

Emissions Test Report

EUT Name: USB Wireless Audio Transmitter

Model No.: Ear Force Stealth 500P TX

CFR 47 Part 15.247:2014 and RSS 210:2010

Prepared for:

Voyetra Turtle Beach, Inc.
100 Summit Lake Drive, Suite 100
Valhalla, New York 10595 USA

Prepared by:

TUV Rheinland of North America, Inc.
1279 Quarry Lane
Pleasanton, CA 94566
Tel: (925) 249-9123
Fax: (925) 249-9124
<http://www.tuv.com/>

Report/Issue Date: October 7, 2014
Report Number: 31462894.001
Revision Number: 0
Project Number: 0000122834

Statement of Compliance

Manufacturer: Voyetra Turtle Beach, Inc.
100 Summit Lake Drive, Suite 100
Valhalla, New York 10595 USA

Requester / Applicant: Tim Blaney
Name of Equipment: USB Wireless Audio Transmitter
Model No. Ear Force Stealth 500P TX (TB300-3271-01)
Type of Equipment: Intentional Radiator
Application of Regulations: CFR 47 Part 15.247:2014 and RSS 210:2010
Test Dates: 2 July 2014 to 8 July 2014

Guidance Documents:

Emissions: ANSI C63.10: 2009, KDB 558074 D01 DTS Measurement Guidance v03r01

Test Methods:

Emissions: ANSI C63.10: 2009, KDB 558074 D01 DTS Measurement Guidance v03r01

The electromagnetic compatibility test and documented data described in this report has been performed and recorded by TUV Rheinland, in accordance with the standards and procedures listed herein. As the responsible authorized agent of the EMC laboratory, I hereby declare that the equipment described above has been shown to be compliant with the EMC requirements of the stated regulations and standards based on these results. If any special accessories and/or modifications were required for compliance, they are listed in the Executive Summary of this report.

This report must not be used to claim product endorsement by A2LA or any agency of the U.S. Government. This report contains data that are not covered by A2LA accreditation. This report shall not be reproduced except in full, without the written authorization of TUV Rheinland of North America.



Jeremy Luong October 7, 2014

Test Engineer Date



Sarbjit Shelopal October 7, 2014

Laboratory Signatory Date



Testing Cert #3331.02



US5254



Industry
Canada Industrie
Canada

2932M-1

Table of Contents

1	Executive Summary	6
1.1	Scope	6
1.2	Purpose	6
1.3	Summary of Test Results	6
1.4	Special Accessories	7
1.5	Equipment Modifications	7
2	Laboratory Information	8
2.1	Accreditations & Endorsements	8
2.1.1	US Federal Communications Commission	8
2.1.2	NIST / A2LA	8
2.1.3	Canada – Industry Canada	8
2.1.4	Japan – VCCI	8
2.1.5	Acceptance by Mutual Recognition Arrangement	9
2.2	Test Facilities	9
2.2.1	Emission Test Facility	9
2.2.2	Immunity Test Facility	9
2.3	Measurement Uncertainty	9
2.3.1	Sample Calculation – radiated & conducted emissions	10
2.3.2	Measurement Uncertainties	11
2.4	Calibration Traceability	11
3	Product Information	12
3.1	Product Description	12
3.2	Equipment Configuration	12
3.3	Operating Mode	12
3.4	Unique Antenna Connector	13
3.4.1	Results	13
4	Emissions	14
4.1	Output Power Requirements	14
4.1.1	Test Method	14
4.1.2	Results	15
4.2	Occupied Bandwidth	19
4.2.1	Test Method	19
4.2.2	Results	20
4.3	Out-of-Band Emissions	24
4.3.1	Test Method	24
4.3.2	Test Result	25
4.4	Peak Power Spectral Density	29
4.4.1	Test Method	29
4.4.2	Results	30

Table of Contents

4.5	Maximum Permissible Exposure	33
4.5.1	Test Methodology	33
4.5.2	RF Exposure Limit	33
4.5.3	EUT Operating Condition	33
4.5.4	Classification	34
4.5.5	Test Results	34
4.5.6	Sample Calculation	34
4.6	Transmitter Spurious Emissions	35
4.6.1	Test Methodology	35
4.6.2	Transmitter Spurious Emission Limit	36
4.6.3	Test Results	36
4.6.4	Sample Calculation	44
4.7	AC Conducted Emissions	45
4.7.1	Test Methodology	45
4.7.2	Test Results	45
5	Test Equipment List	46
5.1	Equipment List	46
6	EMC Test Plan	47
6.1	Introduction	47
6.2	Customer	47
6.3	Equipment Under Test (EUT)	48
6.4	Test Specifications	51

Index of Tables

Table 1: Summary of Test Results	6
Table 2: Summary of Uncertainties	11
Table 3: RF Output Power at the Antenna Port – Test Results	15
Table 4: Average Output Power at the Antenna Port – Reference Use Only	15
Table 5: Occupied Bandwidth – Test Results	20
Table 6: Out of Band Emissions – Test Results	25
Table 7: Peak Power Spectral Density – Test Results	30
Table 8: Transmit Spurious Emission at Band-Edge Requirements	37
Table 9: Customer Information	47
Table 10: Technical Contact Information	47
Table 11: EUT Specifications	48
Table 12: Interface Specifications	49
Table 13: Supported Equipment	49
Table 14: Description of Sample used for Testing	49
Table 15: Description of Test Configuration used for Radiated Measurement.	49
Table 16: Final Test Mode for 2403.35 MHz to 2477.35MHz Band	50
Table 17: Test Specifications	51

1 Executive Summary

1.1 Scope

This report is intended to document the status of conformance with the requirements of the CFR 47 Part 15.247:2014 and RSS 210:2010 based on the results of testing performed on 2 July 2014 through 8 July 2014 on the USB Wireless Audio Transmitter Model Ear Force Stealth 500P TX manufactured by Voyetra Turtle Beach, Inc.. This report only applies to the specific samples tested under the stated test conditions. It is the responsibility of the manufacturer to assure that additional production units of this model are manufactured with identical or EMI equivalent electrical and mechanical components. This report is further intended to document changes and modifications to the EUT throughout its life cycle. All documentation will be included as a supplement.

1.2 Purpose

Testing was performed to evaluate the EMC performance of the EUT in accordance with the applicable requirements, procedures, and criteria defined in the application of regulations and application of standards listed in this report.

1.3 Summary of Test Results

Table 1: Summary of Test Results

Test	Test Method ANSI C63.4: 2009 / ANSI C64.10:2009	Test Parameters	Measured Value	Result
Spurious Emission in Transmitted Mode	CFR47 15.209, RSS-GEN Sect.7.2.3	Class B	-4.58 dB (Margin)	Complied
Restricted Bands of Operation	CFR47 15.205, RSS 210 Sect.2.6	Class B		Complied
AC Power Conducted Emission	CFR47 15.207, RSS-GEN Sect.7.2.2	Class B	NA	Complied
Occupied Bandwidth	CFR47 15.247 (a2), RSS GEN Sect.4.4.1	≥ 500 kHz	1.6343 MHz	Complied
Maximum Transmitted Power	CFR47 15.247 (b3), RSS 210 Sect. A.8.4	30 dBm w/ 6 dBi antenna	-0.74 dBm	Complied
Peak Power Spectral Density	CFR47 15.247 (e), RSS 210 Sect. A.8.2	8 dBm/ 3 kHz	-26.12 dBm	Complied
Band Edge Measurement	CFR47 15.247 (d), RSS 210 Sect. A.8.5	-30 dB	-23.41 dB (Margin)	Complied
RF Exposure for General Population	CFR47 15.247 (i), 2.1091	1.0 mW/cm ²	0.0002367 mW/cm ²	Complied

1.4 *Special Accessories*

No special accessories were necessary in order to achieve compliance.

1.5 *Equipment Modifications*

None.

2 Laboratory Information

2.1 Accreditations & Endorsements

2.1.1 US Federal Communications Commission



TUV Rheinland of North America at 1279 Quarry Lane, Ste. A., Pleasanton, CA 94566, is accredited by the commission for performing testing services for the general public on a fee basis. These laboratory test facilities have been fully described in reports submitted to and accepted by the FCC. The laboratory scope of accreditation includes: Title 47 CFR Parts 15, 18, and 90. The accreditation is updated every 3 years.

2.1.2 NIST / A2LA



TUV Rheinland of North America is accredited by the National Voluntary Laboratory Accreditation Program, which is administered under the auspices of the National Institute of Standards and Technology. The laboratory has been assessed and accredited in accordance with ISO Guide 17025:1999 and ISO 9002 (Lab Code US5254). The scope of laboratory accreditation includes emission and immunity testing. The accreditation is updated annually.

2.1.3 Canada – Industry Canada



TUV Rheinland of North America at the 1279 Quarry Ln, Pleasanton, CA 94566 address is accredited by Industry Canada for performing testing services for the general public on a fee basis. This laboratory test facilities have been fully described in reports submitted to and accepted by Industry Canada (File Number 2932M). This reference number is the indication to the Industry Canada Certification Officers that the site meets the requirements of RSS 212, Issue 1 (Provisional). The accreditation is updated every 3 years.

2.1.4 Japan – VCCI



The Voluntary Control Council for Interference by Information Technology Equipment (VCCI) is a group that consists of Information Technology Equipment (ITE) manufacturers and EMC test laboratories. The purpose of the Council is to take voluntary control measures against electromagnetic interference from Information Technology Equipment, and thereby contribute to the development of a socially beneficial and responsible state of affairs in the realm of Information Technology Equipment in Japan. TUV Rheinland of North America at 1279 Quarry Ln, Pleasanton, CA 94566 has been assessed and approved in accordance with the Regulations for Voluntary Control Measures.

VCCI Registration No. for Pleasanton: A-0031

VCCI Registration No. for Santa Clara: A-0032

2.1.5 Acceptance by Mutual Recognition Arrangement



The United States has an established agreement with specific countries under the Asia Pacific Laboratory Accreditation Corporation (APLAC) Mutual Recognition Arrangement. Under this agreement, all TUV Rheinland at 1279 Quarry Ln, Pleasanton, CA 94566 test results and test reports within the scope of the laboratory NIST / A2LA accreditation will be accepted by each member country.

2.2 Test Facilities

All of the test facilities are located at 1279 Quarry Lane, Ste. A, Pleasanton, California 94566, USA. The 2305 Mission College, Santa Clara, 95054, USA location is considered a Pleasanton annex.

2.2.1 Emission Test Facility

The Semi-Anechoic chamber and AC Line Conducted measurement facility used to collect the radiated and conducted data has been constructed in accordance with ANSI C63.7:1992. The site has been measured in accordance with and verified to comply with the theoretical normalized site attenuation requirements of ANSI C63.4-2009, at a test distance of 3 and 5 meters. The site is listed with the FCC and accredited by A2LA (Lab Code US5254). The 3/5-meter semi-anechoic chamber used to collect the radiated data has been verified to comply with the theoretical normalized site attenuation requirements of ANSI C63.4-2009, at a test distance of 3 meter and 5 meters. A report detailing this site can be obtained from TUV Rheinland of North America.

2.2.2 Immunity Test Facility

ESD, EFT, Surge, PQF: These tests are performed in an environmentally controlled room with a 3.7 m x 4.8 m x 3.175 mm thick aluminum floor connected to PE ground.

For ESD testing, tabletop equipment is placed on an insulated mat with a surface resistivity of 10^9 Ohms/square on a 1.6 m x 0.8 m x 0.8 m high non-conductive table with a 3.175 mm aluminum top (Horizontal Coupling Plane). The HCP is connected to the main ground plane via a low impedance ground strap through two 470-k Ω resistors. The Vertical Coupling Plane consists of an aluminum plate 50 cm x 50 cm x 3.175 mm thick. The VCP is connected to the main ground plane via a low impedance ground strap through two 470-k Ω resistors.

For EFT, Surge, PQF, the HCP and VCP are removed.

RF Field Immunity testing is performed in a 7.3m x 4.3m x 4.1m anechoic chamber.

RF Conducted and Magnetic Field Immunity testing is performed on a 4.8m x 3.7m x 3.175mm thick aluminum ground plane.

All test areas allow a minimum distance of 1 meter from the EUT to walls or conducting objects.

2.3 Measurement Uncertainty

Two types of measurement uncertainty are expressed in this report, per *ISO Guide To The Expression Of Uncertainty In Measurement*, 1st Edition, 1995.

The Combined Standard Uncertainty is the standard uncertainty of the result of a measurement when that result is obtained from the values of a number of other quantities; it is equal to the positive square root of the sum of the variances or co-variances of these other quantities, weighted according to how the measurement result varies with changes in these quantities. The term *standard uncertainty* is the result of a measurement expressed as a standard deviation.

The Expanded Uncertainty defines an interval about the result of a measurement that may be expected to encompass a large fraction of the distribution of values that could reasonably be attributed to the measurand. The fraction may be viewed as the coverage probability or level of confidence of the interval.

2.3.1 Sample Calculation – radiated & conducted emissions

The field strength is calculated by subtracting the Amplifier Gain and adding the Cable Loss and Antenna Correction Factor to the measured reading. The basic equation is as follows:

$$\text{Field Strength (dB}\mu\text{V/m)} = \text{RAW} - \text{AMP} + \text{CBL} + \text{ACF}$$

Where: RAW = Measured level before correction (dB μ V)

AMP = Amplifier Gain (dB)

CBL = Cable Loss (dB)

ACF = Antenna Correction Factor (dB/m)

$$\mu\text{V/m} = 10^{\frac{\text{dB}\mu\text{V/m}}{20}}$$

Sample radiated emissions calculation @ 30 MHz

Measurement +Antenna Factor–Amplifier Gain+Cable loss=Radiated Emissions (dBuV/m)

$$25 \text{ dBuV/m} + 17.5 \text{ dB} - 20 \text{ dB} + 1.0 \text{ dB} = 23.5 \text{ dBuV/m}$$

2.3.2 Measurement Uncertainties

Table 2: Summary of Uncertainties

	U_{lab}	U_{cispr}
Radiated Disturbance		
30 MHz – 25,000 MHz	3.2 dB	5.2 dB
Conducted Disturbance @ Mains Terminals		
150 kHz – 30 MHz	2.4 dB	3.6 dB
Disturbance Power		
30 MHz – 300 MHz	3.92 dB	4.5 dB

Note: U_{lab} is the calculated Combined Standard Uncertainty
 U_{cispr} is the measurement uncertainty requirement per CISPR 16.

Measurement Uncertainty Immunity

The estimated combined standard uncertainty for ESD immunity measurements is ± 4.1%.
The estimated combined standard uncertainty for radiated immunity measurements is ± 2.7dB.
The estimated combined standard uncertainty for conducted immunity measurements is ± 1.4dB.
The estimated combined standard uncertainty for damped oscillatory wave immunity measurements is ± 8.8%.
The estimated combined standard uncertainty for harmonic current and flicker measurements is ± 0.45%.

Measurement Uncertainty – Radio Testing

The estimated combined standard uncertainty for frequency error measurements is ± 3.88 Hz
The estimated combined standard uncertainty for carrier power measurements is ± 1.59 dB.
The estimated combined standard uncertainty for adjacent channel power measurements is ± 1.47 dB.
The estimated combined standard uncertainty for modulation frequency response measurements is ± 0.46 dB.
The estimated combined standard uncertainty for transmitter conducted emission measurements is ± 4.01 dB

The expanded uncertainty at a level of 95% confidence is obtained by multiplying the combined standard uncertainty by a coverage factor of 2. Compliance criteria are not based on measurement uncertainty.

2.4 Calibration Traceability

All measurement instrumentation is traceable to the National Institute of Standards and Technology (NIST). Measurement method complies with ANSI/NCSL Z540-1-1994 and ISO Guide 17025:2005.

3 Product Information

3.1 Product Description

The Ear Force Stealth 500P Wireless Gaming System consists of two main communication modules, the Stealth 500P RX (“Headset”) and the Stealth 500P TX (“Transmitter”). These two modules comprise a closed-loop wireless audio gaming system that utilize a proprietary 2.4 GHz communication technology to offer wireless streaming audio and chat/talkback capabilities.

3.2 Equipment Configuration

A description of the equipment configuration is given in Test Plan Section. The EUT was tested as called for in the test standard and was configured and operated in a manner consistent with its intended use. The EUT was connected to rated power and allowed to reach intended operating conditions. The placement of the EUT system components was guided by the test standard and selected to represent typical installation conditions.

In the case of a EUT that can operate in more than one configuration, preliminary testing was performed to determine the configuration that produced maximum radiation.

The final configuration was selected to produce the worst case radiation for emissions testing and to place the EUT in the most susceptible state for immunity testing.

3.3 Operating Mode

A description of the operation mode is given in Test Plan Section. In the case of a EUT that can operate in more than one state, preliminary testing was performed to determine the operating mode that produced maximum radiation.

The final operating mode was selected to produce the worst case radiation for emissions testing and to place the EUT in the most susceptible state for immunity testing.

3.4 Unique Antenna Connector

An intentional radiator shall be designed to ensure that no antenna other than that furnished by the responsible party shall be used with the device. The use of a permanently attached antenna or of an antenna that uses a unique coupling to the intentional radiator shall be considered sufficient to comply with the provisions of this section. The manufacturer may design the unit so that a broken antenna can be replaced by the user, but the use of a standard antenna jack or electrical connector is prohibited. This requirement does not apply to carrier current devices or to devices operated under the provisions of CFR47 Parts 15.211, 15.213, 15.217, 15.219, or 15.221.

3.4.1 Results

The Ear Force Stealth 500P TX uses the permanently attached PCB trace antennas located inside the device. See EUT Photo for details.

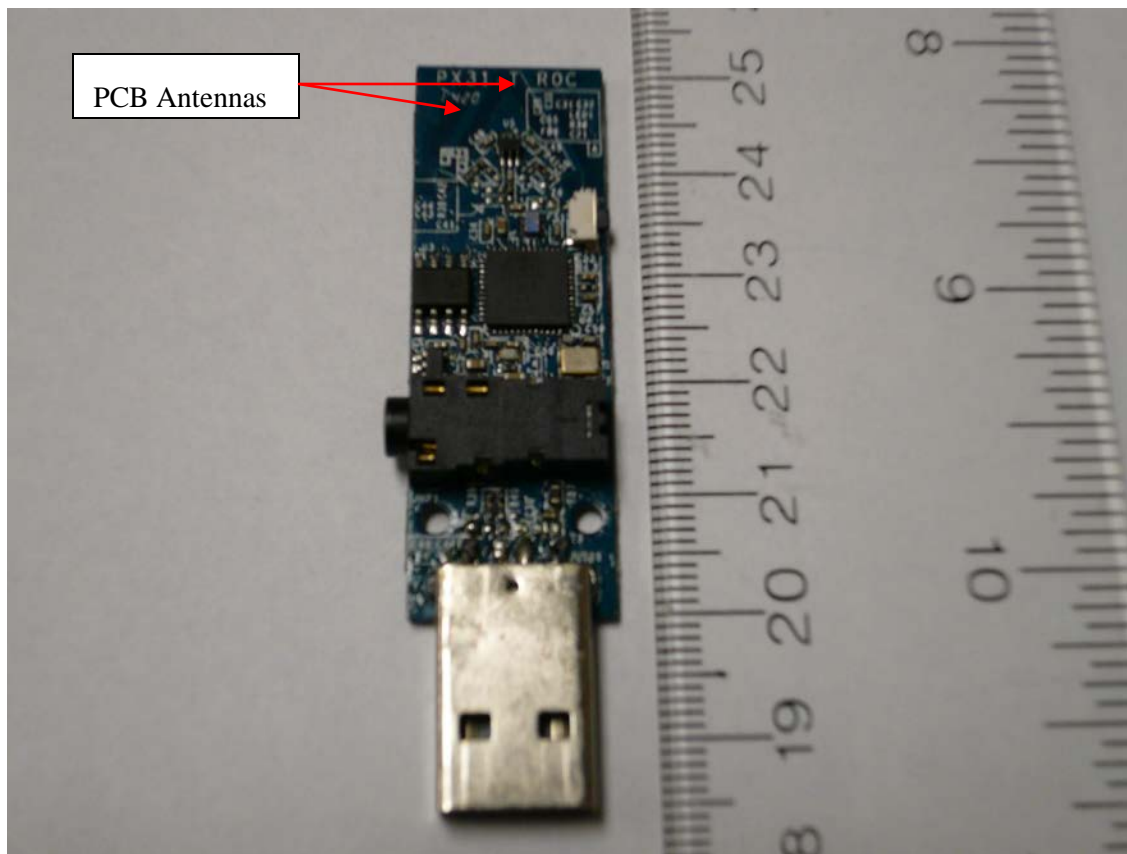

4 Emissions

Testing was performed in accordance with CFR 47 Part 15.247:2014 and RSS 210 Annex 8:2010. These test methods are listed under the laboratory's A2LA Scope of Accreditation. This test measures the levels emanating from the EUT, thus evaluating the potential for the EUT to cause radio frequency interference to other electronic devices. Procedures described in ANSI C63.10: 2009 were used.

4.1 Output Power Requirements

The maximum peak output power requirement is the maximum equivalent isotropic radiated power delivering at the transmitting antenna under specified conditions of measurements in the presence of modulation.

The maximum output power and harmonics shall not exceed CFR47 Part 15.247 (b3):2013 and RSS 210 A.8.4: 2010

The maximum transmitted power is +30 dBm or 1 Watt.

4.1.1 Test Method

The conducted method was used to measure the channel power output according to ANSI C63.10:2009 Section 6.10.3.1. The measurement was performed with modulation per CFR47 Part15.247 (b3):2014 and RSS 210 A.8.4: 2010. This test was conducted on 3 channels of Sample S/N PP#1. The worst mode result indicated below.

Test Setup:

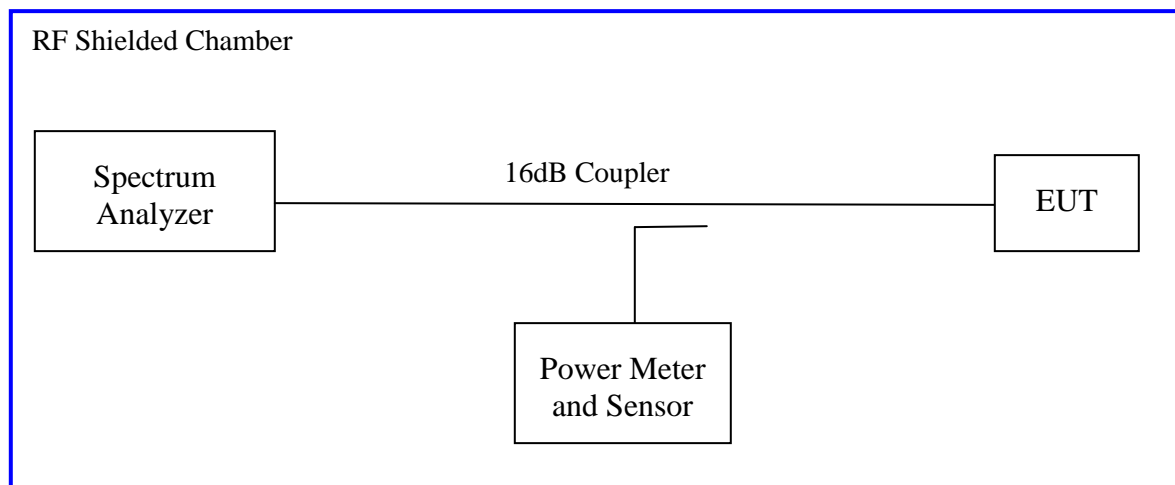

Method AVGSA-1 of "KDB 558074 – DTS Measurement Guidance v03r01" applies since the Ear Force Stealth 500P TX continuously transmits with duty cycle greater than 98%. Sample detector was used.

4.1.2 Results

As originally tested, the EUT was found to be compliant to the requirements of the test standard(s).

Table 3: RF Output Power at the Antenna Port – Test Results

Test Conditions: Conducted Measurement			Date: July 2, 2014		
Antenna Type: Integrated			Power Setting: 0 dBm		
Antenna Gain: -0.5 dBi			Signal State: Modulated		
Ambient Temp.: 23 °C			Relative Humidity: 33%		
Transmitter					
Frequency [MHz]	Limit [dBm]	Chain 0 [dBm]	Duty Cycle [dB]	∑ Power [dBm]	Margin [dB]
2403.35	+30.00	-0.74			-30.74
2441.35	+30.00	-1.06			-31.06
2477.35	+30.00	-1.44			-31.44
Note: The transmitter transmitted at 100% duty cycle.					

Table 4: Average Output Power at the Antenna Port – Reference Use Only

Test Conditions: Conducted Measurement			Date: July 2, 2014		
Antenna Type: Integrated			Power Setting: See test plan		
Antenna Gain: -0.5 dBi			Signal State: Modulated		
Ambient Temp.: 23 °C			Relative Humidity: 33%		
Transmitter					
Frequency [MHz]	Limit [dBm]	Chain 0 [dBm]	Duty Cycle [dB]	∑ Power [dBm]	Margin [dB]
2403.35	N/A	-0.97			N/A
2441.35	N/A	-1.35			N/A
2477.35	N/A	-1.80			N/A
Note: The transmitter transmitted at 100% duty cycle.					

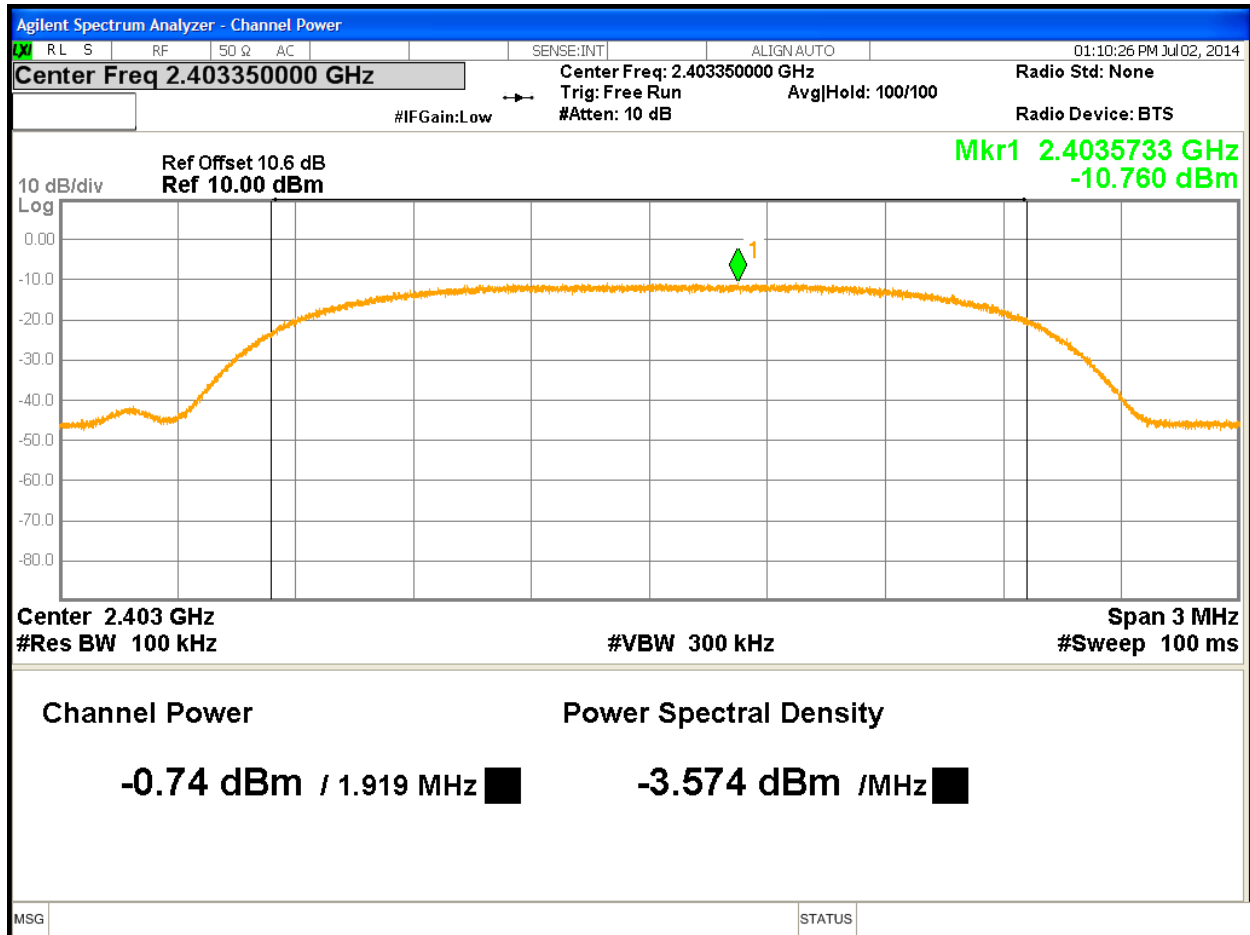

Figure 1: Maximum Conducted Output Power at 2403.35MHz – Transmitter

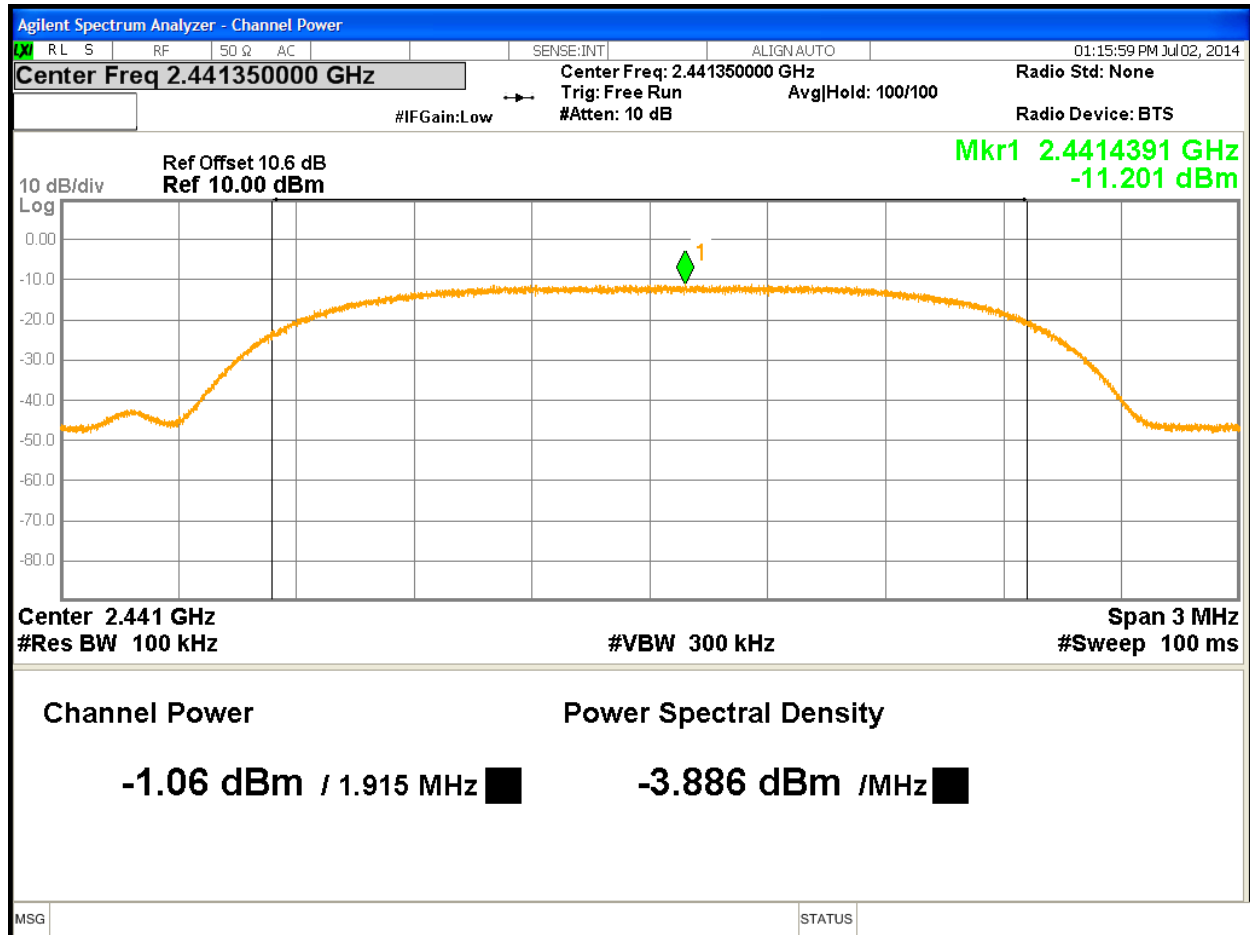

Figure 2: Maximum Conducted Output Power at 2441.35MHz – Transmitter

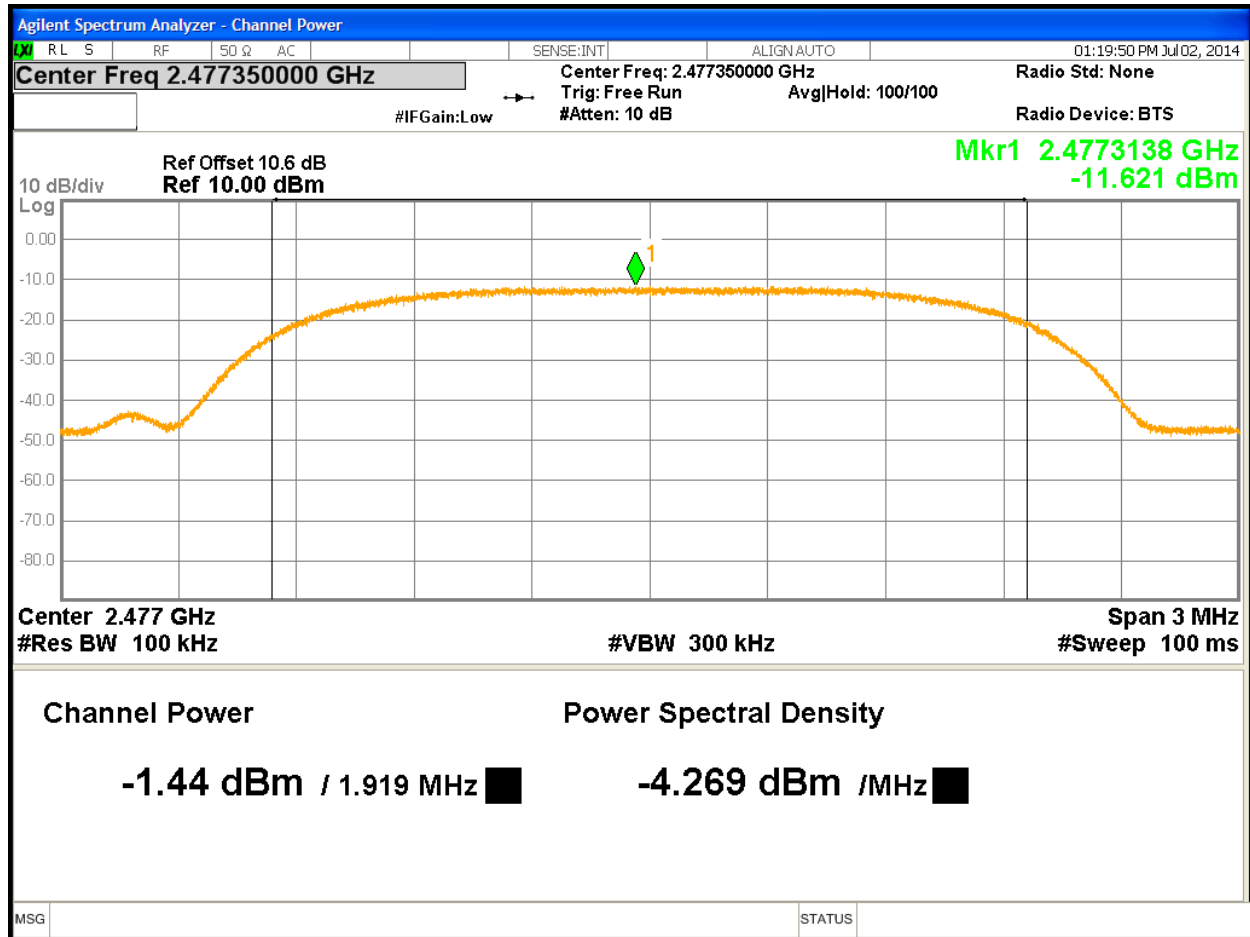

Figure 3: Maximum Conducted Output Power at 2477.35MHz – Transmitter

4.2 Occupied Bandwidth

The occupied bandwidth is measured at an amplitude level reduced from the reference level by a specified ratio. The reference level is the level of the highest amplitude signal observed from the transmitter at the fundamental frequency.

The 99% bandwidth is the bandwidth in which 99% of the transmitted power occupied.

The 6dB bandwidth is defined the bandwidth of 6dB from highest transmitted level of the fundamental frequency.

The bandwidth shall be at least 500 kHz per Section CFR47 15.247(a2) 2014 and RSS Gen Sect. 4.4.1: 2010.

4.2.1 Test Method

The conducted method was used to measure the occupied bandwidth according to ANSI C63.10:2009 Section 6.9.1. The measurement was performed with modulation per CFR47 15.247(a2) 2014 and RSS Gen Sect. 4.4.1:2010. This test was conducted on 3 channels in each mode of Sample S/N PP #1. The worst sample result indicated below.

Test Setup:

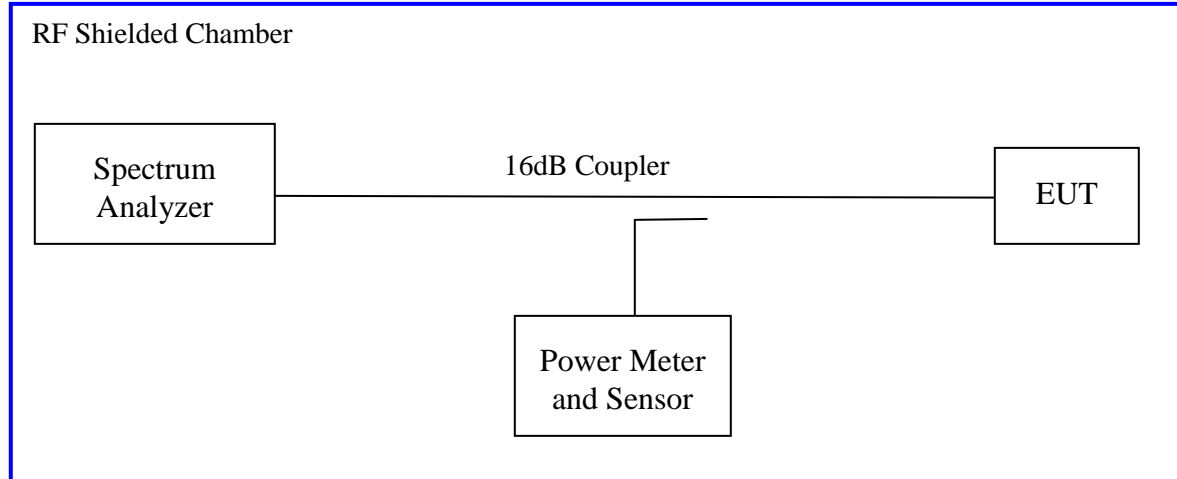

4.2.2 Results

As originally tested, the EUT was found to be compliant to the requirements of the test standard(s).

Table 5: Occupied Bandwidth – Test Results

Test Conditions: Conducted Measurement		Date: July 2, 2014		
Antenna Type: Integrated		Power Setting: 0 dBm		
Antenna Gain: -0.5 dBi		Signal State: Modulated		
Ambient Temp.: 23 °C		Relative Humidity: 33%		
Bandwidth (MHz) for TX Dongle				
Frequency (MHz)	Limit (kHz)	99% Bandwidth	6 dB Bandwidth	Results
2403.35	500	1.9075	1.6448	Pass
2441.35	500	1.9016	1.6538	Pass
2477.35	500	1.9004	1.6343	Pass
Note: The bandwidth was measured at 100% duty cycle				

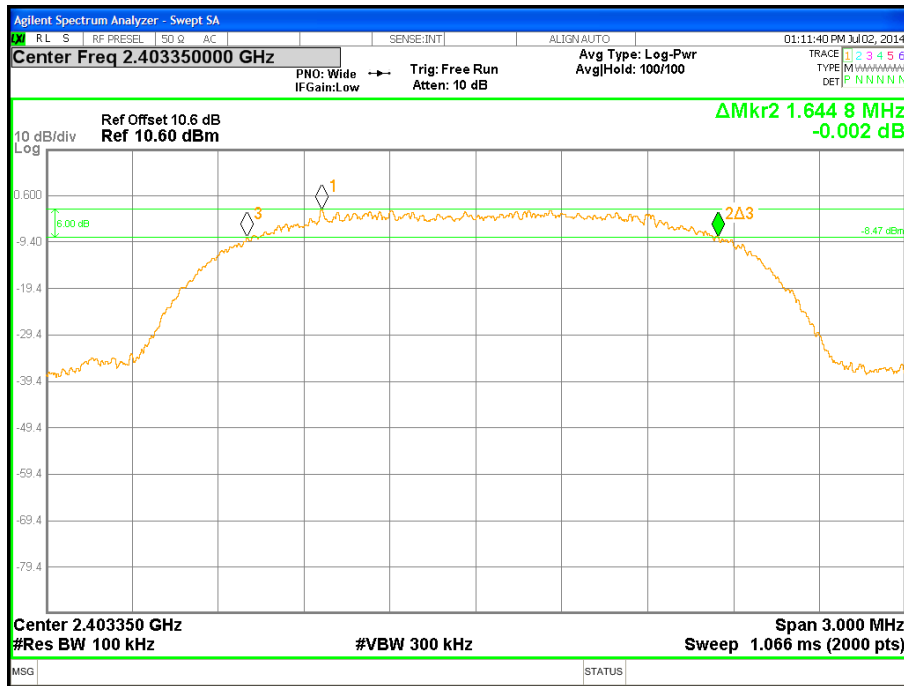

Figure 4: DTS Bandwidth-Transmitter-2403.35MHz

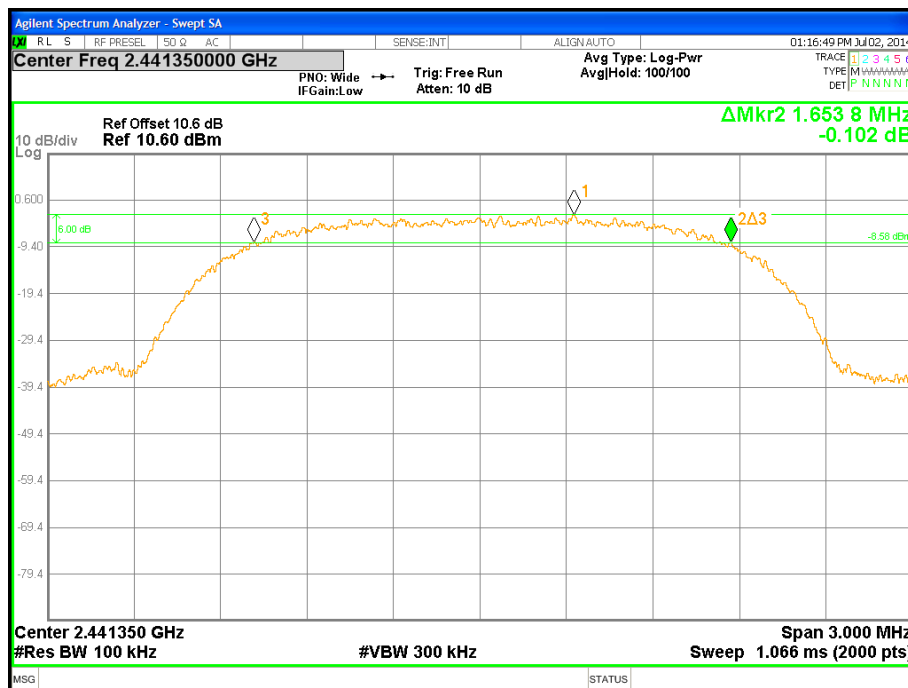

Figure 5: DTS Bandwidth- Transmitter -2441.35MHz

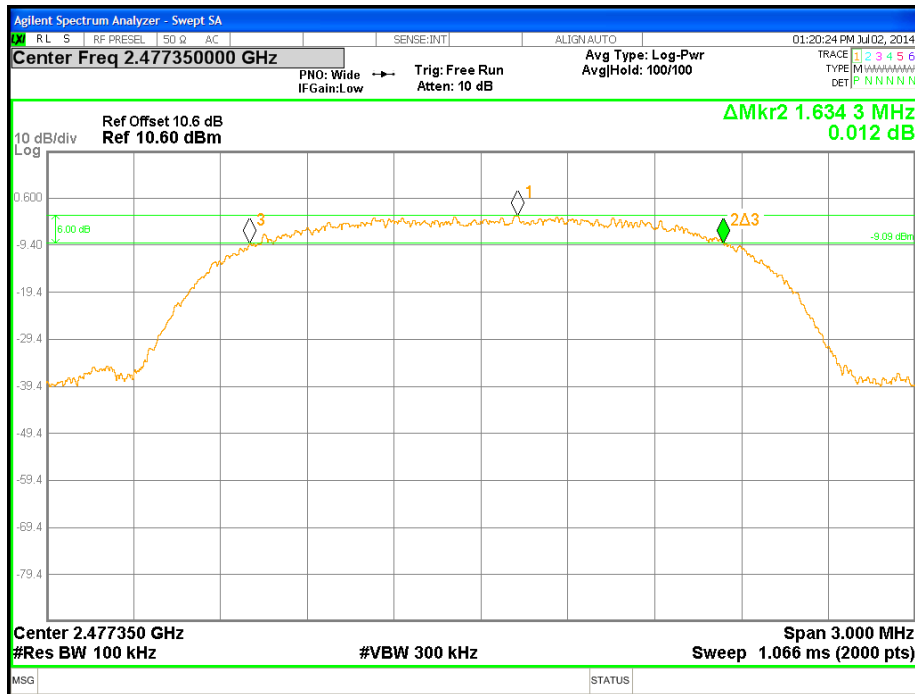

Figure 6: DTS Bandwidth- Transmitter -2477.35MHz

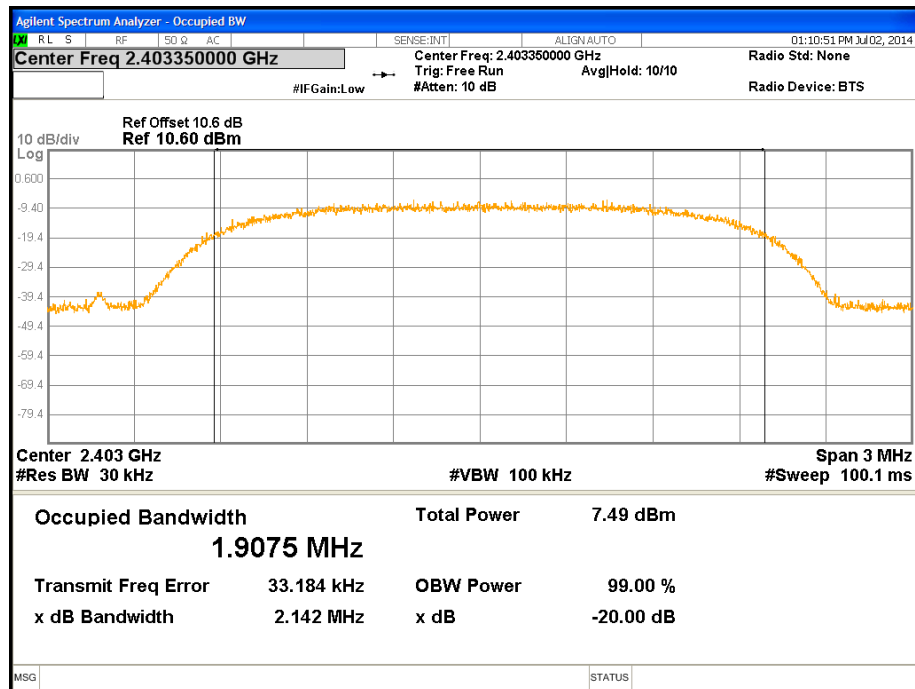

Figure 7: 99% Bandwidth- Transmitter -2403.35MHz

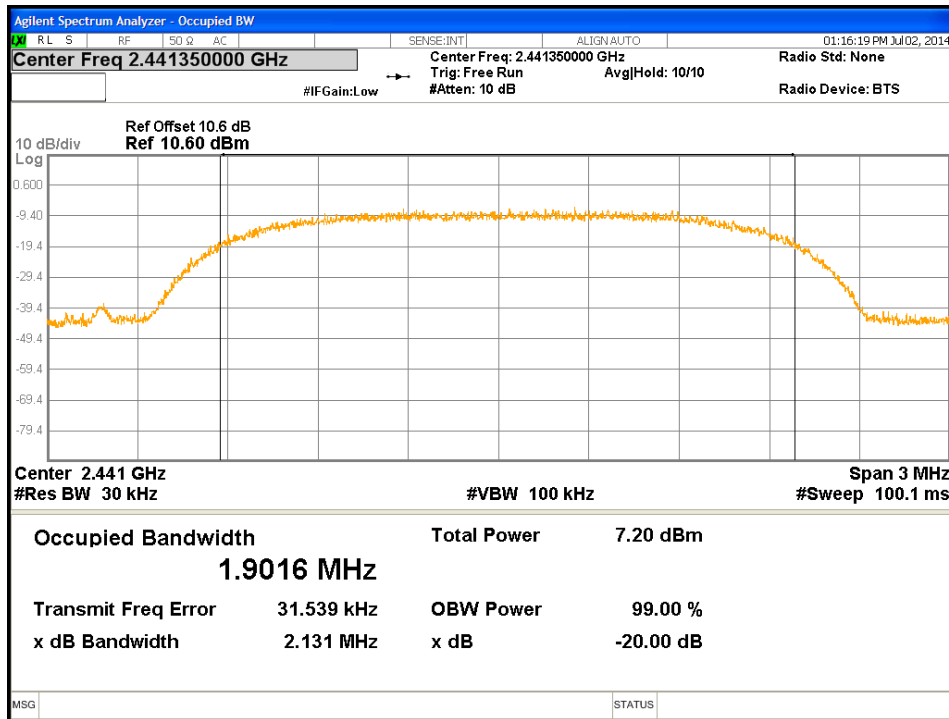

Figure 8: 99% Bandwidth- Transmitter -2441.35MHz

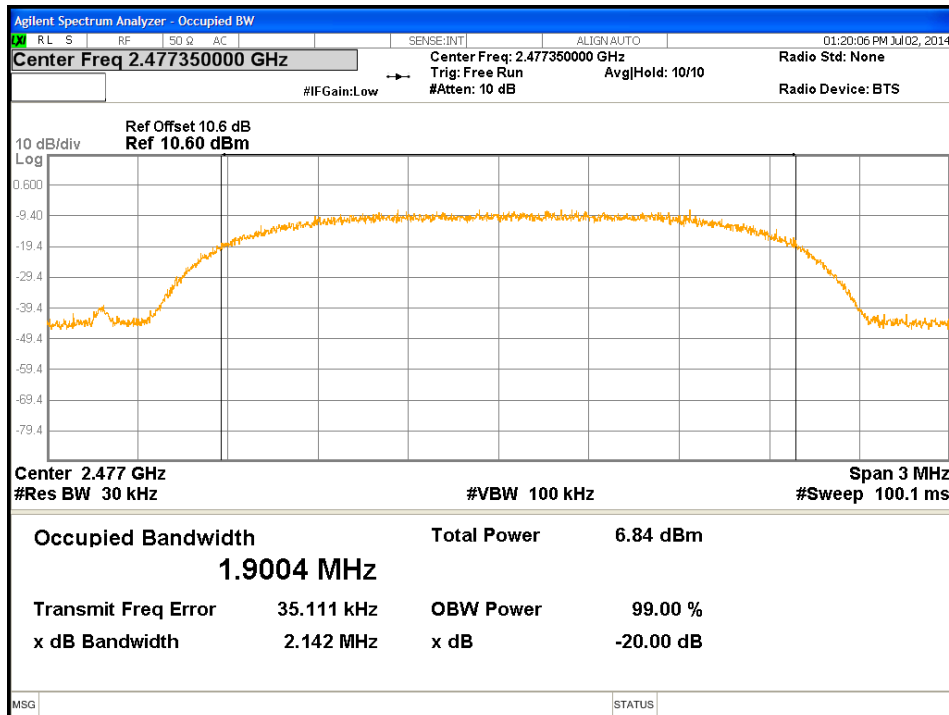

Figure 9: 99% Bandwidth- Transmitter -2477.35MHz

4.3 Out-of-Band Emissions

The setup was identical to RF output power measurement. Intentional radiators operating under the alternative provisions to the general emission limits, must be designed to ensure that the 20 dB or 30 dB bandwidth of the emission, or whatever bandwidth may otherwise be specified in the specific rule section under which the equipment operates, is contained within the frequency band designated in the rule section under which the equipment is operated. The requirement to contain the designated bandwidth of the emission within the specified frequency band includes the effects from frequency sweeping, frequency hopping and other modulation techniques that may be employed as well as the frequency stability of the transmitter over expected variations in temperature and supply voltage. If the frequency stability is not specified in the regulations, it is recommended that the fundamental emission be kept within at least the central 80% of the permitted band in order to minimize the possibility of out-of-band operation.

Since the transmitter complies with the conducted power limits base on the use of RMS averaging per CFR47 Part 15.247(b)(3), any frequency outside the band of 2400MHz to 2483.5MHz, the power output level must be below 30db from the in-band transmitting signal; CFR 47 Part 15.215, 15.247(d) and RSS 210 A8.5

4.3.1 Test Method

The conducted method was used to measure the out-of-band emission requirement. The measurement was performed with modulation per CFR47 15.247(4)(d) 2014 and RSS 210 A8.5: 2010. This test was conducted on 3 channels of Sample S/N PP #1. The worst sample result indicated below.

Test Setup:

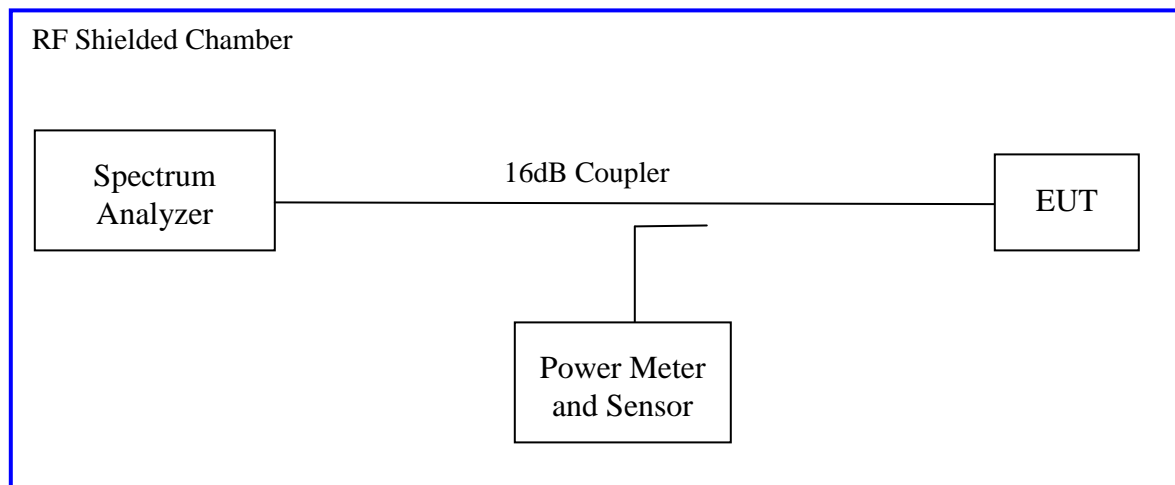

4.3.2 Test Result

As originally tested, the EUT was found to be compliant to the requirements of the test standard(s).

Table 6: Out of Band Emissions – Test Results

Test Conditions: Conducted Measurement		Date: July 2, 2014	
Antenna Type: Integrated		Power Setting: 0 dBm	
Antenna Gain: -0.5 dBi		Signal State: Modulated	
Ambient Temp.: 23 °C		Relative Humidity: 33%	
Band-Edge Results for the Transmitter			
Operating Channel	Out of Band Level (dBm)	30 dBr Level (dBm)	Margin (dB)
2403.35 MHz	-56.71	-32.53	-24.18
2441.35 MHz	-56.31	-32.90	-23.41
2477.35 MHz	-57.22	-33.12	-24.10
<p>Note: The band-edge level must lower than the 30dBr level. The maximum out of band emission on each individual output put is at least 30 dB below the maximum in-band PSD on that output. (*) The band-edge is compared to the highest -30dBr level of the test mode.</p>			

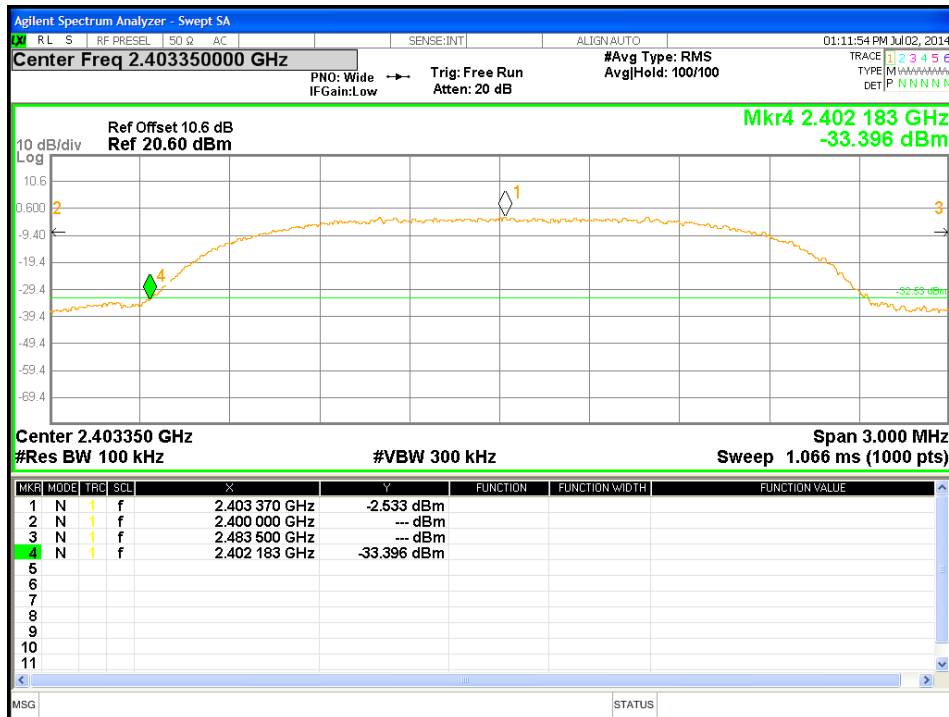

Figure 10: Conducted Band Edge-2403.35MHz-Transmitter

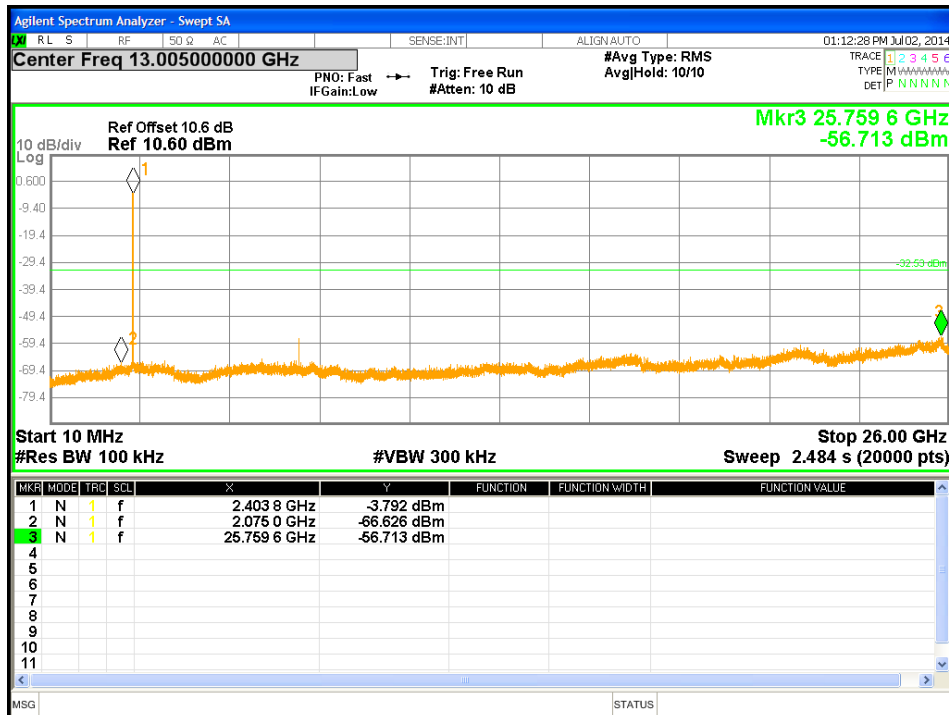

Figure 11: Out of band Emission-2403.35MHz- Transmitter

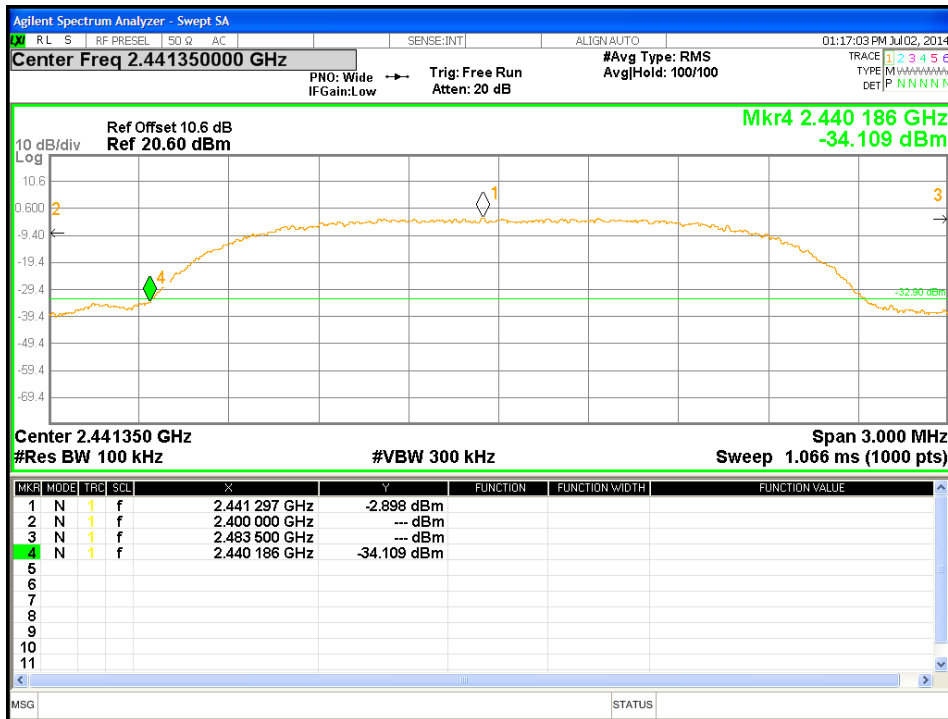

Figure 12: Conducted Band Edge-2441.35MHz- Transmitter

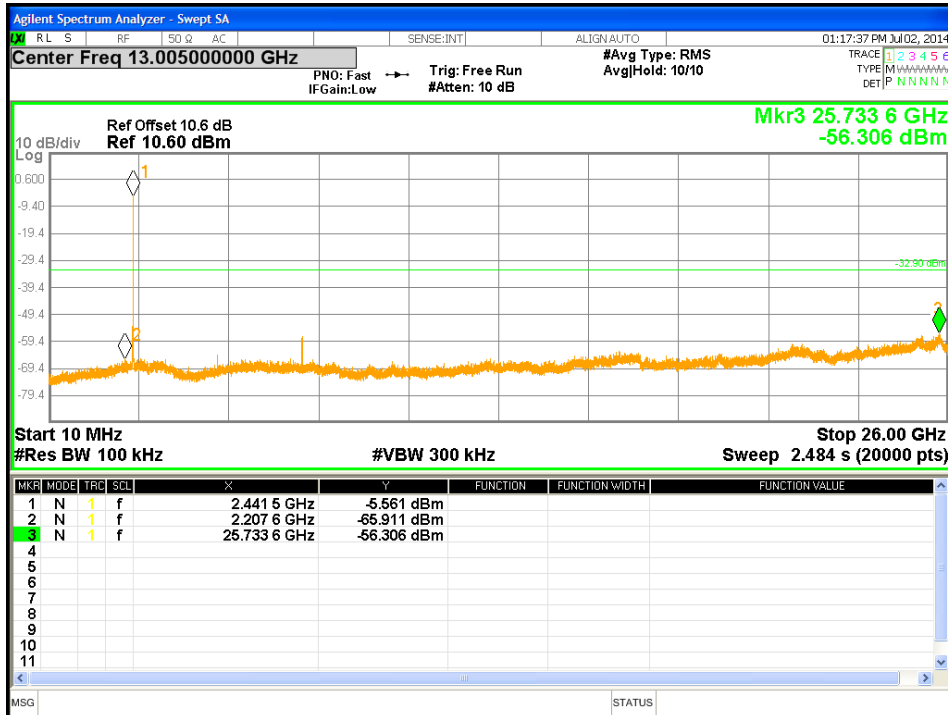

Figure 13: Out of band Emission-2441.35MHz- Transmitter

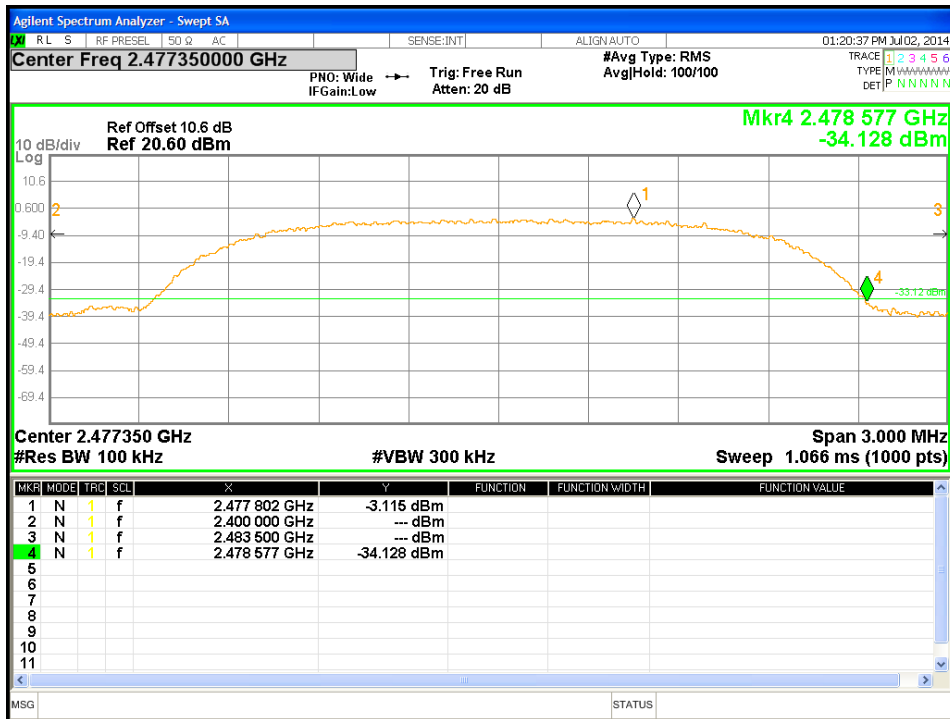

Figure 14: Conducted Band Edge-2477.35MHz- Transmitter

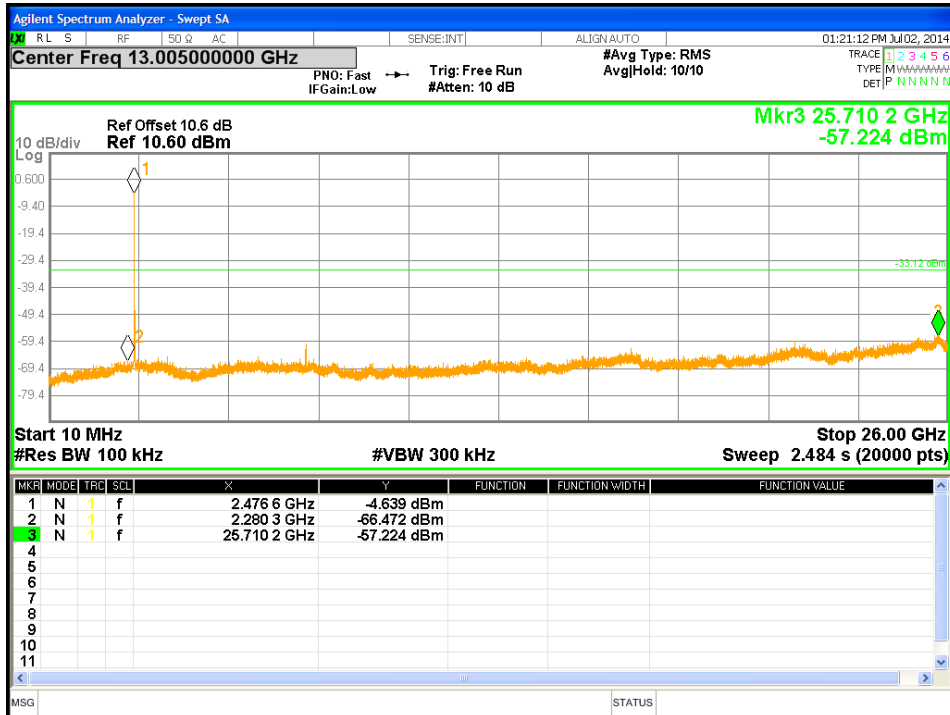

Figure 15: Out of band Emission-2477.35MHz- Transmitter

4.4 Peak Power Spectral Density

According to the CFR47 Part 15.247 (e) and RSS 210 (A8.2), the spectral power density output of the antenna port shall be less than 8dBm in any 3 kHz band during any time interval of continuous transmission.

4.4.1 Test Method

The conducted method was used to measure the channel power output per ANSI C63.10:2009 Section 6.11.2. The measurement was performed with modulation per CFR47 Part 15.247 (e) and RSS 210 (A8.2). This test was conducted on 3 channels of Sample SN PP #1. The worst sample result indicated below.

Test Setup:

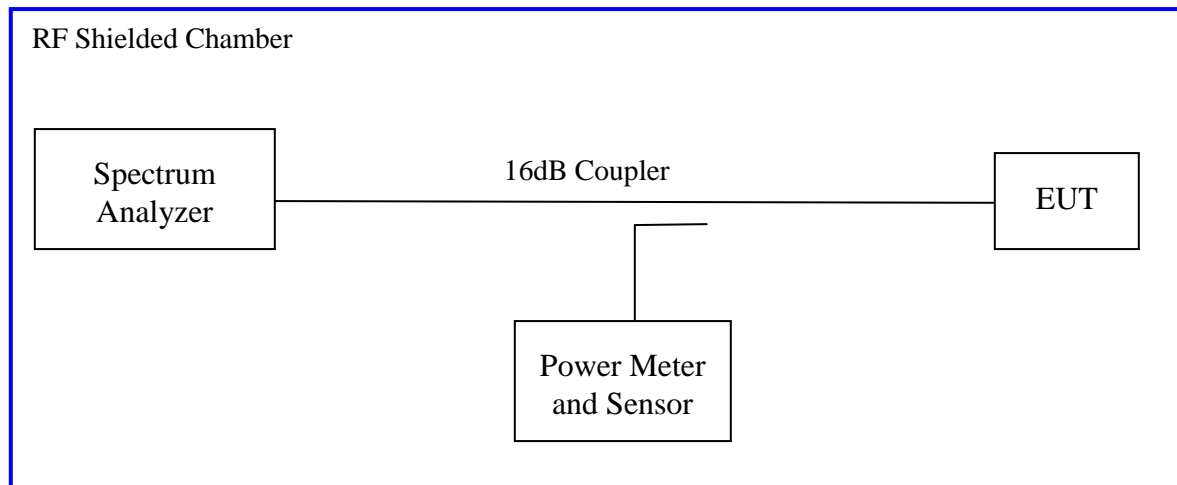

4.4.2 Results

As originally tested, the EUT was found to be compliant to the requirements of the test standard(s).

Table 7: Peak Power Spectral Density – Test Results

Test Conditions: Conducted Measurement				Date: July 2, 2014		
Antenna Type: Integrated				Power Setting: 0 dBm		
Antenna Gain: -0.5 dBi				Signal State: Modulated		
Ambient Temp.: 23 °C				Relative Humidity: 33%		
Peak Power Spectral Density						
Freq. (MHz)	Config.	Output [dBm]	CF [dB]	Max. PPSD [dBm]	Limit [dBm]	Margin [dB]
2403.35	Transmitter	-10.93	-15.23	-26.16	8.00	-34.16
2441.35	Transmitter	-10.89	-15.23	-26.12	8.00	-34.12
2477.35	Transmitter	-11.58	-15.23	-26.81	8.00	-34.81
Note: CF was accounted for the measured RBW. The bandwidth ratio is $10 \cdot \log(3\text{kHz}/100\text{kHz})$ or -15.23 dB. Transmitter transmitted at 100% duty cycle.						

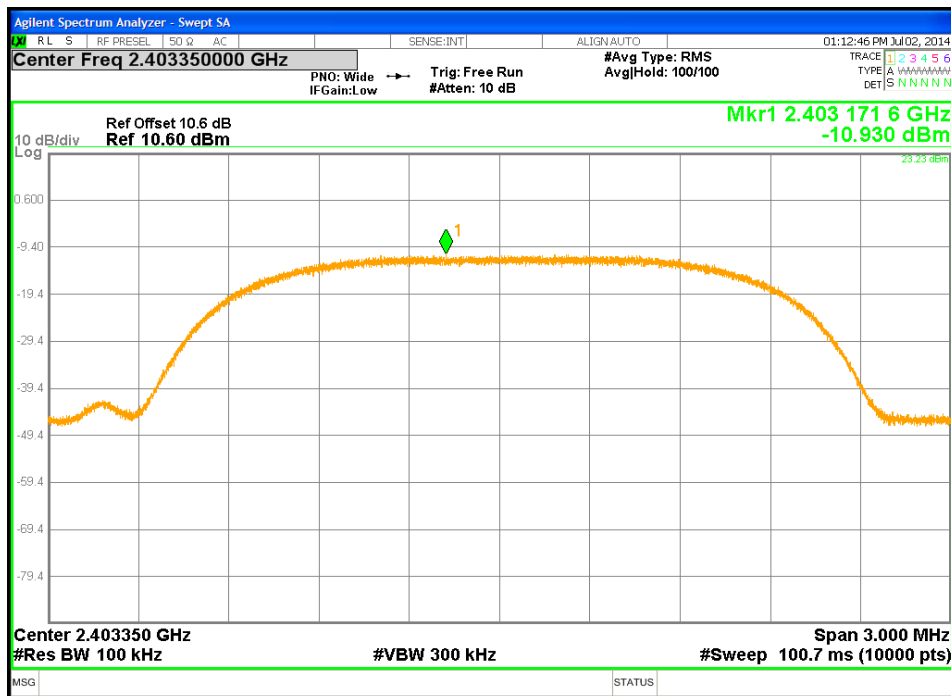

Figure 16: Maximum Power Spectral Density-2403.35MHz- Transmitter

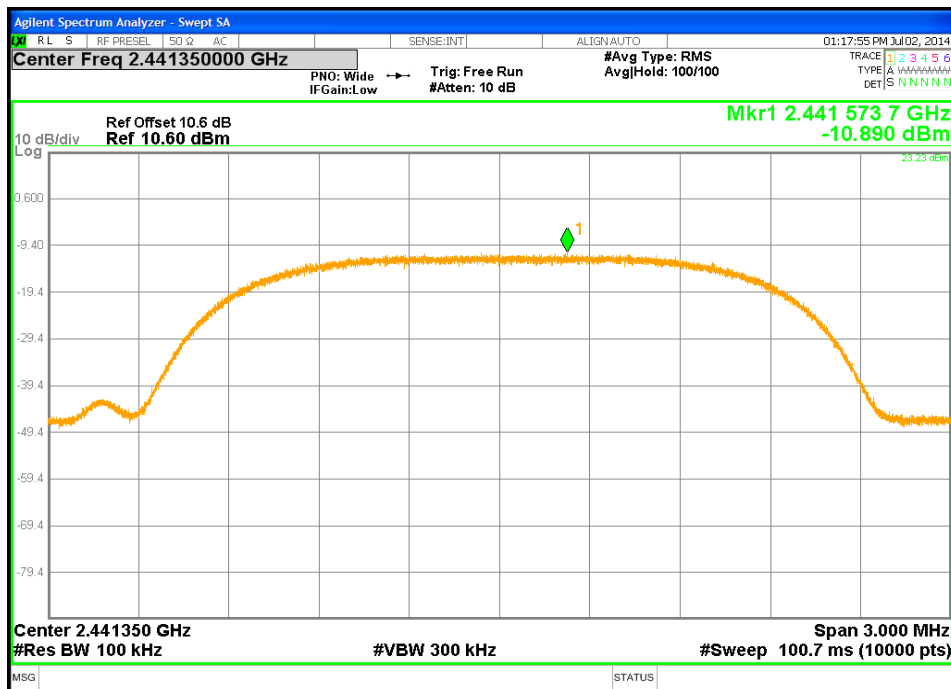

Figure 17: Maximum Power Spectral Density-2441.35MHz- Transmitter

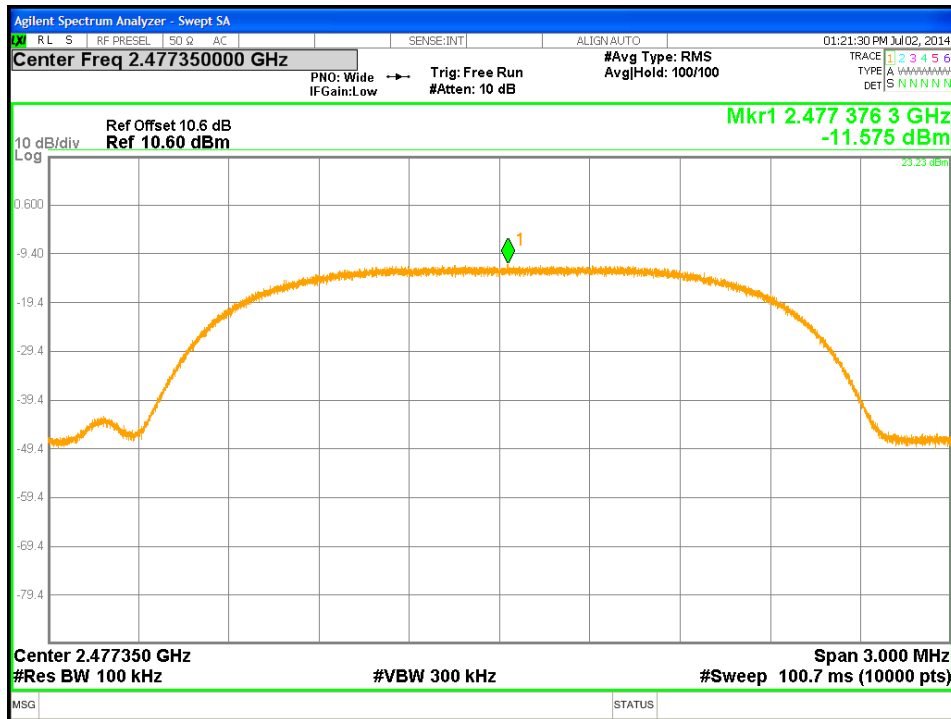

Figure 18: Maximum Power Spectral Density-2477.35MHz- Transmitter

4.5 Maximum Permissible Exposure

4.5.1 Test Methodology

In this document, we try to prove the safety of radiation harmfulness to the human body for our product. The limit for Maximum Permissible Exposure (MPE) specified in FCC 1.1310 is followed. The Gain of the antenna used in this product is measured in a Semi-Anechoic Chamber, and also the maximum total power input to the antenna is measured. Through the Friis transmission formula and the maximum gain of the antenna, we can calculate the distance, away from the product, where the limit of MPE is reached.

Although the Friis transmission formula is a far field assumption, the calculated result of that is an over-prediction for near field power density. We will take that as the worst case to specify the safety range.

4.5.2 RF Exposure Limit

According to FCC 1.1310 table 1: The criteria listed in the following table shall be used to evaluate the environmental impact of human exposure to radio-frequency (RF) radiation as specified in 1.1307(b)

LIMITS FOR MAXIMUM PERMISSIBLE EXPOSURE (MPE)

Frequency Range (MHz)	Electric Field Strength (V/m)	Magnetic Field Strength (A/m)	Power Density (mW/cm ²)	Average Time (minutes)
(A)Limits For Occupational / Control Exposures				
300 - 1500	F/300	6
1500 - 100,000	5	6
(B)Limits For General Population / Uncontrolled Exposure				
300 - 1500	F/1500	6
1500 - 100,000	1.0	30

F = Frequency in MHz

4.5.3 EUT Operating Condition

The software provided by Manufacturer enabled the EUT to transmit data at lowest, middle and highest channel individually.

4.5.4 Classification

The antenna of the product, under normal use condition, is at least 20cm away from the body of the user. Warning statement to the user for keeping at least 20cm or more separation distance with the antenna should be included in user's manual. So, this device is classified as a **Mobile Device**.

4.5.5 Test Results

4.5.5.1 Antenna Gain

The transmitting antenna was integrated. The maximum antenna gain for the highest observed power was -0.5 dBi or 0.89 (numeric).

4.5.5.2 Output Power into Antenna & RF Exposure value at distance 20cm:

Calculations for this report are based on highest power measurement.

Limit for MPE (from FCC part 1.1310 table1) is 1.0 mW/cm²

The highest measured power is -0.74 dBm or 0.84333mW.

Using the Friss transmission formula, the EIRP is Pout*G, and R is 20cm.

$Pd = (0.8433 * 0.891) / (1600\pi) = 0.0001496 \text{ mW/cm}^2$, which is 0.999850 mW/cm² below to the limit.

As originally tested, the EUT was found to be compliant to the requirements of the test standard(s).

4.5.6 Sample Calculation

The Friss transmission formula: $Pd = (Pout * G) / (4 * \pi * R^2)$

Where;

Pd = power density in mW/cm²

Pout = output power to antenna in mW

G = gain of antenna in linear scale

$\pi \approx 3.1416$

R = distance between observation point and center of the radiator in cm

Ref. : David K. Cheng, *Field and Wave Electromagnetics*, Second Edition, Page 640, Eq. (11-133).

4.6 Transmitter Spurious Emissions

Transmitter spurious emissions are emissions outside the frequency range of the equipment when the equipment is in transmit mode; per requirement of CFR47 15.205, 15.209, 15.247(d), RSS 210 Sect. A.8.5

4.6.1 Test Methodology

4.6.1.1 Preliminary Test

A test program that controls instrumentation and data logging was used to automate the preliminary RF emission test procedure. The frequency range of interest was divided into sub-ranges to yield a frequency resolution of approximately 120 kHz and provide a reading at each frequency for no more than 12° of turntable rotation. For each frequency sub-range the turntable was rotated 360° while peak emission data was recorded and plotted over the frequency range of interest in horizontal and vertical antenna polarization's.

Preliminary emission profile testing was performed inside the anechoic chamber. The EUT was placed on a 1.0m x 1.5m non-conductive table 80cm above the floor. The EUT was positioned as shown in the setup photographs. The receiving antenna was placed at a distance of 3m at a fixed height of 1m. Measurement equipment was located outside of the chamber. A video camera was placed inside the chamber to view the EUT.

4.6.1.2 Final Test

For each frequency measured, the peak emission was maximized by manipulating the receiving antenna from 1 to 4 meters above the ground plane and placing it at the position that produced the maximum signal strength reading. The turntable was then rotated through 360° while observing the peak signal and placing the EUT at the position that produced maximum radiation. The six highest emissions relative to the limit were measured unless such emissions were more than 20 dB below the limit. If less than six emissions are within 20 dB of the limit, than the noise level of the receiver is measured at frequencies where emissions are expected. Multiples of all oscillator and microprocessor frequencies were also checked.

Final testing was performed on an NSA compliant test site. The EUT was placed on a 1.0m x 1.5m non-conductive table 80cm above the ground plane. The placement of EUT and cables were the same as for preliminary testing and is shown in the setup photographs.

The final scans performed on the worst axis, Y-Axis up, for three operating channels in each operating mode;

2403.35MHz, 2441.35MHz, and 2477.35MHz

4.6.1.3 Deviations

None.

4.6.2 Transmitter Spurious Emission Limit

The spurious emissions of the transmitter shall not exceed the values in CFR47 Part 15.205, 15.209: 2014 and RSS 210 A1.1.2 2010.

Frequency (MHz)	Field strength (microvolts/meter)	Measurement distance (meters)
0.009-0.490	2400/F (kHz)	300
0.490-1.705	24000/F (kHz)	30
1.705-30.0	30	30
30-88	100 **	3
88-216	150 **	3
216-960	200 **	3
Above 960	500	3

All harmonics and spurious emission which are outside of the restricted band shall be 20dB below the in-band emission.

4.6.3 Test Results

The final measurement data was taken under the worst case operating modes, configurations, and/or cable positions. It also reflects the results including any modifications and/or special accessories listed in Sections 1.4 and Test Plan.

As originally tested, the EUT was found to be compliant to the requirements of the test standard(s).

Table 8: Transmit Spurious Emission at Band-Edge Requirements

Test Conditions: Radiated Measurement, Normal Temperature and Voltage only									
Antenna Type: Integrated					Power Setting: See Test Plan				
Max. Antenna Gain: -0.5 dBi					Signal State: Modulated				
Ambient Temp.: 23 °C					Relative Humidity: 32%				
Band-Edge Results									
Center Freq.	Mode	Edge Freq.	Pol.	Ant.	Table	Det.	Level	Limit	Margin
MHz		MHz	V/H	cm	Deg.	Pk/Avg	dBuV/m	dBuV/m	dB
2403.35	Transmitter – Flat	2390.00	V	255	28	Pk	48.36	74.00	-25.64
2403.35	Transmitter – Flat	2390.00	V	249	45	Ave	46.50	54.00	-7.50
2403.35	Transmitter – Flat	2390.00	H	261	69	Pk	51.37	74.00	-22.63
2403.35	Transmitter – Flat	2390.00	H	261	69	Ave	47.80	54.00	-6.20
2477.35	Transmitter – Flat	2483.50	H	254	91	Pk	50.75	74.00	-23.25
2477.35	Transmitter – Flat	2483.50	H	254	91	Ave	49.42	54.00	-4.58
2477.35	Transmitter – Flat	2483.50	V	268	348	Pk	51.14	74.00	-22.86
2477.35	Transmitter – Flat	2483.50	V	268	348	Ave	48.71	54.00	-5.29
Note: The above emissions are measured at the adjacent restricted banded.									

SOP 1 Radiated Emissions											Tracking # 31462894.001 Page 1 of 6
EUT Name		USB Wireless Audio Transmitter					Date		July 7, 2014		
EUT Model		Ear Force Stealth 500P TX					Temp / Hum in		23°C / 33%rh		
EUT Serial		PP #2					Temp / Hum out		N/A		
EUT Config.		Transmitter					Line AC / Freq		5VDC		
Standard		CFR47 Part 15 Subpart C					RBW / VBW		120 kHz/ 300 kHz		
Dist/Ant Used		3m / JB3					Performed by		Jeremy Luong		
Freq.	Raw	Cbl	AF	Level	Det.	Pol.	Hght.	Azt	Limit	Margin	Result
MHz	dBuV/m	dB	dB	dBuV/m		H/V	cm	deg	dBuV/m	dB	
Transmitted Data at 2441.35MHz											
236.13	39.00	1.90	-21.10	19.80	QP	V	155	194	46.00	-26.20	Pass
348.92	34.90	2.10	-18.00	18.90	QP	V	163	172	46.00	-27.10	Pass
399.67	30.70	2.20	-17.00	15.90	QP	V	124	-8	46.00	-30.10	Pass
598.27	29.20	2.50	-14.10	17.60	QP	V	261	96	46.00	-28.40	Pass
787.38	30.20	2.70	-11.50	21.40	QP	V	124	42	46.00	-24.60	Pass
898.56	28.90	2.90	-10.20	21.50	QP	V	146	48	46.00	-24.50	Pass
Spec Margin = Level - Limit, Level = Raw+ Cbl+ CF ± Uncertainty											
CF= Amp Gain + ANT Factor											
Combined Standard Uncertainty $u_c(y) = \pm 3.2$ dB Expanded Uncertainty $U = k u_c(y)$ $k = 2$ for 95% confidence											
Note: The worst case was observed at Channel 2441.35 MHz.											

SOP 1 Radiated Emissions

Tracking # 31462894.001 Page 2 of 6

EUT Name	USB Wireless Audio Transmitter	Date	July 8, 2014
EUT Model	Ear Force Stealth 500P TX	Temp / Hum in	22°C / 31%rh
EUT Serial	PP #2	Temp / Hum out	N/A
EUT Config.	Transmitter	Line AC / Freq	5VDC
Standard	CFR47 Part 15 Subpart C	RBW / VBW	120 kHz/ 300 kHz
Dist/Ant Used	3m / JB3	Date	Jeremy Luong

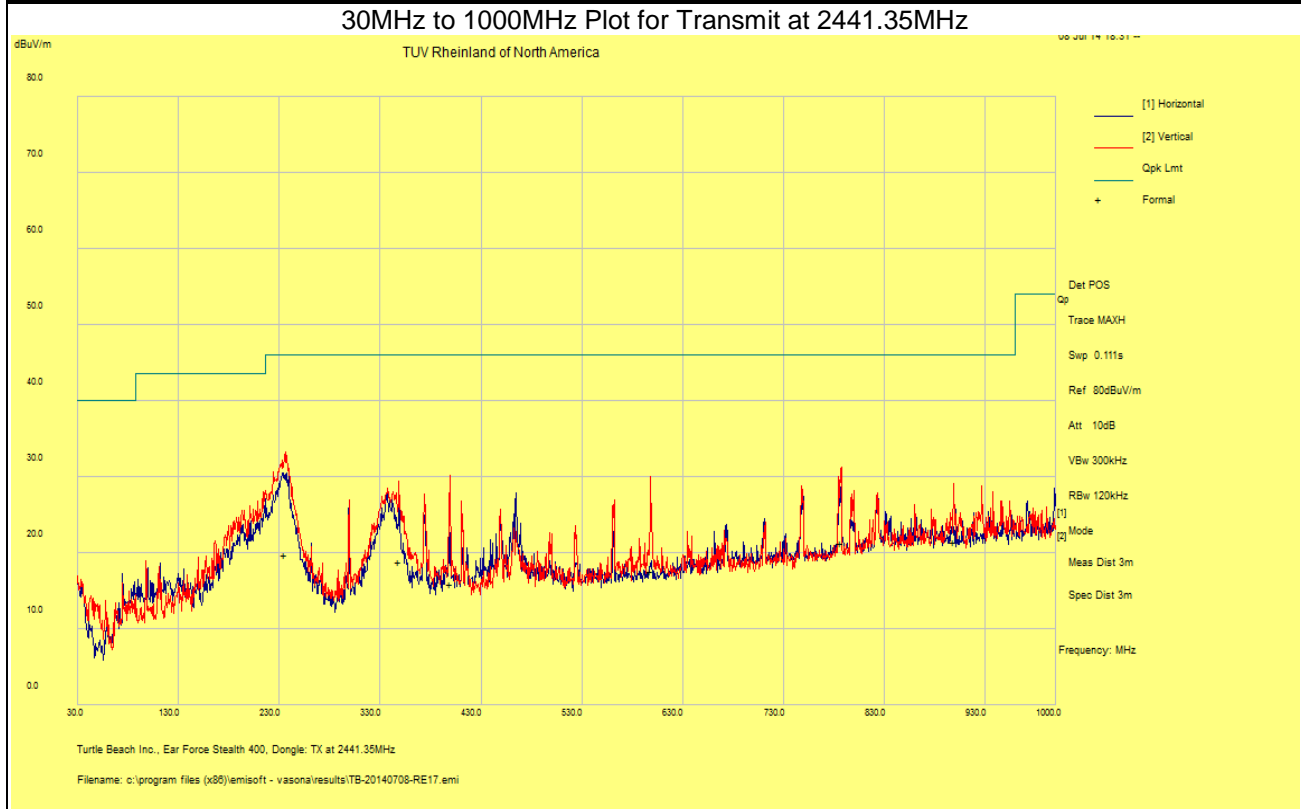

Notes: None.

SOP 1 Radiated Emissions											Tracking # 31462894.001 Page 3 of 6	
EUT Name		USB Wireless Audio Transmitter					Date		July 7, 2014			
EUT Model		Ear Force Stealth 500P TX					Temp / Hum in		23°C / 33%rh			
EUT Serial		PP #2					Temp / Hum out		N/A			
EUT Config.		Transmitter					Line AC / Freq		5VDC			
Standard		CFR47 Part 15 Subpart C					RBW / VBW		1MHz / 3MHz			
Dist/Ant Used		3m / DRH-118, 1m / RA42-K-F-4B-C					Performed by		Jeremy Luong			
Freq	Raw	Cbl	AF	Level	Det	Pol	Hght	Azt	Limit	Margin	Comment	
MHz	dBuV/m	dB	dB	dBuV/m		H/V	cm	deg	dBuV/m	dB		
Transmitted Data at 2403.35MHz												
7209.69	46.32	3.05	-11.70	37.67	Ave	H	127	162	54.00	-16.33	Harmonics	
9615.07	39.62	3.41	-8.50	34.53	Ave	H	120	176	54.00	-19.47	Harmonics	
Transmitted Data at 2441.35MHz												
7209.65	45.86	3.05	-11.70	37.22	Ave	H	234	190	54.00	-16.78	Harmonics	
9614.42	45.83	3.41	-8.50	40.74	Ave	H	124	152	54.00	-13.26	Harmonics	
Transmitted Data at 2477.35MHz												
7431.67	40.05	3.09	-11.08	32.06	Ave	H	207	138	54.00	-21.94	Harmonics	
4959.50	40.26	2.68	-17.10	25.85	Ave	V	156	83	54.00	-28.16	Harmonics	
Spec Margin = Level - Limit, Level = Raw+ Cbl+ CF ± Uncertainty												
CF= Amp Gain + ANT Factor												
Combined Standard Uncertainty $u_c(y) = \pm 3.2\text{dB}$ Expanded Uncertainty $U = ku_c(y)$ $k = 2$ for 95% confidence												
Notes: All emissions passed the spurious emission limit.												

SOP 1 Radiated Emissions

Tracking # 31462894.001 Page 4 of 6

EUT Name	USB Wireless Audio Transmitter	Date	July 7, 2014
EUT Model	Ear Force Stealth 500P TX	Temp / Hum in	23°C / 33%rh
EUT Serial	PP #2	Temp / Hum out	N/A
EUT Config.	Transmitter	Line AC / Freq	5VDC
Standard	CFR47 Part 15 Subpart C	RBW / VBW	1MHz / 3MHz
Dist/Ant Used	3m / DRH-118, 1m / RA42-K-F-4B-C	Performed by	Jeremy Luong

Above 1GHz Plots for Transmit Mode at 2403.35MHz

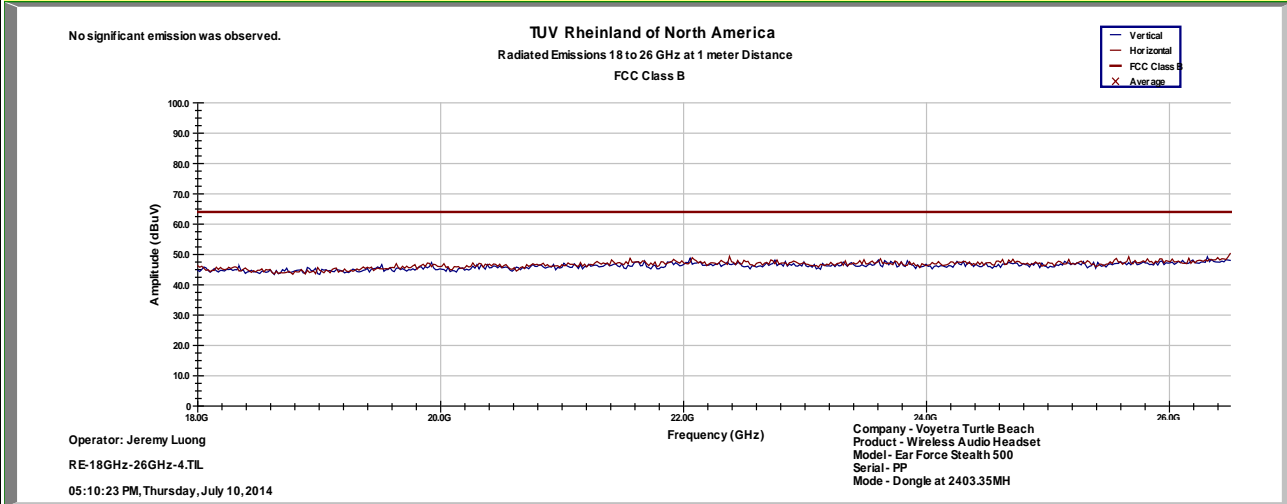
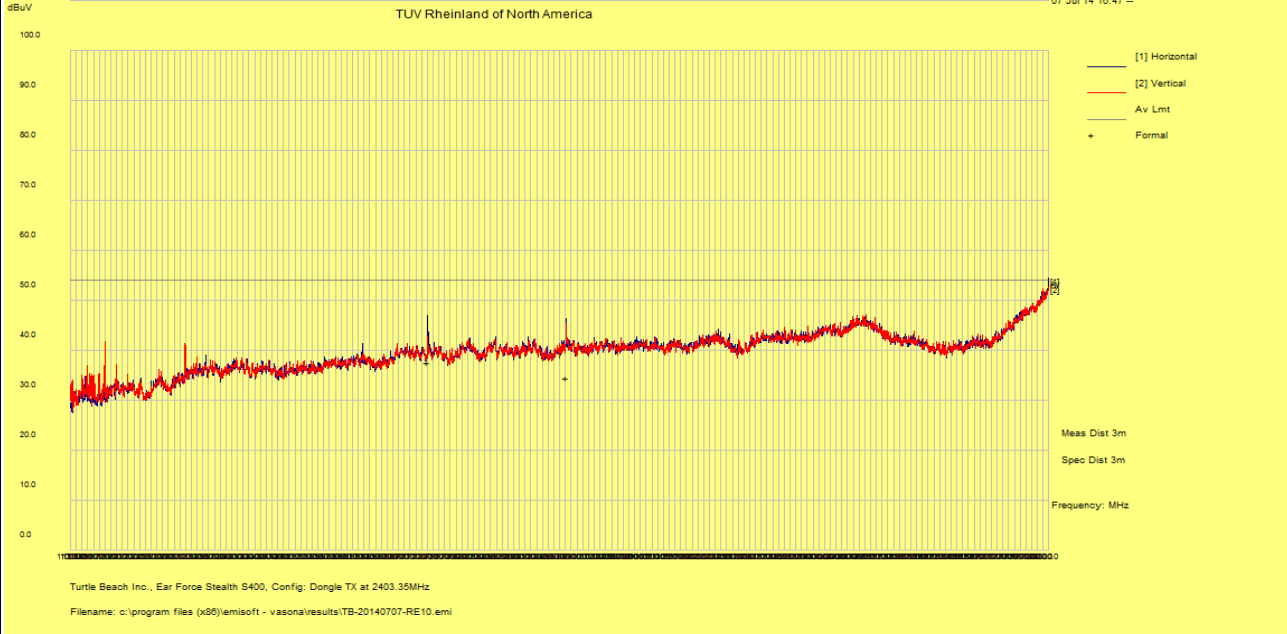

Notes: Limit was extrapolated to 1m distance for 18GHz – 25GHz range.
 1GHz – 25GHz Setting: RBW = 1MHz/ VBW = 3MHz

SOP 1 Radiated Emissions

Tracking # 31462894.001 Page 5 of 6

EUT Name	USB Wireless Audio Transmitter	Date	July 7, 2014
EUT Model	Ear Force Stealth 500P TX	Temp / Hum in	23°C / 33%rh
EUT Serial	PP #2	Temp / Hum out	N/A
EUT Config.	Transmitter	Line AC / Freq	5VDC
Standard	CFR47 Part 15 Subpart C	RBW / VBW	1MHz / 3MHz
Dist/Ant Used	3m / DRH-118, 1m / RA42-K-F-4B-C	Performed by	Jeremy Luong

Above 1GHz Plots for Transmit Mode at 2441.35MHz

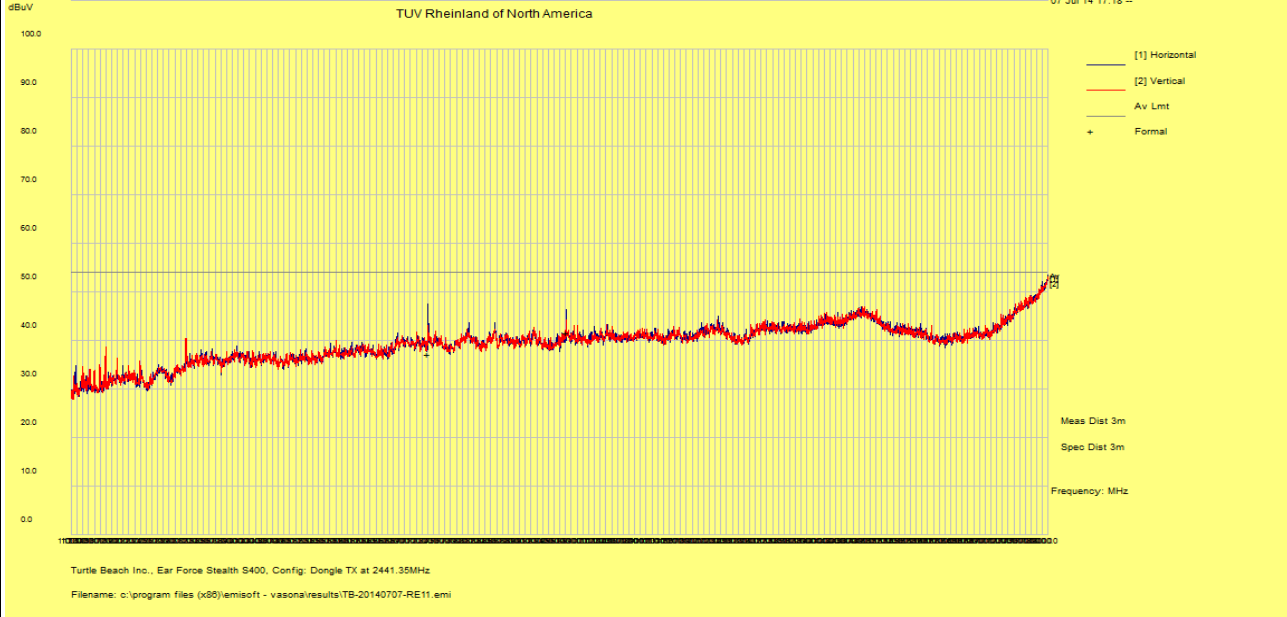

No significant emission was observed.

TUV Rheinland of North America
 Radiated Emissions 18 to 26 GHz at 1 meter Distance
 FCC Class B

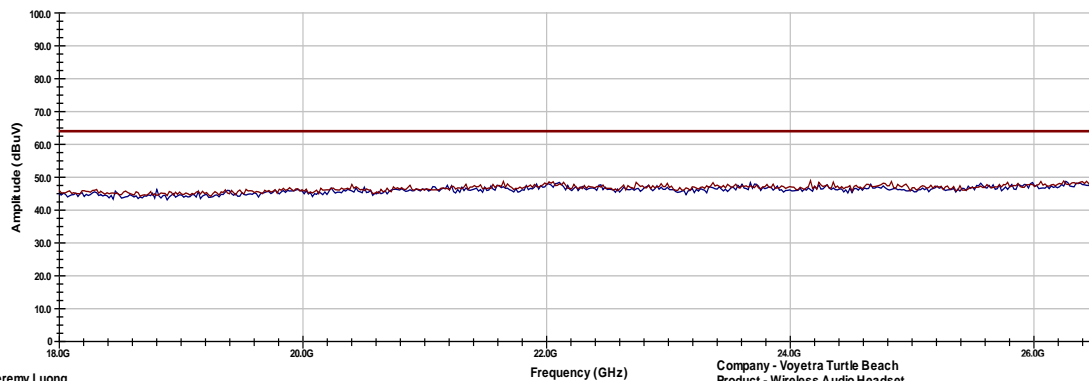

Notes: Limit was extrapolated to 1m distance for 18GHz – 25GHz range.
 1GHz – 25GHz Setting: RBW = 1MHz/ VBW = 3MHz

SOP 1 Radiated Emissions

Tracking # 31462894.001 Page 6 of 6

EUT Name	USB Wireless Audio Transmitter	Date	July 7, 2014
EUT Model	Ear Force Stealth 500P TX	Temp / Hum in	23°C / 33%rh
EUT Serial	PP #2	Temp / Hum out	N/A
EUT Config.	Transmitter	Line AC / Freq	5VDC
Standard	CFR47 Part 15 Subpart C	RBW / VBW	1MHz / 3MHz
Dist/Ant Used	3m / DRH-118, 1m / RA42-K-F-4B-C	Performed by	Jeremy Luong

Above 1GHz Plots for Transmit Mode at 2477.35MHz

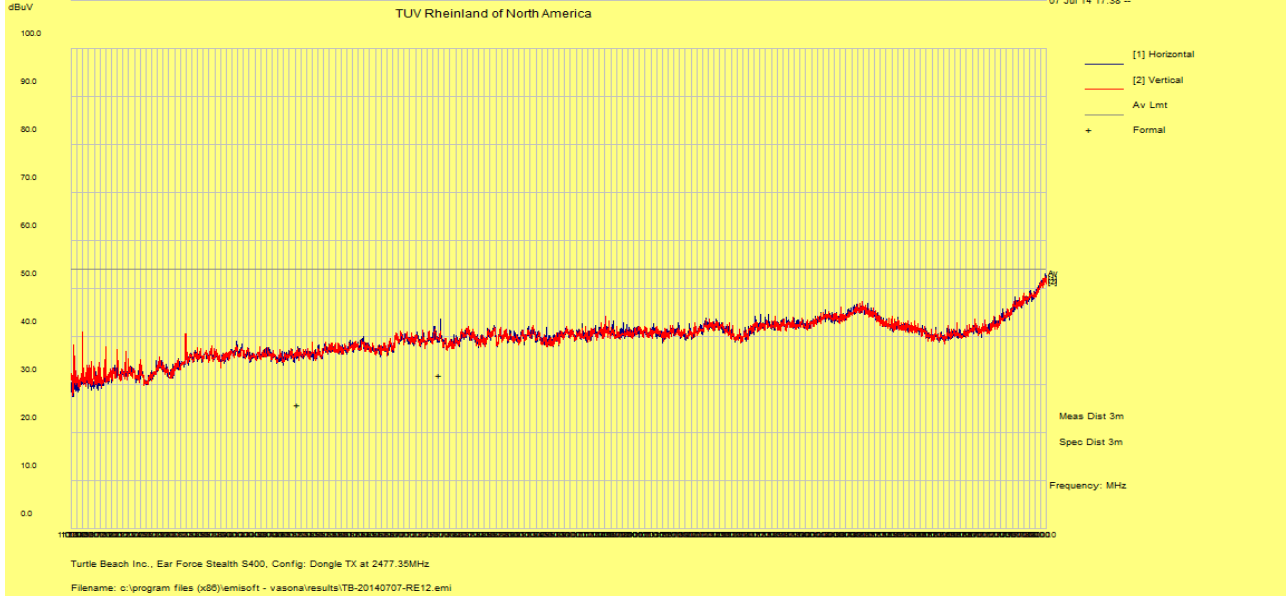

No significant emission was observed.

TUV Rheinland of North America
 Radiated Emissions 18 to 26 GHz at 1 meter Distance
 FCC Class B

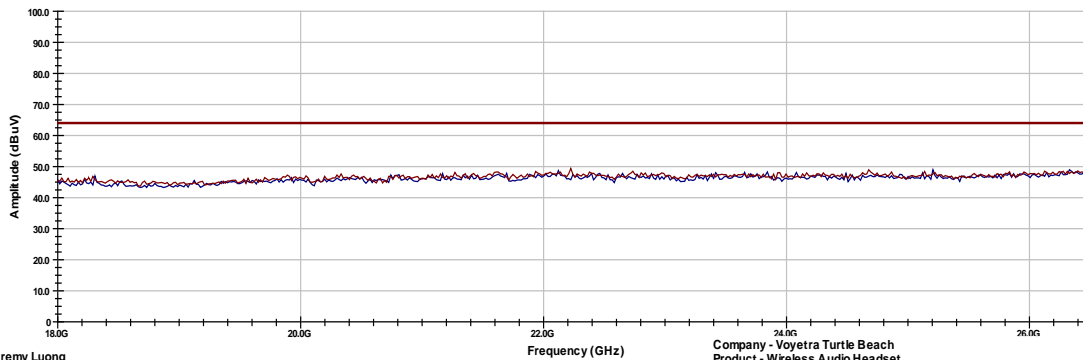

Operator: Jeremy Luong

RE-18GHz-26GHz-6.TIL

05:16:45 PM, Thursday, July 10, 2014

Company - Voyetra Turtle Beach
 Product - Wireless Audio Headset
 Model - Ear Force Stealth 500
 Serial - PP
 Mode - Dongle at 2477.35MH

Notes: Limit was extrapolated to 1m distance for 18GHz – 25GHz range.
 1GHz – 25GHz Setting: RBW = 1MHz/ VBW = 3MHz

4.6.4 Sample Calculation

The field strength is calculated by subtracting the Amplifier Gain and adding the Cable Loss and Antenna Correction Factor to the measured reading. The basic equation is as follows:

$$\text{Field Strength (dB}\mu\text{V/m)} = \text{FIM} - \text{AMP} + \text{CBL} + \text{ACF}$$

Where: FIM = Field Intensity Meter (dB μ V)
AMP = Amplifier Gain (dB)
CBL = Cable Loss (dB)
ACF = Antenna Correction Factor (dB/m)

$$\mu\text{V/m} = 10^{\frac{\text{dB}\mu\text{V/m}}{20}}$$

4.7 AC Conducted Emissions

Testing was performed in accordance with ANSI C63.4: 2003. These test methods are listed under the laboratory's A2LA Scope of Accreditation.

This test measures the levels emanating from the EUT's AC input port, thus evaluating the potential for the EUT to cause radio frequency interference to other electronic devices.

The AC conducted emissions of equipment under test shall not exceed the values in CFR47 Part 15.207: 2013 and RSS 210: 2010.

4.7.1 Test Methodology

A test program that controls instrumentation and data logging was used to automate the AC Power Line Conducted emission test procedure. The frequency range of interest was divided into sub-ranges such as to yield a frequency resolution of 9 kHz. Each phase and neutral of the AC power line were measured with respect to ground. Measurements were performed using a set of 50 μ H / 50 Ω LISNs.

Testing is either performed in 5m Chamber. The setup photographs clearly identify which site was used. The vertical ground plane used in the semi-anechoic chamber is a 2m x 2m solid aluminum frame and panel, and it is bonded to the horizontal ground plane.

In the case of tabletop equipment, the EUT is placed on a 1.0m x 1.5m non-conductive table 80cm above the ground plane and 40cm from a vertical ground reference plane. The rear of the EUT was positioned flush with the backside of the table and directly over the LISNs. The power and I/O cables were routed over the edge of the table and bundled approximately 40cm from the ground plane. Support equipment was powered from a separate LISN.

4.7.1.1 Deviations

There were no deviations from this test methodology.

4.7.2 Test Results

This test is not required since EUT is powered by 5 VDC voltage.

5 Test Equipment List

5.1 Equipment List

Equipment	Manufacturer	Model #	Serial/Inst #	Last Cal mm/dd/yy	Next Cal mm/dd/yy
Bilog Antenna	Sunol Sciences	JB3	A020502	04/12/2013	04/12/2015
Horn Antenna	Sunol Sciences	DRH-118	A040806	10/05/2012	10/05/2014
Horn Antenna	CMT	RA42-K-F-4B-C	020131-004	06/20/2013	07/20/2014
Spectrum Analyzer	Rohde & Schwarz	FSL6	100169	01/08/2014	02/08/2015
Spectrum Analyzer	Agilent	N9038A	MY52260210	01/08/2014	02/08/2015
Spectrum Analyzer	Rohde Schwarz	ESIB	832427/002	01/08/2014	02/08/2015
Spectrum Analyzer	Hewlett Packard	8546A	3325A00168	11/14/2013	11/14/2014
RF Pre-Selector	Hewlett Packard	85460A	3330A00174	11/14/2013	11/14/2014
Amplifier	Hewlett Packard	8447D	2944A07996	01/07/2014	02/07/2015
Amplifier	Miteq	TTA1800-30-4G	1842452	01/08/2014	02/08/2015
Amplifier	Rhode&Schwarz	TS-PR26	100011	06/20/2013	07/20/2014
LISN	Com-Power	LI-250	12111	01/07/2014	02/07/2015
Transient Limiter	Com-Power	LIT930	531582	01/08/2014	02/08/2015
Power Meter	Agilent	E4418B	MY45103902	01/09/2014	02/09/2015
Power Sensor	Hewlett Packard	8482A	55-5131	01/09/2014	02/09/2015
Notch Filter	Micro-Tronics	BRM50702	9	01/06/2014	02/06/2016

* Calibration of equipment past due for re-calibration will be performed expeditiously. If any equipment is found to be out of tolerance at that time, affected customers will be notified accordingly.

6 EMC Test Plan

6.1 Introduction

This section provides a description of the Equipment Under Test (EUT), configurations, operating conditions, and performance acceptance criteria. It is an overview of information provided by the manufacturer so that the test laboratory may perform the requested testing.

6.2 Customer

Table 9: Customer Information

Company Name	Voyetra Turtle Beach, Inc.
Address	100 Summit Lake Drive, Suite 100
City, State, Zip	Valhalla, New York 10595
Country	USA

Table 10: Technical Contact Information

Name	Tim Blaney
E-mail	tim@commcepts.net
Phone	(530) 277-3482

6.3 Equipment Under Test (EUT)

Table 11: EUT Specifications

EUT Specification	
Package Dimensions	69.85mm (2.75") x 25.4mm (1.0") x 9.5mm (0.375")
Power Input	Transmitter Input Voltage: 5.0 Vdc (Host Computer)
Environment	Indoor
Operating Temperature Range:	0 to 50 degrees C
Multiple Feeds:	<input type="checkbox"/> Yes and how many <input checked="" type="checkbox"/> No
Hardware Version	PP
Part Number	N/A
RF Software Version	VMI Test Software V0.5
Operating Mode	VMI RF Protocol
Transmitter Frequency Band	2403.35 GHz to 2477.35 GHz
Max. Rated Power Output	-0.74 dBm
Power Setting @ Operating Channel	0 dBm
Antenna Type	Attached on board
Modulation Type	<input type="checkbox"/> AM <input type="checkbox"/> FM <input checked="" type="checkbox"/> DSSS <input type="checkbox"/> OFDM <input type="checkbox"/> Other describe:
Date Rate	11 kbps
TX/RX Chain (s)	1
Antenna Gain	-0.5 dBi
Directional Gain Type	<input checked="" type="checkbox"/> Uncorrelated <input checked="" type="checkbox"/> No Beam-Forming <input type="checkbox"/> Other describe:
Type of Equipment	<input type="checkbox"/> Table Top <input type="checkbox"/> Wall-mount <input type="checkbox"/> Floor standing cabinet <input checked="" type="checkbox"/> Other describe: <i>Head wear device.</i>
Note: Aux 0 is the default antenna output.	

Table 12: Interface Specifications

Interface Type	Cabled with what type of cable?	Is the cable shielded?	Maximum potential length of the cable?	Metallic (M), Coax (C), Fiber (F), or Not Applicable?
USB	Terminated	<input checked="" type="checkbox"/> Yes	<input type="checkbox"/> Metric: --	<input checked="" type="checkbox"/> M
Note: USB connected directly to host computer.				

Table 13: Supported Equipment

Equipment	Manufacturer	Model	Serial	Used for
Laptop	Dell Computer	D630	28353268189	Set test mode

Table 14: Description of Sample used for Testing

Device	Serial Number	Configuration	Used For
Ear Force Stealth 500P TX	PP #2	Radiated Sample	Radiated Emissions.
Ear Force Stealth 500P TX	PP #1	Conducted Sample	Output Power, Occupied Bandwidth, Conducted Spurious Emissions, Peak Power Spectral Density
Note: None			

Table 15: Description of Test Configuration used for Radiated Measurement.

Device	Antenna	Mode	Setup Description
Ear Force Stealth 500P TX	Attached	Transmit & Receive	Ear Force Stealth 500P TX positioned horizontally, typically usage.
Note: The final setup configuration used for testing.			

Table 16: Final Test Mode for 2403.35 MHz to 2477.35MHz Band

Test	Ear Force Stealth 500P TX
Occupied Bandwidth	2403.35, 2441.35, 2477.35 MHz @ 11 kbps
Output Power	2403.35, 2441.35, 2477.35 MHz @ 11 kbps
Peak Power Spectral Density	2403.35, 2441.35, 2477.35 MHz @ 11 kbps
Out-of-Band (-30 dBr)	2403.35, 2441.35, 2477.35 MHz @ 11 kbps
Band-Edge (Radiated)	2403.35, 2477.35 MHz @ 11 kbps
Transmitted Spurious Emission	2403.35, 2441.35, 2477.35 MHz @ 11 kbps
AC Conducted Emission	NA
Note: EUT transmits at 100% duty cycle.	

6.4 Test Specifications

Testing requirements

Table 17: Test Specifications

Emissions and Immunity	
Standard	Requirement
CFR 47 Part 15.247: 2014	All
RSS 210 Iss. 8 2010	All