

SPECIFICATION

Laser mark:

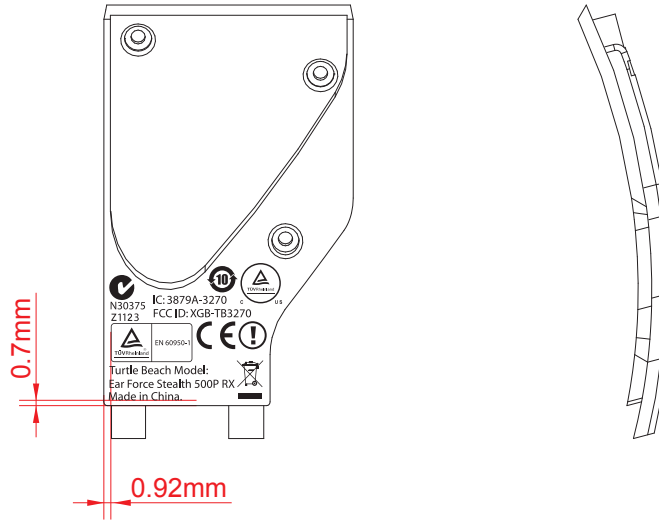
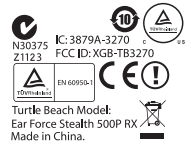

Note

- 1.Dimension:
- 2.Thickness
- 3.Material:
- 4.Printing Color:
- 5.Adhesive:

Turtle Beach Confidential

Drawing No.	EE Approved		Model Name		Description					
03911-A4-1031185	Name	Date	Headband Cover-R Laser mark		PX41 Headset Artwork					
Part No.	Approved		Checked		Drawn		Designed			
FE8337	Name	Date	Name	Date	Name	Date	Name	Date		
	Connie	2014.07.16	Alice Li	2014.07.16	William Chang	2014.07.16	Mike Hsu	2014.07.16		
This drawing contains information that is proprietary to Tatung A.E.B.U.				Version	01	Scale	1:1	Unit	mm	
							Sheet	1/1	Size	A4