

Emissions Test Report

EUT Name: Wireless Audio Headset

Model No.: Ear Force Stealth 420X RX

CFR 47 Part 15.247:2015 and RSS 210:2010

Prepared for:

Voyetra Turtle Beach, Inc.
100 Summit Lake Drive, Suite 100
Valhalla, New York 10595 USA

Prepared by:

TUV Rheinland of North America, Inc.
1279 Quarry Lane
Pleasanton, CA 94566
Tel: (925) 249-9123
Fax: (925) 249-9124
<http://www.tuv.com/>

Report/Issue Date: April 23, 2015
Report Number: 31560647.001
Revision Number: 0
Project Number: 0000126477

Statement of Compliance

Manufacturer: Voyetra Turtle Beach, Inc.
100 Summit Lake Drive, Suite 100
Valhalla, New York 10595 USA

Requester / Applicant: Tim Blaney
(530) 277-3482

Name of Equipment: Wireless Audio Headset
Model No. Ear Force Stealth 420X RX (TB300-2470-01)

Type of Equipment: Intentional Radiator
Application of Regulations: CFR 47 Part 15.247:2015 and RSS 210:2010

Test Dates: March 15, 2015 to April 12, 2015

Guidance Documents:

Emissions: ANSI C63.10: 2009, KDB 558074 D01 DTS Measurement Guidance v03r01

Test Methods:

Emissions: ANSI C63.10: 2009, KDB 558074 D01 DTS Measurement Guidance v03r01

The electromagnetic compatibility test and documented data described in this report has been performed and recorded by TUV Rheinland, in accordance with the standards and procedures listed herein. As the responsible authorized agent of the EMC laboratory, I hereby declare that the equipment described above has been shown to be compliant with the EMC requirements of the stated regulations and standards based on these results. If any special accessories and/or modifications were required for compliance, they are listed in the Executive Summary of this report.

This report must not be used to claim product endorsement by A2LA or any agency of the U.S. Government. This report contains data that are not covered by A2LA accreditation. This report shall not be reproduced except in full, without the written authorization of TUV Rheinland of North America.

<u>Jeremy Luong</u>	<u>April 23, 2015</u>	<u>David Spencer</u>	<u>April 23, 2015</u>
Test Engineer	Date	Laboratory Signatory	Date



Industry Canada
Industrie Canada

Testing Cert #3331.02

US5254

2932M-1

Table of Contents

1	Executive Summary	6
1.1	Scope.....	6
1.2	Purpose.....	6
1.3	Summary of Test Results.....	6
1.4	Special Accessories.....	7
1.5	Equipment Modifications.....	7
2	Laboratory Information	8
2.1	Accreditations & Endorsements.....	8
2.1.1	US Federal Communications Commission.....	8
2.1.2	NIST / A2LA.....	8
2.1.3	Canada – Industry Canada.....	8
2.1.4	Japan – VCCI.....	8
2.1.5	Acceptance by Mutual Recognition Arrangement.....	9
2.2	Test Facilities.....	9
2.2.1	Emission Test Facility.....	9
2.2.2	Immunity Test Facility.....	9
2.3	Measurement Uncertainty.....	9
2.3.1	Sample Calculation – radiated & conducted emissions.....	10
2.3.2	Measurement Uncertainties.....	11
2.4	Calibration Traceability.....	11
3	Product Information	12
3.1	Product Description.....	12
3.2	Equipment Configuration.....	12
3.3	Operating Mode.....	12
3.4	Unique Antenna Connector.....	13
3.4.1	Results.....	13
4	Emissions	14
4.1	Output Power Requirements.....	14
4.1.1	Test Method.....	14
4.1.2	Results.....	15
4.2	Occupied Bandwidth.....	19
4.2.1	Test Method.....	19
4.2.2	Results.....	20
4.3	Out-of-Band Emissions.....	24
4.3.1	Test Method.....	24
4.3.2	Test Result.....	25
4.4	Peak Power Spectral Density.....	29
4.4.1	Test Method.....	29
4.4.2	Results.....	30
4.5	Maximum Permissible Exposure.....	33

Table of Contents

4.5.1	Test Methodology	33
4.5.2	FCC KDB 447498 D01 – General SAR Test Exclusion Guidance	33
4.5.3	EUT Operating Condition.....	34
4.5.4	Classification	34
4.5.5	SAR Test Exclusion Threshold.....	34
4.6	Transmitter Spurious Emissions	35
4.6.1	Test Methodology	35
4.6.2	Transmitter Spurious Emission Limit	36
4.6.3	Test Results.....	36
4.6.4	Sample Calculation	48
4.7	AC Conducted Emissions	49
4.7.1	Test Methodology	49
4.7.2	Test Results.....	49
5	Test Equipment List.....	50
5.1	Equipment List.....	50
6	EMC Test Plan.....	51
6.1	Introduction.....	51
6.2	Customer.....	51
6.3	Equipment Under Test (EUT)	52
6.4	Test Specifications.....	55

Index of Tables

Table 1: Summary of Test Results 6
Table 2: Summary of Uncertainties 11
Table 3: RF Output Power at the Antenna Port – Test Results 15
Table 5: Occupied Bandwidth – Test Results 20
Table 6: Out of Band Emissions – Test Results 25
Table 7: Peak Power Spectral Density – Test Results 30
Table 8: Transmit Spurious Emission at Band-Edge Requirements 37
Table 9: Customer Information 51
Table 10: Technical Contact Information 51
Table 11: EUT Specifications 52
Table 12: Interface Specifications 53
Table 13: Supported Equipment 53
Table 14: Description of Sample used for Testing 53
Table 15: Description of Test Configuration used for Radiated Measurement. 53
Table 16: Final Test Mode for 2403.35 MHz to 2477.35MHz Band 54
Table 17: Test Specifications 55

1 Executive Summary

1.1 Scope

This report is intended to document the status of conformance with the requirements of the CFR 47 Part 15.247:2015 and RSS 210:2010 based on the results of testing performed on March 15, 2015 through April 12, 2015 on the Wireless Audio Headset Model Ear Force Stealth 420X RX manufactured by Voyetra Turtle Beach, Inc.. This report only applies to the specific samples tested under the stated test conditions. It is the responsibility of the manufacturer to assure that additional production units of this model are manufactured with identical or EMI equivalent electrical and mechanical components. This report is further intended to document changes and modifications to the EUT throughout its life cycle. All documentation will be included as a supplement.

1.2 Purpose

Testing was performed to evaluate the EMC performance of the EUT in accordance with the applicable requirements, procedures, and criteria defined in the application of regulations and application of standards listed in this report.

1.3 Summary of Test Results

Table 1: Summary of Test Results

Test	Test Method ANSI C63.4: 2009 / ANSI C64.10:2009	Test Parameters	Measured Value	Result
Spurious Emission in Transmitted Mode	CFR47 15.209, RSS-GEN Sect.7.2.3	Class B	-4.16 dB (Margin)	Complied
Restricted Bands of Operation	CFR47 15.205, RSS-210 Sect.2.6	Class B		Complied
AC Power Conducted Emission	CFR47 15.207, RSS-GEN Sect.7.2.2	Class B	NA	Complied
Occupied Bandwidth	CFR47 15.247 (a2), RSS GEN Sect.4.4.1	≥ 500 kHz	1.653 MHz	Complied
Maximum Transmitted Power	CFR47 15.247 (b3), RSS-210 Sect. A.8.4	30 dBm w/ 6 dBi antenna	+3.00 dBm	Complied
Peak Power Spectral Density	CFR47 15.247 (e), RSS-210 Sect. A.8.2	8 dBm/ 3 kHz	-30.46 dBm	Complied
Band Edge Measurement	CFR47 15.247 (d), RSS-210 Sect. A.8.5	-30 dB	-13.98 dB (Margin)	Complied

Note: Since EUT is a portable device where the end user will have the direct contact as head wear device, RF Exposure/SAR requirements are calculated for human head and body, and EUT met FCC KDB 447498 SAR exclusion. See Section 4.5 of this report

1.4 *Special Accessories*

No special accessories were necessary in order to achieve compliance.

1.5 *Equipment Modifications*

None.

2 Laboratory Information

2.1 Accreditations & Endorsements

2.1.1 US Federal Communications Commission



TUV Rheinland of North America at 1279 Quarry Lane, Ste. A., Pleasanton, CA 94566, is accredited by the commission for performing testing services for the general public on a fee basis. These laboratory test facilities have been fully described in reports submitted to and accepted by the FCC. The laboratory scope of accreditation includes: Title 47 CFR Parts 15, 18, and 90. The accreditation is updated every 3 years.

2.1.2 NIST / A2LA



TUV Rheinland of North America is accredited by the National Voluntary Laboratory Accreditation Program, which is administered under the auspices of the National Institute of Standards and Technology. The laboratory has been assessed and accredited in accordance with ISO Guide 17025:1999 and ISO 9002 (Lab Code US5254). The scope of laboratory accreditation includes emission and immunity testing. The accreditation is updated annually.

2.1.3 Canada – Industry Canada



TUV Rheinland of North America at the 1279 Quarry Ln, Pleasanton, CA 94566 address is accredited by Industry Canada for performing testing services for the general public on a fee basis. This laboratory test facilities have been fully described in reports submitted to and accepted by Industry Canada (File Number 2932M). This reference number is the indication to the Industry Canada Certification Officers that the site meets the requirements of RSS 212, Issue 1 (Provisional). The accreditation is updated every 3 years.

2.1.4 Japan – VCCI



The Voluntary Control Council for Interference by Information Technology Equipment (VCCI) is a group that consists of Information Technology Equipment (ITE) manufacturers and EMC test laboratories. The purpose of the Council is to take voluntary control measures against electromagnetic interference from Information Technology Equipment, and thereby contribute to the development of a socially beneficial and responsible state of affairs in the realm of Information Technology Equipment in Japan. TUV Rheinland of North America at 1279 Quarry Ln, Pleasanton, CA 94566 has been assessed and approved in accordance with the Regulations for Voluntary Control Measures.

VCCI Registration No. for Pleasanton: A-0031

VCCI Registration No. for Santa Clara: A-0032

2.1.5 Acceptance by Mutual Recognition Arrangement



The United States has an established agreement with specific countries under the Asia Pacific Laboratory Accreditation Corporation (APLAC) Mutual Recognition Arrangement. Under this agreement, all TUV Rheinland at 1279 Quarry Ln, Pleasanton, CA 94566 test results and test reports within the scope of the laboratory NIST / A2LA accreditation will be accepted by each member country.

2.2 Test Facilities

All of the test facilities are located at 1279 Quarry Lane, Ste. A, Pleasanton, California 94566, USA. The 2305 Mission College, Santa Clara, 95054, USA location is considered a Pleasanton annex.

2.2.1 Emission Test Facility

The Semi-Anechoic chamber and AC Line Conducted measurement facility used to collect the radiated and conducted data has been constructed in accordance with ANSI C63.7:1992. The site has been measured in accordance with and verified to comply with the theoretical normalized site attenuation requirements of ANSI C63.4-2009, at a test distance of 3 and 5 meters. The site is listed with the FCC and accredited by A2LA (Lab Code US5254). The 3/5-meter semi-anechoic chamber used to collect the radiated data has been verified to comply with the theoretical normalized site attenuation requirements of ANSI C63.4-2009, at a test distance of 3 meter and 5 meters. A report detailing this site can be obtained from TUV Rheinland of North America.

2.2.2 Immunity Test Facility

ESD, EFT, Surge, PQF: These tests are performed in an environmentally controlled room with a 3.7 m x 4.8 m x 3.175 mm thick aluminum floor connected to PE ground.

For ESD testing, tabletop equipment is placed on an insulated mat with a surface resistivity of 10^9 Ohms/square on a 1.6 m x 0.8 m x 0.8 m high non-conductive table with a 3.175 mm aluminum top (Horizontal Coupling Plane). The HCP is connected to the main ground plane via a low impedance ground strap through two 470-k Ω resistors. The Vertical Coupling Plane consists of an aluminum plate 50 cm x 50 cm x 3.175 mm thick. The VCP is connected to the main ground plane via a low impedance ground strap through two 470-k Ω resistors.

For EFT, Surge, PQF, the HCP and VCP are removed.

RF Field Immunity testing is performed in a 7.3m x 4.3m x 4.1m anechoic chamber.

RF Conducted and Magnetic Field Immunity testing is performed on a 4.8m x 3.7m x 3.175mm thick aluminum ground plane.

All test areas allow a minimum distance of 1 meter from the EUT to walls or conducting objects.

2.3 Measurement Uncertainty

Two types of measurement uncertainty are expressed in this report, per *ISO Guide To The Expression Of Uncertainty In Measurement*, 1st Edition, 1995.

The Combined Standard Uncertainty is the standard uncertainty of the result of a measurement when that result is obtained from the values of a number of other quantities; it is equal to the positive square root of the sum of the variances or co-variances of these other quantities, weighted according to how the measurement result varies with changes in these quantities. The term *standard uncertainty* is the result of a measurement expressed as a standard deviation.

The Expanded Uncertainty defines an interval about the result of a measurement that may be expected to encompass a large fraction of the distribution of values that could reasonably be attributed to the measurand. The fraction may be viewed as the coverage probability or level of confidence of the interval.

2.3.1 Sample Calculation – radiated & conducted emissions

The field strength is calculated by subtracting the Amplifier Gain and adding the Cable Loss and Antenna Correction Factor to the measured reading. The basic equation is as follows:

$$\text{Field Strength (dB}\mu\text{V/m)} = \text{RAW} - \text{AMP} + \text{CBL} + \text{ACF}$$

Where: RAW = Measured level before correction (dB μ V)

AMP = Amplifier Gain (dB)

CBL = Cable Loss (dB)

ACF = Antenna Correction Factor (dB/m)

$$\mu\text{V/m} = 10^{\frac{\text{dB}\mu\text{V/m}}{20}}$$

Sample radiated emissions calculation @ 30 MHz

Measurement +Antenna Factor–Amplifier Gain+Cable Loss=Radiated Emissions (dBuV/m)

$$25 \text{ dBuV/m} + 17.5 \text{ dB} - 20 \text{ dB} + 1.0 \text{ dB} = 23.5 \text{ dBuV/m}$$

2.3.2 Measurement Uncertainties

Table 2: Summary of Uncertainties

	U_{lab}	U_{cispr}
Radiated Disturbance		
30 MHz – 25,000 MHz	3.2 dB	5.2 dB
Conducted Disturbance @ Mains Terminals		
150 kHz – 30 MHz	2.4 dB	3.6 dB
Disturbance Power		
30 MHz – 300 MHz	3.92 dB	4.5 dB

Note: U_{lab} is the calculated Combined Standard Uncertainty
 U_{cispr} is the measurement uncertainty requirement per CISPR 16.

Measurement Uncertainty Immunity

The estimated combined standard uncertainty for ESD immunity measurements is $\pm 4.1\%$.
The estimated combined standard uncertainty for radiated immunity measurements is $\pm 2.7\text{dB}$.
The estimated combined standard uncertainty for conducted immunity measurements is $\pm 1.4\text{dB}$.
The estimated combined standard uncertainty for damped oscillatory wave immunity measurements is $\pm 8.8\%$.
The estimated combined standard uncertainty for harmonic current and flicker measurements is $\pm 0.45\%$.

Measurement Uncertainty – Radio Testing

The estimated combined standard uncertainty for frequency error measurements is $\pm 3.88\text{ Hz}$
The estimated combined standard uncertainty for carrier power measurements is $\pm 1.59\text{ dB}$.
The estimated combined standard uncertainty for adjacent channel power measurements is $\pm 1.47\text{ dB}$.
The estimated combined standard uncertainty for modulation frequency response measurements is $\pm 0.46\text{ dB}$.
The estimated combined standard uncertainty for transmitter conducted emission measurements is $\pm 4.01\text{ dB}$

The expanded uncertainty at a level of 95% confidence is obtained by multiplying the combined standard uncertainty by a coverage factor of 2. Compliance criteria are not based on measurement uncertainty.

2.4 Calibration Traceability

All measurement instrumentation is traceable to the National Institute of Standards and Technology (NIST). Measurement method complies with ANSI/NCSL Z540-1-1994 and ISO Guide 17025:2005.

3 Product Information

3.1 Product Description

The Ear Force Stealth 420X Wireless Gaming System consists of two main communication modules, the Stealth 420X RX (“Headset”) and the Stealth 420X TX (“Transmitter”). These two modules comprise a closed-loop wireless audio gaming system that utilize a proprietary 2.4 GHz communication technology to offer wireless streaming audio and chat/talkback capabilities.

3.2 Equipment Configuration

A description of the equipment configuration is given in Test Plan Section. The EUT was tested as called for in the test standard and was configured and operated in a manner consistent with its intended use. The EUT was connected to rated power and allowed to reach intended operating conditions. The placement of the EUT system components was guided by the test standard and selected to represent typical installation conditions.

In the case of a EUT that can operate in more than one configuration, preliminary testing was performed to determine the configuration that produced maximum radiation.

The final configuration was selected to produce the worst case radiation for emissions testing and to place the EUT in the most susceptible state for immunity testing.

3.3 Operating Mode

A description of the operation mode is given in Test Plan Section. In the case of a EUT that can operate in more than one state, preliminary testing was performed to determine the operating mode that produced maximum radiation.

The final operating mode was selected to produce the worst case radiation for emissions testing and to place the EUT in the most susceptible state for immunity testing.

3.4 Unique Antenna Connector

An intentional radiator shall be designed to ensure that no antenna other than that furnished by the responsible party shall be used with the device. The use of a permanently attached antenna or of an antenna that uses a unique coupling to the intentional radiator shall be considered sufficient to comply with the provisions of this section. The manufacturer may design the unit so that a broken antenna can be replaced by the user, but the use of a standard antenna jack or electrical connector is prohibited. This requirement does not apply to carrier current devices or to devices operated under the provisions of CFR47 Parts 15.211, 15.213, 15.217, 15.219, or 15.221.

3.4.1 Results

The Ear Force Stealth 420X RX uses the permanently attached PCB trace antennas inside the device. See EUT Photo for details.

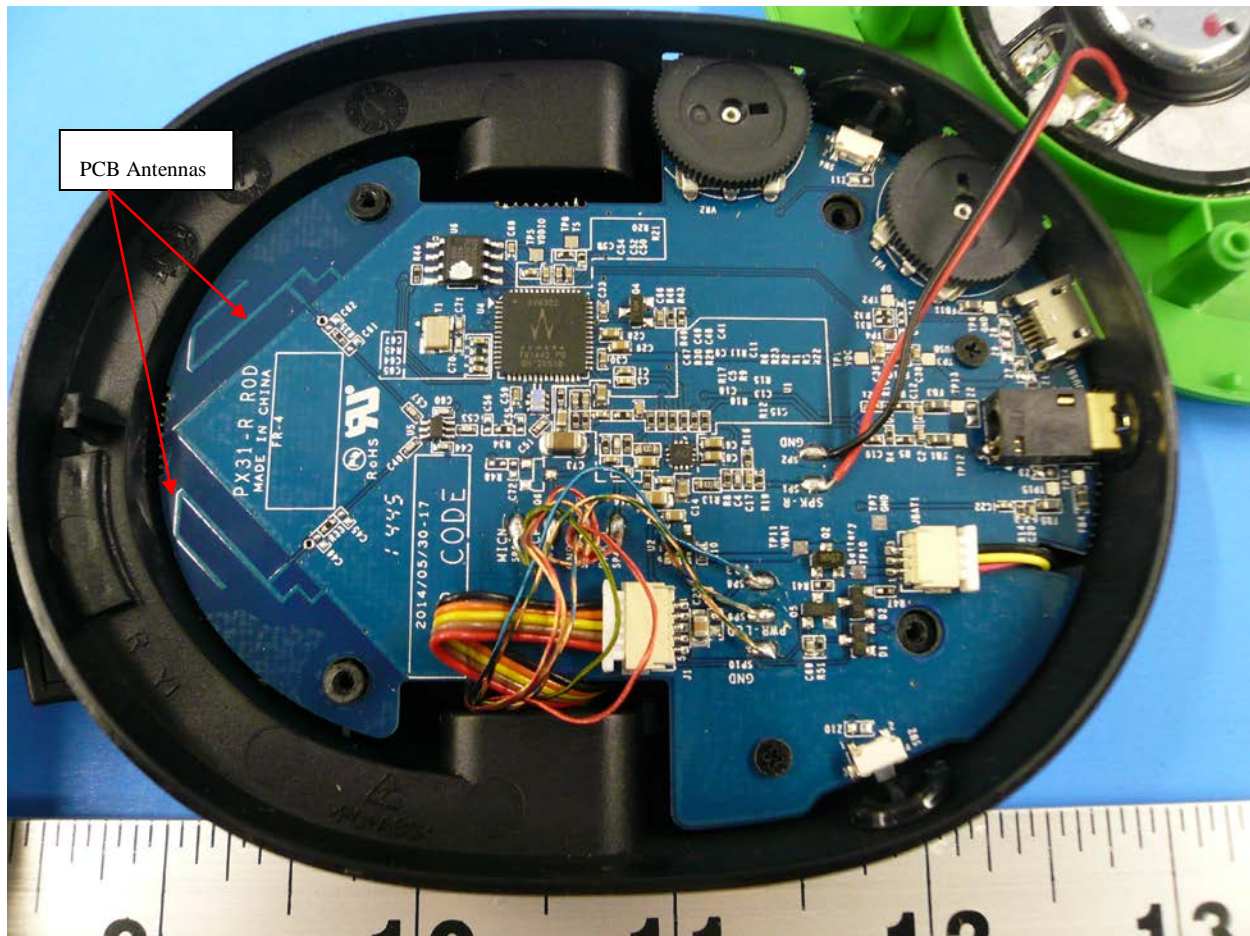

4 Emissions

Testing was performed in accordance with CFR 47 Part 15.247:2015 and RSS 210 Annex 8:2010. These test methods are listed under the laboratory's A2LA Scope of Accreditation. This test measures the levels emanating from the EUT, thus evaluating the potential for the EUT to cause radio frequency interference to other electronic devices. Procedures described in ANSI C63.10: 2009 were used.

4.1 Output Power Requirements

The maximum peak output power requirement is the maximum equivalent isotropic radiated power delivering at the transmitting antenna under specified conditions of measurements in the presence of modulation.

The maximum output power and harmonics shall not exceed CFR47 Part 15.247 (b3):2015 and RSS-210 A.8.4: 2010

The maximum transmitted power is +30 dBm or 1 Watt.

4.1.1 Test Method

The conducted method was used to measure the channel power output according to ANSI C63.10:2009 Section 6.10.3.1. The measurement was performed with modulation per CFR47 Part15.247 (b3):2014 and RSS-210 A.8.4: 2010. This test was conducted on 3 channels of Sample, S/N PP #1. The worst mode result indicated below.

Test Setup:

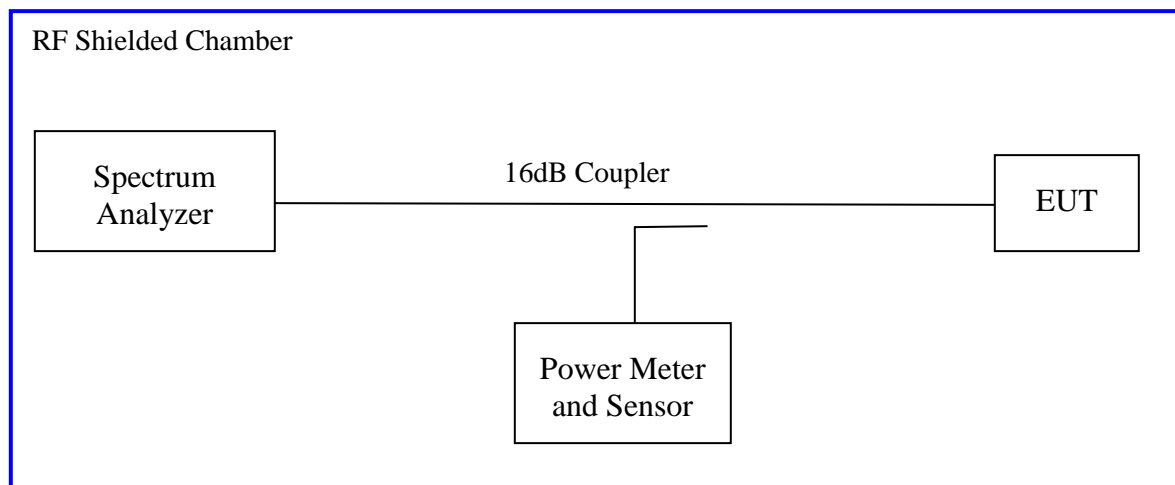

Method AVGSA-1 of "KDB 558074 – DTS Measurement Guidance v03r01" applies since the Ear Force Stealth 420X RX continuously transmits with duty cycle greater than 98%. Sample detector was used.

4.1.2 Results

As originally tested, the EUT was found to be compliant to the requirements of the test standard(s).

Table 3: RF Output Power at the Antenna Port – Test Results

Test Conditions: Conducted Measurement			Date: March 12, 2015		
Antenna Type: Integrated			Power Setting: 0 dBm		
Antenna Gain: +2.0 dBi			Signal State: Modulated at 100%		
Ambient Temp.: 23 °C			Relative Humidity: 30%		
Wireless Audio Headset					
Frequency (MHz)	Limit [dBm]	Output [dBm]	Duty Cycle [dB]	∑ Power [dBm]	Margin [dB]
2403.35	+30.00	3.00			-27.00
2441.35	+30.00	2.76			-27.24
2477.35	+30.00	2.79			-27.21
Note: The headset transmitted at 100% duty cycle.					

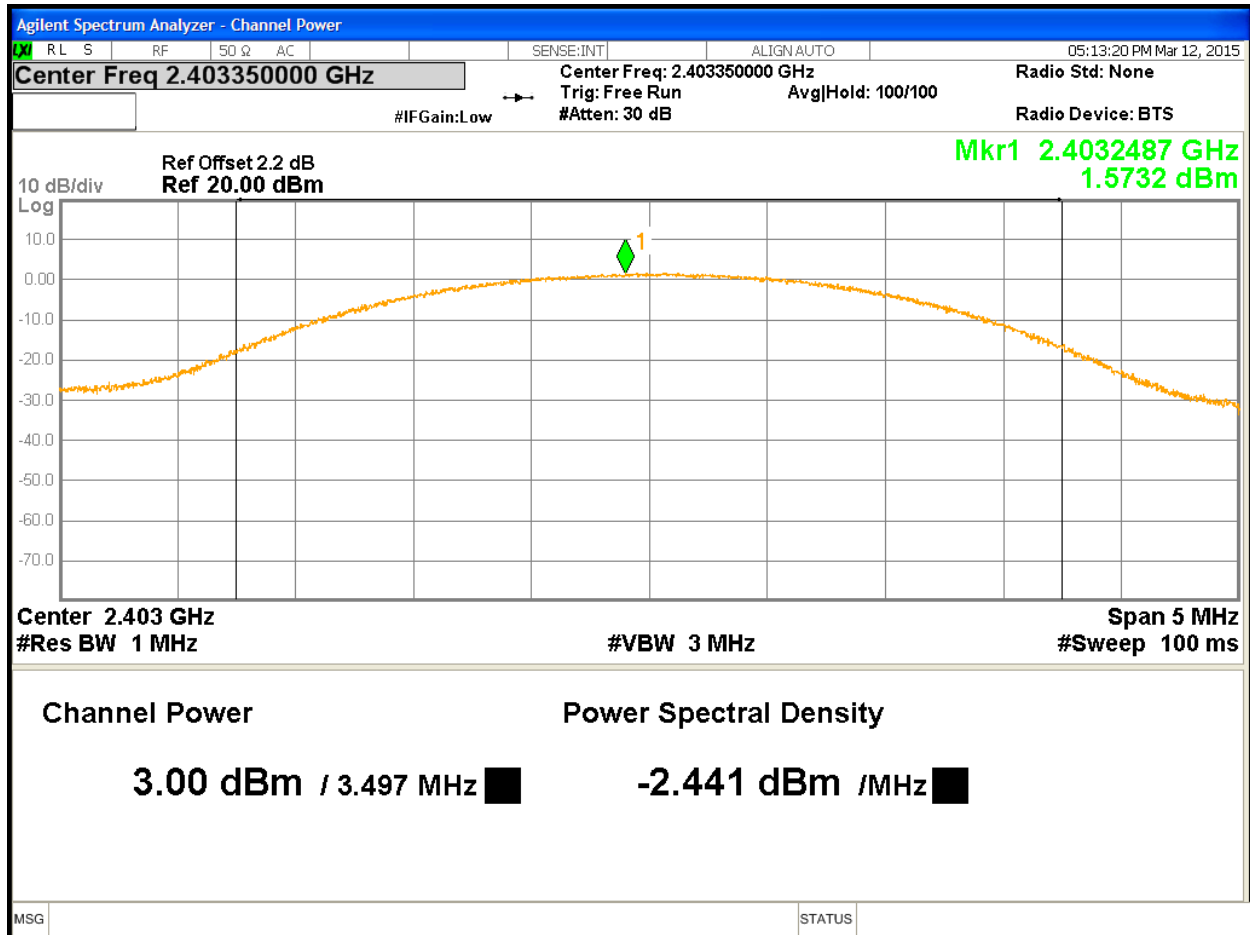

Figure 1: Maximum Conducted Output Power at 2403.35MHz – Headset

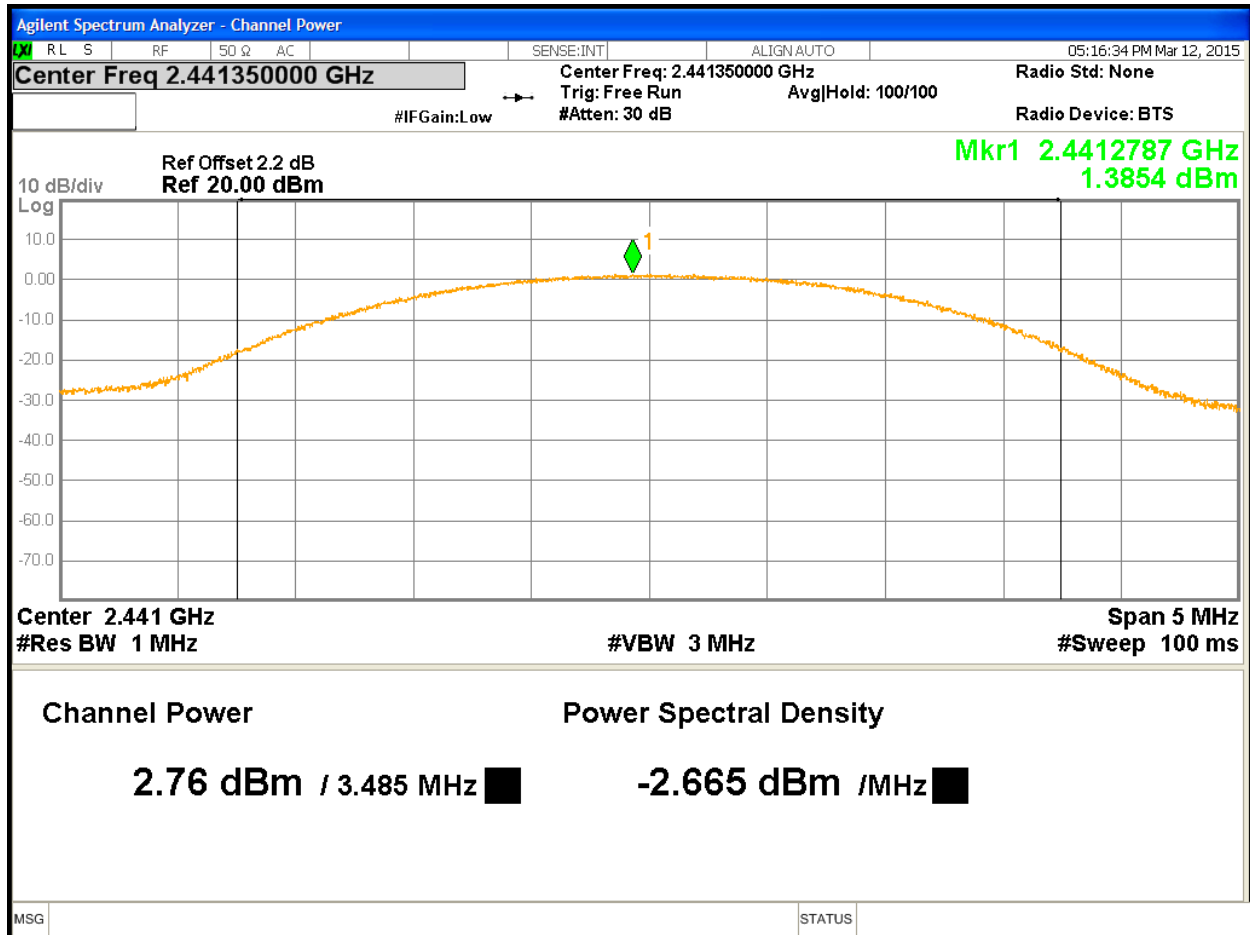

Figure 2: Maximum Conducted Output Power at 2441.35MHz - Headset

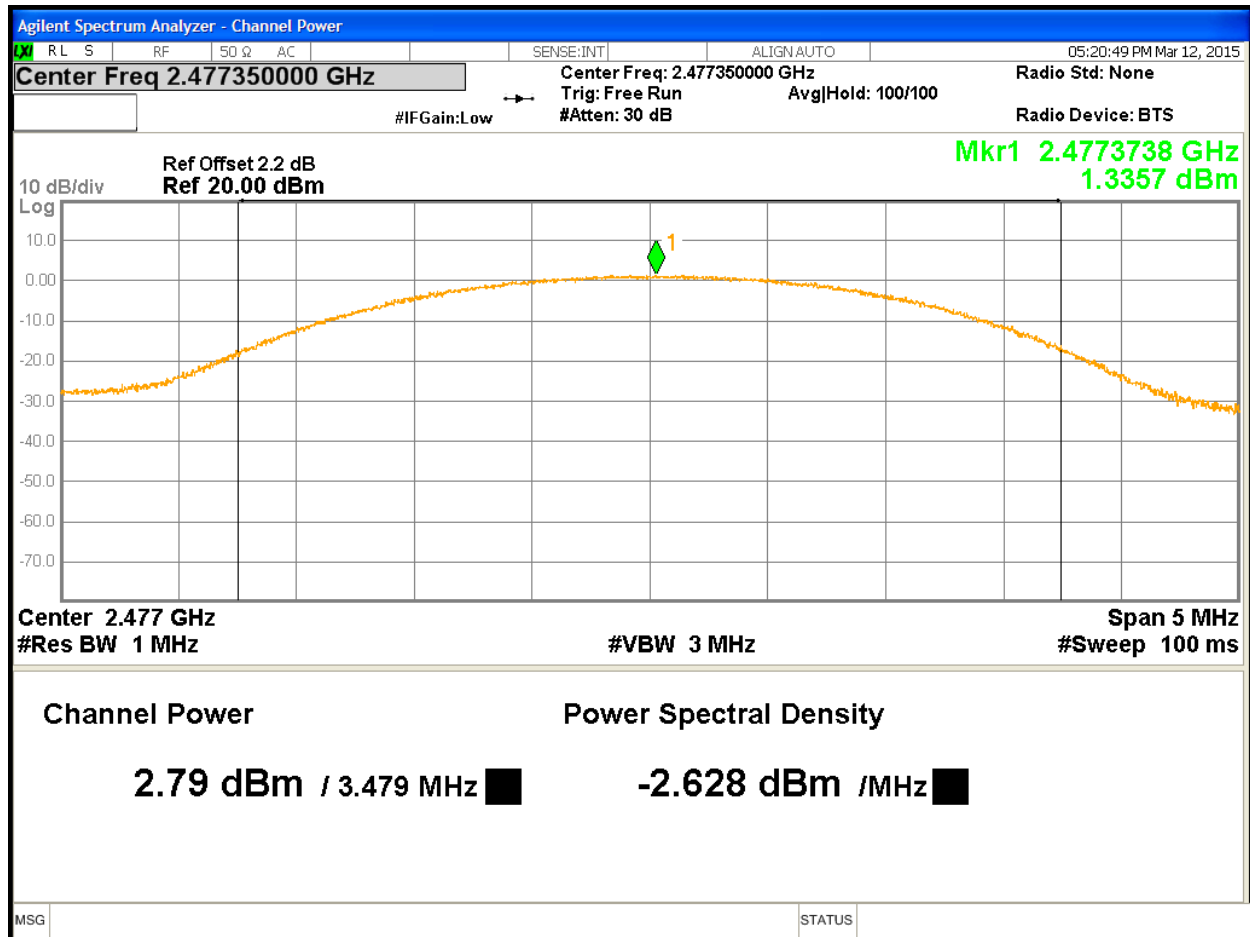

Figure 3: Maximum Conducted Output Power at 2477.35MHz - Headset

4.2 Occupied Bandwidth

The occupied bandwidth is measured at an amplitude level reduced from the reference level by a specified ratio. The reference level is the level of the highest amplitude signal observed from the transmitter at the fundamental frequency.

The 99% bandwidth is the bandwidth in which 99% of the transmitted power occupied.

The 6dB bandwidth is defined the bandwidth of 6dB from highest transmitted level of the fundamental frequency.

The bandwidth shall be at least 500 kHz per Section CFR47 15.247(a2) 2015 and RSS Gen Sect. 4.4.1: 2010.

4.2.1 Test Method

The conducted method was used to measure the occupied bandwidth according to ANSI C63.10:2009 Section 6.9.1. The measurement was performed with modulation per CFR47 15.247(a2) 2015 and RSS Gen Sect. 4.4.1:2010. This test was conducted on 3 channels in each mode of Sample S/N PP #1. The worst sample result indicated below.

Test Setup:

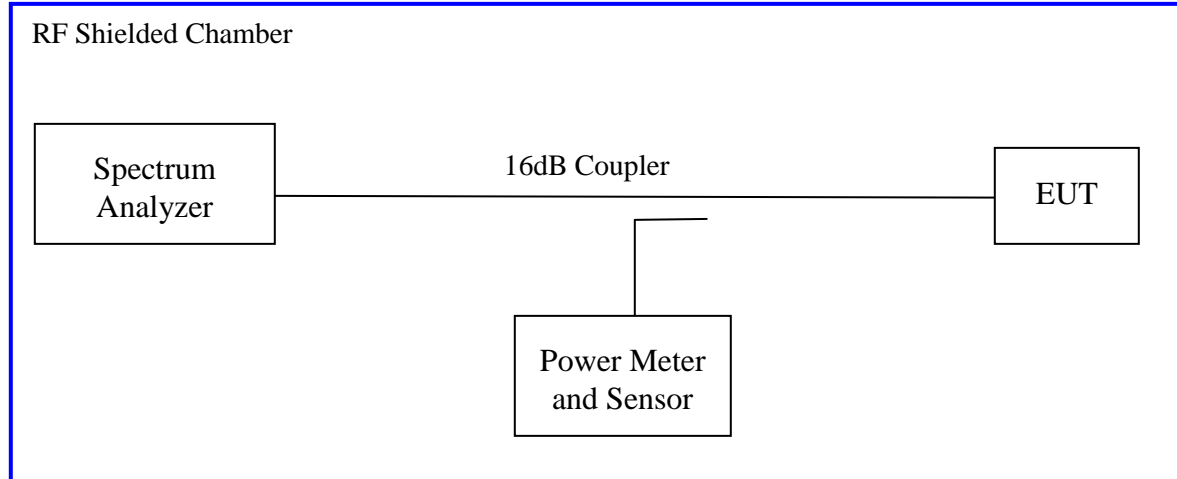

4.2.2 Results

As originally tested, the EUT was found to be compliant to the requirements of the test standard(s).

Table 4: Occupied Bandwidth – Test Results

Test Conditions: Conducted Measurement		Date: March 12, 2015		
Antenna Type: Integrated		Power Setting: 0 dBm		
Antenna Gain: +2.0 dBi		Signal State: Modulated at 100%		
Ambient Temp.: 23 °C		Relative Humidity: 31%		
Bandwidth (MHz) for Wireless Audio Headset				
Frequency (MHz)	Limit (kHz)	99% Bandwidth	6 dB Bandwidth	Results
2403.35	500	1.904	1.653	Pass
2441.35	500	1.904	1.604	Pass
2477.35	500	1.907	1.657	Pass
Note: The bandwidth was measured at 100% duty cycle				

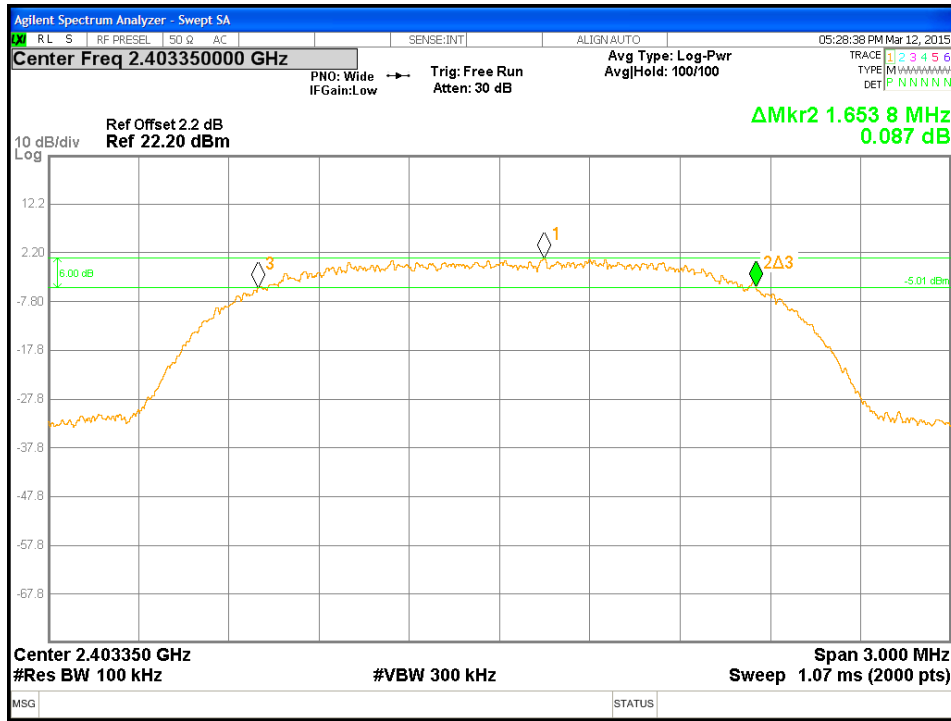

Figure 4: DTS Bandwidth-Headset -2403.35MHz



Figure 5: DTS Bandwidth-Headset -2441.35MHz

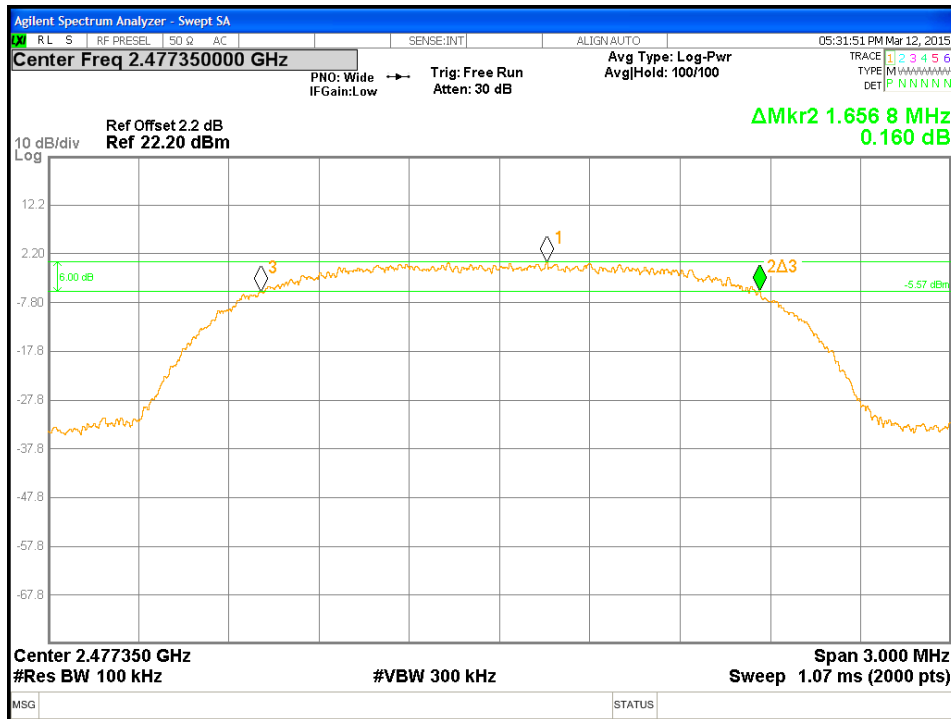

Figure 6: DTS Bandwidth-Headset -2477.35MHz

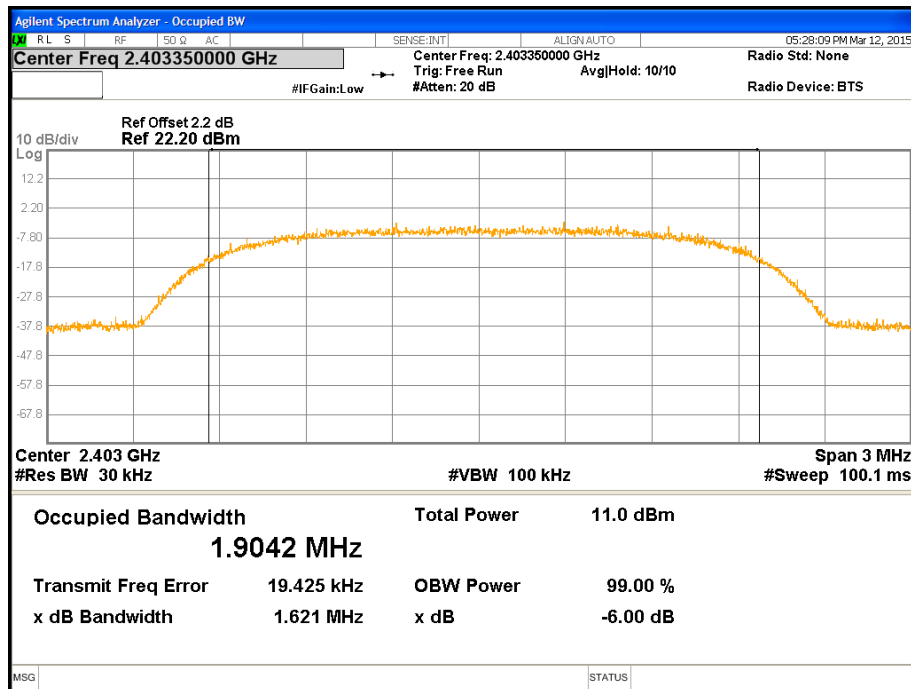

Figure 7: 99% Bandwidth-Headset -2403.35MHz

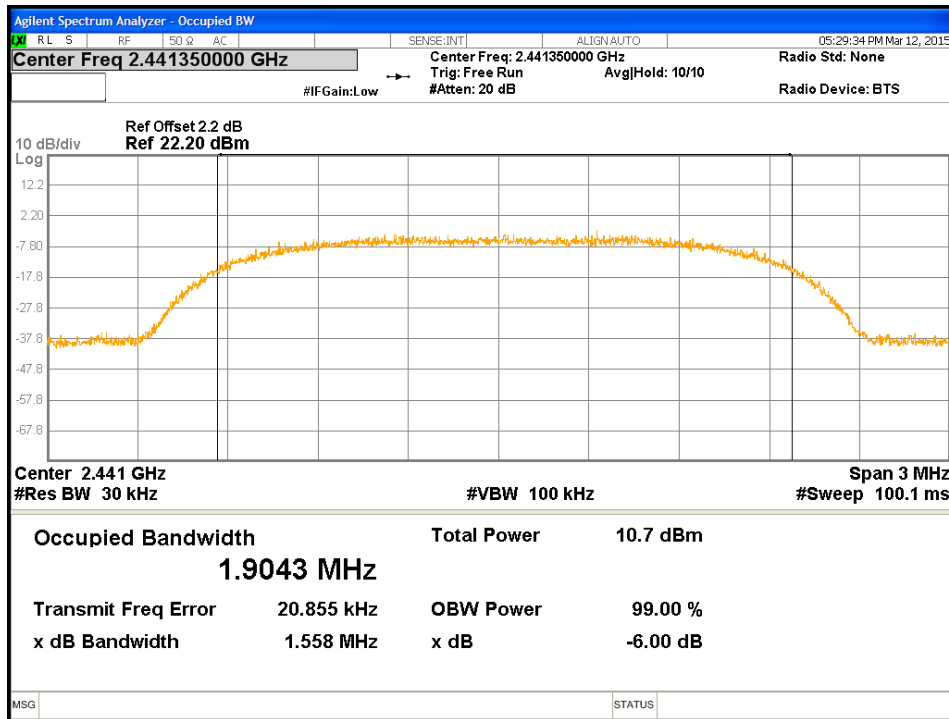

Figure 8: 99% Bandwidth-Headset -2441.35MHz

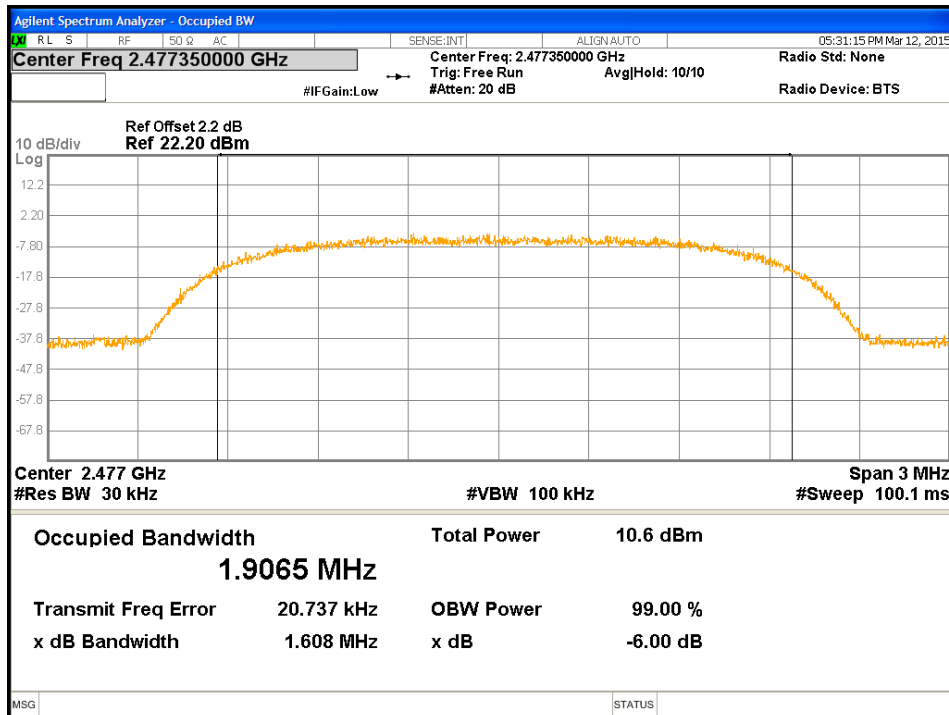

Figure 9: 99% Bandwidth-Headset -2477.35MHz

4.3 Out-of-Band Emissions

The setup was identical to RF output power measurement. Intentional radiators operating under the alternative provisions to the general emission limits, must be designed to ensure that the 20 dB or 30 dB bandwidth of the emission, or whatever bandwidth may otherwise be specified in the specific rule section under which the equipment operates, is contained within the frequency band designated in the rule section under which the equipment is operated. The requirement to contain the designated bandwidth of the emission within the specified frequency band includes the effects from frequency sweeping, frequency hopping and other modulation techniques that may be employed as well as the frequency stability of the transmitter over expected variations in temperature and supply voltage. If the frequency stability is not specified in the regulations, it is recommended that the fundamental emission be kept within at least the central 80% of the permitted band in order to minimize the possibility of out-of-band operation.

Since the transmitter complies with the conducted power limits base on the use of RMS averaging per CFR47 Part 15.247(b)(3), any frequency outside the band of 2400MHz to 2483.5MHz, the power output level must be below 30db from the in-band transmitting signal; CFR 47 Part 15.215, 15.247(d) and RSS-210 A8.5

4.3.1 Test Method

The conducted method was used to measure the out-of-band emission requirement. The measurement was performed with modulation per CFR47 15.247(4) (d) 2015 and RSS-210 A8.5: 2010. This test was conducted on 3 channels of Sample S/N PP #1. The worst sample result indicated below.

Test Setup:

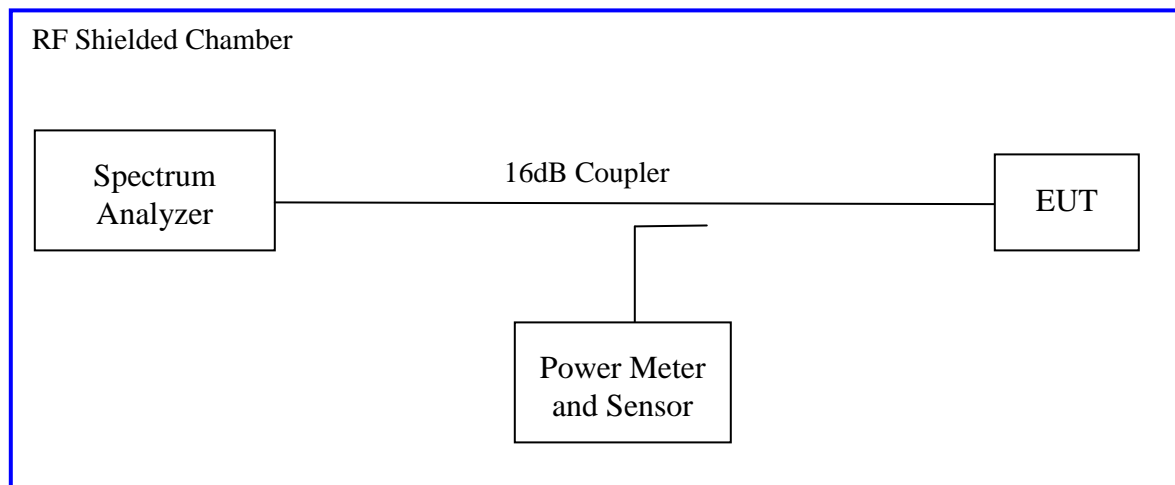

4.3.2 Test Result

As originally tested, the EUT was found to be compliant to the requirements of the test standard(s).

Table 5: Out of Band Emissions – Test Results

Test Conditions: Conducted Measurement		Date: March 12, 2015	
Antenna Type: Integrated		Power Setting: See test plan	
Antenna Gain: +2.0 dBi		Signal State: Modulated at 100%	
Ambient Temp.: 23 °C		Relative Humidity: 31%	
Out of Band Results for Wireless Audio Headset			
Operating Channel	Out of Band Level (dBm)	30 dBr Level (dBm)	Margin (dB)
2403.35 MHz	-42.77	-28.79	-13.98
2441.35 MHz	-43.67	-28.96	-14.71
2477.35 MHz	-44.05	-28.80	-15.25
<p>Note: The band-edge level must lower than the 30dBr level. The maximum out of band emission on each individual output put is at least 30 dB below the maximum in-band PSD on that output. (*) The band-edge is compared to the highest -30dBr level of the test mode.</p>			

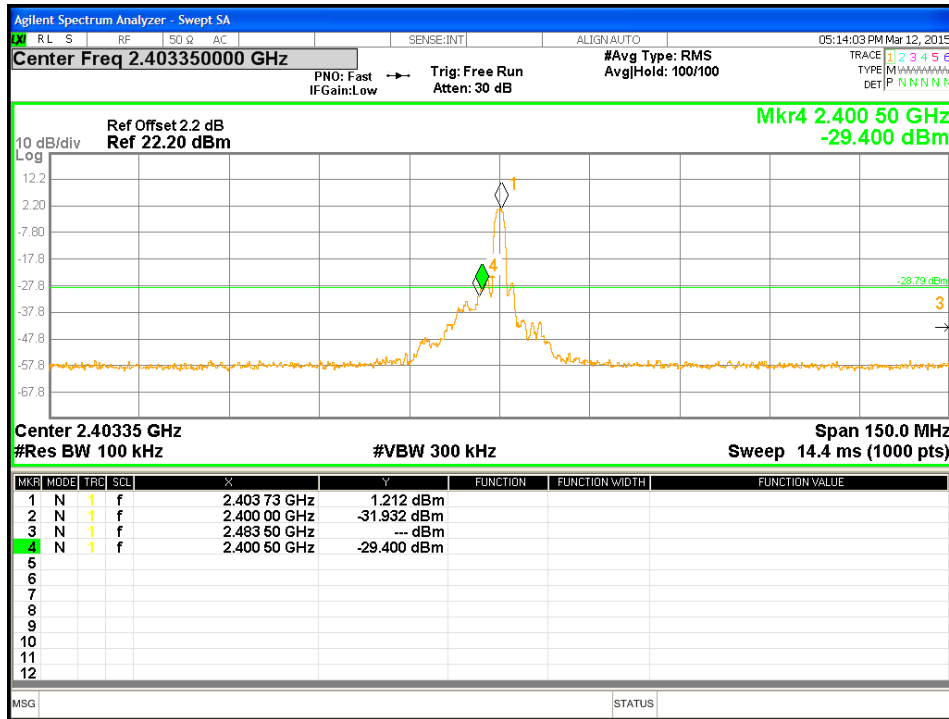

Figure 10: Conducted Band Edge at 2403.35MHz-Headset

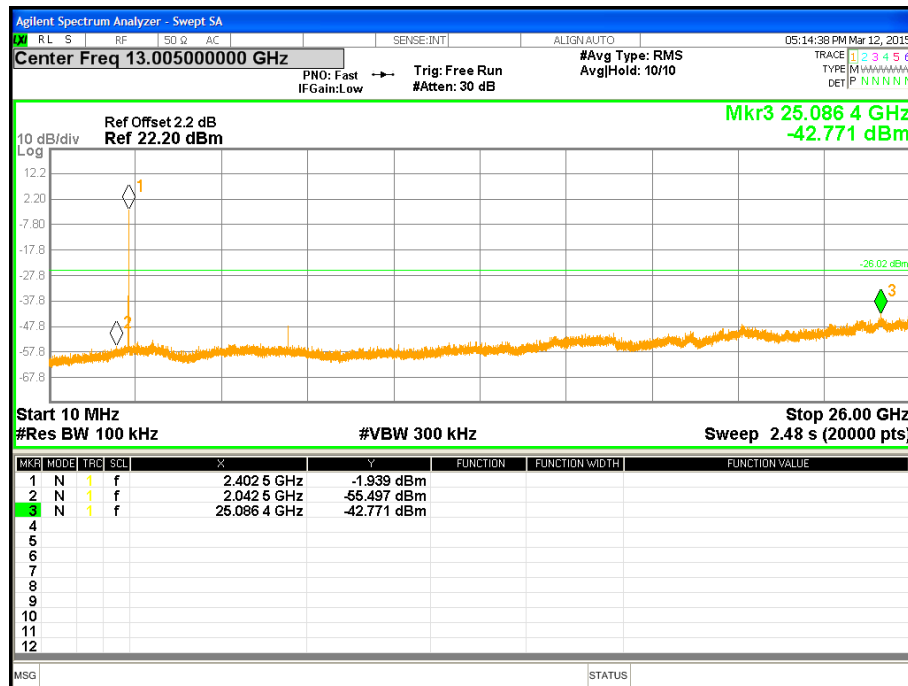

Figure 11: Out of band Emission-2403.35MHz-Headset

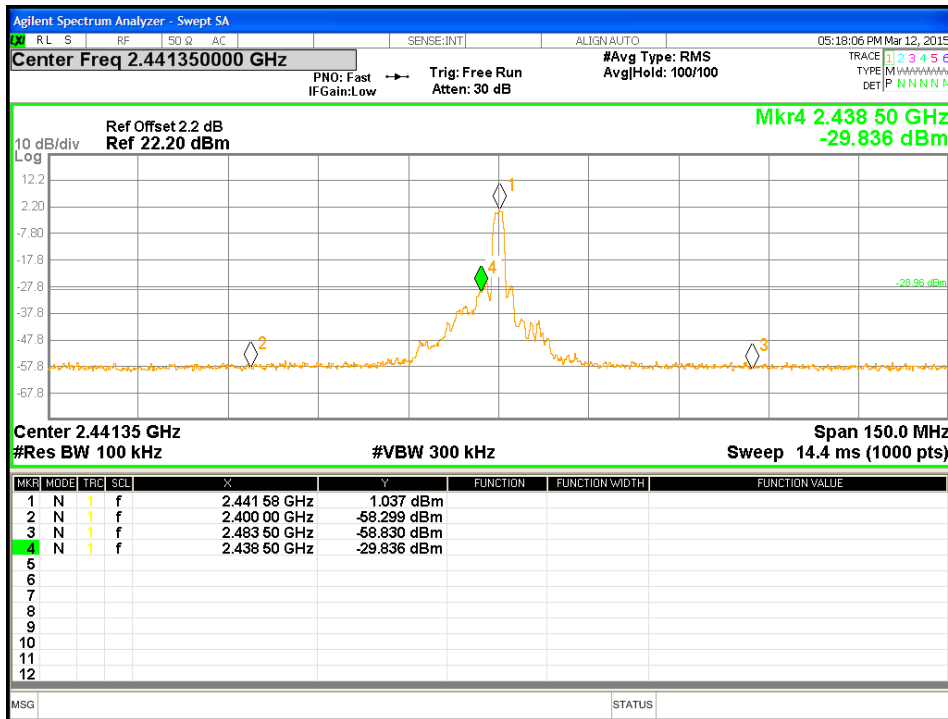

Figure 12: Conducted Band Edge-2441.35MHz-Headset

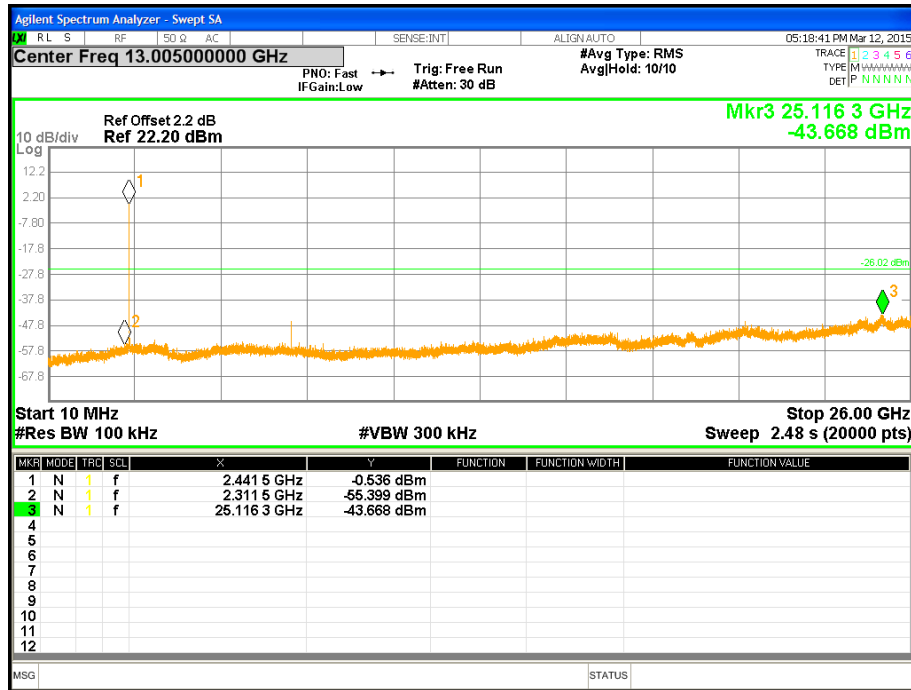

Figure 13: Out of band Emission-2441.35MHz-Headset

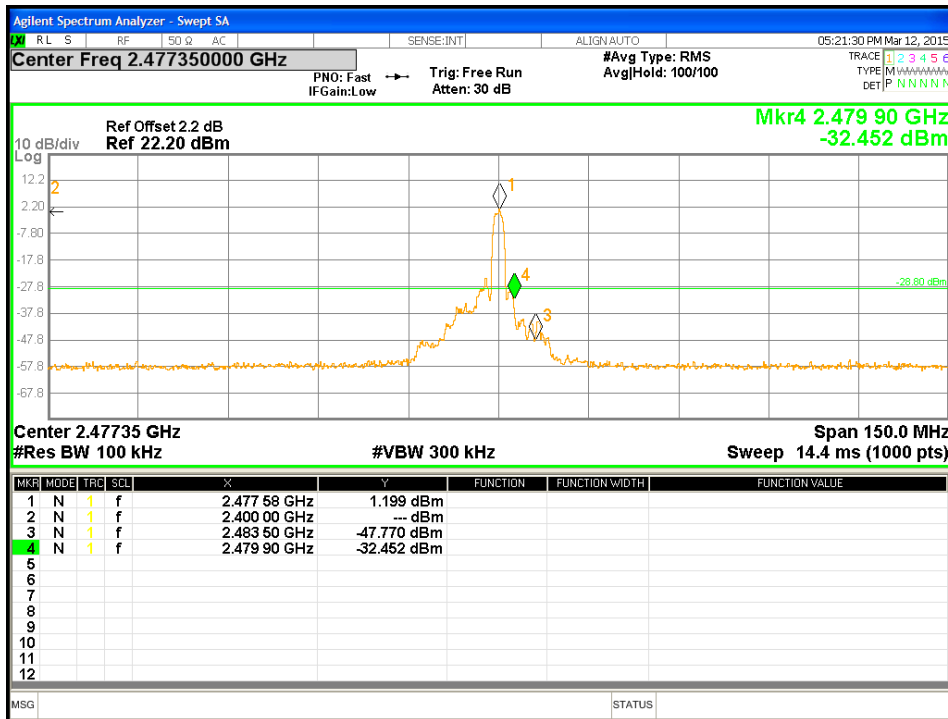

Figure 14: Conducted Band Edge-2477.35MHz-Headset

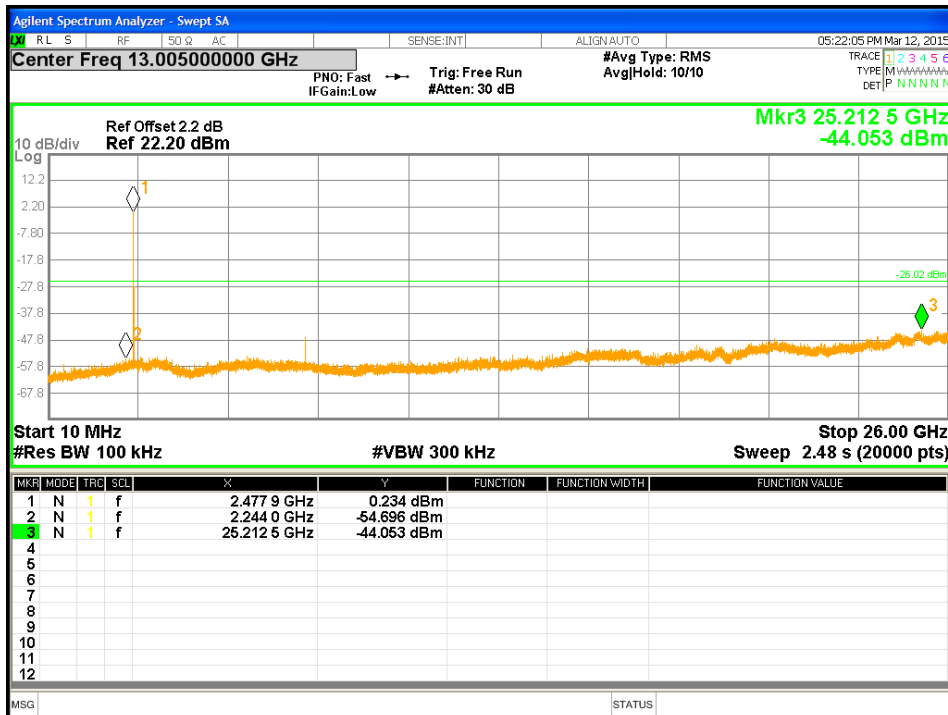

Figure 15: Out of band Emission-2477.35MHz-Headset

4.4 Peak Power Spectral Density

According to the CFR47 Part 15.247 (e) and RSS-210 (A8.2), the spectral power density output of the antenna port shall be less than 8dBm in any 3kHz band during any time interval of continuous transmission.

4.4.1 Test Method

The conducted method was used to measure the channel power output per ANSI C63.10:2009 Section 6.11.2. The measurement was performed with modulation per CFR47 Part 15.247 (e) and RSS-210 (A8.2). This test was conducted on 3 channels of Sample SN PP #1. The worst sample result indicated below.

Test Setup:

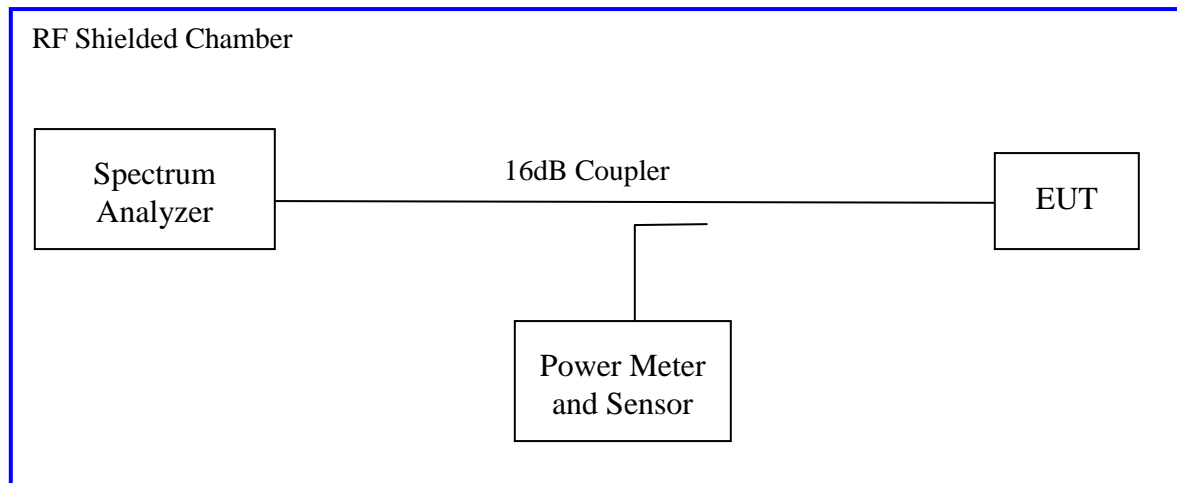

4.4.2 Results

As originally tested, the EUT was found to be compliant to the requirements of the test standard(s).

Table 6: Peak Power Spectral Density – Test Results

Test Conditions: Conducted Measurement				Date: March 12, 2015		
Antenna Type: Integrated				Power Setting: See test plan		
Antenna Gain: +2.0 dBi				Signal State: Modulated at 100%		
Ambient Temp.: 23 °C				Relative Humidity: 31%		
Peak Power Spectral Density						
Freq. (MHz)	Config.	Output [dBm]	CF [dB]	Max. PPSD [dBm]	Limit [dBm]	Margin [dB]
2403.35	Headset	-7.23	-15.23	-22.46	8.00	-30.46
2441.35	Headset	-7.35	-15.23	-22.58	8.00	-30.58
2477.35	Headset	-7.54	-15.23	-22.77	8.00	-30.77
Note: CF was accounted for the measured RBW. The bandwidth ratio is $10 \cdot \log(3\text{kHz}/100\text{kHz})$ or -15.23 dB. Headset transmitted at 100% duty cycle.						

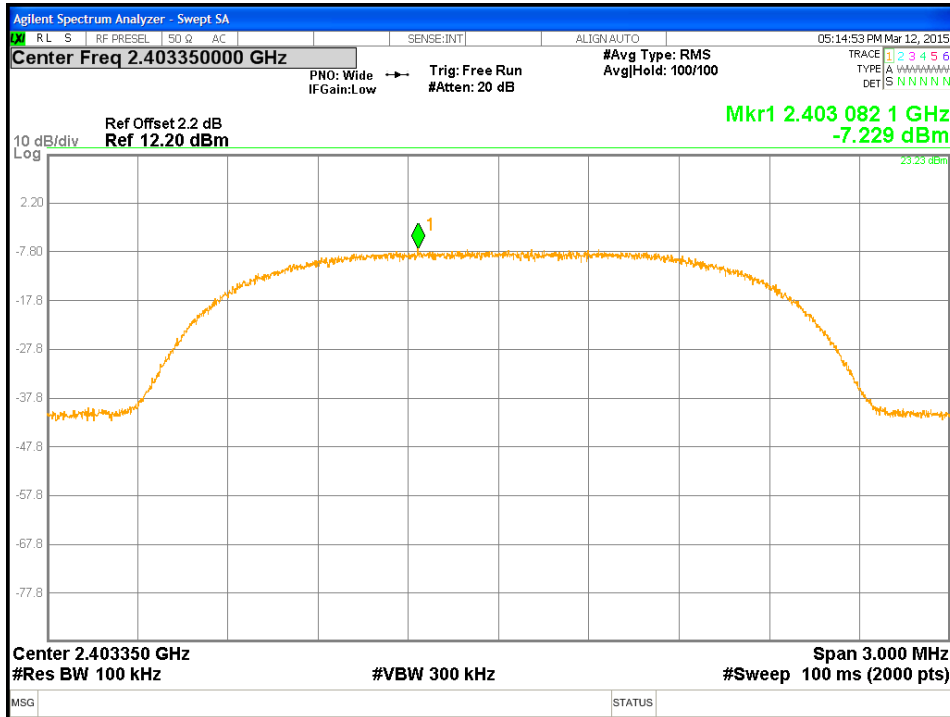

Figure 16: Maximum Power Spectral Density-2403.35MHz-Headset

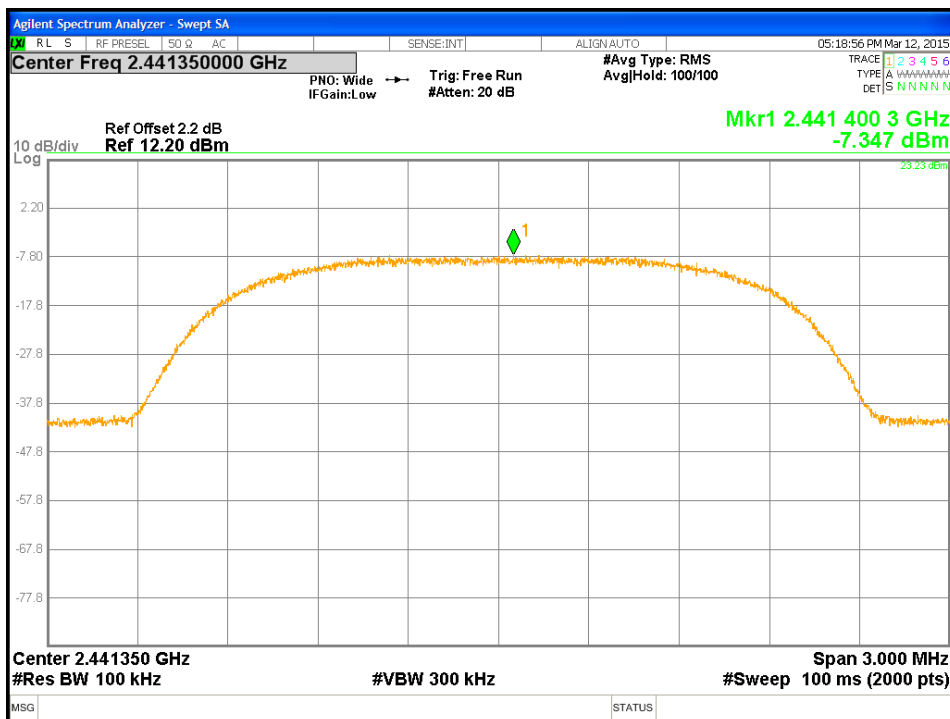

Figure 17: Maximum Power Spectral Density-2441.35MHz-Headset

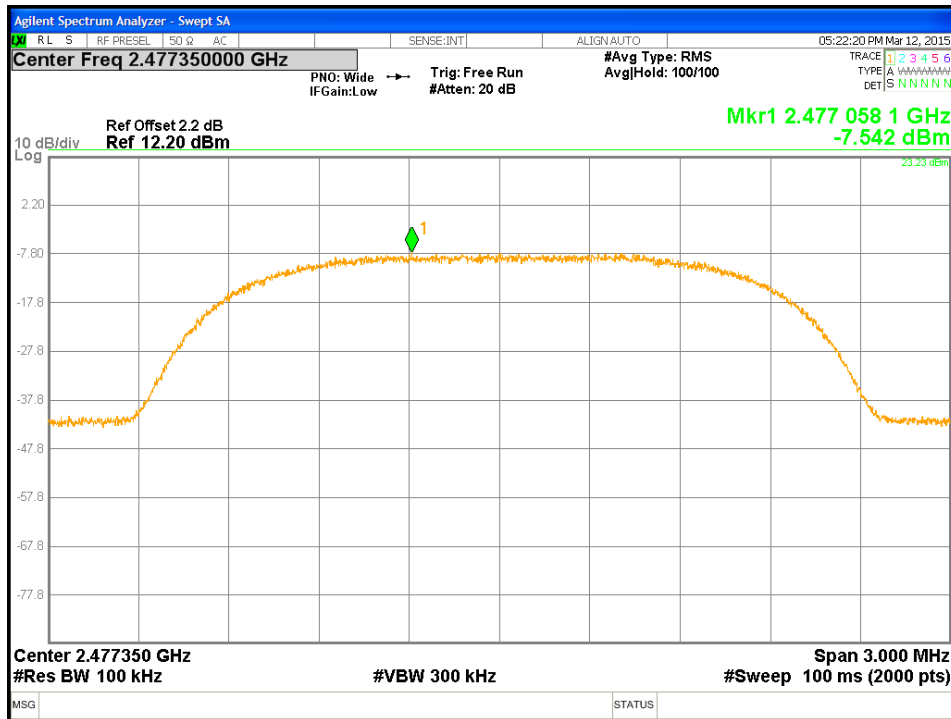

Figure 18: Maximum Power Spectral Density-2477.35MHz-Headset

4.5 Maximum Permissible Exposure

4.5.1 Test Methodology

In this section, we try to prove the safety of radiation harmfulness to the human body for our product. The KDB 447498 D01 General RF Exposure Guidance is followed. The Gain of the antenna used in this calculation is declared by the manufacturer, and the maximum average power input to the antenna is measured. Using the general SAR test exclusion guidance in Section 4.3 of KDB 447498, we show the device meeting the SAR exclusion threshold.

4.5.2 FCC KDB 447498 D01 – General SAR Test Exclusion Guidance

The SAR exclusion threshold conditions are listed:

- 1) The 1-g and 10-g SAR test exclusion thresholds for 100 MHz to 6 GHz at test separation distances ≤ 50 mm are determined by:
[(max. power of channel, including tune-up tolerance, mW)/(min. test separation distance, mm)] · $[\sqrt{f(\text{GHz})}] \leq 3.0$ for 1-g SAR and ≤ 7.5 for 10-g extremity SAR,16 where
 - f(GHz) is the RF channel transmit frequency in GHz
 - Power and distance are rounded to the nearest mW and mm before calculation17
 - The result is rounded to one decimal place for comparison

The test exclusions are applicable only when the minimum test separation distance is ≤ 50 mm and for transmission frequencies between 100 MHz and 6 GHz. When the minimum test separation distance is < 5 mm, a distance of 5 mm is applied to determine SAR test exclusion.

- 2) At 100 MHz to 6 GHz and for test separation distances > 50 mm, the SAR test exclusion threshold is determined according to the following, and as illustrated in Appendix B:18
 - a) [Threshold at 50 mm in step 1) + (test separation distance - 50 mm) · (f(MHz)/150)] mW, at 100 MHz to 1500 MHz
 - b) [Threshold at 50 mm in step 1) + (test separation distance - 50 mm) · 10] mW at > 1500 MHz and ≤ 6 GHz
- 3) At frequencies below 100 MHz, the following may be considered for SAR test exclusion, and as illustrated in Appendix C:19
 - a) The threshold at the corresponding test separation distance at 100 MHz in step 2) is multiplied by $[1 + \log(100/f(\text{MHz}))]$ for test separation distances > 50 mm and < 200 mm
 - b) The threshold determined by the equation in a) for 50 mm and 100 MHz is multiplied by $\frac{1}{2}$ for test separation distances ≤ 50 mm
 - c) SAR measurement procedures are not established below 100 MHz. When SAR test exclusion cannot be applied, a KDB inquiry is required to determine SAR evaluation requirements for any test results to be acceptable.

4.5.3 EUT Operating Condition

The software provided by Manufacturer enabled the EUT to transmit data at lowest, middle and highest channel individually.

4.5.4 Classification

The antenna of the product, under normal use condition, is less than 2cm away from the body of the user. This device is classified as a **Portable Device**. It is intended to be used with head wear device; extremity SAR limit is applied.

4.5.5 SAR Test Exclusion Threshold

4.5.5.1 Antenna Gain

The transmitting antenna was integrated. The omni-directional antenna gain was 2.0 dBi.

4.5.5.2 SAR Exclusion Threshold Calculation

Mode	Max. Power (dBm)	EIRP (dBm)	Min. Separation Distance (mm)	Cal. Excl. Threshold	1-g SAR Limit	10-g extremity SAR Limit	Result
Modulated	3.00	5.00	5	0.996695	<3.0	<7.5	Exempted *

Note:

1. Since EUT can operate at distance less than 50 mm, the minimum distance, 5 mm, was used for calculation per condition #1 of SAR Exclusion Threshold.
2. The maximum output power was taken from Table 2.
3. (*) The calculated threshold is less than 3.0; therefore, EUT is SAR exempted for head and body usage.

4.6 Transmitter Spurious Emissions

Transmitter spurious emissions are emissions outside the frequency range of the equipment when the equipment is in transmitting mode; per requirement of CFR47 15.205, 15.209, 15.247(d), RSS-210 Sect. A.8.5

4.6.1 Test Methodology

4.6.1.1 Preliminary Test

A test program that controls instrumentation and data logging was used to automate the preliminary RF emission test procedure. The frequency range of interest was divided into sub-ranges to yield a frequency resolution of approximately 120 kHz and provide a reading at each frequency for no more than 12° of turntable rotation. For each frequency sub-range the turntable was rotated 360° while peak emission data was recorded and plotted over the frequency range of interest in horizontal and vertical antenna polarization's.

Preliminary emission profile testing was performed inside the anechoic chamber. The EUT was placed on a 1.0m x 1.5m non-conductive table 80cm above the floor. The EUT was positioned as shown in the setup photographs. The receiving antenna was placed at a distance of 3m at a fixed height of 1m. Measurement equipment was located outside of the chamber. A video camera was placed inside the chamber to view the EUT.

4.6.1.2 Final Test

For each frequency measured, the peak emission was maximized by manipulating the receiving antenna from 1 to 4 meters above the ground plane and placing it at the position that produced the maximum signal strength reading. The turntable was then rotated through 360° while observing the peak signal and placing the EUT at the position that produced maximum radiation. The six highest emissions relative to the limit were measured unless such emissions were more than 20 dB below the limit. If less than six emissions are within 20 dB of the limit, than the noise level of the receiver is measured at frequencies where emissions are expected. Multiples of all oscillator and microprocessor frequencies were also checked.

Final testing was performed on an NSA compliant test site. The EUT was placed on a 1.0m x 1.5m non-conductive table 80cm above the ground plane. The placement of EUT and cables were the same as for preliminary testing and is shown in the setup photographs.

The final scans performed on the worst axis, Y-Axis up, for three operating channels in each operating mode;

2403.35MHz, 2441.35MHz, and 2477.35MHz

4.6.1.3 Deviations

None.

4.6.2 Transmitter Spurious Emission Limit

The spurious emissions of the transmitter shall not exceed the values in CFR47 Part 15.205, 15.209: 2015 and RSS-210 A1.1.2 2010.

Frequency (MHz)	Field strength (microvolts/meter)	Measurement distance (meters)
0.009-0.490.....	2400/F(kHz)	300
0.490-1.705.....	24000/F(kHz)	30
1.705-30.0.....	30	30
30-88.....	100 **	3
88-216.....	150 **	3
216-960.....	200 **	3
Above 960.....	500	3

All harmonics and spurious emission which are outside of the restricted band shall be 20dB below the in-band emission.

4.6.3 Test Results

The final measurement data was taken under the worst case operating modes, configurations, and/or cable positions. It also reflects the results including any modifications and/or special accessories listed in Sections 1.4 and Test Plan.

As originally tested, the EUT was found to be compliant to the requirements of the test standard(s).

Table 7: Transmit Spurious Emission at Band-Edge Requirements

Test Conditions: Radiated Measurement, Normal Temperature and Voltage only									
Antenna Type: Integrated					Power Setting: 0 dBm				
Max. Antenna Gain: +2.0 dBi					Signal State: Modulated at 100%				
Ambient Temp.: 23 °C					Relative Humidity: 31%				
Band-Edge Results									
Center Freq.	Mode	Edge Freq.	Pol.	Ant.	Table	Det.	Level	Limit	Margin
MHz		MHz	V/H	cm	Deg.	Pk/Avg	dBuV/m	dBuV/m	dB
2403.35	Headset – Up Right	2390.00	V	247	47	Pk	59.70	74.00	-14.30
2403.35	Headset – Up Right	2390.00	V	247	47	Ave	39.60	54.00	-14.40
2403.35	Headset – Up Right	2390.00	H	214	288	Pk	58.33	74.00	-15.67
2403.35	Headset – Up Right	2390.00	H	214	288	Ave	41.06	54.00	-12.94
2477.35	Headset – Up Right	2483.50	H	308	323	Pk	60.30	74.00	-13.70
2477.35	Headset – Up Right	2483.50	H	308	323	Ave	48.88	54.00	-5.12
2477.35	Headset – Up Right	2483.50	V	158	16	Pk	60.82	74.00	-13.18
2477.35	Headset – Up Right	2483.50	V	158	16	Ave	48.03	54.00	-5.97
Note: The emissions were measured at the adjacent restricted band of the fundamental signal.									

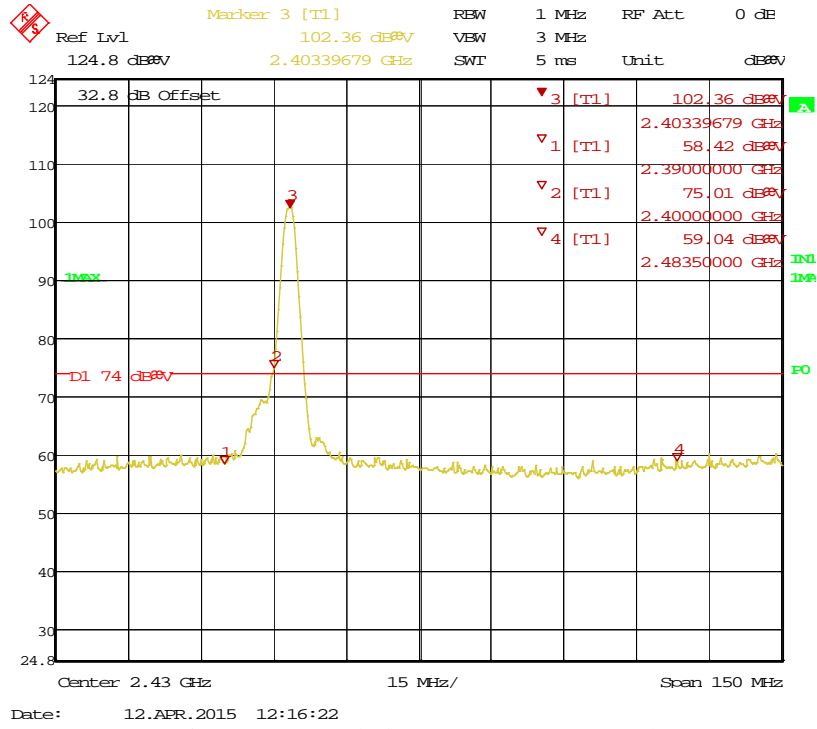

Figure 19: Bandedge-2403.35 MHz-H-Pk

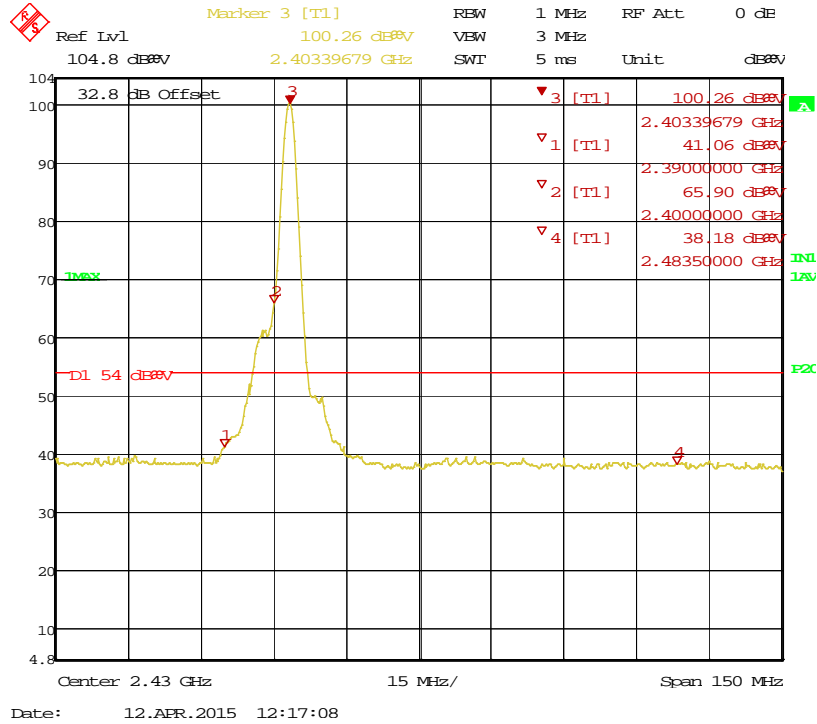

Figure 20: Bandedge-2403.35 MHz-H-Ave

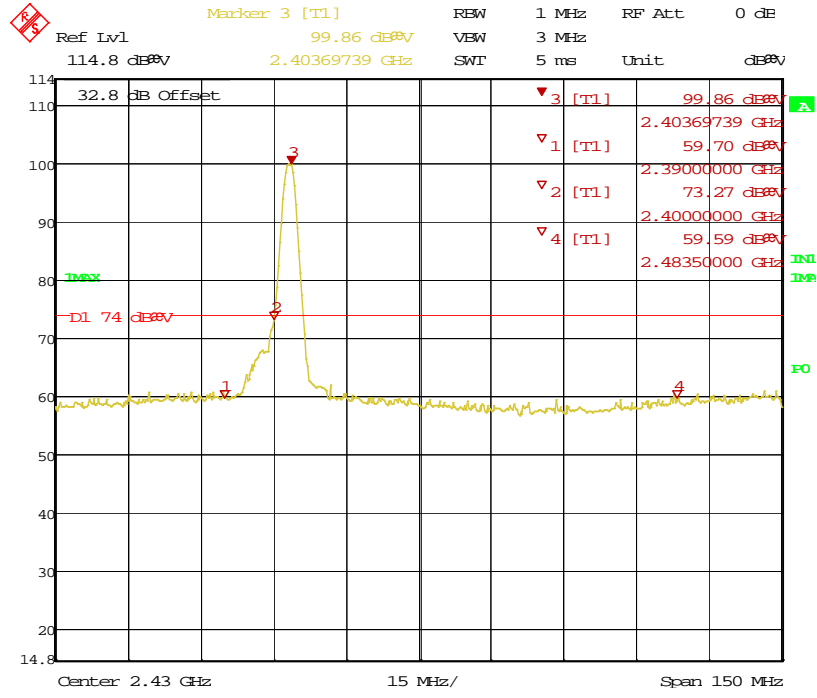

Figure 21: Bandedge-2403.35 MHz-V-pk

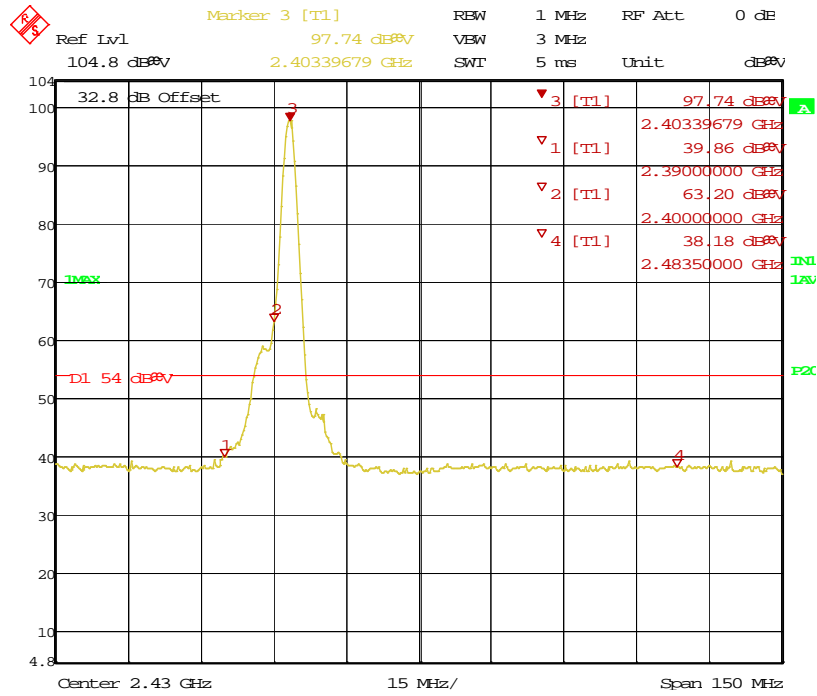

Figure 22: Bandedge-2403.35 MHz-V-Ave

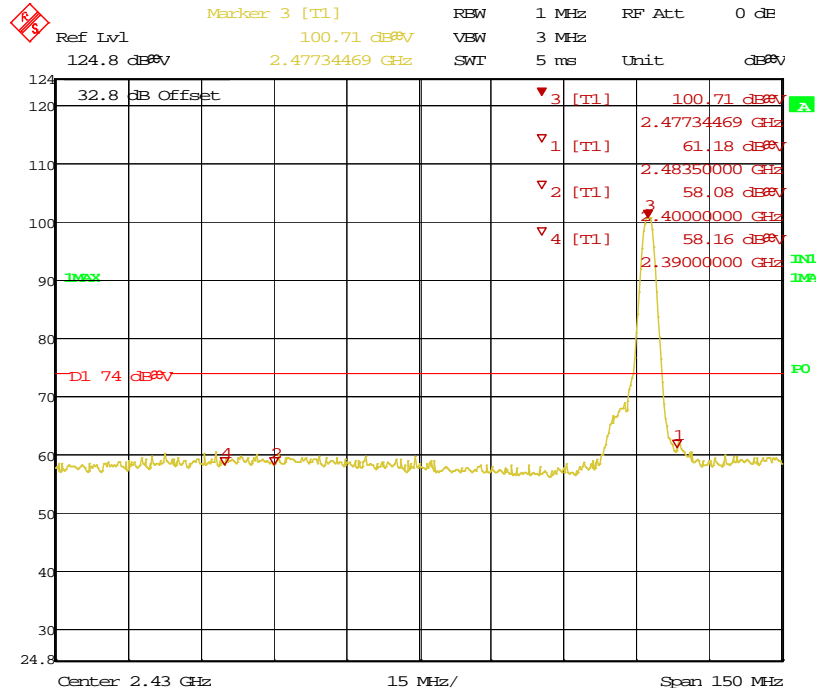

Figure 23: Bandedge-2477.35 MHz-H-Pk

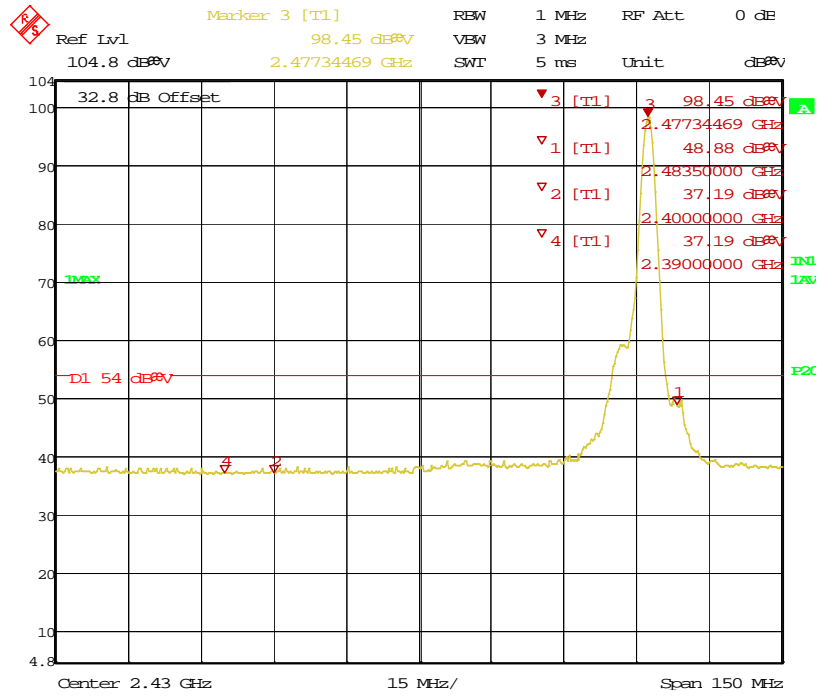

Figure 24: Bandedge-2477.35 MHz-H-Ave

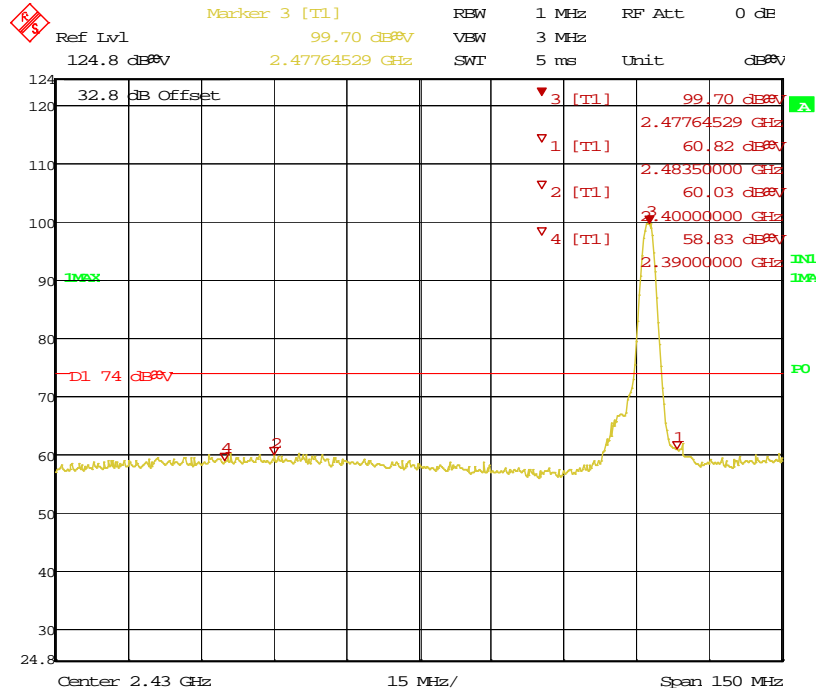

Figure 25: Bandedge-2477.35 MHz-V-Pk

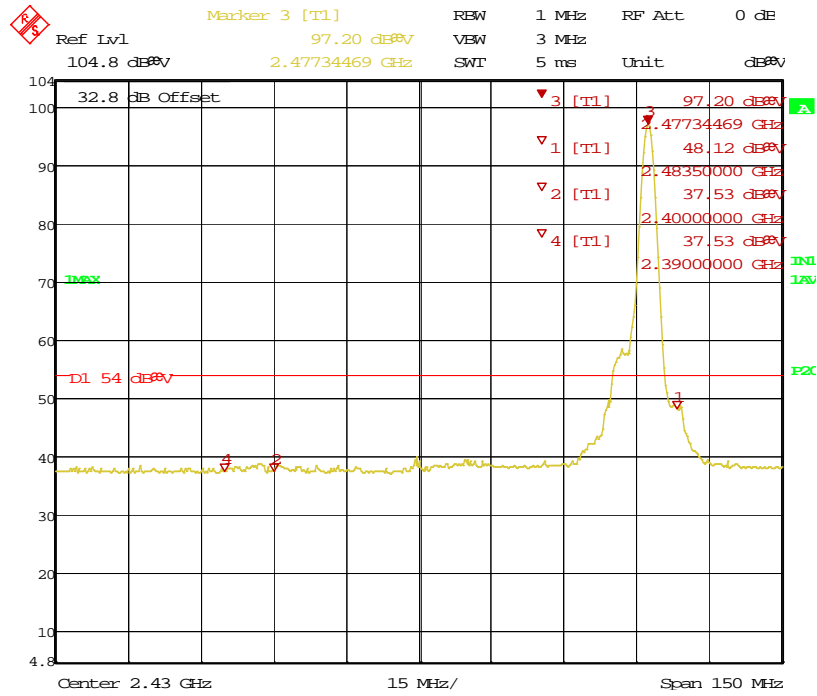

Figure 26: Bandedge-2477.35 MHz-V-Ave

SOP 1 Radiated Emissions												Tracking # 31560647.001 Page 1 of 6	
EUT Name		Wireless Audio Headset						Date		July 7, 2014			
EUT Model		Ear Force Stealth 420X RX						Temp / Hum in		23°C / 33%rh			
EUT Serial		PP #2						Temp / Hum out		N/A			
EUT Config.		Headset up right						Line AC / Freq		3.7 VDC			
Standard		CFR47 Part 15 Subpart C						RBW / VBW		120 kHz/ 300 kHz			
Dist/Ant Used		3m / JB3						Performed by		Jeremy Luong			
Freq.	Raw	Cbl	AF	Level	Det.	Pol.	Hght.	Azt	Limit	Margin	Result		
MHz	dBuV/m	dB	dB	dBuV/m		H/V	cm	deg	dBuV/m	dB			
Transmitted Data at 2441.35MHz													
31.07	41.01	2.60	-11.64	31.97	QP	V	152	208	40.00	-8.03	Pass		
32.65	46.09	2.62	-12.87	35.84	QP	V	152	356	40.00	-4.16	Pass		
34.46	46.26	2.64	-14.20	34.69	QP	V	152	88	40.00	-5.31	Pass		
38.76	47.72	2.68	-17.51	32.88	QP	V	152	158	40.00	-7.12	Pass		
43.41	49.36	2.72	-20.72	31.37	QP	V	152	263	40.00	-8.64	Pass		
47.96	50.39	2.76	-23.19	29.95	QP	V	152	38	40.00	-10.05	Pass		
Spec Margin = Level - Limit, Level = Raw+ Cbl+ CF ± Uncertainty													
CF= Amp Gain + ANT Factor													
Combined Standard Uncertainty $u_c(y) = \pm 3.2$ dB Expanded Uncertainty $U = ku_c(y)$ $k = 2$ for 95% confidence													
Note: The worst case was observed at Channel 2441.35 MHz.													

SOP 1 Radiated Emissions											Tracking # 31560647.001 Page 2 of 6	
EUT Name		Wireless Audio Headset						Date		March 10, 2015		
EUT Model		Ear Force Stealth 420X RX						Temp / Hum in		23°C / 30%rh		
EUT Serial		PP #2						Temp / Hum out		N/A		
EUT Config.		Headset						Line AC / Freq		3.7 VDC		
Standard		CFR47 Part 15 Subpart C						RBW / VBW		1MHz / 3MHz		
Dist/Ant Used		3m / DRH-118, 1m / RA42-K-F-4B-C						Performed by		Jeremy Luong		
Freq	Raw	Cbl	AF	Level	Det	Pol	Hght	Azt	Limit	Margin	Comment	
MHz	dBuV/m	dB	dB	dBuV/m		H/V	cm	deg	dBuV/m	dB		
Transmitted Data at 2403.35MHz												
4804.04	49.87	1.87	-16.08	35.66	Ave	H	118	17	54.00	-18.34	Harmonics	
14346.59	39.64	3.28	-7.51	35.40	Ave	H	236	202	54.00	-18.60	Spurious	
7209.16	46.61	2.27	-11.68	37.20	Ave	V	156	104	54.00	-16.80	Harmonics	
9614.06	50.41	2.67	-7.89	45.18	Ave	V	181	120	54.00	-8.82	Harmonics	
17763.20	36.56	3.90	-0.28	40.18	Ave	V	208	236	54.00	-13.82	Spurious	
Transmitted Data at 2441.35MHz												
1859.47	43.56	1.07	-23.39	21.24	Ave	V	111	128	54.00	-32.76	Spurious	
4880.05	50.83	1.88	-15.86	36.85	Ave	V	131	141	54.00	-17.16	Harmonics	
Transmitted Data at 2477.35MHz												
1860.21	43.53	1.07	-23.39	21.22	Ave	V	127	330	54.00	-32.78	Spurious	
4952.03	54.73	1.87	-15.71	40.89	Ave	V	102	84	54.00	-13.11	Harmonics	
7432.74	43.93	2.31	-11.01	35.23	Ave	V	179	134	54.00	-18.77	Harmonics	
14482.58	39.47	3.39	-7.37	35.49	Ave	V	135	320	54.00	-18.51	Spurious	
17862.34	37.23	3.99	-0.58	40.64	Ave	V	209	38	54.00	-13.36	Spurious	
Spec Margin = Level - Limit, Level = Raw+ Cbl+ CF ± Uncertainty												
CF= Amp Gain + ANT Factor												
Combined Standard Uncertainty $u_c(y) = \pm 3.2\text{dB}$ Expanded Uncertainty $U = ku_c(y)$ $k = 2$ for 95% confidence												
Notes: All emissions passed the spurious emission limit.												

SOP 1 Radiated Emissions

Tracking # 31560647.001 Page 3 of 6

EUT Name	Wireless Audio Headset	Date	March 13, 2015
EUT Model	Ear Force Stealth 420X RX	Temp / Hum in	23°C / 33%rh
EUT Serial	PP #2	Temp / Hum out	N/A
EUT Config.	Headset	Line AC / Freq	3.7 VDC
Standard	CFR47 Part 15 Subpart C	RBW / VBW	120 kHz/ 300 kHz
Dist/Ant Used	3m / JB3	Date	Jeremy Luong

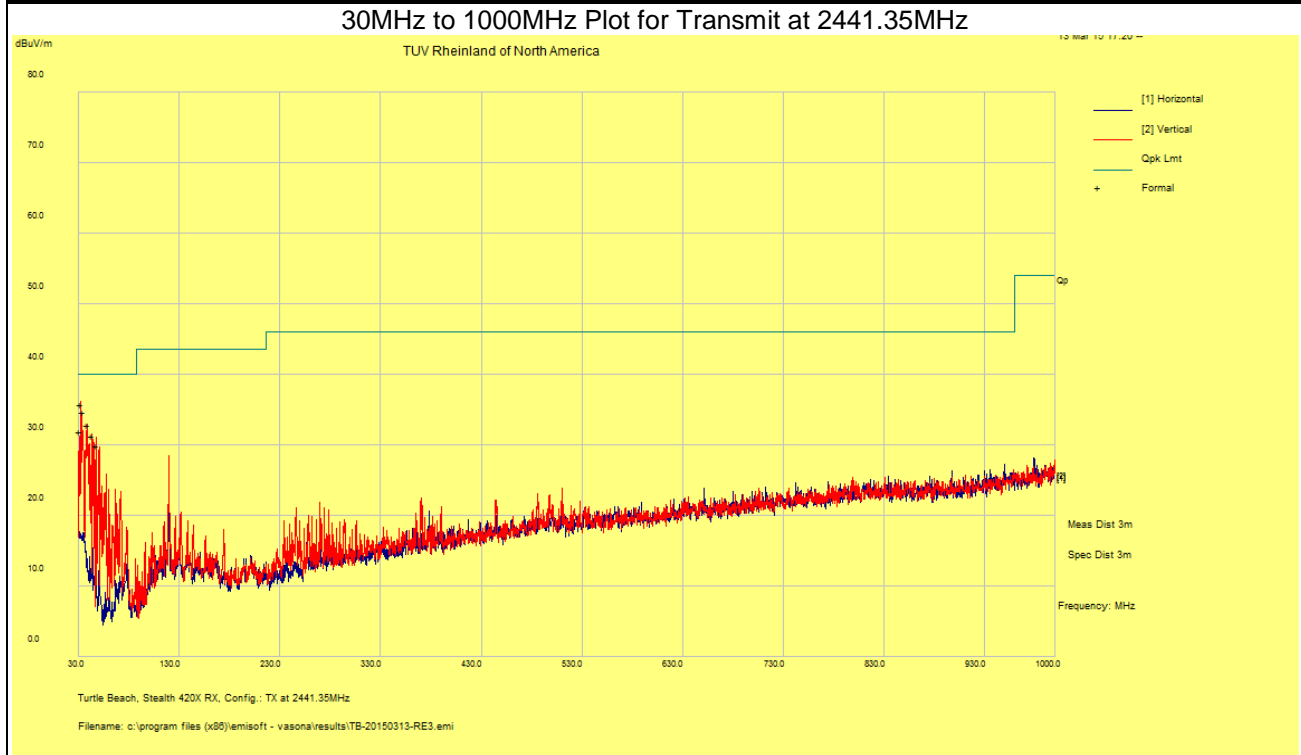

Notes: None.

SOP 1 Radiated Emissions

Tracking # 31560647.001 Page 4 of 6

EUT Name	Wireless Audio Headset	Date	March 10, 2015
EUT Model	Ear Force Stealth 420X RX	Temp / Hum in	23°C / 30%rh
EUT Serial	PP #2	Temp / Hum out	N/A
EUT Config.	Headset	Line AC / Freq	3.7 VDC
Standard	CFR47 Part 15 Subpart C	RBW / VBW	1MHz / 3MHz
Dist/Ant Used	3m / DRH-118, 1m / RA42-K-F-4B-C	Performed by	Jeremy Luong

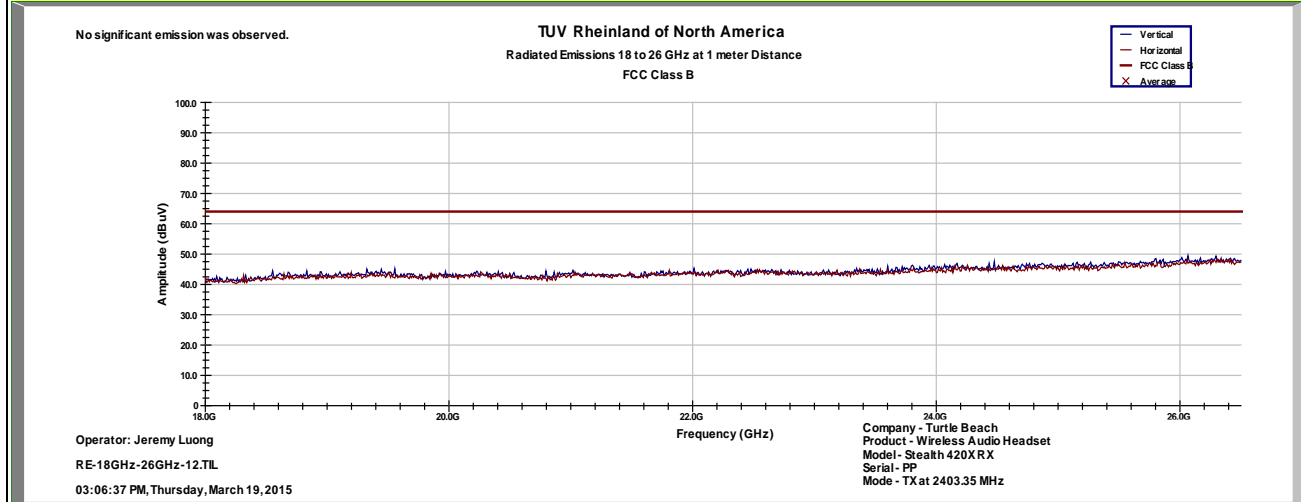
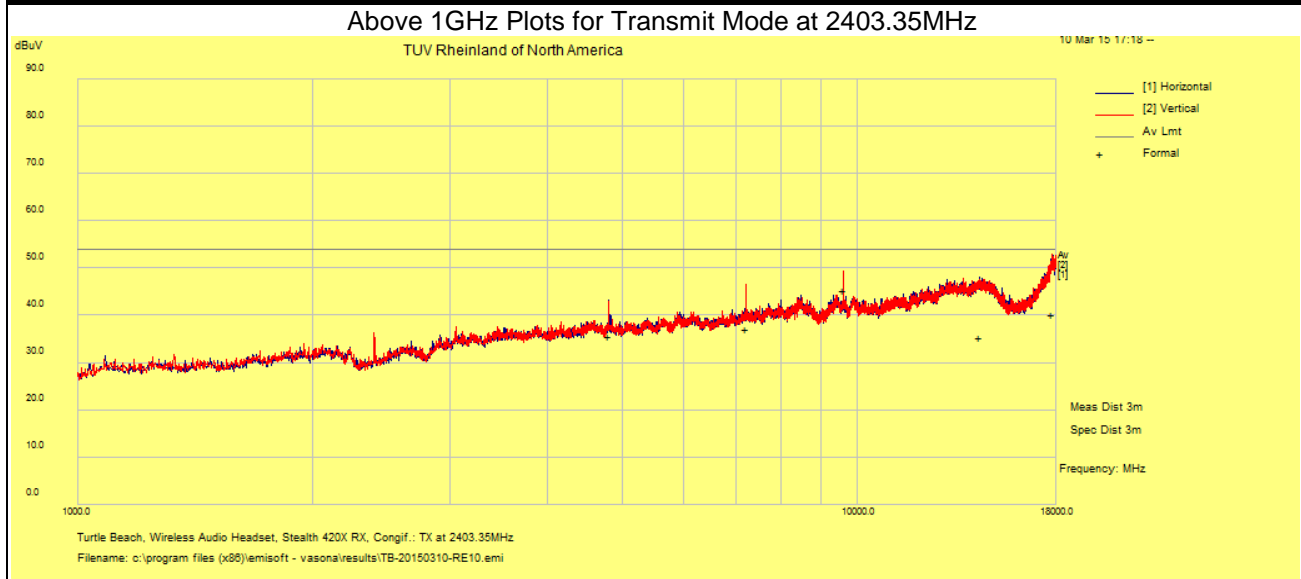

Notes: Limit was extrapolated to 1m distance for 18GHz – 26GHz range.
 1GHz – 25GHz Setting: RBW = 1MHz/ VBW = 3MHz

SOP 1 Radiated Emissions

Tracking # 31560647.001 Page 5 of 6

EUT Name	Wireless Audio Headset	Date	March 10, 2015
EUT Model	Ear Force Stealth 420X RX	Temp / Hum in	23°C / 30%rh
EUT Serial	PP #2	Temp / Hum out	N/A
EUT Config.	Headset	Line AC / Freq	3.7 VDC
Standard	CFR47 Part 15 Subpart C	RBW / VBW	1MHz / 3MHz
Dist/Ant Used	3m / DRH-118, 1m / RA42-K-F-4B-C	Performed by	Jeremy Luong

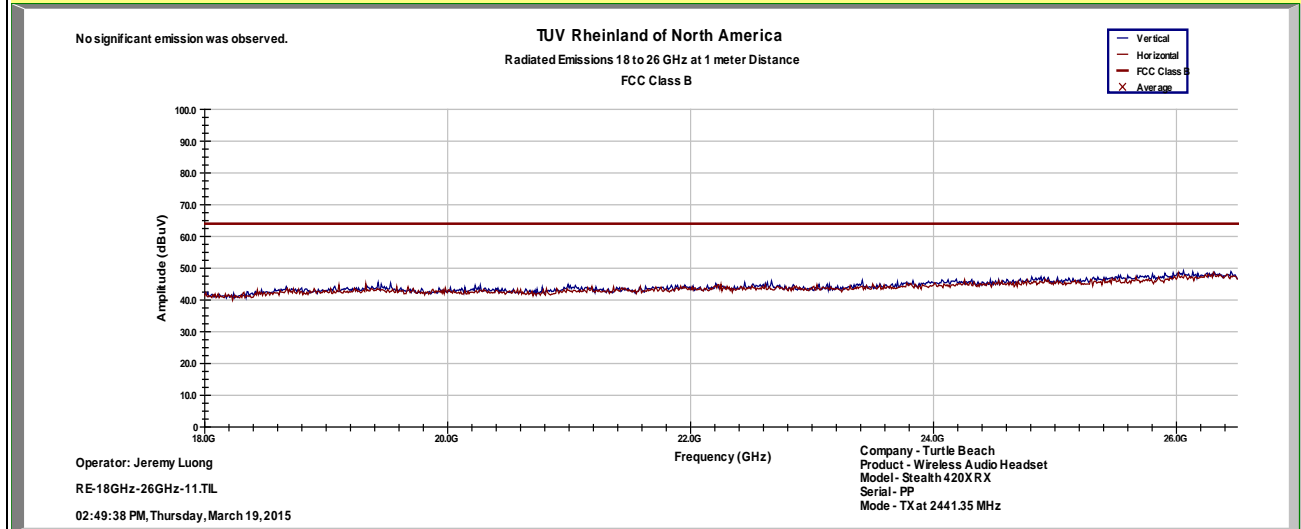
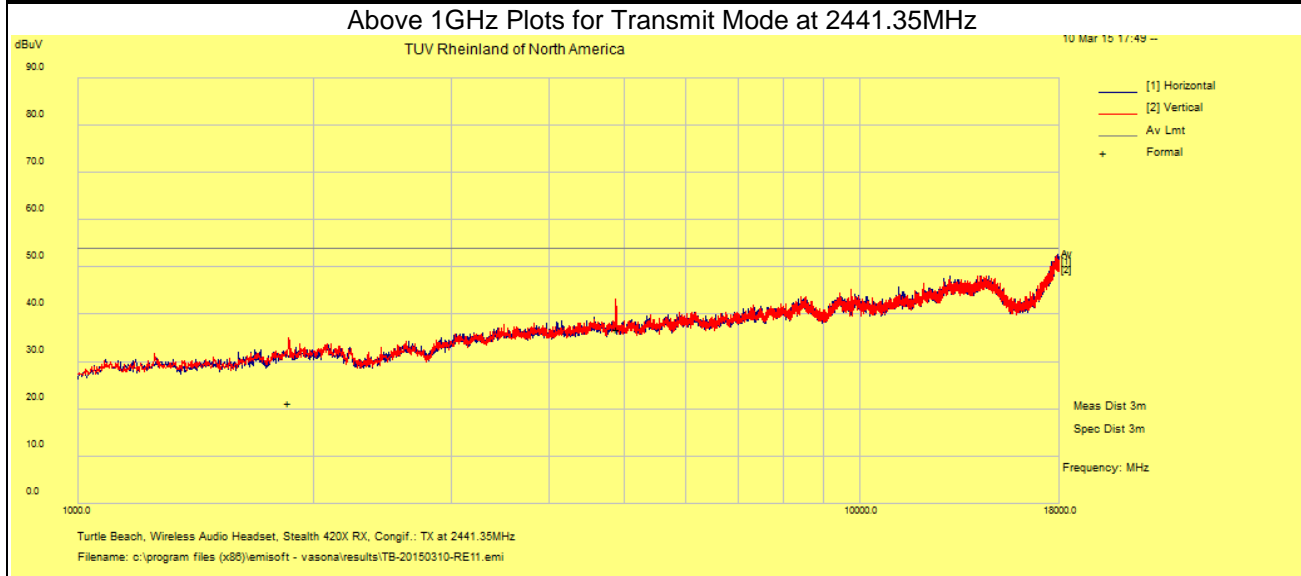

Notes: Limit was extrapolated to 1m distance for 18GHz – 25GHz range.
 1GHz – 25GHz Setting: RBW = 1MHz/ VBW = 3MHz.

SOP 1 Radiated Emissions

Tracking # 31560647.001 Page 6 of 6

EUT Name	Wireless Audio Headset	Date	March 10, 2015
EUT Model	Ear Force Stealth 420X RX	Temp / Hum in	23°C / 30%rh
EUT Serial	PP #2	Temp / Hum out	N/A
EUT Config.	Headset	Line AC / Freq	3.7 VDC
Standard	CFR47 Part 15 Subpart C	RBW / VBW	1MHz / 3MHz
Dist/Ant Used	3m / DRH-118, 1m / RA42-K-F-4B-C	Performed by	Jeremy Luong

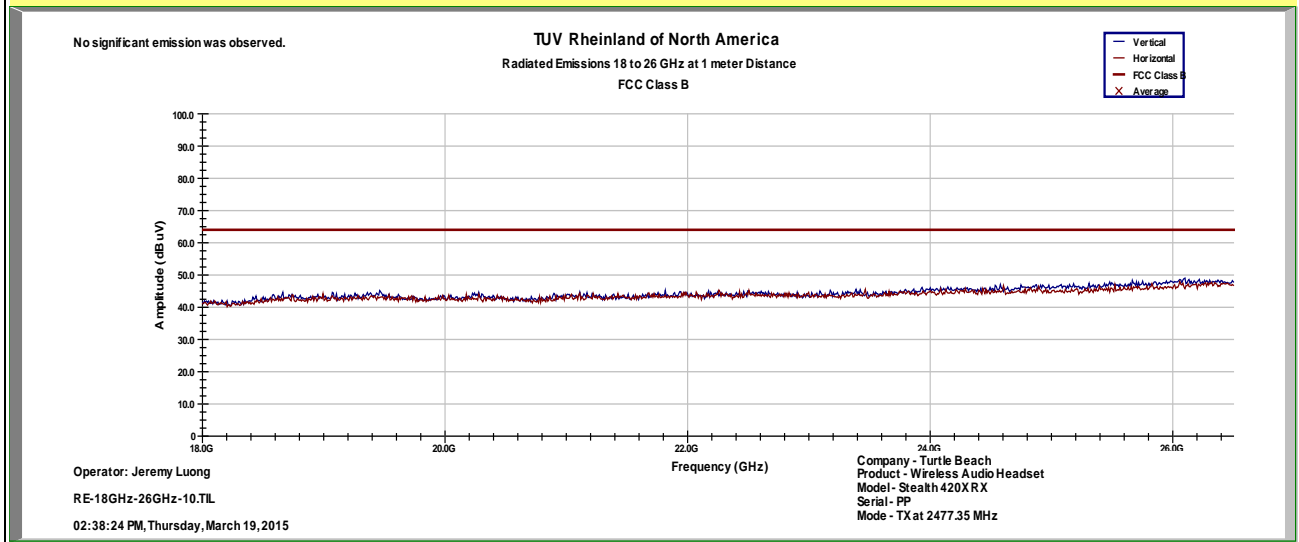
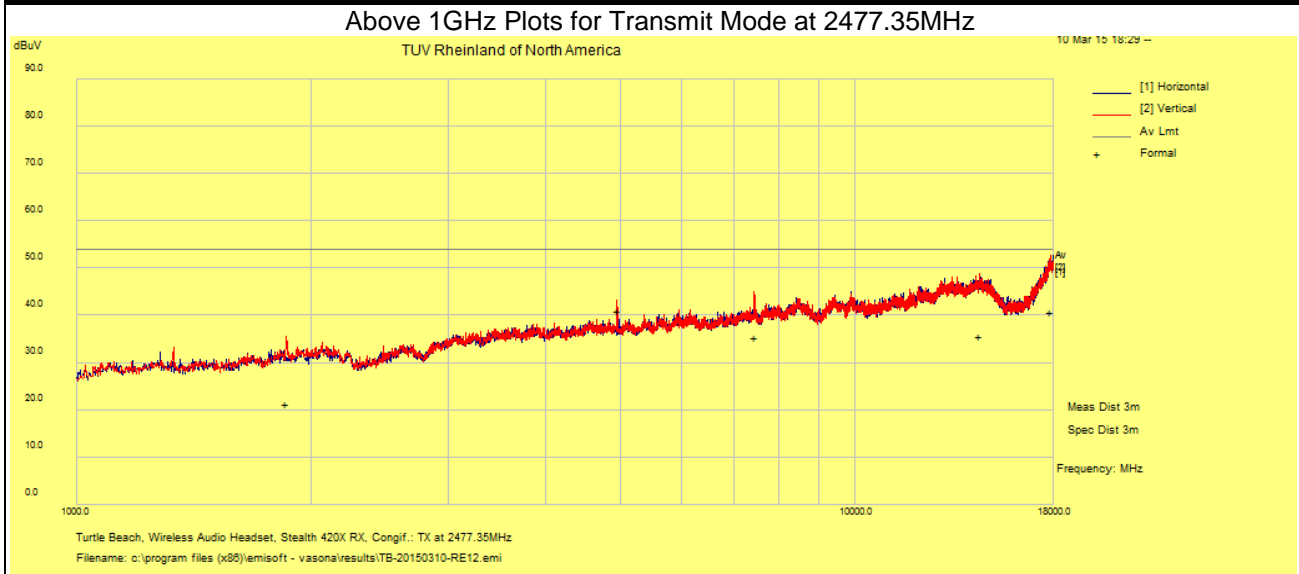

Notes: Limit was extrapolated to 1m distance for 18GHz – 25GHz range.
 1GHz – 25GHz Setting: RBW = 1MHz/ VBW = 3MHz

4.6.4 Sample Calculation

The field strength is calculated by subtracting the Amplifier Gain and adding the Cable Loss and Antenna Correction Factor to the measured reading. The basic equation is as follows:

$$\text{Field Strength (dB}\mu\text{V/m)} = \text{FIM} - \text{AMP} + \text{CBL} + \text{ACF}$$

Where: FIM = Field Intensity Meter (dB μ V)

AMP = Amplifier Gain (dB)

CBL = Cable Loss (dB)

ACF = Antenna Correction Factor (dB/m)

$$\mu\text{V/m} = 10^{\frac{\text{dB}\mu\text{V/m}}{20}}$$

4.7 AC Conducted Emissions

Testing was performed in accordance with ANSI C63.4: 2003. These test methods are listed under the laboratory's A2LA Scope of Accreditation.

This test measures the levels emanating from the EUT's AC input port, thus evaluating the potential for the EUT to cause radio frequency interference to other electronic devices.

The AC conducted emissions of equipment under test shall not exceed the values in CFR47 Part 15.207: 2013 and RSS-210: 2010.

4.7.1 Test Methodology

A test program that controls instrumentation and data logging was used to automate the AC Power Line Conducted emission test procedure. The frequency range of interest was divided into sub-ranges such as to yield a frequency resolution of 9 kHz. Each phase and neutral of the AC power line was measured with respect to ground. Measurements were performed using a set of 50 μ H / 50 Ω LISNs.

Testing is either performed in 5m Chamber. The setup photographs clearly identify which site was used. The vertical ground plane used in the semi-anechoic chamber is a 2m x 2m solid aluminum frame and panel, and it is bonded to the horizontal ground plane.

In the case of tabletop equipment, the EUT is placed on a 1.0m x 1.5m non-conductive table 80cm above the ground plane and 40cm from a vertical ground reference plane. The rear of the EUT was positioned flush with the backside of the table and directly over the LISNs. The power and I/O cables were routed over the edge of the table and bundled approximately 40cm from the ground plane. Support equipment was powered from a separate LISN.

4.7.1.1 Deviations

There were no deviations from this test methodology.

4.7.2 Test Results

This test is not required since EUT is powered by DC voltage.

5 Test Equipment List

5.1 Equipment List

Equipment	Manufacturer	Model #	Serial/Inst #	Last Cal mm/dd/yyyy	Next Cal mm/dd/yyyy
Bilog Antenna	Sunol Sciences	JB3	A102606	07/08/2014	07/08/2016
Bilog Antenna	Sunol Sciences	JB3	A020502	04/12/2013	04/12/2015
Horn Antenna	EMCO	3115	9710-5301	09/04/2013	09/04/2015
Horn Antenna	EMCO	3115	9211-3969	03/18/2013	04/18/2015
Antenna (18-26GHz)	CMT	RA42-K-F-4B-C	020131-004	07/24/2014	07/24/2015
Spectrum Analyzer	Rohde & Schwarz	FSL6	100169	01/13/2015	01/13/2016
Spectrum Analyzer	Agilent	N9038A	MY51210195	01/12/2015	01/12/2016
Spectrum Analyzer	Agilent	N9030A	MY51380689	01/19/2015	01/19/2016
Spectrum Analyzer	Rohde Schwarz	ESIB	832427/002	01/13/2015	01/13/2016
Spectrum Analyzer	Rohde Schwarz	FSV40	1321.3008K40	11/01/2015	11/01/2016
Amplifier	Sonoma Instruments	310	213221	09/30/2014	09/30/2015
Amplifier	Miteq	TTA1800-30-4G	1842452	01/13/2015	01/13/2016
Amplifier	Rohde & Schwarz	TS-PR26	100011	07/24/2014	07/24/2016
Amplifier	Rohde & Schwarz	TS-PR40	100012	02/21/2015	02/21/2016
Power Meter	Agilent	E4418B	MY45103902	01/15/2015	01/15/2016
Power Sensor	Hewlett Packard	8482A	US37295801	01/15/2015	01/15/2016
Thermometer	Fluke	52II	96480032	06/28/2014	06/28/2015
Thermo Chamber	Espec	BTZ-133	0613436	03/16/2015	03/16/2016
DC Power Supply	Agilent	E3634A	MY400004331	01/12/2015	01/12/2016
Notch Filter	Micro-Tronics	BRM50716	003	01/30/2015	01/30/2016
Signal Generator	Anritsu	MG3694A	42803	01/13/2015	01/13/2016
Signal Generator	Rohde & Schwarz	SMF100A	1167.0000K02	10/14/2014	10/14/2015
Signal Generator	Rohde & Schwarz	SMBV100A	1407.6004K02	12/04/2014	12/04/2015
Power Sensors	Rohde & Schwarz	OSP120	1520.9010.02	12/19/2014	12/14/2015

6 EMC Test Plan

6.1 Introduction

This section provides a description of the Equipment Under Test (EUT), configurations, operating conditions, and performance acceptance criteria. It is an overview of information provided by the manufacturer so that the test laboratory may perform the requested testing.

6.2 Customer

Table 8: Customer Information

Company Name	Voyetra Turtle Beach, Inc.
Address	100 Summit Lake Drive, Suite 100
City, State, Zip	Valhalla, New York 10595
Country	USA

Table 9: Technical Contact Information

Name	Tim Blaney
E-mail	tim@commcepts.net
Phone	(530) 277-3482

6.3 Equipment Under Test (EUT)

Table 10: EUT Specifications

EUT Specification	
Package Dimensions	225mm (8.9") x 252mm (9.9") x 115mm (4.5")
Power Input	Headset Input Voltage: 3.7 Vdc (battery)
Environment	Indoor
Operating Temperature Range:	0 to 50 degrees C
Multiple Feeds:	<input type="checkbox"/> Yes and how many <input checked="" type="checkbox"/> No
Hardware Version	PP
Part Number	N/A
RF Software Version	VMI Test Software V0.5
Operating Mode	VMI RF Protocol
Transmitter Frequency Band	2403.35 MHz to 2477.35 MHz
Max. Rated Power Output	+3.00 dBm
Power Setting @ Operating Channel	0 dBm
Antenna Type	PCB Attached on board (2 antennas; Ant1 = Ant2 = +2.0 dBi)
Modulation Type	<input type="checkbox"/> AM <input type="checkbox"/> FM <input checked="" type="checkbox"/> DSSS <input type="checkbox"/> OFDM <input type="checkbox"/> Other describe:
Date Rate	11 kbps
TX/RX Chain (s)	1
Directional Gain Type	<input checked="" type="checkbox"/> Uncorrelated <input checked="" type="checkbox"/> No Beam-Forming <input type="checkbox"/> Other describe:
Type of Equipment	<input type="checkbox"/> Table Top <input type="checkbox"/> Wall-mount <input type="checkbox"/> Floor standing cabinet <input checked="" type="checkbox"/> Other <i>describe: Head wear device.</i>
Note: Aux 0 is the default antenna output.	

Table 11: Interface Specifications

Interface Type	Cabled with what type of cable?	Is the cable shielded?	Maximum potential length of the cable?	Metallic (M), Coax (C), Fiber (F), or Not Applicable?
USB	Terminated	<input checked="" type="checkbox"/> Yes	<input checked="" type="checkbox"/> Metric:3m	<input checked="" type="checkbox"/> M
Headset	Unterminated	<input checked="" type="checkbox"/> No	<input checked="" type="checkbox"/> Metric: 1m	<input checked="" type="checkbox"/> M
Microphone	Terminated	<input checked="" type="checkbox"/> Yes	<input checked="" type="checkbox"/> Metric: 0.1m	<input checked="" type="checkbox"/> M

Table 12: Supported Equipment

Equipment	Manufacturer	Model	Serial	Used for
Laptop	Dell Computer	D630	28353268189	Set test mode

Table 13: Description of Sample used for Testing

Device	Serial Number	Configuration	Used For
Ear Force Stealth 420X RX	PP #2	Radiated Sample	Radiated Emissions.
Ear Force Stealth 420X RX	PP #1	Conducted Sample	Output Power, Occupied Bandwidth, Conducted Spurious Emissions, Peak Power Spectral Density
Note: None			

Table 14: Description of Test Configuration used for Radiated Measurement.

Device	Antenna	Mode	Setup Description
Ear Force Stealth 420X RX	Integrated	Transmit & Receive	Ear Force Stealth 420X RX positioned vertically, normal usage.
Note: The final setup configuration used for testing.			

Table 15: Final Test Mode for 2403.35 MHz to 2477.35MHz Band

Test	Ear Force Stealth 400 RX
Occupied Bandwidth	2403.35, 2441.35, 2477.35 MHz @ 11 kbps
Output Power	2403.35, 2441.35, 2477.35 MHz @ 11 kbps
Peak Power Spectral Density	2403.35, 2441.35, 2477.35 MHz @ 11 kbps
Out-of-Band (-30 dBr)	2403.35, 2441.35, 2477.35 MHz @ 11 kbps
Band-Edge (Radiated)	2403.35, 2477.35 MHz @ 11 kbps
Transmitted Spurious Emission	2403.35, 2441.35, 2477.35 MHz @ 11 kbps
AC Conducted Emission	NA
Note: EUT transmits at 100% duty cycle.	

6.4 Test Specifications

Testing requirements

Table 16: Test Specifications

Emissions and Immunity	
Standard	Requirement
CFR 47 Part 15.247: 2015	All
RSS-210 Iss. 8 2010	All