



**TÜVRheinland**<sup>®</sup>  
Precisely Right.

# Emissions Test Report

**EUT Name:** Wireless Audio Transmitter

**Model No.:** Elite 800X TX

CFR 47 Part 15.407:2014 and RSS-210:2010

*Prepared for:*

Voyetra Turtle Beach, Inc.  
100 Summit Lake Drive, Suite 100  
Valhalla, New York 10595 USA

*Prepared by:*

TUV Rheinland of North America, Inc.  
1279 Quarry Lane, Ste. A  
Pleasanton, CA 94566 U.S.A.  
Tel: (925) 249-9123  
Fax: (925) 249-9124  
<http://www.tuv.com/>

*Report/Issue Date:* April 2, 2015  
*Report Number:* 31560639.001  
*Project Number:* 0000126478  
*Revision Number:* 0



# Statement of Compliance

*Manufacturer:* Voyetra Turtle Beach, Inc.  
100 Summit Lake Drive, Suite 100  
Valhalla, New York 10595 USA

*Requester / Applicant:* Tim Blaney

*Name of Equipment:* Wireless Audio Transmitter  
*Model No.* Elite 800X TX (TB300-2391-01)  
*Type of Equipment:* Intentional Radiator  
*Application of Regulations:* CFR 47 Part 15.407:2014 and RSS-210:2010  
*Test Dates:* 27 February 2015 to 20 March 2015

*Guidance Documents:*

Emissions: ANSI C63.10-2009, KDB 789033 D02 General UNII Test Procedure New Rules v01

*Test Methods:*

Emissions: ANSI C63.10-2009, KDB 789033 D02 General UNII Test Procedure New Rules v01

The electromagnetic compatibility test and documented data described in this report has been performed and recorded by TUV Rheinland, in accordance with the standards and procedures listed herein. As the responsible authorized agent of the EMC laboratory, I hereby declare that the equipment described above has been shown to be compliant with the EMC requirements of the stated regulations and standards based on these results. If any special accessories and/or modifications were required for compliance, they are listed in the Executive Summary of this report.

This report must not be used to claim product endorsement by A2LA or any agency of the U.S. Government. This report contains data that are not covered by A2LA accreditation. This report shall not be reproduced except in full, without the written authorization of TUV Rheinland of North America.

Jeremy Luong	April 2, 2015	David Spencer	April 2, 2015
Test Engineer	Date	Laboratory Signature	Date



**Testing Cert #3331.02**

**US5254**

**2932M-1**

Table of Contents

<b>1</b>	<b>Executive Summary</b>	<b>7</b>
1.1	Scope	7
1.2	Purpose	7
1.3	Summary of Test Results	8
1.4	Special Accessories	8
1.5	Equipment Modifications	8
<b>2</b>	<b>Laboratory Information</b>	<b>9</b>
2.1	Accreditations & Endorsements	9
2.1.1	US Federal Communications Commission	9
2.1.2	NIST / A2LA	9
2.1.3	Canada – Industry Canada	9
2.1.4	Japan – VCCI	9
2.1.5	Acceptance by Mutual Recognition Arrangement	10
2.2	Test Facilities	10
2.2.1	Emission Test Facility	10
2.2.2	Immunity Test Facility	10
2.3	Measurement Uncertainty	11
2.3.1	Sample Calculation – radiated & conducted emissions	11
2.3.2	Measurement Uncertainty Emissions	11
2.3.3	Measurement Uncertainty Immunity	12
2.4	Calibration Traceability	12
<b>3</b>	<b>Product Information</b>	<b>13</b>
3.1	Product Description	13
3.2	Equipment Configuration	13
3.3	Operating Mode	13
3.4	Unique Antenna Connector	14
3.4.1	Results	14
<b>4</b>	<b>Emissions</b>	<b>15</b>
4.1	Output Power Requirements	15
4.1.1	Test Method	15
4.1.2	Results	16
4.2	Occupied Bandwidth	19
4.2.1	Test Method	19
4.2.2	Results	20
4.3	Peak Power Spectral Density	23
4.3.1	Test Method	23
4.3.2	Results	24
4.4	Transmitter Spurious Emissions	27
4.4.1	Test Methodology	27
4.4.2	Transmitter Spurious Emission Limit	28
4.4.3	Test Results	28

## Table of Contents

4.4.4	Sample Calculation	42
<b>4.5</b>	<b>AC Conducted Emissions</b>	<b>43</b>
4.5.1	Test Methodology	43
4.5.2	Test Results	43
<b>4.6</b>	<b>Frequency Stability</b>	<b>44</b>
4.6.1	Test Methodology	44
4.6.2	Manufacturer Declaration	44
4.6.3	Limit	45
4.6.4	Test results	45
<b>4.7</b>	<b>Voltage Variation</b>	<b>47</b>
4.7.1	Test Methodology	47
4.7.2	Test results	47
<b>4.8</b>	<b>Maximum Permissible Exposure</b>	<b>49</b>
4.8.1	Test Methodology	49
4.8.2	RF Exposure Limit	49
4.8.3	EUT Operating Condition	50
4.8.4	Classification	50
4.8.5	Test Results	50
4.8.6	Sample Calculation	50
<b>6</b>	<b>Test Equipment Use List</b>	<b>51</b>
<b>6.1</b>	<b>Equipment List</b>	<b>51</b>
<b>7</b>	<b>EMC Test Plan</b>	<b>52</b>
<b>7.1</b>	<b>Introduction</b>	<b>52</b>
<b>7.2</b>	<b>Customer</b>	<b>52</b>
<b>7.3</b>	<b>Equipment Under Test (EUT)</b>	<b>53</b>
<b>7.4</b>	<b>Test Specifications</b>	<b>56</b>

Index of Tables

**Table 1:** Summary of Test Results ..... 8  
**Table 2:** RF Output Power at the Antenna Port – Test Results ..... 16  
**Table 3:** Occupied Bandwidth – Test Results ..... 20  
**Table 4:** Maximum Power Spectral Density – Test Results..... 24  
**Table 5:** Transmit Spurious Emission at Band-Edge Requirements ..... 29  
**Table 6:** Frequency Stability – Test Results ..... 45  
**Table 7:** Voltage Variation – Test Results ..... 47  
**Table 8:** Customer Information ..... 52  
**Table 9:** Technical Contact Information ..... 52  
**Table 10:** EUT Specifications ..... 53  
**Table 11:** Interface Specifications..... 54  
**Table 12:** Supported Equipment..... 54  
**Table 13:** Description of Sample used for Testing..... 54  
**Table 14:** Description of Test Configuration used for Radiated Measurement. .... 54  
**Table 15:** Final Test Mode for 5150 - 5250 Bands ..... 55  
**Table 16:** Test Specifications ..... 56

# 1 Executive Summary

## 1.1 Scope

This report is intended to document the status of conformance with the requirements of the CFR 47 Part 15.407:2014 and RSS-210:2010 based on the results of testing performed on 27 February 2015 to 20 March 2015 on the Wireless Audio Transmitter Model Elite 800X TX manufactured by Voyetra Turtle Beach, Inc. This report only applies to the specific samples tested under the stated test conditions. It is the responsibility of the manufacturer to assure that additional production units of this model are manufactured with identical or EMI equivalent electrical and mechanical components. This report is further intended to document changes and modifications to the EUT throughout its life cycle. All documentation will be included as a supplement.

## 1.2 Purpose

Testing was performed to evaluate the EMC performance of the EUT in accordance with the applicable requirements, procedures, and criteria defined in the application of regulations and application of standards listed in this report.

The 5150 MHz to 5250 MHz frequency band was covered this document.

### 1.3 Summary of Test Results

**Table 1:** Summary of Test Results

Test	Test Method ANSI C63.4:2003/ ANSI C63.10:2009	Test Parameters	Measured Value	Result
Spurious Emission in Transmitted Mode	CFR47 15.209, CFR47 15.407 (b) RSS-GEN Sect.7.2.3, RSS-210 Sect. A.9.2	Class B	-7.50 dB (margin)	<b>Complied</b>
Restricted Bands of Operation	CFR47 15.205, RSS-210 Sect.2.6	Class B		<b>Complied</b>
AC Power Conducted Emission	CFR47 15.207, RSS-GEN Sect.7.2.2	Class B	N/A	<b>Complied</b>
Occupied Bandwidth	CFR47 15.407 (a), RSS GEN Sect.4.4.1	N/A	26dB BW: 32.78 MHz 99% BW: 18.22 MHz	<b>Complied</b>
Maximum Output Power	CFR47 15.407 (a), RSS-210 Sect. A.9.2	22.60 dBm	6.81 dBm	<b>Complied</b>
Peak Power Spectral Density	CFR47 15.407 (a), RSS-210 Sect. A.9.2	4.00 dBm/MHz	-4.01 dBm/MHz	<b>Complied</b>
Conducted Emission – Antenna Port	CFR47 15.407 (b), RSS-210 Sect.6.2.2	< -27 dBm/MHz	Note 3	<b>Complied</b>
Frequency Stability	CFR47 15.407 (g), RSS GEN Sect. 4.7.	±20 ppm	19.62 ppm	<b>Complied</b>
RF Exposure - General Population	CFR47 15.247 (i), 2.1091	1.0 mW/cm <sup>2</sup>	0.021087 mW/cm <sup>2</sup>	<b>Complied</b>

Note: 1. Meet restricted band emission requirements.  
 2. This report is only documented for 5150 – 5250 MHz.  
 3. EUT met spurious emission limit of CFR47 Part 15.407.

### 1.4 Special Accessories

No special accessories were necessary in order to achieve compliance.

### 1.5 Equipment Modifications

None



## 2 Laboratory Information

### 2.1 Accreditations & Endorsements

#### 2.1.1 US Federal Communications Commission



TUV Rheinland of North America at 1279 Quarry Ln, Pleasanton, CA 94566 is recognized by the commission for performing testing services for the general public on a fee basis. These laboratory test facilities have been fully described in reports submitted to and accepted by the FCC (US5254). The laboratory scope of accreditation includes: Title 47 CFR Parts 15, 18, and 90. The accreditation is updated every 3 years.

#### 2.1.2 NIST / A2LA



TUV Rheinland of North America is accredited by the National Voluntary Laboratory Accreditation Program, which is administered under the auspices of the National Institute of Standards and Technology. The laboratory has been assessed and accredited in accordance with ISO Guide 17025:2005 and ISO 9002 (Lab Code 3331.02). The scope of laboratory accreditation includes emission and immunity testing. The accreditation is updated annually.

#### 2.1.3 Canada – Industry Canada



TUV Rheinland of North America at the 1279 Quarry Ln, Pleasanton, CA 94566 address is accredited by Industry Canada for performing testing services for the general public on a fee basis. This laboratory test facilities have been fully described in reports submitted to and accepted by Industry Canada (File Number 2932M). This reference number is the indication to the Industry Canada Certification Officers that the site meets the requirements of RSS 212, Issue 1 (Provisional). The accreditation is updated every 3 years.

#### 2.1.4 Japan – VCCI



The Voluntary Control Council for Interference by Information Technology Equipment (VCCI) is a group that consists of Information Technology Equipment (ITE) manufacturers and EMC test laboratories. The purpose of the Council is to take voluntary control measures against electromagnetic interference from Information Technology Equipment, and thereby contribute to the development of a socially beneficial and responsible state of affairs in the realm of Information Technology Equipment in Japan. TUV Rheinland of North America at 1279 Quarry Ln, Pleasanton, CA 94566 has been assessed and approved in accordance with the Regulations for Voluntary Control Measures.

VCCI Registration No. for Pleasanton: A-0031

VCCI Registration No. for Santa Clara: A-0032

## 2.1.5 Acceptance by Mutual Recognition Arrangement



The United States has an established agreement with specific countries under the Asia Pacific Laboratory Accreditation Corporation (APLAC) Mutual Recognition Arrangement. Under this agreement, all TUV Rheinland at 1279 Quarry Ln, Pleasanton, CA 94566 test results and test reports within the scope of the laboratory NIST / A2LA accreditation will be accepted by each member country.

## 2.2 Test Facilities

All of the test facilities are located at 1279 Quarry Lane, Pleasanton, California 94566, USA. The 2305 Mission College, Santa Clara, 95054, USA location is considered a Pleasanton annex.

### 2.2.1 Emission Test Facility

The Semi-Anechoic chamber and AC Line Conducted measurement facility used to collect the radiated and conducted data has been constructed in accordance with ANSI C63.7:1992. The site has been measured in accordance with and verified to comply with the theoretical normalized site attenuation requirements of ANSI C63.4-2009, at a test distance of 3 and 5 meters. The site is listed with the FCC and accredited by A2LA (Lab Code 3331.02). The 3/5-meter semi-anechoic chamber used to collect the radiated data has been verified to comply with the theoretical normalized site attenuation requirements of ANSI C63.4-2009, at a test distance of 3 meter and 5 meters. A report detailing this site can be obtained from TUV Rheinland of North America.

### 2.2.2 Immunity Test Facility

ESD, EFT, Surge, PQF: These tests are performed in an environmentally controlled room with a 3.7 m x 4.8 m x 3.175 mm thick aluminum floor connected to PE ground.

For ESD testing, tabletop equipment is placed on an insulated mat with a surface resistivity of  $10^9$  Ohms/square on a 1.6 m x 0.8 m x 0.8 m high non-conductive table with a 3.175 mm aluminum top (Horizontal Coupling Plane). The HCP is connected to the main ground plane via a low impedance ground strap through two 470-k $\Omega$  resistors. The Vertical Coupling Plane consists of an aluminum plate 50 cm x 50 cm x 3.175 mm thick. The VCP is connected to the main ground plane via a low impedance ground strap through two 470-k $\Omega$  resistors.

For EFT, Surge, PQF, the HCP and VCP are removed.

RF Field Immunity testing is performed in a 7.3m x 4.3m x 4.1m anechoic chamber.

RF Conducted and Magnetic Field Immunity testing is performed on a 4.8m x 3.7m x 3.175mm thick aluminum ground plane.

All test areas allow a minimum distance of 1 meter from the EUT to walls or conducting objects.

## 2.3 Measurement Uncertainty

Two types of measurement uncertainty are expressed in this report, per *ISO Guide To The Expression Of Uncertainty In Measurement*, 1<sup>st</sup> Edition, 1995.

*The Combined Standard Uncertainty* is the standard uncertainty of the result of a measurement when that result is obtained from the values of a number of other quantities; it is equal to the positive square root of the sum of the variances or co-variances of these other quantities, weighted according to how the measurement result varies with changes in these quantities. The term *standard uncertainty* is the result of a measurement expressed as a standard deviation.

### 2.3.1 Sample Calculation – radiated & conducted emissions

The field strength is calculated by subtracting the Amplifier Gain and adding the Cable Loss and Antenna Correction Factor to the measured reading. The basic equation is as follows:

$$\text{Field Strength (dB}\mu\text{V/m)} = \text{RAW} - \text{AMP} + \text{CBL} + \text{ACF}$$

Where: RAW = Measured level before correction (dBμV)

AMP = Amplifier Gain (dB)

CBL = Cable Loss (dB)

ACF = Antenna Correction Factor (dB/m)

$$\mu\text{V/m} = 10^{\frac{\text{dB}\mu\text{V} / \text{m}}{20}}$$

#### Sample radiated emissions calculation @ 30 MHz

**Measurement +Antenna Factor–Amplifier Gain+Cable loss=Radiated Emissions (dBuV/m)**

$$25 \text{ dBuV/m} + 17.5 \text{ dB} - 20 \text{ dB} + 1.0 \text{ dB} = 23.5 \text{ dBuV/m}$$

### 2.3.2 Measurement Uncertainty Emissions

Per CISPR 16-4-2	U <sub>lab</sub>	U <sub>cispr</sub>
<b>Radiated Disturbance @ 10 meters</b>		
30 – 1,000 MHz	2.25 dB	4.51 dB
<b>Radiated Disturbance @ 3 meters</b>		
30 – 1,000 MHz	2.26 dB	4.52 dB
1 – 6 GHz	2.12 dB	4.25 dB
6 – 18 GHz	2.47 dB	4.93 dB
<b>Conducted Disturbance @ Mains Terminals</b>		
150 kHz – 30 MHz	1.09 dB	2.18 dB
<b>Disturbance Power</b>		
30 MHz – 300 MHz	3.92 dB	4.3 dB

**Voltech PM6000A**

The estimated combined standard uncertainty for harmonic current and flicker measurements is $\pm 5.0\%$ .	Per CISPR 16-4-2 Methods
--	--------------------------

**2.3.3 Measurement Uncertainty Immunity**

The estimated combined standard uncertainty for ESD immunity measurements is $\pm 8.2\%$ .	Per IEC 61000-4-2
The estimated combined standard uncertainty for radiated immunity measurements is $\pm 4.10$ dB.	Per IEC 61000-4-3
The estimated combined standard uncertainty for conducted immunity measurements with CDN is $\pm 3.66$ dB	Per IEC 61000-4-6
The estimated combined standard uncertainty for power frequency magnetic field immunity is $\pm 11.6\%$ .	Per IEC 61000-4-8

**Thermo KeyTek EMC Pro**

The estimated combined standard uncertainty for EFT fast transient immunity measurements is $\pm 5.84\%$ .
The estimated combined standard uncertainty for surge immunity measurements is $\pm 5.84\%$ .
The estimated combined standard uncertainty for voltage variation and interruption measurements is $\pm 3.48\%$ .

The expanded uncertainty at a level of 95% confidence is obtained by multiplying the combined standard uncertainty by a coverage factor of 2. Compliance criteria are not based on measurement uncertainty.

**Measurement Uncertainty – Radio Testing**

The estimated combined standard uncertainty for frequency error measurements is $\pm 3.88$ Hz
The estimated combined standard uncertainty for carrier power measurements is $\pm 1.59$ dB.
The estimated combined standard uncertainty for adjacent channel power measurements is $\pm 1.47$ dB.
The estimated combined standard uncertainty for modulation frequency response measurements is $\pm 0.46$ dB.
The estimated combined standard uncertainty for transmitter conducted emission measurements is $\pm 4.01$ dB

The expanded uncertainty at a level of 95% confidence is obtained by multiplying the combined standard uncertainty by a coverage factor of 2. Compliance criteria are not based on measurement uncertainty.

**2.4 Calibration Traceability**

All measurement instrumentation is traceable to the National Institute of Standards and Technology (NIST). Measurement method complies with ANSI/NCSL Z540-1-1994 and ISO Standard 17025:2005.

---

## 3 Product Information

### 3.1 Product Description

The Elite 800X Wireless Gaming System consists of two main communication modules, the Elite 800X RX (“Headset”) and the Elite 800X TX (“Transmitter”). These two modules comprise a closed-loop wireless audio gaming system that utilize a Wi-Fi and Bluetooth communication technologies to offer wireless streaming audio and chat/talkback capabilities.

### 3.2 Equipment Configuration

A description of the equipment configuration is given in the Test Plan Section. The EUT was tested as called for in the test standard and was configured and operated in a manner consistent with its intended use. The EUT was connected to rated power and allowed to reach intended operating conditions. The placement of the EUT system components was guided by the test standard and selected to represent typical installation conditions.

In the case of a EUT that can operate in more than one configuration, preliminary testing was performed to determine the configuration that produced maximum radiation.

The final configuration was selected to produce the worst case radiation for emissions testing and to place the EUT in the most susceptible state for immunity testing.

### 3.3 Operating Mode

A description of the operation mode is given in the Test Plan Section. In the case of a EUT that can operate in more than one state, preliminary testing was performed to determine the operating mode that produced maximum radiation.

The final operating mode was selected to produce the worst case radiation for emissions testing and to place the EUT in the most susceptible state for immunity testing.

### 3.4 Unique Antenna Connector

An intentional radiator shall be designed to ensure that no antenna other than that furnished by the responsible party shall be used with the device. The use of a permanently attached antenna or of an antenna that uses a unique coupling to the intentional radiator shall be considered sufficient to comply with the provisions of this Section. The manufacturer may design the unit so that a broken antenna can be replaced by the user, but the use of a standard antenna jack or electrical connector is prohibited. This requirement does not apply to carrier current devices or to devices operated under the provisions of CFR47 Parts 15.211, 15.213, 15.217, 15.219, or 15.221.

#### 3.4.1 Results

The Elite 800X TX has (1) internal integrated antenna. There is no external antenna connection available.

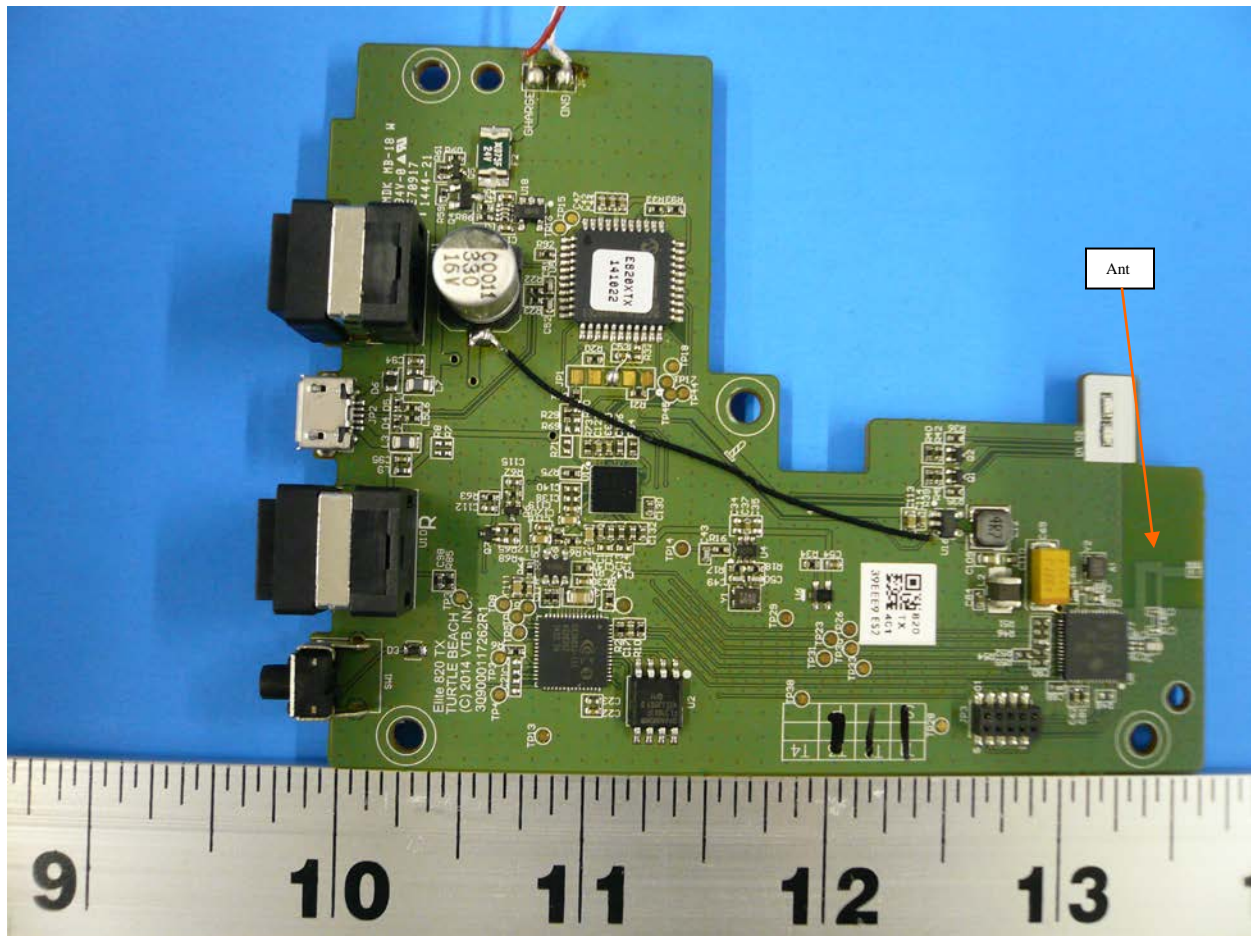



## 4 Emissions

Testing was performed in accordance with CFR 47 Part 15.407: 2014 and RSS 210 Annex 9: 2010. These test methods are listed under the laboratory's A2LA Scope of Accreditation. This test measures the levels emanating from the EUT, thus evaluating the potential for the EUT to cause radio frequency interference to other electronic devices. Procedures described in section 8 of the standard were used.

### 4.1 Output Power Requirements

*The maximum output power requirement is the maximum equivalent isotropic radiated power delivering at the transmitting antenna under specified conditions of measurements in the presence of modulation.*

*The maximum output power and harmonics shall not exceed CFR47 Part 15.407 (a):2014 and RSS-210 A9.2: 2010.*

*The maximum transmitted powers for mobile and portable client device is*

*Band 5150-5250 MHz: 250 mW; per CFR47 Part 15.407:2014*

*Band 5150-5250 MHz: 200 mW or  $10+10\log(B)$ ; where B is 99% Bandwidth.*

#### 4.1.1 Test Method

The ANSI C63.10-2009 Section 6.10.3.1 conducted method was used to measure the channel power output. The preliminary investigation was performed at different data rate to determine the highest power output for each mode. The worst findings were conducted on 3 channels on the sample, S/N PP #1, per CFR47 Part 15.407(a): 2014 and RSS-210 A.9.2; 5150 MHz to 5250 MHz. The worst mode results indicated below.

Test Setup:

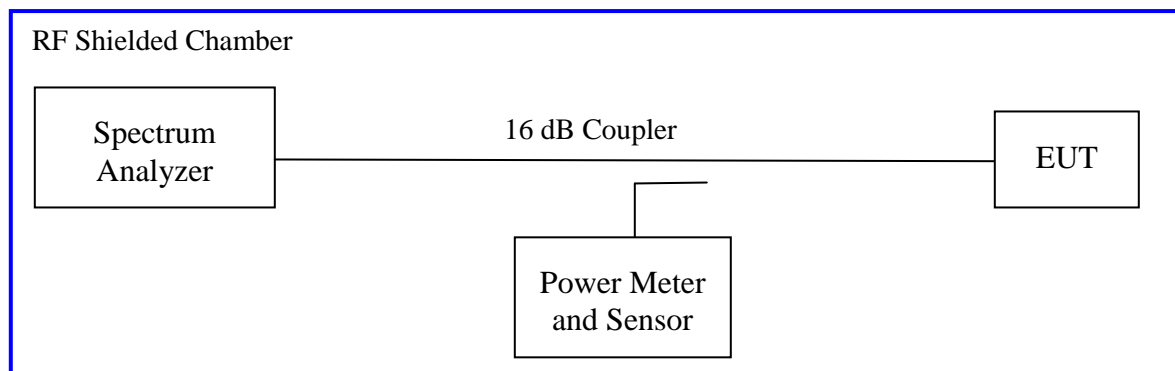

Method SA-2 of KDB 789033 D02 General UNII Test Procedure New Rules v01, "Guidelines for Compliance Testing of Unlicensed National Information Infrastructure (U-NII) Devices", applies since the EUT continuously transmit with duty cycle less 100%. The duty cycle,  $CF = 10\log(1/\text{duty cycle})$ , did not applied since EUT transmitted at 100% duty cycle.

#### 4.1.2 Results

As originally tested, the EUT was found to be compliant to the requirements of the test standard(s).

**Table 2: RF Output Power at the Antenna Port – Test Results**

<b>Test Conditions:</b> Conducted Measurement		<b>Test Date:</b> March 16, 2015	
<b>Antenna Type:</b> Integrated		<b>Power Setting:</b> SPW 0	
<b>Antenna Gain:</b> + 3.5 dBi		<b>Signal State:</b> Modulated	
<b>Ambient Temp.:</b> 23 °C		<b>Relative Humidity:</b> 32%	
<b>Result</b>			
Operating Channel	Limit [dBm]	Output Power [dBm]	Margin [dB]
5180	22.60	5.29	-17.31
5200	22.60	6.29	-16.31
5240	22.60	6.81	-15.79
<p><b>Note:</b> 1. The highest output power was observed at 802.11a, 6Mbps.          2. EUT is portable device. The limit under CFR47 Part 15.407 (a)(1)(iv) is 250 mW or 23.98 dBm. RSS 210 Sect 9.2 limit calculated using 99% bandwidth is 22.60dBm. Since the calculated limit is more stricken, it is used to show compliance to both FCC and IC.          3. Measurements performed at 100% duty cycle; therefore, duty correction factor do not include to the final calculation.          4. Maximum antenna gain is less than 6 dBi; therefore, no antenna correction factor was applied.</p>			



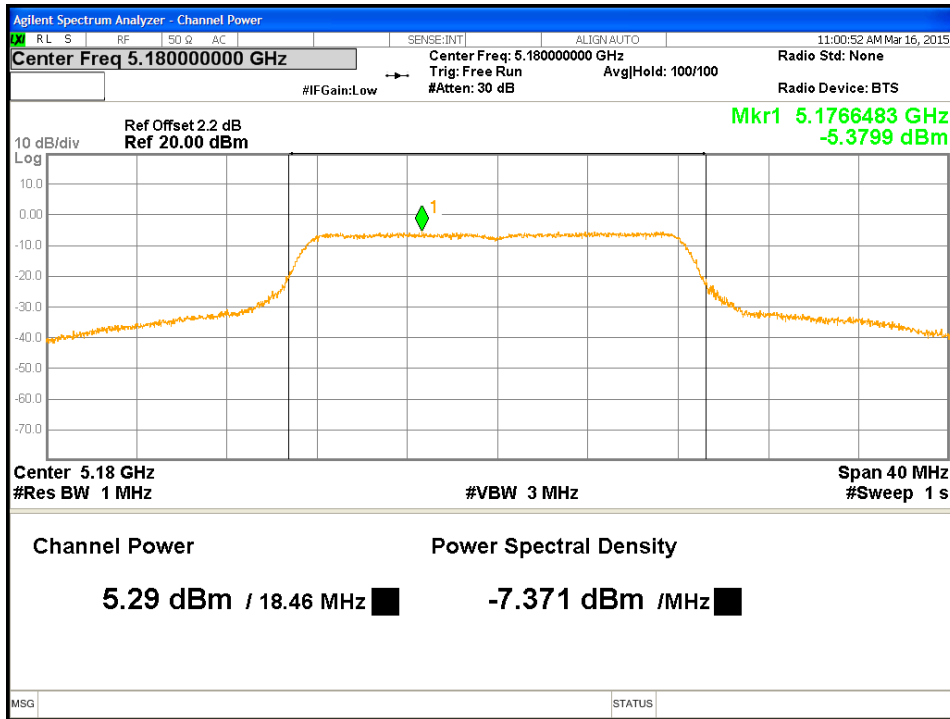

Figure 1: Maximum Conducted Output Power-5180 MHz-11a-6Mbps

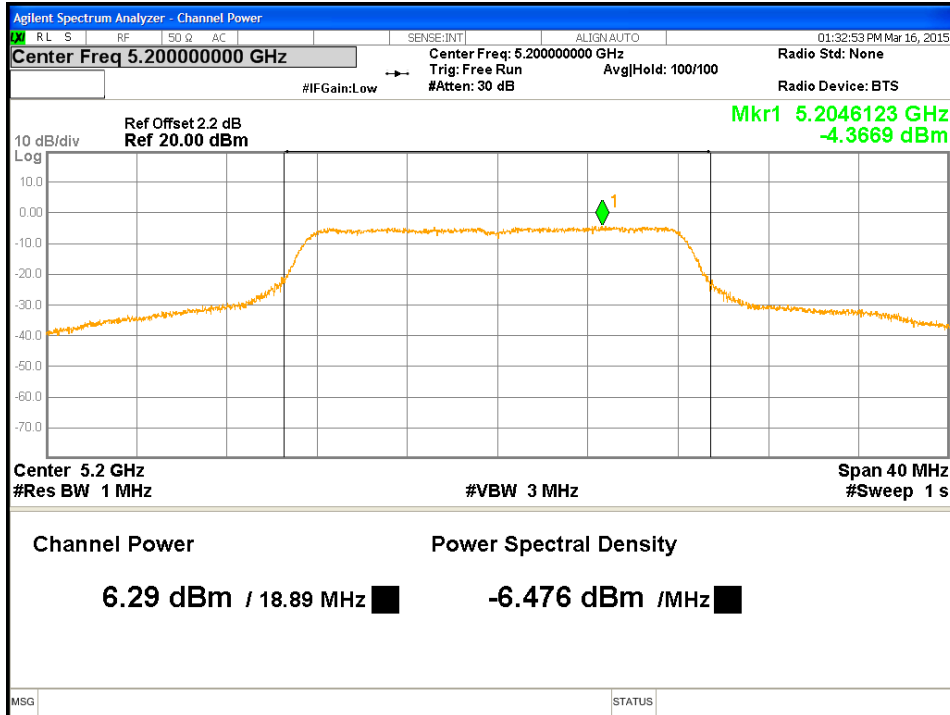

Figure 2: Maximum Conducted Output Power-5200 MHz-11a-6Mbps

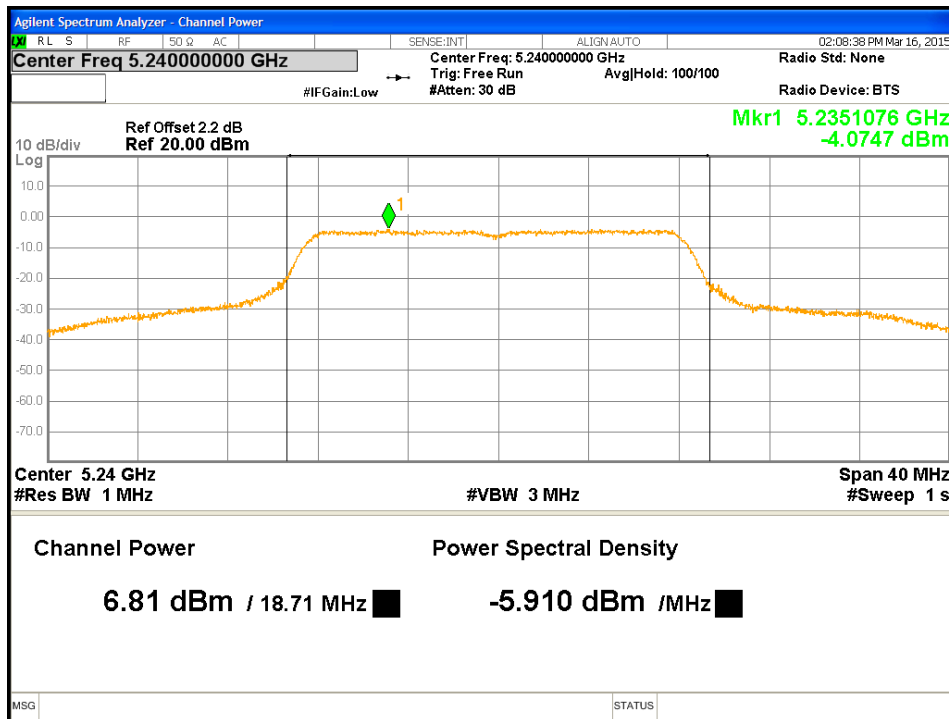

Figure 3: Maximum Conducted Output Power-5240 MHz-11a-6Mbps

## 4.2 Occupied Bandwidth

The occupied bandwidth is measured at an amplitude level reduced from the reference level by a specified ratio. The reference level is the level of the highest amplitude signal observed from the transmitter at the fundamental frequency.

The 99% bandwidth is the bandwidth in which 99% of the transmitted power occupied.

The 26 dB bandwidth is defined the bandwidth of 26 dB from highest transmitted level of the fundamental frequency.

There is no power limitation referencing to the 26 dB bandwidth under CFR47 Part 15.407 (a)(1)(iv).

The 26 dB bandwidth recorded for information only.

### 4.2.1 Test Method

The conducted method was used to measure the occupied bandwidth. The measurement was performed with modulation per CFR47 15.407(a) 2014 and RSS Gen Sect. 4.4.1:2010. The preliminary investigation was performed to find the narrowest 26 dB bandwidth for each operational mode at different data rates. This worst finding was performed on 3 channels in each operating frequency range; 5150 MHz to 5250 MHz on the sample, Elite 800X TX S/N PP#1. The results indicated below.

Test Setup:

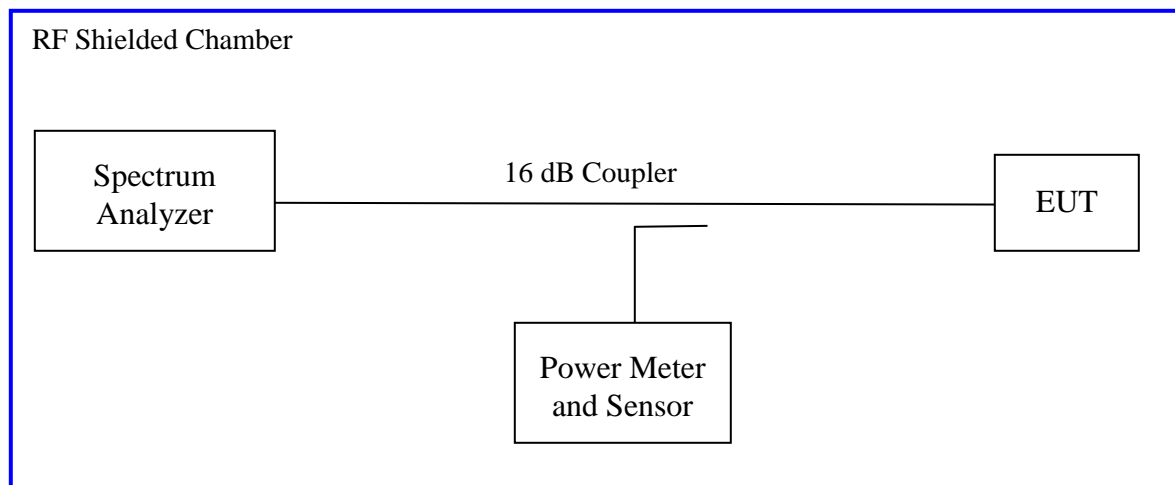

Method in Sect. C and D of KDB 789033 D02 General UNII Test Procedure New Rules v01, “Guidelines for Compliance Testing of Unlicensed National Information Infrastructure (U-NII) Devices”, used to perform measurements.

## 4.2.2 Results

These occupied bandwidth measurements were taken for references only.

**Table 3: Occupied Bandwidth – Test Results**

<b>Test Conditions:</b> Conducted Measurement		<b>Test Date:</b> March 16, 2015
<b>Antenna Type:</b> Integrated		<b>Power Setting:</b> SPW 0
<b>Antenna Gain:</b> + 3.5 dBi		<b>Signal State:</b> Modulated
<b>Ambient Temp.:</b> 23 °C		<b>Relative Humidity:</b> 32%
<b>Bandwidth for 802.11a</b>		
Frequency (MHz)	99% Bandwidth (MHz)	26dB Bandwidth (MHz)
5180	18.217	32.780
5200	18.378	33.090
5240	18.607	34.910
<b>Note:</b> 1. The bandwidth was measured at 802.11a, 6 Mbps. 2. The 18.217 MHz is used toward the maximum output power limit calculation per RSS210 Sect. 9.2.		

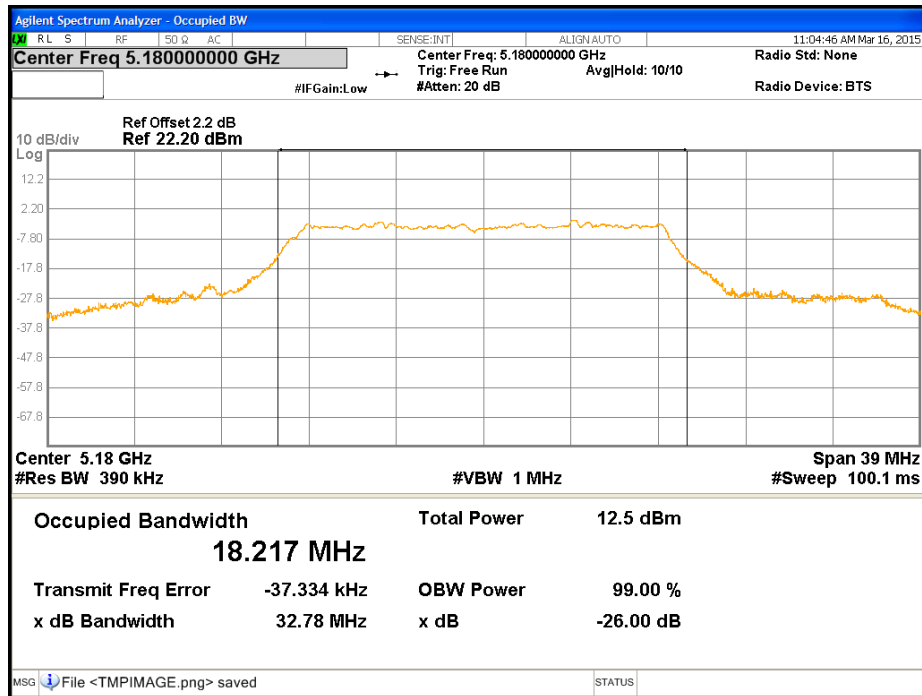

Figure 4: Occupied Bandwidth-5180 MHz-11a-6Mbps

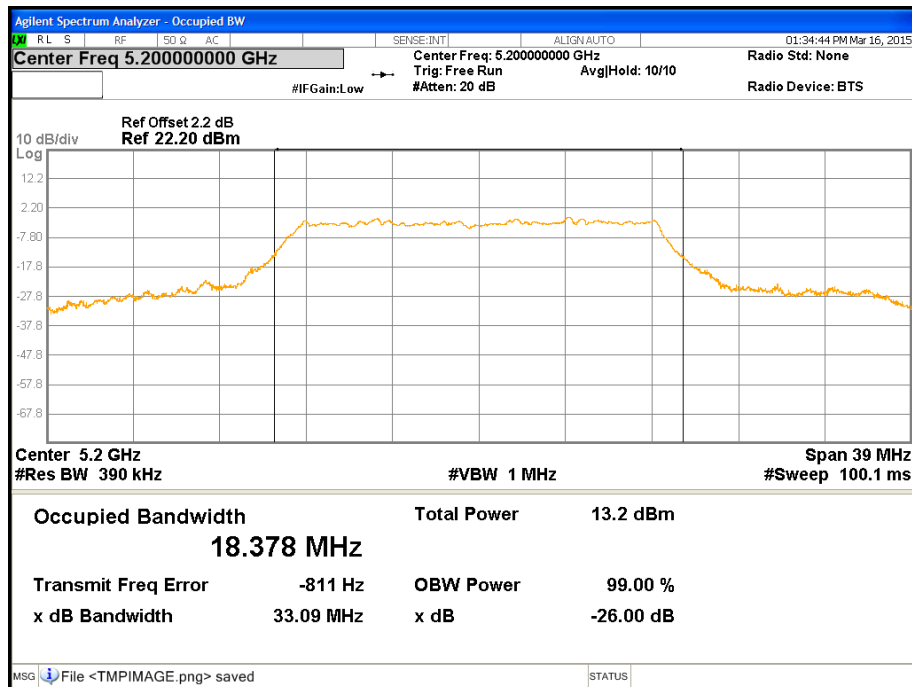

Figure 5: Occupied Bandwidth-5200 MHz-11a-6Mbps

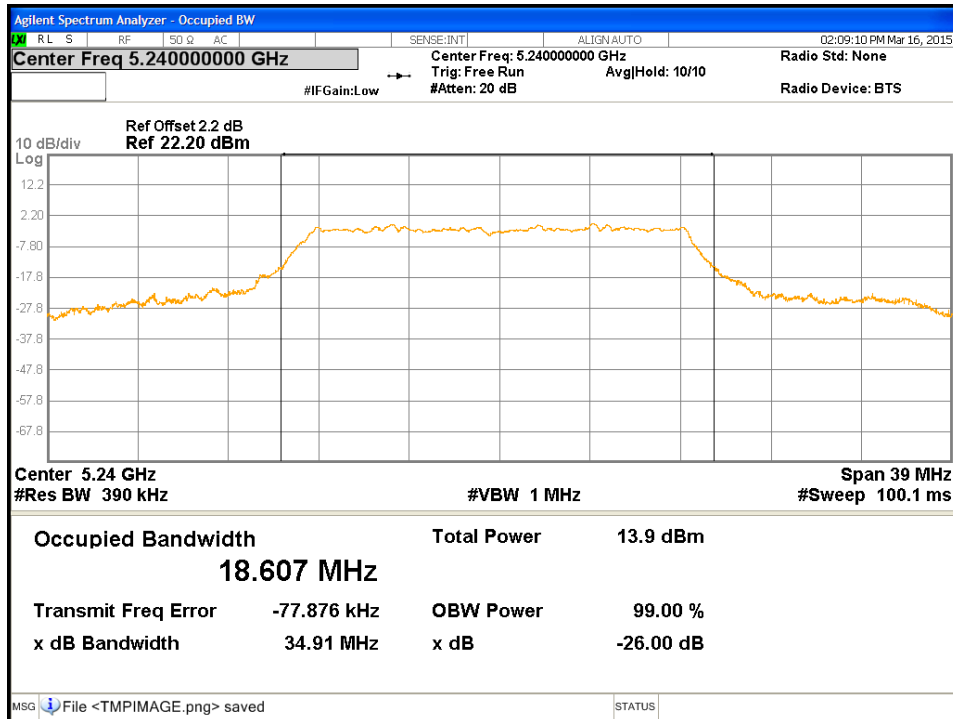

Figure 6: Occupied Bandwidth-5240 MHz-11 a-6Mbps

### 4.3 Peak Power Spectral Density

According to the CFR47 Part 15.407 (a) (1)(iv) the spectral power density output of the antenna port shall be less than 11 dBm in any 1 MHz band during any time interval of continuous transmission. RSS-210 (A9.2) has the e.i.r.p limit of 10.0 dBm in any 1 MHz.

#### 4.3.1 Test Method

The conducted method was used to measure the peak power spectral density per ANSI C63.10-2009 Section 6.11.2. The measurement was performed with modulation per CFR47 Part 15.407 (a) and RSS-210 (A9.2). The pre-evaluation was performed to find the worst modes. The worst findings were conducted on 3 channels in frequency range of 5150 MHz to 5250 MHz for the test sample, Elite 800X TX S/N PP#1. The result indicated below.

Test Setup:

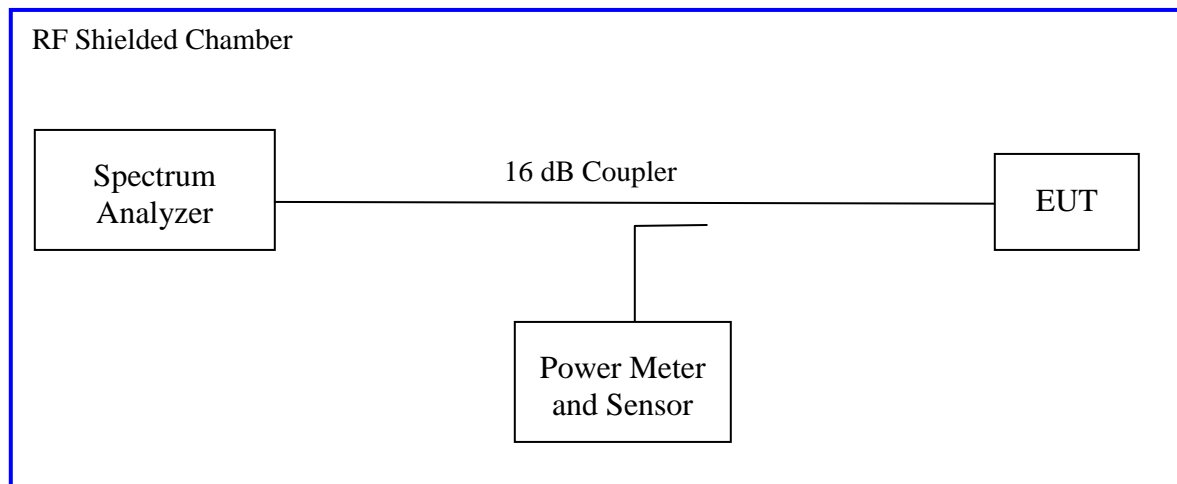

KDB 789033 D02 General UNII Test Procedure New Rules v01, “Guidelines for Compliance Testing of Unlicensed National Information Infrastructure (U-NII) Devices” Section F applies for measuring maximum power spectral density with duty cycle less than 100%. There was no duty cycle correction factor applied.

### 4.3.2 Results

As originally tested, the EUT was found to be compliant to the requirements of the test standard(s).

**Table 4: Maximum Power Spectral Density – Test Results**

<b>Test Conditions:</b> Conducted Measurement		<b>Test Date:</b> March 16, 2015	
<b>Antenna Type:</b> Integrated		<b>Power Setting:</b> SPW 0	
<b>Antenna Gain:</b> + 3.5 dBi		<b>Signal State:</b> Modulated	
<b>Ambient Temp.:</b> 23 °C		<b>Relative Humidity:</b> 32%	
<b>Maximum Power Spectral Density</b>			
<b>802.11a Mode</b>			
Freq. [MHz]	Limit [dBm]	Max. Power Spectral Density [dBm]	Margin [dB]
5180	4.00	-5.37	-9.37
5200	4.00	-4.70	-8.70
5240	4.00	-4.01	-8.01
<b>Note:</b> 1. The maximum power spectral density was observed at 802.11a 6 Mbps at 100% duty cycle. 2. The conducted maximum spectral density limit with 6dBi antenna for CFR47 Part 15.407 (a)(1)(iv) is 17.0 dBm, and it is 4.0 dBm for RSS210 Sect. 9.2. The 4.0 dBm limit is used to show compliance to both standards.			



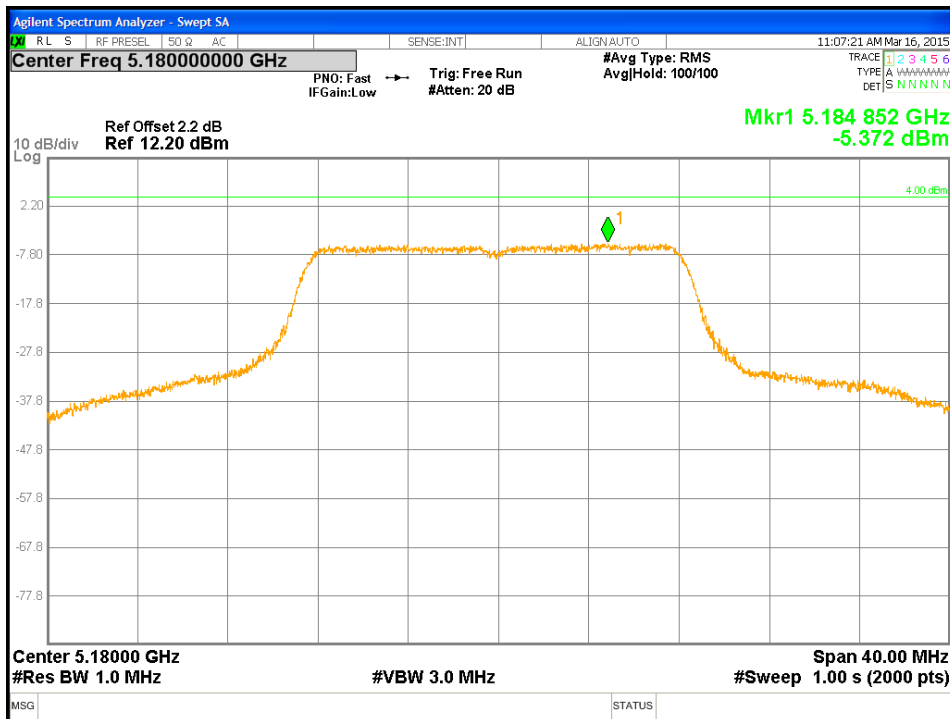

Figure 7: Maximum Power Spectral Density-5180 MHz-11a-6Mbps

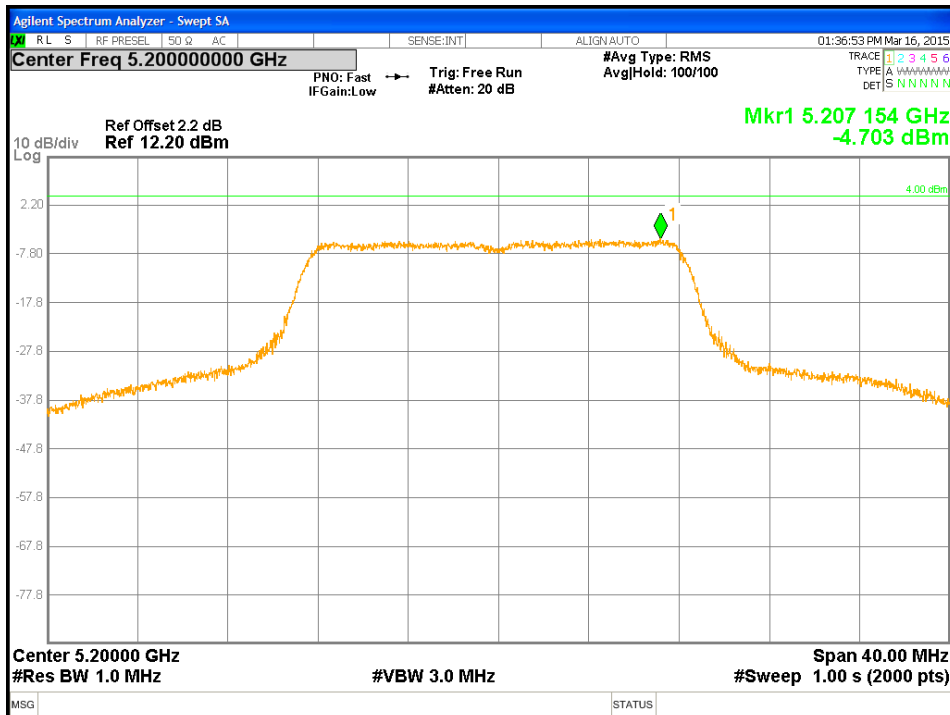

Figure 8: Maximum Power Spectral Density-5200 MHz-11a-6Mbps

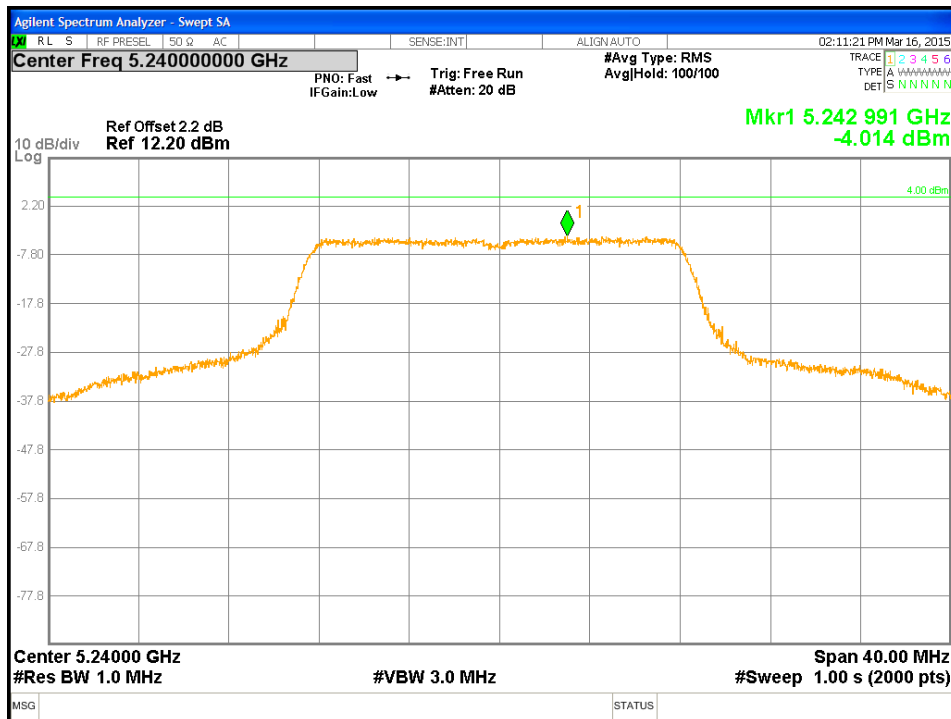

Figure 9: Maximum Power Spectral Density-5240 MHz-11 a-6Mbps

## **4.4 Transmitter Spurious Emissions**

*Transmitter spurious emissions are emissions outside the frequency range of the equipment when the equipment is in transmit mode; per requirement of CFR47 15.205, 15.209, 15.407(b), RSS-210 Sect. A.9.2*

### **4.4.1 Test Methodology**

#### **4.4.1.1 Preliminary Test**

A test program that controls instrumentation and data logging was used to automate the preliminary RF emission test procedure. The frequency range of interest was divided into sub-ranges to yield a frequency resolution of approximately 120 kHz and provide a reading at each frequency for no more than 12° of turntable rotation. For each frequency sub-range the turntable was rotated 360° while peak emission data was recorded and plotted over the frequency range of interest in horizontal and vertical antenna polarization's.

Preliminary emission profile testing was performed inside the anechoic chamber. The EUT was placed on a 1.0m x 1.5m non-conductive table 80cm above the floor. The EUT was positioned as shown in the setup photographs. The receiving antenna was placed at a distance of 3m at a fixed height of 1m. Measurement equipment was located outside of the chamber. A video camera was placed inside the chamber to view the EUT.

Pre-scans were performed to determine the worst axis, and data rate.

#### **4.4.1.2 Final Test**

For each frequency measured, the peak emission was maximized by manipulating the receiving antenna from 1 to 4 meters above the ground plane and placing it at the position that produced the maximum signal strength reading. The turntable was then rotated through 360° while observing the peak signal and placing the EUT at the position that produced maximum radiation. The six highest emissions relative to the limit were measured unless such emissions were more than 20 dB below the limit. If less than six emissions are within 20 dB of the limit, than the noise level of the receiver is measured at frequencies where emissions are expected. Multiples of all oscillator and microprocessor frequencies were also checked.

Final testing was performed on an NSA compliant test site. The EUT was placed on a 1.0m x 1.5m non-conductive table 80cm above the ground plane. The placement of EUT and cables were the same as for preliminary testing and is shown in the setup photographs.

The final scans performed on the worst axis, X-Axis, for three operating channels;

6 Mbps for 802.11a Mode: 5180 MHz, 5200 MHz, 5240 MHz

#### **4.4.1.3 Deviations**

None.

#### 4.4.2 Transmitter Spurious Emission Limit

The spurious emissions of the transmitter shall not exceed the values in CFR47 Part 15.205, 15.209: 2014 and RSS-210 A1.1.2 2010.

Frequency (MHz)	Field strength (microvolts/meter)	Measurement distance (meters)
0.009-0.490.....	2400/F (kHz)	300
0.490-1.705.....	24000/F (kHz)	30
1.705-30.0.....	30	30
30-88.....	100 **	3
88-216.....	150 **	3
216-960.....	200 **	3
Above 960.....	500	3

According to CFR47 15.407 (b), all harmonics and spurious emissions which are outside the 5150 MHz - 5350 MHz shall not exceed -27 dBm/MHz. This is equivalent to 68.2 dBuV/m at 3 meter distance.

#### 4.4.3 Test Results

The final measurement data was taken under the worst case operating modes, configurations, and/or cable positions. It also reflects the results including any modifications and/or special accessories listed in Sections 1.4 and test plan.

As originally tested, the EUT was found to be compliant to the requirements of the test standard(s).

**Table 5: Transmit Spurious Emission at Band-Edge Requirements**

<b>Test Conditions:</b> Radiated Measurement					<b>Test Date:</b> March 2, 2015			
<b>Antenna Type:</b> Integrated					<b>Power Setting:</b> SPW 0			
<b>Antenna Gain:</b> + 3.5 dBi					<b>Signal State:</b> Modulated			
<b>Ambient Temp.:</b> 23 °C					<b>Relative Humidity:</b> 32%			
<b>Band-Edge Results</b>								
Freq. (MHz)	Level (dBuV/m)	Polarity (H/V)	Limit (dBuV/m)	Margin (dB)	Det.	Table Deg.	Tower (cm)	Note
5150	57.57	H	74.00	-16.43	Pk	-20	308	5180 MHz-11a-6Mbps
5150	46.50	H	54.00	-7.50	Ave	-20	308	5180 MHz-11a-6Mbps
5150	53.75	V	74.00	-20.25	Pk	271	338	5180 MHz-11a-6Mbps
5150	44.32	V	54.00	-9.68	Ave	271	338	5180 MHz-11a-6Mbps
5150	51.45	H	74.00	-22.55	Pk	-20	333	5240 MHz-11a-6Mbps
5150	41.04	H	54.00	-12.96	Ave	-20	333	5240 MHz-11a-6Mbps
5150	50.77	V	74.00	-23.23	Pk	317	310	5240 MHz-11a-6Mbps
5150	40.67	V	54.00	-13.33	Ave	317	310	5240 MHz-11a-6Mbps
<p><b>Note:</b></p> <ol style="list-style-type: none"> <li>1. All the band-edge measurements met the restricted band requirements of CFR47 15.205.</li> <li>3. It is also complied with the -27 dBm/MHz (68.2dBuV/m at 3m) requirements as stated in CFR47 15.407 (b) (1).</li> <li>4. It is also confirm that the 20dBr point of the highest channel in each mode is within the 5150-5250 MHz range.</li> </ol>								

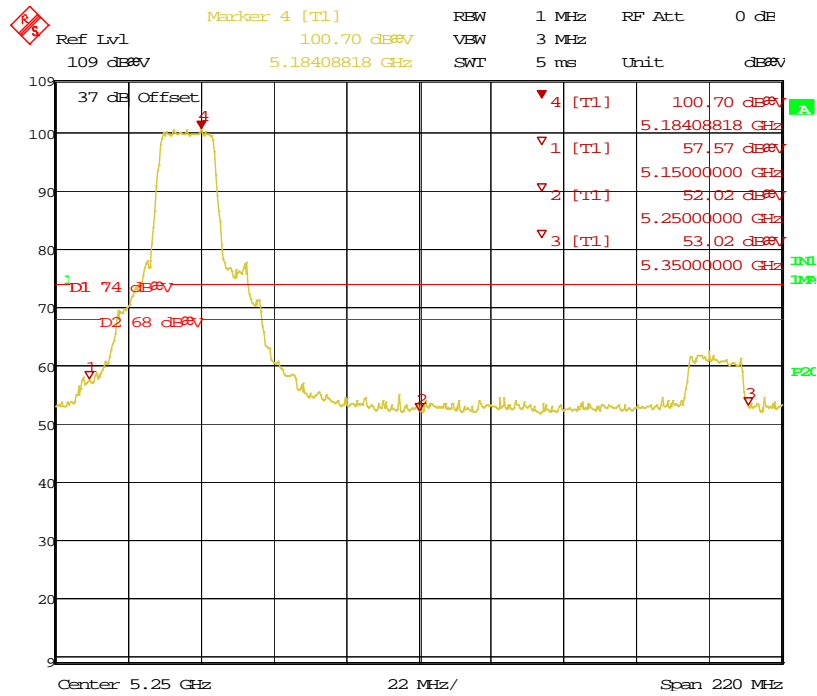

Date: 2.MAR.2015 14:31:28

Figure 10: Bandedge-5180 MHz-11a-H-Pk

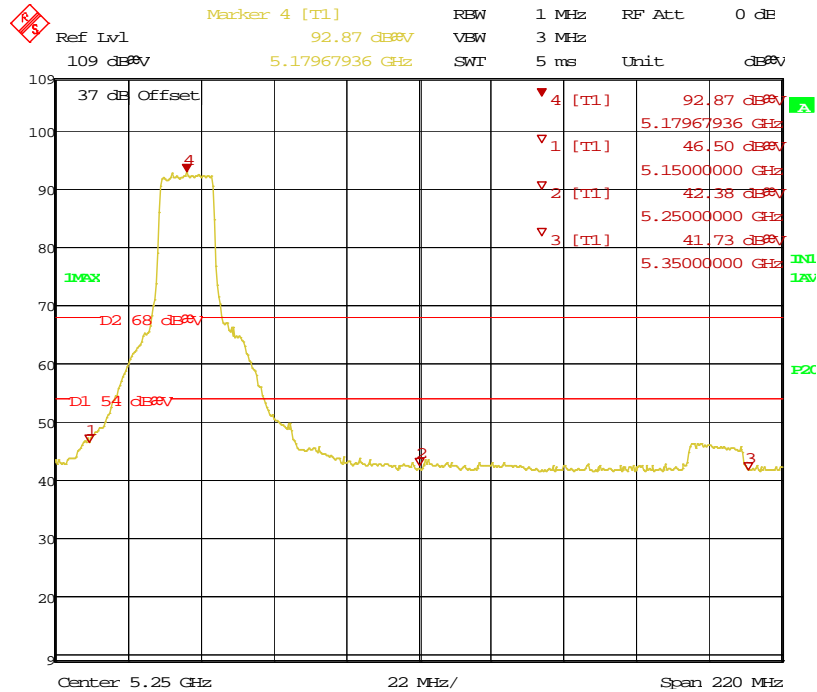

Date: 2.MAR.2015 14:32:06

Figure 11: Bandedge-5180 MHz-11a-H-Ave

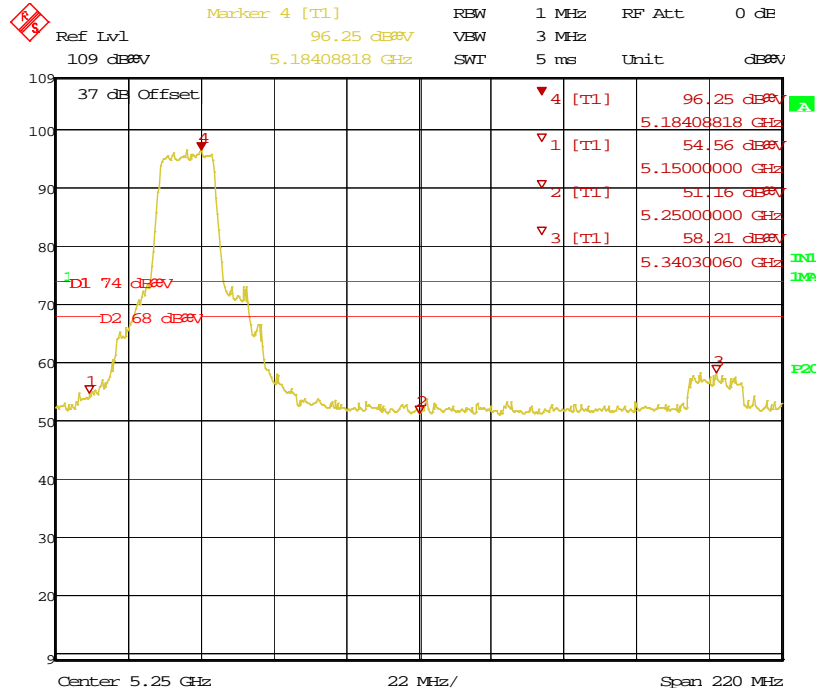

Date: 2.MAR.2015 14:34:08

Figure 12: Bandedge-5180 MHz-11a-V-pk

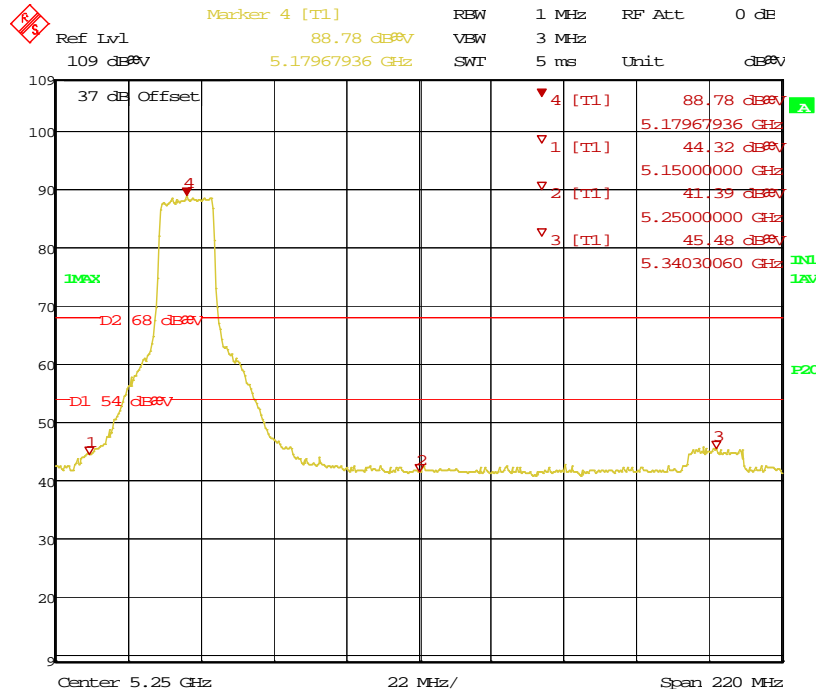

Date: 2.MAR.2015 14:34:40

Figure 13: Bandedge-5180 MHz-11a-V-Ave

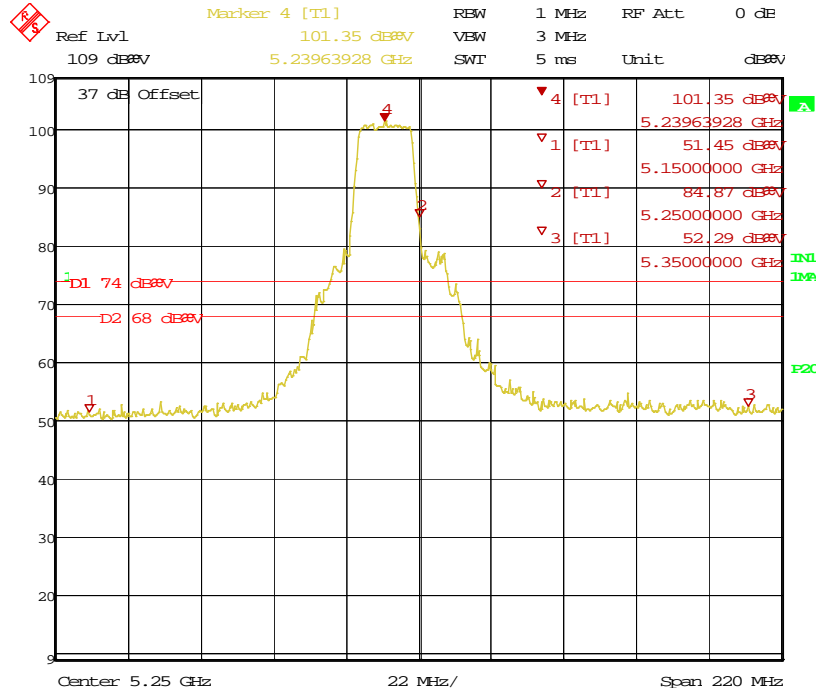

Date: 2.MAR.2015 14:24:33

Figure 14: Bandedge-5240 MHz-11a-H-Pk

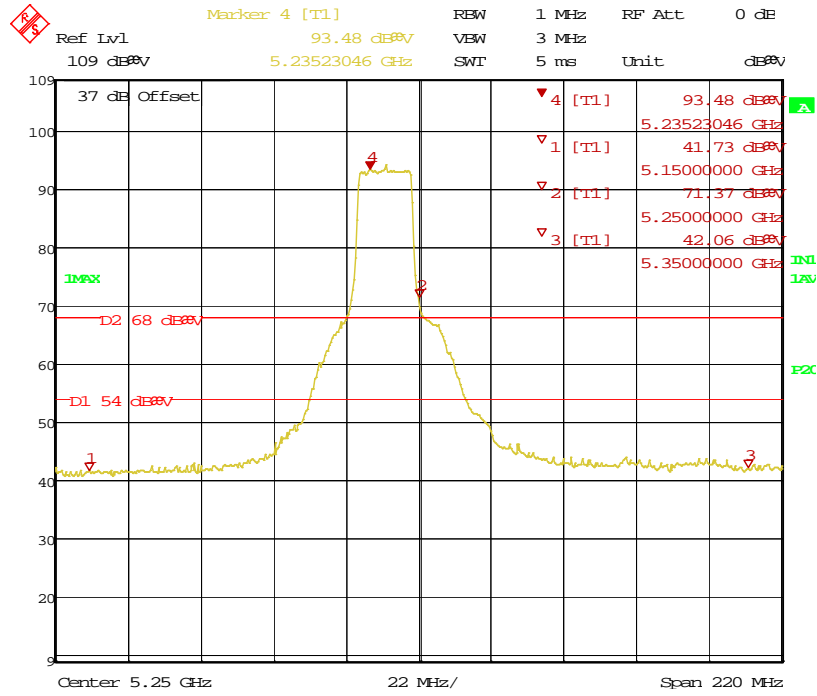

Date: 2.MAR.2015 14:24:59

Figure 15: Bandedge-5240 MHz-11a-H-Ave



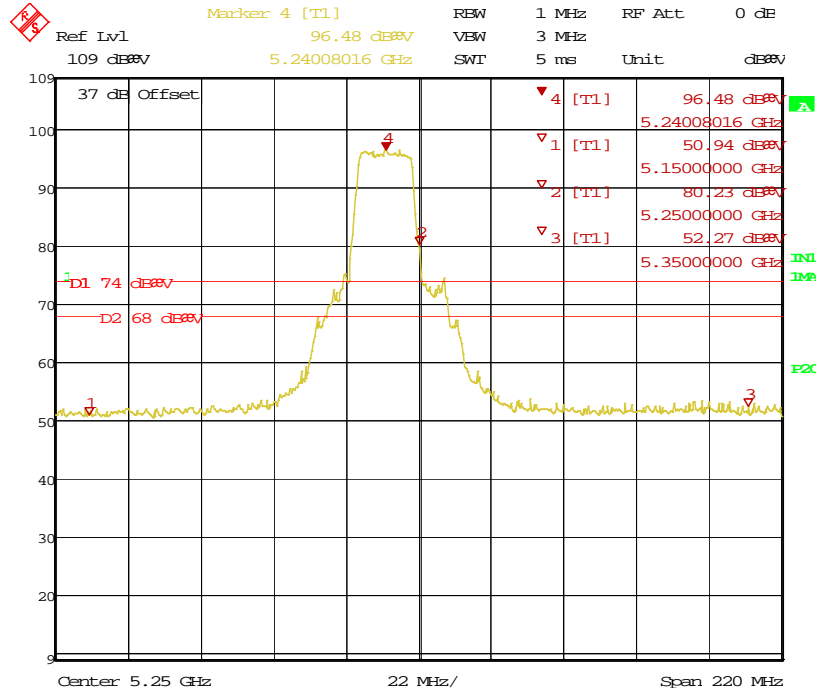

Date: 2.MAR.2015 14:26:25

Figure 16: Bandedge-5240 MHz-11a-V-Pk

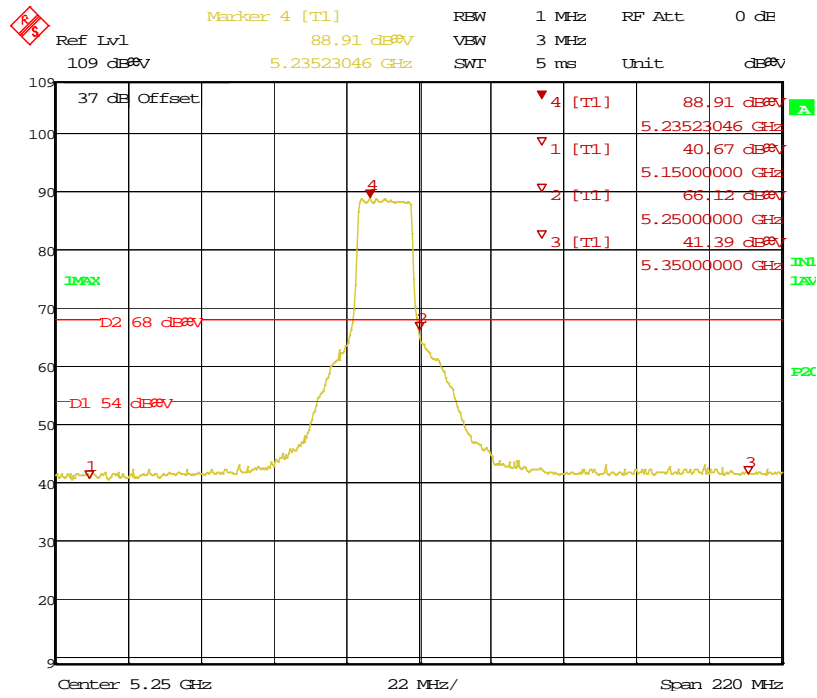

Date: 2.MAR.2015 14:26:43

Figure 17: Bandedge-5240 MHz-V-Ave

SOP 1 Radiated Emissions											Tracking # 31560639.001 Page 1 of 9	
<b>EUT Name</b>		Wireless Audio Transmitter					<b>Date</b>		March 3, 2015			
<b>EUT Model</b>		Elite 800X TX					<b>Temp / Hum in</b>		23° C / 32%rh			
<b>EUT Serial</b>		PP#2					<b>Temp / Hum out</b>		N/A			
<b>EUT Config.</b>		802.11a on X-Axis (30 MHz-1GHz)					<b>Line AC / Freq</b>		5.0 VDC			
<b>Standard</b>		CFR47 Part 15 Subpart C					<b>RBW / VBW</b>		120 kHz/ 300 kHz			
<b>Dist/Ant Used</b>		3m / JB3					<b>Performed by</b>		Jeremy Luong			
Freq.	Raw	Cbl	AF	Level	Det.	Pol.	Hght.	Azt	Limit	Margin	Result	
MHz	dBuV/m	dB	dB	dBuV/m		H/V	cm	deg	dBuV/m	dB		
Transmitted Data at 802.11a, 5240 MHz												
47.88	48.85	2.76	-23.16	28.46	Pk	V	150	342	40.00	-11.54	Pass	
479.84	44.21	4.63	-14.94	33.90	Pk	V	150	178	46.00	-12.10	Pass	
492.27	42.69	4.66	-14.85	32.50	Pk	V	150	33	46.00	-13.50	Pass	
504.09	42.30	4.70	-14.94	32.06	Pk	V	150	292	46.00	-13.94	Pass	
494.08	40.78	4.67	-14.86	30.60	Pk	V	150	305	46.00	-15.40	Pass	
552.59	39.95	4.85	-14.29	30.50	Pk	H	150	258	46.00	-15.50	Pass	
528.03	40.24	4.77	-14.59	30.42	Pk	V	150	64	46.00	-15.58	Pass	
Spec Margin = Level - Limit, Level = Raw+ Cbl+ CF ± Uncertainty												
CF= Amp Gain + ANT Factor												
Combined Standard Uncertainty $u_c(y) = \pm 4.52$ dB Expanded Uncertainty $U = k u_c(y)$ $k = 2$ for 95% confidence												
<b>Note:</b> All other emissions passed Class B limit.												

**SOP 1 Radiated Emissions**

Tracking # 31560639.001 Page 2 of 8

<b>EUT Name</b>	Wireless Audio Transmitter	<b>Date</b>	March 3, 2015
<b>EUT Model</b>	Elite 800X TX	<b>Temp / Hum in</b>	23° C / 32%rh
<b>EUT Serial</b>	PP#2	<b>Temp / Hum out</b>	N/A
<b>EUT Config.</b>	802.11a on X-Axis	<b>Line AC / Freq</b>	5.0 VDC
<b>Standard</b>	CFR47 Part 15 Subpart C	<b>RBW / VBW</b>	120 kHz/ 300 kHz
<b>Dist/Ant Used</b>	3m / JB3	<b>Performed by</b>	Jeremy Luong

30 MHz to 1GHz Plots for Transmit Mode at 5240 MHz

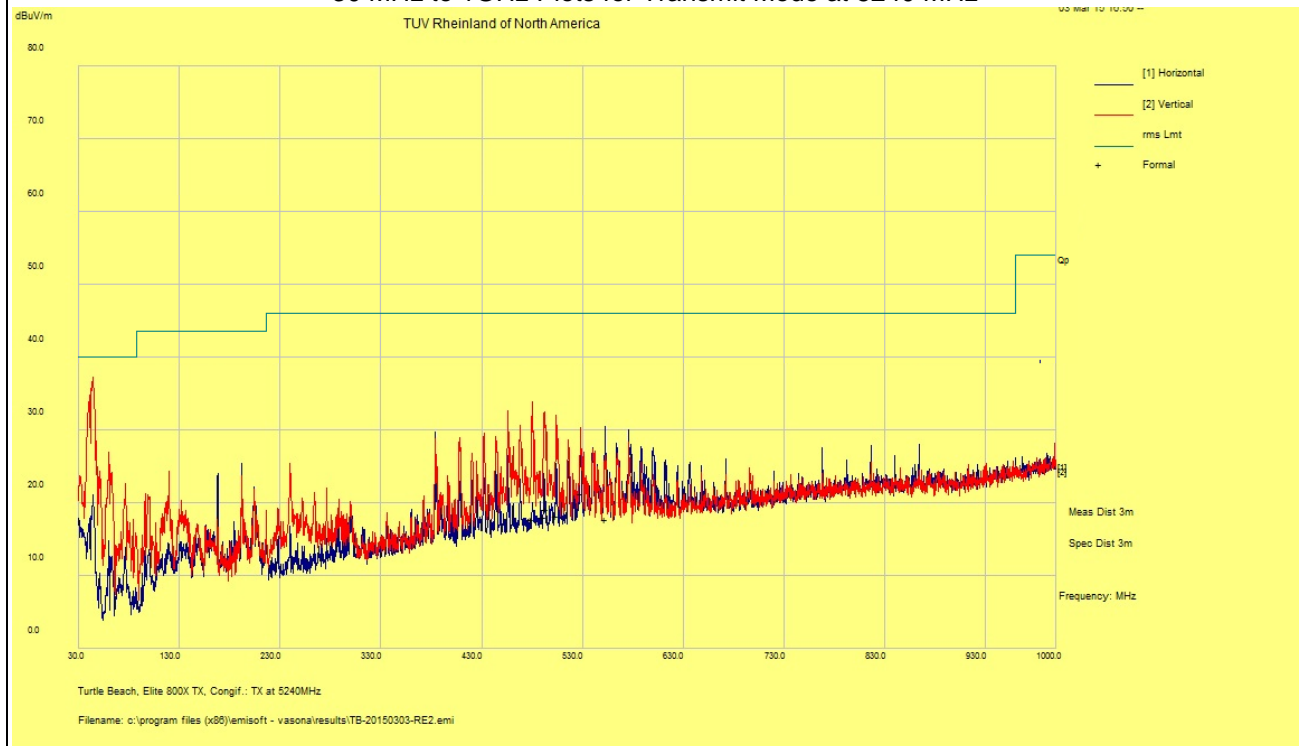

Notes: FCC Class B Limit.

SOP 1 Radiated Emissions											Tracking # 31560639.001 Page 3 of 9	
<b>EUT Name</b>		Wireless Audio Transmitter						<b>Date</b>		March 2, 2015		
<b>EUT Model</b>		Elite 800X TX						<b>Temp / Hum in</b>		23° C / 32%rh		
<b>EUT Serial</b>		PP#2						<b>Temp / Hum out</b>		N/A		
<b>EUT Config.</b>		802.11a on X-Axis						<b>Line AC / Freq</b>		5.0 Vdc		
<b>Standard</b>		CFR47 Part 15 Subpart C						<b>RBW / VBW</b>		1 MHz/ 3 MHz		
<b>Dist/Ant Used</b>		3m / EMCO3115 / 1m - RA42-K-F-4B-C						<b>Performed by</b>		Jeremy Luong		
Freq	Raw	Cbl	AF	Level	Det	Pol	Hght	Azt	Limit	Margin	Comment	
MHz	dBuV/m	dB	dB	dBuV/m		H/V	cm	deg	dBuV/m	dB		
Transmitted Data at 5180 MHz at 802.11a, 6Mbit/s												
6906.47	54.26	2.16	-13.10	43.31	Ave	H	244	-8	54.00	-10.69	Spurious	
10359.57	41.00	2.80	-8.60	35.20	Ave	H	141	125	54.00	-18.80	Harmonics	
Transmitted Data at 5200 MHz at 802.11a, 6Mbit/s												
6933.22	53.30	2.20	-13.00	42.50	Ave	H	124	349	54.00	-11.50	Spurious	
10401.40	39.00	2.80	-8.70	33.10	Ave	H	158	8	54.00	-20.90	Harmonics	
Transmitted Data at 5240 MHz at 802.11a, 6Mbit/s												
6986.48	54.60	2.20	-12.80	44.00	Ave	H	128	14	54.00	-10.00	Spurious	
10483.00	40.30	2.80	-8.90	34.30	Ave	V	186	357	54.00	-19.70	Harmonics	
15725.79	40.90	3.50	-9.70	34.70	Ave	V	236	332	54.00	-19.30	Spurious	
Spec Margin = Level - Limit, Level = Raw+ Cbl+ CF ± Uncertainty												
CF= Amp Gain + ANT Factor												
Combined Standard Uncertainty $u_c(y) = \pm 4.93\text{dB}$ Expanded Uncertainty $U = k u_c(y)$ $k = 2$ for 95% confidence												
Notes: All emissions passed the spurious emission limit. No significant emission was observed from 18GHz to 40GHz.												

**SOP 1 Radiated Emissions**

Tracking # 31560639.001 Page 4 of 9

<b>EUT Name</b>	Wireless Audio Transmitter	<b>Date</b>	March 2, 2015
<b>EUT Model</b>	Elite 800X TX	<b>Temp / Hum in</b>	23° C / 32%rh
<b>EUT Serial</b>	PP#2	<b>Temp / Hum out</b>	N/A
<b>EUT Config.</b>	802.11a on X-Axis	<b>Line AC</b>	5.0 VDC
<b>Standard</b>	CFR47 Part 15 Subpart C	<b>RBW / VBW</b>	1 MHz / 3 MHz
<b>Dist/Ant Used</b>	3m - EMCO3115 / 1m - RA42-K-F-4B-C	<b>Performed by</b>	Jeremy Luong

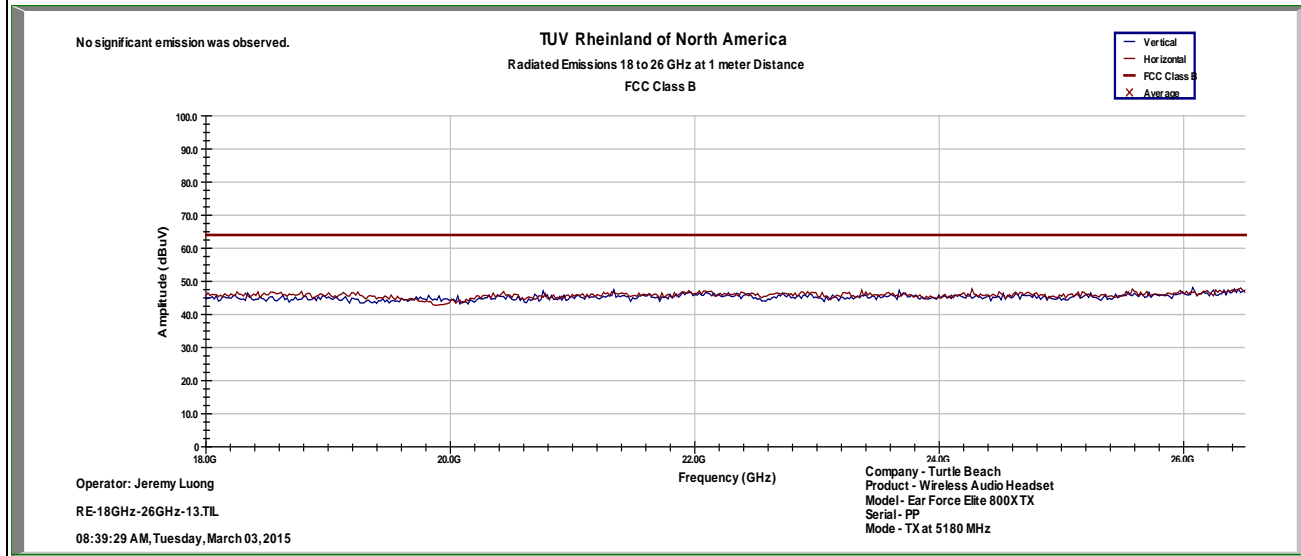
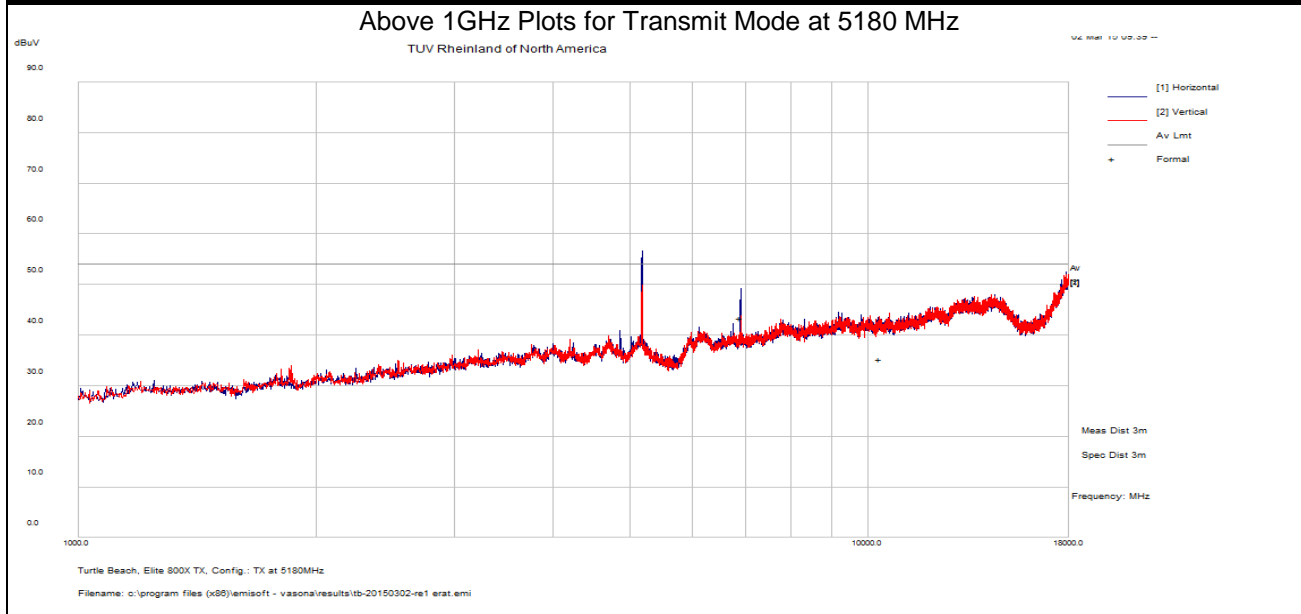

Notes: Limit was extrapolated to 1m distance for 18 GHz – 40 GHz range.

**SOP 1 Radiated Emissions**

Tracking # 31560639.001 Page 5 of 9

<b>EUT Name</b>	Wireless Audio Transmitter	<b>Date</b>	March 3, 2015
<b>EUT Model</b>	Elite 800X TX	<b>Temp / Hum in</b>	23° C / 32%rh
<b>EUT Serial</b>	PP#2	<b>Temp / Hum out</b>	N/A
<b>EUT Config.</b>	802.11a on X-Axis	<b>Line AC / Freq</b>	5.0 VDC
<b>Standard</b>	CFR47 Part 15 Subpart C	<b>RBW / VBW</b>	1 MHz / 3 MHz
<b>Dist/Ant Used</b>	1m - RA42-K-F-4B-C	<b>Performed by</b>	Jeremy Luong

Above 1GHz Plots for Transmit Mode at 5180 MHz

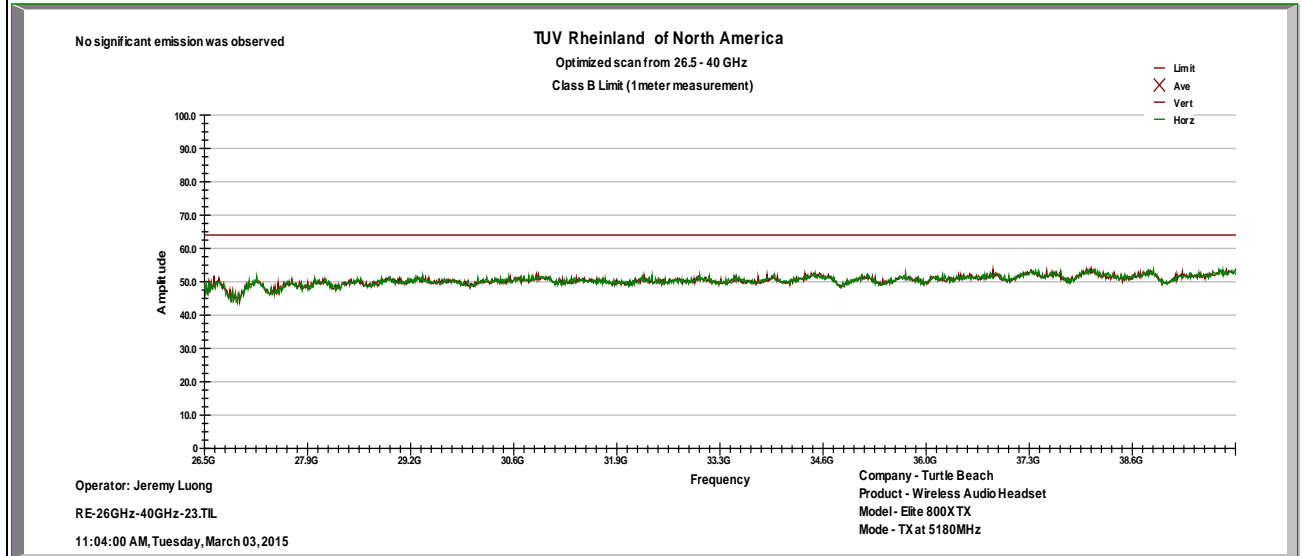

Notes: Limit was extrapolated to 1m distance for 18 GHz – 40 GHz range.

**SOP 1 Radiated Emissions**

Tracking # 31560639.001 Page 6 of 9

<b>EUT Name</b>	Wireless Audio Transmitter	<b>Date</b>	March 2, 2015
<b>EUT Model</b>	Elite 800X TX	<b>Temp / Hum in</b>	23° C / 32%rh
<b>EUT Serial</b>	PP#2	<b>Temp / Hum out</b>	N/A
<b>EUT Config.</b>	802.11a on X-Axis	<b>Line AC / Freq</b>	5.0 VDC
<b>Standard</b>	CFR47 Part 15 Subpart C	<b>RBW / VBW</b>	1 MHz / 3 MHz
<b>Dist/Ant Used</b>	3m - EMCO3115 / 1m - RA42-K-F-4B-C	<b>Performed by</b>	Jeremy Luong

Above 1GHz Plots for Transmit Mode at 5200 MHz

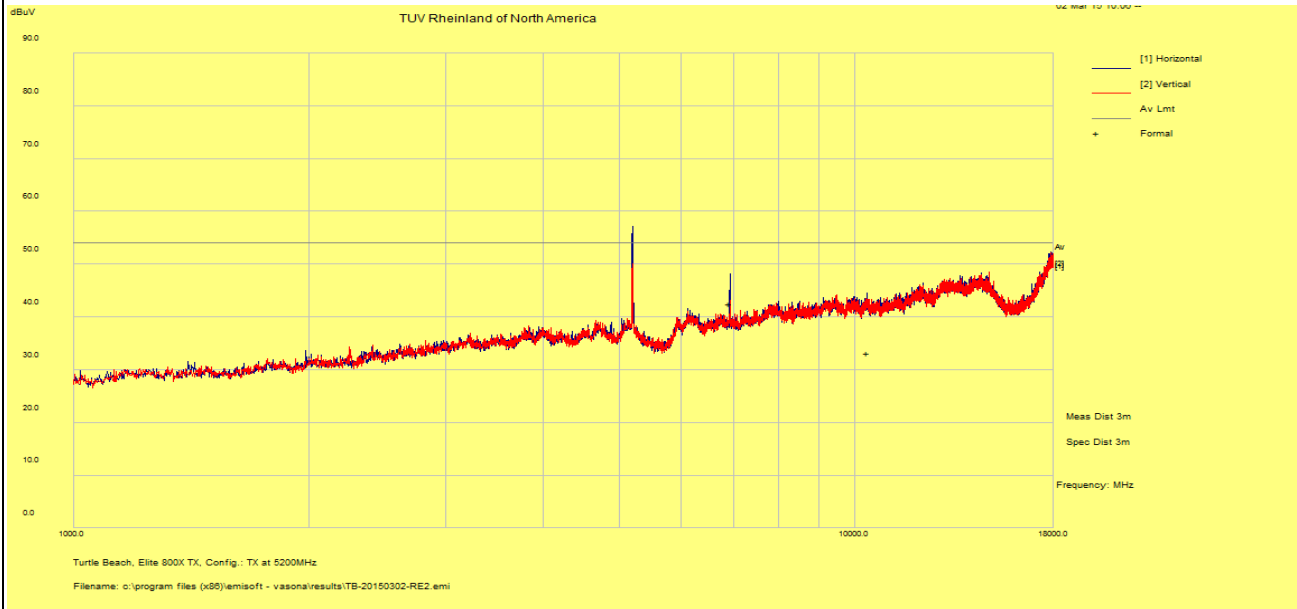

No significant emission was observed.

TUV Rheinland of North America  
 Radiated Emissions 18 to 26 GHz at 1 meter Distance  
 FCC Class B

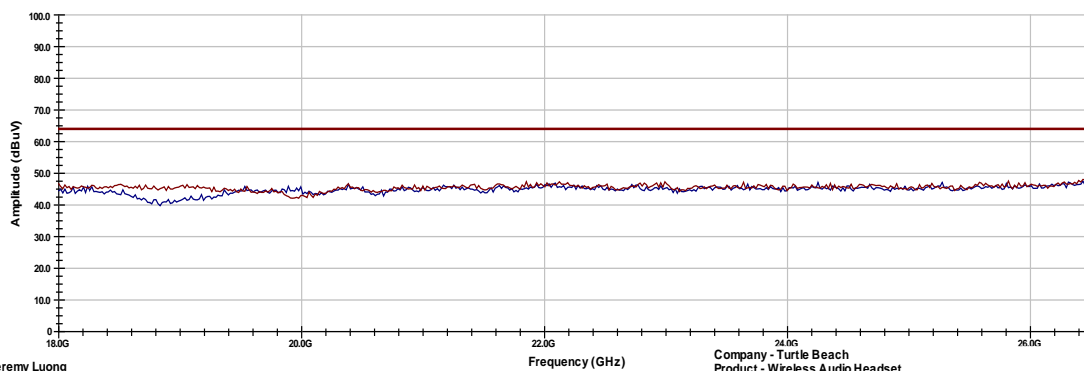

Operator: Jeremy Luong

RE-18GHz-26GHz-14.TL

08:50:19 AM, Tuesday, March 03, 2015

Company - Turtle Beach  
 Product - Wireless Audio Headset  
 Model - Ear Force Elite 800XTX  
 Serial - PP  
 Mode - TX at 5200 MHz

Notes: Limit was extrapolated to 1m distance for 18 GHz – 40 GHz range.

**SOP 1 Radiated Emissions**

Tracking # 31560639.001 Page 7 of 9

<b>EUT Name</b>	Wireless Audio Transmitter	<b>Date</b>	March 3, 2015
<b>EUT Model</b>	Elite 800X TX	<b>Temp / Hum in</b>	23° C / 32%rh
<b>EUT Serial</b>	PP#2	<b>Temp / Hum out</b>	N/A
<b>EUT Config.</b>	802.11a on X-Axis	<b>Line AC / Freq</b>	5.0 VDC
<b>Standard</b>	CFR47 Part 15 Subpart C	<b>RBW / VBW</b>	1 MHz / 3 MHz
<b>Dist/Ant Used</b>	1m - RA42-K-F-4B-C	<b>Performed by</b>	Jeremy Luong

Above 1GHz Plots for Transmit Mode at 5200 MHz

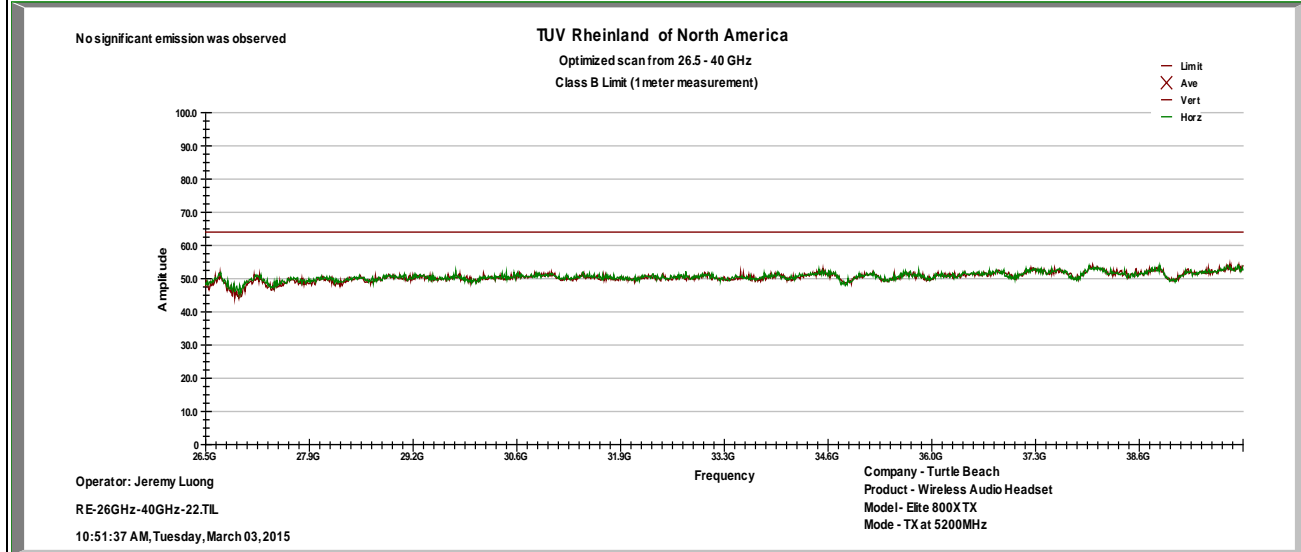

Notes: Limit was extrapolated to 1m distance for 18 GHz – 40 GHz range.



**SOP 1 Radiated Emissions**

Tracking # 31560639.001 Page 8 of 9

<b>EUT Name</b>	Wireless Audio Transmitter	<b>Date</b>	March 2, 2015
<b>EUT Model</b>	Elite 800X TX	<b>Temp / Hum in</b>	23° C / 32%rh
<b>EUT Serial</b>	PP#2	<b>Temp / Hum out</b>	N/A
<b>EUT Config.</b>	802.11a on X-Axis	<b>Line AC / Freq</b>	5.0 VDC
<b>Standard</b>	CFR47 Part 15 Subpart C	<b>RBW / VBW</b>	1 MHz / 3 MHz
<b>Dist/Ant Used</b>	3m - EMCO3115 / 1m - RA42-K-F-4B-C	<b>Performed by</b>	Jeremy Luong

Above 1GHz Plots for Transmit Mode at 5240 MHz

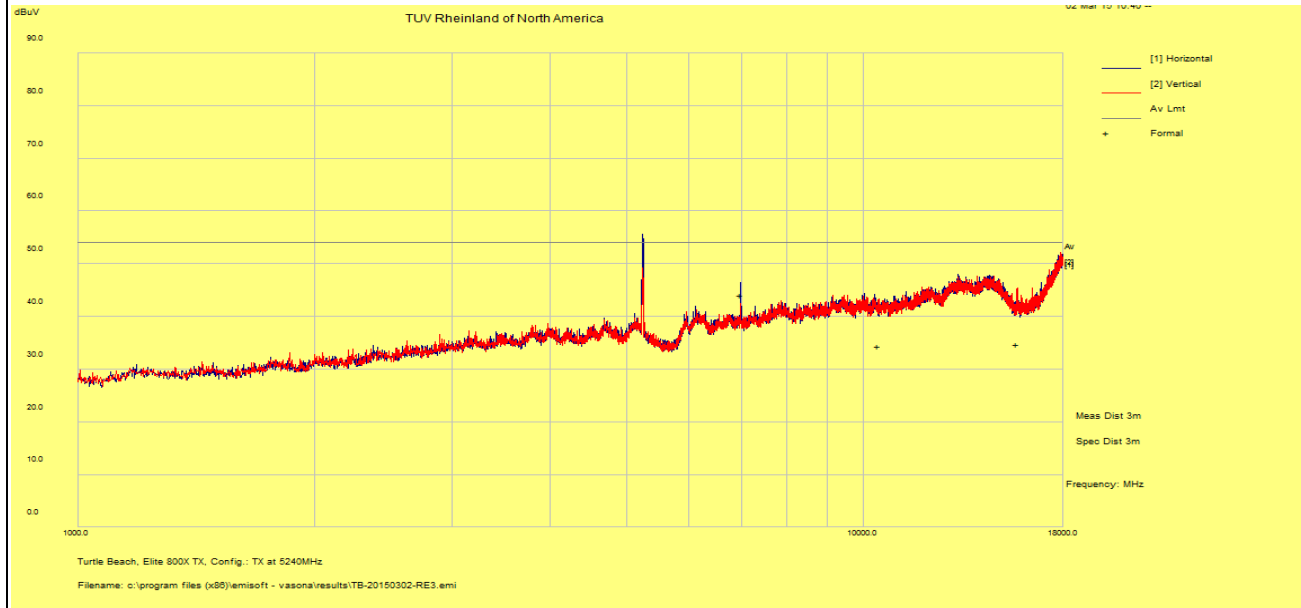

No significant emission was observed.

TUV Rheinland of North America  
 Radiated Emissions 18 to 26 GHz at 1 meter Distance  
 FCC Class B

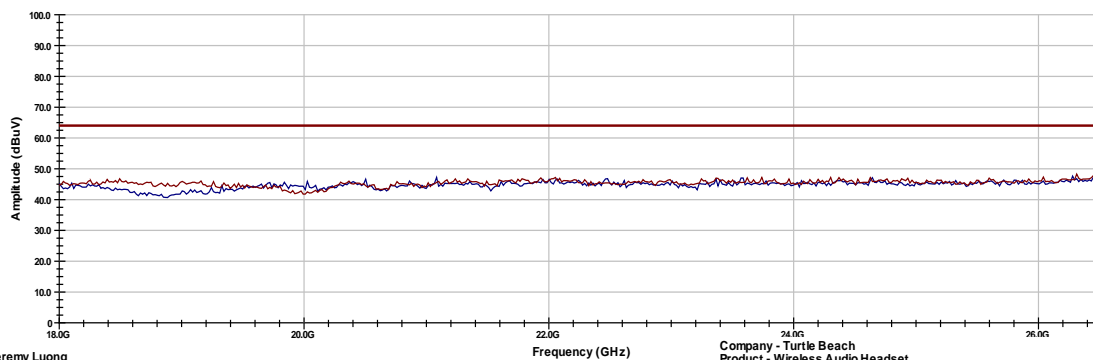

Notes: Limit was extrapolated to 1m distance for 18 GHz – 40 GHz range.

**SOP 1 Radiated Emissions**

Tracking # 31560639.001 Page 9 of 9

<b>EUT Name</b>	Wireless Audio Transmitter	<b>Date</b>	March 3, 2015
<b>EUT Model</b>	Elite 800X TX	<b>Temp / Hum in</b>	23° C / 32%rh
<b>EUT Serial</b>	PP#2	<b>Temp / Hum out</b>	N/A
<b>EUT Config.</b>	802.11a on X-Axis	<b>Line AC / Freq</b>	5.0 VDC
<b>Standard</b>	CFR47 Part 15 Subpart C	<b>RBW / VBW</b>	1 MHz / 3 MHz
<b>Dist/Ant Used</b>	1m - RA42-K-F-4B-C	<b>Performed by</b>	Jeremy Luong

Above 1GHz Plots for Transmit Mode at 5240 MHz

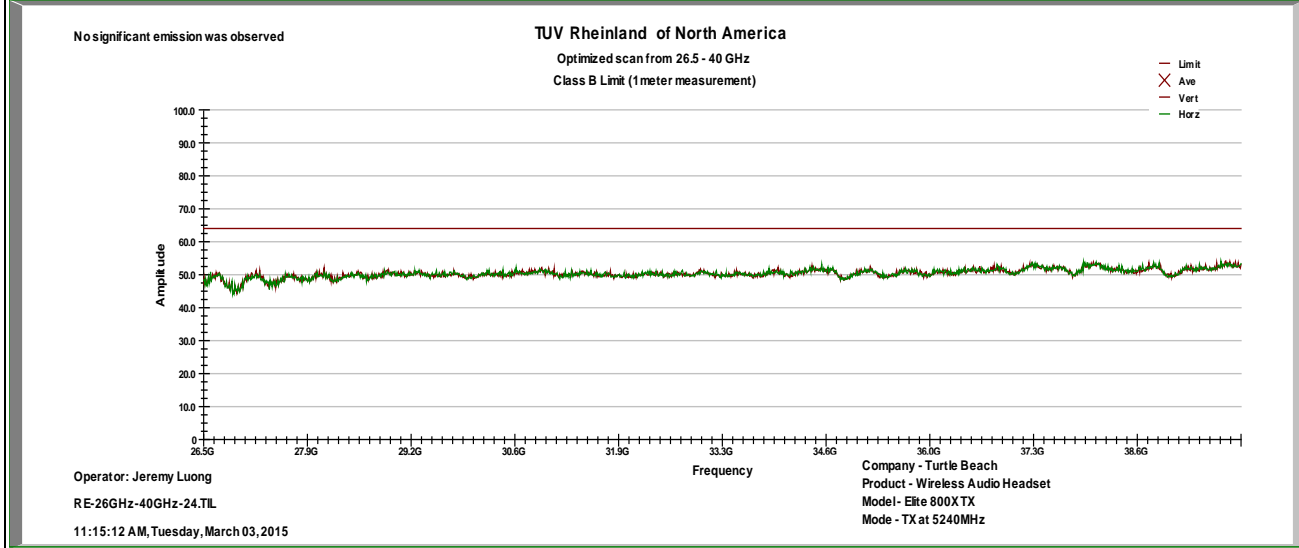

Notes: Limit was extrapolated to 1m distance for 18 GHz – 40 GHz range.

**4.4.4 Sample Calculation**

The field strength is calculated by subtracting the Amplifier Gain and adding the Cable Loss and Antenna Correction Factor to the measured reading. The basic equation is as follows:

$$\text{Level (dB}\mu\text{V/m)} = \text{Raw} - \text{AMP} + \text{CBL} + \text{ACF}$$

- Where: Raw = Field Intensity Meter (dBμV)
- AMP = Amplifier Gain (dB)
- CBL = Cable Loss (dB)
- ACF = Antenna Correction Factor (dB/m)

$$\mu\text{V/m} = 10^{\frac{\text{dB}\mu\text{V} / \text{m}}{20}}$$

---

## **4.5 AC Conducted Emissions**

Testing was performed in accordance with ANSI C63.4: 2010. These test methods are listed under the laboratory's A2LA Scope of Accreditation.

This test measures the levels emanating from the EUT's AC input port, thus evaluating the potential for the EUT to cause radio frequency interference to other electronic devices.

The AC conducted emissions of equipment under test shall not exceed the values in CFR47 Part 15.207: 2013 and RSS-210: 2010.

### **4.5.1 Test Methodology**

A test program that controls instrumentation and data logging was used to automate the AC Power Line Conducted emission test procedure. The frequency range of interest was divided into sub-ranges such as to yield a frequency resolution of 9 kHz. Each phase and neutral of the AC power line were measured with respect to ground. Measurements were performed using a set of 50 $\mu$ H / 50 $\Omega$  LISNs.

Testing is either performed in Lab 2. The setup photographs clearly identify which site was used. The vertical ground plane used in the semi-anechoic chamber is a 2m x 2m solid aluminum frame and panel, and it is bonded to the horizontal ground plane.

In the case of tabletop equipment, the EUT is placed on a 1.0m x 1.5m non-conductive table 80cm above the ground plane and 40cm from a vertical ground reference plane. The rear of the EUT was positioned flush with the backside of the table and directly over the LISNs. The power and I/O cables were routed over the edge of the table and bundled approximately 40cm from the ground plane. Support equipment was powered from a separate LISN.

#### **4.5.1.1 Deviations**

There were no deviations from this test methodology.

### **4.5.2 Test Results**

The Elite 800X TX is powered by 5.0 VDC via a host USB port. The AC conducted emission is not required.

---

## 4.6 Frequency Stability

In accordance with 47 CFR Part 15.407(g) the frequency stability of U-NII devices must be such that an emission is maintained within the band of operation under all conditions of normal operation as specified in the user's manual. The Manufacturer calls out operating temperature ranges of +0° to +50° C

### 4.6.1 Test Methodology

The manufacturer of the equipment is responsible for ensuring that the frequency stability is such that emissions are always maintained within the band of operation under all conditions. This test performs according to ANSI C63.10-2009 Section 6.8

### 4.6.2 Manufacturer Declaration

The frequency stability of the reference oscillator sets the frequency stability of the RF transceiver signals. Therefore all of the RF signal should have  $\pm 20$ ppm stability.

This stability accounts for room temp tolerance of the crystal oscillator circuit, frequency variation across temperature, and crystal ageing.

Worst case:

5GHz -  $\pm 20$ ppm/103 kHz

$\pm 20$ ppm at 5 GHz translates to a maximum frequency shift of  $\pm 103$  kHz. As the edge of the channels are at least one MHz from either of the band edges,  $\pm 103$  kHz is more than sufficient to guarantee that the intentional emission will remain in the band over the entire operating range of the radio.

### 4.6.3 Limit

CFR47 Part 407(g) - Manufacturers of U-NII devices are responsible for ensuring frequency stability such that an emission is maintained within the band of operation under all conditions of normal operation as specified in the user's manual.

### 4.6.4 Test results

As originally tested, the EUT was found to be compliant to the requirements of the test standard(s) since the maximum frequency drift was 12.67 ppm.

**Table 6: Frequency Stability – Test Results**

Temperature	Time	PPM
0° C	Start	3.173077
	2 Min.	8.653846
	5 Min	3.173077
	10 min	7.211538
10° C	Start	0.865385
	2 Min.	0.865385
	5 Min	2.019231
	10 min	3.173077
20° C	Start	0.576923
	2 Min.	1.730769
	5 Min	11.25
	10 min	1.442308
30° C	Start	8.653846
	2 Min.	11.53846
	5 Min	8.942308
	10 min	8.942308
40° C	Start	9.230769
	2 Min.	13.84615
	5 Min	10.38462
	10 min	15.86538
50° C	Start	5.192308
	2 Min.	17.01923
	5 Min	13.84615
	10 min	8.942308

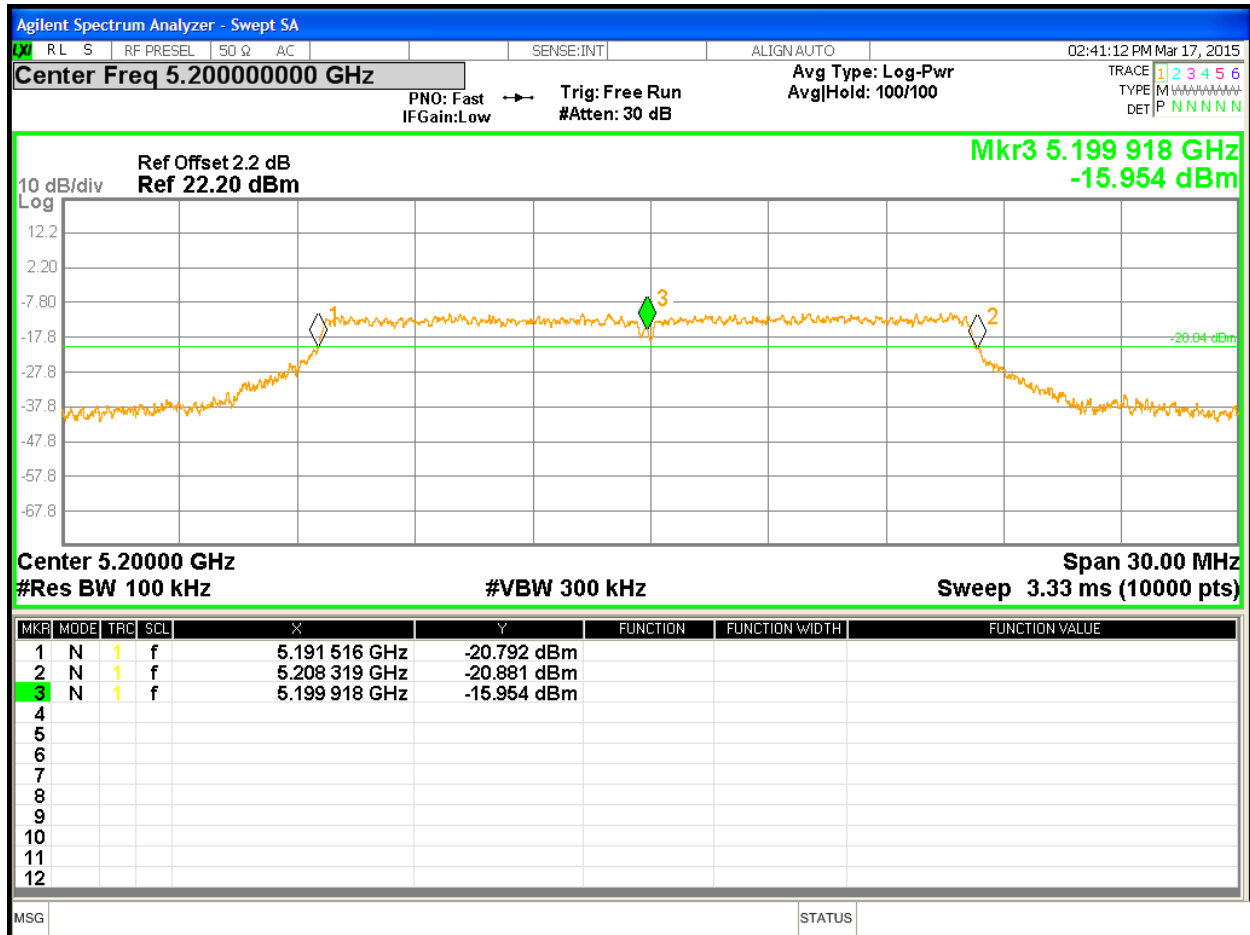

Figure 18: Frequency Stability – Worst Case

## 4.7 Voltage Variation

In accordance with 47 CFR Part 15.31 (e) intentional radiators, measurements of the variation of the input power or the radiated signal level of the fundamental frequency component of the emission, as appropriate, shall be performed with the supply voltage varied between 85% and 115% of the nominal rated supply voltage. For battery operated equipment, the equipment tests shall be performed using a new battery.

### 4.7.1 Test Methodology

The dc supply voltage was varied between 85% and 115% of the nominal rated supply voltage. The fundamental frequency was observed during the variation. The EUT was powered by 5.0 Vdc by a programmable power supply. The voltage was varied from 4.25 Vdc to 5.75 Vdc mean while the fundamental frequencies were observed and record for the maximum drift in ppm; part per millions.

### 4.7.2 Test results

As originally tested, the EUT was found to be compliant to the requirements of the test standard(s). The fundamental frequencies drifted less than  $\pm 20$ ppm.

**Table 7:** Voltage Variation – Test Results

Frequency MHz	Nominal (5Vdc) ppm	Lo Voltage (4.25Vdc) Ppm	Hi Voltage (5.75Vdc) ppm	Max Drift ppm
5200	19.61538	14.13462	15.57692	19.61538

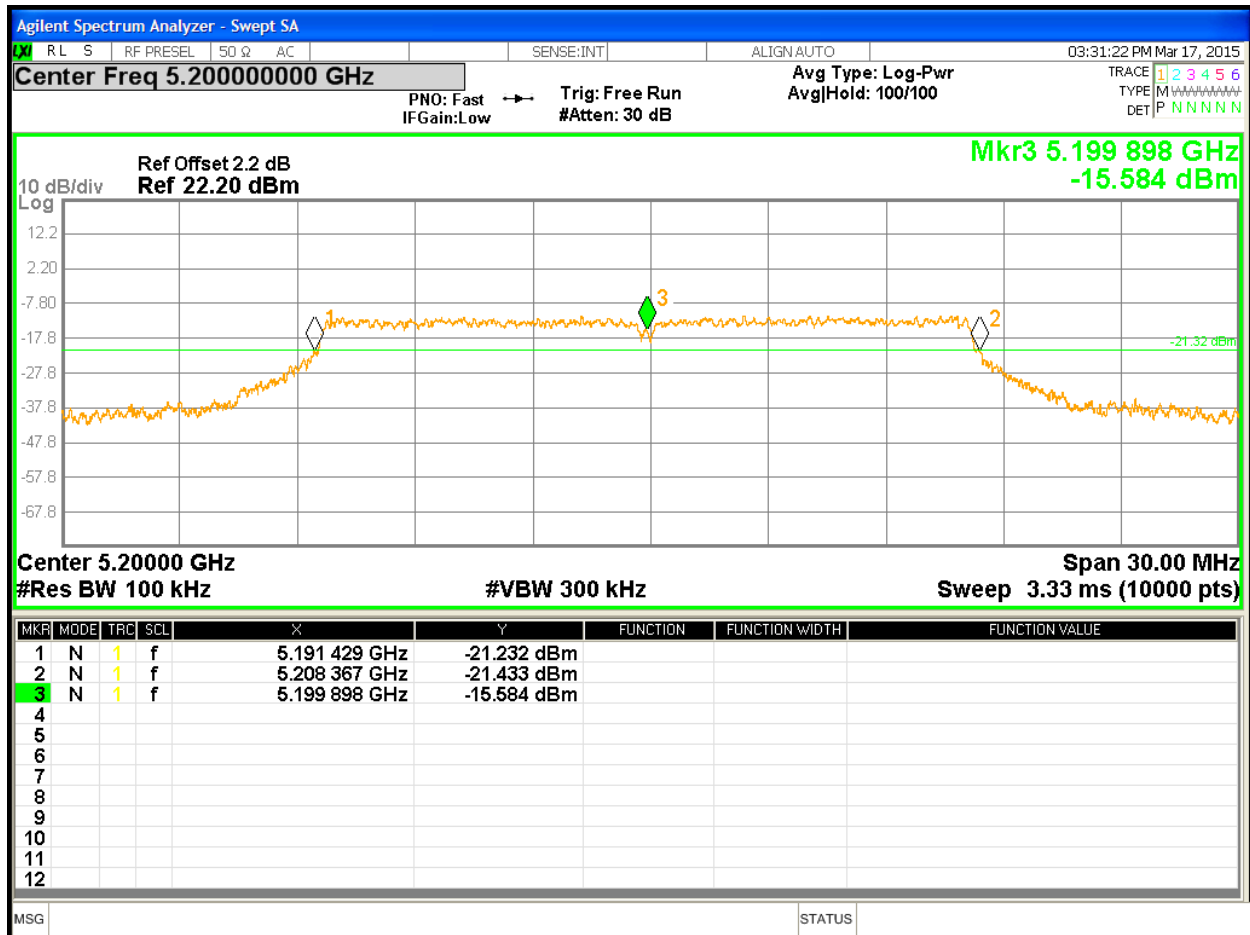

Figure 19: Voltage Variation – Worst Case



## 4.8 Maximum Permissible Exposure

### 4.8.1 Test Methodology

In this document, we try to prove the safety of radiation harmfulness to the human body for our product. The limit for Maximum Permissible Exposure (MPE) specified in FCC 1.1310 is followed. The Gain of the antenna used in this calculation is declared by the manufacturer, and the maximum total power input to the antenna is measured. Through the Friis transmission formula and the maximum gain of the antenna, we can calculate the distance, away from the product, where the limit of MPE is reached.

Although the Friis transmission formula is a far field assumption, the calculated result of that is an over-prediction for near field power density. We will take that as the worst case to specify the safety range.

### 4.8.2 RF Exposure Limit

According to FCC 1.1310 table 1: The criteria listed in the following table shall be used to evaluate the environmental impact of human exposure to radio-frequency (RF) radiation as specified in 1.1307(b)

LIMITS FOR MAXIMUM PERMISSIBLE EXPOSURE (MPE)

Frequency Range (MHz)	Electric Field Strength (V/m)	Magnetic Field Strength (A/m)	Power Density (mW/cm <sup>2</sup> )	Average Time (minutes)
<b>(A)Limits For Occupational / Control Exposures</b>				
0.3–3.0	614	1.63	*(100)	6
3.0–30	1842/f	4.89/f	*(900/f <sup>2</sup> )	6
30–300	...	...	1.0	6
300 - 1500	...	...	f/300	6
1500 - 100,000	...	...	5	6
<b>(B)Limits For General Population / Uncontrolled Exposure</b>				
0.3–1.34	614	1.63	*(100)	30
1.34-30	824/f	2.19/f	*(180/ f <sup>2</sup> )	30
30–300	27.5	0.037	0.2	30
300 - 1500	...	...	f/1500	30
1500 - 100,000	...	...	1.0	30

F = Frequency in MHz

\* = Plane-wave equivalent power density

### 4.8.3 EUT Operating Condition

The software provided by Manufacturer enabled the EUT to transmit data at lowest, middle and highest channel individually.

### 4.8.4 Classification

The antenna of the product, under normal use condition, is at least 20cm away from the body of the user. Warning statement to the user for keeping at least 20cm or more separation distance with the antenna should be included in user's manual. So, this device is classified as a **Mobile Device**.

### 4.8.5 Test Results

#### 4.8.5.1 Antenna Gain

The transmitting antennas were integrated. The directional antenna gain was +3.5 dBi or 2.24 (numeric).

#### 4.8.5.2 Output Power into Antenna & RF Exposure value at distance 20cm:

Calculations for this report are based on highest power measurement.

Limit for MPE (from FCC part 1.1310 table1) is 1.0 mW/cm<sup>2</sup>

The highest measured total power is +6.81 dBm or 4.797mW

Using the Friss transmission formula, the EIRP is Pout\*G, and R is 20cm.

$P_d = (4797 * 2.24) / (1600\pi) = 0.021087 \text{ mW/cm}^2$ , which is 0.97891 mW/cm<sup>2</sup> below to the limit.

As originally tested, the EUT was found to be compliant to the requirements of the test standard(s).

### 4.8.6 Sample Calculation

The Friss transmission formula:  $P_d = (P_{out} * G) / (4 * \pi * R^2)$

Where;

$P_d$  = power density in mW/cm<sup>2</sup>

$P_{out}$  = output power to antenna in mW

$G$  = gain of antenna in linear scale

$\pi \approx 3.1416$

$R$  = distance between observation point and center of the radiator in cm

Ref.: David K. Cheng, *Field and Wave Electromagnetics*, Second Edition, Page 640, Eq. (11-133).

## 6 Test Equipment Use List

### 6.1 Equipment List

Equipment	Manufacturer	Model #	Serial/Inst #	Last Cal mm/dd/yyyy	Next Cal mm/dd/yyyy
Bilog Antenna	Sunol Sciences	JB3	A102606	07/08/2014	07/08/2016
Bilog Antenna	Sunol Sciences	JB3	A020502	04/12/2013	04/12/2015
Horn Antenna	EMCO	3115	9710-5301	09/04/2013	09/04/2015
Horn Antenna	EMCO	3115	9211-3969	03/18/2013	04/18/2015
Antenna (18-26GHz)	CMT	RA42-K-F-4B-C	020131-004	07/24/2014	07/24/2015
Spectrum Analyzer	Rohde & Schwarz	FSL6	100169	01/13/2015	01/13/2016
Spectrum Analyzer	Agilent	N9038A	MY51210195	01/12/2015	01/12/2016
Spectrum Analyzer	Agilent	N9030A	MY51380689	01/19/2015	01/19/2016
Spectrum Analyzer	Rohde Schwarz	ESIB	832427/002	01/13/2015	01/13/2016
Spectrum Analyzer	Rohde Schwarz	FSV40	1321.3008K40	11/01/2015	11/01/2016
Amplifier	Sonoma Instruments	310	213221	09/30/2014	09/30/2015
Amplifier	Miteq	TTA1800-30-4G	1842452	01/13/2015	01/13/2016
Amplifier	Rohde & Schwarz	TS-PR26	100011	07/24/2014	07/24/2016
Amplifier	Rohde & Schwarz	TS-PR40	100012	02/21/2015	02/21/2016
Power Meter	Agilent	E4418B	MY45103902	01/15/2015	01/15/2016
Power Sensor	Hewlett Packard	8482A	US37295801	01/15/2015	01/15/2016
Thermometer	Fluke	52II	96480032	06/28/2014	06/28/2015
Thermo Chamber	Espec	BTZ-133	0613436	03/16/2015	03/16/2016
DC Power Supply	Agilent	E3634A	MY400004331	01/12/2015	01/12/2016
Notch Filter	Micro-Tronics	BRM50716	003	01/30/2015	01/30/2016
Signal Generator	Anritsu	MG3694A	42803	01/13/2015	01/13/2016
Signal Generator	Rohde & Schwarz	SMF100A	1167.0000K02	10/14/2014	10/14/2015
Signal Generator	Rohde & Schwarz	SMBV100A	1407.6004K02	12/04/2014	12/04/2015
Power Sensors	Rohde & Schwarz	OSP120	1520.9010.02	12/19/2014	12/14/2015

\* Calibration of equipment past due for re-calibration will be performed expeditiously. If any equipment is found to be out of tolerance at that time, affected customers will be notified accordingly.

## 7 EMC Test Plan

### 7.1 Introduction

This section provides a description of the Equipment Under Test (EUT), configurations, operating conditions, and performance acceptance criteria. It is an overview of information provided by the manufacturer so that the test laboratory may perform the requested testing.

### 7.2 Customer

**Table 8:** Customer Information

<b>Company Name</b>	Voyetra Turtle Beach, Inc.
<b>Address</b>	100 Summit Lake Drive, Suite 100
<b>City, State, Zip</b>	Valhalla, New York 10595
<b>Country</b>	U.S.A.

**Table 9:** Technical Contact Information

<b>Name</b>	Tim Blaney
<b>E-mail</b>	tim@commcepts.net
<b>Phone</b>	(530) 277-3482

### 7.3 Equipment Under Test (EUT)

**Table 10:** EUT Specifications

<b>EUT Specifications</b>	
Package Dimensions	165mm (6.5") x 106mm (4.18") x 318mm (1.25")
Input Voltage	5 Vdc (via host USB port)
Environment	Indoor
Operating Temperature Range:	0 to 50 degrees C
Multiple Feeds:	<input type="checkbox"/> Yes and how many <input checked="" type="checkbox"/> No
Hardware Version	PP V4.1
Part Number	39EEE9 ES2
RF Software Version	NA
802.11 Radio	
Operating Mode	802.11a
Transmitter Frequency Band	5.15 GHz to 5.25 GHz
Operating Channel	5180 MHz, 5200 MHz, 5220 MHz, 5240 MHz
Max. Power Output	6.81 dBm
Power Setting @ Operating Channel	SPW 0
Antenna Type	(1) integrated PCB antenna
Antenna Gain	Ant1 = +3.5 dBi
Modulation Type	<input type="checkbox"/> AM <input type="checkbox"/> FM <input type="checkbox"/> DSSS <input checked="" type="checkbox"/> OFDM <input type="checkbox"/> Other describe:
Data Rate	6, 9, 12, 18, 24 Mbps
Type of Equipment	<input checked="" type="checkbox"/> Table Top <input type="checkbox"/> Wall-mount <input type="checkbox"/> Floor standing cabinet <input type="checkbox"/> Other
Directional Gain Type	<input checked="" type="checkbox"/> Uncorrelated <input checked="" type="checkbox"/> Non-Beam Forming <input type="checkbox"/> Other describe:
<b>Note:</b> This report only documents the radio characteristics for 5150 – 5250 MHz band.	

**Table 11: Interface Specifications**

Interface Type	Cabled with what type of cable?	Is the cable shielded?	Maximum potential length of the cable?	Metallic (M), Coax (C), Fiber (F), or Not Applicable?
USB	USB	<input checked="" type="checkbox"/> No	<input checked="" type="checkbox"/> Metric: 1 m	<input checked="" type="checkbox"/> M
Digital In	Optical	<input checked="" type="checkbox"/> No	<input checked="" type="checkbox"/> Metric: 2 m	<input checked="" type="checkbox"/> F
Digital Out	Optical	<input checked="" type="checkbox"/> No	<input checked="" type="checkbox"/> Metric: 2 m	<input checked="" type="checkbox"/> F

**Table 12: Supported Equipment**

Equipment	Manufacturer	Model	Serial	Used for
Laptop	Dell	PP23LB	9271001233	Setup EUT operating channel
Interface Board	Turtle Beach	N.A	N.A	Access radio chipset
<b>Note:</b> None.				

**Table 13: Description of Sample used for Testing**

Device	Serial	RF Connection	CFR47 Part 15.247
Elite 800X TX	PP #2	Integrated Antenna	TX Emissions
	PP #1	Direct via SMA Connection	Peak Transmit Power, Peak Power Spectral Density, Peak Excursion Ratio Occupied Bandwidth Frequency Stability Voltage Variation

**Table 14: Description of Test Configuration used for Radiated Measurement.**

Device	Antenna	Mode	Setup Photo (X-Axis)	Setup Photo (Y-Axis)	Setup Photo (Z-Axis)
Elite 800X TX	Integrated	Transmit	EUT laid flat.	N/A	N/A
<b>Note:</b> The Elite 800X TX is designed and intended to lay flat. All emission scans performed on the X-Axis.					

**Table 15: Final Test Mode for 5150 - 5250 Bands**

Test	802.11a
Occupied Bandwidth FCC Part 15.407(a), RSS210 Sect. 9.2	5180, 5220, 5240 MHz at 6Mbps
Output Power FCC Part 15.407(a)(1)(iv), RSS210 Sect. 9.2	5180, 5220, 5240 MHz at 6Mbps
Peak Power Spectral Density FCC Part 15.407(a)(1)(iv), RSS210 Sect. 9.2	5180, 5220, 5240 MHz at 6Mbps
Band-Edge (Radiated) FCC Part 15.205, 15.209, 15.407(b)	5180, 5240 MHz at 6Mbps
Transmitted Spurious Emission (30 MHz – 1GHz) FCC Part 15.205, 15.209, 15.407(b)	5240 MHz at 6 Mbps
Transmitted Spurious Emission (Above 1GHz) FCC Part 15.205, 15.209, 15.407(b)	5180, 5200, 5240 MHz at 6Mbps
Conducted Spurious Emission (antenna port). FCC Part 15.407 (b)	According to CFR47 15.407 (b) EIPR shall not exceed -27 dBm/MHz. This is equivalent to the field strength of 68.2dBuV/m at 3 meter distance. The EUT is satisfied the requirement by meeting the limit under CFR47 Part 15.209.
AC Conducted Emission FCC Part 15.207	EUT is powered by 5.0 VDC via host USB port. Test Not required.
Frequency Stability FCC Part 15.407 (g)	5200 MHz at 6 Mbps
Voltage Variation FCC Part 15.31 (e)	5200 MHz at 6 Mbps
Dynamic Frequency Selection FCC Part 15.407 (h)	5150 – 5250 MHz band does not support DFS.
<p><b>Note:</b> 1. Band 5150 MHz – 5250 MHz support only 802.11a.            2. All radiated emission performed on X-Axis.            3. All tests were pre-scanned for worst case before final testing.</p>	

---

## 7.4 Test Specifications

Testing requirements

**Table 16:** Test Specifications

Emissions and Immunity	
Standard	Requirement
CFR 47 Part 15.407: 2014 June 23	All
RSS-210 Issue 8, 2010	All

**END OF REPORT**