

Emissions Test Report

EUT Name: Wireless Audio Transmitter
Model No.: Ear Force Stealth 500X TX
CFR 47 Part 15.407:2014 and RSS-210:2010

Prepared for:

Voyetra Turtle Beach, Inc.
100 Summit Lake Drive, Suite 100
Valhalla, New York 10595 USA

Prepared by:

TUV Rheinland of North America, Inc.
1279 Quarry Lane, Ste. A
Pleasanton, CA 94566 U.S.A.
Tel: (925) 249-9123
Fax: (925) 249-9124
<http://www.tuv.com/>

Report/Issue Date: November 12, 2014
Report Number: 31462910.001
Project Number: 0000122935
Revision Number 1

Statement of Compliance

Manufacturer: Voyetra Turtle Beach, Inc.
100 Summit Lake Drive, Suite 100
Valhalla, New York 10595 USA

Requester / Applicant: Tim Blaney

Name of Equipment: Wireless Audio Transmitter

Model No.: Ear Force Stealth 500X TX (TB300-2371-01)

Type of Equipment: Intentional Radiator

Application of Regulations: CFR 47 Part 15.407:2014 and RSS-210:2010

Test Dates: 7 July 2014 to 18 July 2014

Guidance Documents:

Emissions: ANSI C63.10-2009, KDB 789033 D02 General UNII Test Procedure New Rules v01

Test Methods:

Emissions: ANSI C63.10-2009, KDB 789033 D02 General UNII Test Procedure New Rules v01

The electromagnetic compatibility test and documented data described in this report has been performed and recorded by TUV Rheinland, in accordance with the standards and procedures listed herein. As the responsible authorized agent of the EMC laboratory, I hereby declare that the equipment described above has been shown to be compliant with the EMC requirements of the stated regulations and standards based on these results. If any special accessories and/or modifications were required for compliance, they are listed in the Executive Summary of this report.

This report must not be used to claim product endorsement by A2LA or any agency of the U.S. Government. This report contains data that are not covered by A2LA accreditation. This report shall not be reproduced except in full, without the written authorization of TUV Rheinland of North America.

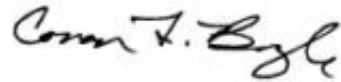

Jeremy Luong November 12, 2014

Test Engineer Date

Conan Boyle November 12, 2014

Laboratory Signature Date



**INDUSTRY
CANADA**

Testing Cert #3331.02

US5254

2932M-1

Table of Contents

| | | |
|----------|---|-----------|
| 1 | Executive Summary | 7 |
| 1.1 | Scope | 7 |
| 1.2 | Purpose | 7 |
| 1.3 | Summary of Test Results | 8 |
| 1.4 | Special Accessories | 8 |
| 1.5 | Equipment Modifications | 8 |
| 2 | Laboratory Information | 9 |
| 2.1 | Accreditations & Endorsements | 9 |
| 2.1.1 | US Federal Communications Commission | 9 |
| 2.1.2 | NIST / A2LA | 9 |
| 2.1.3 | Canada – Industry Canada | 9 |
| 2.1.4 | Japan – VCCI | 9 |
| 2.1.5 | Acceptance by Mutual Recognition Arrangement | 10 |
| 2.2 | Test Facilities | 10 |
| 2.2.1 | Emission Test Facility | 10 |
| 2.2.2 | Immunity Test Facility | 10 |
| 2.3 | Measurement Uncertainty | 11 |
| 2.3.1 | Sample Calculation – radiated & conducted emissions | 11 |
| 2.3.2 | Measurement Uncertainty Emissions | 11 |
| 2.3.3 | Measurement Uncertainty Immunity | 12 |
| 2.4 | Calibration Traceability | 12 |
| 3 | Product Information | 13 |
| 3.1 | Product Description | 13 |
| 3.2 | Equipment Configuration | 13 |
| 3.3 | Operating Mode | 13 |
| 3.4 | Unique Antenna Connector | 14 |
| 4 | Emissions | 15 |
| 4.1 | Output Power Requirements | 15 |
| 4.1.1 | Test Method | 15 |
| 4.1.2 | Results | 16 |
| 4.2 | Occupied Bandwidth | 20 |
| 4.2.1 | Test Method | 20 |
| 4.2.2 | Results | 21 |
| 4.3 | Peak Excursion | 24 |
| 4.3.1 | Test Method | 24 |
| 4.3.2 | Results | 25 |
| 4.4 | Peak Power Spectral Density | 34 |
| 4.4.1 | Test Method | 34 |
| 4.4.2 | Results | 35 |
| 4.5 | Transmitter Spurious Emissions | 38 |

Table of Contents

| | | |
|------------|-------------------------------------|-----------|
| 4.5.1 | Test Methodology | 38 |
| 4.5.2 | Transmitter Spurious Emission Limit | 39 |
| 4.5.3 | Test Results | 39 |
| 4.5.4 | Sample Calculation | 53 |
| 4.6 | AC Conducted Emissions | 54 |
| 4.6.1 | Test Methodology | 54 |
| 4.6.2 | Test Results | 54 |
| 4.7 | Frequency Stability | 55 |
| 4.7.1 | Test Methodology | 55 |
| 4.7.2 | Manufacturer Declaration | 55 |
| 4.7.3 | Limit | 56 |
| 4.7.4 | Test results | 56 |
| 4.8 | Voltage Variation | 58 |
| 4.8.1 | Test Methodology | 58 |
| 4.8.2 | Test results | 58 |
| 4.9 | Maximum Permissible Exposure | 60 |
| 4.9.1 | Test Methodology | 60 |
| 4.9.2 | RF Exposure Limit | 60 |
| 4.9.3 | EUT Operating Condition | 61 |
| 4.9.4 | Classification | 61 |
| 4.9.5 | Test Results | 61 |
| 4.9.6 | Sample Calculation | 61 |
| 6 | Test Equipment Use List | 62 |
| 6.1 | Equipment List | 62 |
| 7 | EMC Test Plan | 63 |
| 7.1 | Introduction | 63 |
| 7.2 | Customer | 63 |
| 7.3 | Equipment Under Test (EUT) | 64 |
| 7.4 | Test Specifications | 67 |

Index of Tables

Table 1: Summary of Test Results 8
Table 2: RF Output Power at the Antenna Port – Test Results 16
Table 3: Average Output Power at the Antenna Port – Reference Only 17
Table 4: Occupied Bandwidth – Test Results 21
Table 5: Peak Excursion – Test Results 25
Table 6: Maximum Power Spectral Density – Test Results 35
Table 7: Transmit Spurious Emission at Band-Edge Requirements 40
Table 8: Frequency Stability – Test Results 56
Table 9: Voltage Variation – Test Results 58
Table 10: Customer Information 63
Table 11: Technical Contact Information 63
Table 12: EUT Specifications 64
Table 13: Interface Specifications 65
Table 14: Supported Equipment 65
Table 15: Description of Sample used for Testing 65
Table 16: Description of Test Configuration used for Radiated Measurement. 65
Table 17: Final Test Mode for 5150 - 5250 Bands 66
Table 18: Test Specifications 67

1 Executive Summary

1.1 Scope

This report is intended to document the status of conformance with the requirements of the CFR 47 Part 15.407:2014 and RSS-210:2010 based on the results of testing performed on 7 July 2014 to 18 July 2014 on the Wireless Audio Transmitter Model Ear Force Stealth 500X TX manufactured by Voyetra Turtle Beach, Inc. This report only applies to the specific samples tested under the stated test conditions. It is the responsibility of the manufacturer to assure that additional production units of this model are manufactured with identical or EMI equivalent electrical and mechanical components. This report is further intended to document changes and modifications to the EUT throughout its life cycle. All documentation will be included as a supplement.

1.2 Purpose

Testing was performed to evaluate the EMC performance of the EUT in accordance with the applicable requirements, procedures, and criteria defined in the application of regulations and application of standards listed in this report.

The 5150 MHz to 5250 MHz frequency band was covered this document.

1.3 Summary of Test Results

Table 1: Summary of Test Results

| Test | Test Method ANSI C63.4:2003/ ANSI C63.10:2009 | Test Parameters | Measured Value | Result |
|---------------------------------------|---|------------------------|---|-----------------|
| Spurious Emission in Transmitted Mode | CFR47 15.209, CFR47 15.407 (b) RSS-GEN Sect.7.2.3, RSS-210 Sect. A.9.2 | Class B | -5.49 dB (margin) | Complied |
| Restricted Bands of Operation | CFR47 15.205, RSS-210 Sect.2.6 | Class B | | Complied |
| AC Power Conducted Emission | CFR47 15.207, RSS-GEN Sect.7.2.2 | Class B | N/A | Complied |
| Occupied Bandwidth | CFR47 15.407 (a), RSS GEN Sect.4.4.1 | N/A | 26dB BW: 29.74 MHz 99% BW: 18.71 MHz | Complied |
| Maximum Output Power | CFR47 15.407 (a), RSS-210 Sect. A.9.2 | 22.50 dBm | 7.72 dBm | Complied |
| Peak Power Spectral Density | CFR47 15.407 (a), RSS-210 Sect. A.9.2 | 4.00 dBm/MHz | -3.02 dBm/MHz | Complied |
| Peak Excursion Ratio | Information Only | < 13 dB | -5.99 dB | Complied |
| Conducted Emission – Antenna Port | CFR47 15.407 (b), RSS-210 Sect.6.2.2 | < -27 dBm/MHz | Note 3 | Complied |
| Frequency Stability | CFR47 15.407 (g), RSS GEN Sect. 4.7. | ±20 ppm | 6.88 ppm | Complied |
| RF Exposure - General Population | CFR47 15.247 (i), 2.1091 | 1.0 mW/cm ² | 0.001931 mW/cm ² | Complied |

Note: 1. Meet restricted band emission requirements.
 2. This report is only documented for 5150 – 5250 MHz.
 3. EUT met spurious emission limit of CFR47 Part 15.247.

1.4 Special Accessories

No special accessories were necessary in order to achieve compliance.

1.5 Equipment Modifications

None

2 Laboratory Information

2.1 Accreditations & Endorsements

2.1.1 US Federal Communications Commission



TUV Rheinland of North America at 1279 Quarry Ln, Pleasanton, CA 94566 is recognized by the commission for performing testing services for the general public on a fee basis. These laboratory test facilities have been fully described in reports submitted to and accepted by the FCC (US5254). The laboratory scope of accreditation includes: Title 47 CFR Parts 15, 18, and 90. The accreditation is updated every 3 years.

2.1.2 NIST / A2LA



TUV Rheinland of North America is accredited by the National Voluntary Laboratory Accreditation Program, which is administered under the auspices of the National Institute of Standards and Technology. The laboratory has been assessed and accredited in accordance with ISO Guide 17025:2005 and ISO 9002 (Lab Code 3331.02). The scope of laboratory accreditation includes emission and immunity testing. The accreditation is updated annually.

2.1.3 Canada – Industry Canada



TUV Rheinland of North America at the 1279 Quarry Ln, Pleasanton, CA 94566 address is accredited by Industry Canada for performing testing services for the general public on a fee basis. This laboratory test facilities have been fully described in reports submitted to and accepted by Industry Canada (File Number 2932M). This reference number is the indication to the Industry Canada Certification Officers that the site meets the requirements of RSS 212, Issue 1 (Provisional). The accreditation is updated every 3 years.

2.1.4 Japan – VCCI



The Voluntary Control Council for Interference by Information Technology Equipment (VCCI) is a group that consists of Information Technology Equipment (ITE) manufacturers and EMC test laboratories. The purpose of the Council is to take voluntary control measures against electromagnetic interference from Information Technology Equipment, and thereby contribute to the development of a socially beneficial and responsible state of affairs in the realm of Information Technology Equipment in Japan. TUV Rheinland of North America at 1279 Quarry Ln, Pleasanton, CA 94566 has been assessed and approved in accordance with the Regulations for Voluntary Control Measures.

VCCI Registration No. for Pleasanton: A-0031

VCCI Registration No. for Santa Clara: A-0032

2.1.5 Acceptance by Mutual Recognition Arrangement



The United States has an established agreement with specific countries under the Asia Pacific Laboratory Accreditation Corporation (APLAC) Mutual Recognition Arrangement. Under this agreement, all TUV Rheinland at 1279 Quarry Ln, Pleasanton, CA 94566 test results and test reports within the scope of the laboratory NIST / A2LA accreditation will be accepted by each member country.

2.2 Test Facilities

All of the test facilities are located at 1279 Quarry Lane, Pleasanton, California 94566, USA. The 2305 Mission College, Santa Clara, 95054, USA location is considered a Pleasanton annex.

2.2.1 Emission Test Facility

The Semi-Anechoic chamber and AC Line Conducted measurement facility used to collect the radiated and conducted data has been constructed in accordance with ANSI C63.7:1992. The site has been measured in accordance with and verified to comply with the theoretical normalized site attenuation requirements of ANSI C63.4-2009, at a test distance of 3 and 5 meters. The site is listed with the FCC and accredited by A2LA (Lab Code 3331.02). The 3/5-meter semi-anechoic chamber used to collect the radiated data has been verified to comply with the theoretical normalized site attenuation requirements of ANSI C63.4-2009, at a test distance of 3 meter and 5 meters. A report detailing this site can be obtained from TUV Rheinland of North America.

2.2.2 Immunity Test Facility

ESD, EFT, Surge, PQF: These tests are performed in an environmentally controlled room with a 3.7 m x 4.8 m x 3.175 mm thick aluminum floor connected to PE ground.

For ESD testing, tabletop equipment is placed on an insulated mat with a surface resistivity of 10^9 Ohms/square on a 1.6 m x 0.8 m x 0.8 m high non-conductive table with a 3.175 mm aluminum top (Horizontal Coupling Plane). The HCP is connected to the main ground plane via a low impedance ground strap through two 470-k Ω resistors. The Vertical Coupling Plane consists of an aluminum plate 50 cm x 50 cm x 3.175 mm thick. The VCP is connected to the main ground plane via a low impedance ground strap through two 470-k Ω resistors.

For EFT, Surge, PQF, the HCP and VCP are removed.

RF Field Immunity testing is performed in a 7.3m x 4.3m x 4.1m anechoic chamber.

RF Conducted and Magnetic Field Immunity testing is performed on a 4.8m x 3.7m x 3.175mm thick aluminum ground plane.

All test areas allow a minimum distance of 1 meter from the EUT to walls or conducting objects.

2.3 Measurement Uncertainty

Two types of measurement uncertainty are expressed in this report, per *ISO Guide To The Expression Of Uncertainty In Measurement*, 1st Edition, 1995.

The Combined Standard Uncertainty is the standard uncertainty of the result of a measurement when that result is obtained from the values of a number of other quantities; it is equal to the positive square root of the sum of the variances or co-variances of these other quantities, weighted according to how the measurement result varies with changes in these quantities. The term *standard uncertainty* is the result of a measurement expressed as a standard deviation.

2.3.1 Sample Calculation – radiated & conducted emissions

The field strength is calculated by subtracting the Amplifier Gain and adding the Cable Loss and Antenna Correction Factor to the measured reading. The basic equation is as follows:

$$\text{Field Strength (dB}\mu\text{V/m)} = \text{RAW} - \text{AMP} + \text{CBL} + \text{ACF}$$

Where: RAW = Measured level before correction (dB μ V)

AMP = Amplifier Gain (dB)

CBL = Cable Loss (dB)

ACF = Antenna Correction Factor (dB/m)

$$\mu\text{V/m} = 10^{\frac{\text{dB}\mu\text{V/m}}{20}}$$

Sample radiated emissions calculation @ 30 MHz

Measurement +Antenna Factor–Amplifier Gain+Cable loss=Radiated Emissions (dBuV/m)

$$25 \text{ dBuV/m} + 17.5 \text{ dB} - 20 \text{ dB} + 1.0 \text{ dB} = 23.5 \text{ dBuV/m}$$

2.3.2 Measurement Uncertainty Emissions

| Per CISPR 16-4-2 | U _{lab} | U _{cispr} |
|--|------------------|--------------------|
| Radiated Disturbance @ 10 meters | | |
| 30 – 1,000 MHz | 2.25 dB | 4.51 dB |
| Radiated Disturbance @ 3 meters | | |
| 30 – 1,000 MHz | 2.26 dB | 4.52 dB |
| 1 – 6 GHz | 2.12 dB | 4.25 dB |
| 6 – 18 GHz | 2.47 dB | 4.93 dB |
| Conducted Disturbance @ Mains Terminals | | |
| 150 kHz – 30 MHz | 1.09 dB | 2.18 dB |
| Disturbance Power | | |
| 30 MHz – 300 MHz | 3.92 dB | 4.3 dB |

Voltech PM6000A

| | |
|--|--------------------------|
| The estimated combined standard uncertainty for harmonic current and flicker measurements is $\pm 5.0\%$. | Per CISPR 16-4-2 Methods |
|--|--------------------------|

2.3.3 Measurement Uncertainty Immunity

| | |
|---|-------------------|
| The estimated combined standard uncertainty for ESD immunity measurements is $\pm 8.2\%$. | Per IEC 61000-4-2 |
| The estimated combined standard uncertainty for radiated immunity measurements is ± 4.10 dB. | Per IEC 61000-4-3 |
| The estimated combined standard uncertainty for conducted immunity measurements with CDN is ± 3.66 dB | Per IEC 61000-4-6 |
| The estimated combined standard uncertainty for power frequency magnetic field immunity is $\pm 11.6\%$. | Per IEC 61000-4-8 |

Thermo KeyTek EMC Pro

| |
|---|
| The estimated combined standard uncertainty for EFT fast transient immunity measurements is $\pm 5.84\%$. |
| The estimated combined standard uncertainty for surge immunity measurements is $\pm 5.84\%$. |
| The estimated combined standard uncertainty for voltage variation and interruption measurements is $\pm 3.48\%$. |

The expanded uncertainty at a level of 95% confidence is obtained by multiplying the combined standard uncertainty by a coverage factor of 2. Compliance criteria are not based on measurement uncertainty.

Measurement Uncertainty – Radio Testing

| |
|--|
| The estimated combined standard uncertainty for frequency error measurements is ± 3.88 Hz |
| The estimated combined standard uncertainty for carrier power measurements is ± 1.59 dB. |
| The estimated combined standard uncertainty for adjacent channel power measurements is ± 1.47 dB. |
| The estimated combined standard uncertainty for modulation frequency response measurements is ± 0.46 dB. |
| The estimated combined standard uncertainty for transmitter conducted emission measurements is ± 4.01 dB |

The expanded uncertainty at a level of 95% confidence is obtained by multiplying the combined standard uncertainty by a coverage factor of 2. Compliance criteria are not based on measurement uncertainty.

2.4 Calibration Traceability

All measurement instrumentation is traceable to the National Institute of Standards and Technology (NIST). Measurement method complies with ANSI/NCSL Z540-1-1994 and ISO Standard 17025:2005.

3 Product Information

3.1 Product Description

The Ear Force Stealth 500X Wireless Gaming System consists of two main communication modules, the Stealth 500X RX (“Headset”) and the Stealth 500X TX (“Transmitter”). These two modules comprise a closed-loop wireless audio gaming system that utilize a Wi-Fi communication technology to offer wireless streaming audio and chat/talkback capabilities.

3.2 Equipment Configuration

A description of the equipment configuration is given in the Test Plan Section. The EUT was tested as called for in the test standard and was configured and operated in a manner consistent with its intended use. The EUT was connected to rated power and allowed to reach intended operating conditions. The placement of the EUT system components was guided by the test standard and selected to represent typical installation conditions.

In the case of a EUT that can operate in more than one configuration, preliminary testing was performed to determine the configuration that produced maximum radiation.

The final configuration was selected to produce the worst case radiation for emissions testing and to place the EUT in the most susceptible state for immunity testing.

3.3 Operating Mode

A description of the operation mode is given in the Test Plan Section. In the case of a EUT that can operate in more than one state, preliminary testing was performed to determine the operating mode that produced maximum radiation.

The final operating mode was selected to produce the worst case radiation for emissions testing and to place the EUT in the most susceptible state for immunity testing.

3.4 Unique Antenna Connector

An intentional radiator shall be designed to ensure that no antenna other than that furnished by the responsible party shall be used with the device. The use of a permanently attached antenna or of an antenna that uses a unique coupling to the intentional radiator shall be considered sufficient to comply with the provisions of this Section. The manufacturer may design the unit so that a broken antenna can be replaced by the user, but the use of a standard antenna jack or electrical connector is prohibited. This requirement does not apply to carrier current devices or to devices operated under the provisions of CFR47 Parts 15.211, 15.213, 15.217, 15.219, or 15.221.

3.4.1 Results

The Ear Force Stealth 500X TX has (1) internal integrated antenna. There is no external antenna connection available.

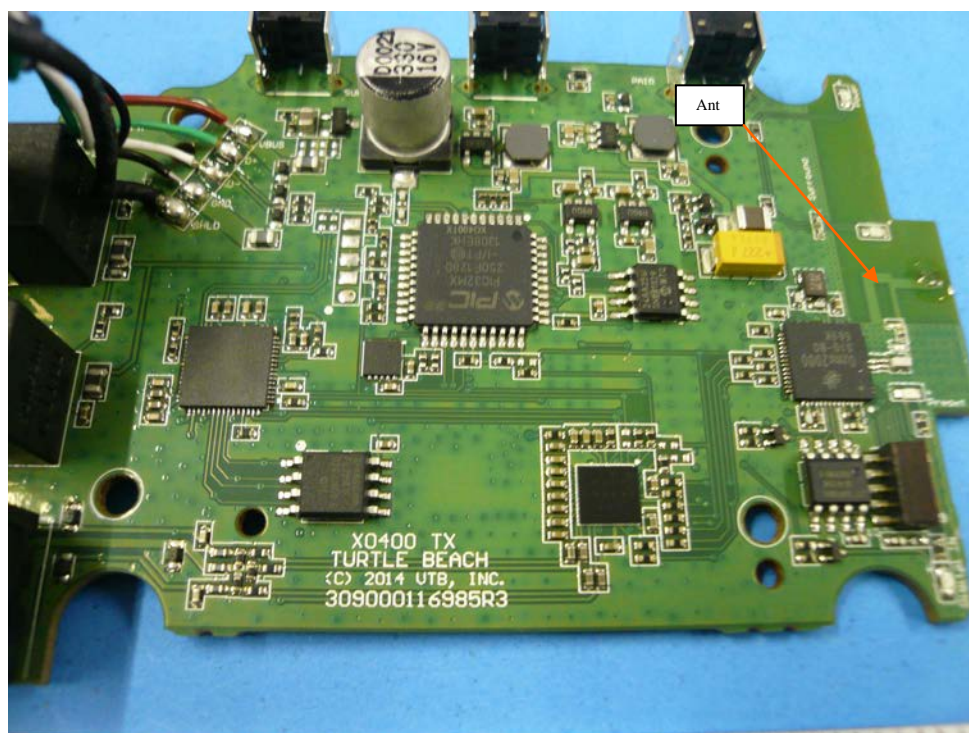

4 Emissions

Testing was performed in accordance with CFR 47 Part 15.407: 2014 and RSS 210 Annex 9: 2010. These test methods are listed under the laboratory's A2LA Scope of Accreditation. This test measures the levels emanating from the EUT, thus evaluating the potential for the EUT to cause radio frequency interference to other electronic devices. Procedures described in section 8 of the standard were used.

4.1 Output Power Requirements

The maximum output power requirement is the maximum equivalent isotropic radiated power delivering at the transmitting antenna under specified conditions of measurements in the presence of modulation.

The maximum output power and harmonics shall not exceed CFR47 Part 15.407 (a):2014 and RSS-210 A9.2: 2010.

The maximum transmitted powers for mobile and portable client device is

Band 5150-5250 MHz: 250 mW; per CFR47 Part 15.407:2014

Band 5150-5250 MHz: 200 mW or $10+10\log(B)$; where B is 99% Bandwidth.

4.1.1 Test Method

The ANSI C63.10-2009 Section 6.10.3.1 conducted method was used to measure the channel power output. The preliminary investigation was performed at different data rate to determine the highest power output for each mode. The worst findings were conducted on 3 channels on the sample, S/N PP #1, per CFR47 Part 15.407(a): 2014 and RSS-210 A.9.2; 5150 MHz to 5250 MHz. The worst mode results indicated below.

Test Setup:

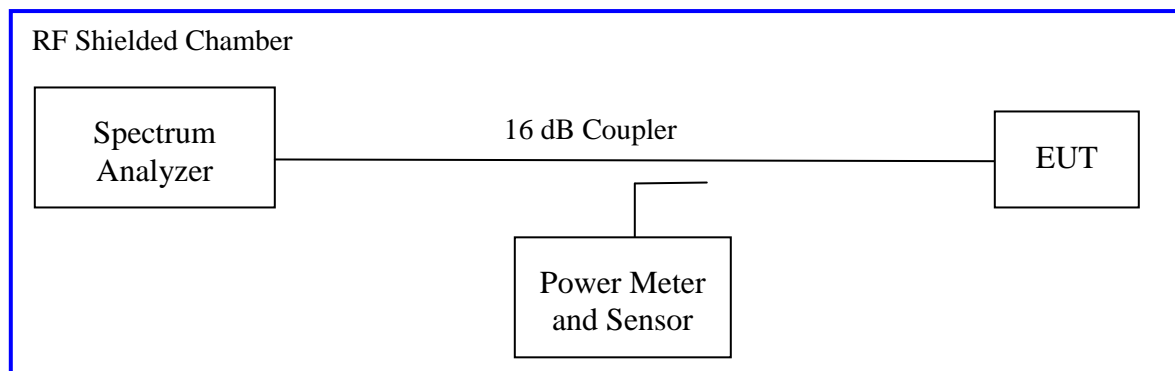

Method SA-2 of KDB 789033 D02 General UNII Test Procedure New Rules v01, "Guidelines for Compliance Testing of Unlicensed National Information Infrastructure (U-NII) Devices", applies since the EUT continuously transmit with duty cycle less 100%. The duty cycle, $CF = 10\log(1/\text{duty cycle})$, did not applied since EUT transmitted at 100% duty cycle.

4.1.2 Results

As originally tested, the EUT was found to be compliant to the requirements of the test standard(s).

Table 2: RF Output Power at the Antenna Port – Test Results

| Test Conditions: Conducted Measurement | | Test Date: July 11, 2014 | |
|---|-------------|---------------------------------|-------------|
| Antenna Type: Integrated | | Power Setting: SPW 0 | |
| Antenna Gain: + 2.16 dBi | | Signal State: Modulated. | |
| Ambient Temp.: 22 °C | | Relative Humidity: 35% | |
| Result | | | |
| Operating Channel | Limit [dBm] | Output Power [dBm] | Margin [dB] |
| 5180 | 22.50 | 6.74 | -15.76 |
| 5200 | 22.50 | 6.87 | -15.63 |
| 5240 | 22.50 | 7.72 | -14.78 |
| <p>Note: 1. The highest output power was observed at 802.11a, 6Mbps. 2. EUT is portable device. The limit under CFR47 Part 15.407 (a)(1)(iv) is 250 mW or 23.98 dBm. RSS 210 Sect 9.2 limit calculated using 99% bandwidth is 22.5dBm. Since the calculated limit is more stricken, it is used to show compliance to both FCC and IC. 3. Measurements performed at 100% duty cycle; therefore, duty correction factor do not include to the final calculation. 4. Maximum antenna gain is less than 6 dBi; therefore, no antenna correction factor was applied.</p> | | | |

Table 3: Average Output Power at the Antenna Port – Reference Only

| Test Conditions: Conducted Measurement | | Test Date: July 11, 2014 | |
|---|-------------|---------------------------------|-------------|
| Antenna Type: Integrated | | Power Setting: SPW 0 | |
| Antenna Gain: + 2.16 dBi | | Signal State: Modulated. | |
| Ambient Temp.: 22 °C | | Relative Humidity: 35% | |
| Result | | | |
| Operating Channel | Limit [dBm] | Output Power [dBm] | Margin [dB] |
| 5180 | | 8.51 | |
| 5200 | | 8.55 | |
| 5240 | | 9.02 | |
| Note: The highest output power was observed at 802.11a, 6Mbps. | | | |

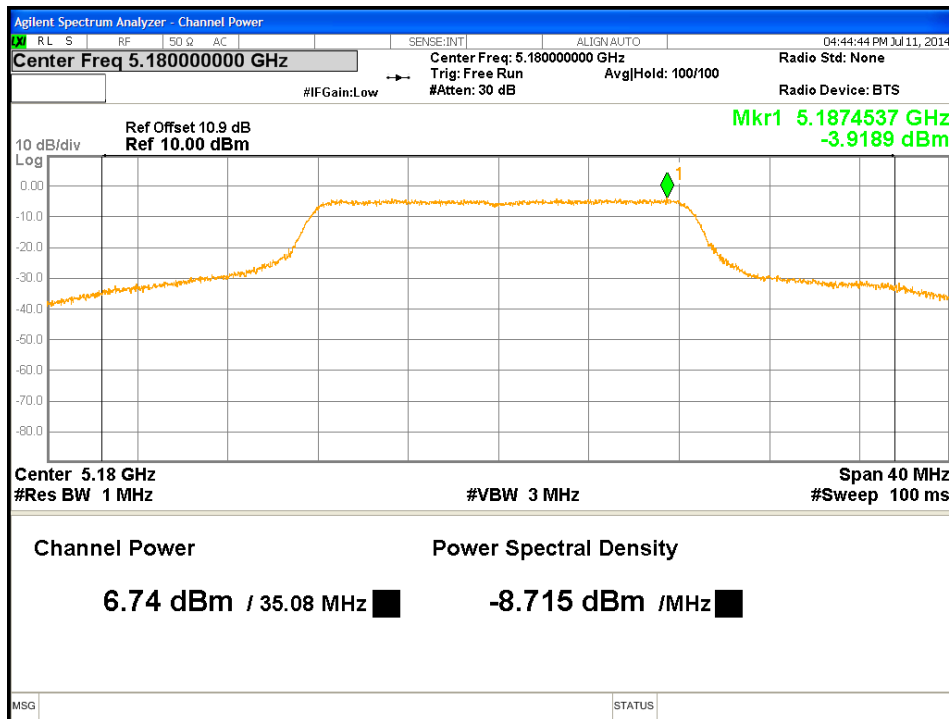

Figure 1: Maximum Conducted Output Power-5180 MHz-11a-6Mbps

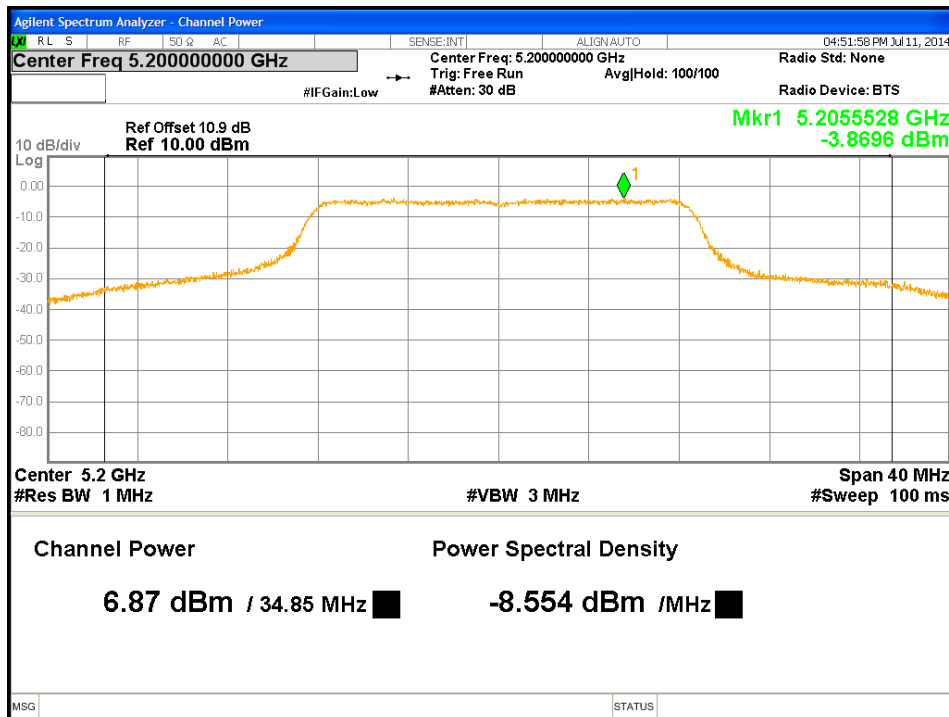

Figure 2: Maximum Conducted Output Power-5200 MHz-11a-6Mbps

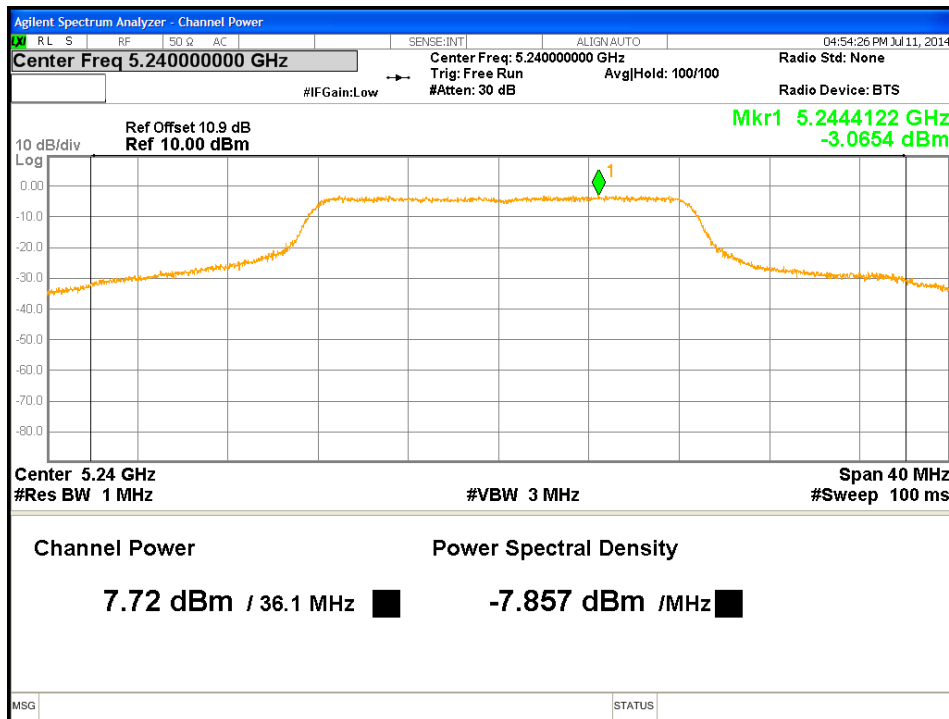

Figure 3: Maximum Conducted Output Power-5240 MHz-11a-6Mbps

4.2 Occupied Bandwidth

The occupied bandwidth is measured at an amplitude level reduced from the reference level by a specified ratio. The reference level is the level of the highest amplitude signal observed from the transmitter at the fundamental frequency.

The 99% bandwidth is the bandwidth in which 99% of the transmitted power occupied.

The 26 dB bandwidth is defined the bandwidth of 26 dB from highest transmitted level of the fundamental frequency.

There is no power limitation referencing to the 26 dB bandwidth under CFR47 Part 15.407 (a)(1)(iv).

The 26 dB bandwidth recorded for information only.

4.2.1 Test Method

The conducted method was used to measure the occupied bandwidth. The measurement was performed with modulation per CFR47 15.407(a) 2014 and RSS Gen Sect. 4.4.1:2010. The preliminary investigation was performed to find the narrowest 26 dB bandwidth for each operational mode at different data rates. This worst finding was performed on 3 channels in each operating frequency range; 5150 MHz to 5250 MHz on the sample, S/N PP#1. The results indicated below.

Test Setup:

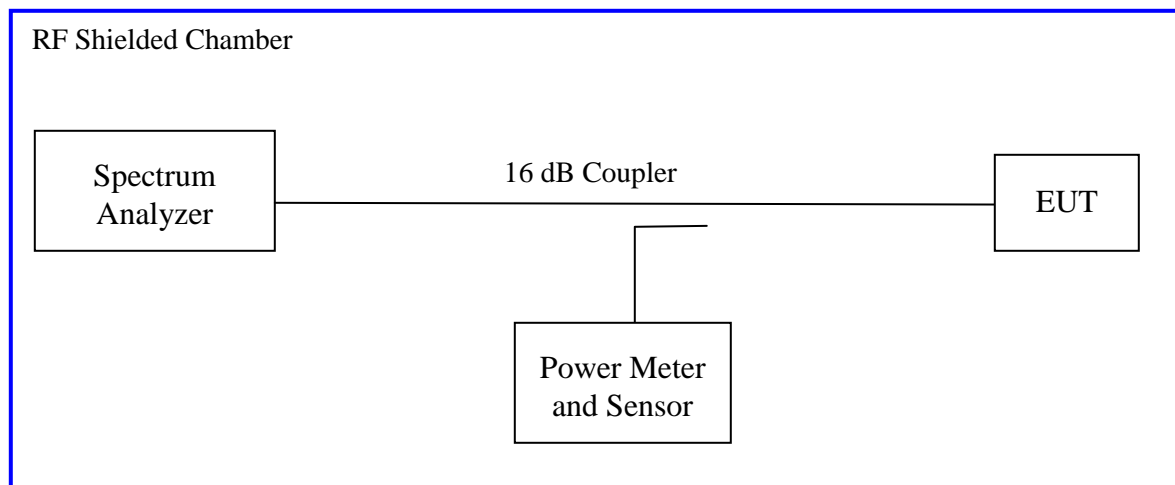

Method in Sect. C and D of KDB 789033 D02 General UNII Test Procedure New Rules v01, “Guidelines for Compliance Testing of Unlicensed National Information Infrastructure (U-NII) Devices”, used to perform measurements.

4.2.2 Results

These occupied bandwidth measurements were taken for references only.

Table 4: Occupied Bandwidth – Test Results

| Test Conditions: Conducted Measurement | | Test Date: July 11, 2014 |
|---|------------------------|---------------------------------|
| Antenna Type: Integrated | | Power Setting: SPW 0 |
| Antenna Gain: + 2.16 dBi | | Signal State: Modulated. |
| Ambient Temp.: 22 °C | | Relative Humidity: 35% |
| Bandwidth for 802.11a | | |
| Frequency (MHz) | 99% Bandwidth (MHz) | 26dB Bandwidth (MHz) |
| 5180 | 17.95 | 29.69 |
| 5200 | 18.12 | 29.24 |
| 5240 | 18.71 | 29.74 |
| Note: 1. The bandwidth was measured at 802.11a, 6Mbps. 2. The 17.95 MHz is used toward the maximum output power limit calculation per RSS210 Sect. 9.2. | | |

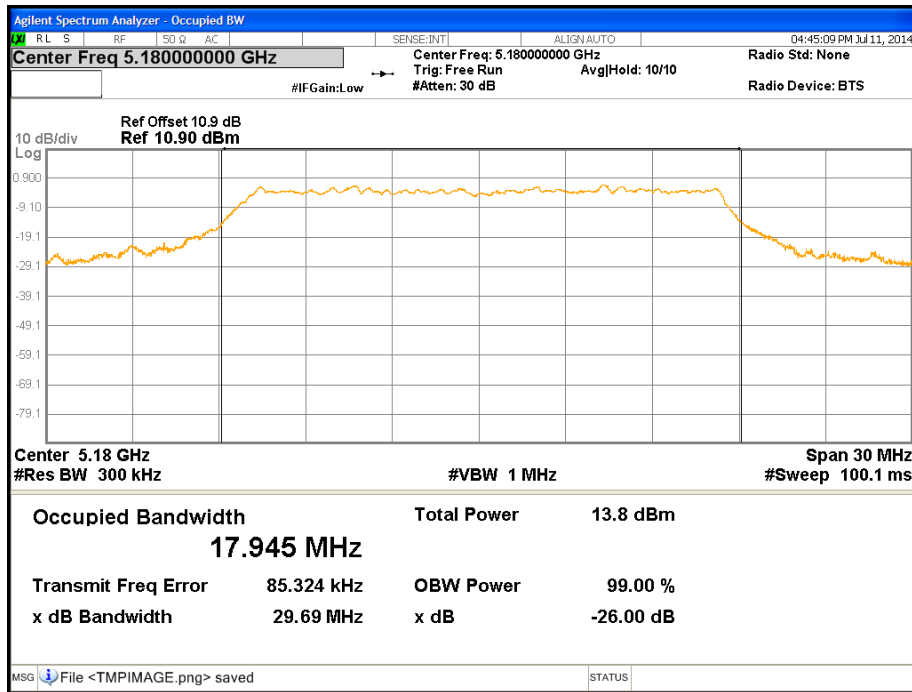

Figure 4: Occupied Bandwidth-5180 MHz-11a-6Mbps

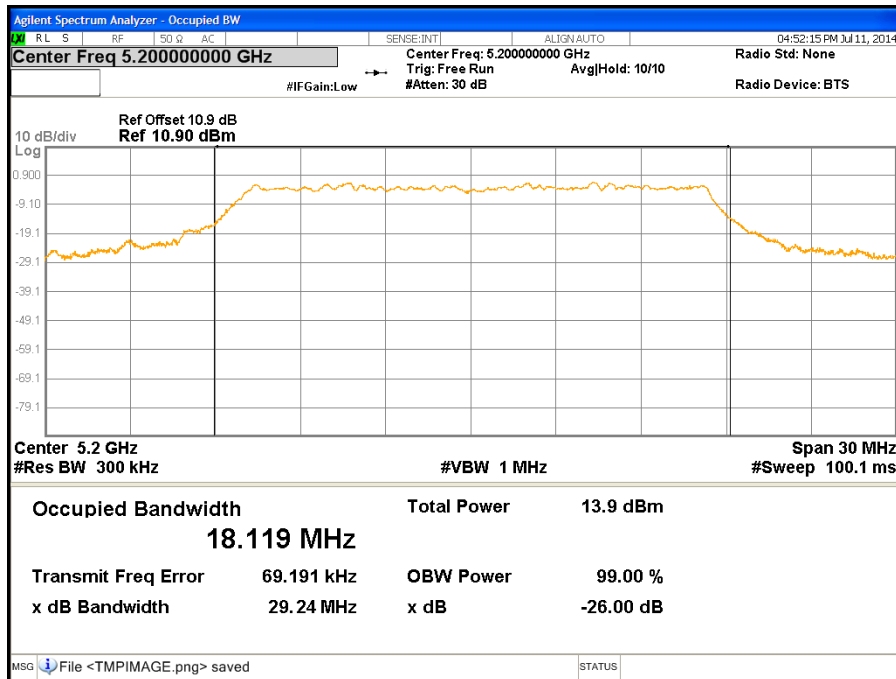

Figure 5: Occupied Bandwidth-5200 MHz-11a-6Mbps

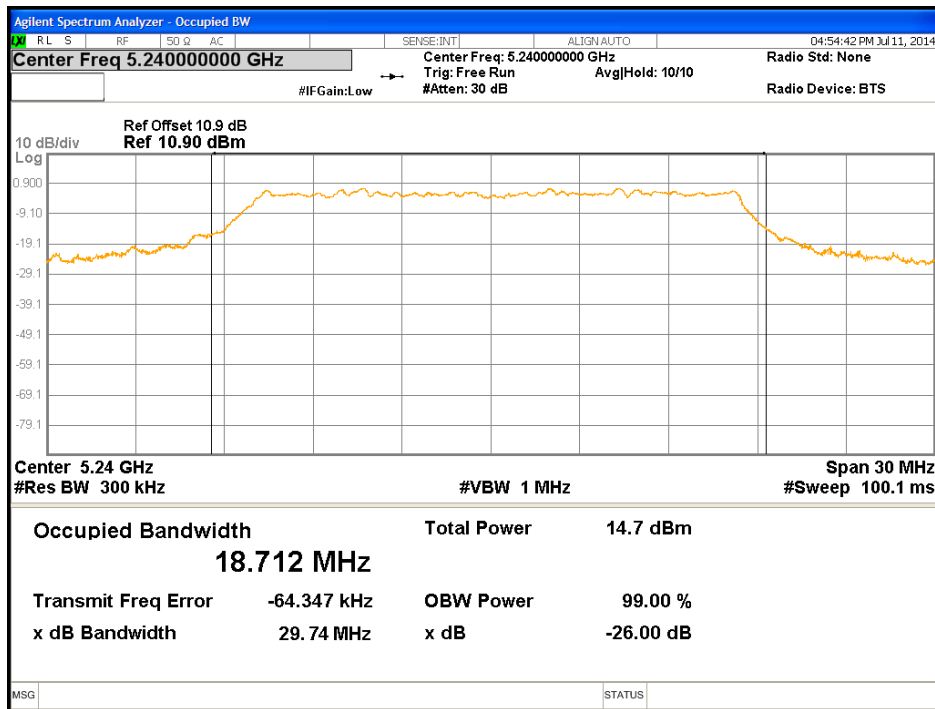

Figure 6: Occupied Bandwidth-5240 MHz-11 a-6Mbps

4.3 Peak Excursion

The ratio of the peak excursion of the modulation envelope, measured using a peak hold function, to the maximum conducted output power performed under Section 4.1 shall not exceed 13 dB across any 1 MHz bandwidth or the emission bandwidth whichever is less.

The peak excursion is not required under CFR47 Part 15.407:2014. These measurements recorded for information only.

4.3.1 Test Method

The ANSI C63.10-2009 Section 6.10.4 conducted method was used to measure the peak excursion.

The measurement was performed with modulation at all data rates. This test was conducted on 3 channels in each operating mode in frequency range 5150 MHz to 5250 MHz on the test sample, S/N PP#1. The worst sample result indicated below.

Test Setup:

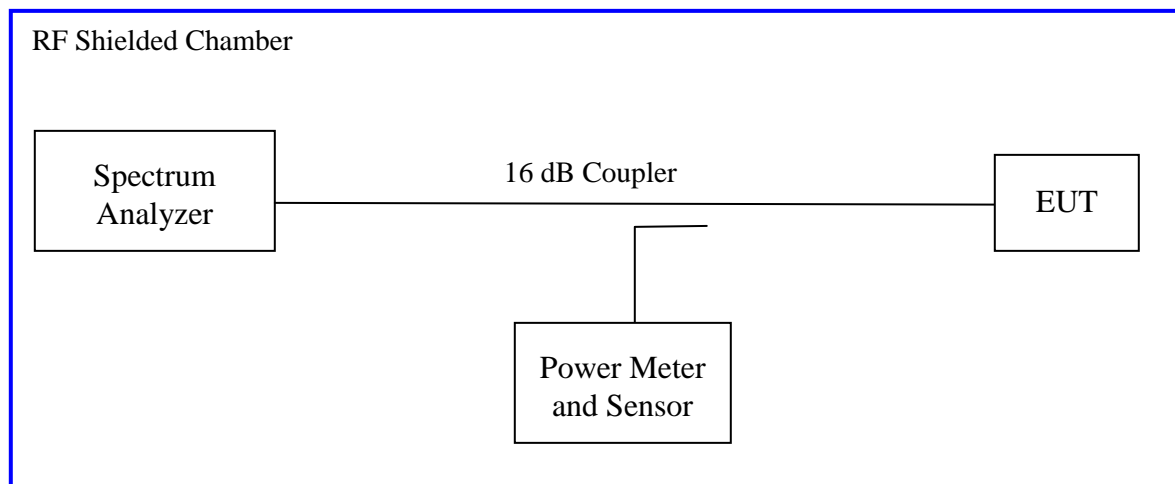

4.3.2 Results

As originally tested, the EUT was found to be compliant to the requirements of the test standard(s).

Table 5: Peak Excursion – Test Results

| Test Conditions: Conducted Measurement | | Test Date: July 11, 2014 | | |
|--|-------------|---------------------------------|-------------------|--------------------|
| Antenna Type: Integrated | | Power Setting: SPW 0 | | |
| Antenna Gain: + 2.16 dBi | | Signal State: Modulated. | | |
| Ambient Temp.: 22 °C | | Relative Humidity: 35% | | |
| 802.11a Mode | | | | |
| Operating Channel | Mode | Peak Excursion [dB] | Limit [dB] | Margin [dB] |
| 5180 | 6 Mbps | 6.95 | 13.0 | -6.05 |
| | 9 Mbps | 6.91 | 13.0 | -6.09 |
| | 12 Mbps | 6.94 | 13.0 | -6.06 |
| | 18 Mbps | 6.97 | 13.0 | -6.03 |
| | 24 Mbps | 7.01 | 13.0 | -5.99 |
| 5200 | 6 Mbps | 6.69 | 13.0 | -6.31 |
| | 9 Mbps | 6.92 | 13.0 | -6.08 |
| | 12 Mbps | 6.70 | 13.0 | -6.30 |
| | 18 Mbps | 6.70 | 13.0 | -6.30 |
| | 24 Mbps | 6.47 | 13.0 | -6.53 |
| 5240 | 6 Mbps | 6.71 | 13.0 | -6.29 |
| | 9 Mbps | 6.85 | 13.0 | -6.15 |
| | 12 Mbps | 6.84 | 13.0 | -6.16 |
| | 18 Mbps | 6.69 | 13.0 | -6.31 |
| | 24 Mbps | 6.86 | 13.0 | -6.14 |
| Note: The peak excursion was observed at all data rates of the 802.11a. | | | | |

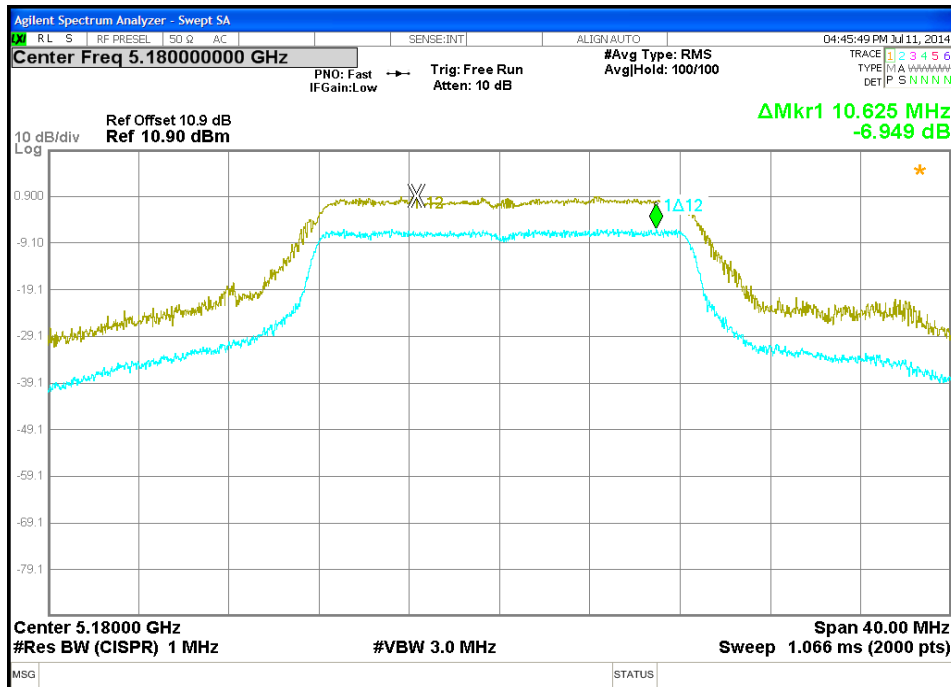

Figure 7: Peak Excursion-5180 MHz-11a-6Mbps

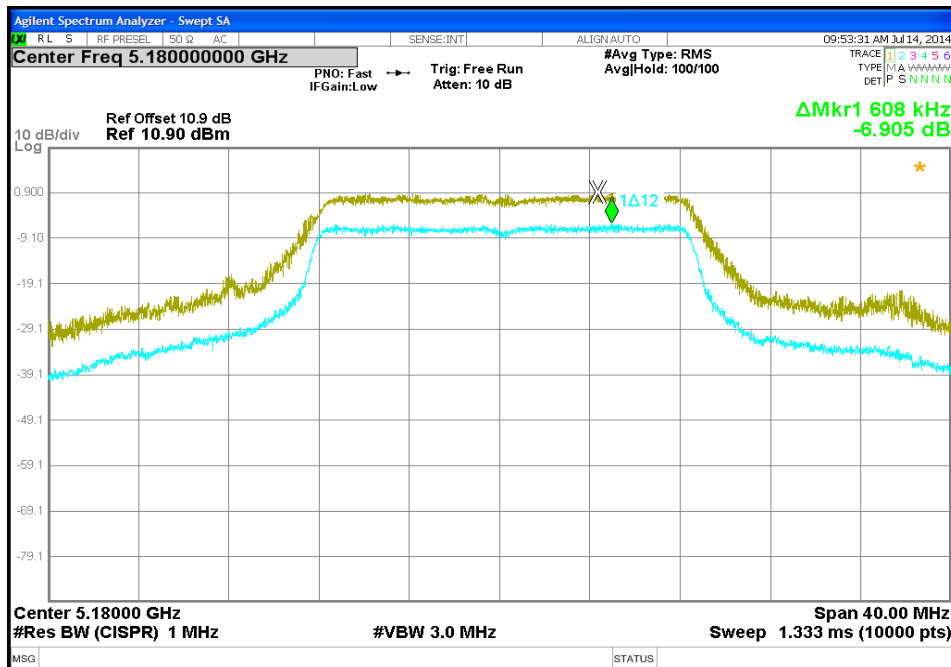

Figure 8: Peak Excursion-5180 MHz-11a-9Mbps

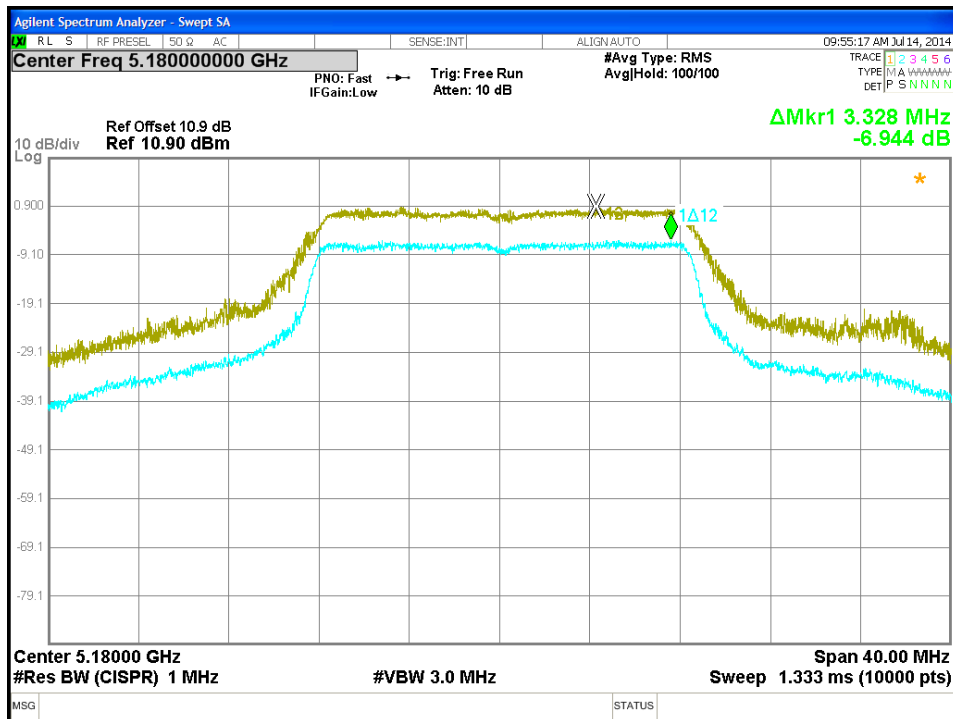

Figure 9: Peak Excursion-5180 MHz-11a-12Mbps

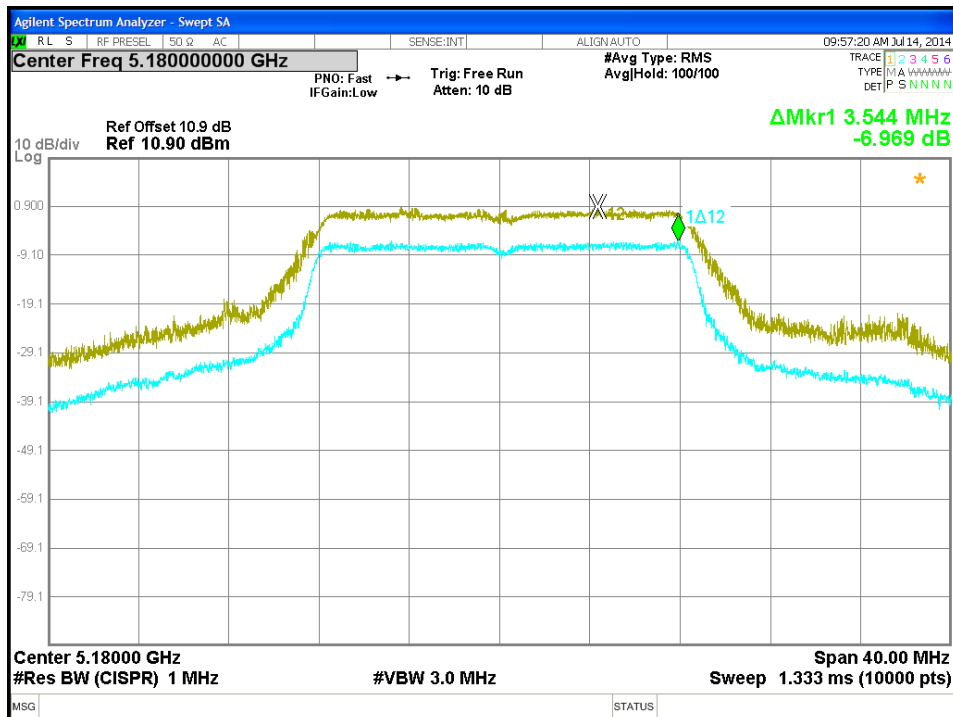

Figure 10: Peak Excursion-5180 MHz-11a-18Mbps

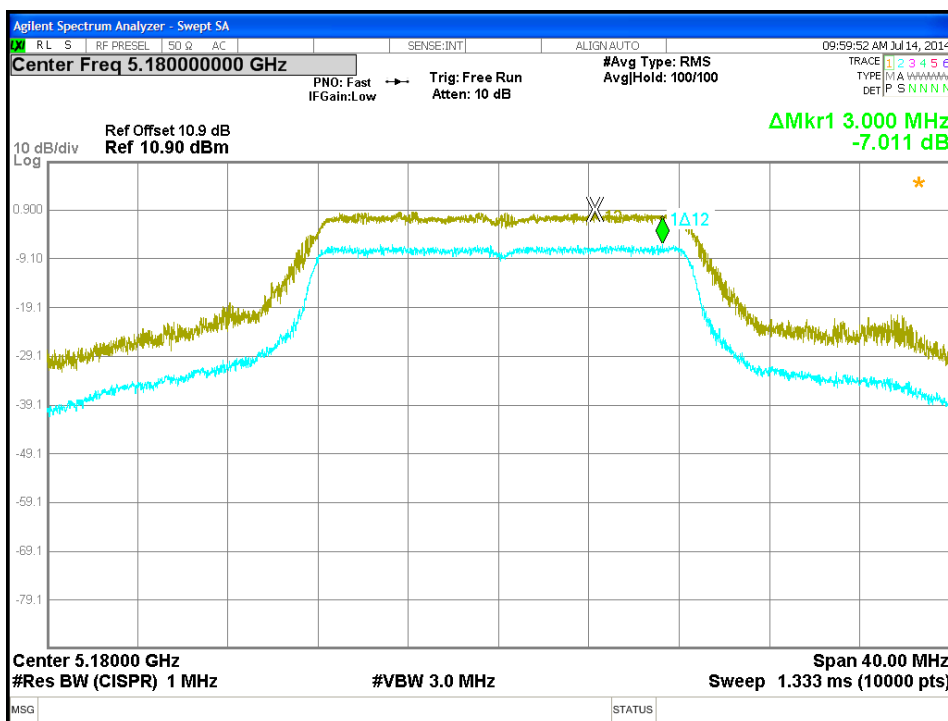

Figure 11: Peak Excursion-5180 MHz-11a-24Mbps

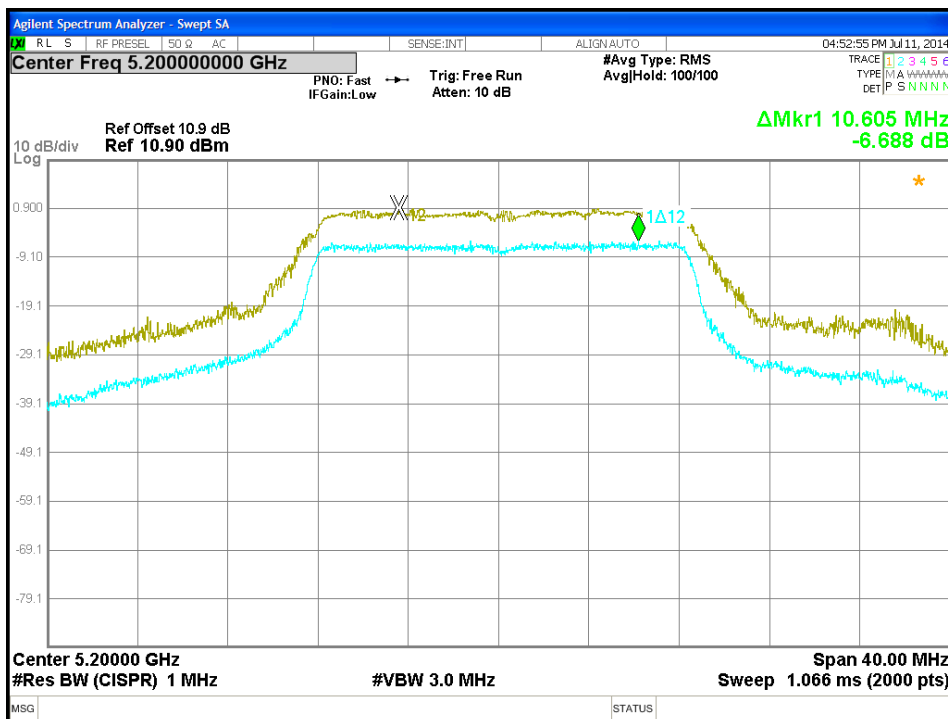

Figure 12: Peak Excursion-5200 MHz-11a-6Mbps

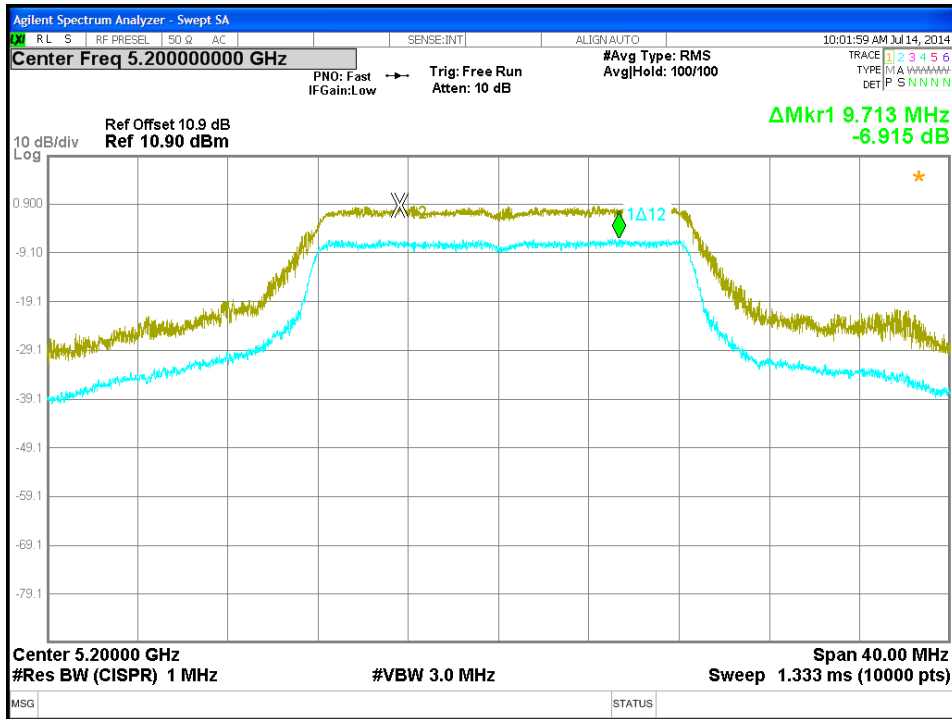

Figure 13: Peak Excursion-5200 MHz-11a-9Mbps

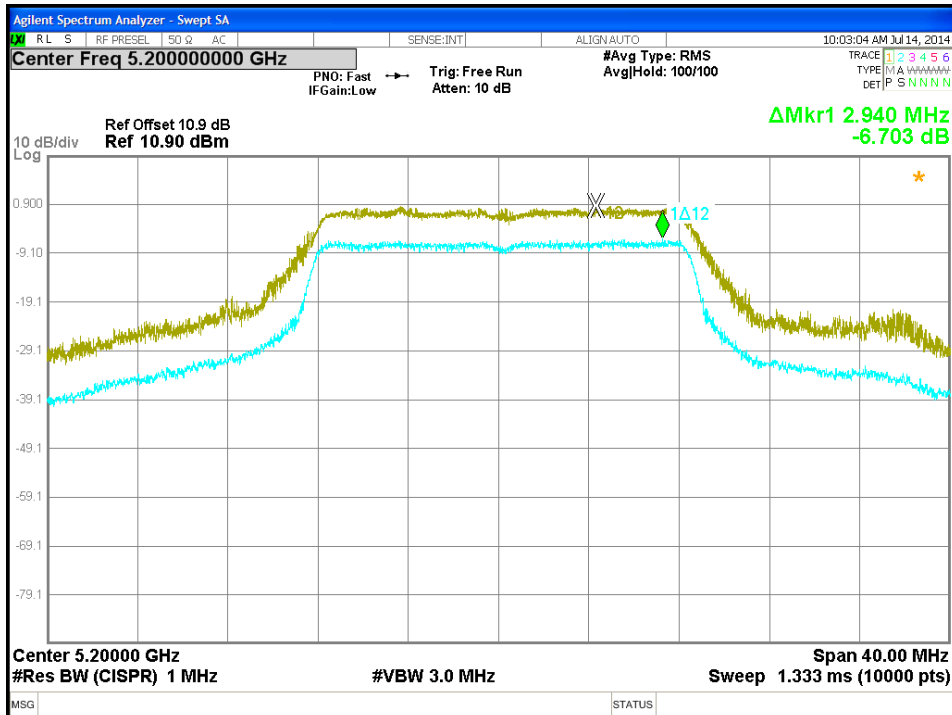

Figure 14: Peak Excursion-5200 MHz-11a-12Mbps

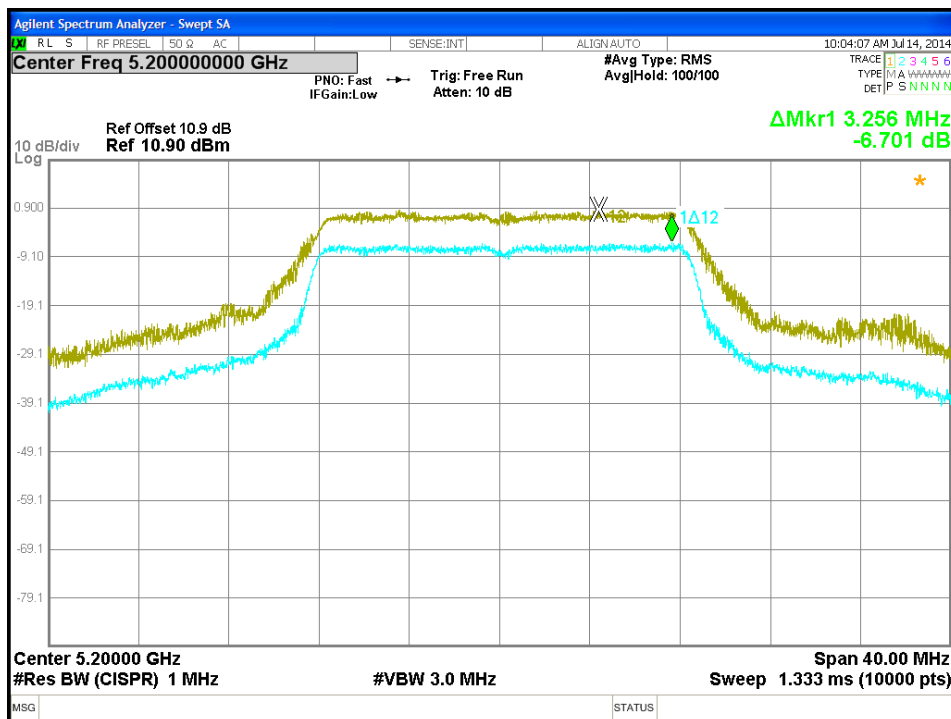

Figure 15: Peak Excursion-5200 MHz-11a-18Mbps

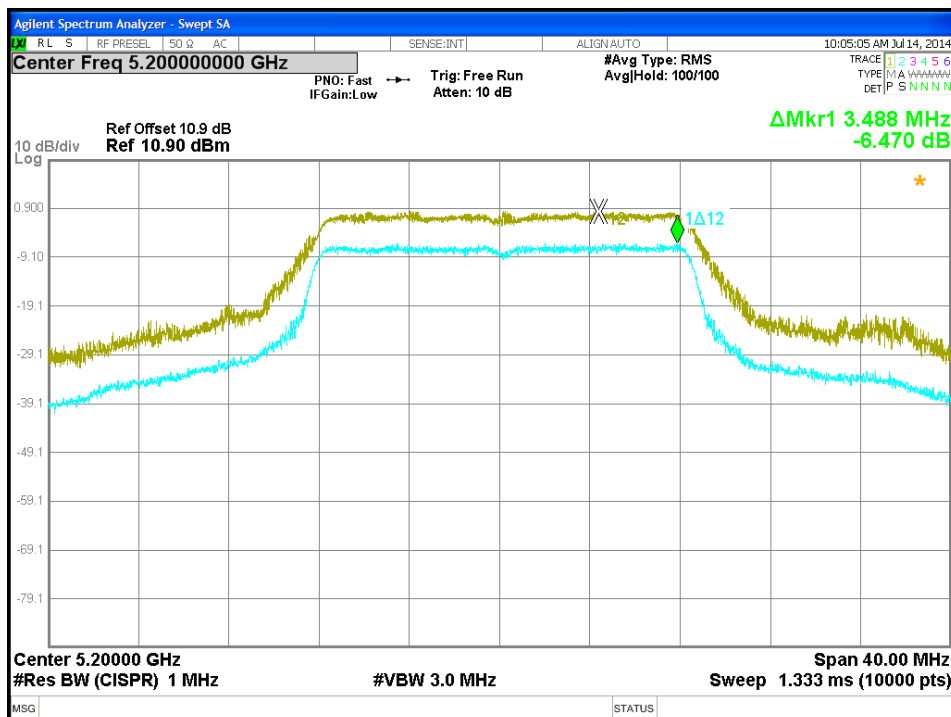

Figure 16: Peak Excursion-5200 MHz-11a-24Mbps

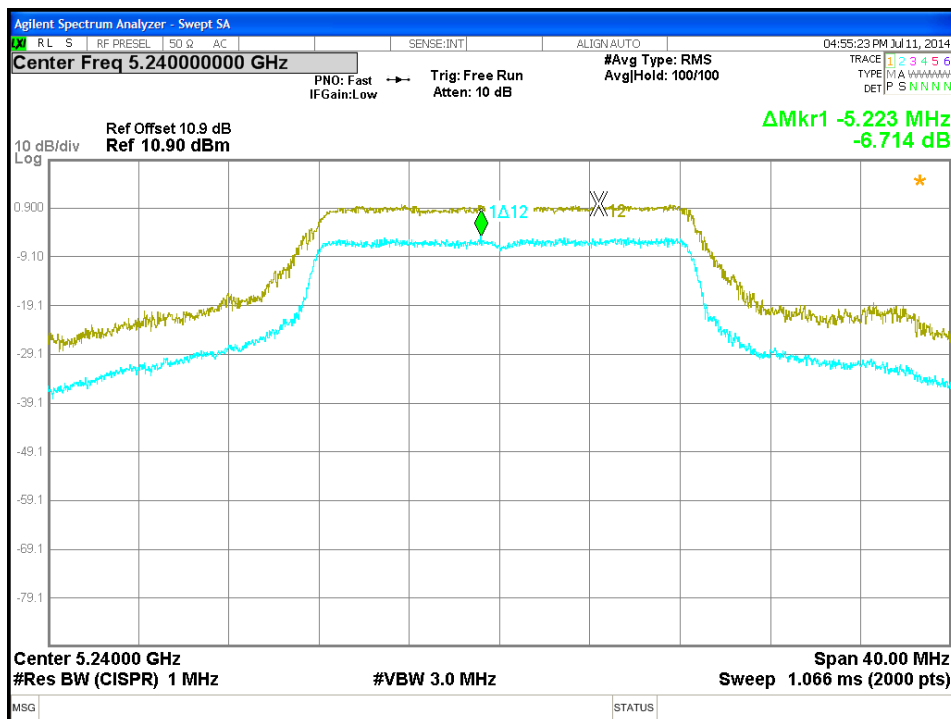

Figure 17: Peak Excursion-5240 MHz-11a-6Mbps

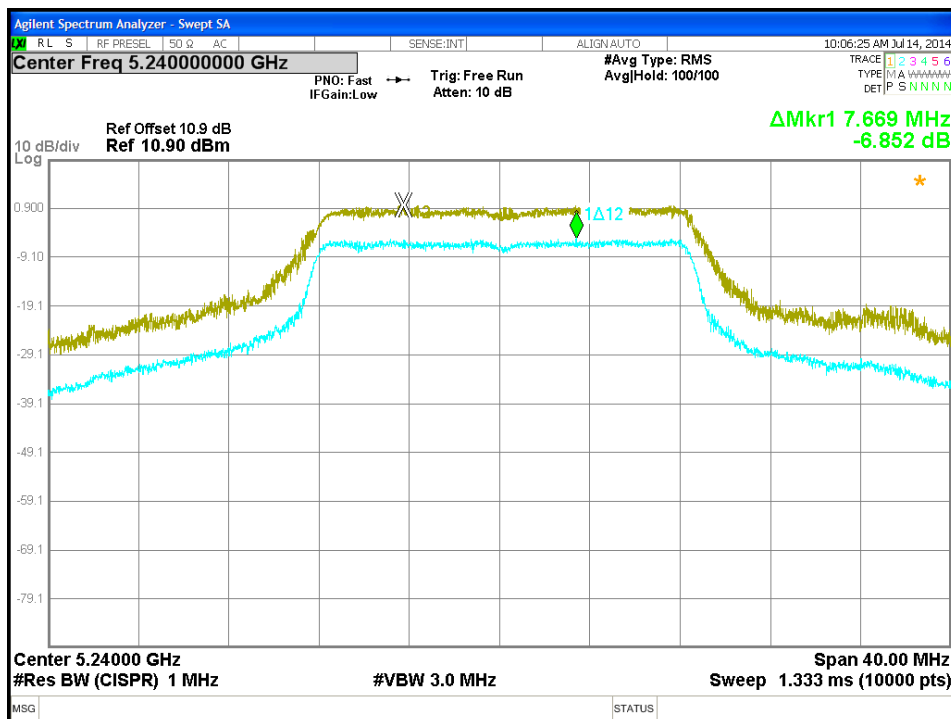

Figure 18: Peak Excursion-5240 MHz-11a-9Mbps

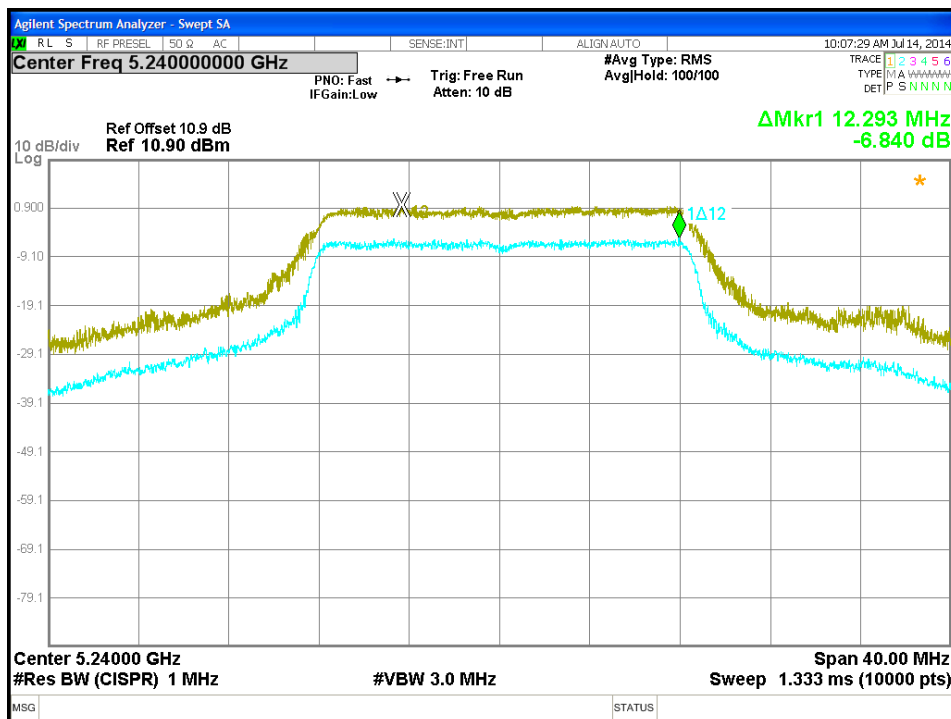

Figure 19: Peak Excursion-5240 MHz-11 a-12Mbps

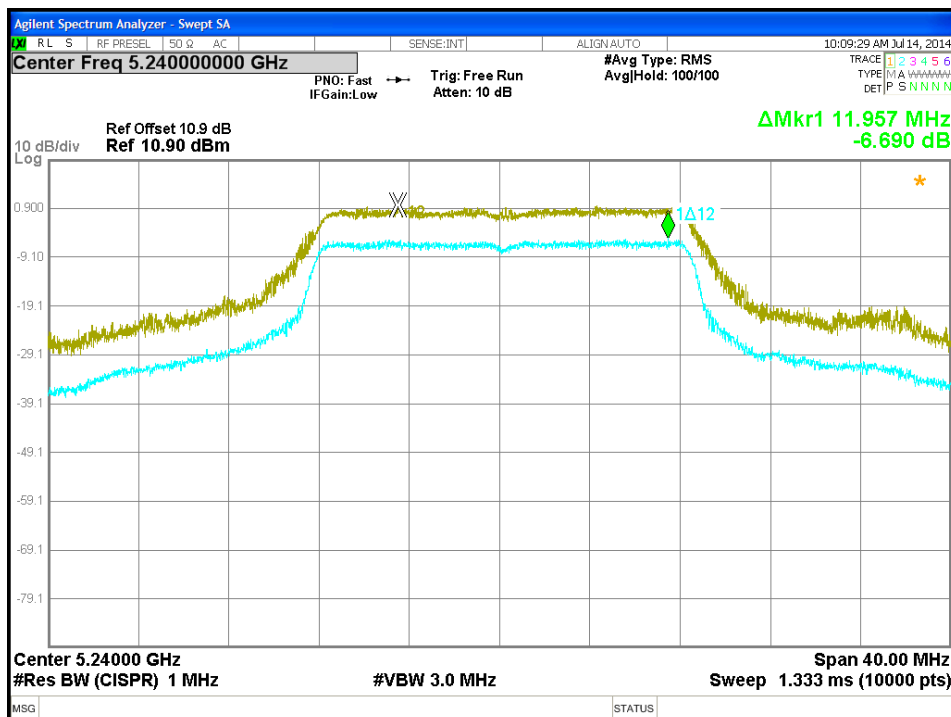

Figure 20: Peak Excursion-5240 MHz-11 a-18Mbps

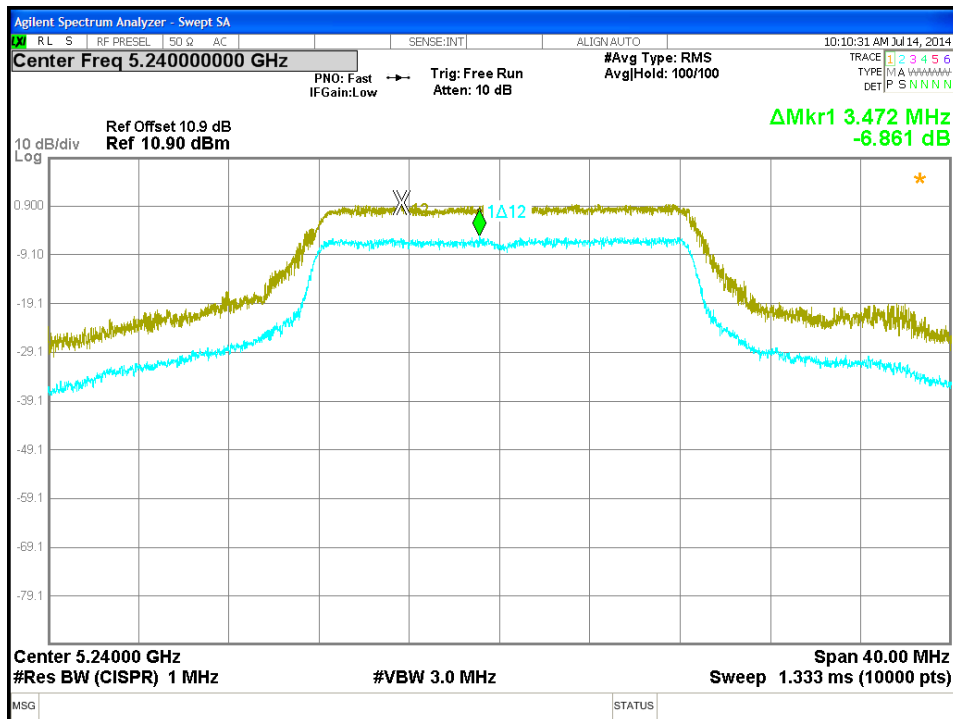

Figure 21: Peak Excursion-5240 MHz-11 a-24Mbps

4.4 Peak Power Spectral Density

According to the CFR47 Part 15.407 (a) (1)(iv) the spectral power density output of the antenna port shall be less than 11 dBm in any 1 MHz band during any time interval of continuous transmission. RSS-210 (A9.2) has the e.i.r.p limit of 10.0 dBm in any 1 MHz.

4.4.1 Test Method

The conducted method was used to measure the peak power spectral density per ANSI C63.10-2009 Section 6.11.2. The measurement was performed with modulation per CFR47 Part 15.407 (a) and RSS-210 (A9.2). The pre-evaluation was performed to find the worst modes. The worst findings were conducted on 3 channels in frequency range of 5150 MHz to 5250 MHz for the test sample, S/N PP#1. The result indicated below.

Test Setup:

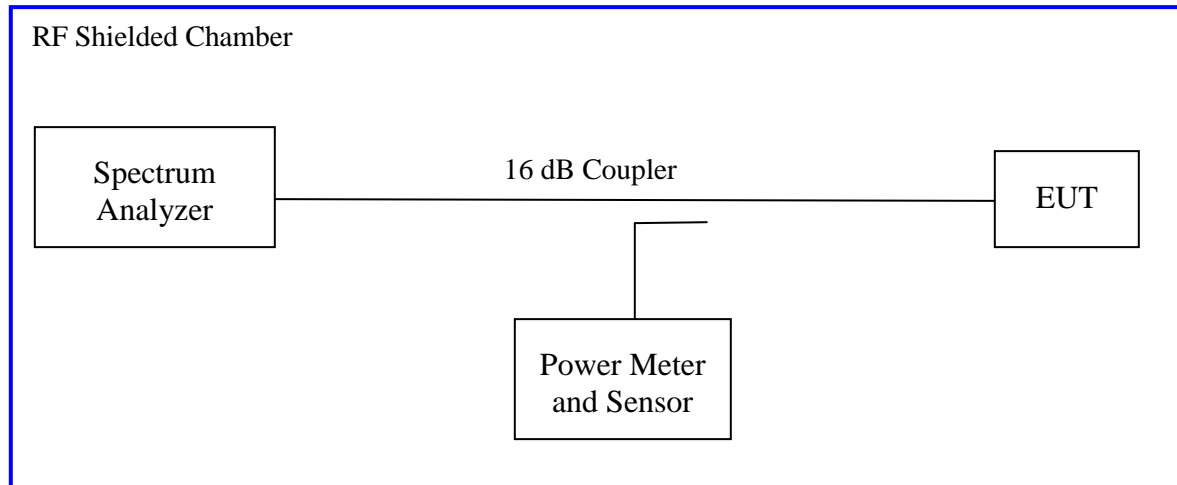

KDB 789033 D02 General UNII Test Procedure New Rules v01, “Guidelines for Compliance Testing of Unlicensed National Information Infrastructure (U-NII) Devices” Section F applies for measuring maximum power spectral density with duty cycle less than 100%. There was no duty cycle correction factor applied.

4.4.2 Results

As originally tested, the EUT was found to be compliant to the requirements of the test standard(s).

Table 6: Maximum Power Spectral Density – Test Results

| Test Conditions: Conducted Measurement | | Test Date: July 11, 2014 | |
|--|----------------|--------------------------------------|----------------|
| Antenna Type: Integrated | | Power Setting: SPW 0 | |
| Antenna Gain: + 2.16 dBi | | Signal State: Modulated. | |
| Ambient Temp.: 22 °C | | Relative Humidity: 35% | |
| Maximum Power Spectral Density | | | |
| 802.11a Mode | | | |
| Freq. [MHz] | Limit [dBm] | Max. Power Spectral Density [dBm] | Margin [dB] |
| 5180 | 4.00 | -4.12 | -8.12 |
| 5200 | 4.00 | -3.92 | -7.92 |
| 5240 | 4.00 | -3.02 | -7.02 |
| Note: 1. The maximum power spectral density was observed at 802.11a 6 Mbps at 100% duty cycle. 2. The conducted maximum spectral density limit with 6dBi antenna for CFR47 Part 15.407 (a)(1)(iv) is 17.0 dBm, and it is 4.0 dBm for RSS210 Sect. 9.2. The 4.0 dBm limit is used to show compliance to both standards. | | | |

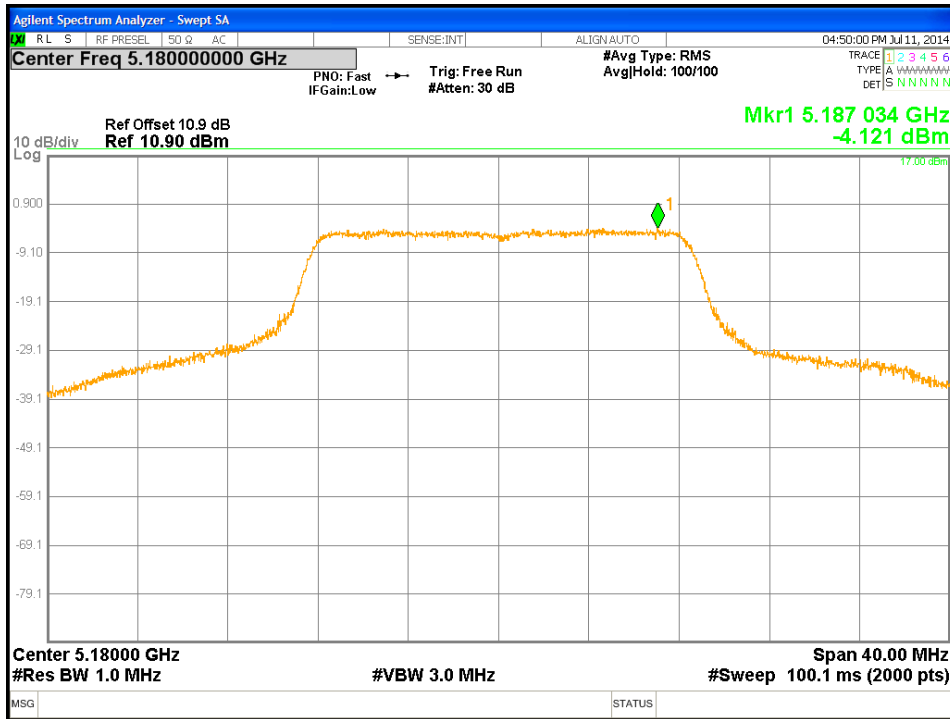

Figure 22: Maximum Power Spectral Density-5180 MHz-11a-6Mbps

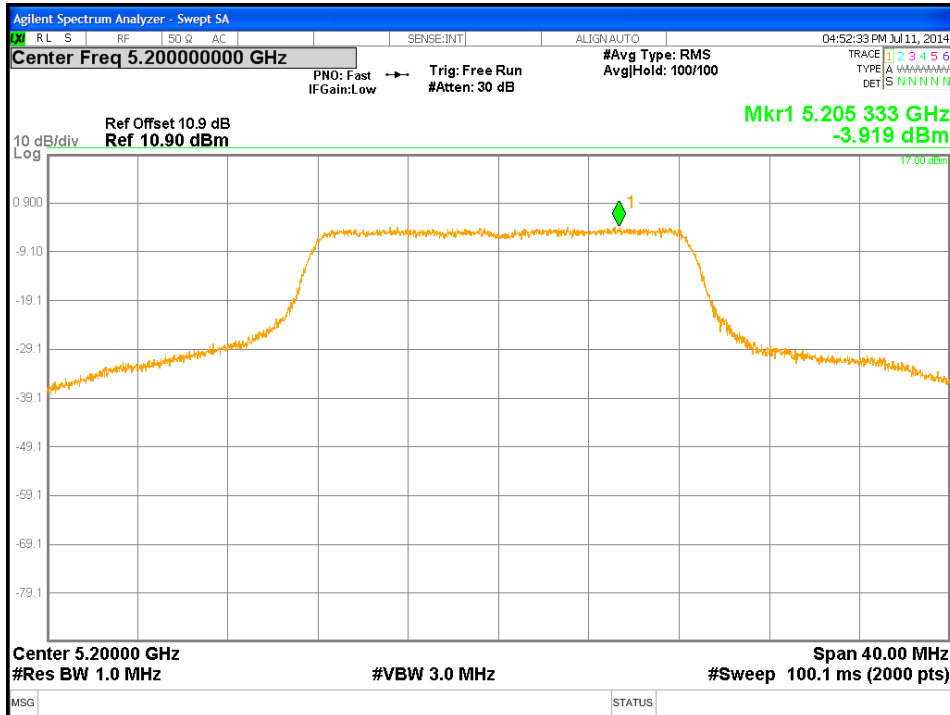

Figure 23: Maximum Power Spectral Density-5200 MHz-11a-6Mbps

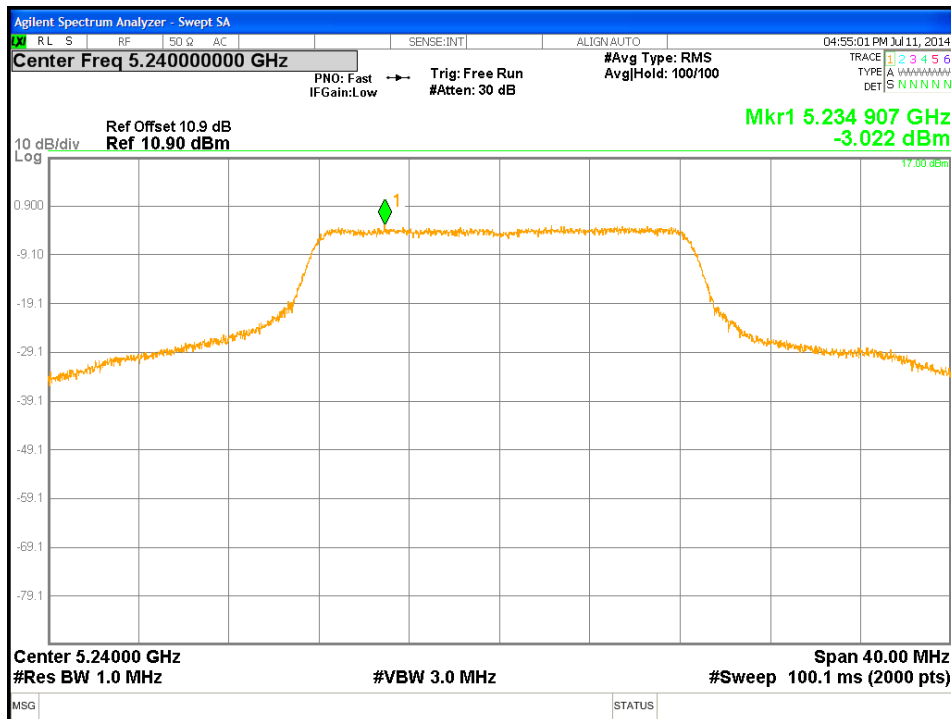

Figure 24: Maximum Power Spectral Density-5240 MHz-11a-6Mbps

4.5 Transmitter Spurious Emissions

Transmitter spurious emissions are emissions outside the frequency range of the equipment when the equipment is in transmit mode; per requirement of CFR47 15.205, 15.209, 15.407(b), RSS-210 Sect. A.9.2

4.5.1 Test Methodology

4.5.1.1 Preliminary Test

A test program that controls instrumentation and data logging was used to automate the preliminary RF emission test procedure. The frequency range of interest was divided into sub-ranges to yield a frequency resolution of approximately 120 kHz and provide a reading at each frequency for no more than 12° of turntable rotation. For each frequency sub-range the turntable was rotated 360° while peak emission data was recorded and plotted over the frequency range of interest in horizontal and vertical antenna polarization's.

Preliminary emission profile testing was performed inside the anechoic chamber. The EUT was placed on a 1.0m x 1.5m non-conductive table 80cm above the floor. The EUT was positioned as shown in the setup photographs. The receiving antenna was placed at a distance of 3m at a fixed height of 1m. Measurement equipment was located outside of the chamber. A video camera was placed inside the chamber to view the EUT.

Pre-scans were performed to determine the worst axis, and data rate.

4.5.1.2 Final Test

For each frequency measured, the peak emission was maximized by manipulating the receiving antenna from 1 to 4 meters above the ground plane and placing it at the position that produced the maximum signal strength reading. The turntable was then rotated through 360° while observing the peak signal and placing the EUT at the position that produced maximum radiation. The six highest emissions relative to the limit were measured unless such emissions were more than 20 dB below the limit. If less than six emissions are within 20 dB of the limit, than the noise level of the receiver is measured at frequencies where emissions are expected. Multiples of all oscillator and microprocessor frequencies were also checked.

Final testing was performed on an NSA compliant test site. The EUT was placed on a 1.0m x 1.5m non-conductive table 80cm above the ground plane. The placement of EUT and cables were the same as for preliminary testing and is shown in the setup photographs.

The final scans performed on the worst axis, X-Axis, for three operating channels;

6 Mbps for 802.11a Mode: 5180 MHz, 5200 MHz, 5240 MHz

4.5.1.3 Deviations

None.

4.5.2 Transmitter Spurious Emission Limit

The spurious emissions of the transmitter shall not exceed the values in CFR47 Part 15.205, 15.209: 2013 and RSS-210 A1.1.2 2010.

| Frequency (MHz) | Field strength (microvolts/meter) | Measurement distance (meters) |
|-----------------|--------------------------------------|-------------------------------------|
| 0.009-0.490 | 2400/F (kHz) | 300 |
| 0.490-1.705 | 24000/F (kHz) | 30 |
| 1.705-30.0 | 30 | 30 |
| 30-88 | 100 ** | 3 |
| 88-216 | 150 ** | 3 |
| 216-960 | 200 ** | 3 |
| Above 960 | 500 | 3 |

According to CFR47 15.407 (b), all harmonics and spurious emissions which are outside the 5150 MHz - 5350 MHz shall not exceed -27 dBm/MHz. This is equivalent to 68.2 dBuV/m at 3 meter distance.

4.5.3 Test Results

The final measurement data was taken under the worst case operating modes, configurations, and/or cable positions. It also reflects the results including any modifications and/or special accessories listed in Sections 1.4 and test plan.

As originally tested, the EUT was found to be compliant to the requirements of the test standard(s).

Table 7: Transmit Spurious Emission at Band-Edge Requirements

| Test Conditions: Radiated Measurement | | | | Test Date: July 18, 2014 | | | | |
|--|----------------|----------------|----------------|-------------------------------------|------|------------|------------|--------------------|
| Antenna Type: Integrated | | | | Power Setting: See test plan | | | | |
| Max. Antenna Gain: +2.16 dBi | | | | Signal State: Modulated | | | | |
| Ambient Temp.: 23 °C | | | | Relative Humidity: 33% | | | | |
| Band-Edge Results | | | | | | | | |
| Freq. (MHz) | Level (dBuV/m) | Polarity (H/V) | Limit (dBuV/m) | Margin (dB) | Det. | Table Deg. | Tower (cm) | Note |
| 5150.00 | 56.42 | V | 74.00 | -17.58 | Pk | 261 | 196 | 5180 MHz-11a-6Mbps |
| 5150.00 | 45.90 | V | 54.00 | -8.10 | Ave | 261 | 196 | 5180 MHz-11a-6Mbps |
| 5150.00 | 60.07 | H | 74.00 | -13.93 | Pk | 201 | 339 | 5180 MHz-11a-6Mbps |
| 5150.00 | 48.51 | H | 54.00 | -5.49 | Ave | 201 | 339 | 5180 MHz-11a-6Mbps |
| 5150.00 | 53.90 | H | 74.00 | -20.10 | Pk | 203 | 299 | 5240 MHz-11a-6Mbps |
| 5150.00 | 43.48 | H | 54.00 | -10.52 | Ave | 203 | 299 | 5240 MHz-11a-6Mbps |
| 5150.00 | 53.44 | V | 74.00 | -20.56 | Pk | 224 | 218 | 5240 MHz-11a-6Mbps |
| 5150.00 | 42.83 | V | 54.00 | -11.17 | Ave | 224 | 218 | 5240 MHz-11a-6Mbps |
| <p>Note:</p> <ol style="list-style-type: none"> 1. Band-edge frequencies were taken at 5150 MHz since 5250-5350 MHz band is not a restricted band. 2. All the band-edge measurements met the restricted band requirements of CFR47 15.205. 3. It is also complied with the -27 dBm/MHz (68.2dBuV/m at 3m) requirements as stated in CFR47 15.407 (b) (1). 4. It is also confirm that the 20dBr point of the highest channel in each mode is within the 5150-5250 MHz range. | | | | | | | | |

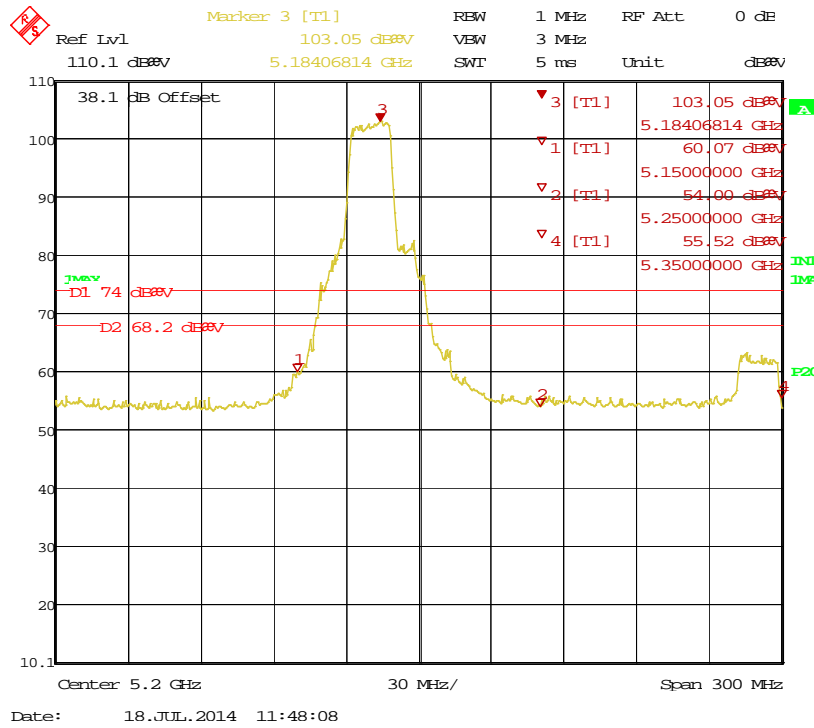

Figure 25: Bandedge-5180 MHz-11a-H-Pk

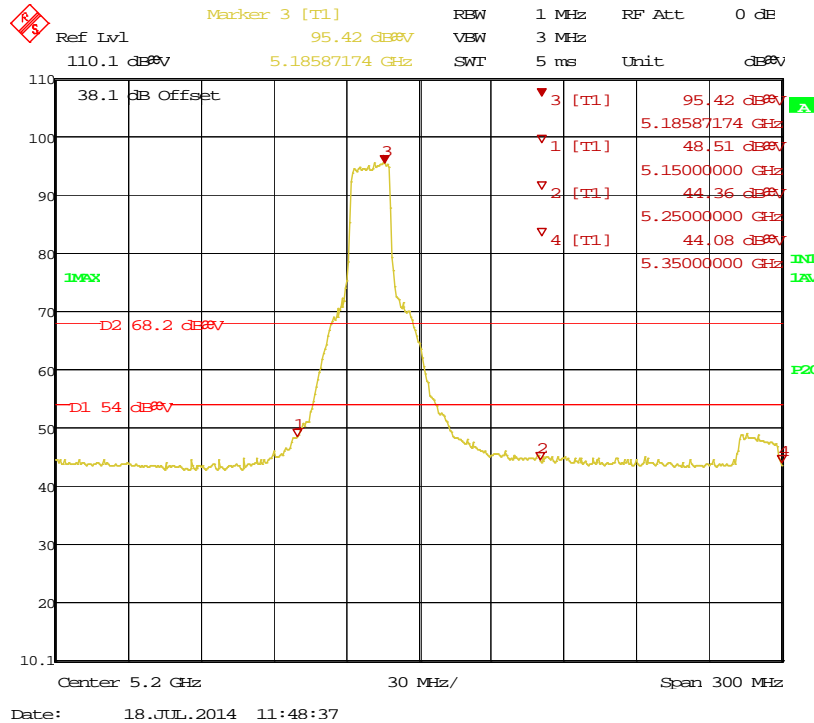
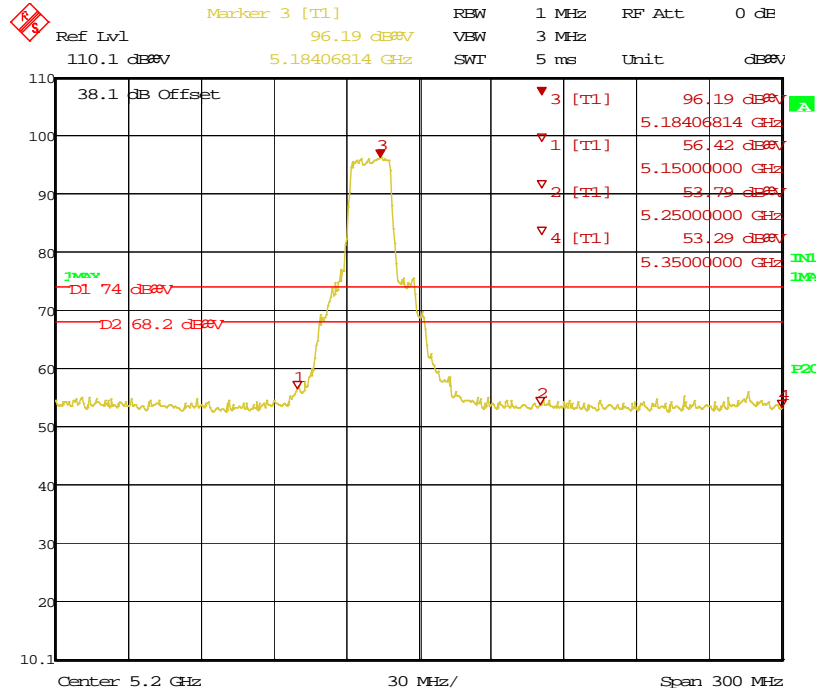
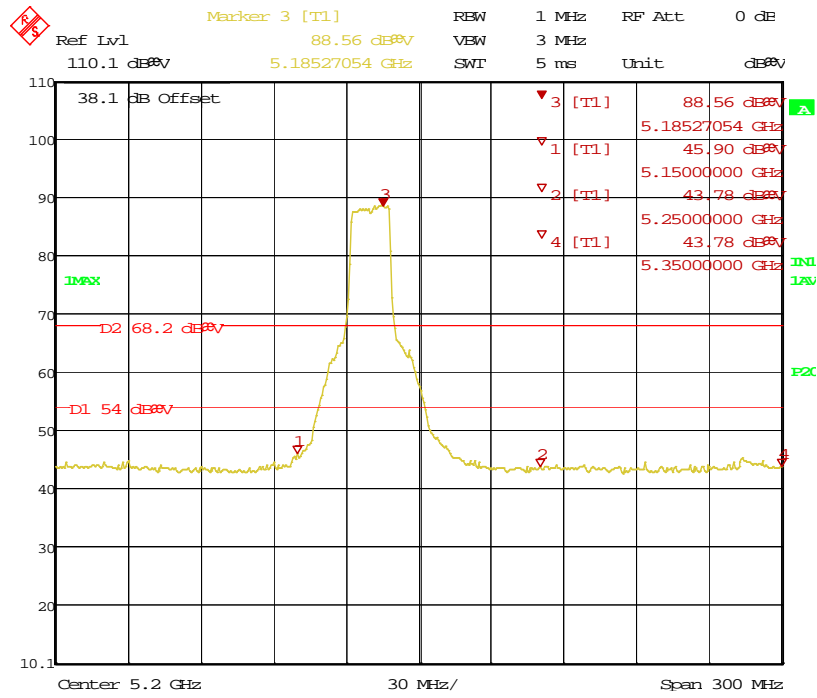

Figure 26: Bandedge-5180 MHz-11a-H-Ave



Date: 18.JUL.2014 11:44:17

Figure 27: Bandedge-5180 MHz-11a-V-pk



Date: 18.JUL.2014 11:45:06

Figure 28: Bandedge-5180 MHz-11a-V-Ave

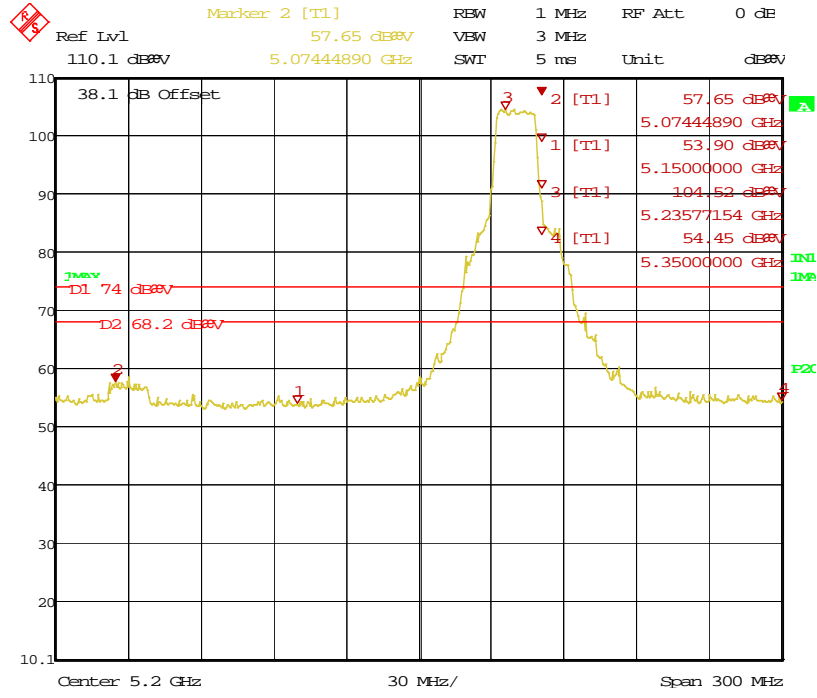

Date: 18.JUL.2014 11:53:18

Figure 29: Bandedge-5240 MHz-11a-H-Pk

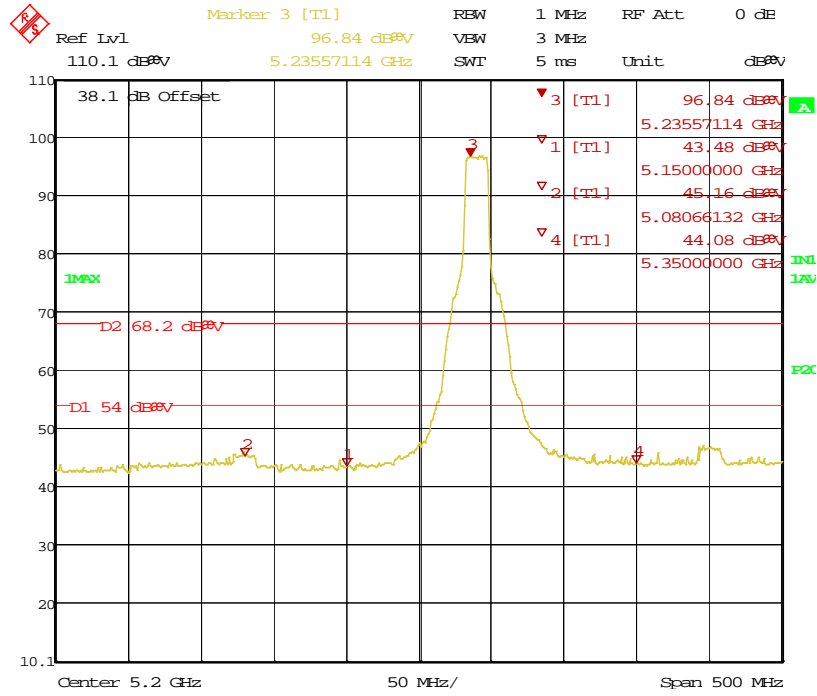

Date: 18.JUL.2014 11:54:34

Figure 30: Bandedge-5240 MHz-11a-H-Ave

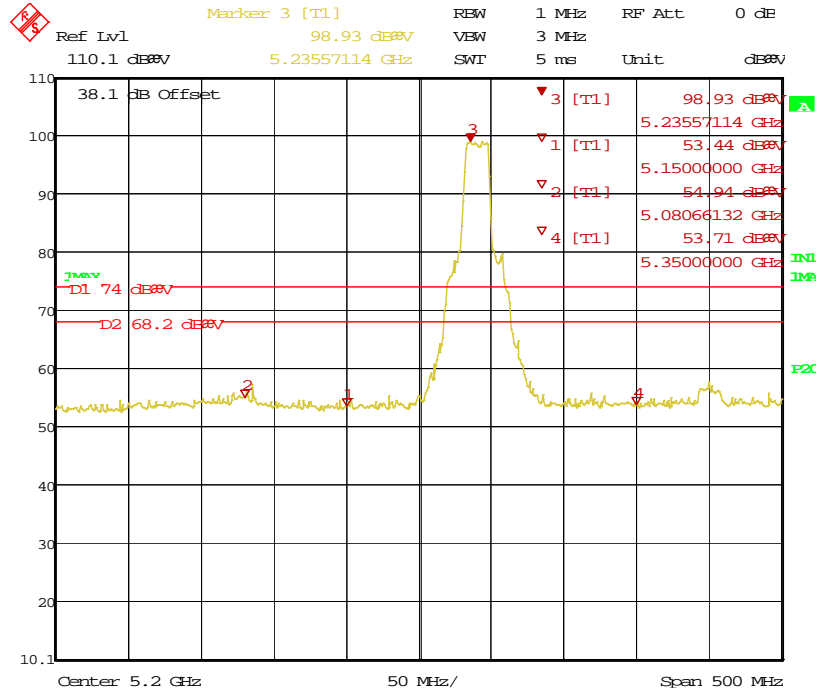

Date: 18.JUL.2014 11:57:19

Figure 31: Bandedge-5240 MHz-11a-V-Pk

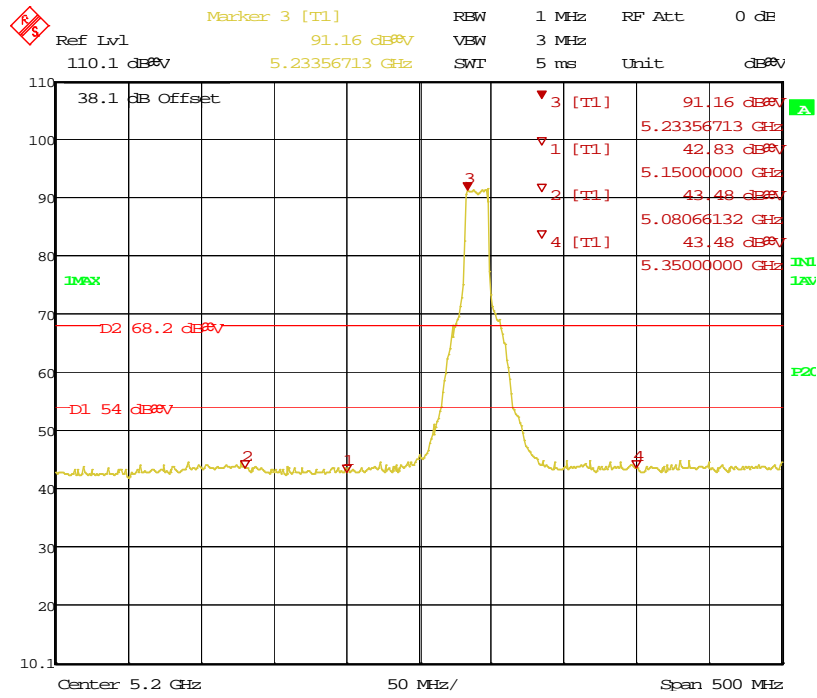

Date: 18.JUL.2014 11:57:43

Figure 32: Bandedge-5240 MHz-V-Ave

| SOP 1 Radiated Emissions | | | | | | | | | | | | Tracking # 31462910.001 Page 1 of 9 | |
|---|--------|---------------------------------|--------|--------|------|------|-------|-----------------------|--------|------------------|--------|-------------------------------------|--|
| EUT Name | | Wireless Audio Transmitter | | | | | | Date | | July 10, 2014 | | | |
| EUT Model | | Ear Force Stealth 500X TX | | | | | | Temp / Hum in | | 23° C / 35%rh | | | |
| EUT Serial | | PP#2 | | | | | | Temp / Hum out | | N/A | | | |
| EUT Config. | | 802.11a on X-Axis (30 MHz-1GHz) | | | | | | Line AC / Freq | | 5 VDC | | | |
| Standard | | CFR47 Part 15 Subpart C | | | | | | RBW / VBW | | 120 kHz/ 300 kHz | | | |
| Dist/Ant Used | | 3m / JB3 | | | | | | Performed by | | Jeremy Luong | | | |
| Freq. | Raw | Cbl | AF | Level | Det. | Pol. | Hght. | Azt | Limit | Margin | Result | | |
| MHz | dBuV/m | dB | dB | dBuV/m | | H/V | cm | deg | dBuV/m | dB | | | |
| Transmitted Data at 802.11a, 5180 MHz | | | | | | | | | | | | | |
| 276.08 | 46.06 | 1.93 | -19.30 | 28.70 | QP | H | 121 | 78 | 46.00 | -17.31 | Pass | | |
| 276.81 | 39.33 | 1.93 | -19.30 | 21.97 | QP | H | 110 | 212 | 46.00 | -24.03 | Pass | | |
| 283.69 | 41.46 | 1.95 | -19.22 | 24.18 | QP | H | 148 | 78 | 46.00 | -21.82 | Pass | | |
| 92.33 | 49.72 | 1.50 | -24.87 | 26.35 | QP | V | 163 | 166 | 43.50 | -17.15 | Pass | | |
| 93.60 | 49.22 | 1.51 | -24.54 | 26.18 | QP | V | 183 | 166 | 43.50 | -17.32 | Pass | | |
| 95.81 | 45.69 | 1.51 | -23.92 | 23.28 | QP | V | 242 | 166 | 43.50 | -20.22 | Pass | | |
| Spec Margin = Level - Limit, Level = Raw+ Cbl+ CF ± Uncertainty | | | | | | | | | | | | | |
| CF= Amp Gain + ANT Factor | | | | | | | | | | | | | |
| Combined Standard Uncertainty $u_c(y) = \pm 4.52$ dB Expanded Uncertainty $U = k u_c(y)$ $k = 2$ for 95% confidence | | | | | | | | | | | | | |
| Note: The worst case was observed at 802.11a, 5180 MHz. All other emissions passed Class B limit. | | | | | | | | | | | | | |

SOP 1 Radiated Emissions

Tracking # 31462910.001 Page 2 of 8

| | | | |
|----------------------|----------------------------|-----------------------|------------------|
| EUT Name | Wireless Audio Transmitter | Date | July 10, 2014 |
| EUT Model | Ear Force Stealth 500X TX | Temp / Hum in | 23° C / 35%rh |
| EUT Serial | PP#2 | Temp / Hum out | N/A |
| EUT Config. | 802.11a on X-Axis | Line AC / Freq | 5 VDC |
| Standard | CFR47 Part 15 Subpart C | RBW / VBW | 120 kHz/ 300 kHz |
| Dist/Ant Used | 3m / JB3 | Performed by | Jeremy Luong |

30 MHz to 1GHz Plots for Transmit Mode at 5200 MHz

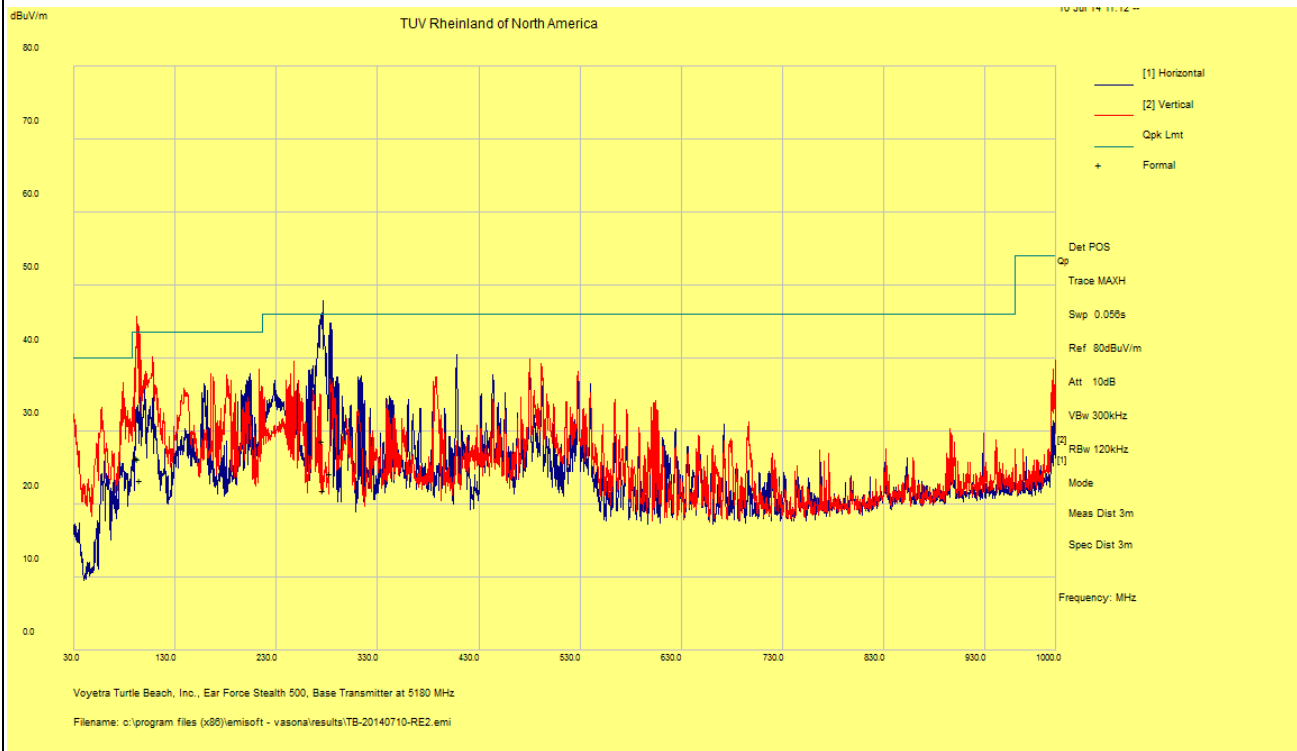

Notes: FCC Class B Limit.

| SOP 1 Radiated Emissions | | | | | | | | | | | Tracking # 31462910.001 Page 3 of 9 | |
|--|--------|------------------------------------|--------|--------|-----|-----|------|-----------------------|--------|---------------|-------------------------------------|--|
| EUT Name | | Wireless Audio Transmitter | | | | | | Date | | July 10, 2014 | | |
| EUT Model | | Ear Force Stealth 500X TX | | | | | | Temp / Hum in | | 23° C / 35%rh | | |
| EUT Serial | | PP#2 | | | | | | Temp / Hum out | | N/A | | |
| EUT Config. | | 802.11a on X-Axis | | | | | | Line AC / Freq | | 120Vac/60Hz | | |
| Standard | | CFR47 Part 15 Subpart C | | | | | | RBW / VBW | | 1 MHz/ 3 MHz | | |
| Dist/Ant Used | | 3m / EMCO3115 / 1m - RA42-K-F-4B-C | | | | | | Performed by | | Jeremy Luong | | |
| Freq | Raw | Cbl | AF | Level | Det | Pol | Hght | Azt | Limit | Margin | Comment | |
| MHz | dBuV/m | dB | dB | dBuV/m | | H/V | cm | deg | dBuV/m | dB | | |
| Transmitted Data at 5180 MHz at 802.11a, 6Mbit/s | | | | | | | | | | | | |
| 6906.90 | 50.53 | 2.01 | -12.24 | 40.30 | Ave | H | 122 | 301 | 54.00 | -13.70 | Spurious | |
| 10357.43 | 49.10 | 2.50 | -8.90 | 42.70 | Ave | H | 262 | 19 | 54.00 | -11.30 | Harmonics | |
| 1989.12 | 52.00 | 1.00 | -23.30 | 29.70 | Ave | V | 243 | 264 | 54.00 | -24.30 | Spurious | |
| Transmitted Data at 5200 MHz at 802.11a, 6Mbit/s | | | | | | | | | | | | |
| 6933.58 | 51.82 | 2.01 | -12.24 | 41.59 | Ave | H | 251 | 312 | 54.00 | -12.41 | Spurious | |
| 10396.82 | 47.20 | 2.50 | -9.10 | 40.70 | Ave | H | 214 | 7 | 54.00 | -13.30 | Harmonics | |
| 1987.64 | 51.40 | 1.00 | -23.30 | 29.10 | Ave | V | 243 | 214 | 54.00 | -24.90 | Spurious | |
| Transmitted Data at 5240 MHz at 802.11a, 6Mbit/s | | | | | | | | | | | | |
| 1987.23 | 49.30 | 1.00 | -23.30 | 27.00 | Ave | H | 180 | 195 | 54.00 | -27.00 | Spurious | |
| 6933.57 | 54.39 | 2.01 | -12.24 | 44.16 | Ave | H | 238 | 342 | 54.00 | -9.84 | Spurious | |
| 10396.57 | 45.90 | 2.50 | -9.10 | 39.40 | Ave | H | 269 | 9 | 54.00 | -14.60 | Harmonics | |
| 2466.19 | 47.70 | 1.20 | -21.50 | 27.40 | Ave | V | 124 | 153 | 54.00 | -26.60 | Spurious | |
| Spec Margin = Level - Limit, Level = Raw+ Cbl+ CF ± Uncertainty | | | | | | | | | | | | |
| CF= Amp Gain + ANT Factor | | | | | | | | | | | | |
| Combined Standard Uncertainty $u_c(y) = \pm 4.93\text{dB}$ Expanded Uncertainty $U = ku_c(y)$ $k = 2$ for 95% confidence | | | | | | | | | | | | |
| Notes: All emissions passed the spurious emission limit. No significant emission was observed from 18GHz to 40GHz. | | | | | | | | | | | | |

SOP 1 Radiated Emissions

Tracking # 31462910.001 Page 4 of 9

| | | | |
|----------------------|------------------------------------|-----------------------|---------------|
| EUT Name | Wireless Audio Transmitter | Date | July 10, 2014 |
| EUT Model | Ear Force Stealth 500X TX | Temp / Hum in | 23° C / 35%rh |
| EUT Serial | PP#2 | Temp / Hum out | N/A |
| EUT Config. | 802.11a on X-Axis | Line AC | 5 VDC |
| Standard | CFR47 Part 15 Subpart C | RBW / VBW | 1 MHz / 3 MHz |
| Dist/Ant Used | 3m - EMCO3115 / 1m - RA42-K-F-4B-C | Performed by | Jeremy Luong |

Above 1GHz Plots for Transmit Mode at 5180 MHz

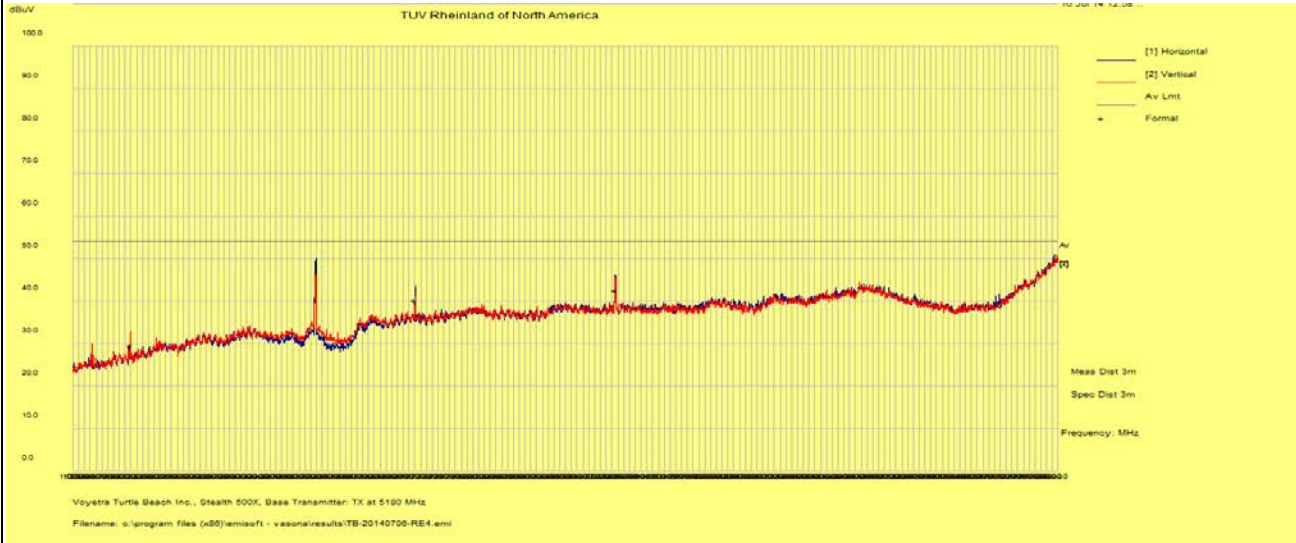

No significant emission was observed.

TUV Rheinland of North America
 Radiated Emissions 18 to 26 GHz at 1 meter Distance
 FCC Class B

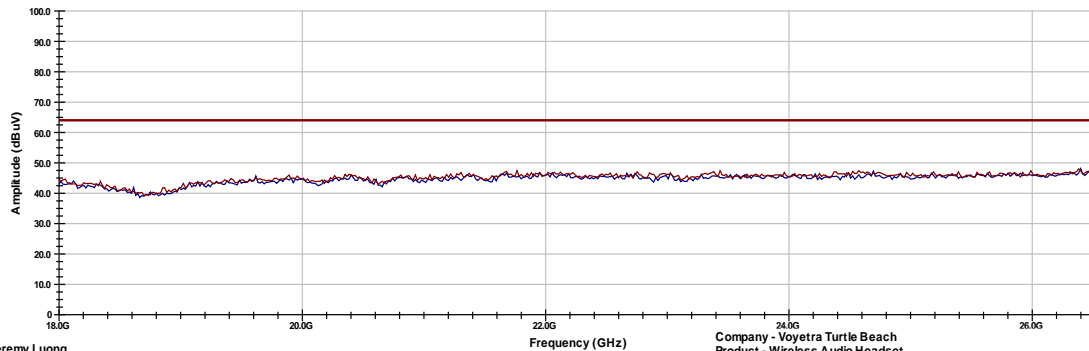

Operator: Jeremy Luong

RE-18GHz-26GHz-12.TL

04:34:57 PM, Tuesday, July 15, 2014

Company - Voyetra Turtle Beach
 Product - Wireless Audio Headset
 Model - Ear Force Stealth 500X
 Serial - PP
 Mode - Base Transmitter: TX at 5180 MHz

Notes: Limit was extrapolated to 1m distance for 18 GHz – 40 GHz range.

SOP 1 Radiated Emissions

Tracking # 31462910.001 Page 5 of 9

| | | | |
|----------------------|----------------------------|-----------------------|---------------|
| EUT Name | Wireless Audio Transmitter | Date | July 16, 2014 |
| EUT Model | Ear Force Stealth 500X TX | Temp / Hum in | 23° C / 32%rh |
| EUT Serial | PP#2 | Temp / Hum out | N/A |
| EUT Config. | 802.11a on X-Axis | Line AC / Freq | 5 VDC |
| Standard | CFR47 Part 15 Subpart C | RBW / VBW | 1 MHz / 3 MHz |
| Dist/Ant Used | 1m - RA42-K-F-4B-C | Performed by | Jeremy Luong |

Above 1GHz Plots for Transmit Mode at 5180 MHz

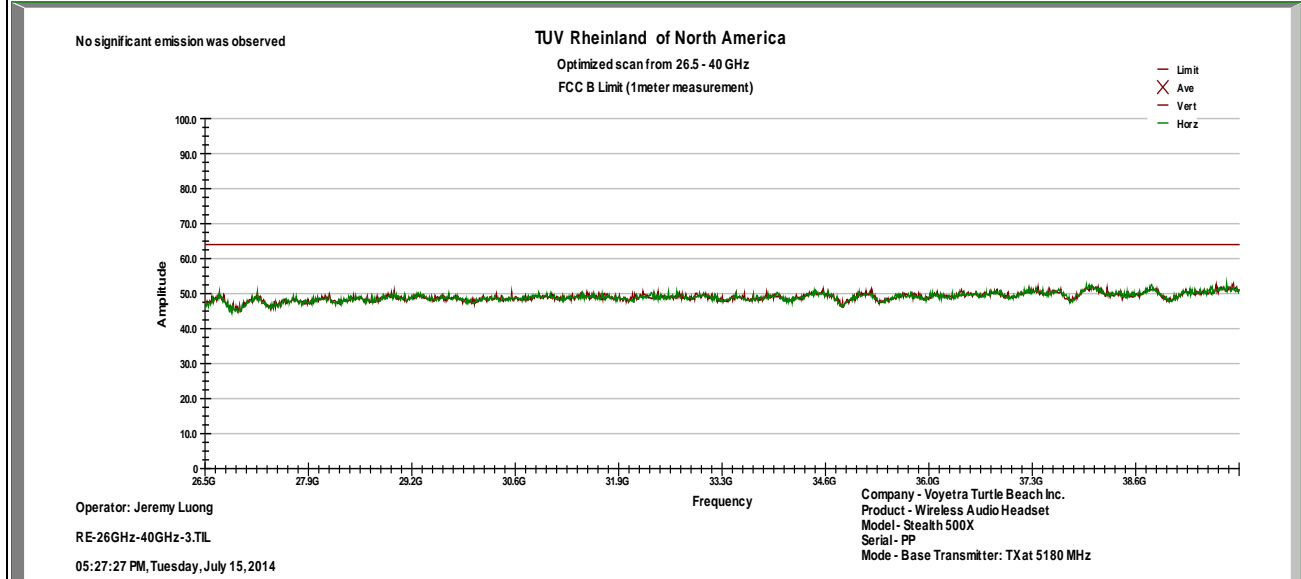

Notes: Limit was extrapolated to 1m distance for 18 GHz – 40 GHz range.

SOP 1 Radiated Emissions

Tracking # 31462910.001 Page 6 of 9

| | | | |
|----------------------|------------------------------------|-----------------------|---------------|
| EUT Name | Wireless Audio Transmitter | Date | July 10, 2014 |
| EUT Model | Ear Force Stealth 500X TX | Temp / Hum in | 23° C / 35%rh |
| EUT Serial | PP#2 | Temp / Hum out | N/A |
| EUT Config. | 802.11a on X-Axis | Line AC / Freq | 5 VDC |
| Standard | CFR47 Part 15 Subpart C | RBW / VBW | 1 MHz / 3 MHz |
| Dist/Ant Used | 3m - EMCO3115 / 1m - RA42-K-F-4B-C | Performed by | Jeremy Luong |

Above 1GHz Plots for Transmit Mode at 5200 MHz

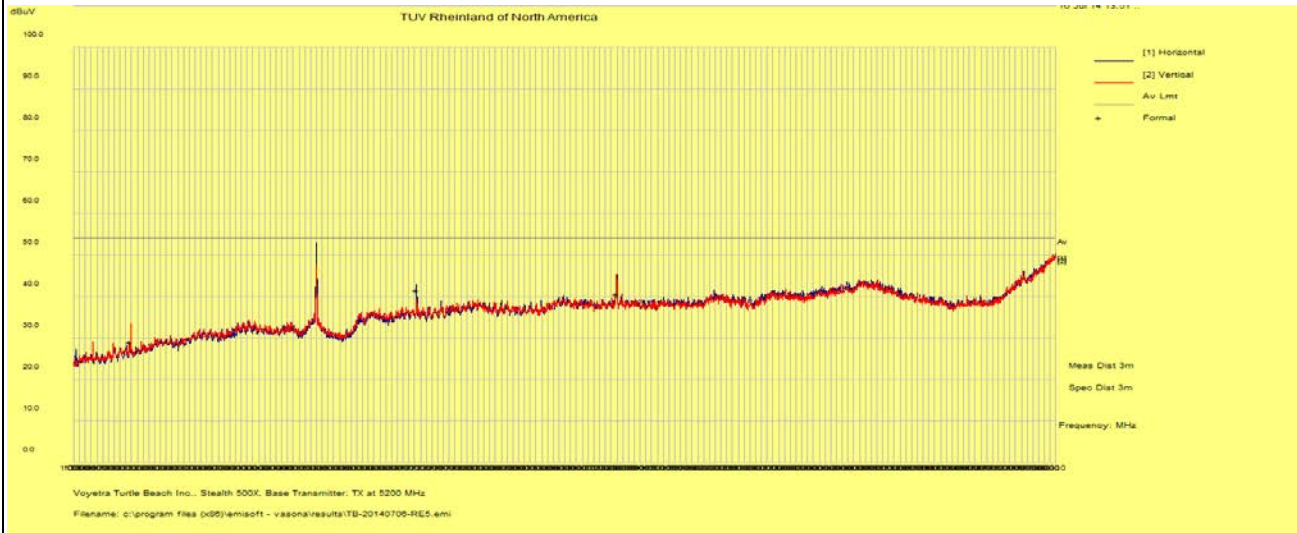

No significant emission was observed.

TUV Rheinland of North America
 Radiated Emissions 18 to 26 GHz at 1 meter Distance
 FCC Class B

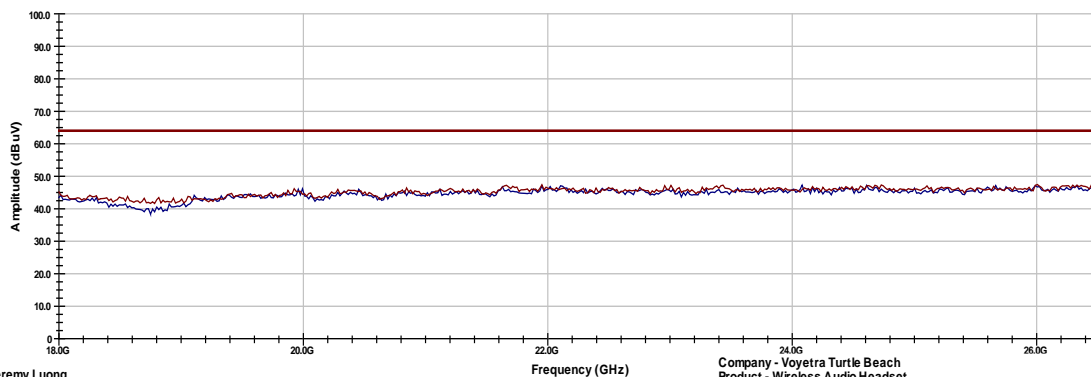

Operator: Jeremy Luong

RE-18GHz-26GHz-13.TIL

04:40:25 PM, Tuesday, July 15, 2014

Company - Voyetra Turtle Beach
 Product - Wireless Audio Headset
 Model - Ear Force Stealth 500X
 Serial - PP
 Mode - Base Transmitter: TX at 5200 MHz

Notes: Limit was extrapolated to 1m distance for 18 GHz – 40 GHz range.

SOP 1 Radiated Emissions

Tracking # 31462910.001 Page 7 of 9

| | | | |
|----------------------|----------------------------|-----------------------|---------------|
| EUT Name | Wireless Audio Transmitter | Date | July 16, 2014 |
| EUT Model | Ear Force Stealth 500X TX | Temp / Hum in | 23° C / 32%rh |
| EUT Serial | PP#2 | Temp / Hum out | N/A |
| EUT Config. | 802.11a on X-Axis | Line AC / Freq | 5 VDC |
| Standard | CFR47 Part 15 Subpart C | RBW / VBW | 1 MHz / 3 MHz |
| Dist/Ant Used | 1m - RA42-K-F-4B-C | Performed by | Jeremy Luong |

Above 1GHz Plots for Transmit Mode at 5200 MHz

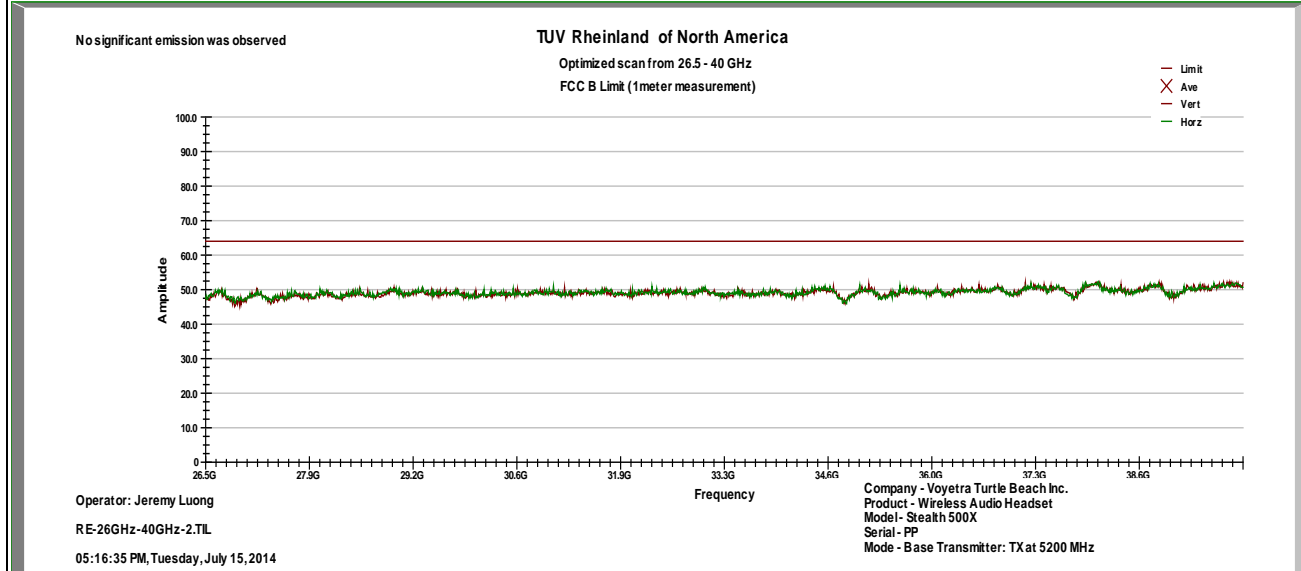

Notes: Limit was extrapolated to 1m distance for 18 GHz – 40 GHz range.

SOP 1 Radiated Emissions

Tracking # 31462910.001 Page 8 of 9

| | | | |
|----------------------|------------------------------------|-----------------------|---------------|
| EUT Name | Wireless Audio Transmitter | Date | July 10, 2014 |
| EUT Model | Ear Force Stealth 500X TX | Temp / Hum in | 23° C / 35%rh |
| EUT Serial | PP#2 | Temp / Hum out | N/A |
| EUT Config. | 802.11a on X-Axis | Line AC / Freq | 5 VDC |
| Standard | CFR47 Part 15 Subpart C | RBW / VBW | 1 MHz / 3 MHz |
| Dist/Ant Used | 3m - EMCO3115 / 1m - RA42-K-F-4B-C | Performed by | Jeremy Luong |

Above 1GHz Plots for Transmit Mode at 5240 MHz

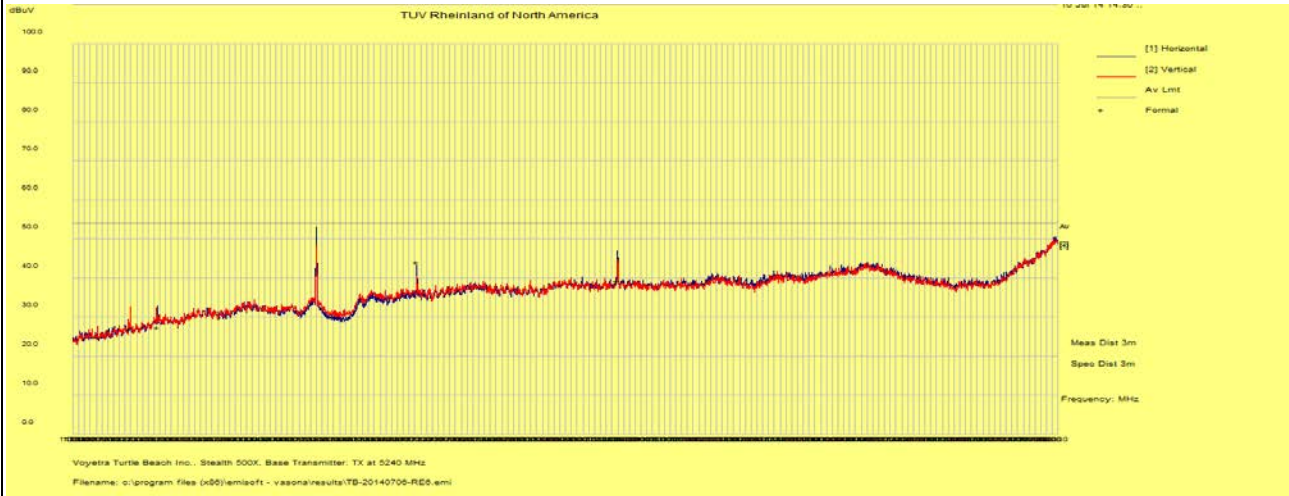

No significant emission was observed.

TUV Rheinland of North America
 Radiated Emissions 18 to 26 GHz at 1 meter Distance
 FCC Class B

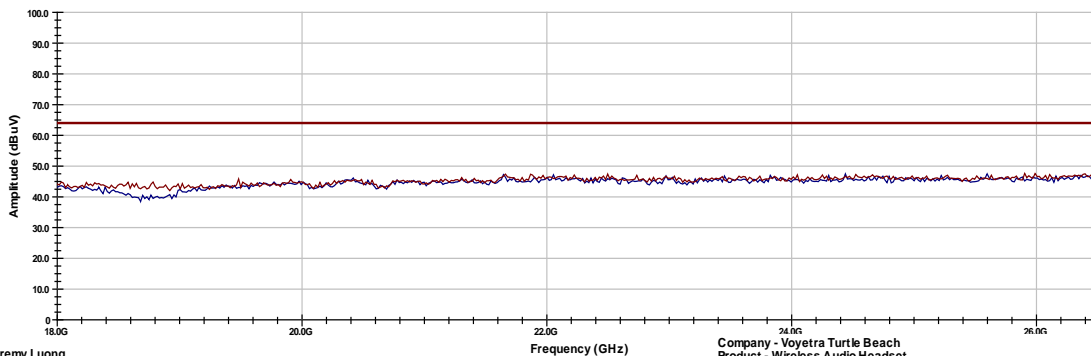

Operator: Jeremy Luong
 RE-18GHz-26GHz-14.TIL
 04:47:43 PM, Tuesday, July 15, 2014

Company - Voyetra Turtle Beach
 Product - Wireless Audio Headset
 Model - Ear Force Stealth 500X
 Serial - PP
 Mode - Base Transmitter: TX at 5240 MHz

Notes: Limit was extrapolated to 1m distance for 18 GHz – 40 GHz range.

SOP 1 Radiated Emissions

Tracking # 31462910.001 Page 9 of 9

| | | | |
|----------------------|----------------------------|-----------------------|---------------|
| EUT Name | Wireless Audio Transmitter | Date | July 16, 2014 |
| EUT Model | Ear Force Stealth 500X TX | Temp / Hum in | 23° C / 32%rh |
| EUT Serial | PP#2 | Temp / Hum out | N/A |
| EUT Config. | 802.11a on X-Axis | Line AC / Freq | 5 VDC |
| Standard | CFR47 Part 15 Subpart C | RBW / VBW | 1 MHz / 3 MHz |
| Dist/Ant Used | 1m - RA42-K-F-4B-C | Performed by | Jeremy Luong |

Above 1GHz Plots for Transmit Mode at 5240 MHz

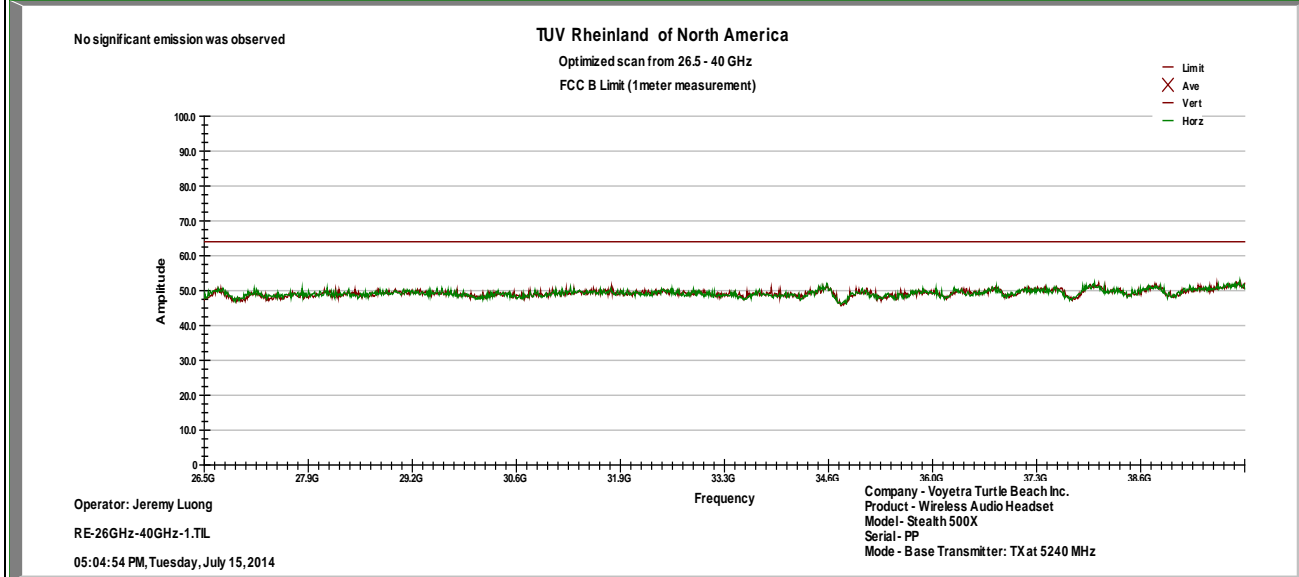

Notes: Limit was extrapolated to 1m distance for 18 GHz – 40 GHz range.

4.5.4 Sample Calculation

The field strength is calculated by subtracting the Amplifier Gain and adding the Cable Loss and Antenna Correction Factor to the measured reading. The basic equation is as follows:

$$\text{Level (dB}\mu\text{V/m)} = \text{Raw} - \text{AMP} + \text{CBL} + \text{ACF}$$

Where: Raw = Field Intensity Meter (dBμV)
 AMP = Amplifier Gain (dB)
 CBL = Cable Loss (dB)
 ACF = Antenna Correction Factor (dB/m)

$$\mu\text{V/m} = 10^{\frac{\text{dB}\mu\text{V} / \text{m}}{20}}$$

4.6 AC Conducted Emissions

Testing was performed in accordance with ANSI C63.4: 2010. These test methods are listed under the laboratory's A2LA Scope of Accreditation.

This test measures the levels emanating from the EUT's AC input port, thus evaluating the potential for the EUT to cause radio frequency interference to other electronic devices.

The AC conducted emissions of equipment under test shall not exceed the values in CFR47 Part 15.207: 2013 and RSS-210: 2010.

4.6.1 Test Methodology

A test program that controls instrumentation and data logging was used to automate the AC Power Line Conducted emission test procedure. The frequency range of interest was divided into sub-ranges such as to yield a frequency resolution of 9 kHz. Each phase and neutral of the AC power line were measured with respect to ground. Measurements were performed using a set of 50 μ H / 50 Ω LISNs.

Testing is either performed in Lab 2. The setup photographs clearly identify which site was used. The vertical ground plane used in the semi-anechoic chamber is a 2m x 2m solid aluminum frame and panel, and it is bonded to the horizontal ground plane.

In the case of tabletop equipment, the EUT is placed on a 1.0m x 1.5m non-conductive table 80cm above the ground plane and 40cm from a vertical ground reference plane. The rear of the EUT was positioned flush with the backside of the table and directly over the LISNs. The power and I/O cables were routed over the edge of the table and bundled approximately 40cm from the ground plane. Support equipment was powered from a separate LISN.

4.6.1.1 Deviations

There were no deviations from this test methodology.

4.6.2 Test Results

The Ear Force Stealth 500X TX is powered by 5 VDC via a host USB port. The AC conducted emission is not required.

4.7 Frequency Stability

In accordance with 47 CFR Part 15.407(g) the frequency stability of U-NII devices must be such that an emission is maintained within the band of operation under all conditions of normal operation as specified in the user's manual. The Manufacturer calls out operating temperature ranges of +0° to +50° C

4.7.1 Test Methodology

The manufacturer of the equipment is responsible for ensuring that the frequency stability is such that emissions are always maintained within the band of operation under all conditions. This test performs according to ANSI C63.10-2009 Section 6.8

4.7.2 Manufacturer Declaration

The frequency stability of the reference oscillator sets the frequency stability of the RF transceiver signals. Therefore all of the RF signal should have ± 20 ppm stability.

This stability accounts for room temp tolerance of the crystal oscillator circuit, frequency variation across temperature, and crystal ageing.

Worst case:

5GHz - ± 20 ppm/103 kHz

± 20 ppm at 5 GHz translates to a maximum frequency shift of ± 103 kHz. As the edge of the channels are at least one MHz from either of the band edges, ± 103 kHz is more than sufficient to guarantee that the intentional emission will remain in the band over the entire operating range of the radio.

4.7.3 Limit

CFR47 Part 407(g) - Manufacturers of U-NII devices are responsible for ensuring frequency stability such that an emission is maintained within the band of operation under all conditions of normal operation as specified in the user's manual.

4.7.4 Test results

As originally tested, the EUT was found to be compliant to the requirements of the test standard(s) since the maximum frequency drift was 6.877 ppm.

Table 8: Frequency Stability – Test Results

| Temperature | Time | PPM |
|-------------|--------|----------|
| 0° C | Start | 6.153475 |
| | 2 Min. | 4.705598 |
| | 5 Min | 5.067568 |
| | 10 min | 6.515444 |
| 10° C | Start | 3.619691 |
| | 2 Min. | 2.533784 |
| | 5 Min | 3.98166 |
| | 10 min | 2.533784 |
| 20° C | Start | 2.895753 |
| | 2 Min. | 0.361969 |
| | 5 Min | 2.171815 |
| | 10 min | 0.723938 |
| 30° C | Start | 0.361969 |
| | 2 Min. | 3.257722 |
| | 5 Min | 3.257722 |
| | 10 min | 1.447876 |
| 40° C | Start | 3.98166 |
| | 2 Min. | 4.705598 |
| | 5 Min | 2.171815 |
| | 10 min | 2.533784 |
| 50° C | Start | 5.429537 |
| | 2 Min. | 5.067568 |
| | 5 Min | 6.877413 |
| | 10 min | 5.429537 |

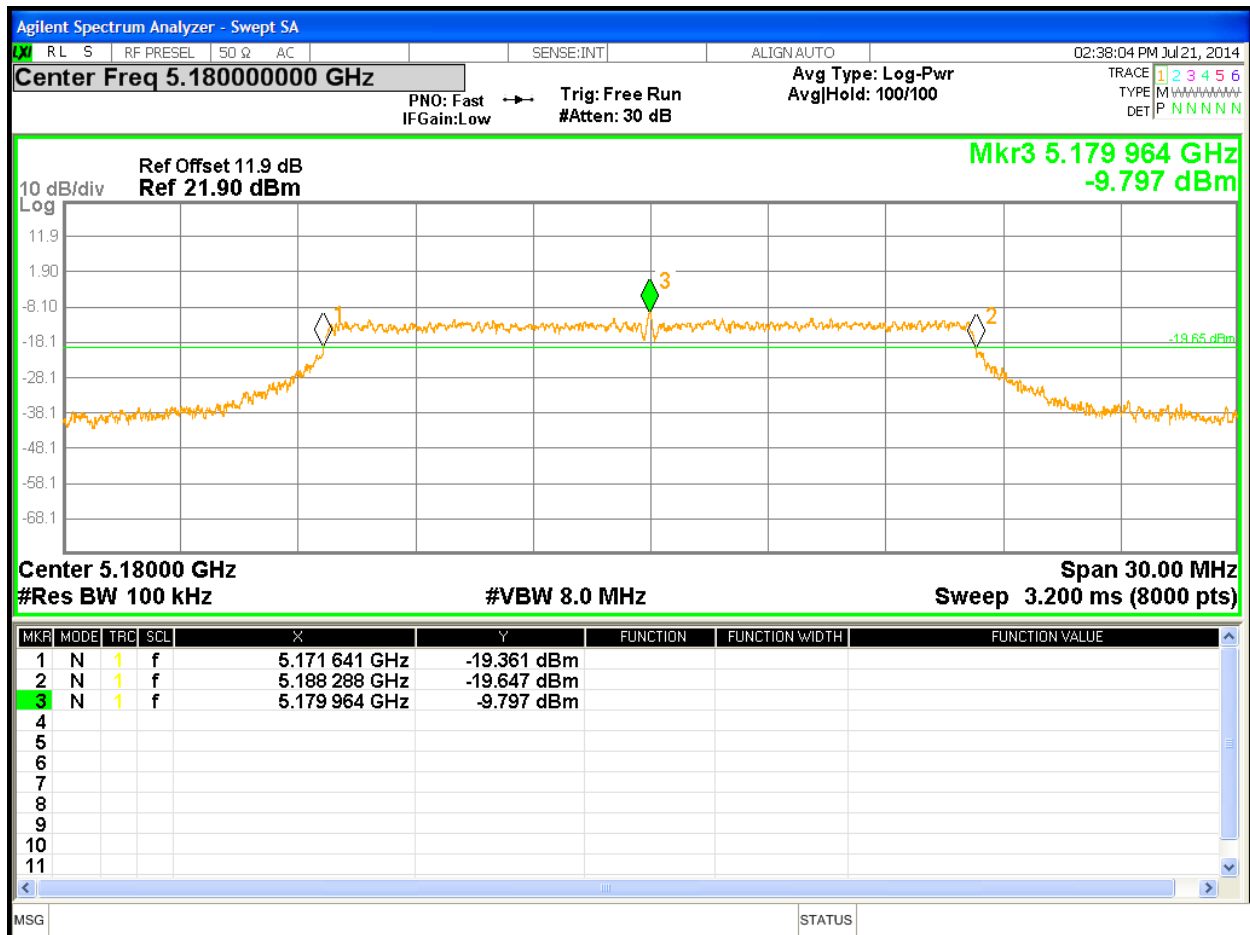

Figure 33: Frequency Stability – Worst Case

4.8 Voltage Variation

In accordance with 47 CFR Part 15.31 (e) intentional radiators, measurements of the variation of the input power or the radiated signal level of the fundamental frequency component of the emission, as appropriate, shall be performed with the supply voltage varied between 85% and 115% of the nominal rated supply voltage. For battery operated equipment, the equipment tests shall be performed using a new battery.

4.8.1 Test Methodology

The dc supply voltage was varied between 85% and 115% of the nominal rated supply voltage. The fundamental frequency was observed during the variation. The EUT was powered by 5 Vdc by a programmable power supply. The voltage was varied from 4.25 Vdc to 5.75 Vdc mean while the fundamental frequencies were observed and record for the maximum drift in ppm; part per millions.

4.8.2 Test results

As originally tested, the EUT was found to be compliant to the requirements of the test standard(s). The fundamental frequencies drifted less than ± 20 ppm.

Table 9: Voltage Variation – Test Results

| Frequency MHz | Nominal (5Vdc) ppm | Lo Voltage (4.25Vdc) ppm | Hi Voltage (5.75Vdc) ppm | Max Drift ppm |
|------------------|--------------------------|--------------------------------|--------------------------------|------------------|
| 5200 | 2.896 | 5.048 | 5.409 | 5.409 |

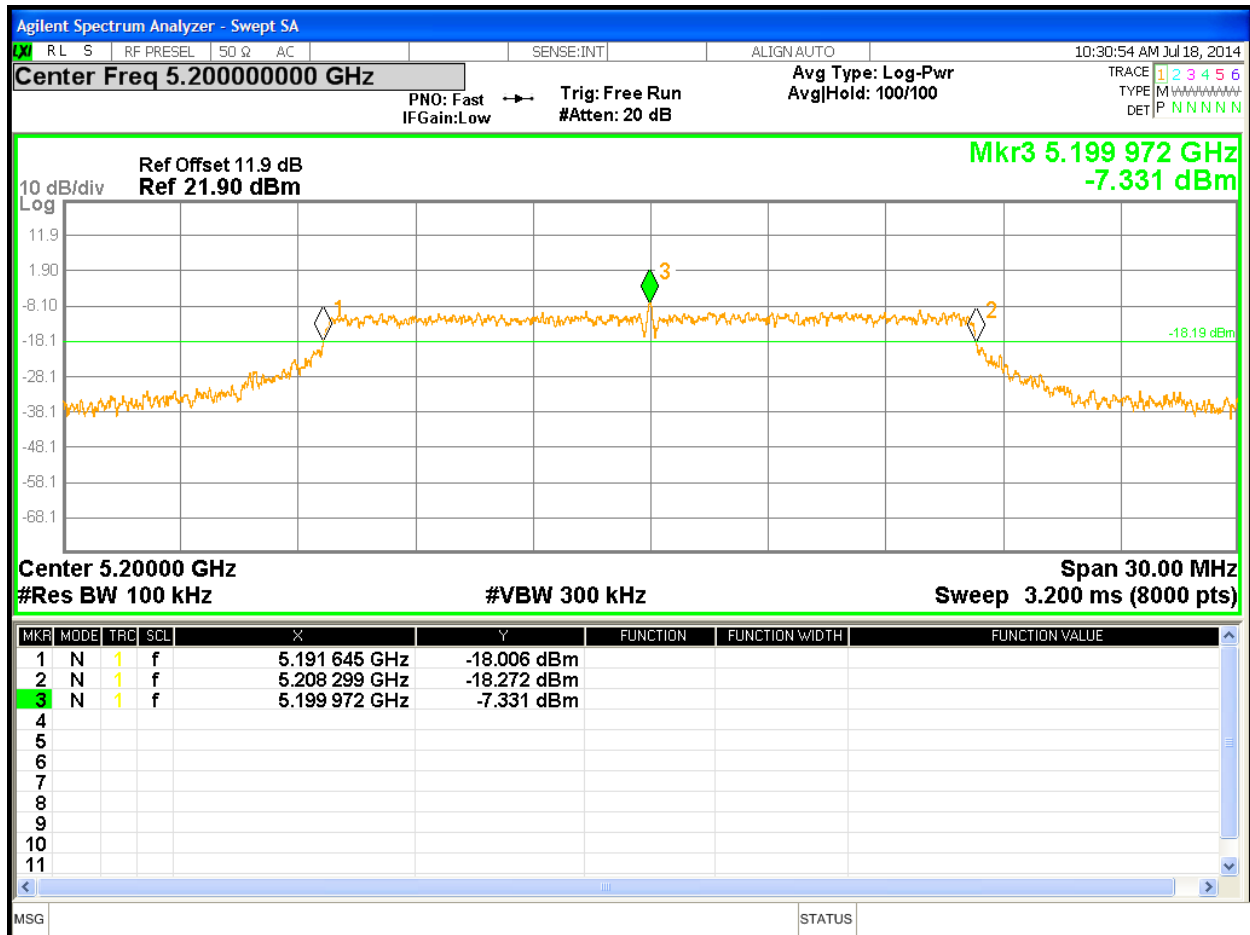

Figure 34: Voltage Variation – Worst Case

4.9 Maximum Permissible Exposure

4.9.1 Test Methodology

In this document, we try to prove the safety of radiation harmfulness to the human body for our product. The limit for Maximum Permissible Exposure (MPE) specified in FCC 1.1310 is followed. The Gain of the antenna used in this calculation is declared by the manufacturer, and the maximum total power input to the antenna is measured. Through the Friis transmission formula and the maximum gain of the antenna, we can calculate the distance, away from the product, where the limit of MPE is reached.

Although the Friis transmission formula is a far field assumption, the calculated result of that is an over-prediction for near field power density. We will take that as the worst case to specify the safety range.

4.9.2 RF Exposure Limit

According to FCC 1.1310 table 1: The criteria listed in the following table shall be used to evaluate the environmental impact of human exposure to radio-frequency (RF) radiation as specified in 1.1307(b)

LIMITS FOR MAXIMUM PERMISSIBLE EXPOSURE (MPE)

| Frequency Range (MHz) | Electric Field Strength (V/m) | Magnetic Field Strength (A/m) | Power Density (mW/cm ²) | Average Time (minutes) |
|---|-------------------------------|-------------------------------|-------------------------------------|------------------------|
| (A)Limits For Occupational / Control Exposures | | | | |
| 0.3–3.0 | 614 | 1.63 | *(100) | 6 |
| 3.0–30 | 1842/f | 4.89/f | *(900/f ²) | 6 |
| 30–300 | ... | ... | 1.0 | 6 |
| 300 - 1500 | ... | ... | f/300 | 6 |
| 1500 - 100,000 | ... | ... | 5 | 6 |
| (B)Limits For General Population / Uncontrolled Exposure | | | | |
| 0.3–1.34 | 614 | 1.63 | *(100) | 30 |
| 1.34-30 | 824/f | 2.19/f | *(180/ f ²) | 30 |
| 30–300 | 27.5 | 0.037 | 0.2 | 30 |
| 300 - 1500 | ... | ... | f/1500 | 30 |
| 1500 - 100,000 | ... | ... | 1.0 | 30 |

F = Frequency in MHz

* = Plane-wave equivalent power density

4.9.3 EUT Operating Condition

The software provided by Manufacturer enabled the EUT to transmit data at lowest, middle and highest channel individually.

4.9.4 Classification

The antenna of the product, under normal use condition, is at least 20cm away from the body of the user. Warning statement to the user for keeping at least 20cm or more separation distance with the antenna should be included in user's manual. So, this device is classified as a **Mobile Device**.

4.9.5 Test Results

4.9.5.1 Antenna Gain

The transmitting antennas were integrated. The directional antenna gain was +2.16 dBi or 1.64 (numeric).

4.9.5.2 Output Power into Antenna & RF Exposure value at distance 20cm:

Calculations for this report are based on highest power measurement.

Limit for MPE (from FCC part 1.1310 table1) is 1.0 mW/cm²

The highest measured total power is +7.72 dBm or 5.916mW

Using the Friss transmission formula, the EIRP is Pout*G, and R is 20cm.

$P_d = (5.916 * 1.64) / (1600\pi) = 0.001931 \text{ mW/cm}^2$, which is 0.9981 mW/cm² below to the limit.

As originally tested, the EUT was found to be compliant to the requirements of the test standard(s).

4.9.6 Sample Calculation

The Friss transmission formula: $P_d = (P_{out} * G) / (4 * \pi * R^2)$

Where;

P_d = power density in mW/cm²

P_{out} = output power to antenna in mW

G = gain of antenna in linear scale

$\pi \approx 3.1416$

R = distance between observation point and center of the radiator in cm

Ref.: David K. Cheng, *Field and Wave Electromagnetics*, Second Edition, Page 640, Eq. (11-133).

6 Test Equipment Use List

6.1 Equipment List

| Equipment | Manufacturer | Model # | Serial/Inst # | Last Cal mm/dd/yy | Next Cal mm/dd/yy |
|---------------------|-----------------|---------------|---------------|-------------------|-------------------|
| Bilog Antenna | Sunol Sciences | JB3 | A020502 | 04/12/2013 | 04/12/2015 |
| Horn Antenna | Sunol Sciences | DRH-118 | A040806 | 11/05/2012 | 11/05/2014 |
| Antenna (18-26GHz) | CMT | RA42-K-F-4B-C | 020131-004 | 07/24/2014 | 07/24/2015 |
| Antenna (26-40 GHz) | CMT | RA28-K-F-4B-C | 011469R-003 | 12/01/2013 | 12/01/2014 |
| Spectrum Analyzer | Agilent | N9038A | MY52260210 | 01/08/2014 | 02/08/2015 |
| Amplifier | Hewlett Packard | 8447D | 2944A07996 | 01/07/2014 | 02/07/2015 |
| Spectrum Analyzer | Rohde & Schwarz | ESIB40 | 832427/002 | 01/08/2014 | 02/08/2015 |
| Amplifier | Miteq | TTA1800-30-4G | 1842452 | 01/08/2014 | 02/08/2015 |
| Amplifier | Rohde & Schwarz | TS-PR26 | 100011 | 07/24/2014 | 07/24/2015 |
| Amplifier | Rohde & Schwarz | TS-PR40 | 100012 | 12/01/2013 | 12/01/2014 |
| Signal Generator | Anritsu | MG3694A | 42803 | 01/07/2013 | 02/07/2015 |
| Notch Filter | Micro-Tronics | BRM50716-02 | 3 | 05/19/2015 | 05/19/2016 |
| Power Meter | Agilent | E4418B | MY45103902 | 01/09/2014 | 02/09/2015 |
| Power Sensor | Hewlett Packard | 8482A | 55-5131 | 01/09/2014 | 02/09/2015 |
| Thermometer | Fluke | 52II | 96480032 | 08/07/2013 | 08/07/2014 |
| Thermo Chamber | Espec | BTZ-133 | 0613436 | 03/17/2014 | 03/17/2015 |
| Spectrum Analyzer | Rohde & Schwarz | FSL6 | 100169 | 01/08/2014 | 02/08/2015 |

* Calibration of equipment past due for re-calibration will be performed expeditiously. If any equipment is found to be out of tolerance at that time, affected customers will be notified accordingly.

7 EMC Test Plan

7.1 Introduction

This section provides a description of the Equipment Under Test (EUT), configurations, operating conditions, and performance acceptance criteria. It is an overview of information provided by the manufacturer so that the test laboratory may perform the requested testing.

7.2 Customer

Table 10: Customer Information

| | |
|-------------------------|----------------------------------|
| Company Name | Voyetra Turtle Beach, Inc. |
| Address | 100 Summit Lake Drive, Suite 100 |
| City, State, Zip | Valhalla, New York 10595 |
| Country | U.S.A. |

Table 11: Technical Contact Information

| | |
|---------------|-------------------|
| Name | Tim Blaney |
| E-mail | tim@commcepts.net |
| Phone | (530) 277-3482 |

7.3 Equipment Under Test (EUT)

Table 12: EUT Specifications

| EUT Specifications | |
|---|--|
| Dimensions | 88.9mm (3.5") x 63.5mm (2.5") x 25.4mm (1.0") |
| Input Voltage | 5 Vdc (via host USB port) |
| Environment | Indoor |
| Operating Temperature Range: | 0 to 50 degrees C |
| Multiple Feeds: | <input type="checkbox"/> Yes and how many <input checked="" type="checkbox"/> No |
| Hardware Version | E70917 |
| Part Number | 309000116985R3 |
| RF Software Version | NA |
| 802.11-radio modules | |
| Operating Mode | 802.11a |
| Transmitter Frequency Band | 5.15 GHz to 5.25 GHz |
| Operating Channels | 5180 MHz, 5200 MHz, 5220 MHz, 5240 MHz |
| Max. Rated Power Output | 7.72 dBm |
| Power Setting @ Operating Channel | SPW 0 |
| Antenna Type | (1) integrated PCB antenna |
| Antenna Gain | Ant1 = 2.16 dBi |
| Modulation Type | <input type="checkbox"/> AM <input type="checkbox"/> FM <input type="checkbox"/> DSSS <input checked="" type="checkbox"/> OFDM <input type="checkbox"/> Other describe: |
| Data Rate | 6, 9, 12, 18, 24 Mbps |
| Type of Equipment | <input checked="" type="checkbox"/> Table Top <input type="checkbox"/> Wall-mount <input type="checkbox"/> Floor standing cabinet <input type="checkbox"/> Other |
| Directional Gain Type | <input checked="" type="checkbox"/> Uncorrelated <input checked="" type="checkbox"/> Non-Beam Forming <input type="checkbox"/> Other describe: |
| Note: This report only documents the radio characteristics for 5150 – 5250 MHz band. | |

Table 13: Interface Specifications

| Interface Type | Cabled with what type of cable? | Is the cable shielded? | Maximum potential length of the cable? | Metallic (M), Coax (C), Fiber (F), or Not Applicable? |
|----------------|---------------------------------|--|---|---|
| USB | USB | <input checked="" type="checkbox"/> No | <input checked="" type="checkbox"/> Metric: 1 m | <input checked="" type="checkbox"/> M |

Table 14: Supported Equipment

| Equipment | Manufacturer | Model | Serial | Used for |
|--------------------|--------------|--------|------------|-----------------------------|
| Laptop | Dell | PP23LB | 9271001233 | Setup EUT operating channel |
| Interface Board | Turtle Beach | N.A | N.A | Access radio chipset |
| Note: None. | | | | |

Table 15: Description of Sample used for Testing

| Device | Serial | RF Connection | CFR47 Part 15.247 |
|---------------------------|--------|---------------------------|--|
| Ear Force Stealth 500X TX | PP #2 | Integrated Antenna | TX Emissions |
| | PP #1 | Direct via SMA Connection | Peak Transmit Power, Peak Power Spectral Density, Peak Excursion Ratio Occupied Bandwidth Frequency Stability Voltage Variation |

Table 16: Description of Test Configuration used for Radiated Measurement.

| Device | Antenna | Mode | Setup Photo (X-Axis) | Setup Photo (Y-Axis) | Setup Photo (Z-Axis) |
|--|------------|----------|----------------------|----------------------|----------------------|
| Ear Force Stealth 500X TX | Integrated | Transmit | EUT laid flat. | N/A | N/A |
| Note: The Ear Force Stealth 500X TX is designed and intended to lay flat. All emission scans performed on the X-Axis. | | | | | |

Table 17: Final Test Mode for 5150 - 5250 Bands

| Test | 802.11a |
|---|---|
| Occupied Bandwidth FCC Part 15.407(a), RSS210 Sect. 9.2 | 5180, 5220, 5240 MHz at 6Mbps |
| Output Power FCC Part 15.407(a)(1)(iv), RSS210 Sect. 9.2 | 5180, 5220, 5240 MHz at 6Mbps |
| Peak Excursion Ratio Information Only. | 5180, 5220, 5240 MHz at 6, 9, 12, 18, 24Mbps |
| Peak Power Spectral Density FCC Part 15.407(a)(1)(iv), RSS210 Sect. 9.2 | 5180, 5220, 5240 MHz at 6Mbps |
| Band-Edge (Radiated) FCC Part 15.205, 15.209, 15.407(b) | 5180, 5240 MHz at 6Mbps |
| Transmitted Spurious Emission (30 MHz – 1GHz) FCC Part 15.205, 15.209, 15.407(b) | 5180 MHz at 6 Mbps |
| Transmitted Spurious Emission (Above 1GHz) FCC Part 15.205, 15.209, 15.407(b) | 5180, 5220, 5240 MHz at 6Mbps |
| Conducted Spurious Emission (antenna port). FCC Part 15.407 (b) | According to CFR47 15.407 (b) EIPR shall not exceed -27 dBm/MHz. This is equivalent to the field strength of 68.2dBuV/m at 3 meter distance. The EUT is satisfied the requirement by meeting the limit under CFR47 Part 15.209. |
| AC Conducted Emission FCC Part 15.207 | EUT is powered by 5VDC via host USB port. Test Not required. |
| Frequency Stability FCC Part 15.407 (g) | 5180 MHz at 6 Mbps |
| Voltage Variation FCC Part 15.31 (e) | 5200 MHz at 6 Mbps |
| Dynamic Frequency Selection FCC Part 15.407 (h) | 5150 – 5250 MHz band does not support DFS. |
| Note: 1. Band 5150 MHz – 5250 MHz support only 802.11a. 2. All radiated emission performed on X-Axis. 3. All tests were pre-scanned for worst case before final testing. | |

7.4 Test Specifications

Testing requirements

Table 18: Test Specifications

| Emissions and Immunity | |
|----------------------------------|-------------|
| Standard | Requirement |
| CFR 47 Part 15.407: 2014 June 23 | All |
| RSS-210 Issue 8, 2010 | All |

END OF REPORT