

Test of Ear Force XP510 TX Wireless Audio
Transmitter
Ear Force PX51 TX Wireless Audio Transmitter
To: FCC 47 CFR Part 15.407 & IC RSS-210

Test Report Serial No.: COMM20-U2 Rev A



TEST REPORT

FROM



Test of Ear Force XP510 TX Wireless Audio Transmitter
Ear Force PX51 TX Wireless Audio Transmitter

to

To FCC 47 CFR Part 15.407 & IC RSS-210

Test Report Serial No.: COMM20-U2 Rev A

Note: this report contains data with regard to the 5,150 to 5,250 MHz band for Turtle Beach, Ear Force XP510 TX Wireless Audio Transmitter. 2.4 GHz test data are reported in MiCOM Labs test report COMM20-U1

This report supersedes None

Applicant: Voyetra Turtle Beach Inc
100 Summit Lake Drive, Suite 100
Valhalla
New York, 10595, USA

Product Function: Wireless Audio Transmitter

Copy No: pdf Issue Date: 12th February 2013

This Test Report is Issued Under the Authority of:

MiCOM Labs, Inc.
440 Boulder Court, Suite 200
Pleasanton, CA 94566 USA
Phone: +1 (925) 462-0304
Fax: +1 (925) 462-0306
www.micomlabs.com



TEST CERTIFICATE #2381.01

MiCOM Labs is an ISO 17025 Accredited Testing Laboratory



Title: Ear Force XP510 TX Wireless Audio Transmitter
To: FCC 47 CFR Part 15.407 & IC RSS-210
Serial #: COMM20-U2 Rev A
Issue Date: 12th February 2013
Page: 3 of 67

This page has been left intentionally blank

This test report may be reproduced in full only. The document may only be updated by MiCOM Labs personnel. Any changes will be noted in the Document History section of the report.



TABLE OF CONTENTS

ACCREDITATION, LISTINGS & RECOGNITION	5
TESTING ACCREDITATION	5
RECOGNITION	6
PRODUCT CERTIFICATION	7
1. TEST RESULT CERTIFICATE	9
2. REFERENCES AND MEASUREMENT UNCERTAINTY	10
2.1. Normative References.....	10
2.2. Test and Uncertainty Procedures.....	11
3. PRODUCT DETAILS AND TEST CONFIGURATIONS	12
3.1. Technical Details	12
3.2. Scope of Test Program	13
3.3. Equipment Model(s) and Serial Number(s).....	17
3.4. Antenna Details	17
3.5. Cabling and I/O Ports	17
3.6. Test Configurations	18
3.7. Equipment Modifications	19
3.8. Deviations from the Test Standard	19
3.9. Subcontracted Testing or Third Party Data	19
4. TESTING EQUIPMENT CONFIGURATION(S)	20
4.1. Conducted RF Emission Test Set-up	20
4.2. Radiated Spurious Emission Test Set-up > 1 GHz	21
4.3. Digital Emissions Test Set-up (0.03 – 1 GHz).....	22
4.4. ac Wireline Emission Test Set-up	23
5. TEST SUMMARY	24
6. TEST RESULTS	26
6.1. Device Characteristics.....	26
6.1.1. <i>Conducted Testing</i>	26
6.1.2. <i>Radiated Emission Testing</i>	40
6.1.3. <i>AC Wireline Conducted Emissions (150 kHz – 30 MHz)</i>	52
7. PHOTOGRAPHS	54
7.1. Test Setup - Radiated Emissions < 1 GHz.....	54
7.2. Test Setup - Radiated Emissions > 1 GHz.....	55
8. TEST EQUIPMENT DETAILS	56
APPENDIX	57
A. SUPPORTING INFORMATION	57
A.1. CONDUCTED TEST PLOTS	57
A.1.1. <i>26 dB & 99% Bandwidth</i>	58
A.1.2. <i>Peak Power Spectral Density</i>	61
A.1.3. <i>Peak Excursion Ratio</i>	64

This test report may be reproduced in full only. The document may only be updated by MiCOM Labs personnel. Any changes will be noted in the Document History section of the report.

ACCREDITATION, LISTINGS & RECOGNITION

TESTING ACCREDITATION

MiCOM Labs, Inc. is an accredited Electrical testing laboratory per the international standard EN ISO/IEC 17025. The company is accredited by the American Association for Laboratory Accreditation (A2LA) www.a2la.org test laboratory number 2381.01. MiCOM Labs test schedule is available at the following URL; <http://www.a2la.org/scopepdf/2381-01.pdf>



This test report may be reproduced in full only. The document may only be updated by MiCOM Labs personnel. Any changes will be noted in the Document History section of the report.



Title: Ear Force XP510 TX Wireless Audio Transmitter
To: FCC 47 CFR Part 15.407 & IC RSS-210
Serial #: COMM20-U2 Rev A
Issue Date: 12th February 2013
Page: 6 of 67

RECOGNITION

MiCOM Labs, Inc has widely recognized Electrical testing capabilities. Our international recognition includes Conformity Assessment Body designation by APEC MRA** countries. Our test reports are widely accepted for global type approvals.

Country	Recognition Body	Status	Phase	Identification No.
USA	Federal Communications Commission (FCC)	TCB	-	US0159 Listing #: 102167
Canada	Industry Canada (IC)	FCB	APEC MRA 2	US0159 Listing #: 4143A-2
Japan	MIC (Ministry of Internal Affairs and Communication)	CAB	APEC MRA 2	RCB 210
	VCCI	--	--	A-0012
Europe	European Commission	NB	EU MRA	NB 2280
Australia	Australian Communications and Media Authority (ACMA)	CAB	APEC MRA 1	US0159
Hong Kong	Office of the Telecommunication Authority (OFTA)	CAB	APEC MRA 1	
Korea	Ministry of Information and Communication Radio Research Laboratory (RRL)	CAB	APEC MRA 1	
Singapore	Infocomm Development Authority (IDA)	CAB	APEC MRA 1	
Taiwan	National Communications Commission (NCC) Bureau of Standards, Metrology and Inspection (BSMI)	CAB	APEC MRA 1	
Vietnam	Ministry of Communication (MIC)	CAB	APEC MRA 1	

**APEC MRA – Asia Pacific Economic Community Mutual Recognition Agreement.

Is a recognition agreement under which test lab is accredited to regulatory standards of the APEC member countries.

Phase I - recognition for product testing

Phase II – recognition for both product testing and certification

N/A – Not Applicable

**EU MRA – European Union Mutual Recognition Agreement.

Is a recognition agreement under which test lab is accredited to regulatory standards of the EU member countries.

**NB – Notified Body

This test report may be reproduced in full only. The document may only be updated by MiCOM Labs personnel. Any changes will be noted in the Document History section of the report.

PRODUCT CERTIFICATION

MiCOM Labs, Inc. is an accredited Product Certification Body per the international standard EN ISO/IEC Guide 65. The company is accredited by the American Association for Laboratory Accreditation (A2LA) www.a2la.org test laboratory number 2381.02. MiCOM Labs test schedule is available at the following URL; <http://www.a2la.org/scopepdf/2381-02.pdf>



USA Telecommunication Certification Body (TCB) - TCB Identifier – US0159

Industry Canada Certification Body - CAB Identifier – US0159

European Notified Body - Notified Body Identifier - 2280

Japan – Recognized Certification Body (RCB) - RCB Identifier - 210

This test report may be reproduced in full only. The document may only be updated by MiCOM Labs personnel. Any changes will be noted in the Document History section of the report.



Title: Ear Force XP510 TX Wireless Audio Transmitter
To: FCC 47 CFR Part 15.407 & IC RSS-210
Serial #: COMM20-U2 Rev A
Issue Date: 12th February 2013
Page: 8 of 67

DOCUMENT HISTORY

Document History		
Revision	Date	Comments
Draft		
Rev A	12 th February 2013	Initial release

This test report may be reproduced in full only. The document may only be updated by MiCOM Labs personnel. Any changes will be noted in the Document History section of the report.



Title: Ear Force XP510 TX Wireless Audio Transmitter
To: FCC 47 CFR Part 15.407 & IC RSS-210
Serial #: COMM20-U2 Rev A
Issue Date: 12th February 2013
Page: 9 of 67

1. TEST RESULT CERTIFICATE

Applicant:	Voyetra Turtle Beach Inc 100 Summit Lake Drive, Suite 100 Valhalla New York, 10595, USA	Tested By:	MiCOM Labs, Inc. 440 Boulder Court Suite 200 Pleasanton California, 94566, USA
EUT:	Wireless Audio Transmitter	Tel:	+1 925 462 0304
Model:	Ear Force XP510 TX (TB300-2291-01) Ear Force PX51 TX (TB300-2291-01)	Fax:	+1 925 462 0306
S/N:	001 & 002		
Test Date(s):	8th January to 29th January '13	Website:	www.micomlabs.com

STANDARD(S)	TEST RESULTS
FCC 47 CFR Part 15.407 & IC RSS-210	EQUIPMENT COMPLIES

MiCOM Labs, Inc. tested the equipment mentioned in accordance with the requirements set forth in the above standards. Test results indicate that the equipment tested is capable of demonstrating compliance with the requirements as documented within this report.

Notes:

1. This document reports conditions under which testing was conducted and the results of testing performed.
2. Details of test methods used have been recorded and kept on file by the laboratory.
3. Test results apply only to the item(s) tested.

Approved & Released for MiCOM Labs, Inc. by:





Graeme Grieve
Quality Manager MiCOM Labs,

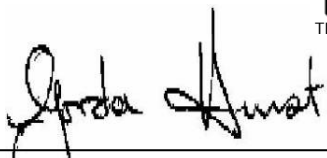

Gordon Hurst
President & CEO MiCOM Labs, Inc.

This test report may be reproduced in full only. The document may only be updated by MiCOM Labs personnel. Any changes will be noted in the Document History section of the report.



Title: Ear Force XP510 TX Wireless Audio Transmitter
To: FCC 47 CFR Part 15.407 & IC RSS-210
Serial #: COMM20-U2 Rev A
Issue Date: 12th February 2013
Page: 10 of 67

2. REFERENCES AND MEASUREMENT UNCERTAINTY

2.1. Normative References

Ref.	Publication	Year	Title
(i)	FCC 47 CFR Part 15.407	2012	Code of Federal Regulations
(ii)	FCC 06-96	June 2006	Memorandum Opinion and Order
(iii)	FCC OET KDB 662911	4 th April 2011	Emissions Testing of Transmitters with Multiple Outputs in the Same Band
(iv)	Industry Canada RSS-210	2010	Low Power License-Exempt Radiocommunication Devices (All Frequency Bands): Category 1 Equipment
(v)	Industry Canada RSS-Gen	2010	General Requirements and Information for the Certification of Radiocommunication Equipment
(vi)	ANSI C63.4	2009	American National Standards for Methods of Measurement of Radio-Noise Emissions from Low-Voltage Electrical and Electronic Equipment in the Range of 9 kHz to 40 GHz
(vii)	CISPR 22/ EN 55022	2008 2006+A1:2007	Limits and Methods of Measurements of Radio Disturbance Characteristics of Information Technology Equipment
(viii)	M 3003	Edition 2 Jan. 2007	Expression of Uncertainty and Confidence in Measurements
(ix)	LAB34	Edition 1 Aug 2002	The expression of uncertainty in EMC Testing
(x)	ETSI TR 100 028	2001	Parts 1 and 2 Electromagnetic compatibility and Radio Spectrum Matters (ERM); Uncertainties in the measurement of mobile radio equipment characteristics
(xi)	A2LA	July 2012	Reference to A2LA Accreditation Status – A2LA Advertising Policy
(xii)	FCC Public Notice – DA 02-2138	2002	Guidelines for Assessing Unlicensed National Information Infrastructure (U-NII) Devices

This test report may be reproduced in full only. The document may only be updated by MiCOM Labs personnel. Any changes will be noted in the Document History section of the report.



Title: Ear Force XP510 TX Wireless Audio Transmitter
To: FCC 47 CFR Part 15.407 & IC RSS-210
Serial #: COMM20-U2 Rev A
Issue Date: 12th February 2013
Page: 11 of 67

2.2. Test and Uncertainty Procedures

Conducted and radiated emission measurements were conducted in accordance with American National Standards Institute ANSI C63.4, listed in the Normative References section of this report.

Measurement uncertainty figures are calculated in accordance with ETSI TR 100 028 Parts 1 and 2.

Measurement uncertainties stated are based on a standard uncertainty multiplied by a coverage factor $k = 2$, providing a level of confidence of approximately 95 % in accordance with UKAS document M 3003 listed in the Normative References section of this report.

This test report may be reproduced in full only. The document may only be updated by MiCOM Labs personnel. Any changes will be noted in the Document History section of the report.



Title: Ear Force XP510 TX Wireless Audio Transmitter
To: FCC 47 CFR Part 15.407 & IC RSS-210
Serial #: COMM20-U2 Rev A
Issue Date: 12th February 2013
Page: 12 of 67

3. PRODUCT DETAILS AND TEST CONFIGURATIONS

3.1. Technical Details

Details	Description
Purpose:	Test of the Ear Force XP510 TX Wireless Audio Transmitter in the frequency range 5,150 to 5,250 MHz to FCC Part 15.407 and Industry Canada RSS-210 regulations.
Applicant:	Voyetra Turtle Beach Inc 100 Summit Lake Drive, Suite 100 Valhalla New York, 10595, USA
Manufacturer:	As applicant
Laboratory performing the tests:	MiCOM Labs, Inc. 440 Boulder Court, Suite 200 Pleasanton, California 94566 USA
Test report reference number:	COMM20-U2 Rev A
Date EUT received:	8th January 2013
Standard(s) applied:	FCC 47 CFR Part 15.407 & IC RSS-210
Dates of test (from - to):	8th January to 29th January '13
No of Units Tested:	Two
Type of Equipment:	Wireless Audio Transmitter
Applicants Trade Name:	Ear Force
Model(s):	XP510 TX (TB300-2291-01), PX51 TX (TB300-2291-01)
Location for use:	Indoor only
Declared Frequency Range(s):	5,150 – 5,250 MHz
Hardware Rev	1.0
Software Rev	3.5
Type of Modulation:	Per 802.11 – OFDM
Declared Nominal Output Power: (Average Power)	802.11a: Legacy +3.08 dBm
EUT Modes of Operation:	Legacy 802.11a
Transmit/Receive Operation:	Time Division Duplex
System Beam Forming:	EUT has no capability for antenna beam forming
Rated Input Voltage and Current:	5 Vdc (USB)
Operating Temperature Range:	Declared range 0o to +50°C at 95% humidity non condensing
ITU Emission Designator:	802.11a 16M8D1D
Equipment Dimensions:	8.875 x 4.375 x 4.375 inches
Weight:	8.4 oz
Primary function of equipment:	Wireless Audio Transmitter

This test report may be reproduced in full only. The document may only be updated by MiCOM Labs personnel. Any changes will be noted in the Document History section of the report.



Title: Ear Force XP510 TX Wireless Audio Transmitter
To: FCC 47 CFR Part 15.407 & IC RSS-210
Serial #: COMM20-U2 Rev A
Issue Date: 12th February 2013
Page: 13 of 67

3.2. Scope of Test Program

Ear Force XP510 TX Wireless Audio Transmitter RF Testing

The scope of the test program was to test the Ear Force XP510 TX Wireless Audio Transmitter, in the frequency range 5,150 to 5,250 MHz for compliance against FCC 47 CFR Part 15.407 and Industry Canada RSS-210 specifications.

The Ear Force PX51 TX is included in the scope of this test program, it is electrically identical to the XP510 TX, but marketed under a different product name.

This test report may be reproduced in full only. The document may only be updated by MiCOM Labs personnel. Any changes will be noted in the Document History section of the report.

Ear Force XP510 TX Wireless Audio Transmitter



This test report may be reproduced in full only. The document may only be updated by MiCOM Labs personnel. Any changes will be noted in the Document History section of the report.

Ear Force XP510 TX Wireless Audio Transmitter – PCB

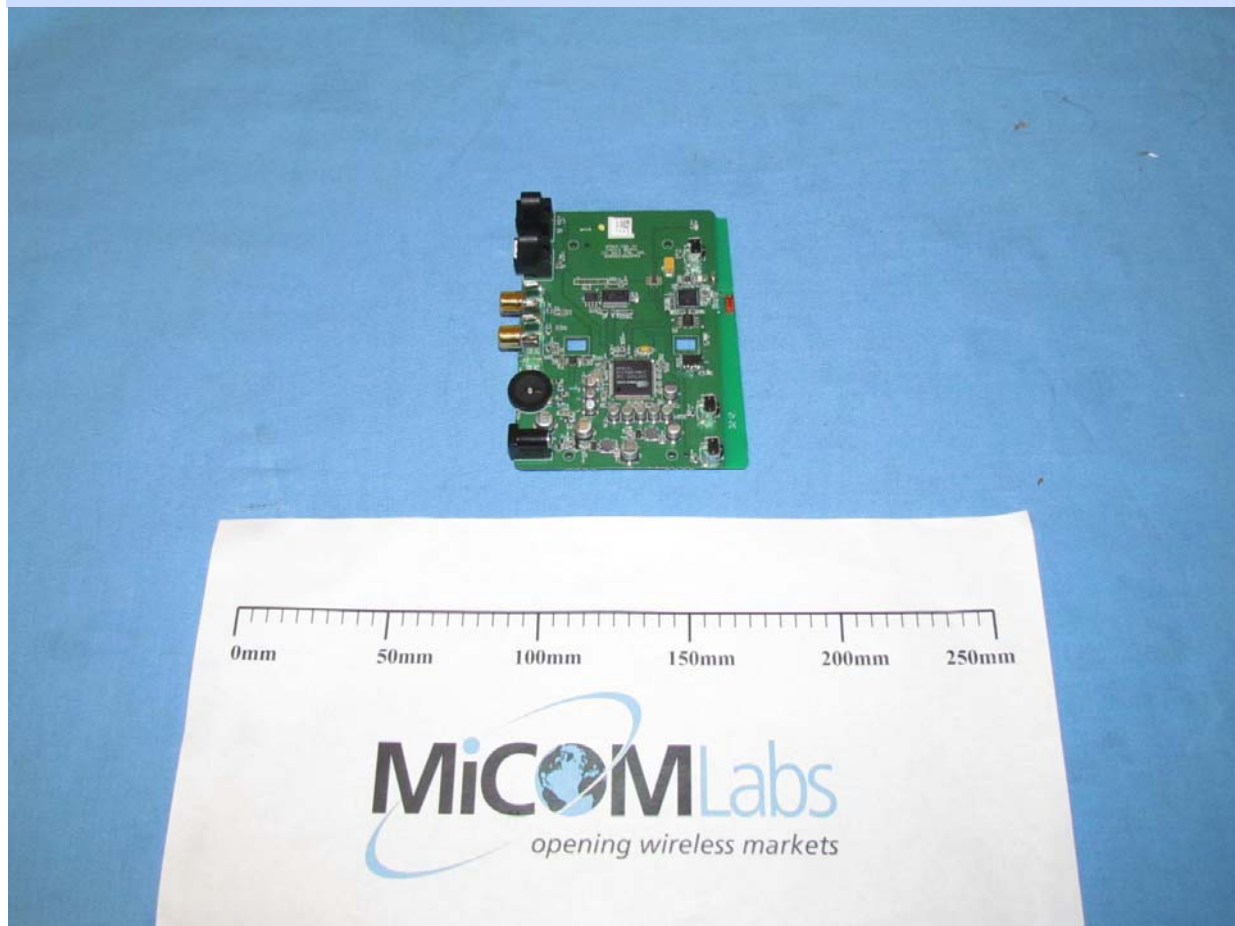

This test report may be reproduced in full only. The document may only be updated by MiCOM Labs personnel. Any changes will be noted in the Document History section of the report.

Ear Force XP510 TX Wireless Audio Transmitter – PCB Back



This test report may be reproduced in full only. The document may only be updated by MiCOM Labs personnel. Any changes will be noted in the Document History section of the report.



Title: Ear Force XP510 TX Wireless Audio Transmitter
To: FCC 47 CFR Part 15.407 & IC RSS-210
Serial #: COMM20-U2 Rev A
Issue Date: 12th February 2013
Page: 17 of 67

3.3. Equipment Model(s) and Serial Number(s)

Type (EUT/Support)	Equipment Description (Including Brand Name)	Mfr	Model No.	Serial No.
EUT	Wireless Audio Transmitter	Voyetra Turtle Beach	Ear Force XP510 TX	001 & 002
Support	Laptop PC	IBM	Thinkpad	None

3.4. Antenna Details

Antenna Type	Manufacturer	Model Number	Antenna Gain (dBi)	
			2.4 GHz	5 GHz
Chip (Wi-Fi)	Fractus	FR05-S1-NO-1-004	-1.5	--
Chip (Wi-Fi)	Fractus	FR05-S1-NO-1-004	--	3.3

3.5. Cabling and I/O Ports

Number and type of I/O ports

1. 1 x USB (power)
2. (2) RCA audio input jacks (L and R)
3. (2) Optical audio ports (Input and Output)

This test report may be reproduced in full only. The document may only be updated by MiCOM Labs personnel. Any changes will be noted in the Document History section of the report.



3.6. Test Configurations

Testing was performed to determine the highest power level versus bit rate. The variant with the highest power was used to exercise the product.

Matrix of test configurations

Operational Mode(s) (802.11)	Variant	Data Rates with Highest Power	Frequencies (MHz)
a	Legacy	6 MBit/s	5180/5,200/5,240

Spurious Emission and Band-Edge Test Strategy Bands 5,150 – 5250;

11a
SE 5180
SE 5200
SE 5240
BE 5350

KEY:-

SE – Spurious Emissions

BE – Band-Edge



Title: Ear Force XP510 TX Wireless Audio Transmitter
To: FCC 47 CFR Part 15.407 & IC RSS-210
Serial #: COMM20-U2 Rev A
Issue Date: 12th February 2013
Page: 19 of 67

3.7. Equipment Modifications

The following modifications were required to bring the equipment into compliance:

1. NONE

3.8. Deviations from the Test Standard

The following deviations from the test standard were required in order to complete the test program:

1. NONE

3.9. Subcontracted Testing or Third Party Data

1. NONE

This test report may be reproduced in full only. The document may only be updated by MiCOM Labs personnel. Any changes will be noted in the Document History section of the report.

4. TESTING EQUIPMENT CONFIGURATION(S)

4.1. Conducted RF Emission Test Set-up

The following tests were performed using the conducted test set-up shown in the diagram below.

1. Section 6.1.1.1. 26 dB and 99% Bandwidth
2. Section 6.1.1.2. Maximum Conducted Output Power
3. Section 6.1.1.3. Peak Power Spectral Density
4. Section 6.1.1.4. Peak Excursion Ratio

Conducted Test Set-Up Pictorial Representation

Test Measurement set up

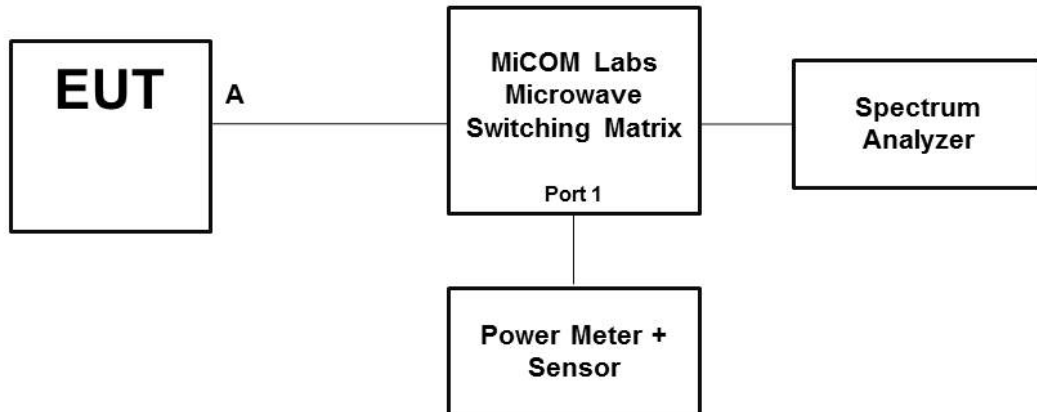

Conducted Test Measurement Setup

4.2. Radiated Spurious Emission Test Set-up > 1 GHz

The following tests were performed using the conducted test set-up shown in the diagram below.

Radiated Emission Measurement Setup – Above 1 GHz

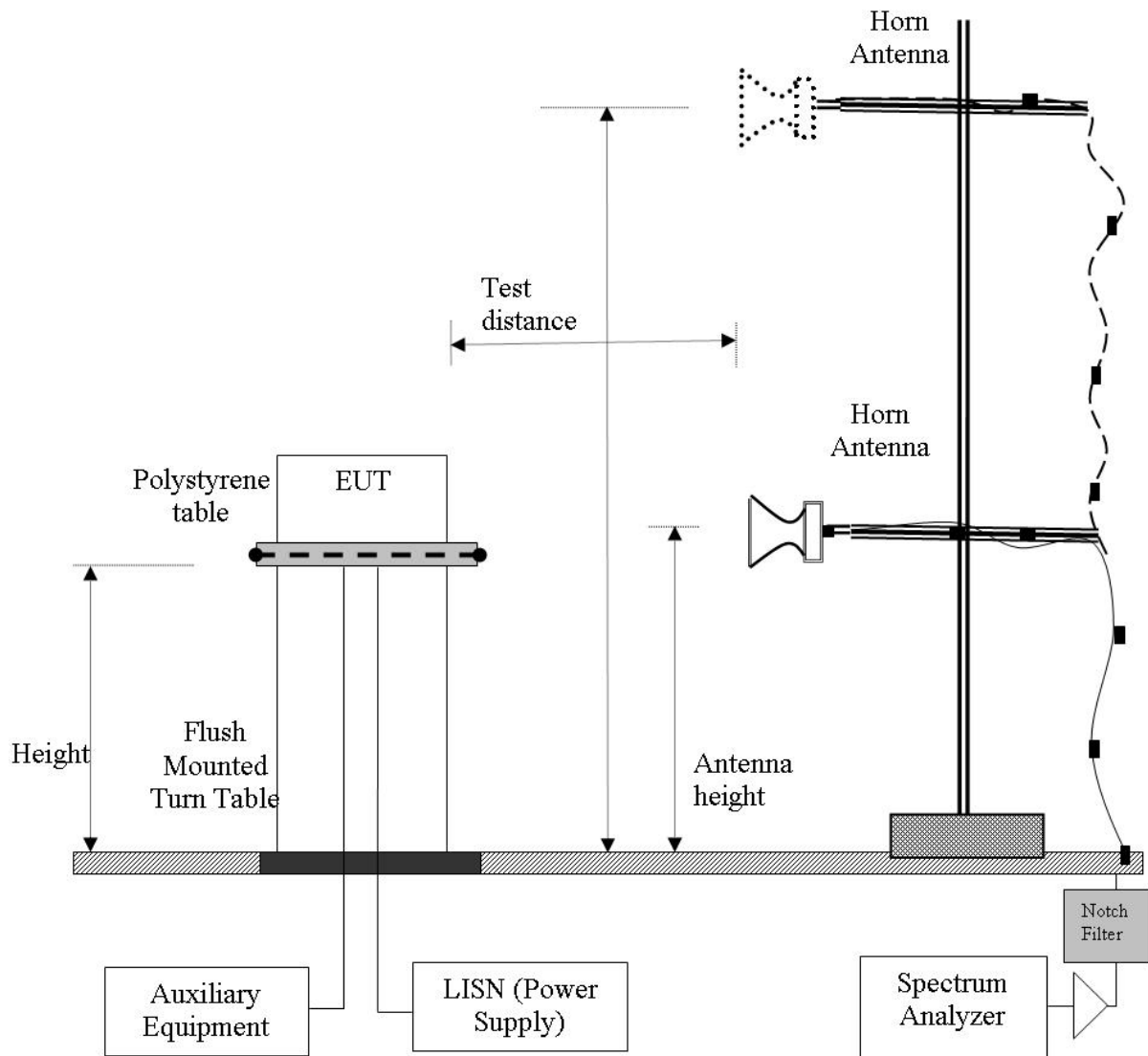

This test report may be reproduced in full only. The document may only be updated by MiCOM Labs personnel. Any changes will be noted in the Document History section of the report.

4.3. Digital Emissions Test Set-up (0.03 – 1 GHz)

The following tests were performed using the conducted test set-up shown in the diagram below.

1. Section 6.1.2.4. Digital Emissions

Digital Emission Measurement Setup – Below 1 GHz

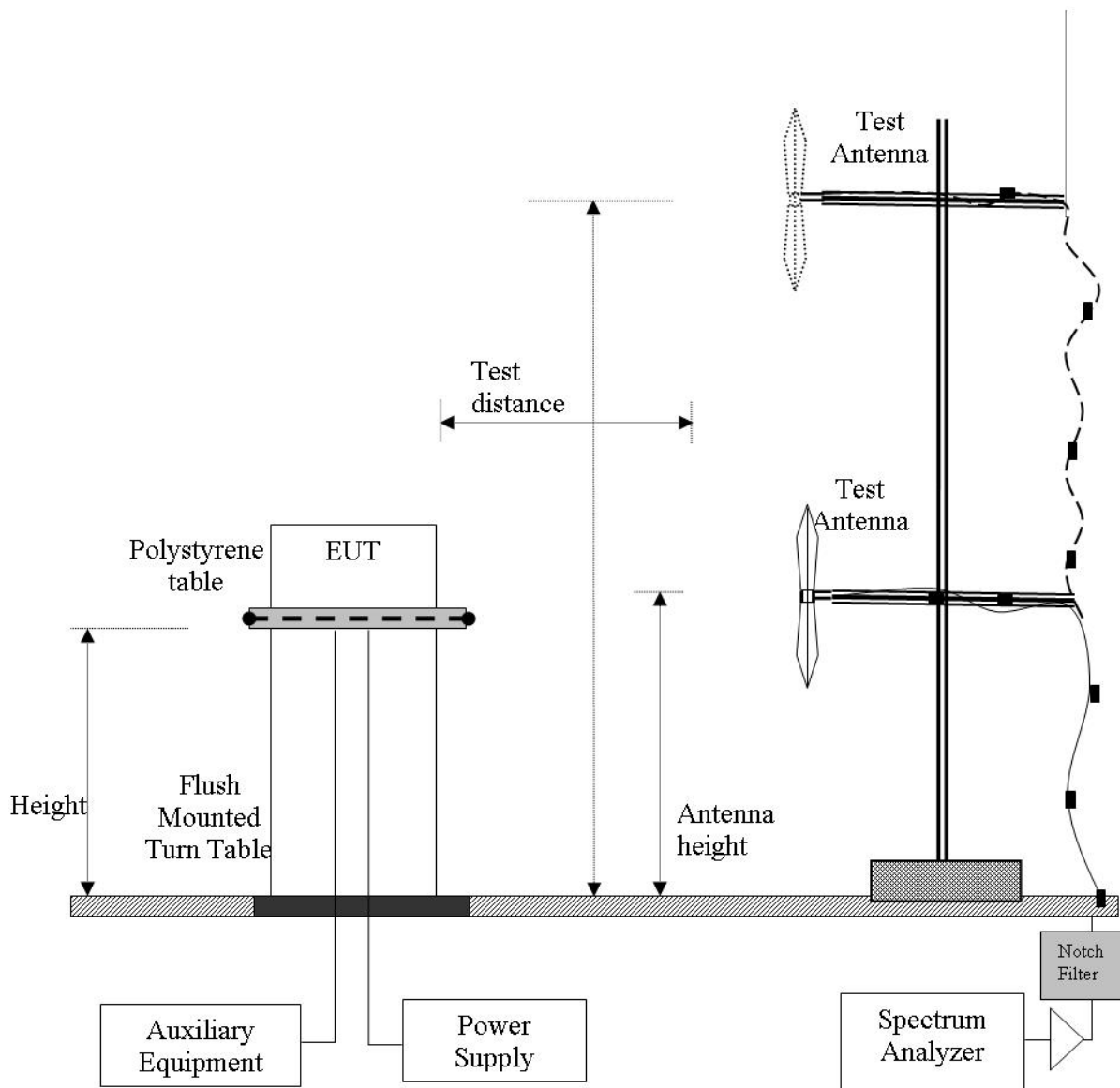

This test report may be reproduced in full only. The document may only be updated by MiCOM Labs personnel. Any changes will be noted in the Document History section of the report.

4.4. ac Wireline Emission Test Set-up

The following tests were performed using the conducted test set-up shown in the diagram below.

1. Section 6.1.3 ac Wireline Conducted Emissions

Conducted Test Set-Up Pictorial Representation

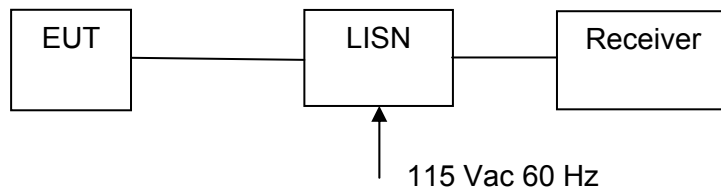

Measurement set up for ac Wireline Conducted Emissions Test



5. TEST SUMMARY

List of Measurements

The following table represents the list of measurements required under the **FCC CFR47 Part 15.407** and **Industry Canada RSS-210** and **Industry Canada RSS-Gen**.

Section(s)	Test Items	Description	Condition	Result	Test Report Section
15.407(a) A9.2(2) 4.4	26dB and 99% Emission BW	Emission bandwidth measurement	Conducted	Complies	6.1.1.1 A.1.1
15.407(a) A9.2(2) 4.6	Maximum Conducted Output Power	Power Measurement	Conducted	Complies	6.1.1.2
15.407(a) A9.2(2)	Peak Power Spectral Density	PPSD	Conducted	Complies	6.1.1.3 A.1.2
15.407(a)(6)	Peak Excursion Ratio	<13dB in any 1MHz bandwidth	Conducted	Complies	6.1.1.4 A.1.3
15.407(g) 15.31 2.1 4.5	Frequency Stability	Limits: contained within band of operation at all times.	Applicant declaration	Complies	6.1.1.5
15.407(f) 5.5	Radio Frequency Radiation Exposure	Exposure to radio frequency energy levels, Maximum Permissible Exposure (MPE)	Conducted	See included MPE exhibit	--

This test report may be reproduced in full only. The document may only be updated by MiCOM Labs personnel. Any changes will be noted in the Document History section of the report.



List of Measurements (continued)

The following table represents the list of measurements required under the **FCC CFR47 Part 15.407** and **Industry Canada RSS-210** and **Industry Canada RSS-Gen**.

Section(s)	Test Items	Description	Condition	Result	Test Report Section
15.407(b)(2) 15.205(a) 15.209(a) 2.2 2.6 A9.3(2) 4.7	Radiated Emissions		Radiated		6.1.2
	Transmitter Radiated Spurious Emissions	Emissions above 1 GHz		Complies	6.1.2.1 6.1.2.2 6.1.2.3
	Radiated Band Edge	Band edge results		Complies	6.1.2.1 6.1.2.2 6.1.2.3
15.407(b)(6) 15.205(a) 15.209(a) 2.2	Radiated Emissions	Emissions <1 GHz (30M-1 GHz)		Complies	6.1.2.4
15.407(b)(6) 15.207 7.2.2	AC Wireline Conducted Emissions 150 kHz–30 MHz	Conducted Emissions	Conducted	N/A EUT is Battery Powered	6.1.3

Note 1: Test results reported in this document relate only to the items tested

Note 2: The required tests demonstrated compliance as per client declaration of test configuration, monitoring methodology and associated pass/fail criteria



Title: Ear Force XP510 TX Wireless Audio Transmitter
To: FCC 47 CFR Part 15.407 & IC RSS-210
Serial #: COMM20-U2 Rev A
Issue Date: 12th February 2013
Page: 26 of 67

6. TEST RESULTS

6.1. Device Characteristics

6.1.1. Conducted Testing

6.1.1.1. 26 dB and 99 % Bandwidth

Conducted Test Conditions for 26 dB and 99% Bandwidth			
Standard:	FCC CFR 47:15.407	Ambient Temp. (°C):	24.0 - 27.5
Test Heading:	26 dB and 99 % Bandwidth	Rel. Humidity (%):	32 - 45
Standard Section(s):	15.407 (a)	Pressure (mBars):	999 - 1001
Reference Document(s):	KDB 789033 - D01 DTS General UNII Test Procedures v01		

Test Procedure for 26 dB and 99% Bandwidth Measurement

The bandwidth at 26 dB and 99 % is measured with a spectrum analyzer connected to the antenna terminal, while EUT is operating in transmission mode at the appropriate center frequency. KDB 789033 Section 5.1 Emission Bandwidth was used in order to prove compliance. The Resolution Bandwidth was set to approximately 1% of the emission bandwidth.

This test report may be reproduced in full only. The document may only be updated by MiCOM Labs personnel. Any changes will be noted in the Document History section of the report.



Title: Ear Force XP510 TX Wireless Audio Transmitter
To: FCC 47 CFR Part 15.407 & IC RSS-210
Serial #: COMM20-U2 Rev A
Issue Date: 12th February 2013
Page: 27 of 67

Measurement Results for 26 dB and 99 % Operational Bandwidth(s)

Equipment Configuration for 26 dB & 99% Occupied Bandwidth

Variant:	802.11a	Duty Cycle (%):	100
Data Rate:	6 Mbs	Antenna Gain (dBi):	Not Applicable
Modulation:	OFDM	Beam Forming Gain (Y):	Not Applicable
TPC:	N/A		
Engineering Test Notes:			

Test Measurement Results

Test Frequency	Measured 26 dB Bandwidth (MHz)				26 dB Bandwidth (MHz)			
	Port(s)				Highest	Lowest		
MHz	a	b	c	d				
5180.0	30.962				30.962	30.962		
5200.0	31.663				31.663	31.663		
5240.0	30.461				30.461	30.461		

Test Frequency	Measured 99% Bandwidth (MHz)				99% Bandwidth (MHz)			
	Port(s)				Highest	Lowest		
MHz	a	b	c	d				
5180.0	17.936				17.936	17.936		
5200.0	17.836				17.836	17.836		
5240.0	17.735				17.735	17.735		

Traceability to Industry Recognized Test Methodologies

Work Instruction:	WI-03 MEASURING RF SPECTRUM MASK
Measurement Uncertainty:	±2.81 dB

[Click on the links above to see the plot](#)

This test report may be reproduced in full only. The document may only be updated by MiCOM Labs personnel. Any changes will be noted in the Document History section of the report.



Specification

Limits

FCC, Part 15 §15.407 (a)(1), (a)(2)

(a)(1) For the band 5.15-5.25 GHz the maximum conducted output power over the frequency band of operation shall not exceed the lesser of 50 mW or $+4 \text{ dBm} + 10 \log B$, where B is the 26 dB emission bandwidth in megahertz. In addition, the peak power spectral density shall not exceed +4 dBm in any 1 megahertz band.

(a)(2) For the 5.25-5.35 GHz band the maximum conducted output power over the frequency band of operation shall not exceed the lesser of 250 mW or $+11 \text{ dBm} + 10 \log B$, where B is the 26 dB emission bandwidth in megahertz. In addition, the peak power spectral density shall not exceed +11 dBm in any 1 megahertz band.

Industry Canada RSS-210 § A9.2

- **Band 5150–5250 MHz**

Note: LE-LAN devices are restricted to indoor operation only in the band 5150–5250 MHz.

Power limits

The maximum e.i.r.p. shall not exceed 200 mW or $10 + 10 \log_{10} B$, dBm, whichever power is less. B is the 99% emission bandwidth in MHz. The e.i.r.p. spectral density shall not exceed 10 dBm in any 1.0 MHz band.

Out-of-band emission limits

Emissions outside the band 5150–5250 MHz shall not exceed -27 dBm/MHz e.i.r.p.

- **Band 5250–5350 MHz**

Power limits

The maximum conducted output power shall not exceed 250 mW or $11 + 10 \log_{10} B$, dBm, whichever power is less. The power spectral density shall not exceed 11 dBm in any 1.0 MHz band. The maximum e.i.r.p. shall not exceed 1.0 W or $17 + 10 \log_{10} B$, dBm, whichever power is less. B is the 99% emission bandwidth in MHz. Note that devices with a maximum e.i.r.p. greater than 500 mW shall implement TPC in order to have the capability to operate at least 6 dB below the maximum permitted e.i.r.p. of 1 W.

Out-of-band emission limits

Emissions outside the band 5250–5350 MHz shall not exceed -27 dBm/MHz e.i.r.p.

Traceability

Test Equipment Used
0158, 0287, 0252, 0313, 0314, 0070, 0116, 0117



Title: Ear Force XP510 TX Wireless Audio Transmitter
To: FCC 47 CFR Part 15.407 & IC RSS-210
Serial #: COMM20-U2 Rev A
Issue Date: 12th February 2013
Page: 29 of 67

6.1.1.2. Maximum Conducted Output Power

Conducted Test Conditions for Maximum Conducted Output Power			
Standard:	FCC CFR 47:15.407	Ambient Temp. (°C):	24.0 - 27.5
Test Heading:	Maximum Conducted Output Power	Rel. Humidity (%):	32 - 45
Standard Section(s):	15.407 (a)	Pressure (mBars):	999 - 1001
Reference Document(s):	KDB 789033 - D01 DTS General UNII Test Procedures v01		
Test Procedure for Maximum Conducted Output Power Measurement			
<p><u>Method PM (Measurement using an RF average power meter)</u>. Section C) 4) of KDB 789033 defines a methodology using an average wideband power meter. Measurements were made while the EUT was operating in a continuous transmission mode (100% duty cycle) at the appropriate center frequency. All cable losses and offsets were taken into consideration in the measured result. All operational modes and frequency bands were measured independently and the resultant \square calculated. For multiple outputs, the measurements were made simultaneously on each output port and summed in a linear fashion. This technique was used in order to prove compliance.</p>			

This test report may be reproduced in full only. The document may only be updated by MiCOM Labs personnel. Any changes will be noted in the Document History section of the report.



Maximum Transmit (Conducted) Power, FCC Limits and Industry Canada Limits

Bands 5150 – 5250 MHz

FCC Limits

Conducted Power Limit lesser of: 50 mW or 4 dBm + 10 log (B) dBm. B is the 26 dB emission bandwidth in MHz.

Mode	Frequency Range (MHz)	Minimum 26 dB Bandwidth (MHz)	4 + 10 Log (B) (dBm)	Limit (dBm)
a	5150 – 5250	30.461	+18.84	+17

Industry Canada Limits

EIRP Limit 5150 – 5250 MHz: Lesser of 200 mW (+23 dBm) or 10 + 10 Log (B) dBm. B is the 99% emission bandwidth in MHz.

Mode	Frequency Range (MHz)	Minimum 99 % Bandwidth (MHz)	10 + 10 Log (B) (dBm)	EIRP Limit (dBm)
a	5150 – 5250	17.735	+22.49	+22.49



Title: Ear Force XP510 TX Wireless Audio Transmitter
To: FCC 47 CFR Part 15.407 & IC RSS-210
Serial #: COMM20-U2 Rev A
Issue Date: 12th February 2013
Page: 31 of 67

Measurement Results for Maximum Conducted Output Power

Equipment Configuration for Peak Transmit Power

Variant:	802.11a	Duty Cycle (%):	100
Data Rate:	6 Mbs	Antenna Gain (dBi):	3.3
Modulation:	OFDM	Beam Forming Gain (Y):	N/A
TPC:	N/A		
Engineering Test Notes:	--		

Test Measurement Results

Test Frequency	Measured Conducted Output Power (dBm)				Calculated Total Power	Minimum 26 dB Bandwidth	Limit	Margin	EUT Power Setting
	Port(s)								
MHz	a	b	c	d	Σ Port(s) dBm	MHz	dBm	dBm	
5180	3.08				3.08	30.461	17	-13.92	Max
5200	2.06				2.06	30.461	17	-14.94	Max
5240	1.46				1.46	30.461	17	-15.54	Max

Traceability to Industry Recognized Test Methodologies

Work Instruction:	WI-01 MEASURING RF OUTPUT POWER
Measurement Uncertainty:	±1.33 dB

This test report may be reproduced in full only. The document may only be updated by MiCOM Labs personnel. Any changes will be noted in the Document History section of the report.



Specification Limits

FCC, Part 15 §15.407 (a)(1), (a)(2)

(a)(1) For the band 5.15-5.25 GHz the maximum conducted output power over the frequency band of operation shall not exceed the lesser of 50 mW or $+4 \text{ dBm} + 10 \log B$, where B is the 26 dB emission bandwidth in megahertz. In addition, the peak power spectral density shall not exceed +4 dBm in any 1 megahertz band.

(a)(2) For the 5.25-5.35 and 5470-5725 MHz GHz band the maximum conducted output power over the frequency band of operation shall not exceed the lesser of 250 mW or $+11 \text{ dBm} + 10 \log B$, where B is the 26 dB emission bandwidth in megahertz. In addition, the peak power spectral density shall not exceed +11 dBm in any 1 megahertz band.

Industry Canada RSS-210 § A9.2

- **Band 5150–5250 MHz**

Note: LE-LAN devices are restricted to indoor operation only in the band 5150–5250 MHz.

Power limits

The maximum e.i.r.p. shall not exceed 200 mW or $10 + 10 \log_{10} B$, dBm, whichever power is less. B is the 99% emission bandwidth in MHz. The e.i.r.p. spectral density shall not exceed 10 dBm in any 1.0 MHz band.

Out-of-band emission limits

Emissions outside the band 5150–5250 MHz shall not exceed -27 dBm/MHz e.i.r.p.

- **Band 5250–5350 MHz**

Power limits

The maximum conducted output power shall not exceed 250 mW or $11 + 10 \log_{10} B$, dBm, whichever power is less. The power spectral density shall not exceed 11 dBm in any 1.0 MHz band. The maximum e.i.r.p. shall not exceed 1.0 W or $17 + 10 \log_{10} B$, dBm, whichever power is less. B is the 99% emission bandwidth in MHz. Note that devices with a maximum e.i.r.p. greater than 500 mW shall implement TPC in order to have the capability to operate at least 6 dB below the maximum permitted e.i.r.p. of 1 W.

Out-of-band emission limits

Emissions outside the band 5250–5350 MHz shall not exceed -27 dBm/MHz e.i.r.p.

Traceability

Test Equipment Used

0158, 0287, 0252, 0313, 0314, 0070, 0116, 0117
--



Title: Ear Force XP510 TX Wireless Audio Transmitter
To: FCC 47 CFR Part 15.407 & IC RSS-210
Serial #: COMM20-U2 Rev A
Issue Date: 12th February 2013
Page: 33 of 67

6.1.1.3. Peak Power Spectral Density

Conducted Test Conditions for Power Spectral Density			
Standard:	FCC CFR 47:15.407	Ambient Temp. (°C):	24.0 - 27.5
Test Heading:	Power Spectral Density	Rel. Humidity (%):	32 - 45
Standard Section(s):	15.247 (a)	Pressure (mBars):	999 - 1001
Reference Document(s):	KDB 789033 - D01 DTS General UNII Test Procedures v01		
Test Procedure for Power Spectral Density			
The In-Band power spectral density was measured using the measure and sum approach per FCC KDB 662911 (D01 Multiple Transmitter Output v01.)			
<u>Measure and sum the spectra across the outputs.</u> With this technique, spectra are measured at each output of the device at the required resolution bandwidth. The individual spectra are then summed mathematically in linear power units. Unlike in-band power measurements, in which the sum involves a single measured value (output power) from each output, measurements for compliance with PSD limits involve summing entire spectra across corresponding frequency bins on the various outputs. Consistency is maintained for any device with N transmitter outputs to be certain the individual outputs are all aligned with the same span and same number of points. In this instance, the linear power spectrum value within the first spectral bin of output 0 is summed with that in the first spectral bin of output 1, and the first spectral bin of output 2, and so on up to the Nth output to obtain the true value for the first frequency bin of the summed spectrum. The summed spectrum value for each frequency bin is computed in this fashion. These summed spectral values were calculated on a computer, and the results read back into the spectrum analyzer as a data file to produce a representative plot of total spectral power density.			
Calculated Power = A + 10 log (1/x) dBm			
A = Total Power Spectral Density [10 Log ₁₀ (10a/10 + 10 b/10 + 10c/10 + 10d/10)]			
x = Duty Cycle			

This test report may be reproduced in full only. The document may only be updated by MiCOM Labs personnel. Any changes will be noted in the Document History section of the report.



Title: Ear Force XP510 TX Wireless Audio Transmitter
To: FCC 47 CFR Part 15.407 & IC RSS-210
Serial #: COMM20-U2 Rev A
Issue Date: 12th February 2013
Page: 34 of 67

Equipment Configuration for Peak Power Spectral Density

Variant:	802.11a	Duty Cycle (%):	100
Data Rate:	6 Mbs	Antenna Gain (dBi):	Not Applicable
Modulation:	OFDM	Beam Forming Gain (Y):	Not Applicable
TPC:	N/A		
Engineering Test Notes:			

Test Measurement Results

Test Frequency	Measured Power Spectral Density (dBm)				Calculated Total Power Spectral Density (dBm)		Limit	Margin
	Port(s)				S Port(s)	Conversion to 3 kHz RBW		
MHz	a	b	c	d				
5180.0	-10.164				-10.164	N/A	4	-14.16
5200.0	-11.313				-11.313	N/A	4	-15.31
5240.0	-11.904				-11.904	N/A	4	-15.90

Traceability to Industry Recognized Test Methodologies

Work Instruction:	WI-03 MEASURING RF SPECTRUM MASK
Measurement Uncertainty:	±2.81 dB

[Click on the links above to see the plot](#)

This test report may be reproduced in full only. The document may only be updated by MiCOM Labs personnel. Any changes will be noted in the Document History section of the report.



Specification

FCC, Part 15 §15.407 (a)(1), (a)(2)

5150 – 5250 MHz

(a)(1) The peak power spectral density shall not exceed +4 dBm in any 1 megahertz band.

5250 – 5350 MHz & 5470 – 5725 MHz

(a)(2) The peak power spectral density shall not exceed +11 dBm in any 1 megahertz band.

Industry Canada RSS-210 § A9.2

• Band 5150–5250 MHz

Note: LE-LAN devices are restricted to indoor operation only in the band 5150–5250 MHz.

Power limits

The maximum e.i.r.p. shall not exceed 200 mW or $10 + 10 \log_{10} B$, dBm, whichever power is less. B is the 99% emission bandwidth in MHz. The e.i.r.p. spectral density shall not exceed 10 dBm in any 1.0 MHz band.

Out-of-band emission limits

Emissions outside the band 5150–5250 MHz shall not exceed -27 dBm/MHz e.i.r.p.

• Band 5250–5350 MHz

Power limits

The maximum conducted output power shall not exceed 250 mW or $11 + 10 \log_{10} B$, dBm, whichever power is less. The power spectral density shall not exceed 11 dBm in any 1.0 MHz band. The maximum e.i.r.p. shall not exceed 1.0 W or $17 + 10 \log_{10} B$, dBm, whichever power is less. B is the 99% emission bandwidth in MHz. Note that devices with a maximum e.i.r.p. greater than 500 mW shall implement TPC in order to have the capability to operate at least 6 dB below the maximum permitted e.i.r.p. of 1 W.

Out-of-band emission limits

Emissions outside the band 5250–5350 MHz shall not exceed -27 dBm/MHz e.i.r.p.

Traceability

Test Equipment Used

0158, 0287, 0252, 0313, 0314, 0070, 0116, 0117

This test report may be reproduced in full only. The document may only be updated by MiCOM Labs personnel. Any changes will be noted in the Document History section of the report.



Title: Ear Force XP510 TX Wireless Audio Transmitter
To: FCC 47 CFR Part 15.407 & IC RSS-210
Serial #: COMM20-U2 Rev A
Issue Date: 12th February 2013
Page: 36 of 67

6.1.1.4. Peak Excursion Ratio

Conducted Test Conditions for Peak Excursion Ratio			
Standard:	FCC CFR 47:15.407	Ambient Temp. (°C):	24.0 - 27.5
Test Heading:	Peak Excursion Ratio	Rel. Humidity (%):	32 - 45
Standard Section(s):	15.407 (a)(6)	Pressure (mBars):	999 - 1001
Reference Document(s):	KDB 789033 - D01 DTS General UNII Test Procedures v01		

Test Procedure for Peak Excursion Ratio

Compliance with the peak excursion requirement is demonstrated by confirming the ratio of the maximum of the peak-hold spectrum to the maximum of the average spectrum during continuous transmission. Section F) of KDB 789033 was used in order to prove compliance. This is a conducted measurement using a spectrum analyzer using dual traces. Peak Excursion Ratio is the difference in amplitude (dB) between both traces; The following identifies two spectrum traces on the same plot. Trace 1 is the max hold Peak detector, and Trace 2 is the recalled trace data from Peak Power Spectral Density measurements. Each frequency and operational mode is recalled in order to prove compliance.

This test report may be reproduced in full only. The document may only be updated by MiCOM Labs personnel. Any changes will be noted in the Document History section of the report.



Title: Ear Force XP510 TX Wireless Audio Transmitter
To: FCC 47 CFR Part 15.407 & IC RSS-210
Serial #: COMM20-U2 Rev A
Issue Date: 12th February 2013
Page: 37 of 67

Equipment Configuration for Peak Excursion Ratio			
Variant:	802.11a	Duty Cycle (%):	99
Data Rate:	6 MBit/s	Antenna Gain (dBi):	N/A
Modulation:	OFDM	Beam Forming Gain (Y):	N/A
TPC:	Maximum Power		
Engineering Test Notes:			

Variant:		Duty Cycle (%):	
Data Rate:		Antenna Gain (dBi):	Not Applicable
Modulation:		Beam Forming Gain (Y):	Not Applicable
TPC:			
Engineering Test Notes: Manual using SA3 Methods			

Test Measurement Results								
Test Frequency	Measured Peak Excursion (dB)				Ratio (dB)		Limit	Lowest Margin
	Port(s)				Highest	Lowest		
MHz	a	b	c	d			dB	MHz
5180.0	6.60				6.60	6.60	-13.0	-6.40
5200.0	5.11				5.11	5.11	-13.0	-7.89
5240.0	4.88				4.88	4.88	-13.0	-8.12

Traceability to Industry Recognized Test Methodologies	
Work Instruction:	
Measurement Uncertainty:	

[Click on the links above to see the plot](#)

This test report may be reproduced in full only. The document may only be updated by MiCOM Labs personnel. Any changes will be noted in the Document History section of the report.



Title: Ear Force XP510 TX Wireless Audio Transmitter
To: FCC 47 CFR Part 15.407 & IC RSS-210
Serial #: COMM20-U2 Rev A
Issue Date: 12th February 2013
Page: 38 of 67

Specification

Limits

§15.407 (a)(6) The ratio of the peak excursion of the modulation envelope (measured using a peak hold function) to the peak transmit power (measured as specified in this paragraph) shall not exceed 13dB across any 1MHz bandwidth or the emission bandwidth whichever is less

Traceability

Test Equipment Used

0158, 0287, 0252, 0313, 0314, 0070, 0116, 0117
--

This test report may be reproduced in full only. The document may only be updated by MiCOM Labs personnel. Any changes will be noted in the Document History section of the report.



Title: Ear Force XP510 TX Wireless Audio Transmitter
To: FCC 47 CFR Part 15.407 & IC RSS-210
Serial #: COMM20-U2 Rev A
Issue Date: 12th February 2013
Page: 39 of 67

6.1.1.5. Frequency Stability

FCC, Part 15 Subpart E §15.407(g)

Test Procedure

The manufacturer of the equipment is responsible for ensuring that the frequency stability is such that emissions are always maintained within the band of operation under all conditions.

Manufacturer Declaration

The frequency stability of the reference oscillator sets the frequency stability of the RF transceiver signals. Therefore all of the RF signals should have ± 20 ppm stability.

This stability accounts for room temp tolerance of the crystal oscillator circuit, frequency variation across temperature, and crystal ageing.

± 20 ppm at 5.250 GHz translates to a maximum frequency shift of ± 105 KHz. As the edge of the channels is at least one MHz from either of the band edges, ± 105 KHz is more than sufficient to guarantee that the intentional emission will remain in the band over the entire operating range of the EUT.

Specification

Limits

§15.407 (g) Manufacturers of U-NII devices are responsible for ensuring frequency stability such that an emission is maintained within the band of operation under all conditions of normal operation as specified in the user's manual.

This test report may be reproduced in full only. The document may only be updated by MiCOM Labs personnel. Any changes will be noted in the Document History section of the report.



6.1.2. Radiated Emission Testing

FCC, Part 15 Subpart E §15.407(b), §15.205(a)/15.209(a)
Industry Canada RSS-210 §A9.2

Test Procedure

Testing was performed in a 3-meter anechoic chamber. Preliminary radiated emissions were measured on every azimuth and with the receiving antenna in both horizontal and vertical polarizations. Preliminary emissions were recorded with in Spectrum Analyzer mode, using a maximum peak detector while in peak hold mode. Depending on the frequency band spanned a notch filter and/or waveguide filter was used to remove the fundamental frequency.

Emissions nearest the limits were chosen for maximization and formal measurement using a CISPR compliant receiver. Emissions above 1000 MHz are measured utilizing a CISPR compliant average detector with a tuned receiver, using a bandwidth of 1 MHz. Emissions from 30 MHz – 1000 MHz are measured utilizing a CISPR compliant quasi-peak detector with a tuned receiver, using a bandwidth of 120 kHz. Only the highest emissions relative to the limit are listed.

Field Strength Calculation

The field strength is calculated by adding the Antenna Factor and Cable Loss, and subtracting Amplifier Gain from the measured reading. All factors are included in the reported data.

$$FS = R + AF + CORR - FO$$

FS = Field Strength
R = Measured Spectrum analyzer Input Amplitude
AF = Antenna Factor

$$CORR = \text{Correction Factor} = CL - AG + NFL$$

CL = Cable Loss
AG = Amplifier Gain
FO = Distance Falloff Factor
NFL = Notch Filter Loss or Waveguide Loss

Field Strength Calculation Example:

Given receiver input reading of 51.5 dB μ V; Antenna Factor of 8.5 dB; Cable Loss of 1.3 dB; Falloff Factor of 0 dB, an Amplifier Gain of 26 dB and Notch Filter Loss of 1 dB. The Field Strength of the measured emission is:

$$FS = 51.5 + 8.5 + 1.3 - 26.0 + 1 = 36.3 \text{ dB}\mu\text{V/m}$$

Conversion between dB μ V/m (or dB μ V) and μ V/m (or μ V) are done as:

$$\text{Level (dB}\mu\text{V/m)} = 20 * \text{Log (level (\mu\text{V/m}))}$$

$$40 \text{ dB}\mu\text{V/m} = 100 \mu\text{V/m}$$
$$48 \text{ dB}\mu\text{V/m} = 250 \mu\text{V/m}$$

This test report may be reproduced in full only. The document may only be updated by MiCOM Labs personnel. Any changes will be noted in the Document History section of the report.



Title: Ear Force XP510 TX Wireless Audio Transmitter
To: FCC 47 CFR Part 15.407 & IC RSS-210
Serial #: COMM20-U2 Rev A
Issue Date: 12th February 2013
Page: 41 of 67

The following formula is used to convert the equipment isotropic radiated power (eirp) to field strength (dB μ V/m);

$$E = 1000000 \times \sqrt{30P} / 3 \mu\text{V/m}$$

where P is the EIRP in Watts

Therefore: -27 dBm/MHz = 68.23 dB μ V/m

Note: The data in this Section identifies that the EUT is in compliance with the -27dBm/MHz EIRP limit (68.23 dB μ V/m) for out of band emissions. All out of band emissions are less than 68.23 dB μ V/m.

This test report may be reproduced in full only. The document may only be updated by MiCOM Labs personnel. Any changes will be noted in the Document History section of the report.



Title: Ear Force XP510 TX Wireless Audio Transmitter
To: FCC 47 CFR Part 15.407 & IC RSS-210
Serial #: COMM20-U2 Rev A
Issue Date: 12th February 2013
Page: 42 of 67

Specification

Radiated Spurious Emissions

15.407 (b). All emissions outside of the 5,150-5,350MHz, 5,470-5,725MHz band shall not exceed an EIRP of -27dBm/MHz.

FCC §15.205 (a) Except as shown in paragraph (d) of 15.205 (a), only spurious emissions are permitted in any of the frequency bands listed.

FCC §15.205 (a) Except as shown in paragraphs (d) and (e) of this section, the field strength of emissions appearing within these frequency bands shall not exceed the limits shown in Section §15.209. At frequencies equal to or less than 1000 MHz, compliance with the limits in Section 15.209 shall be demonstrated using measurement instrumentation employing a CISPR quasi-peak detector. Above 1000 MHz, compliance with the emission limits in Section 15.209 shall be demonstrated based on the average value of the measured emissions. The provisions in Section 15.35 apply to these measurements.

FCC §15.209 (a) Except as provided elsewhere in this subpart, the emissions from an intentional radiator shall not exceed the field strength levels specified in the following table.

RSS-210 §A9.2 For transmitters operating in the 5250-5350 MHz band, all emissions outside the 5150-5350 MHz band shall not exceed -27 dBm/MHz e.i.r.p. Devices operating in the 5250-5350 MHz band that generate emissions in the 5150-5250 MHz band shall not exceed out of band emission limit of 27 dBm/MHz e.i.r.p. in the 5150-5250 MHz band in order to operate indoor/outdoor, or alternatively shall comply with the spectral power density for operation within the 5150-5250 MHz band and shall be labeled "for indoor use only".

RSS-Gen §4.9 Transmitter Unwanted Emissions.

RSS-Gen §6.1 Receiver Spurious Emission Standard.

This test report may be reproduced in full only. The document may only be updated by MiCOM Labs personnel. Any changes will be noted in the Document History section of the report.



Title: Ear Force XP510 TX Wireless Audio Transmitter
To: FCC 47 CFR Part 15.407 & IC RSS-210
Serial #: COMM20-U2 Rev A
Issue Date: 12th February 2013
Page: 43 of 67

Table 1: FCC 15.209 Spurious Emissions Limits

Frequency (MHz)	Field Strength ($\mu\text{V/m}$)	Field Strength ($\text{dB}\mu\text{V/m}$)	Measurement Distance (meters)
30-88	100	40.0	3
88-216	150	43.5	3
216-960	200	46.0	3
Above 960	500	54.0	3

Traceability:

Test Equipment Used
0088, 0158, 0134, 0304, 0311, 0315, 0310, 0312

This test report may be reproduced in full only. The document may only be updated by MiCOM Labs personnel. Any changes will be noted in the Document History section of the report.



Title: Ear Force XP510 TX Wireless Audio Transmitter
To: FCC 47 CFR Part 15.407 & IC RSS-210
Serial #: COMM20-U2 Rev A
Issue Date: 12th February 2013
Page: 44 of 67

Low

Test Freq.	5180 MHz	Engineer	JMH
Variant	802.11a; 6 Mbs	Temp (°C)	17
Freq. Range	1000 MHz - 18000 MHz	Rel. Hum.(%)	36
Power Setting	SPW0	Press. (mBars)	1011
Antenna	Chip 3.3 dBi	Duty Cycle (%)	100
Test Notes 1			

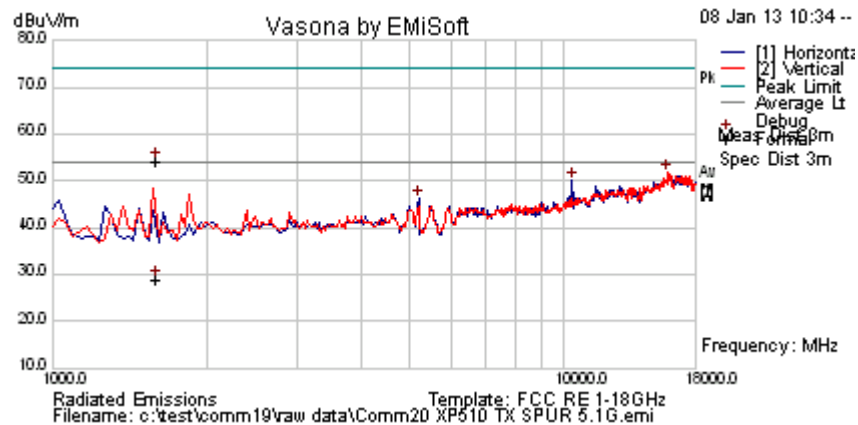

Formally measured emission peaks

Frequency MHz	Raw dBuV	Cable Loss	AF dB	Level dBuV/m	Measurement Type	Pol	Hgt cm	Azt Deg	Limit dBuV/m	Margin dB	Pass /Fail	Comments
15921.844	43.1	8.9	-0.1	51.8	Peak [Scan]	V	150	0	54.0	-2.2	Pass	Noise
5185.751	51.3	4.6	-9.9	46.1	Peak [Scan]	H						FUND
10369.652	45.7	6.7	-2.5	49.9	Peak [Scan]	H	98					NRB
1597.996	67.0	2.5	-15.2	54.2	Peak Max	V	154	61	74	-19.8	Pass	RB
1597.996	41.8	2.5	-15.2	29.0	Average Max	V	154	61	54	-25.0	Pass	RB
Legend: TX = Transmitter Emissions; DIG = Digital Emissions; FUND = Fundamental; WB = Wideband Emission NRB = Non-Restricted Band. Limit = 68.23 dBuV/m; RB = Restricted Band. Limits per 15.205												

This test report may be reproduced in full only. The document may only be updated by MiCOM Labs personnel. Any changes will be noted in the Document History section of the report.



Title: Ear Force XP510 TX Wireless Audio Transmitter
To: FCC 47 CFR Part 15.407 & IC RSS-210
Serial #: COMM20-U2 Rev A
Issue Date: 12th February 2013
Page: 46 of 67

Mid

Test Freq.	5200 MHz	Engineer	JMH
Variant	802.11a; 6 Mbs	Temp (°C)	17
Freq. Range	1000 MHz - 18000 MHz	Rel. Hum.(%)	36
Power Setting	SPW0	Press. (mBars)	1011
Antenna	Chip 3.3 dBi	Duty Cycle (%)	100
Test Notes 1			

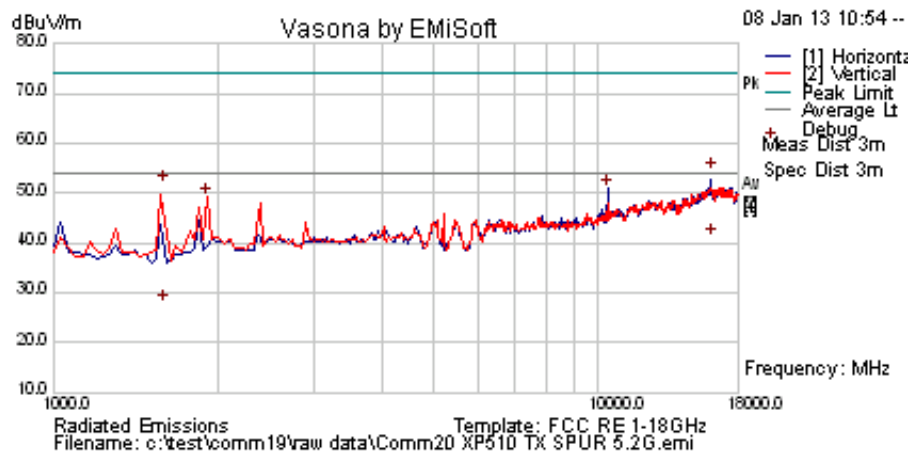

Formally measured emission peaks

Frequency MHz	Raw dBuV	Cable Loss	AF dB	Level dBuV/m	Measurement Type	Pol	Hgt cm	Azt Deg	Limit dBuV/m	Margin dB	Pass /Fail	Comments
10402.806	46.7	6.7	-2.5	51.0	Peak [Scan]	H						NRB
1919.83968	58.4	2.7	-11.9	49.2	Peak [Scan]	V						NRB
16083.928	45.1	9.0	0.3	54.3	Peak Max	H	200	10	74	-19.7	Pass	RB
1593.988	64.3	2.5	-15.2	51.5	Peak Max	V	161	97	74	-22.5	Pass	RB
16083.928	31.6	9.0	0.3	40.9	Average Max	H	200	10	54	-13.2	Pass	RB
1593.988	40.4	2.5	-15.2	27.6	Average Max	V	161	97	54	-26.4	Pass	RB

Legend: TX = Transmitter Emissions; DIG = Digital Emissions; FUND = Fundamental; WB = Wideband Emission
 NRB = Non-Restricted Band. Limit = 68.23 dBuV/m; RB = Restricted Band. Limits per 15.205

This test report may be reproduced in full only. The document may only be updated by MiCOM Labs personnel. Any changes will be noted in the Document History section of the report.



Title: Ear Force XP510 TX Wireless Audio Transmitter
To: FCC 47 CFR Part 15.407 & IC RSS-210
Serial #: COMM20-U2 Rev A
Issue Date: 12th February 2013
Page: 47 of 67

High

Test Freq.	5240 MHz	Engineer	JMH
Variant	802.11a; 6 Mbs	Temp (°C)	17
Freq. Range	1000 MHz - 18000 MHz	Rel. Hum.(%)	36
Power Setting	SPW0	Press. (mBars)	1011
Antenna	Chip 3.3 dBi	Duty Cycle (%)	100
Test Notes 1			

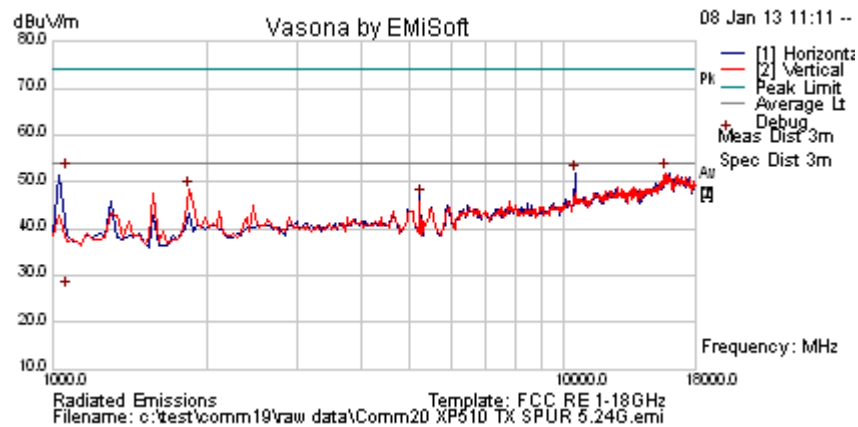

Formally measured emission peaks

Frequency MHz	Raw dBuV	Cable Loss	AF dB	Level dBuV/m	Measurement Type	Pol	Hgt cm	Azt Deg	Limit dBuV/m	Margin dB	Pass /Fail	Comments
15717.435	43.8	8.6	-0.4	51.9	Peak [Scan]	V	150	0	54.0	-2.1	Pass	Noise
10470.942	47.4	6.8	-2.5	51.7	Peak [Scan]	H						NRB
1851.703	58.2	2.7	-12.4	48.4	Peak [Scan]	V						NRB
5228.456	51.8	4.6	-9.8	46.6	Peak [Scan]							FUND
1064.128	65.9	2.0	-15.8	52.1	Peak Max	H	193	22	74	-21.9	Pass	RB
1064.128	40.5	2.0	-15.8	26.7	Average Max	H	193	22	54	-27.3	Pass	RB

Legend: TX = Transmitter Emissions; DIG = Digital Emissions; FUND = Fundamental; WB = Wideband Emission
 NRB = Non-Restricted Band. Limit = 68.23 dBuV/m; RB = Restricted Band. Limits per 15.205

This test report may be reproduced in full only. The document may only be updated by MiCOM Labs personnel. Any changes will be noted in the Document History section of the report.



802.11a 5350 Restricted Band-edge

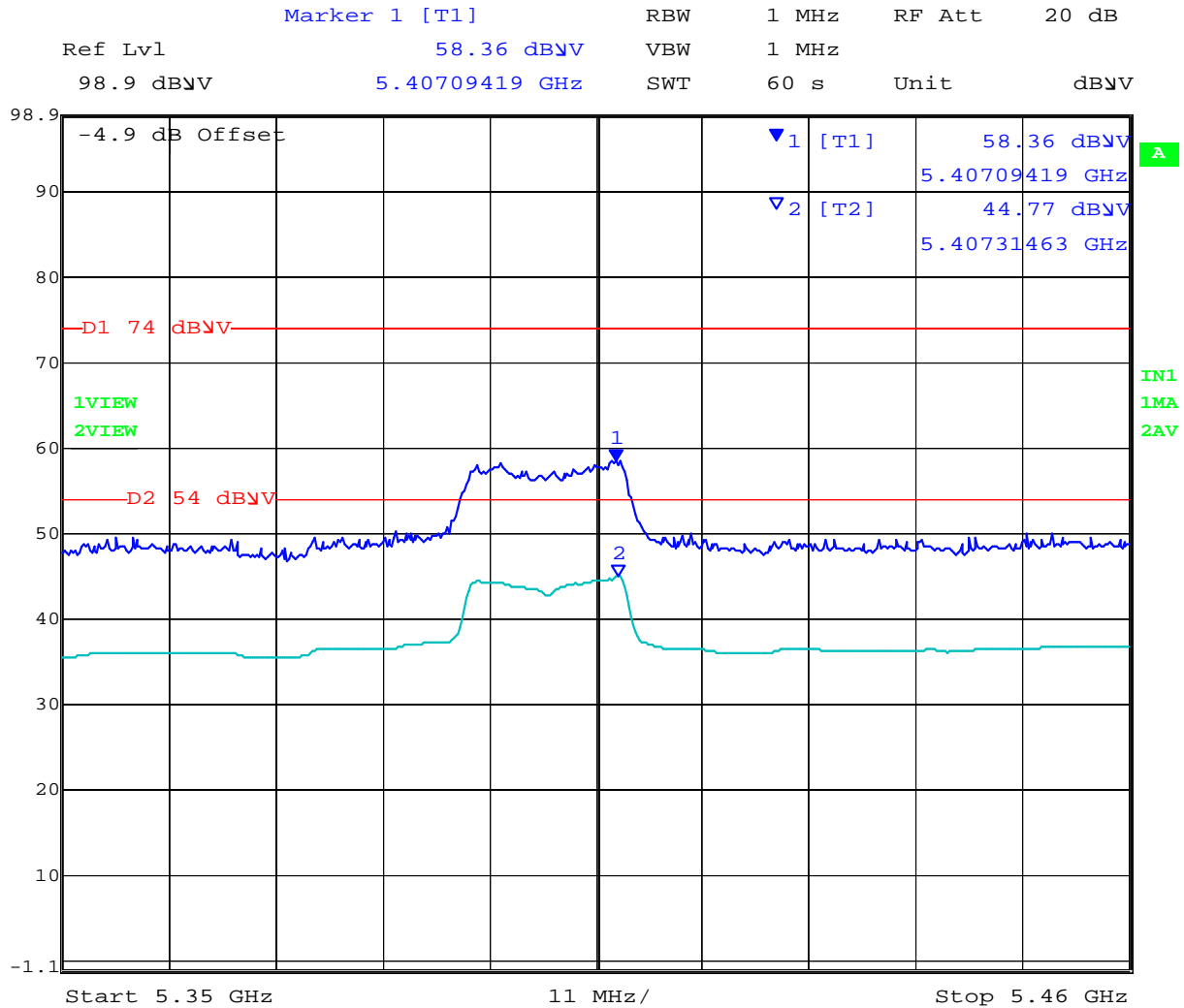

Date: 8.JAN.2013 12:50:51

This test report may be reproduced in full only. The document may only be updated by MiCOM Labs personnel. Any changes will be noted in the Document History section of the report.



6.1.2.1. Digital Emissions (0.03 - 1 GHz)

FCC, Part 15 Subpart C §15.205/ §15.209
Industry Canada RSS-Gen §7.2.5

Test Procedure

Testing 30M-1 GHz was performed in a 3-meter anechoic chamber using a CISPR compliant receiver. Preliminary radiated emissions were measured on every azimuth and with the receiving antenna in both horizontal and vertical polarizations. To further maximize emissions the receive antenna was varied between 1 and 4 meters. The emissions are recorded with receiver in peak hold mode. Emissions closest to the limits are measured in the quasi-peak mode with the tuned receiver using a bandwidth of 120 kHz. Only the highest emissions relative to the limit are listed. The anechoic chamber test set-up is identified in Section 6 Test Set-Up Photographs.

The EUT had two methods of powering on ac/dc converter and Power over Ethernet (POE). Both modes were tested for emissions below 1GHz.

Field Strength Calculation

The field strength is calculated by adding the Antenna Factor and Cable Loss, and subtracting Amplifier Gain from the measured reading. In this test facility, the Antenna Factor, Cable Loss, and Amplifier Gains are loaded into the Rohde & Schwarz Receiver and the corrected field strength can be read directly on the receiver.

$$FS = R + AF + CORR$$

where:

FS = Field Strength
R = Measured Receiver Input Amplitude
AF = Antenna Factor
CORR = Correction Factor = CL – AG + NFL
CL = Cable Loss
AG = Amplifier Gain

For example:

Given a Receiver input reading of 51.5dB μ V; Antenna Factor of 8.5dB; Cable Loss of 1.3dB; Falloff Factor of 0dB, an Amplifier Gain of 26dB and Notch Filter Loss of 1dB. The Field Strength of the measured emission is:

$$FS = 51.5 + 8.5 + 1.3 - 26.0 + 1 = 36.3\text{dB}\mu\text{V/m}$$

Conversion between dB μ V/m (or dB μ V) and μ V/m (or μ V) are done as:

$$\text{Level (dB}\mu\text{V/m)} = 20 * \text{Log (level (\mu\text{V/m}))}$$

$$40 \text{ dB}\mu\text{V/m} = 100\mu\text{V/m}$$

$$48 \text{ dB}\mu\text{V/m} = 250\mu\text{V/m}$$

This test report may be reproduced in full only. The document may only be updated by MiCOM Labs personnel. Any changes will be noted in the Document History section of the report.



Title: Ear Force XP510 TX Wireless Audio Transmitter
To: FCC 47 CFR Part 15.407 & IC RSS-210
Serial #: COMM20-U2 Rev A
Issue Date: 12th February 2013
Page: 50 of 67

Test Freq.	NA	Engineer	JMH
Variant	Digital Emissions	Temp (°C)	19
Freq. Range	30 MHz - 1000 MHz	Rel. Hum.(%)	36
Power Setting		Press. (mBars)	1002
Antenna			
Test Notes 1	XP510TX		
Test Notes 2			

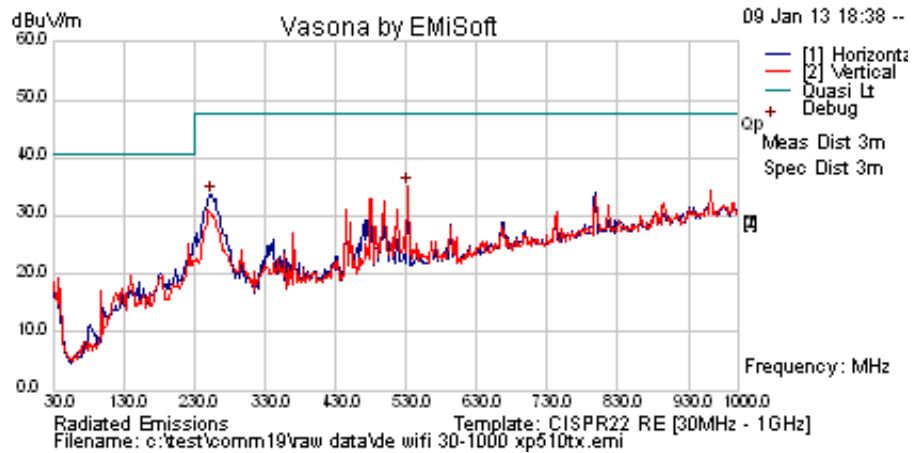

Formally measured emission peaks

Frequency MHz	Raw dBuV	Cable Loss	AF dB	Level dBuV/m	Measurement Type	Pol	Hgt cm	Azt Deg	Limit dBuV/m	Margin dB	Pass /Fail	Comments
255.060	47.6	4.9	-18.9	33.6	Peak [Scan]	H	98	0	47.5	-14.0	Pass	
531.512	41.2	6.0	-12.3	34.9	Peak [Scan]	H	98	0	47.5	-12.6	Pass	

Legend: DIG = Digital Device Emission; TX = Transmitter Emission; FUND = Fundamental Frequency
 NRB = Non-Restricted Band, Limit is 20 dB below Fundamental; RB = Restricted Band

This test report may be reproduced in full only. The document may only be updated by MiCOM Labs personnel. Any changes will be noted in the Document History section of the report.



Specification

Limits

§15.205 (a) Except as shown in paragraph (d) of 15.205 (a), only spurious emissions are permitted in any of the frequency bands listed.

§15.205 (a) Except as shown in paragraphs (d) and (e) of this section, the field strength of emissions appearing within these frequency bands shall not exceed the limits shown in Section §15.209. At frequencies equal to or less than 1000 MHz, compliance with the limits in Section 15.209 shall be demonstrated using measurement instrumentation employing a CISPR quasi-peak detector. Above 1000 MHz, compliance with the emission limits in Section 15.209 shall be demonstrated based on the average value of the measured emissions. The provisions in Section 15.35 apply to these measurements.

§15.209 (a) Except as provided elsewhere in this subpart, the emissions from an intentional radiator shall not exceed the field strength levels specified in the following table.

§15.209 (a) and **Industry Canada RSS-Gen §7.2.5** Limit Matrix

Frequency(MHz)	Field Strength (µV/m)	Field Strength (dBµV/m)	Measurement Distance (meters)
30-88	100	40.0	3
88-216	150	43.5	3
216-960	200	46.0	3
Above 960	500	54.0	3

Laboratory Measurement Uncertainty for Radiated Emissions

Measurement uncertainty	+5.6/ -4.5 dB
-------------------------	---------------

Traceability

Method	Test Equipment Used
Measurements were made per work instruction WI-03 'Measurement of Radiated Emissions'	0088, 0158, 0134, 0304, 0311, 0315, 0310, 0312

This test report may be reproduced in full only. The document may only be updated by MiCOM Labs personnel. Any changes will be noted in the Document History section of the report.



Title: Ear Force XP510 TX Wireless Audio Transmitter
To: FCC 47 CFR Part 15.407 & IC RSS-210
Serial #: COMM20-U2 Rev A
Issue Date: 12th February 2013
Page: 52 of 67

6.1.3. AC Wireline Conducted Emissions (150 kHz – 30 MHz)

FCC, Part 15 Subpart C §15.207
Industry Canada RSS-Gen §7.2.4

Test Procedure

The EUT is configured in accordance with ANSI C63.4. The conducted emissions are measured in a shielded room with a spectrum analyzer in peak hold in the first instance. Emissions closest to the limit are measured in the quasi-peak mode (QP) with the tuned receiver using a bandwidth of 9 kHz. The emissions are maximized further by cable manipulation. The highest emissions relative to the limit are listed.

Measurement Results for AC Wireline Conducted Emissions (150 kHz – 30 MHz)

Ambient conditions.

Temperature: 17 to 23 °C Relative humidity: 31 to 57 % Pressure: 999 to 1012 mbar

Not required - EUT is host powered only.

This test report may be reproduced in full only. The document may only be updated by MiCOM Labs personnel. Any changes will be noted in the Document History section of the report.



Specification

Limit

§15.207 (a) Except as shown in paragraphs (b) and (c) of this section, for an intentional radiator that is designed to be connected to the public utility (AC) power line, the radio frequency voltage that is conducted back onto the AC power line on any frequency or frequencies within the band 150 kHz to 30 MHz shall not exceed the limits in the following table, as measured using a 50 $\mu\Omega$ line impedance stabilization network (LISN), see §15.207 (a) matrix below. Compliance with the provisions of this paragraph shall be based on the measurement of the radio frequency voltage between each power line and ground at the power terminal.

RSS-Gen §7.2.4

Except when the requirements applicable to a given device state otherwise, for any radio apparatus equipped to operate from the public utility AC power supply, either directly or indirectly (such as with a battery charger), the radio frequency voltage of emissions conducted back onto the AC power lines in the frequency range of 0.15 MHz to 30 MHz shall not exceed the limits shown in the table below. The more stringent limit applies at the frequency range boundaries. The conducted emissions shall be measured with a 50 ohm/50 microhenry line impedance stabilization network (LISN).

§15.207 (a) and RSS-Gen §7.2.4 Limit Matrix

The lower limit applies at the boundary between frequency ranges

Frequency of Emission (MHz)	Conducted Limit (dB μ V)	
	Quasi-peak	Average
0.15-0.5	66 to 56*	56 to 46*
0.5-5	56	46
5-30	60	50

* Decreases with the logarithm of the frequency

Laboratory Measurement Uncertainty for Conducted Emissions

Measurement uncertainty	± 2.64 dB
-------------------------	---------------

Traceability

Method	Test Equipment Used
Measurements were made per work instruction WI-EMC-01 'Measurement of Conducted Emissions'	0158, 0184, 0287, 0190, 0293, 0307

This test report may be reproduced in full only. The document may only be updated by MiCOM Labs personnel. Any changes will be noted in the Document History section of the report.

7. PHOTOGRAPHS

7.1. Test Setup - Radiated Emissions < 1 GHz

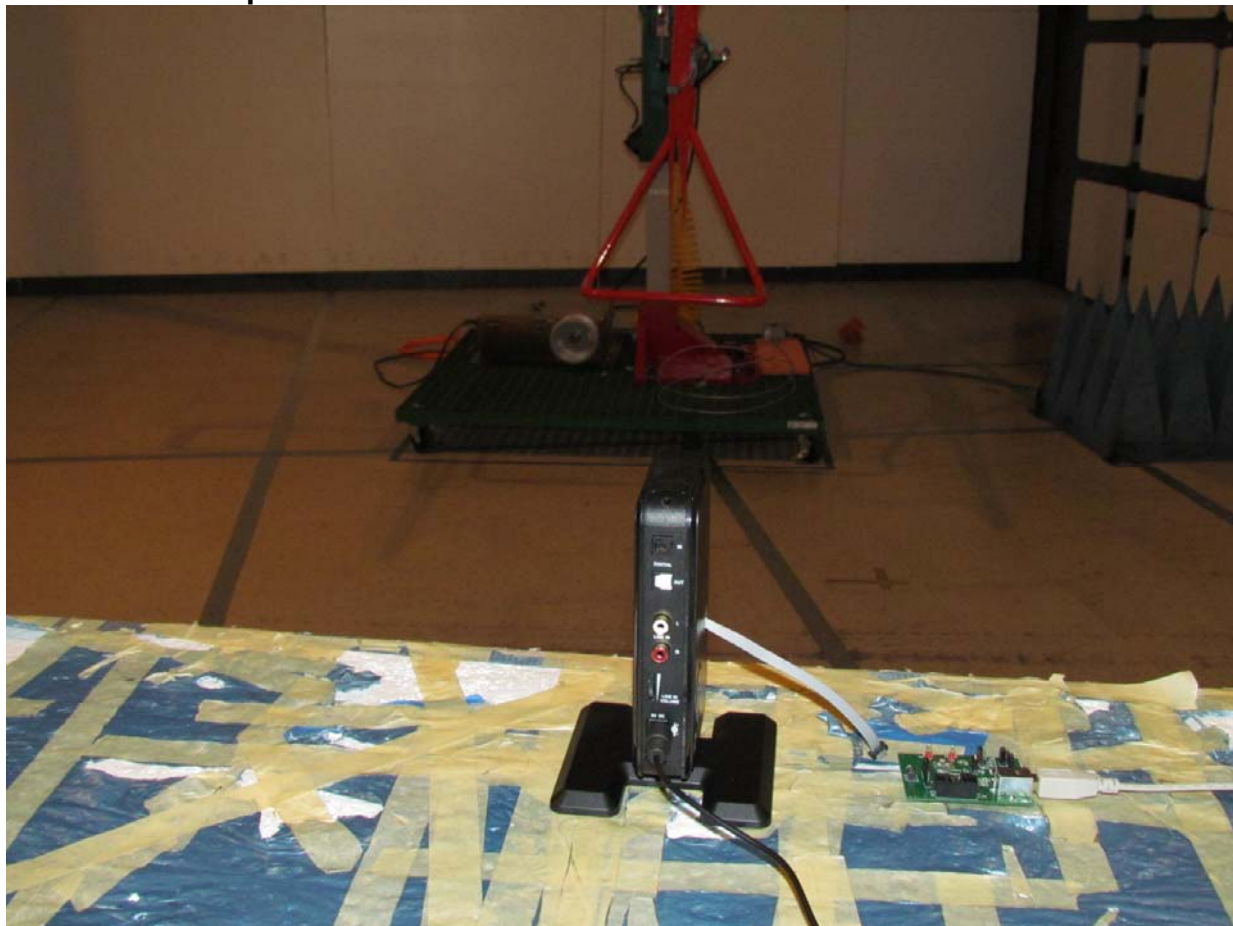

This test report may be reproduced in full only. The document may only be updated by MiCOM Labs personnel. Any changes will be noted in the Document History section of the report.

7.2. Test Setup - Radiated Emissions > 1 GHz

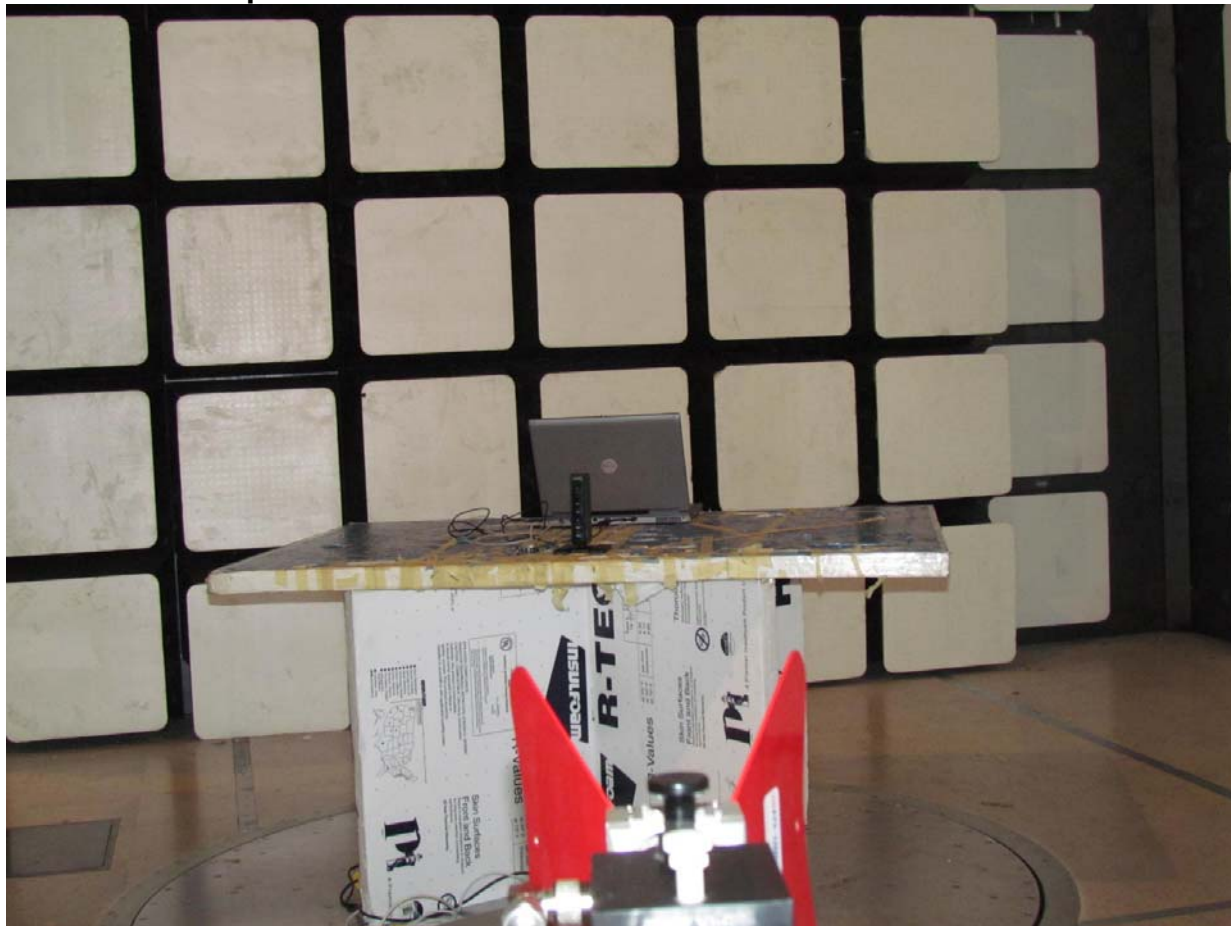

This test report may be reproduced in full only. The document may only be updated by MiCOM Labs personnel. Any changes will be noted in the Document History section of the report.



Title: Ear Force XP510 TX Wireless Audio Transmitter
To: FCC 47 CFR Part 15.407 & IC RSS-210
Serial #: COMM20-U2 Rev A
Issue Date: 12th February 2013
Page: 56 of 67

8. TEST EQUIPMENT DETAILS

Asset #	Instrument	Manufacturer	Part #	Serial #	Calibration Due Date
0070	Power Meter	Hewlett Packard	437B	3125U11552	28 th Nov 13
0117	Power Sensor	Hewlett Packard	8487D	3318A00371	15 th Nov 13
0223	Power Meter	Hewlett Packard	EPM-442A	US37480256	15 th Nov 13
0374	Power Sensor	Hewlett Packard	8485A	3318A19694	29 th Nov 13
0158	Barometer /Thermometer	Control Co.	4196	E2846	8 th Dec 13
0193	EMI Receiver	Rhode & Schwartz	ESI 7	838496/007	2 nd Dec 13
0287	EMI Receiver	Rhode & Schwartz	ESIB40	100201	16 th Nov 13
0338	30 - 3000 MHz Antenna	Sunol	JB3	A052907	8 th Nov 13
0335	1-18 GHz Horn Antenna	EMCO	3117	00066580	7 th Nov 13
0252	SMA Cable	Megaphase	Sucoflex 104	None	N/A
0293	BNC Cable	Megaphase	1689 1GVT4	15F50B001	N/A
0307	BNC Cable	Megaphase	1689 1GVT4	15F50B002	N/A
0310	2m SMA Cable	Micro-Coax	UFA210A-0-0787-3G03G0	209089-001	N/A
0312	3m SMA Cable	Micro-Coax	UFA210A-1-1181-3G0300	209092-001	N/A
0314	30dB N-Type Attenuator	ARRA	N9444-30	1623	N/A
	EMC Test Software	EMISoft	Vasona	5.0051	N/A
	RF Conducted Test Software	National Instruments	Labview	Version 8.2	N/A
	RF Conducted Test Software	MiCOM Labs ATS		Version 1.5	N/A

This test report may be reproduced in full only. The document may only be updated by MiCOM Labs personnel. Any changes will be noted in the Document History section of the report.



Title: Ear Force XP510 TX Wireless Audio Transmitter
To: FCC 47 CFR Part 15.407 & IC RSS-210
Serial #: COMM20-U2 Rev A
Issue Date: 12th February 2013
Page: 57 of 67

APPENDIX

A. SUPPORTING INFORMATION

A.1. CONDUCTED TEST PLOTS

This test report may be reproduced in full only. The document may only be updated by MiCOM Labs personnel. Any changes will be noted in the Document History section of the report.



A.1.1. 26 dB & 99% Bandwidth



26 dB & 99% BANDWIDTH

Variant: 802.11a, Channel: 5180.00 MHz, Chain a, Temp: Ambient, Voltage: 5 Vdc

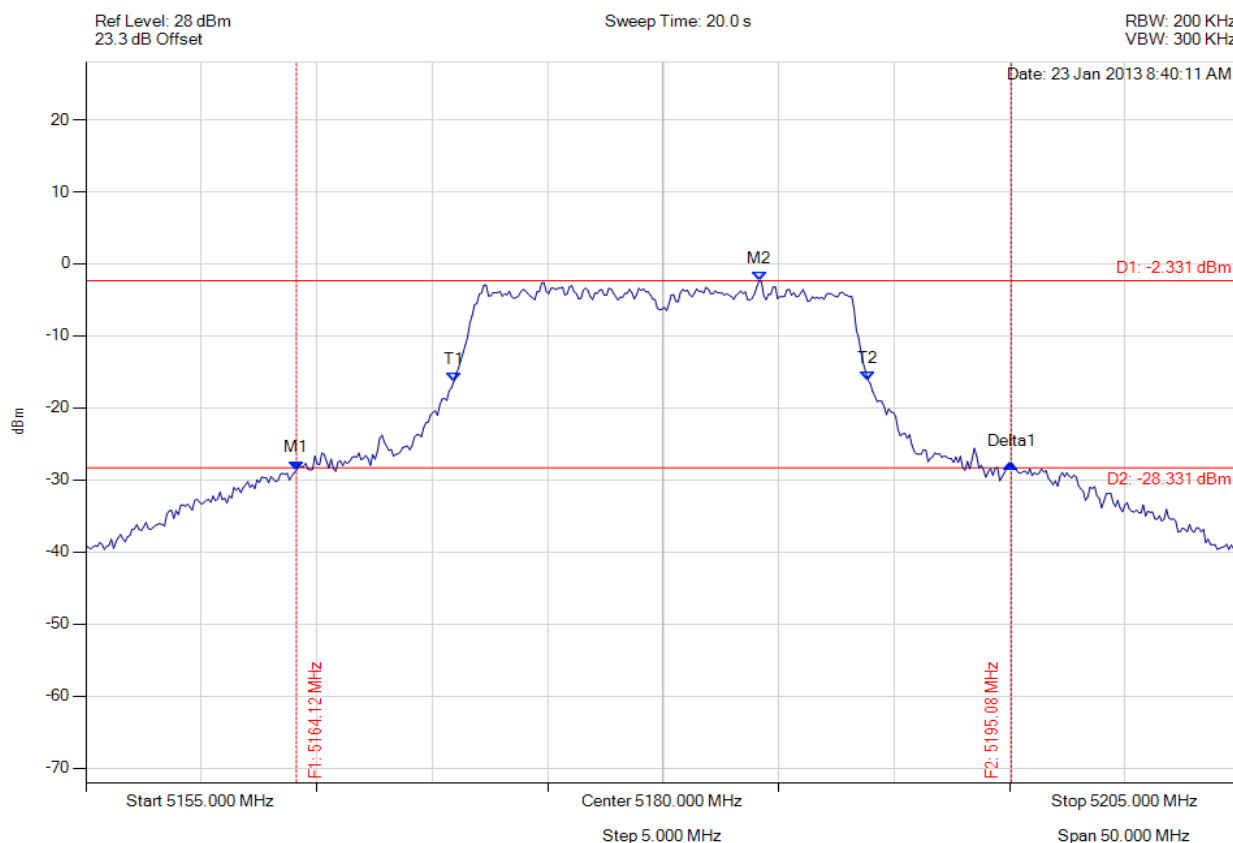

Analyser Setup	Marker : Frequency : Amplitude	Test Results
Detector = MAX PEAK Sweep Count = 0 RF Atten (dB) = 20 Trace Mode = VIEW	M1 : 5164.118 MHz : -28.642 dBm M2 : 5184.158 MHz : -2.331 dBm Delta1 : 30.962 MHz : 0.954 dB T1 : 5170.932 MHz : -16.358 dBm T2 : 5188.868 MHz : -16.155 dBm OBW : 17.936 MHz	Measured 26 dB Bandwidth: 30.962 MHz Measured 99% Bandwidth: 17.936 MHz

[Back to the Matrix](#)

This test report may be reproduced in full only. The document may only be updated by MiCOM Labs personnel. Any changes will be noted in the Document History section of the report.



26 dB & 99% BANDWIDTH

Variant: 802.11a, Channel: 5200.00 MHz, Chain a, Temp: Ambient, Voltage: 5 Vdc

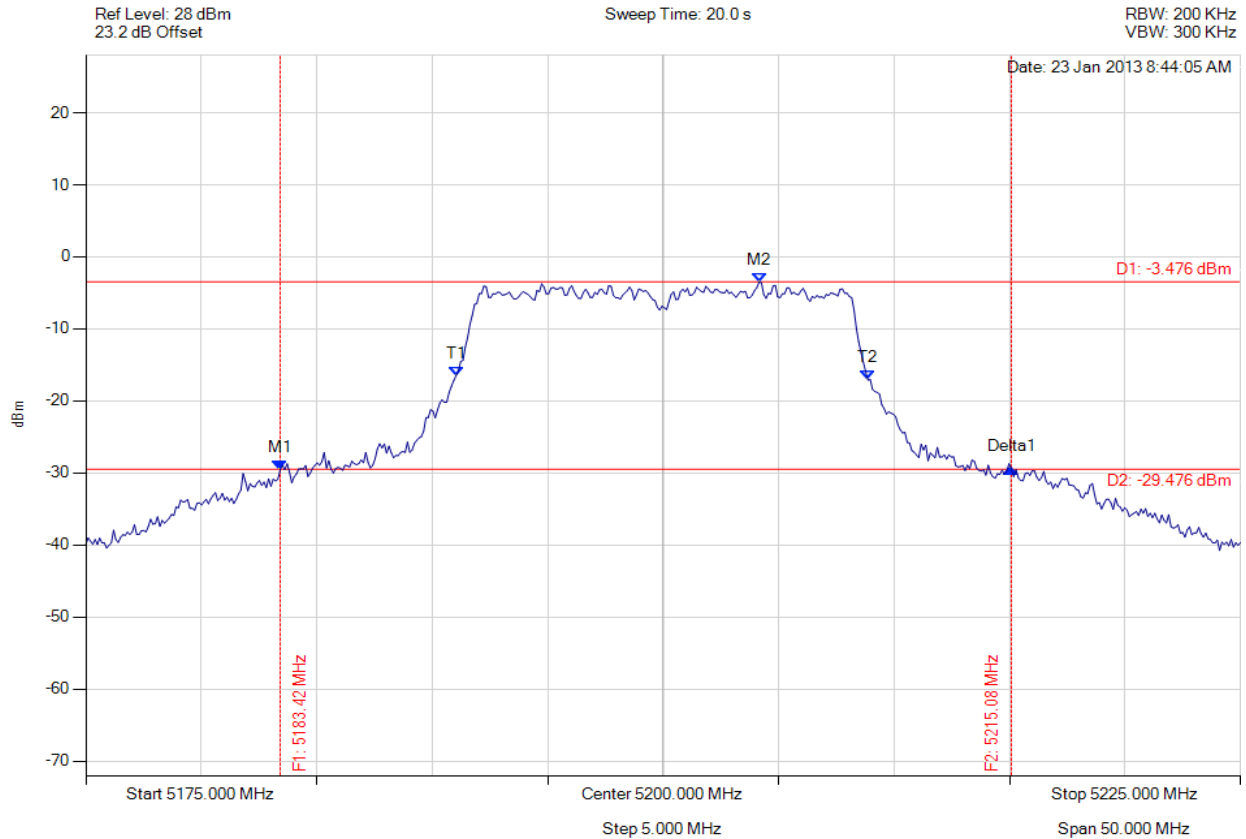

Analyser Setup	Marker : Frequency : Amplitude	Test Results
Detector = MAX PEAK Sweep Count = 0 RF Atten (dB) = 20 Trace Mode = VIEW	M1 : 5183.417 MHz : -29.541 dBm M2 : 5204.158 MHz : -3.476 dBm Delta1 : 31.663 MHz : 0.132 dB T1 : 5191.032 MHz : -16.500 dBm T2 : 5208.868 MHz : -17.094 dBm OBW : 17.836 MHz	Measured 26 dB Bandwidth: 31.663 MHz Measured 99% Bandwidth: 17.836 MHz

[Back to the Matrix](#)

This test report may be reproduced in full only. The document may only be updated by MiCOM Labs personnel. Any changes will be noted in the Document History section of the report.



Title: Ear Force XP510 TX Wireless Audio Transmitter
To: FCC 47 CFR Part 15.407 & IC RSS-210
Serial #: COMM20-U2 Rev A
Issue Date: 12th February 2013
Page: 60 of 67



26 dB & 99% BANDWIDTH

Variant: 802.11a, Channel: 5240.00 MHz, Chain a, Temp: Ambient, Voltage: 5 Vdc

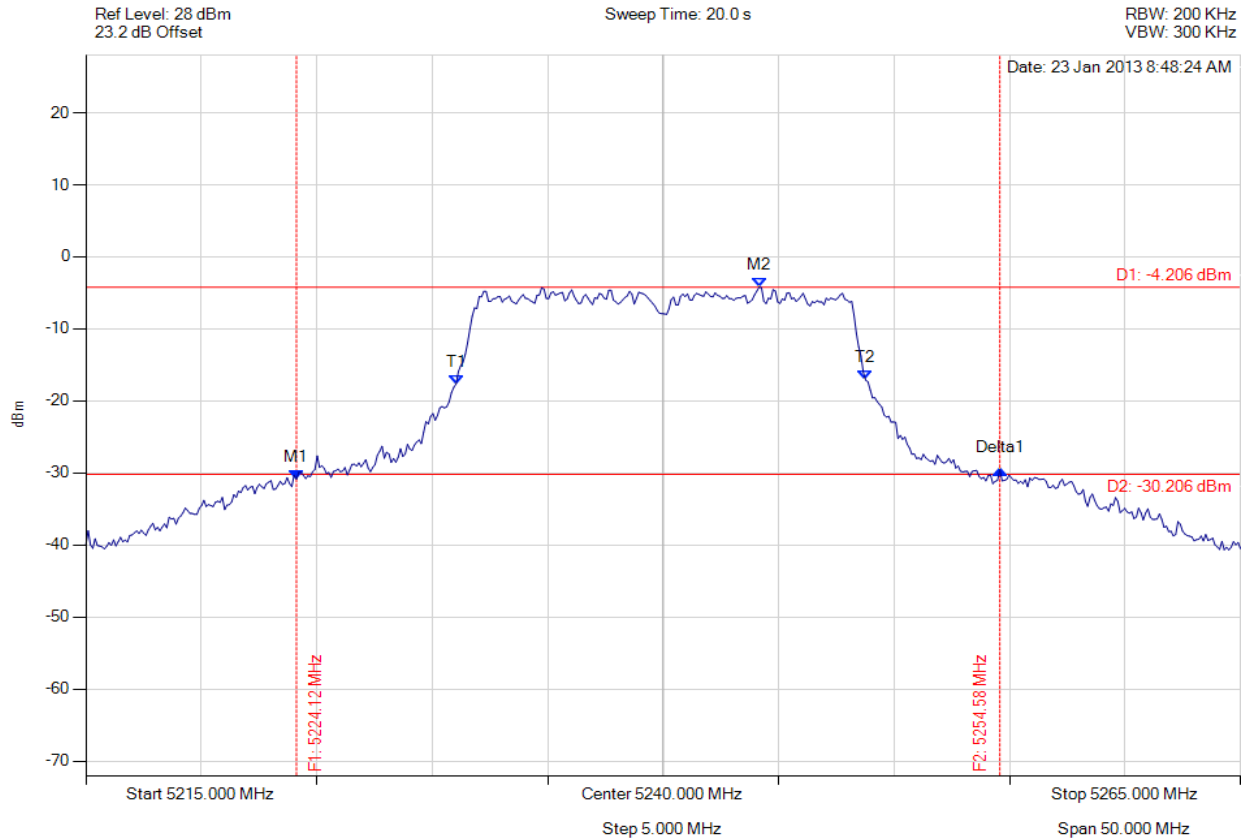

Analyser Setup	Marker : Frequency : Amplitude	Test Results
Detector = MAX PEAK Sweep Count = 0 RF Atten (dB) = 20 Trace Mode = VIEW	M1 : 5224.118 MHz : -30.881 dBm M2 : 5244.158 MHz : -4.206 dBm Delta1 : 30.461 MHz : 1.304 dB T1 : 5231.032 MHz : -17.666 dBm T2 : 5248.768 MHz : -17.106 dBm OBW : 17.735 MHz	Measured 26 dB Bandwidth: 30.461 MHz Measured 99% Bandwidth: 17.735 MHz

[Back to the Matrix](#)

This test report may be reproduced in full only. The document may only be updated by MiCOM Labs personnel. Any changes will be noted in the Document History section of the report.



A.1.2. Peak Power Spectral Density



PEAK POWER SPECTRAL DENSITY

Variant: 802.11a, Channel: 5180.00 MHz, Chain a, Temp: Ambient, Voltage: 5 Vdc

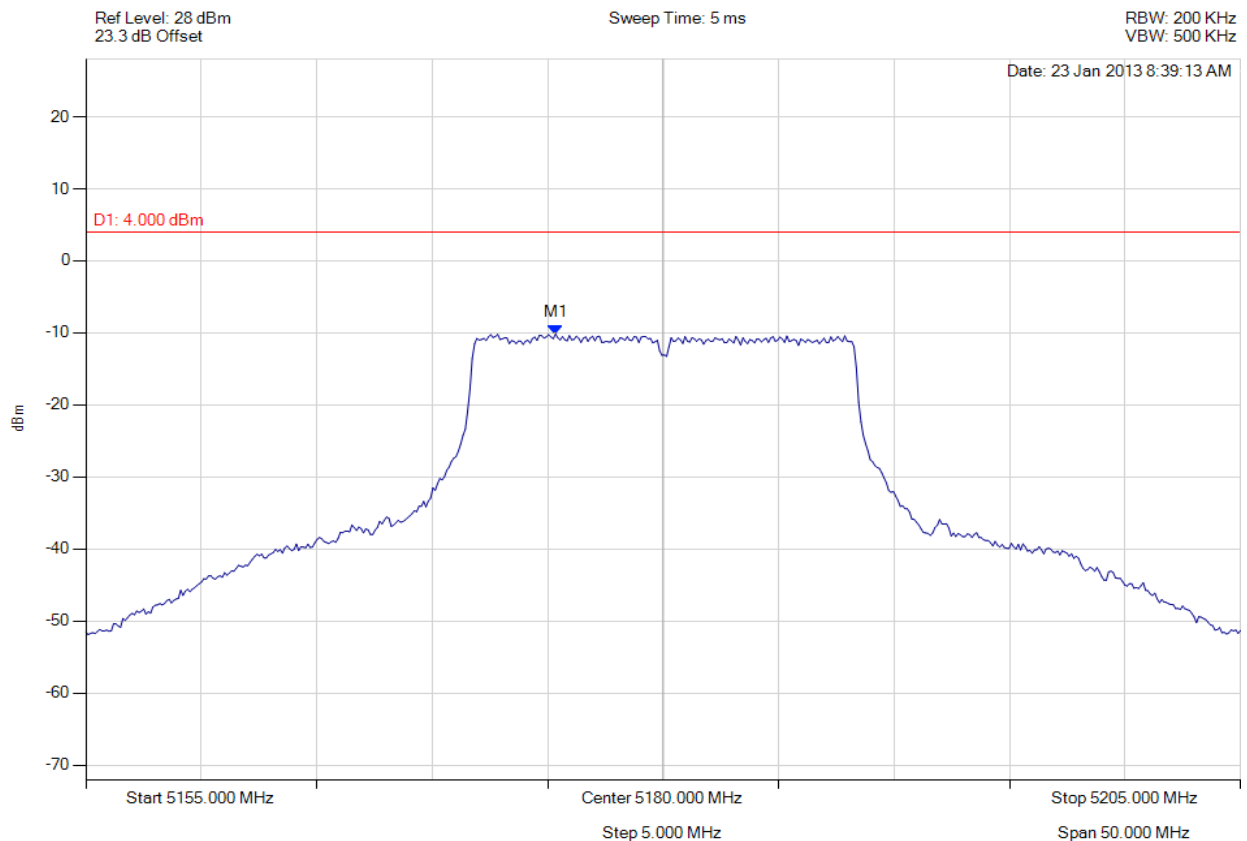

Analyser Setup	Marker : Frequency : Amplitude	Test Results
Detector = RMS Sweep Count = 100 RF Atten (dB) = 20 Trace Mode = VIEW	M1 : 5175.341 MHz : -10.164 dBm	Limit: ≤ 4.000 dBm Margin: -14.16 dB

[Back to the Matrix](#)

This test report may be reproduced in full only. The document may only be updated by MiCOM Labs personnel. Any changes will be noted in the Document History section of the report.



Title: Ear Force XP510 TX Wireless Audio Transmitter
To: FCC 47 CFR Part 15.407 & IC RSS-210
Serial #: COMM20-U2 Rev A
Issue Date: 12th February 2013
Page: 62 of 67



PEAK POWER SPECTRAL DENSITY

Variant: 802.11a, Channel: 5200.00 MHz, Chain a, Temp: Ambient, Voltage: 5 Vdc

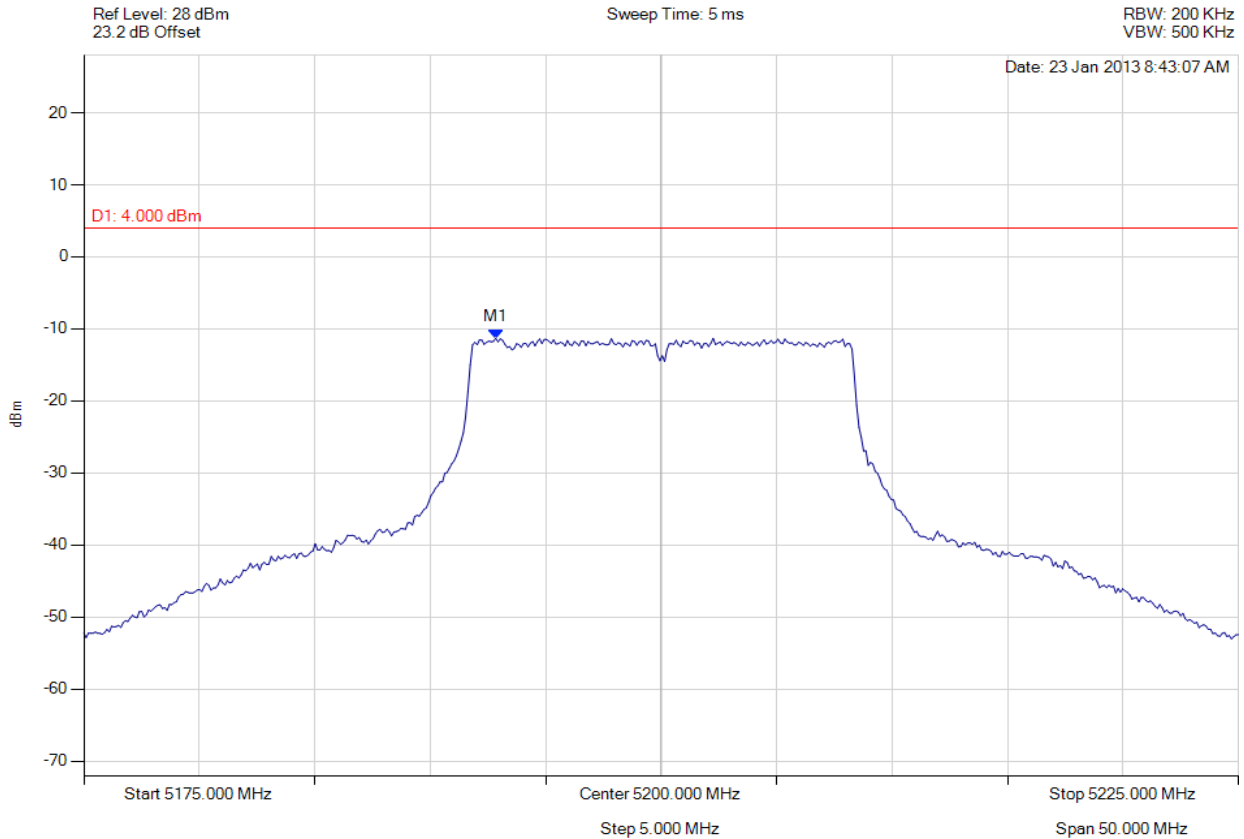

Analyser Setup	Marker : Frequency : Amplitude	Test Results
Detector = RMS Sweep Count = 100 RF Atten (dB) = 20 Trace Mode = VIEW	M1 : 5192.836 MHz : -11.313 dBm	Limit: ≤ 4.000 dBm Margin: -15.31 dB

[Back to the Matrix](#)

This test report may be reproduced in full only. The document may only be updated by MiCOM Labs personnel. Any changes will be noted in the Document History section of the report.



Title: Ear Force XP510 TX Wireless Audio Transmitter
To: FCC 47 CFR Part 15.407 & IC RSS-210
Serial #: COMM20-U2 Rev A
Issue Date: 12th February 2013
Page: 63 of 67



PEAK POWER SPECTRAL DENSITY

Variant: 802.11a, Channel: 5240.00 MHz, Chain a, Temp: Ambient, Voltage: 5 Vdc

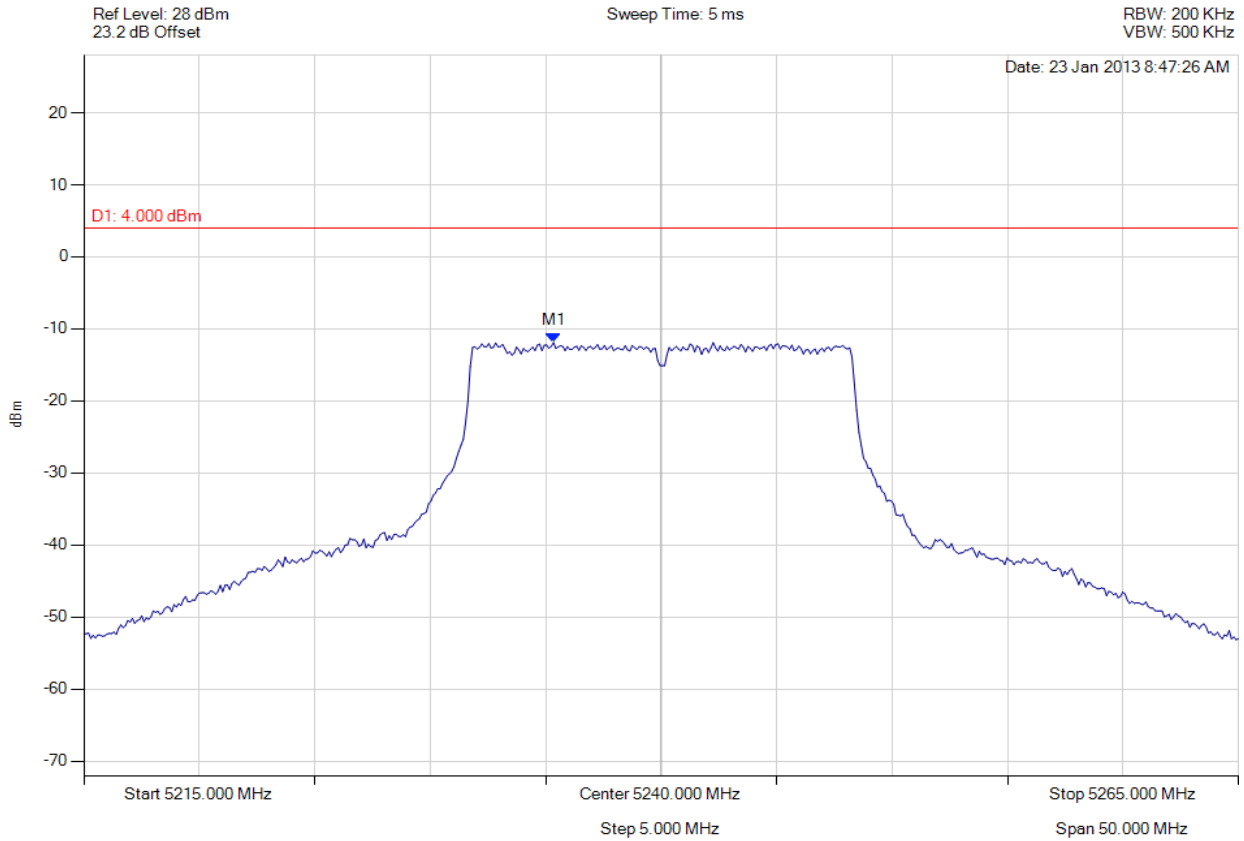

Analyser Setup	Marker : Frequency : Amplitude	Test Results
Detector = RMS Sweep Count = 100 RF Atten (dB) = 20 Trace Mode = VIEW	M1 : 5235.341 MHz : -11.904 dBm	Limit: ≤ 4.000 dBm Margin: -15.90 dB

[Back to the Matrix](#)

This test report may be reproduced in full only. The document may only be updated by MiCOM Labs personnel. Any changes will be noted in the Document History section of the report.



A.1.3. Peak Excursion Ratio



PEAK EXCURSION RATIO

Variant: 802.11a, Channel: 5180.00 MHz, Chain a, Temp: Ambient, Voltage: 5.00 Vdc

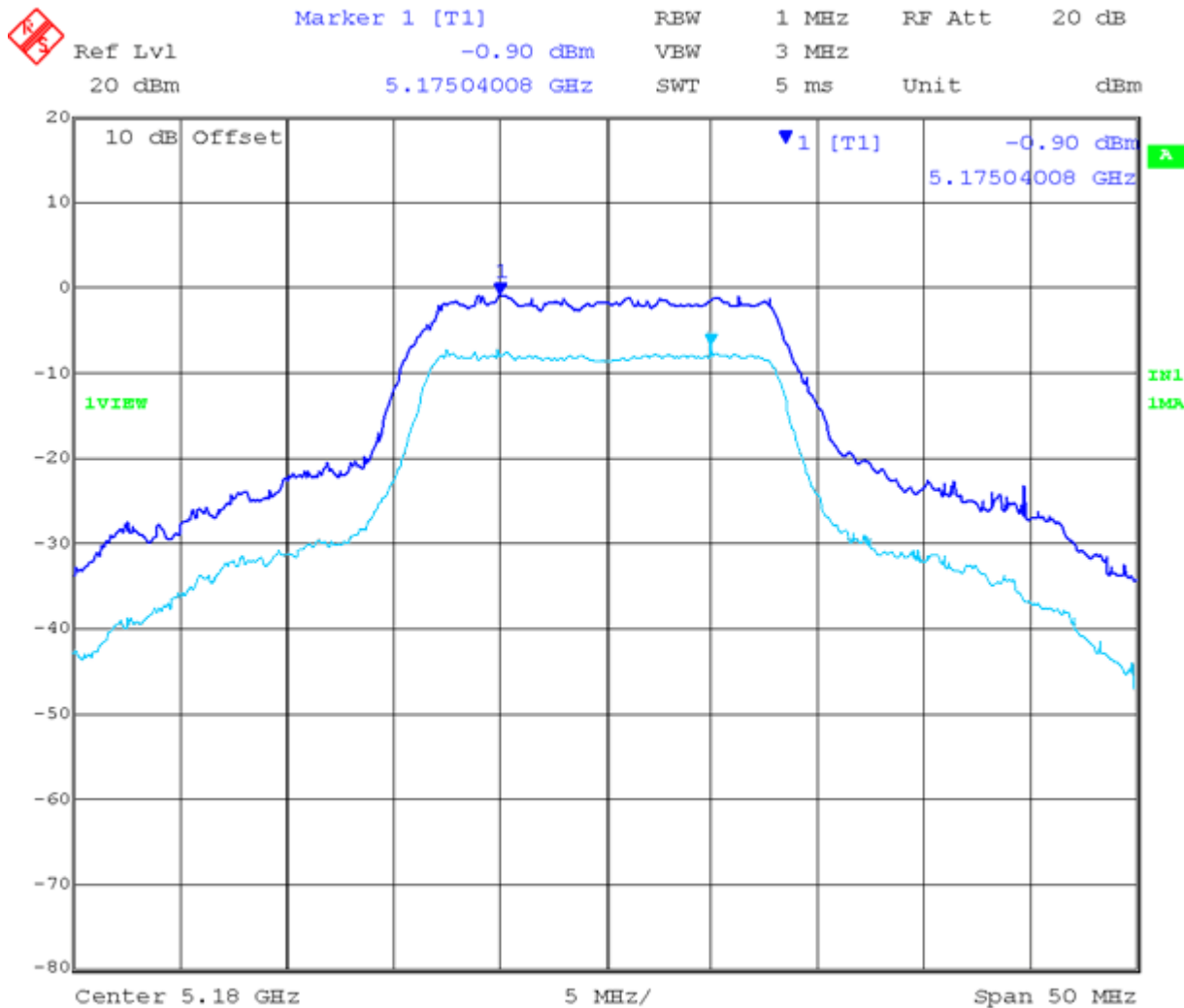

Date: 15.JAN.2013 19:49:50

Analyser Setup	Marker : Frequency : Amplitude	Test Results
Sweep Count = 0 RF Atten (dB) = 30 TRACE 1 Detector = MAX PEAK Trace Mode = VIEW TRACE 2 Detector = RMS Trace Mode = VIEW	M1 : 5180 MHz : -0.90 dBm Delta1 : -6.60dB	Measured Excursion Ratio: 6.60 dB Limit: -13.0 dB Margin: -6.40 dB

[Back to the Matrix](#)

This test report may be reproduced in full only. The document may only be updated by MiCOM Labs personnel. Any changes will be noted in the Document History section of the report.



Title: Ear Force XP510 TX Wireless Audio Transmitter
To: FCC 47 CFR Part 15.407 & IC RSS-210
Serial #: COMM20-U2 Rev A
Issue Date: 12th February 2013
Page: 65 of 67



peak excursion

Variant: 802.11a, Channel: 5200.00 MHz, Chain a, Temp: Ambient, Voltage: 5.00 V

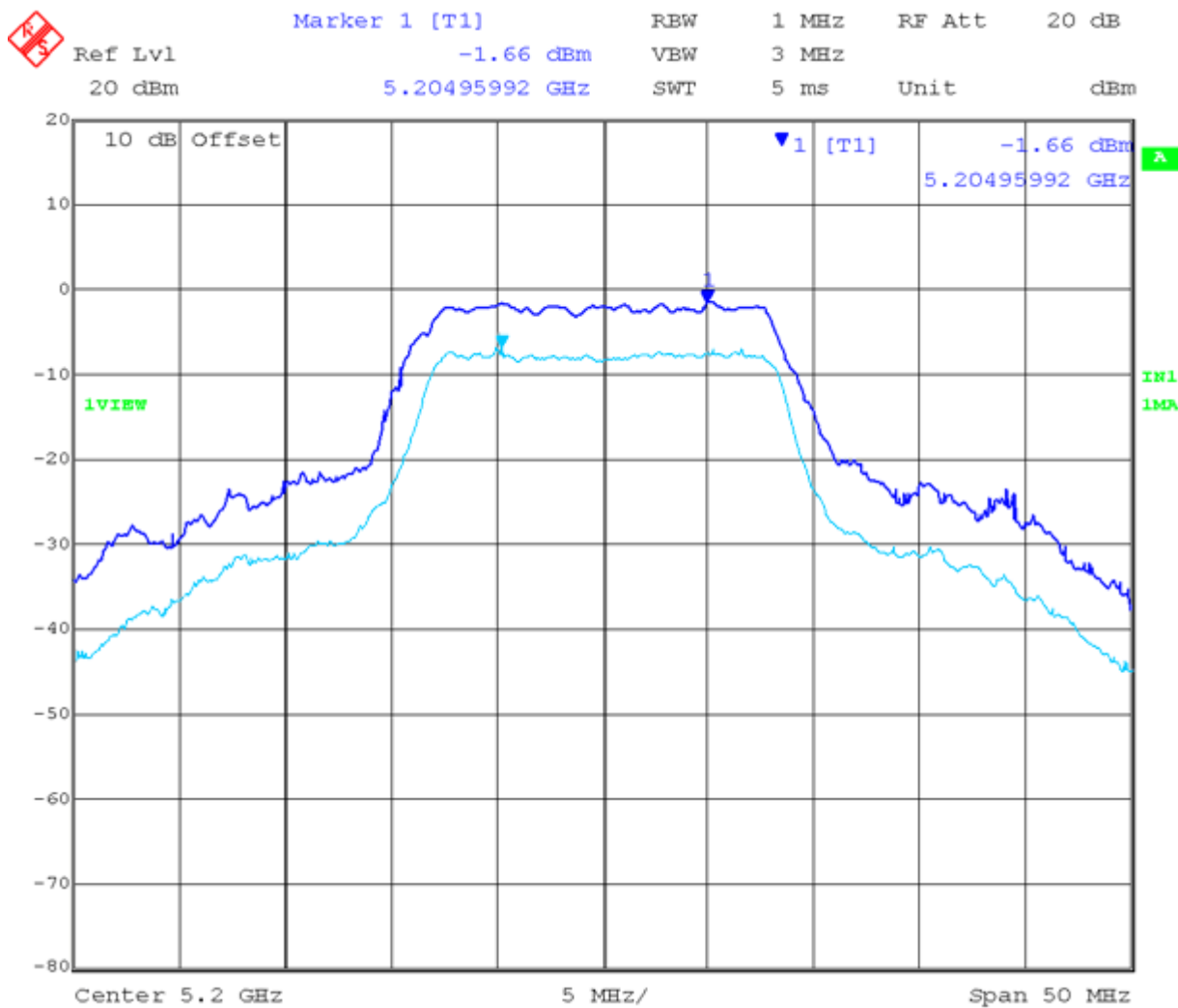

Date: 15.JAN.2013 19:52:19

Analyser Setup	Marker : Frequency : Amplitude	Test Results
Sweep Count = 0 RF Atten (dB) = 30 TRACE 1 Detector = MAX PEAK Trace Mode = VIEW TRACE 2 Detector = RMS Trace Mode = VIEW	M1 : 5203.960 MHz : -1.66 Delta1 : -5.11 dB	Measured Excursion Ratio: 4.68 dB Limit: -13.0 dB Margin: -7.89 dB

[Back to the Matrix](#)

This test report may be reproduced in full only. The document may only be updated by MiCOM Labs personnel. Any changes will be noted in the Document History section of the report.



Title: Ear Force XP510 TX Wireless Audio Transmitter
To: FCC 47 CFR Part 15.407 & IC RSS-210
Serial #: COMM20-U2 Rev A
Issue Date: 12th February 2013
Page: 66 of 67



peak excursion

Variant: 802.11a, Channel: 5240.00 MHz, Chain a, Temp: Ambient, Voltage: 5.00V

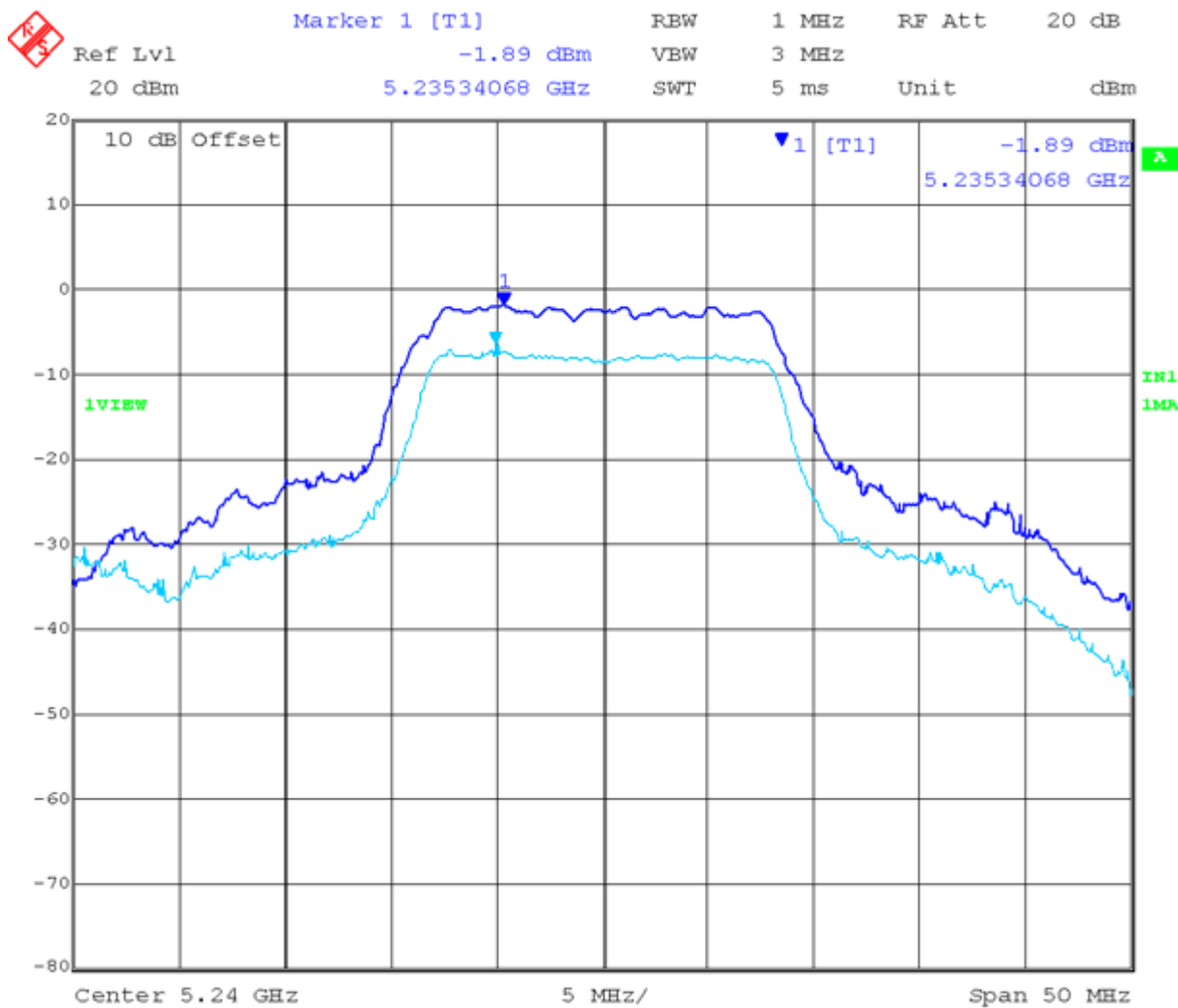

Date: 15.JAN.2013 19:53:58

Analyser Setup	Marker : Frequency : Amplitude	Test Results
Sweep Count = 0 RF Atten (dB) = 30 TRACE 1 Detector = MAX PEAK Trace Mode = VIEW TRACE 2 Detector = RMS Trace Mode = VIEW	M1 : 5235.341 MHz : -1.89 dBm Delta1 : -4.88 dB	Measured Excursion Ratio: 4.88 dB Limit: -13.0 dB Margin: -8.12 dB

[Back to the Matrix](#)

This test report may be reproduced in full only. The document may only be updated by MiCOM Labs personnel. Any changes will be noted in the Document History section of the report.



440 Boulder Court, Suite 200
Pleasanton, CA 94566, USA
Tel: 1.925.462.0304
Fax: 1.925.462.0306
www.micomlabs.com