



NVLAP LAB CODE 200707-0



# FCC PART 15.249

## MEASUREMENT AND TEST REPORT

For

### Voyetra Turtle Beach, Inc.

150 Clearbrook Road, Ste 162,

Elmsford, NY 10523, USA

**FCC ID: XGB-TB2171A**  
**Model: X41**

<b>Report Type:</b> Original Report	<b>Product Type:</b> X41 Wireless RF Transmitter
<b>Test Engineer:</b> <u>Weir Zhong</u> <span style="float: right;"><i>Weir Zhong</i></span>	
<b>Report Number:</b> <u>RSZ10022603</u>	
<b>Report Date:</b> <u>2010-04-01</u>	
<b>Reviewed By:</b> <u>Merry Zhao</u> <span style="float: right;"><i>Merry Zhao</i></span> EMC Engineer	
<b>Prepared By:</b>	Bay Area Compliance Laboratories Corp. (Shenzhen) 6/F, the 3rd Phase of WanLi Industrial Building, ShiHua Road, FuTian Free Trade Zone Shenzhen, Guangdong, China Tel: +86-755-33320018 Fax: +86-755-33320008

**Note:** This test report is prepared for the customer shown above and for the device described herein. It may not be duplicated or used in part without prior written consent from Bay Area Compliance Laboratories Corp. (Shenzhen). This report **must not** be used by the customer to claim product certification, approval, or endorsement by NVLAP\*, NIST, or any agency of the Federal Government.

\* This report may contain data that are not covered by the NVLAP accreditation and are marked with an asterisk "\*" (Rev.2)

## TABLE OF CONTENTS

<b>GENERAL INFORMATION.....</b>	<b>3</b>
PRODUCT DESCRIPTION FOR EQUIPMENT UNDER TEST (EUT) .....	3
OBJECTIVE .....	3
RELATED SUBMITTAL(S)/GRANT(S).....	3
TEST METHODOLOGY .....	3
TEST FACILITY .....	3
<b>SYSTEM TEST CONFIGURATION.....</b>	<b>5</b>
JUSTIFICATION .....	5
EQUIPMENT MODIFICATIONS .....	5
LOCAL SUPPORT EQUIPMENT LIST AND DETAILS .....	5
EXTERNAL I/O CABLE.....	5
CONFIGURATION OF TEST SETUP .....	6
BLOCK DIAGRAM OF TEST SETUP .....	6
<b>SUMMARY OF TEST RESULTS .....</b>	<b>7</b>
<b>FCC §15.203 - ANTENNA REQUIREMENT.....</b>	<b>8</b>
APPLICABLE STANDARD .....	8
ANTENNA CONNECTOR CONSTRUCTION .....	8
<b>FCC §15.107 &amp; §15.207(A) - CONDUCTED EMISSIONS .....</b>	<b>9</b>
APPLICABLE STANDARD .....	9
MEASUREMENT UNCERTAINTY.....	9
EUT SETUP.....	9
EMI TEST RECEIVER SETUP.....	10
TEST EQUIPMENT LIST AND DETAILS.....	10
TEST PROCEDURE .....	10
TEST RESULTS SUMMARY .....	10
TEST DATA .....	10
<b>FCC §15.109, §15.205, §15.209 &amp; §15.249 - RADIATED EMISSIONS .....</b>	<b>15</b>
APPLICABLE STANDARD .....	15
MEASUREMENT UNCERTAINTY.....	15
TEST EQUIPMENT SETUP.....	15
TEST SETUP.....	16
TEST EQUIPMENT LIST AND DETAILS.....	16
TEST PROCEDURE .....	17
CORRECTED AMPLITUDE & MARGIN CALCULATION .....	17
TEST RESULTS SUMMARY .....	17
TEST DATA .....	18
<b>FCC §15.249(D) – OUT OF BAND EMISSIONS.....</b>	<b>22</b>
APPLICABLE STANDARD .....	22
TEST PROCEDURE .....	22
MEASUREMENT UNCERTAINTY.....	22
TEST EQUIPMENT SETUP.....	22
TEST SETUP.....	23
TEST EQUIPMENT LIST AND DETAILS.....	23
TEST DATA .....	24

---

## GENERAL INFORMATION

---

### Product Description for Equipment under Test (EUT)

The *Voyetra Turtle Beach, Inc.* 's product, model *X41(FCC ID: XGB-TB2171A)*, or the "EUT" as referred to in this report is a *X41 Wireless RF Transmitter* which measures approximately 11 cm L x 11 cm W x 22 cm H, rated input voltage: DC 5V From PC.

*\* All measurement and test data in this report was gathered from production sample serial number: 1002040 (Assigned by BAEL, Shenzhen). The EUT was received on 2010-02-26.*

### Objective

This Type approval report is prepared on behalf of *Voyetra Turtle Beach, Inc.* in accordance with Part 2, Subpart J, and Part 15, Subparts A, B and C of the Federal Communication Commissions rules.

The tests were performed in order to determine compliance with FCC Part 15, Subpart C, and section 15.203, 15.205, 15.207, 15.109, 15.209 and 15.249 rules.

### Related Submittal(s)/Grant(s)

No Related Submittals.

### Test Methodology

All measurements contained in this report were conducted with ANSI C63.4-2003, American National Standard for Methods of Measurement of Radio-Noise Emissions from Low-Voltage Electrical and Electronic Equipment in the range of 9 kHz to 40 GHz.

All radiated and conducted emissions measurement was performed at Bay Area Compliance Laboratories Corp. (Shenzhen). The radiated testing was performed at an antenna-to-EUT distance of 3 meters.

### Test Facility

The Test site used by Bay Area Compliance Laboratories Corp. (Shenzhen) to collect test data is located in the 6/F, the 3rd Phase of WanLi Industrial Building, ShiHua Road, FuTian Free Trade Zone Shenzhen, Guangdong, China.

Test site at Bay Area Compliance Laboratories Corp. (Shenzhen) has been fully described in reports submitted to the Federal Communication Commission (FCC). The details of these reports have been found to be in compliance with the requirements of Section 2.948 of the FCC Rules on November 21, 2007. The facility also complies with the radiated and AC line conducted test site criteria set forth in ANSI C63.4-2003.

The Federal Communications Commission has the reports on file and is listed under FCC Registration No.: 382179. The test site has been approved by the FCC for public use and is listed in the FCC Public Access Link (PAL) database.

Additionally, Bay Area Compliance Laboratories Corp. (Shenzhen) is a National Institute of Standards and Technology (NIST) accredited laboratory, under the National Voluntary Laboratory Accredited Program (Lab Code 200707-0).



NVLAP LAB CODE 200707-0

The current scope of accreditations can be found at <http://ts.nist.gov/Standards/scopes/2007070.htm>

## SYSTEM TEST CONFIGURATION

### Justification

The system was configured for testing in a typical fashion (as normally used by a typical user).

### Equipment Modifications

No modifications were made to the unit tested.

### Local Support Equipment List and Details

Manufacturer	Description	Model	Serial Number	FCC ID
KONKA	TV	T14FA073	AQX337YY5029056	DOC
Microsoft	X BOX	XBOX360	504706661306	N/A
Microsoft	AC Adapter	DSP-186CB-1A	9902B013806613	N/A

### External I/O Cable

Cable Description	Length (m)	From/Port	To
Shielded Detachable HD AV Cable	2.5	Fiber Port/XBOX360	EUT
Unshielded Detachable Fiber Cable	3.0	USB Port/ XBOX360	EUT
Shielded Detachable DC Cable	1.2	DC Port/Adapter	XBOX360
Shielded Detachable AC Cable	1.8	AC Port/Adapter	AC Mains
Unshielded Detachable Headphone Cable	1.2	Headphone Port/EUT	AC Mains

### Configuration of Test Setup

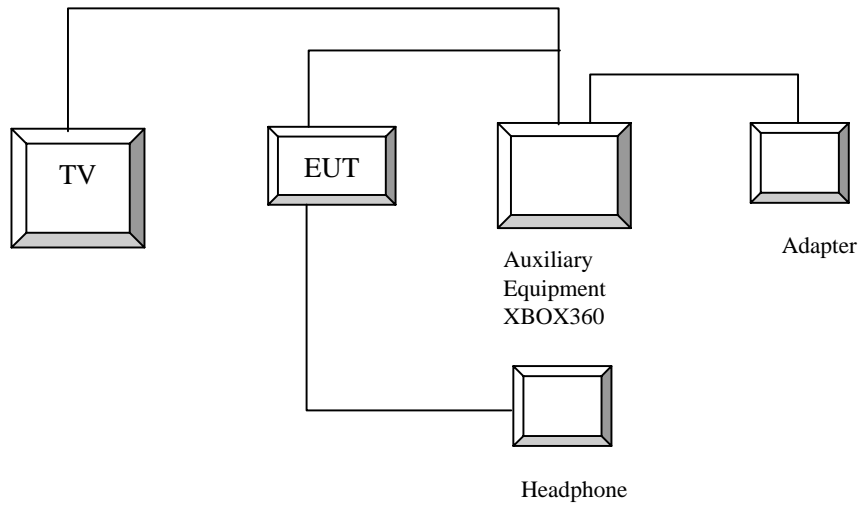

### Block Diagram of Test Setup

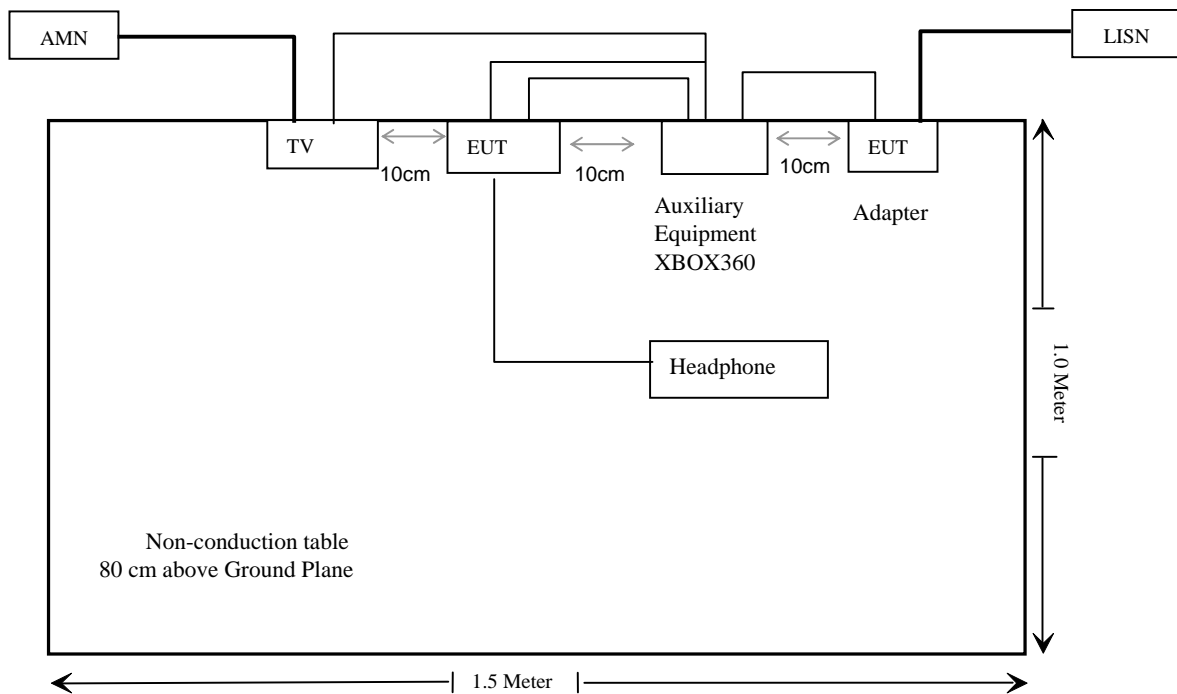

**SUMMARY OF TEST RESULTS**

<b>FCC Rules</b>	<b>Description of Test</b>	<b>Result</b>
§15.203	Antenna Requirement	Compliant
§15.207(a)	Conduction Emissions	Compliant
§15.109, §15.205(a), §15.209(a), 15.249(a), §15.249(c), §15.35	Radiated Emissions	Compliant
§15.249(d)	Out of Band Emissions	Compliant

---

## **FCC §15.203 - ANTENNA REQUIREMENT**

---

### **Applicable Standard**

For intentional device, according to FCC §15.203, an intentional radiator shall be designed to ensure that no antenna other than that furnished by the responsible party shall be used.

### **Antenna Connector Construction**

The EUT has a printed antenna on PCB, which in accordance to section 15.203, is considered sufficient to comply with the provisions of this section.

**Result:** Compliant.

Please refer to the EUT photos.



## FCC §15.107 & §15.207(a) - CONDUCTED EMISSIONS

### Applicable Standard

FCC §15.207, §15.207

### Measurement Uncertainty

All measurements involve certain levels of uncertainties, especially in field of EMC. The factors contributing to uncertainties are spectrum analyzer, cable loss, and LISN.

Based on NIS 81, The Treatment of Uncertainty in EMC Measurements, the best estimate of the uncertainty of any conducted emissions measurement at Bay Area Compliance Laboratory Corp. (Shenzhen) is  $\pm 2.4$  dB.

### EUT Setup

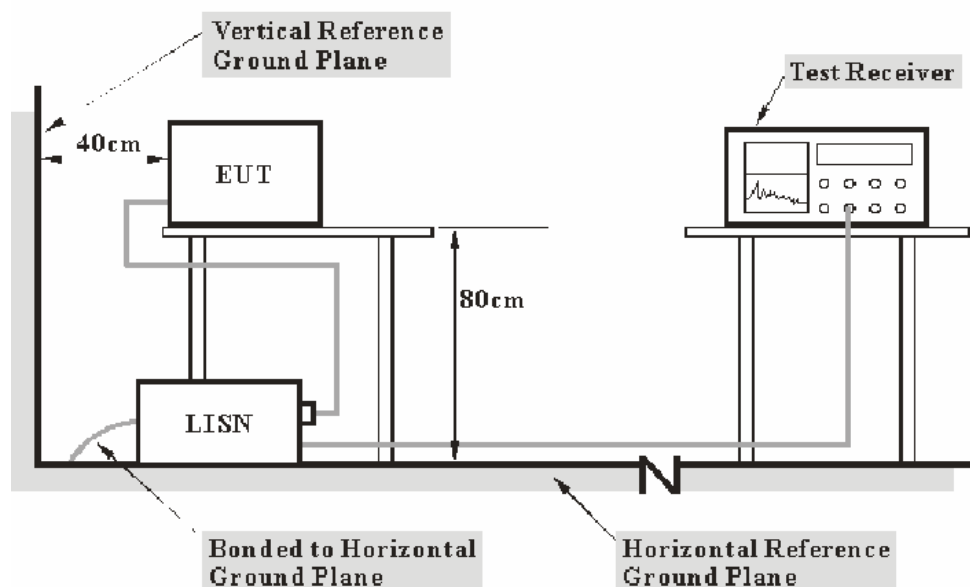

- Note:**
1. Support units were connected to second LISN.
  2. Both of LISNs (AMN) 80 cm from EUT and at least 80 cm from other units and other metal planes support units.

The setup of EUT is according with per ANSI C63.4-2003 measurement procedure. The specification used was with the FCC Part 15.107 and 15.207 limits.

The spacing between the peripherals was 10 cm.

The adapter was connected to a 120 VAC/60 Hz power source.

## EMI Test Receiver Setup

The EMI test receiver was set to investigate the spectrum from 150 kHz to 30 MHz.

During the conducted emission test, the EMI test receiver was set with the following configurations:

<i><b>Frequency Range</b></i>	<i><b>IF B/W</b></i>
150 kHz – 30 MHz	9 kHz

## Test Equipment List and Details

Manufacturer	Description	Model	Serial Number	Calibration Date	Calibration Due Date
Rohde & Schwarz	EMI Test Receiver	ESCS30	830245/006	2009-04-28	2010-04-27
Rohde & Schwarz	L.I.S.N.	ESH2-Z5	892107/021	2009-04-28	2010-04-27

\* **Statement of Traceability:** Bay Area Compliance Laboratory Corp. (Shenzhen) attests that all calibrations have been performed in accordance to NVLAP requirements, traceable to the NIST.

## Test Procedure

Maximizing procedure was performed on the six (6) highest emissions of the EUT.

All data was recorded in the Quasi-peak and average detection mode.

## Test Results Summary

According to the recorded data in following table, the EUT complied with the FCC Part 15.107, 15.249, and 15.207, with the worst margin reading of:

**Transmitting Mode: 20.90 dB at 4.410 MHz in the Line conductor mode**  
**Transmitting Mode: 21.90 dB at 1.040 MHz in the Neutral conductor mode**

**Receiving Mode: 20.90 dB at 4.410 MHz in the Line conductor mode**  
**Receiving Mode: 20.73 dB at 4.410 MHz in the Neutral conductor mode**

## Test Data

### Environmental Conditions

<b>Temperature:</b>	25 °C
<b>Relative Humidity:</b>	56 %
<b>ATM Pressure:</b>	100.0 kPa

\* *The testing was performed by Weir Zhong on 2010-03-08.*

Test Mode: Transmitting

Line:

Conducted Emission			FCC Part 15.207		
Frequency (MHz)	Correction Factor (dB)	Cord. Result (dBμV)	Limit (dBμV)	Margin (dB)	Remark (PK/AV/QP)
4.410	10.10	25.10	46.00	20.90	AV
0.650	10.10	23.17	46.00	22.83	AV
1.040	10.10	22.21	46.00	23.79	AV
1.360	10.10	21.95	46.00	24.05	AV
0.390	10.10	20.73	48.08	27.35	AV
16.470	10.30	20.04	50.00	29.96	AV
1.040	10.10	24.99	56.00	31.01	QP
4.410	10.10	24.89	56.00	31.11	QP
0.650	10.10	24.45	56.00	31.55	QP
1.360	10.10	23.12	56.00	32.88	QP
0.390	10.10	22.38	58.08	35.70	QP
16.340	10.30	21.16	60.00	38.84	QP

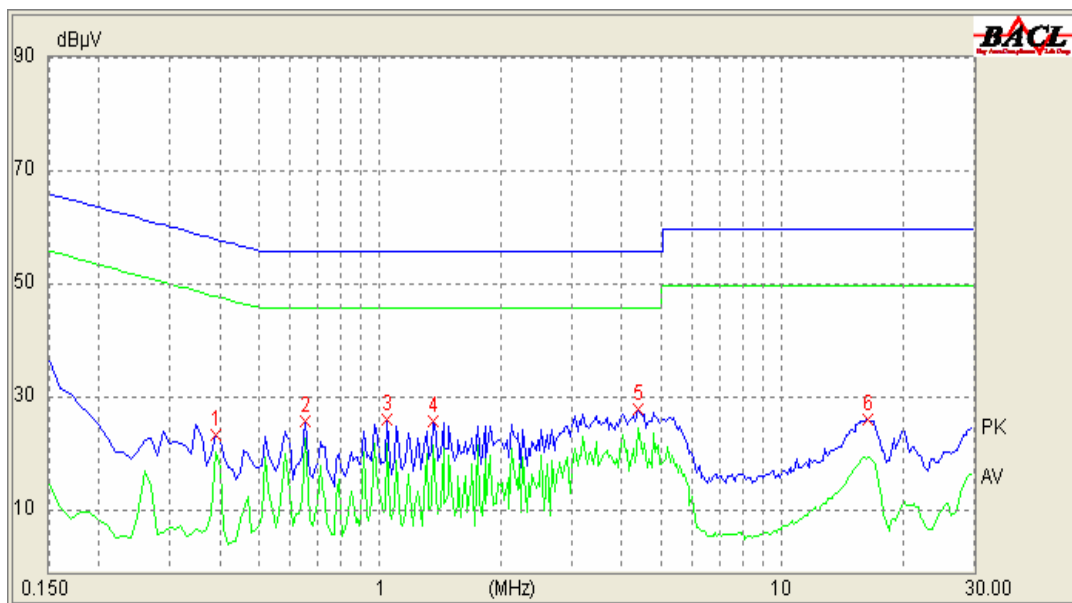

**Neutral:**

Conducted Emission			FCC Part 15.207		
Frequency (MHz)	Correction Factor (dB)	Cord. Result (dBµV)	Limit (dBµV)	Margin (dB)	Remark (PK/AV/QP)
1.040	10.10	24.10	46.00	21.90	AV
4.350	10.10	23.93	46.00	22.07	AV
0.650	10.10	23.17	46.00	22.83	AV
0.260	10.10	25.45	51.49	26.04	AV
16.490	10.30	23.59	50.00	26.41	AV
0.180	10.10	27.17	54.57	27.40	AV
4.350	10.10	25.64	56.00	30.36	QP
1.040	10.10	25.37	56.00	30.63	QP
0.650	10.10	24.73	56.00	31.27	QP
16.490	10.30	26.07	60.00	33.93	QP
0.260	10.10	27.05	61.49	34.44	QP
0.180	10.10	29.80	64.57	34.77	QP

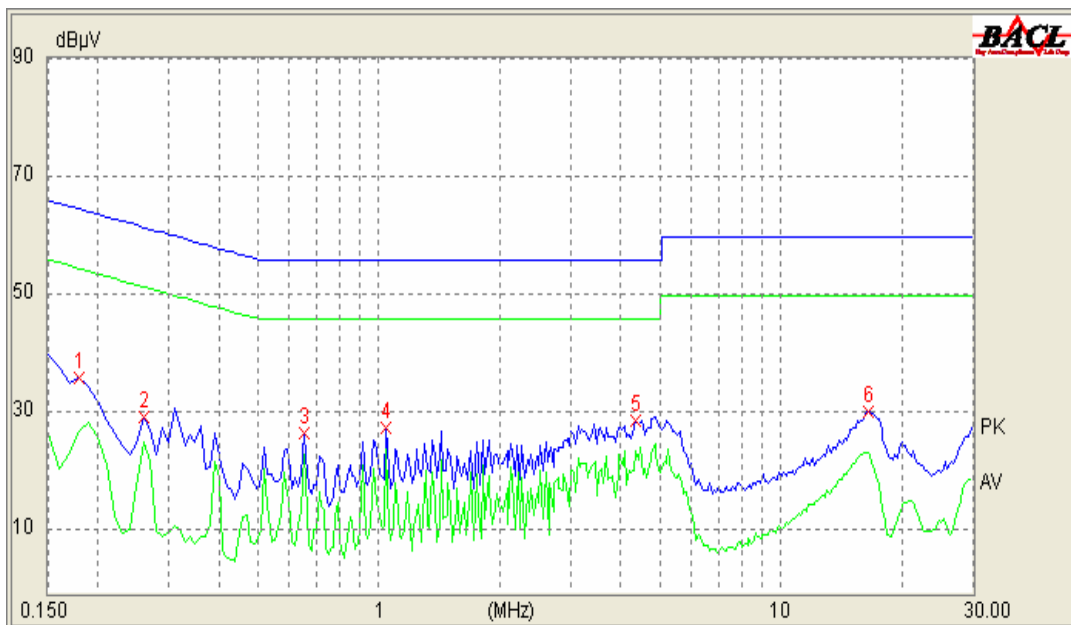

Test Mode: Receiving

Line:

Conducted Emission			FCC Part 15.107		
Frequency (MHz)	Correction Factor (dB)	Cord. Result (dBµV)	Limit (dBµV)	Margin (dB)	Remark (PK/AV/QP)
4.410	10.10	25.10	46.00	20.90	AV
3.200	10.10	23.48	46.00	22.52	AV
0.650	10.10	23.17	46.00	22.83	AV
1.040	10.10	22.21	46.00	23.79	AV
1.360	10.10	21.95	46.00	24.05	AV
0.390	10.10	20.73	48.08	27.35	AV
4.410	10.10	25.78	56.00	30.22	QP
3.200	10.10	25.06	56.00	30.94	QP
1.040	10.10	24.63	56.00	31.37	QP
0.650	10.10	24.35	56.00	31.65	QP
1.360	10.10	23.66	56.00	32.34	QP
0.390	10.10	22.46	58.08	35.62	QP

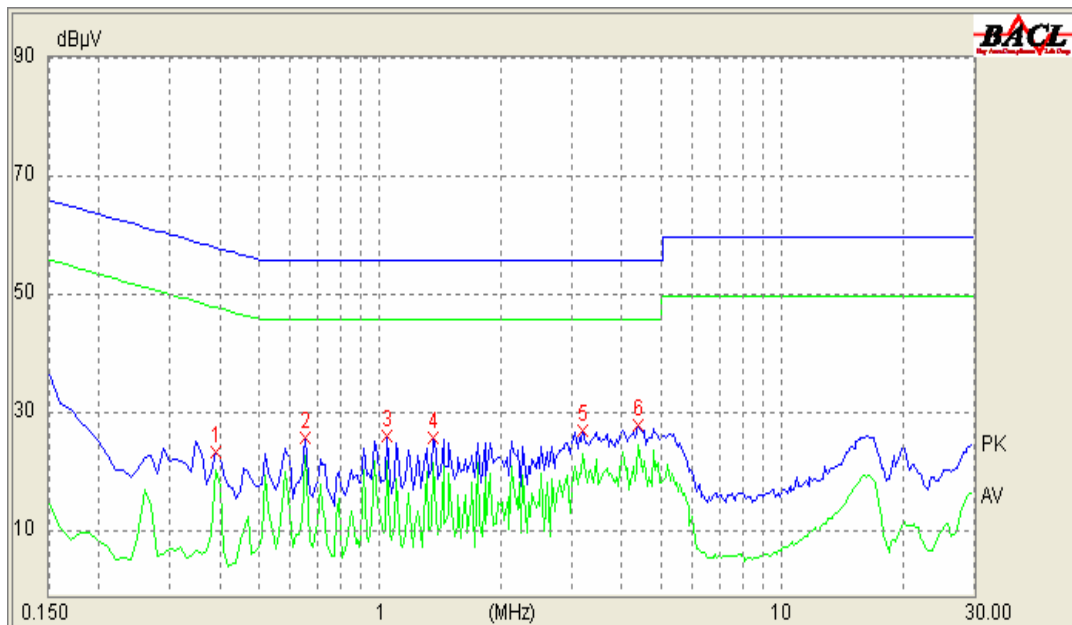

**Neutral:**

Conducted Emission			FCC Part 15.107		
Frequency (MHz)	Correction Factor (dB)	Cord. Result (dBµV)	Limit (dBµV)	Margin (dB)	Remark (PK/AV/QP)
4.410	10.10	25.27	46.00	20.73	AV
1.360	10.10	23.21	46.00	22.79	AV
0.650	10.10	22.83	46.00	23.17	AV
0.190	10.10	29.44	54.13	24.69	AV
0.260	10.10	25.34	51.49	26.15	AV
15.950	10.30	23.47	50.00	26.53	AV
4.410	10.10	26.57	56.00	29.43	QP
0.650	10.10	24.37	56.00	31.63	QP
1.360	10.10	24.29	56.00	31.71	QP
0.190	10.10	31.37	64.13	32.76	QP
0.260	10.10	27.01	61.49	34.48	QP
15.950	10.30	24.87	60.00	35.13	QP

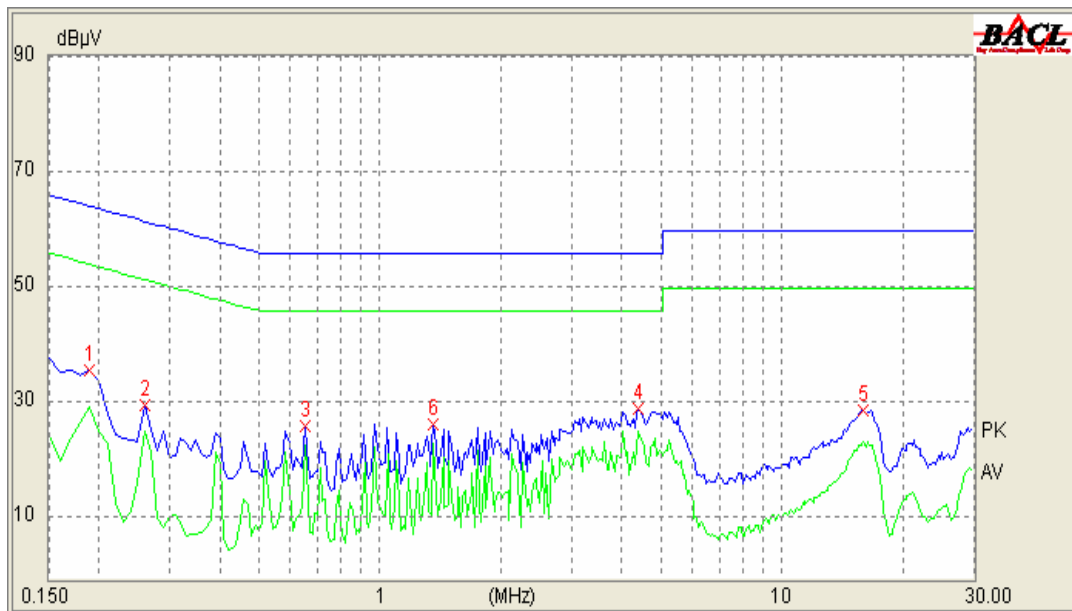

## FCC §15.109, §15.205, §15.209 & §15.249 - RADIATED EMISSIONS

### Applicable Standard

As per FCC §15.249 (a), except as provided in paragraph (b) of this section, the field strength of emissions from intentional radiators operated within these frequency bands shall comply with the following:

Fundamental frequency	Field strength of fundamental (millivolts/meter)	Field strength of harmonics (microvolts/meter)
902–928 MHz	50	500
2400–2483.5 MHz	50	500
5725–5875 MHz	50	500
24.0–24.25 GHz	250	2500

As per FCC §15.249 (c), Field strength limits are specified at a distance of 3 meters.

### Measurement Uncertainty

All measurements involve certain levels of uncertainties, especially in field of EMC. The factors contributing to uncertainties are spectrum analyzer, cable loss, antenna factor calibration, antenna directivity, antenna factor variation with height, antenna phase center variation, antenna factor frequency interpolation, measurement distance variation, site imperfections, mismatch (average), and system repeatability.

Based on NIS 81, The Treatment of Uncertainty in EMC Measurements, the best estimate of the uncertainty of a radiation emissions measurement at Bay Area Compliance Laboratories Corp. (Shenzhen) is  $\pm 4.0$  dB.

### Test Equipment Setup

The spectrum analyzer or receiver is set as:

Below 1000 MHz:

$$\text{RBW} = 100 \text{ kHz} / \text{VBW} = 300 \text{ kHz} / \text{Sweep} = \text{Auto}$$

Above 1000 MHz:

$$\begin{aligned} \text{Peak: RBW} &= 1\text{MHz} / \text{VBW} = 1\text{MHz} / \text{Sweep} = \text{Auto} \\ \text{Average: RBW} &= 1\text{MHz} / \text{VBW} = 10\text{Hz} / \text{Sweep} = \text{Auto} \end{aligned}$$

**Test Setup**

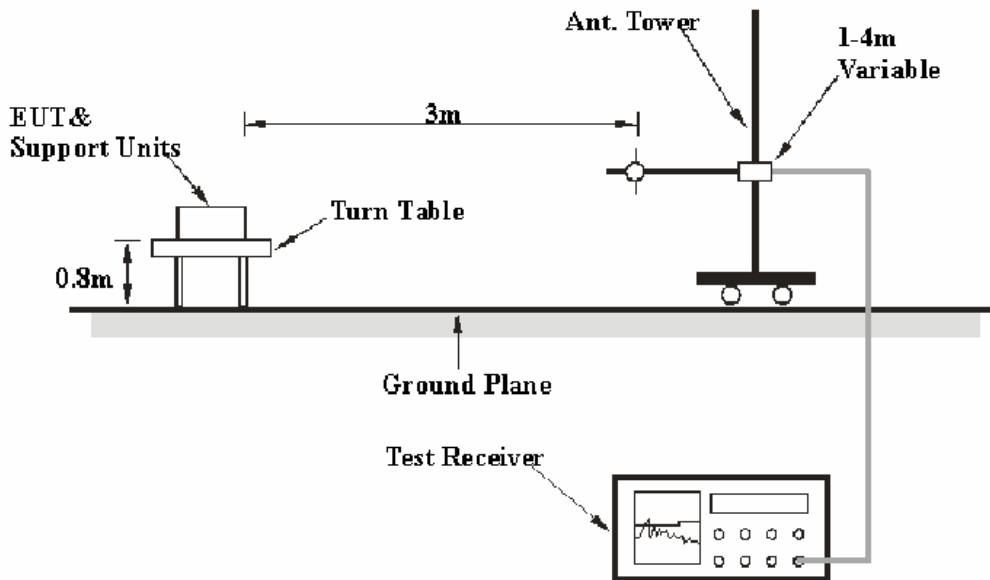

The radiated emission and out of band emission tests were performed in the 3 meters chamber B, using the setup accordance with the ANSI C63.4-2003. The specification used was the FCC 15.209, FCC 15.109 and FCC 15.249 limits.

**Test Equipment List and Details**

Manufacturer	Description	Model	Serial Number	Calibration Date	Calibration Due Date
HP	Amplifier	8447E	1937A01046	2009-08-02	2010-08-01
Rohde & Schwarz	EMI Test Receiver	ESCI	100224	2009-11-24	2010-11-23
Sunol Sciences	Bilog Antenna	JB1	A040904-2	2009-04-12	2010-04-12
HP	Amplifier	8449B	3008A00277	2009-09-12	2010-09-11
Sunol Sciences	Horn Antenna	DRH-118	A052604	2009-05-05	2010-05-04
Rohde & Schwarz	Spectrum Analyzer	FSEM30	849720/019	2009-07-08	2010-07-07

\* **Statement of Traceability:** Bay Area Compliance Laboratories Corp. (Shenzhen) attests that all calibrations have been performed in accordance to NVLAP requirements, traceable to the NIST.



## Test Procedure

For the radiated emissions test, the TV and other support equipment were connected to the AC floor outlet.

Maximizing procedure was performed on the highest emissions to ensure that the EUT complied with all installation combinations.

The EUT is set 3 meter away from the testing antenna, which is varied from 1-4 mete, and the EUT is placed on a turntable, which is 0.8 meter above ground plane, the table shall be rotated for 360 degrees to find out the highest emission. The receiving antenna should be changed the polarization both of horizontal and vertical.

## Corrected Amplitude & Margin Calculation

The Corrected Amplitude is calculated by adding the Antenna Factor and Cable Loss, and subtracting the Amplifier Gain from the Meter Reading. The basic equation is as follows:

$$\text{Corrected Amplitude} = \text{Meter Reading} + \text{Antenna Factor} + \text{Cable Loss} - \text{Amplifier Gain}$$

The “**Margin**” column of the following data tables indicates the degree of compliance with the applicable limit. For example, a margin of 7 dB means the emission is 7 dB below the limit. The equation for margin calculation is as follows:

$$\text{Margin} = \text{Limit} - \text{Corrected Amplitude}$$

## Test Results Summary

According to the data in the following table, the EUT complied with the FCC Part 15.209, 15.109 and 15.249, with the worst margin reading of:

### Below 1 GHz:

Transmitting Mode: **2.5 dB** at **37.035 MHz** in the **Vertical** polarization.  
Receiving Mode: **6.2 dB** at **674.650000 MHz** in the **Horizontal** polarization

### Above 1 GHz:

Transmitting Mode: **14.04 dB** at **2382.35 MHz** in the **Horizontal** polarization, Low Channel  
Transmitting Mode: **18.43 dB** at **4880 MHz** in the **Horizontal** polarization, Middle channel  
Transmitting Mode: **12.04 dB** at **2484.46MHz** in the **Horizontal** polarization, High channel

**Test Data**

**Environmental Conditions**

<b>Temperature:</b>	25 ° C
<b>Relative Humidity:</b>	56%
<b>ATM Pressure:</b>	100.0 kPa

The testing was performed by Weir Zhong on 2010-03-11.

Test Mode: Transmitting (Worse case)

**Below 1 GHz:**

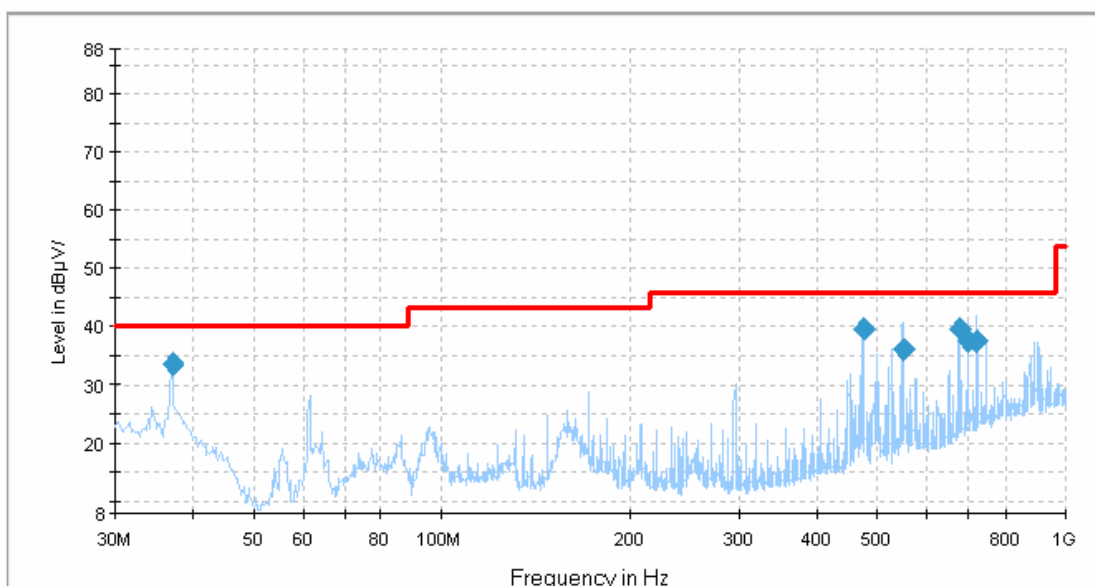

Frequency (MHz)	Corrected Amplitude (dBµV/m)	Antenna Height (cm)	Antenna Polarity (H/V)	Turntable Position (deg)	Limit (dBµV/m)	Margin (dB)
549.851250	36.1	101.0	V	74.0	46.0	9.9
674.650000	39.8	100.0	H	46.0	46.0	6.2
474.746250	39.6	140.0	V	269.0	46.0	6.4
721.791500	37.6	100.0	V	88.0	46.0	8.4
699.538750	37.5	163.0	H	47.0	46.0	8.5
37.035000	33.9	294.0	V	192.0	40.0	2.5*

\* Within measurement uncertainty.

## Above 1 GHz:

Frequency (MHz)	S.A. Reading (dBµV/m)	Detector PK/AV	Direction Degree	Test Antenna			Cable Loss (dB)	Pre Amp. Gain (dB)	Cord. Amp. (dBµV/m)	FCC 15.209/15.249		
				Height (m)	Polar (H/V)	Factor (dB)				Limit (dBµV/m)	Margin (dB)	comment
Low Channel												
2404	84.35	AV	81	1.5	V	30.3	7.90	33.9	88.65	94	5.35	Fund.
2404	81.00	AV	53	1.9	H	30.9	7.90	33.9	85.9	94	8.10	Fund.
2382.35	35.06	AV	360	1.8	H	30.9	7.90	33.9	39.96	54	14.04	spurious
2382.35	34.12	AV	226	1.0	V	30.3	7.90	33.9	38.42	54	15.58	spurious
4808	46.28	AV	276	1.0	H	36.3	7.76	33.7	56.64	74	17.36	harmonic
2404	89.56	PK	81	1.5	V	30.3	7.90	33.9	93.86	114	20.14	Fund.
2382.35	47.66	PK	360	1.8	H	30.9	7.90	33.9	52.56	74	21.44	spurious
4808	42.52	AV	180	1.5	V	35.0	7.76	33.7	51.58	74	22.42	harmonic
2382.35	46.51	PK	226	1.0	V	30.3	7.90	33.9	50.81	74	23.19	spurious
2404	85.21	PK	53	1.9	H	30.9	7.90	33.9	90.11	114	23.89	Fund.
4808	52.30	PK	276	1.0	H	36.3	7.76	33.7	62.66	94	31.34	harmonic
4808	48.40	PK	180	1.5	V	35.0	7.76	33.7	57.46	94	36.54	harmonic
Middle Channel												
2440	85.24	AV	150	1.6	V	30.4	7.95	33.9	89.69	94	4.31	Fund.
2440	81.10	AV	322	1.0	H	31.0	7.95	33.9	86.15	94	7.85	Fund.
4880	44.75	AV	310	1.8	H	36.6	7.92	33.7	55.57	74	18.43	harmonic
2440	90.07	PK	150	1.6	V	30.4	7.95	33.9	94.52	114	19.48	Fund.
4880	42.10	AV	235	1.0	V	35.4	7.92	33.7	51.72	74	22.28	harmonic
2440	86.27	PK	322	1.0	H	31.0	7.95	33.9	91.32	114	22.68	Fund.
1237.94	34.90	AV	38	1.0	H	25.9	5.11	34.8	31.11	54	22.89	spurious
1237.94	34.32	AV	175	1.3	V	24.8	5.11	34.8	29.43	54	24.57	spurious
1237.94	47.35	PK	38	1.0	H	25.9	5.11	34.8	43.56	74	30.44	spurious
4880	51.88	PK	310	1.8	H	36.6	7.92	33.7	62.7	94	31.3	harmonic
1237.94	46.75	PK	175	1.3	V	24.8	5.11	34.8	41.86	74	32.14	spurious
4880	49.58	PK	235	1.0	V	35.4	7.92	33.7	59.2	94	34.8	harmonic

Frequency (MHz)	S.A. Reading (dB $\mu$ V/m)	Detector PK/AV	Direction Degree	Test Antenna			Cable Loss (dB)	Pre Amp. Gain (dB)	Cord. Amp. (dB $\mu$ V/m)	FCC 15.209/15.249		
				Height (m)	Polar (H/V)	Factor (dB)				Limit (dB $\mu$ V/m)	Margin (dB)	comment
High Channel												
2476	84.10	AV	347	1.2	V	30.5	7.97	33.9	88.67	94	5.33	Fund.
2476	80.07	AV	128	1.0	H	31.1	7.97	33.9	85.24	94	8.76	Fund.
2484.46	35.39	AV	188	1.0	H	32.5	7.97	33.9	41.96	54	12.04	spurious
2484.46	35.14	AV	360	1.1	V	31.0	7.97	33.9	40.21	54	13.79	spurious
4952	46.82	AV	282	1.6	H	36.6	7.95	33.7	57.67	74	16.33	harmonic
2484.46	48.10	PK	188	1.0	H	32.5	7.97	33.9	54.67	74	19.33	spurious
2476	89.35	PK	347	1.2	V	30.5	7.97	33.9	93.92	114	20.08	Fund.
2484.46	47.25	PK	360	1.1	V	31.0	7.97	33.9	52.32	74	21.68	spurious
2476	85.12	PK	128	1.0	H	31.1	7.97	33.9	90.29	114	23.71	Fund.
4952	34.72	AV	277	1.5	V	35.4	7.95	33.7	44.37	74	29.63	harmonic
4952	53.23	PK	282	1.6	H	36.6	7.95	33.7	64.08	94	29.92	harmonic
4952	46.95	PK	277	1.5	V	35.4	7.95	33.7	56.6	94	37.4	harmonic

Test mode: Receiving (Worse case)

**Below 1 GHz:**

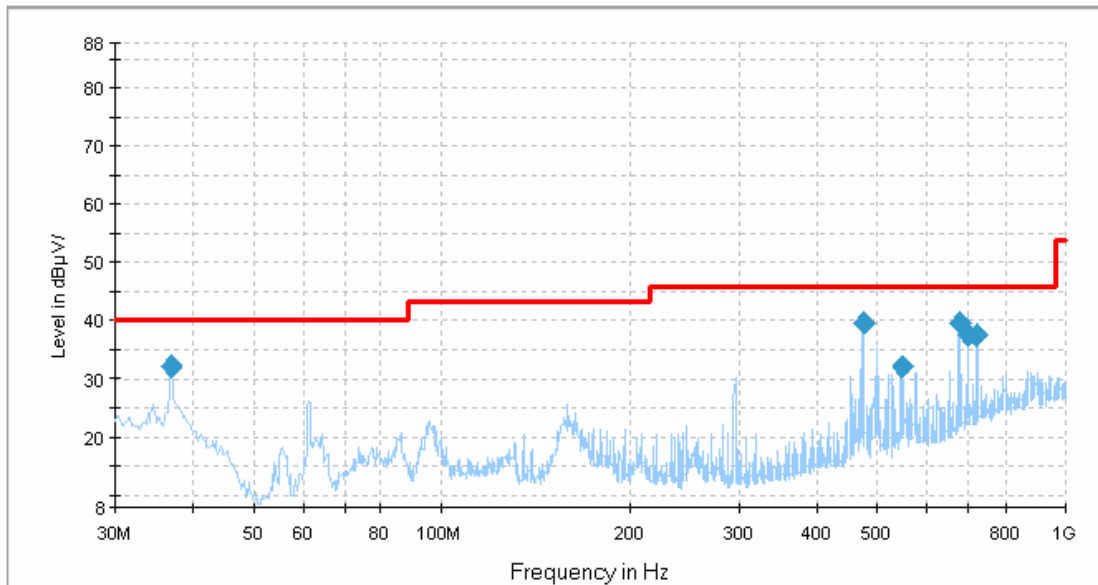

Frequency (MHz)	Corrected Amplitude (dBµV/m)	Antenna Height (cm)	Antenna Polarity (H/V)	Turntable Position (deg)	Limit (dBµV/m)	Margin (dB)
674.650000	39.8	100.0	H	46.0	46.0	6.2
474.746250	39.0	130.0	V	270.0	46.0	7.0
721.791500	37.6	100.0	V	88.0	46.0	8.4
550.841250	31.5	101.0	V	74.0	40.0	8.5
699.538750	37.5	163.0	H	47.0	46.0	8.5
37.102000	31.2	295.0	V	195.0	40.0	8.8

Note: Radiated emission above 1G of receiving mode has not detected, so there is no record about it.

---

**FCC §15.249(d) – OUT OF BAND EMISSIONS**

---

**Applicable Standard**

Emissions radiated outside of the specified frequency bands, except for harmonics, shall be attenuated by at least 50 dB below the level of the fundamental or to the general radiated emission limits in §15.209, whichever is the lesser attenuation.

**Test Procedure**

The EUT is set 3 meter away from the testing antenna, which is varied from 1-4 mete, and the EUT is placed on a turntable, which is 0.8 meter above ground plane, the table shall be rotated for 360 degrees to find out the highest emission at the band edge. The receiving antenna should be changed the polarization both of horizontal and vertical.

$$\text{Corrected Amplitude} = \text{Meter Reading} + \text{Antenna Factor} + \text{Cable Loss} - \text{Amplifier Gain}$$

**Measurement Uncertainty**

All measurements involve certain levels of uncertainties, especially in field of EMC. The factors contributing to uncertainties are spectrum analyzer, cable loss, antenna factor calibration, antenna directivity, antenna factor variation with height, antenna phase center variation, antenna factor frequency interpolation, measurement distance variation, site imperfections, mismatch (average), and system repeatability.

Based on NIS 81, The Treatment of Uncertainty in EMC Measurements, the best estimate of the uncertainty of a radiation emissions measurement at Bay Area Compliance Laboratories Corp. (Shenzhen) is  $\pm 4.0$  dB.

**Test Equipment Setup**

The spectrum analyzer or receiver is set as:

Above 1000 MHz:

Peak: RBW = 1MHz / VBW = 1MHz / Sweep = Auto

Average: RBW = 1MHz / VBW = 10Hz / Sweep = Auto

**Test Setup**

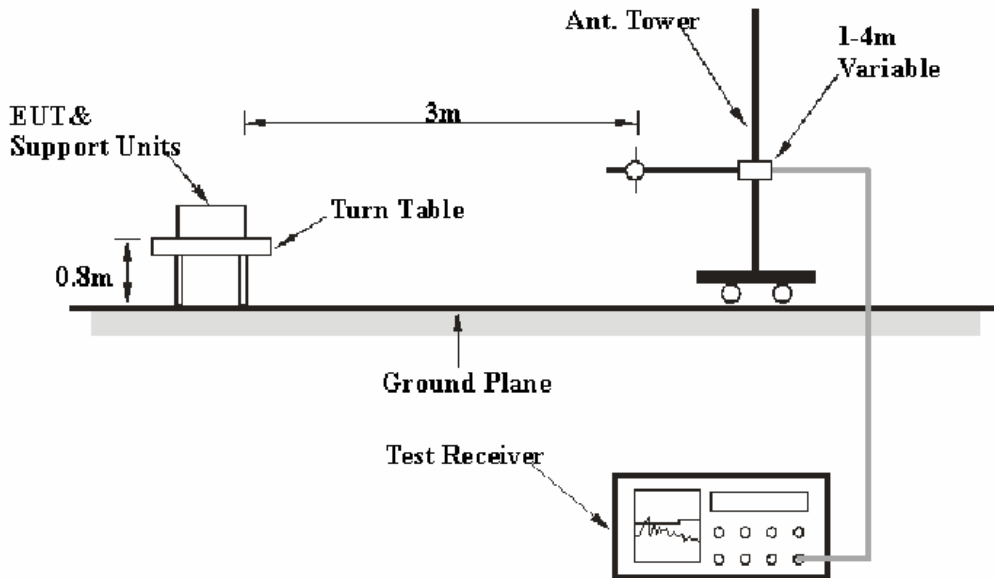

The radiated emission and out of band emission tests were performed in the 3 meters chamber B, using the setup accordance with the ANSI C63.4-2003. The specification used was the FCC 15.209 and FCC 15.249 limits.

**Test Equipment List and Details**

Manufacturer	Description	Model	Serial Number	Calibration Date	Calibration Due Date
Rohde & Schwarz	EMI Test Receiver	ESCI	100224	2009-11-24	2010-11-23
HP	Amplifier	8447E	1937A01046	2009-08-02	2010-08-02
Sunol Sciences	Horn Antenna	DRH-118	A052604	2009-05-05	2010-05-04

\* **Statement of Traceability:** Bay Area Compliance Laboratories Corp. (Shenzhen) Corp. attests that all calibrations have been performed in accordance to NVLAP requirements, traceable to the NIST.

**Test Data****Environmental Conditions**

<b>Temperature:</b>	25 °C
<b>Relative Humidity:</b>	56 %
<b>ATM Pressure:</b>	100.2 kPa

*\*The testing was performed by Weir Zhong on 2010-03-22.*

**Test Result:** Compliant

Please refer to the following table and plots.

*Test Mode: Transmitting*

Frequency (MHz)	S.A. Reading (dB $\mu$ V/m)	Detector PK/AV	Direction Degree	Test Antenna			Cable Loss (dB)	Pre. Amp. Gain (dB)	Cord. Amp. (dB $\mu$ V/m)	FCC 15.209/15.249	
				Height (m)	Polar (H/V)	Factor (dB)				Limit (dB $\mu$ V/m)	Margin (dB)
Frequency In Low Channel											
2399.69	35.95	AV	181	2.0	H	30.9	7.9	33.9	40.85	54	13.15
2399.69	35.32	AV	36	1.2	V	30.3	7.9	33.9	39.62	54	14.38
2399.69	47.12	PK	181	1.0	H	30.9	7.9	33.9	52.02	74	21.98
2399.69	46.13	PK	36	1.2	V	30.3	7.9	33.9	50.43	74	23.57
Frequency In High Channel											
2483.82	36.50	AV	332	1.8	H	31.1	8.0	33.9	41.70	54	12.30
2483.82	35.61	AV	360	1.0	V	30.4	8.0	33.9	40.11	54	13.89
2483.82	48.14	PK	332	1.8	H	31.1	8.0	33.9	53.34	74	20.66
2483.82	46.53	PK	360	1.0	V	30.4	8.0	33.9	51.03	74	22.97

**\*\*\*\*\* END OF REPORT \*\*\*\*\***