

Emissions Test Report

EUT Name: Wireless Audio Headset
Model No.: Ear Force Stealth 600X
CFR 47 Part 15.407 2017 and RSS 247: 2017

Prepared for:

Tim Blaney
Voyetra Turtle Beach, Inc.
100 Summit Lake Drive, Suite 100
Valhalla, New York 10595 USA
Tel: (530) 277-3482

Prepared by:

TUV Rheinland of North America, Inc.
1279 Quarry Lane
Pleasanton, CA 94566
Tel: (925) 249-9123
Fax: (925) 249-9124
<http://www.tuv.com/>

Report/Issue Date: June 19, 2017
Job # 0000148495
Report Number: 31761683.001

Revisions

Revision No.	Date MM/DD/YYYY	Reason for Change	Author
0	06/19/2017	Original Document	N/A

Note: Latest revision report will replace all previous reports.

Statement of Compliance

Manufacturer: Voyetra Turtle Beach, Inc.
100 Summit Lake Drive, Suite 100
Valhalla, New York 10595 USA
(530) 277-3482

Requester / Applicant: Tim Blaney

Name of Equipment: Wireless Audio Headset
Model No. Ear Force Stealth 600X (TB300-2015-01)
Type of Equipment: Intentional Radiator
Application of Regulations: CFR 47 Part 15.407 2017 and RSS 247: 2017
Test Dates: 7 May 2017 to 01 June 2017

Guidance Documents:

Emissions: ANSI C63.10-2013, KDB 789033 D02 General UNII Test Procedures New Rules v01r04

Test Methods:

Emissions: ANSI C63.10-2013, KDB 789033 D02 General UNII Test Procedures New Rules v01r04

The electromagnetic compatibility test and documented data described in this report has been performed and recorded by TUV Rheinland, in accordance with the standards and procedures listed herein. As the responsible authorized agent of the EMC laboratory, I hereby declare that the equipment described above has been shown to be compliant with the EMC requirements of the stated regulations and standards based on these results. If any special accessories and/or modifications were required for compliance, they are listed in the Executive Summary of this report.

This report must not be used to claim product endorsement by A2LA or any agency of the U.S. Government. This report contains data that are not covered by A2LA accreditation. This report shall not be reproduced except in full, without the written authorization of TUV Rheinland of North America.



Jeremy Luong

Test Engineer

Date June 19, 2017



David Spencer

A2LA Signatory

Date June 19, 2017



Testing Cert #3331.02



US1131



Industry
Canada

Industrie
Canada

2932M

Table of Contents

1	Executive Summary	7
1.1	Scope	7
1.2	Purpose	7
1.3	Summary of Test Results	8
1.4	Special Accessories	8
1.5	Equipment Modifications	8
2	Laboratory Information	9
2.1	Accreditations & Endorsements	9
2.1.1	US Federal Communications Commission	9
2.1.2	NIST / A2LA	9
2.1.3	Canada – Industry Canada	9
2.1.4	Japan – VCCI	9
2.1.5	Acceptance by Mutual Recognition Arrangement	9
2.2	Test Facilities	10
2.2.1	Emission Test Facility	10
2.2.2	Immunity Test Facility	10
2.3	Measurement Uncertainty	10
2.3.1	Sample Calculation – radiated & conducted emissions	11
2.3.2	Measurement Uncertainty	11
2.3.3	Measurement Uncertainty Immunity	12
2.4	Calibration Traceability	12
3	Product Information	13
3.1	Product Description	13
3.2	Equipment Configuration	13
3.3	Operating Mode	13
3.4	Unique Antenna Connector	14
3.4.1	Results	14
3.5	Duty Cycle	15
3.5.1	Results	15
4	Emissions	18
4.1	Output Power Requirements	18
4.1.1	Test Method	18
4.1.2	Results	19
4.2	Occupied Bandwidth	35
4.2.1	Test Method	35
4.2.2	Results	35
4.3	Power Spectral Density	50
4.3.1	Test Method	50
4.3.2	Results	50

Table of Contents

4.4	Undesirable Emission Limits	60
4.4.1	Test Method	60
4.4.2	Results	61
4.5	Transmitter Spurious Emissions	90
4.5.1	Test Methodology	90
4.5.2	Transmitter Spurious Emission Limit	91
4.5.3	Results	91
4.6	AC Conducted Emissions	149
4.6.1	Test Methodology	149
4.6.2	Test Results	149
4.7	Frequency Stability	154
4.7.1	Test Methodology	154
4.7.2	Manufacturer Declaration	154
4.7.3	Limit	155
4.7.4	Test results:	155
4.8	Voltage Variation	157
4.8.1	Test Methodology	157
4.8.2	Test results	157
4.9	Maximum Permissible Exposure	159
4.9.1	Test Methodology	159
4.9.2	FCC KDB 447498 D01 – General SAR Test Exclusion Guidance	159
4.9.3	EUT Operating Condition	159
4.9.4	Classification	159
4.9.5	Antenna Gain	160
4.9.6	SAR Test Exclusion Threshold	160
5	Test Equipment List	161
5.1	Equipment List	161
6	EMC Test Plan	162
6.1	Introduction	162
6.2	Customer	162
6.3	Equipment Under Test (EUT)	163
6.4	Test Specifications	166

Index of Tables

Table 1: Summary of Test Results	8
Table 2: RF Output Power at the Antenna Port – Test Results per FCC	19
Table 3: RF Output Power at the Antenna Port – Test Results per RSS-247	21
Table 4: Occupied Bandwidth – Test Results.....	36
Table 5: Power Spectral Density – Test Results for 802.11a	51
Table 6: Power Spectral Density – Test Results for 802.11n HT20.....	52
Table 7: Undesired Emissions for 802.11a – Test Results.....	61
Table 8: Undesired Emissions for 802.11n HT20 – Test Results.....	63
Table 9: Transmit Spurious Emission at Band-Edge Requirements.....	92
Table 10: Transmit Spurious Emission at Band-Edge Requirements Continued.....	93
Table 11: Transmit Spurious Emission at Band-Edge Requirements Continued.....	94
Table 12: AC Conducted Emissions – Test Results.....	149
Table 13: Frequency Stability – Test Results	155
Table 14: Voltage Variation – Test Results.....	157
Table 15: Customer Information	162
Table 16: Technical Contact Information.....	162
Table 17: EUT Specifications	163
Table 18: Antenna Information	164
Table 19: EUT Channel Power Specifications	164
Table 20: Interface Specifications	165
Table 21: Supported Equipment.....	165
Table 22: Description of Sample used for Testing.....	165
Table 23: Description of Test Configuration used for Radiated Measurement.....	165
Table 24: Test Specifications.....	166

1 Executive Summary

1.1 Scope

This report is intended to document the status of conformance with the requirements of the CFR 47 Part 15.407 2017 and RSS 247: 2017 based on the results of testing performed on 7 May 2017 to 01 June 2017 on the Wireless Audio Headset Model Ear Force Stealth 600X manufactured by Voyetra Turtle Beach, Inc. This report only applies to the specific samples tested under the stated test conditions. It is the responsibility of the manufacturer to assure that additional production units of this model are manufactured with identical or EMI equivalent electrical and mechanical components. This report is further intended to document changes and modifications to the EUT throughout its life cycle. All documentation will be included as a supplement.

1.2 Purpose

Testing was performed to evaluate the EMC performance of the EUT in accordance with the applicable requirements, procedures, and criteria defined in the application of regulations and application of standards listed in this report. The 5180 MHz – 5320 MHz, 5500 MHz – 5700 MHz, and 5745 MHz – 5825 MHz frequency bands are covered in this document.

1.3 Summary of Test Results

Table 1: Summary of Test Results

Test	Test Method ANSI C63.10:2013	Test Parameters	Measured Value	Result
Duty Cycle	Information Only	N/A	100%	N/A
Spurious Emission in Transmitted Mode	CFR47 15.209, CFR47 15.407 (b) RSS-GEN Sect.8.9, RSS 247 Sect. 6.2.1.2	Class B	-3.04 dB Margin	Complied
Restricted Bands of Operation	CFR47 15.205, RSS GEN Sect.8.10	Class B		Complied
AC Power Conducted Emission	CFR47 15.207, RSS-GEN Sect.8.8	Class B	-8.24 dB Margin	Complied
Occupied Bandwidth	CFR47 15.407 (a) & (e), RSS GEN Sect.6.6, RSS-247 Sect.6.2.4.1	DTS \geq 500 kHz	99% BW: 16.51 MHz 26dB BW: 24.08 MHz DTS BW: 16.44 MHz	Complied
Maximum Output Power	CFR47 15.407 (a) RSS 247 Sect. 6.2	UNII1: 250mW UNII2a: 250mW UNII2c: 250mW UNII3: 1W	UNII1: 8dBm/ 6.3mW UNII2a: 7.92dBm/ 6.19mW UNII2c: 7.99dBm/ 6.3mW UNII3: 7.66dBm/ 5.83mW	Complied
Peak Power Spectral Density	CFR47 15.407 (a) RSS 247 Sect. 6.2 (UNII2a, UNII2c & UNII3)	< 11 dBm/MHz < 30 dBm/ 500 kHz	UNII1: -2.69 dBm/ MHz UNII2a: -2.61 dBm/ MHz UNII2c: -2.50 dBm/ MHz UNII3: -2.49 dBm/ 500kHz	Complied
	RSS 247 Sect.6.2.1.1	< 10 dBm/MHz (e.i.r.p)	UNII1: -2.69 dBm/ MHz	Complied
Conducted Emission – Antenna Port	CFR47 15.407 (b)(1) (2)(3) RSS 247 Sect.6.2.1 to 6.2.3	< -27 dBm/MHz	-7.6 dB Margin	Complied
	CFR47 15.407 (b)(4) RSS 247 Sect.6.2.4	Spectrum Mask	-1.39 dB Margin	Complied
Frequency Stability	CFR47 15.407 (g), RSS GEN Sect. 6.11	\pm 20 ppm	7.89 ppm	Complied
Voltage Variation	CFR47 15.31(e)	\pm 20 ppm	3.40 ppm	Complied
RF Exposure	CFR47 15.407 (f), 2.1093 RSS-102 Issue 5	SAR	Exempted.	Complied

1.4 Special Accessories

No special accessories were necessary in order to achieve compliance.

1.5 Equipment Modifications

None

2 Laboratory Information

2.1 Accreditations & Endorsements

2.1.1 US Federal Communications Commission



TUV Rheinland of North America at 1279 Quarry Ln, Pleasanton, CA 94566 is recognized by the commission for performing testing services for the general public on a fee basis. These laboratory test facilities have been fully described in reports submitted to and accepted by the FCC (US1131). The laboratory scope of accreditation includes: Title 47 CFR Parts 15, 18, and 90. The accreditation is updated every 3 years.

2.1.2 NIST / A2LA



TUV Rheinland of North America is accredited by the National Voluntary Laboratory Accreditation Program, which is administered under the auspices of the National Institute of Standards and Technology. The laboratory has been assessed and accredited in accordance with ISO Guide 17025:1999 and ISO 9002 (Lab Code Testing Cert #3331.02). The scope of laboratory accreditation includes emission and immunity testing. The accreditation is updated annually.

2.1.3 Canada – Industry Canada



TUV Rheinland of North America at the 1279 Quarry Ln, Pleasanton, CA 94566 address is accredited by Industry Canada for performing testing services for the general public on a fee basis. This laboratory test facilities have been fully described in reports submitted to and accepted by Industry Canada (File Number 2932M). This reference number is the indication to the Industry Canada Certification Officers that the site meets the requirements of RSS 212, Issue 1 (Provisional). The accreditation is updated every 3 years.

2.1.4 Japan – VCCI



The Voluntary Control Council for Interference by Information Technology Equipment (VCCI) is a group that consists of Information Technology Equipment (ITE) manufacturers and EMC test laboratories. The purpose of the Council is to take voluntary control measures against electromagnetic interference from Information Technology Equipment, and thereby contribute to the development of a socially beneficial and responsible state of affairs in the realm of Information Technology Equipment in Japan. TUV Rheinland of North America at 1279 Quarry Ln, Pleasanton, CA 94566 has been assessed and approved in accordance with the Regulations for Voluntary Control Measures.

VCCI Registration No. for Pleasanton: A-0261

2.1.5 Acceptance by Mutual Recognition Arrangement



The United States has an established agreement with specific countries under the Asia Pacific Laboratory Accreditation Corporation (APLAC) Mutual Recognition Arrangement. Under this agreement, all TUV Rheinland at 1279 Quarry Ln, Pleasanton, CA 94566 test results and test reports within the scope of the laboratory NIST / A2LA accreditation will be accepted by each member country.

2.2 Test Facilities

All of the test facilities are located at 1279 Quarry Lane, Pleasanton, California 94566, USA.

2.2.1 Emission Test Facility

The Semi-Anechoic chamber and AC Line Conducted measurement facility used to collect the radiated and conducted data has been constructed in accordance with ANSI C63.7:1992. The site has been measured in accordance with and verified to comply with the theoretical normalized site attenuation requirements of ANSI C63.4-2014, at a test distance of 3 and 5 meters. The site is listed with the FCC and accredited by A2LA (Lab Code Testing Cert #3331.02). A report detailing this site can be obtained from TUV Rheinland of North America.

2.2.2 Immunity Test Facility

ESD, EFT, Surge, PQF: These tests are performed in an environmentally controlled room with a 3.7 m x 4.8 m x 3.175 mm thick aluminum floor connected to PE ground.

For ESD testing, tabletop equipment is placed on an insulated mat with a surface resistivity of 10^9 Ohms/square on a 1.6 m x 0.8 m x 0.8 m high non-conductive table with a 3.175 mm aluminum top (Horizontal Coupling Plane). The HCP is connected to the main ground plane via a low impedance ground strap through two 470-k Ω resistors. The Vertical Coupling Plane consists of an aluminum plate 50 cm x 50 cm x 3.175 mm thick. The VCP is connected to the main ground plane via a low impedance ground strap through two 470-k Ω resistors.

For EFT, Surge, PQF, the HCP and VCP are removed.

RF Field Immunity testing is performed in a 7.3m x 4.3m x 4.1m anechoic chamber.

RF Conducted and Magnetic Field Immunity testing is performed on a 4.8m x 3.7m x 3.175mm thick aluminum ground plane.

All test areas allow a minimum distance of 1 meter from the EUT to walls or conducting objects.

2.3 Measurement Uncertainty

Two types of measurement uncertainty are expressed in this report, per *ISO Guide To The Expression Of Uncertainty In Measurement*, 1st Edition, 1995.

The Combined Standard Uncertainty is the standard uncertainty of the result of a measurement when that result is obtained from the values of a number of other quantities; it is equal to the positive square root of the sum of the variances or co-variances of these other quantities, weighted according to how the measurement result varies with changes in these quantities. The term *standard uncertainty* is the result of a measurement expressed as a standard deviation.

2.3.1 Sample Calculation – radiated & conducted emissions

The field strength is calculated by subtracting the Amplifier Gain and adding the Cable Loss and Antenna Correction Factor to the measured reading. The basic equation is as follows:

$$\text{Field Strength (dB}\mu\text{V/m)} = \text{RAW} - \text{AMP} + \text{CBL} + \text{ACF}$$

Where: RAW = Measured level before correction (dB μ V)

AMP = Amplifier Gain (dB)

CBL = Cable Loss (dB)

ACF = Antenna Correction Factor (dB/m)

$$\mu\text{V/m} = 10^{\frac{\text{dB}\mu\text{V/m}}{20}}$$

Sample radiated emissions calculation @ 30 MHz

Measurement +Antenna Factor–Amplifier Gain+ Cable loss=Radiated Emissions (dBuV/m)

$$25 \text{ dBuV/m} + 17.5 \text{ dB} - 20 \text{ dB} + 1.0 \text{ dB} = 23.5 \text{ dBuV/m}$$

2.3.2 Measurement Uncertainty

Per CISPR 16-4-2	U _{lab}	U _{cispr}
Radiated Disturbance @ 10 meters		
30 – 1,000 MHz	2.25 dB	4.51 dB
Radiated Disturbance @ 3 meters		
30 – 1,000 MHz	2.26 dB	4.52 dB
1 – 6 GHz	2.12 dB	4.25 dB
6 – 18 GHz	2.47 dB	4.93 dB
Conducted Disturbance @ Mains Terminals		
150 kHz – 30 MHz	1.09 dB	2.18 dB
Disturbance Power		
30 MHz – 300 MHz	3.92 dB	4.3 dB

Voltech PM6000A

The estimated combined standard uncertainty for harmonic current and flicker measurements is $\pm 5.0\%$.	Per CISPR 16-4-2 Methods
--	--------------------------

2.3.3 Measurement Uncertainty Immunity

The estimated combined standard uncertainty for ESD immunity measurements is $\pm 8.2\%$.	Per IEC 61000-4-2
The estimated combined standard uncertainty for radiated immunity measurements is ± 4.10 dB.	Per IEC 61000-4-3
The estimated combined standard uncertainty for conducted immunity measurements with CDN is ± 3.66 dB	Per IEC 61000-4-6
The estimated combined standard uncertainty for power frequency magnetic field immunity is $\pm 2.9\%$.	Per IEC 61000-4-8

Thermo KeyTek EMC Pro

The estimated combined standard uncertainty for EFT fast transient immunity measurements is $\pm 2.6\%$.
The estimated combined standard uncertainty for surge immunity measurements is $\pm 2.6\%$.
The estimated combined standard uncertainty for voltage variation and interruption measurements is $\pm 1.74\%$.

The expanded uncertainty at a level of 95% confidence is obtained by multiplying the combined standard uncertainty by a coverage factor of 2. Compliance criteria are not based on measurement uncertainty.

2.4 Calibration Traceability

All measurement instrumentation is traceable to the National Institute of Standards and Technology (NIST). Measurement method complies with ANSI/NCSL Z540-1-1994 and ISO Standard 17025:2005. Equipment calibration records are kept on file at the test facility.

3 Product Information

3.1 Product Description

The Stealth 600X is a completely wireless Xbox One audio gaming headset. It wirelessly connects directly to the Xbox One console over either a 2.4 GHz or 5.0 GHz Wi-Fi link. The functionality in the headset consists of 50mm speaker drivers, a flip up non-removable microphone, microphone monitoring (adjustable via EFAH) and game/chat mix controls on the headset. Additionally, it has a ProSpecs alternative glasses relief ear pad design. With the Microsoft integrated radio module, this headset is also capable of working with compatible Windows PCs in the future.

3.2 Equipment Configuration

A description of the equipment configuration is given in the Test Plan Section. The EUT was tested as called for in the test standard and was configured and operated in a manner consistent with its intended use. The EUT was connected to rated power and allowed to reach intended operating conditions. The placement of the EUT system components was guided by the test standard and selected to represent typical installation conditions.

In the case of an EUT that can operate in more than one configuration, preliminary testing was performed to determine the configuration that produced maximum radiation.

The final configuration was selected to produce the worst case radiation for emissions testing and to place the EUT in the most susceptible state for immunity testing.

3.3 Operating Mode

A description of the operation mode is given in the Test Plan Section. In the case of an EUT that can operate in more than one state, preliminary testing was performed to determine the operating mode that produced maximum radiation.

The final operating mode was selected to produce the worst case radiation for emissions testing and to place the EUT in the most susceptible state for immunity testing.

3.4 Unique Antenna Connector

An intentional radiator shall be designed to ensure that no antenna other than that furnished by the responsible party shall be used with the device. The use of a permanently attached antenna or of an antenna that uses a unique coupling to the intentional radiator shall be considered sufficient to comply with the provisions of this Section. The manufacturer may design the unit so that a broken antenna can be replaced by the user, but the use of a standard antenna jack or electrical connector is prohibited. This requirement does not apply to carrier current devices or to devices operated under the provisions of CFR47 Parts 15.211, 15.213, 15.217, 15.219, or 15.221.

3.4.1 Results

The Wireless Audio Headset uses a dual band Fractus chip antenna for operation in the 2.4 GHz and 5150 MHz to 5850 MHz bands. The chip antenna is integrated on the PCB. It has a peak gain of 1.8 dBi in the 2.4 GHz band and 4.9 dBi in the 5150 MHz to 5850 MHz band.

There is an additional antenna specification available in the submittal package.

7.0 mm x 3.0 mm x 2.0 mm (image larger than real size)



TOP

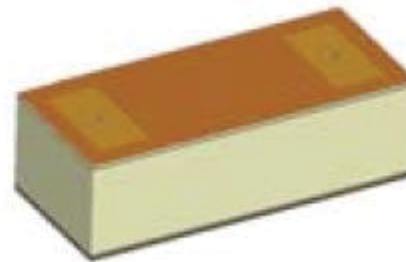

BOTTOM

3.5 Duty Cycle

The Ear Force Stealth 600X, SN: PP1 was measured for the duty cycle

3.5.1 Results

Mode	On Time (ms)	Period (ms)	Duty Cycle (%)	Duty Factor (dB)
802.11a	100	0	100	0
802.11n HT20	100	0	100	0

Notes: EUT configured and measured for the duty cycle. All measurements use 100% duty cycle.

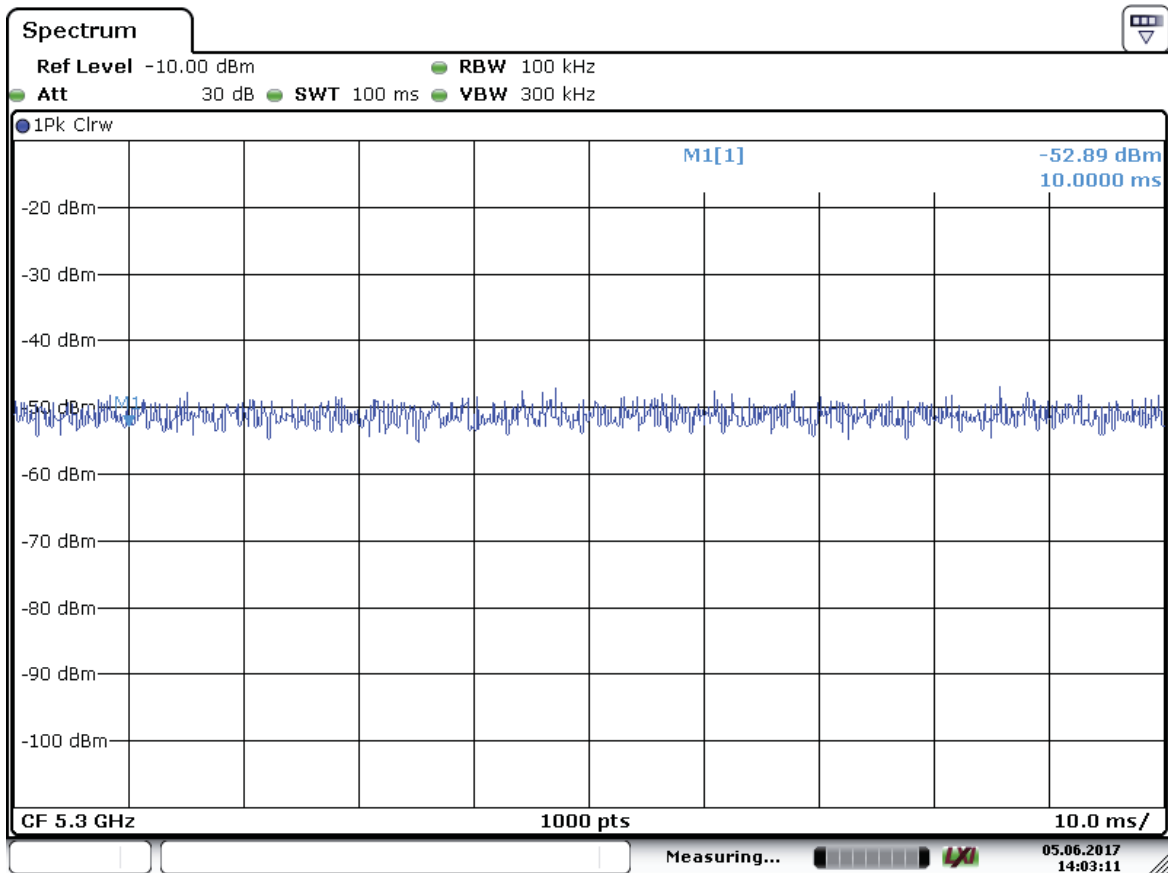

Date: 5 JUN 2017 14:03:11

Figure 1: Duty Cycle for 802.11a

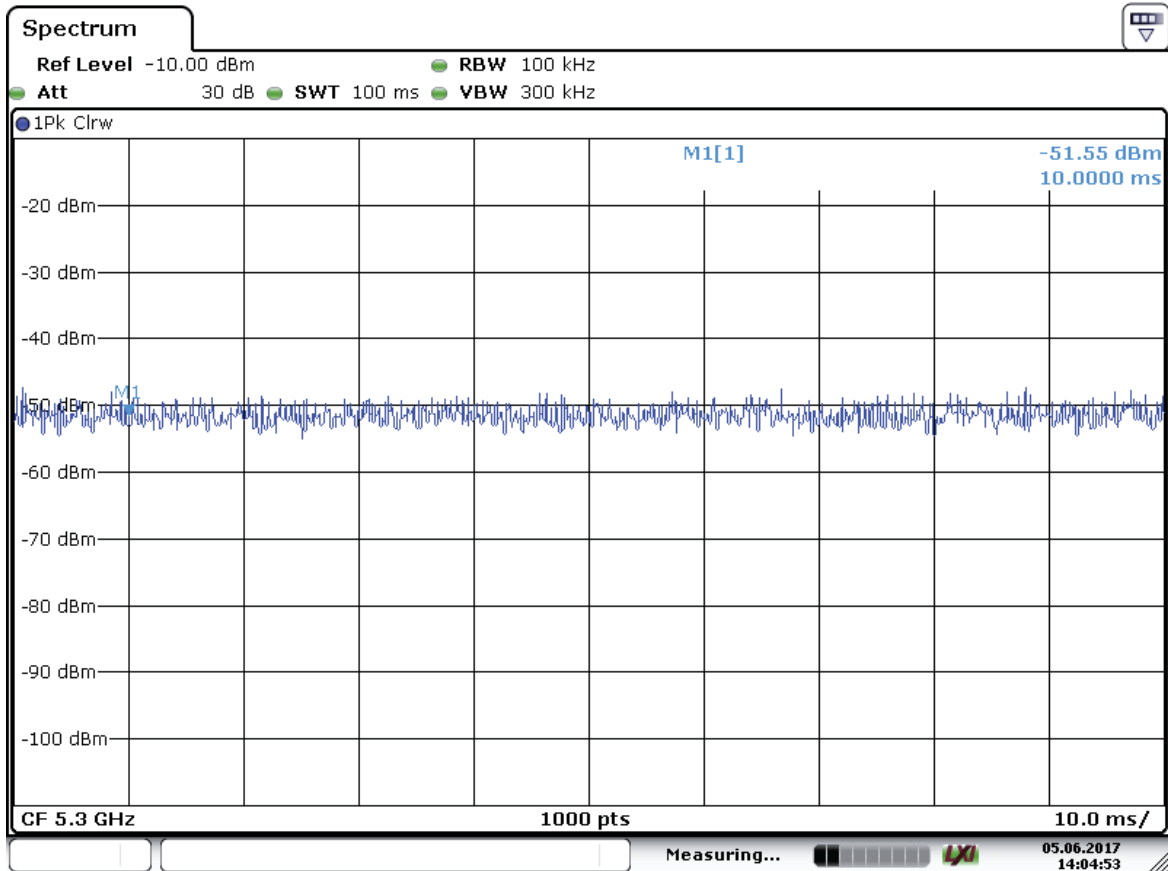

Date: 5 JUN 2017 14:04:54

Figure 2: Duty Cycle for 802.11n HT20

4 Emissions

Testing was performed in accordance with CFR 47 Part 15.407: 2017 and RSS 247: 2017. These test methods are listed under the laboratory's A2LA Scope of Accreditation. This test measures the levels emanating from the EUT, thus evaluating the potential for the EUT to cause radio frequency interference to other electronic devices. Procedures described in section 8 of the standard were used.

4.1 Output Power Requirements

The maximum output power requirement is the maximum equivalent isotropic radiated power delivering at the transmitting antenna under specified conditions of measurements in the presence of modulation.

The maximum transmitted power limits per CFR47 Part 15.407 and RSS-247 are

Part 15.407(a)(1)(iv) – Band 5150-5250 MHz: 250 mW.

Part 15.407(a)(2) – Band 5250-5350 MHz, 5470-5725 MHz: 250 mW or 11 dBm + 10Log B.

Part 15.407(a)(3) – Band 5725-5825 MHz: 1 W

RSS 247 Sect. 6.2.1.1 – Band 5150-5250 MHz (e.i.r.p.): 200 mW or 10 + 10Log(B)

RSS 247 Sect. 6.2.2.1 – Band 5250-5350 MHz, 5470-5725 MHz: 250 mW or 11 dBm + 10Log B

RSS 247 Sect. 6.2.2.1, 6.2.3.1 – Band 5250-5350 MHz, 5470-5725 MHz: 250 mW or 11 dBm + 10Log B.

RSS 247 Sect. 6.242.1 – Band 5725-5850 MHz: 1 W

Note: B is the 99% emission bandwidth.

4.1.1 Test Method

The ANSIC63.10-2013 Section 12.3.2.2 conducted method was used to measure the channel power output. The preliminary investigation was performed at different data rate/ chain to determine the highest power output for each mode. The worst findings were conducted on 3 channels in each operating range per CFR47 Part 15.407(a) and RSS 247 Sect. 6.2.1.1. The worst mode results indicated below.

Test Setup:

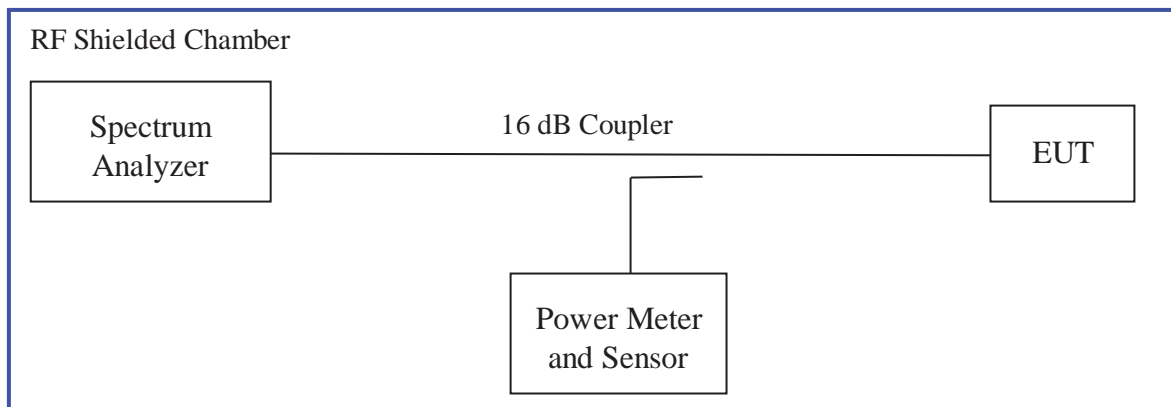

Method SA-1 of “KDB 789033 D02 – Guidelines for Compliance Testing of Unlicensed National Information Infrastructure (U-NII) Devices” applies since the EUT continuously transmit; where duty cycle is greater than 98%. Sample detector was used.

4.1.2 Results

As originally tested, the EUT was found to be compliant to the requirements of the test standard(s).

Table 2: RF Output Power at the Antenna Port – Test Results per FCC

Test Conditions: Conducted Measurement			Date: May 2, 2017		
Antenna Type: Chip			Power Setting: See test plan.		
Antenna Gain: 4.9 dBi			Signal State: Modulated at 100%		
Ambient Temp.: 23 °C			Relative Humidity: 33%		
802.11a at 6 Mbps (FCC Limit)					
Frequency (MHz)	Limit [dBm]	Output [dBm]	Duty Cycle [dB]	∑ Power [dBm]	Margin [dB]
5180	23.98	7.94			-16.04
5200	23.98	8.00			-15.98
5240	23.98	7.77			-16.21
5260	23.98	7.74			-16.24
5300	23.98	7.92			-16.06
5320	23.98	7.56			-16.42
5500	23.98	7.39			-16.59
5580	23.98	7.62			-16.36
5700	23.98	7.90			-16.08
5745	30.00	7.34			-22.66
5785	30.00	7.40			-22.60
5825	30.00	7.52			-22.48
Note: The headset is a client device. Worst case was observed at 6 Mbps.					

802.11n HT20 at 6.5 Mbps (FCC Limit)					
Frequency (MHz)	Limit [dBm]	Output [dBm]	Duty Cycle [dB]	Σ Power [dBm]	Margin [dB]
5180	23.98	7.77			-16.21
5200	23.98	7.71			-16.27
5240	23.98	7.91			-16.07
5260	23.98	7.65			-16.33
5300	23.98	7.84			-16.14
5320	23.98	7.46			-16.52
5500	23.98	7.85			-16.13
5580	23.98	7.99			-15.99
5700	23.98	7.90			-16.08
5745	30.00	7.66			-22.34
5785	30.00	7.52			-22.48
5825	30.00	7.29			-22.71
Note: The headset is a client device. Worst case was observed at 6.5 Mbps.					

Table 3: RF Output Power at the Antenna Port – Test Results per RSS-247

Test Conditions: Conducted Measurement		Date: May 2, 2017			
Antenna Type: Chip		Power Setting: See test plan.			
Antenna Gain: 4.9 dBi		Signal State: Modulated at 100%			
Ambient Temp.: 23 °C		Relative Humidity: 33%			
802.11a at 6 Mbps (RSS-247 Limit)					
Frequency (MHz)	Limit [dBm]	Output [dBm]	Duty Cycle [dB]	∑ Power [dBm]	Margin [dB]
5180	18.10	7.94			-10.16
5200	18.10	8.00			-10.10
5240	18.10	7.77			-10.33
5260	23.98	7.74			-16.24
5300	23.98	7.92			-16.06
5320	23.98	7.56			-16.42
5500	23.98	7.39			-16.59
5580	23.98	7.62			-16.36
5700	23.98	7.90			-16.08
5745	30.00	7.34			-22.66
5785	30.00	7.40			-22.60
5825	30.00	7.52			-22.48
Note: The headset is a client device. Worst case was observed at 6 Mbps. For 5150 – 5250 MHz, RSS-247 Limit = 23 dBm – 4.9 dBi = 18.10 dBm					
802.11n HT20 at 6.5 Mbps (RSS-247 Limit)					
Frequency (MHz)	Limit [dBm]	Output [dBm]	Duty Cycle [dB]	∑ Power [dBm]	Margin [dB]
5180	18.10	7.77			-10.33
5200	18.10	7.71			-10.39
5240	18.10	7.91			-10.19
5260	23.98	7.65			-16.33
5300	23.98	7.84			-16.14
5320	23.98	7.46			-16.52

5500	23.98	7.85			-16.13
5580	23.98	7.99			-15.99
5700	23.98	7.90			-16.08
5745	30.00	7.66			-22.34
5785	30.00	7.52			-22.48
5825	30.00	7.29			-22.71
<p> Note: The headset is a client device. Worst case was observed at 6.5 Mbps. For 5150 – 5250 MHz, RSS-247 Limit = 23 dBm – 4.9 dBi = 18.10 dBm </p>					

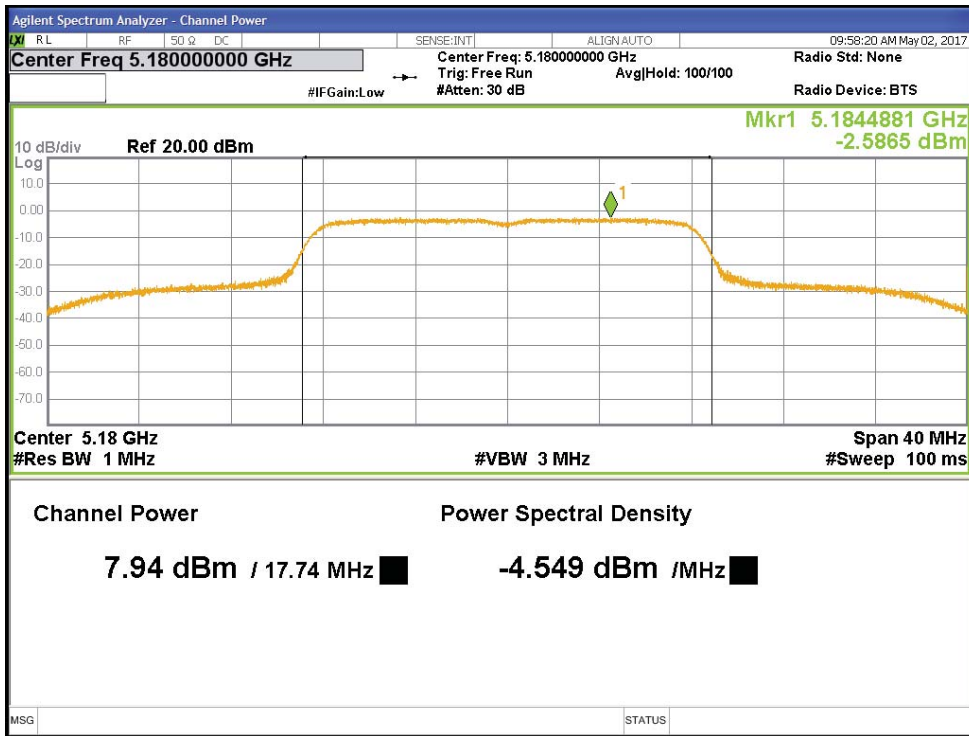

Figure 3: Conducted Output Power-5180 MHz-11a-6 Mbps

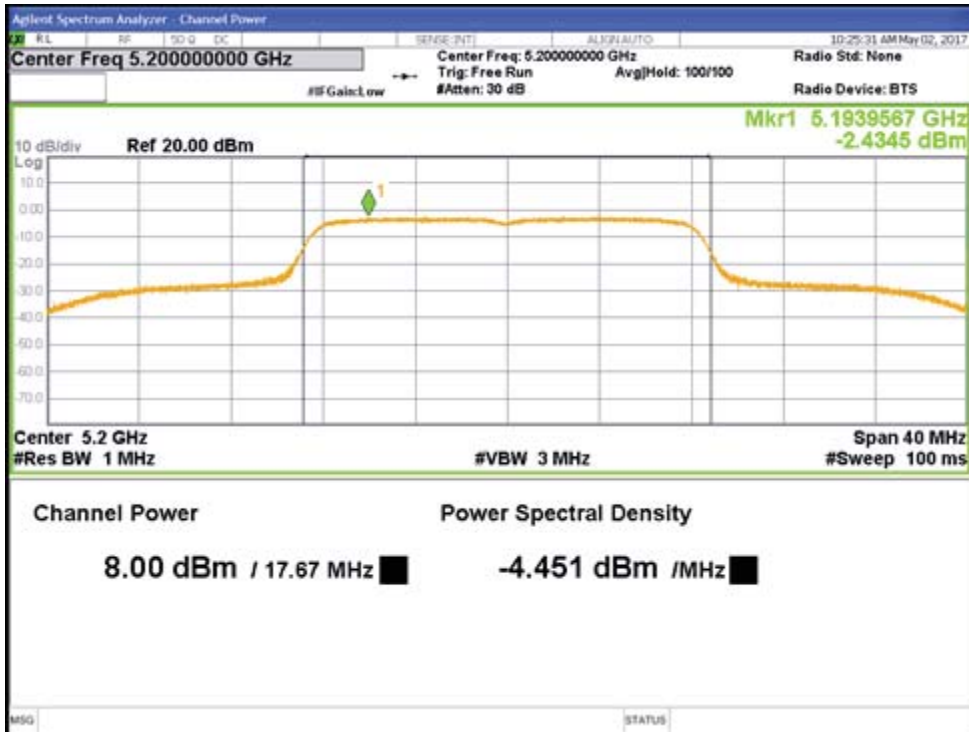

Figure 4: Conducted Output Power -5200 MHz-11a-6 Mbps

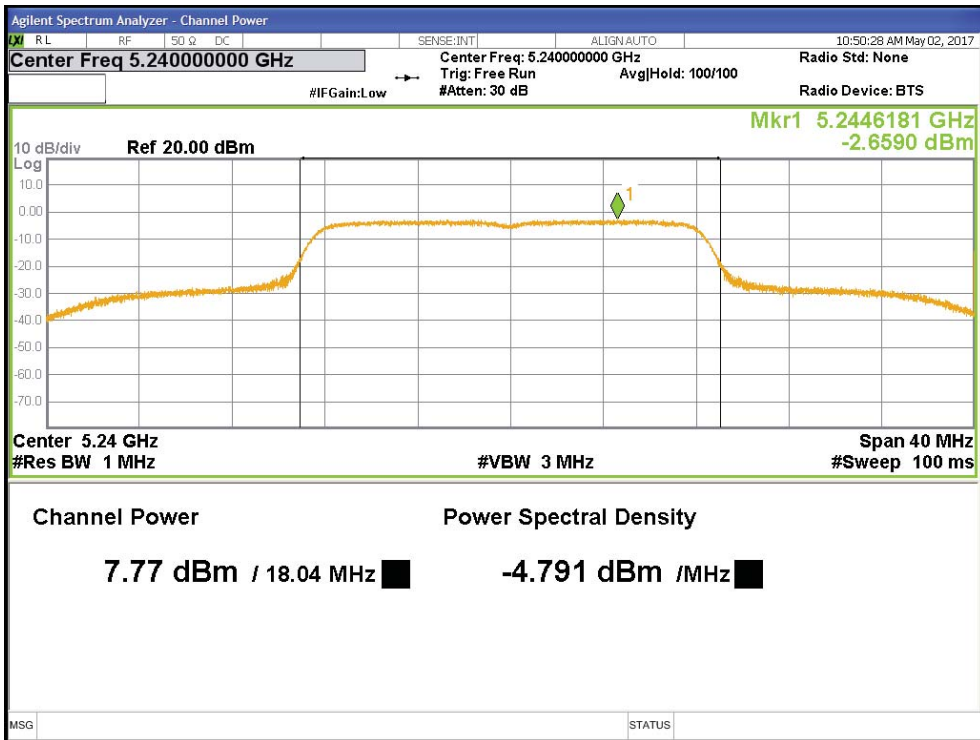

Figure 5: Conducted Output Power-5240 MHz-11a-6 Mbps

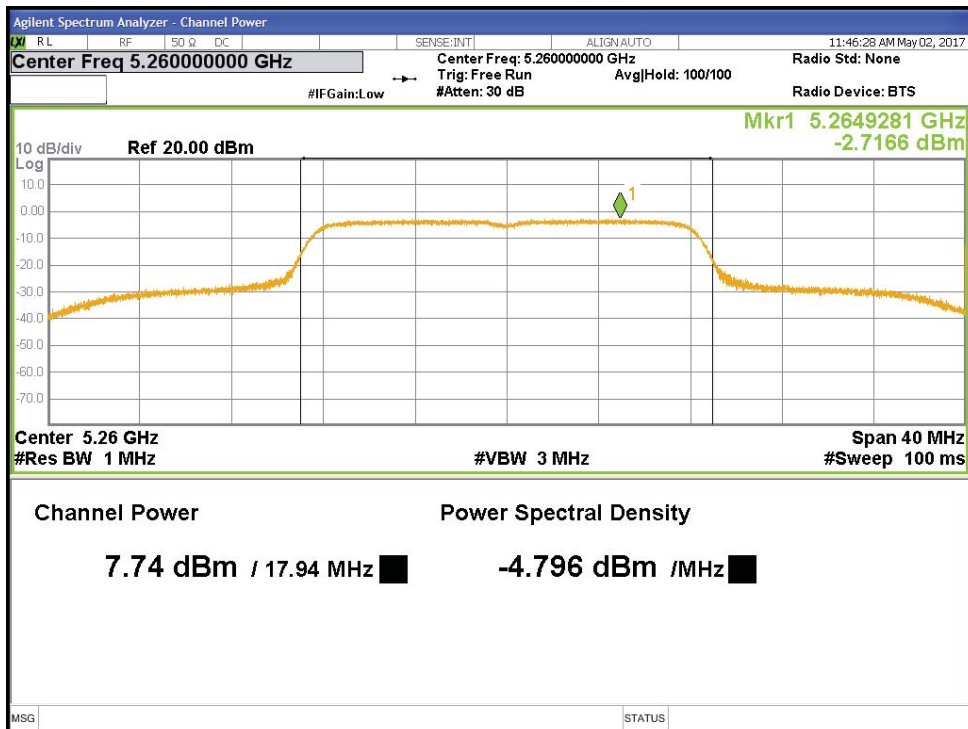

Figure 6: Conducted Output Power-5260 MHz-11a-6 Mbps

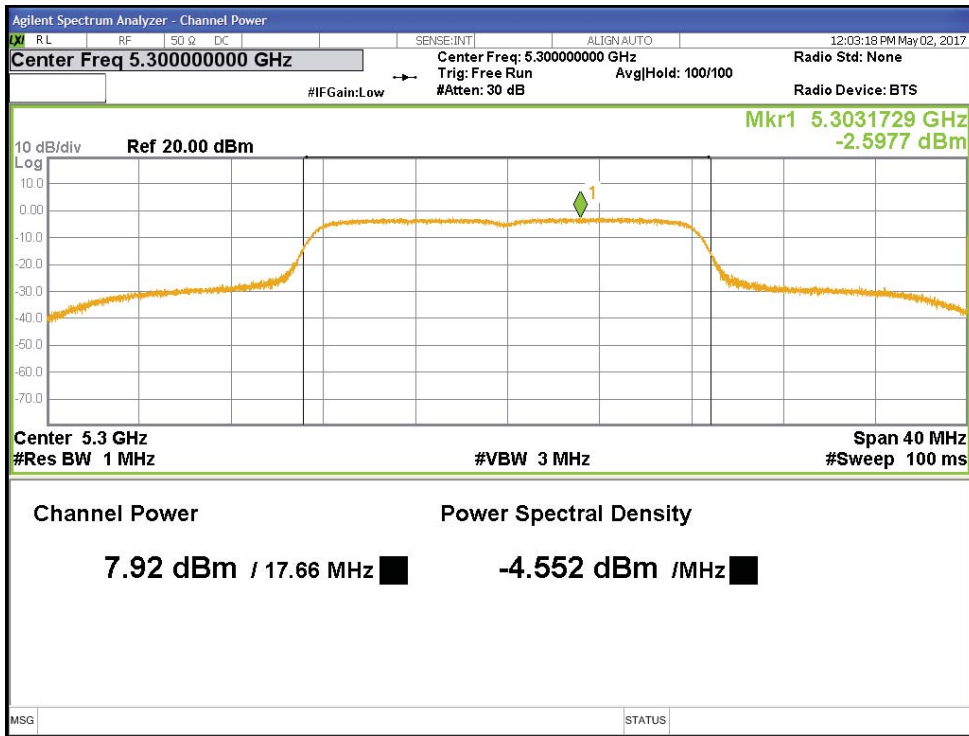

Figure 7: Conducted Output Power-5300 MHz-11a-6 Mbps

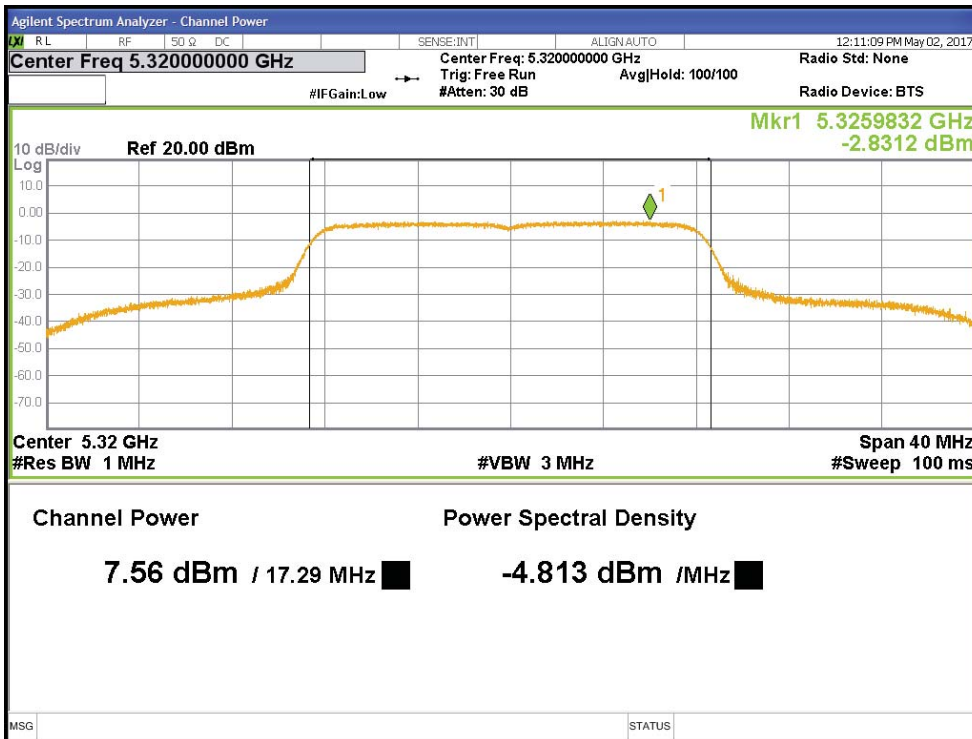

Figure 8: Conducted Output Power-5320 MHz-11a-6 Mbps

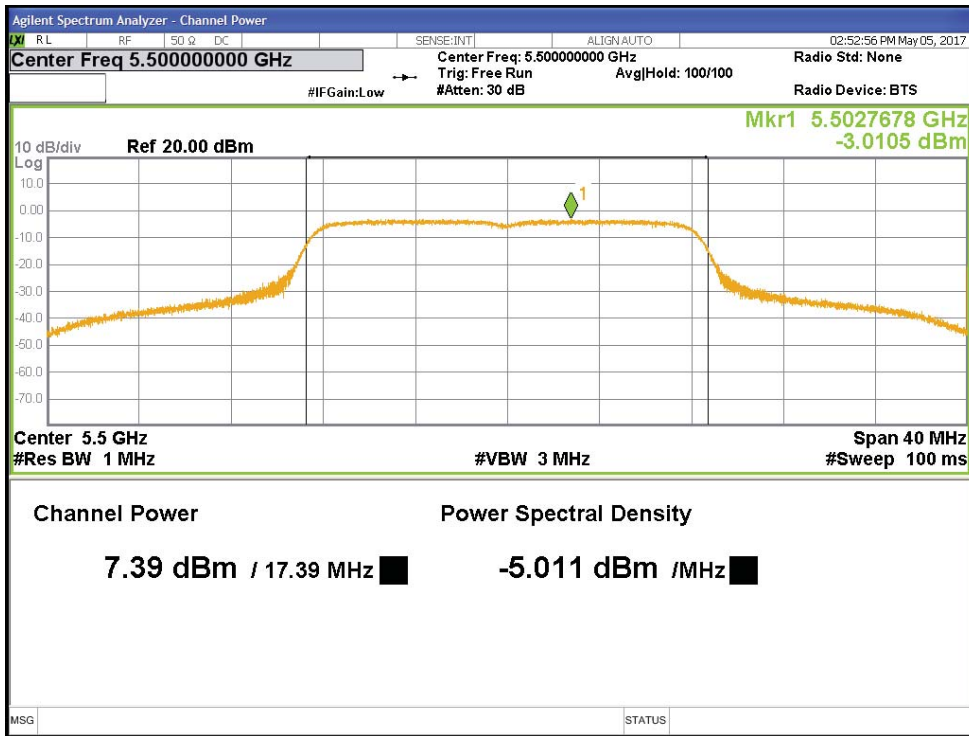

Figure 9: Conducted Output Power-5500 MHz-11a-6 Mbps

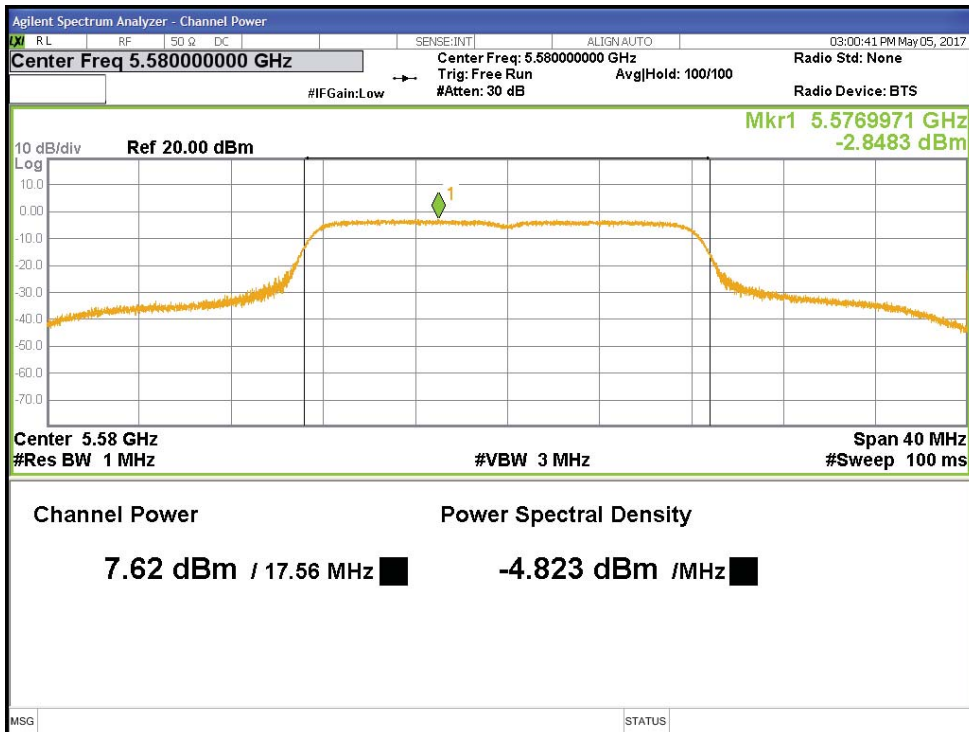

Figure 10: Conducted Output Power-5580 MHz-11a-6 Mbps

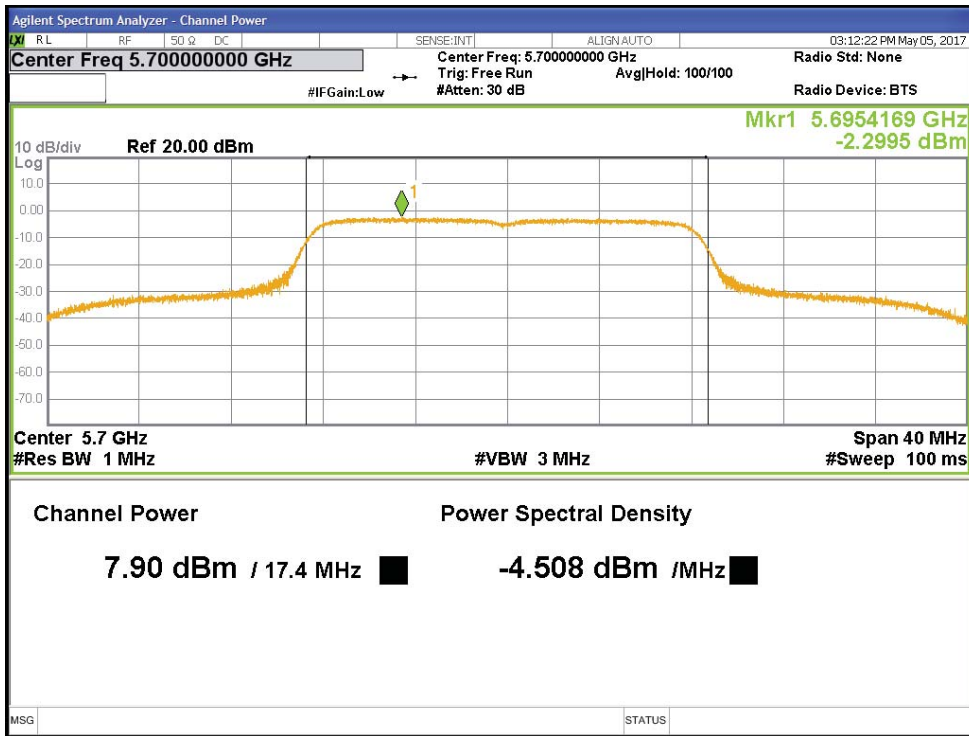

Figure 11: Conducted Output Power-5700 MHz-11a-6 Mbps

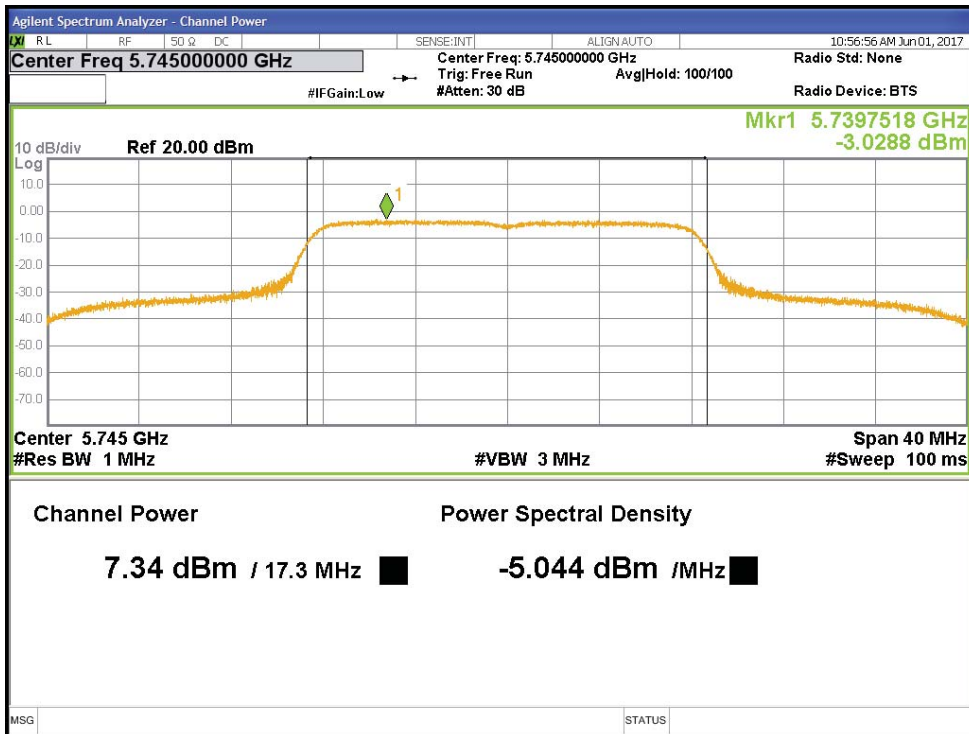

Figure 12: Conducted Output Power-5745 MHz-11a-6 Mbps

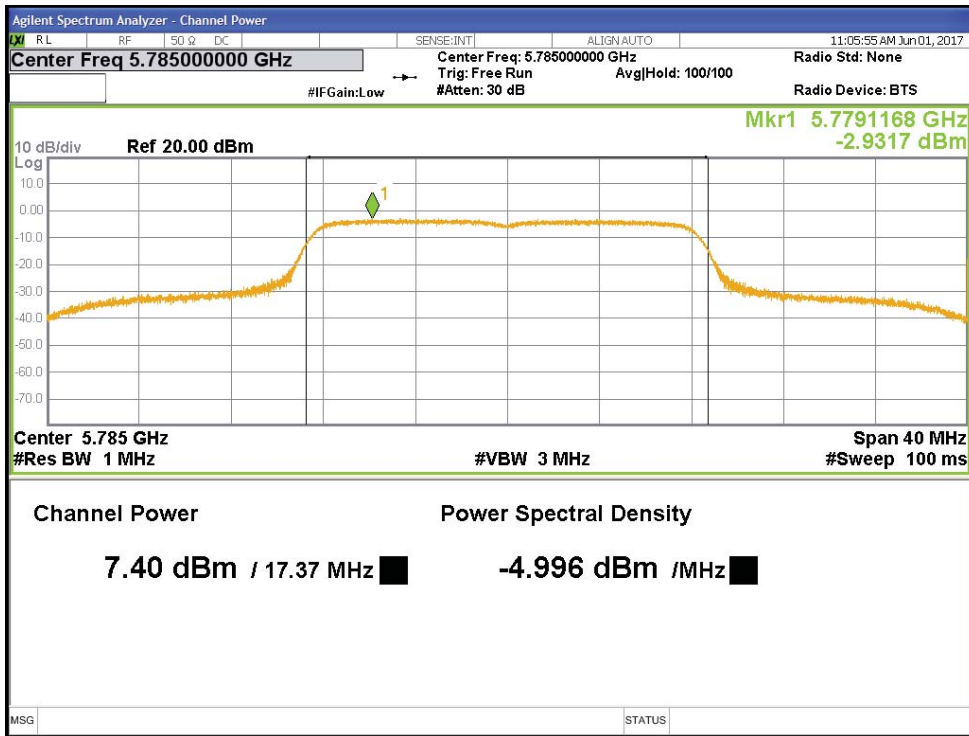

Figure 13: Conducted Output Power-5785 MHz-11a-6 Mbps

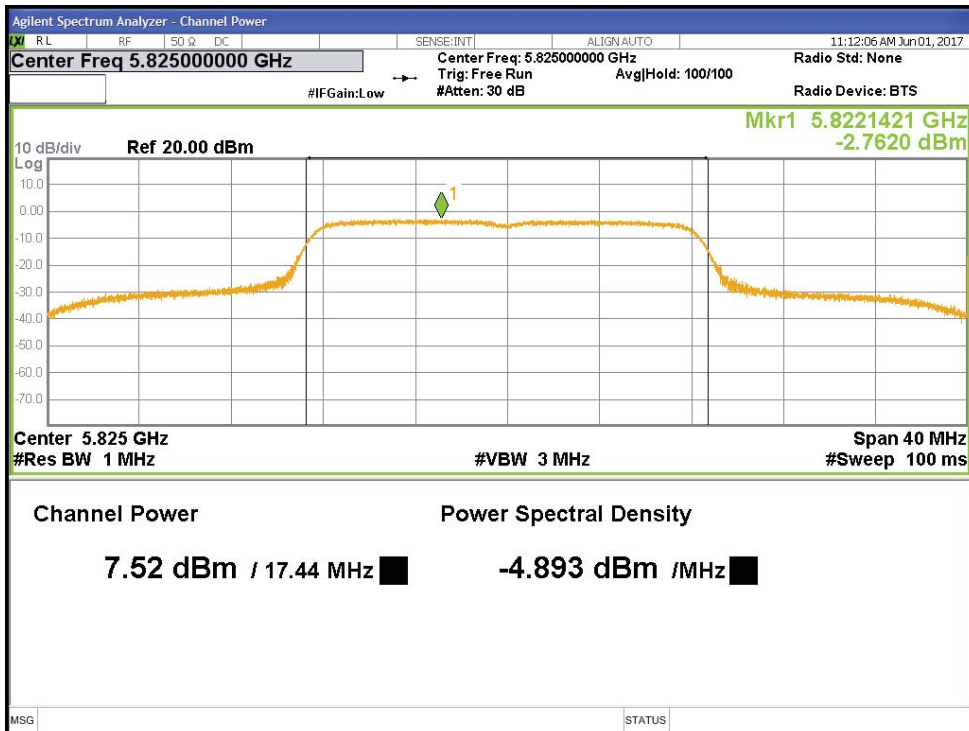

Figure 14: Conducted Output Power-5825 MHz-11a-6 Mbps

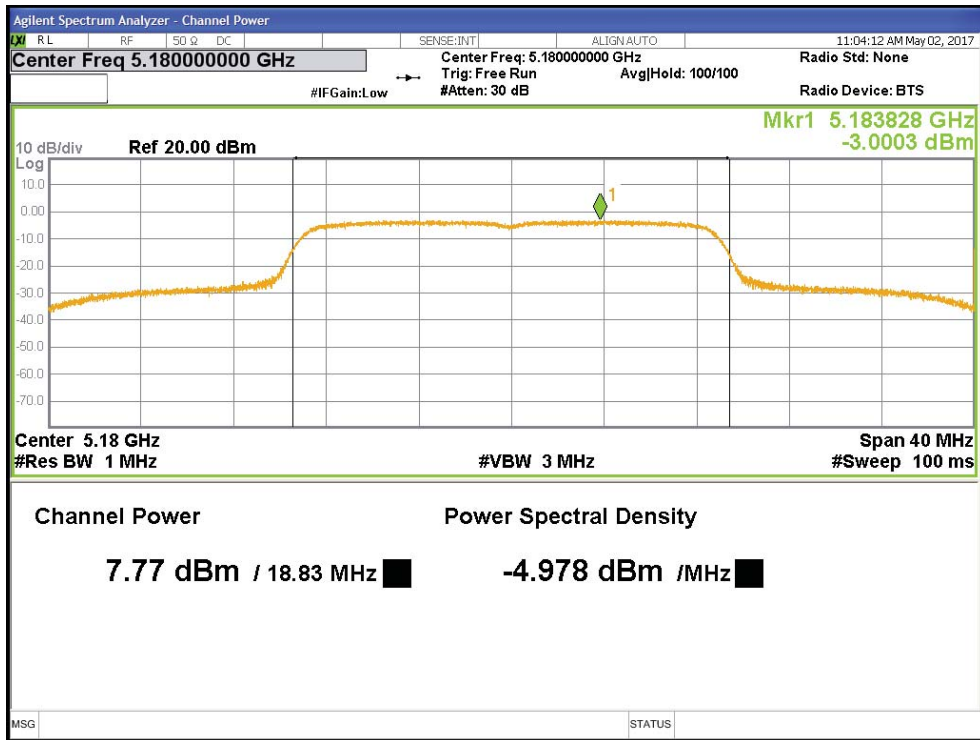

Figure 15: Conducted Output Power-5180 MHz-HT20-6.5 Mbps

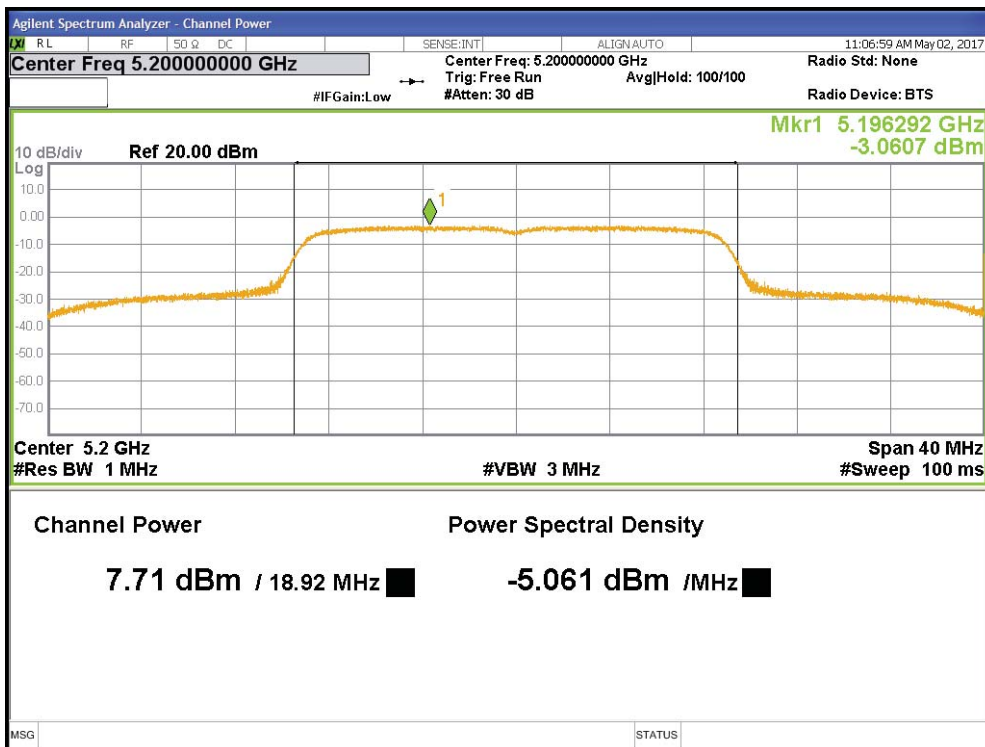

Figure 16: Conducted Output Power -5200 MHz-HT20-6.5 Mbps

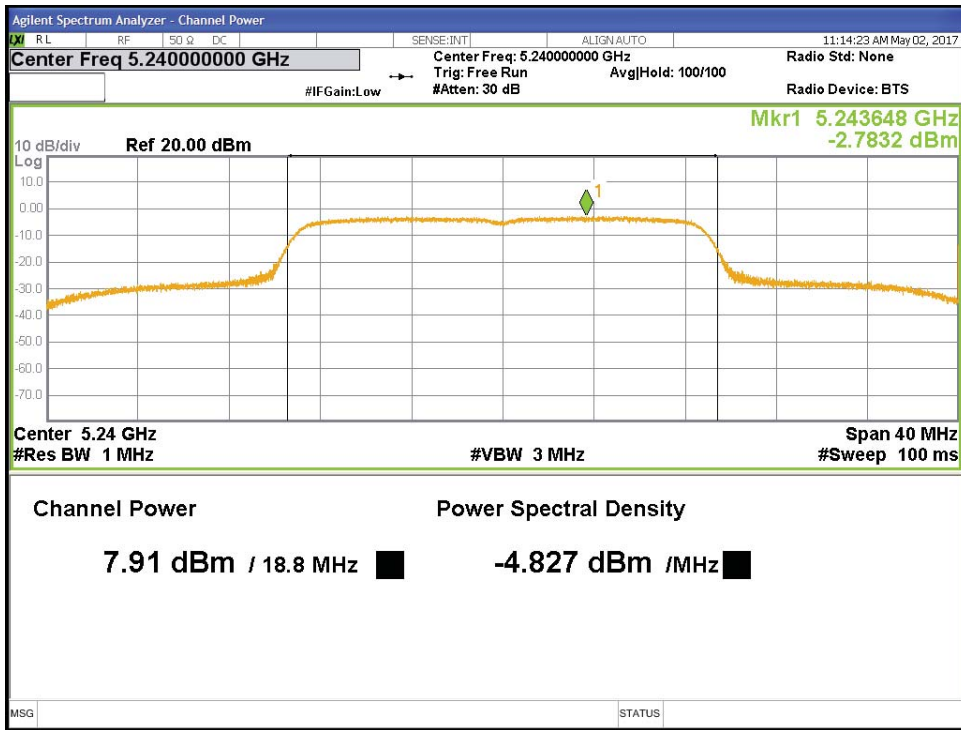

Figure 17: Conducted Output Power-5240 MHz-HT20-6.5 Mbps

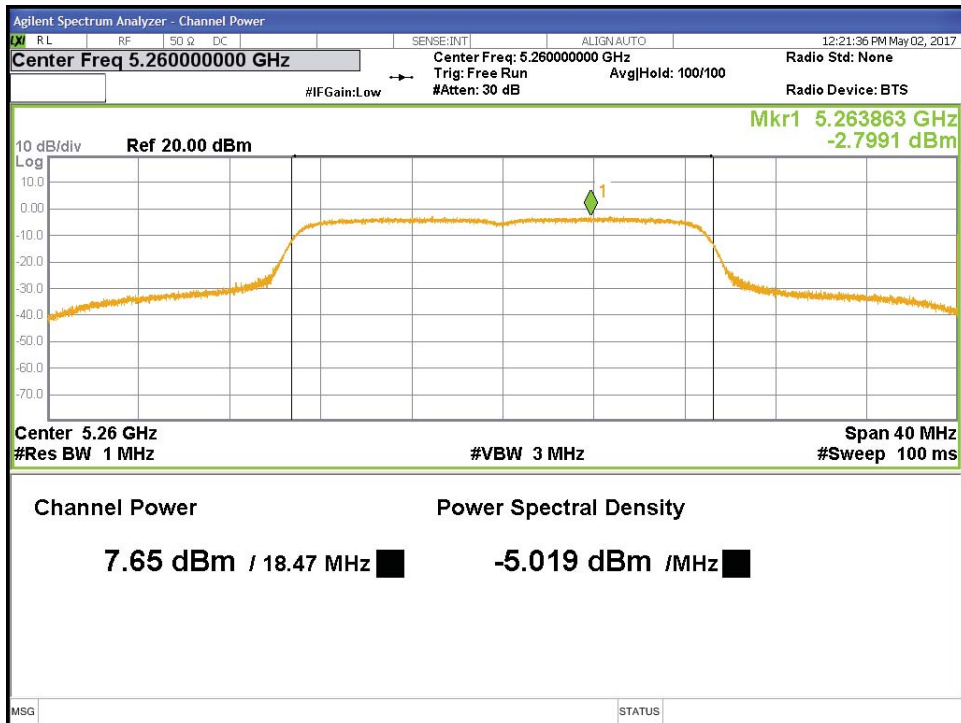

Figure 18: Conducted Output Power-5260 MHz-HT20-6.5 Mbps

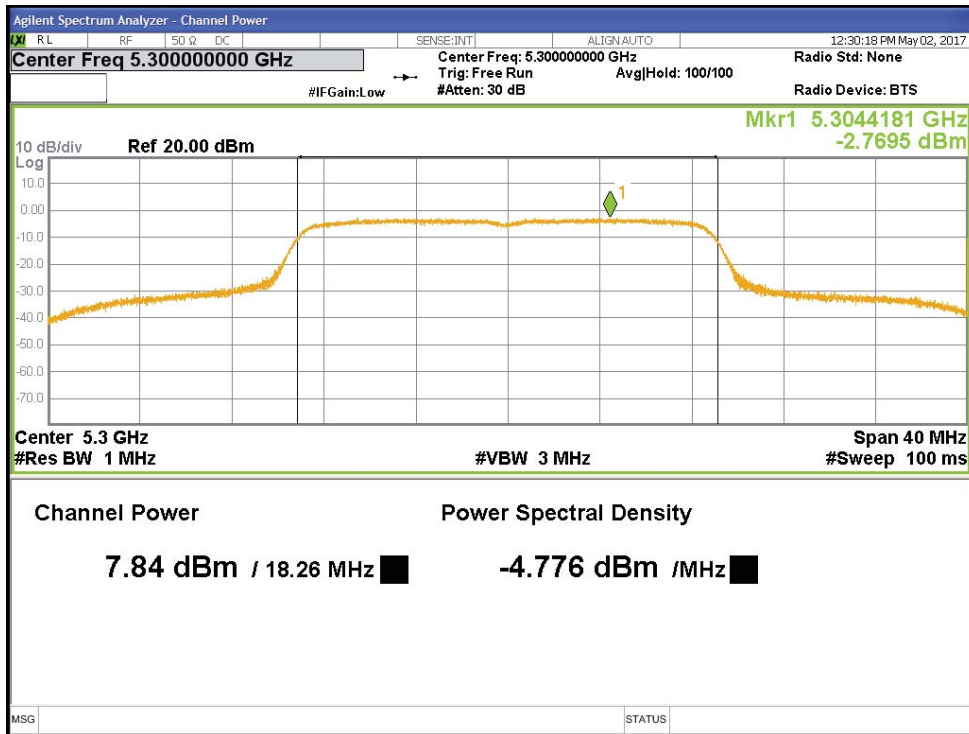

Figure 19: Conducted Output Power-5300 MHz-HT20-6.5 Mbps

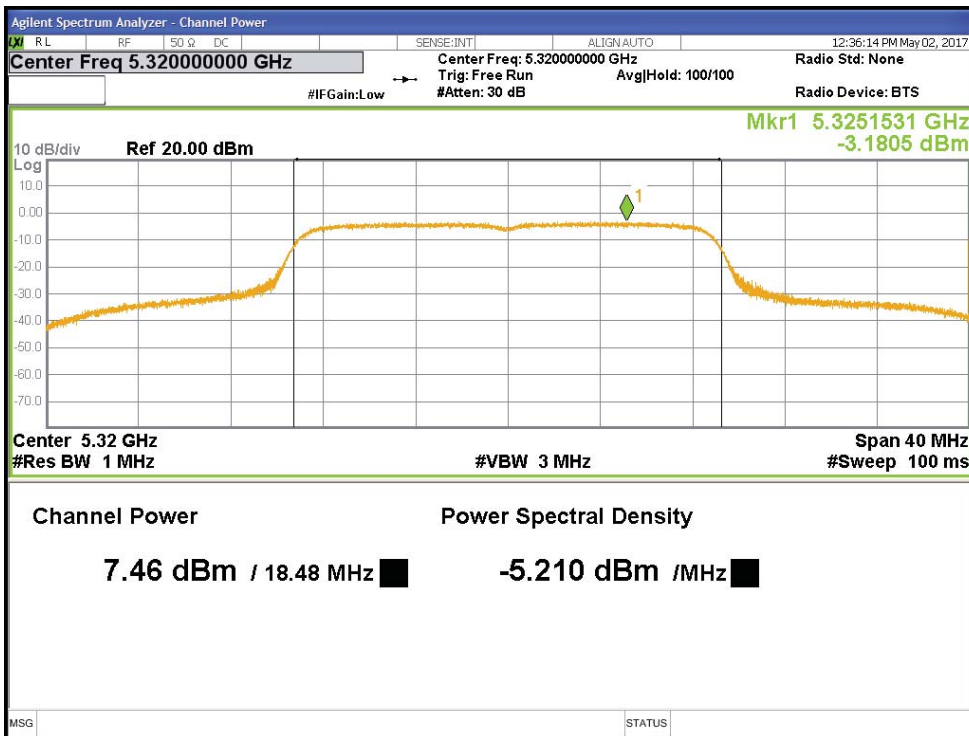

Figure 20: Conducted Output Power-5320 MHz-HT20-6.5 Mbps

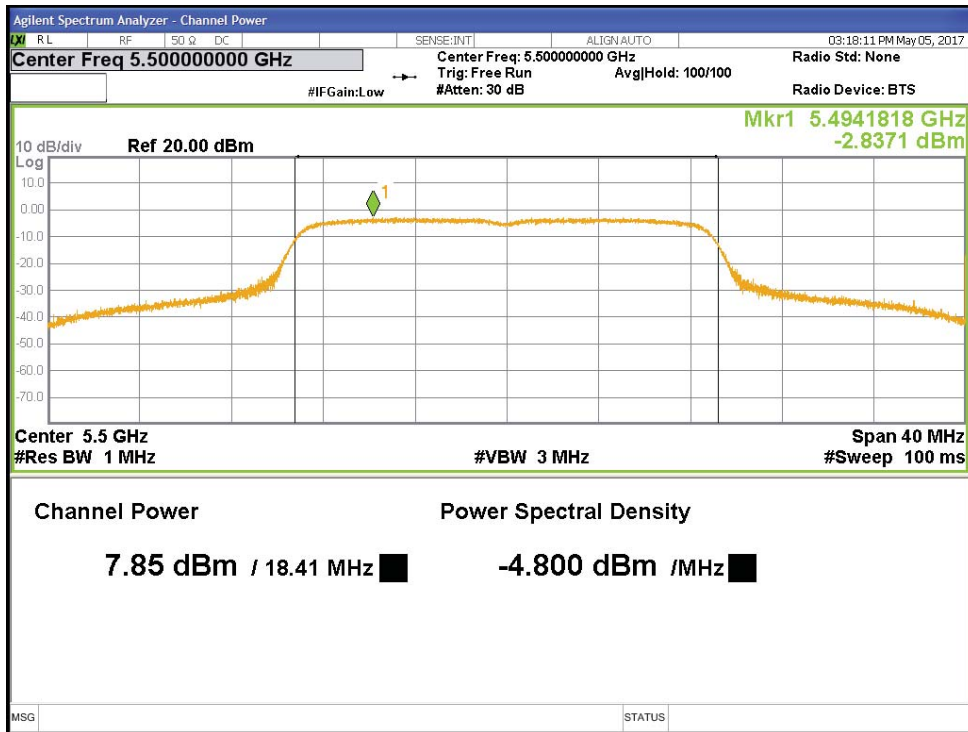

Figure 21: Conducted Output Power-5500 MHz-HT20-6.5 Mbps

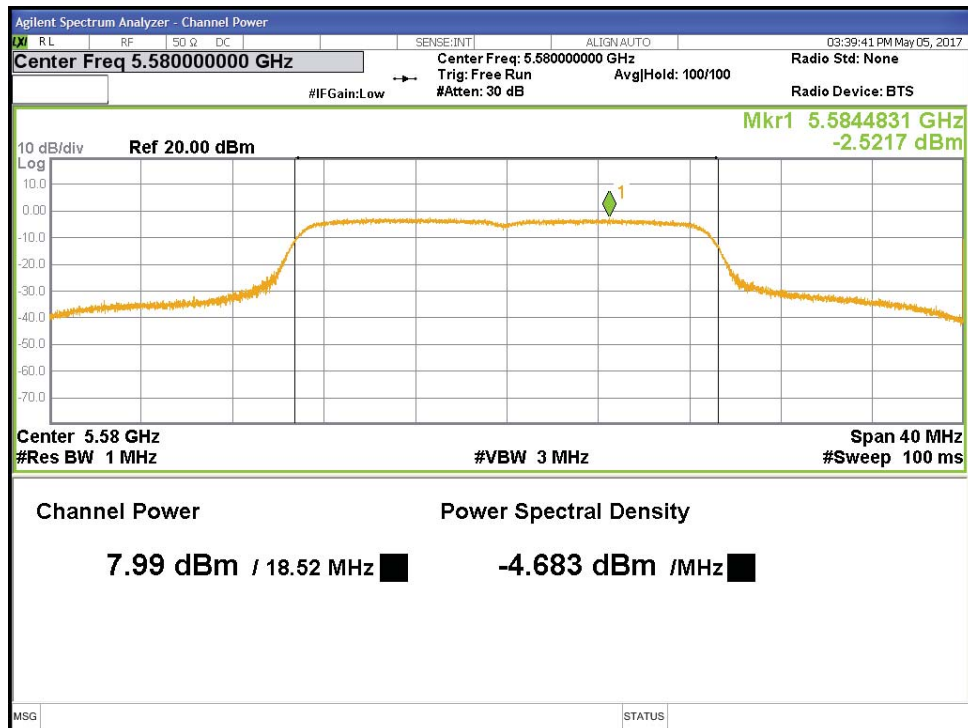

Figure 22: Conducted Output Power-5580 MHz-HT20-6.5 Mbps

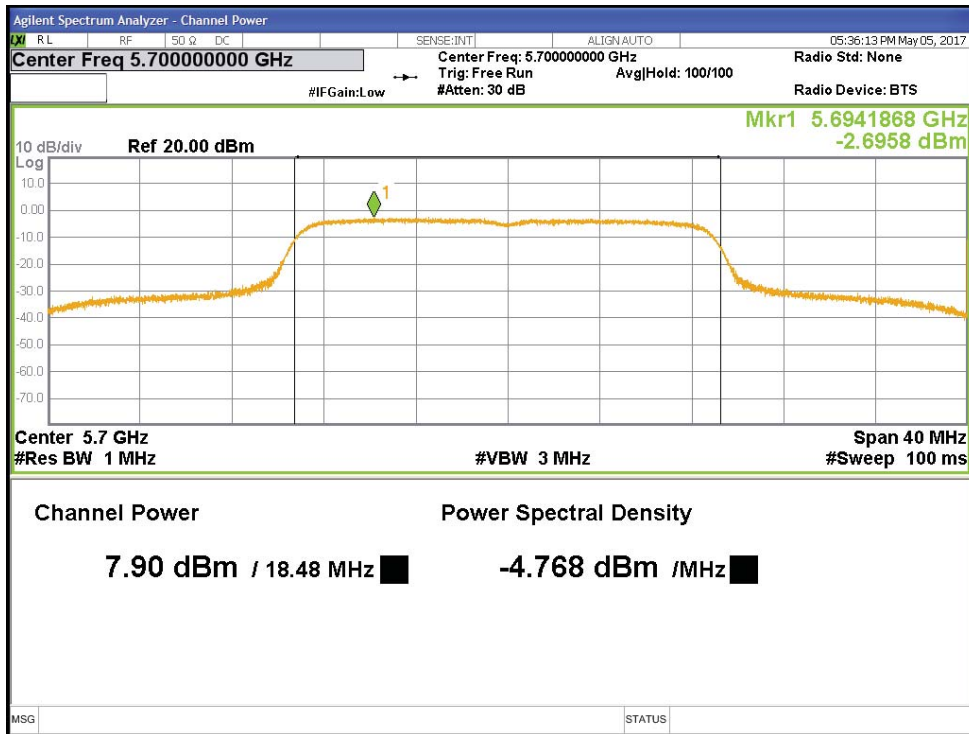

Figure 23: Conducted Output Power-5700 MHz-HT20-6.5 Mbps

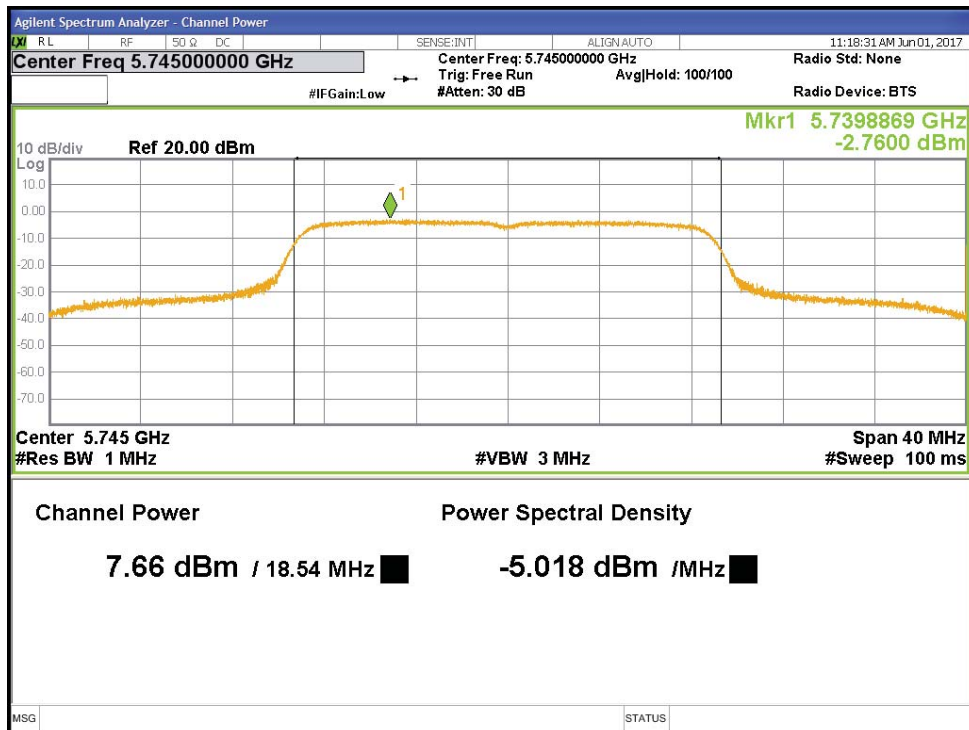

Figure 24: Conducted Output Power-5745 MHz-HT20-6.5 Mbps

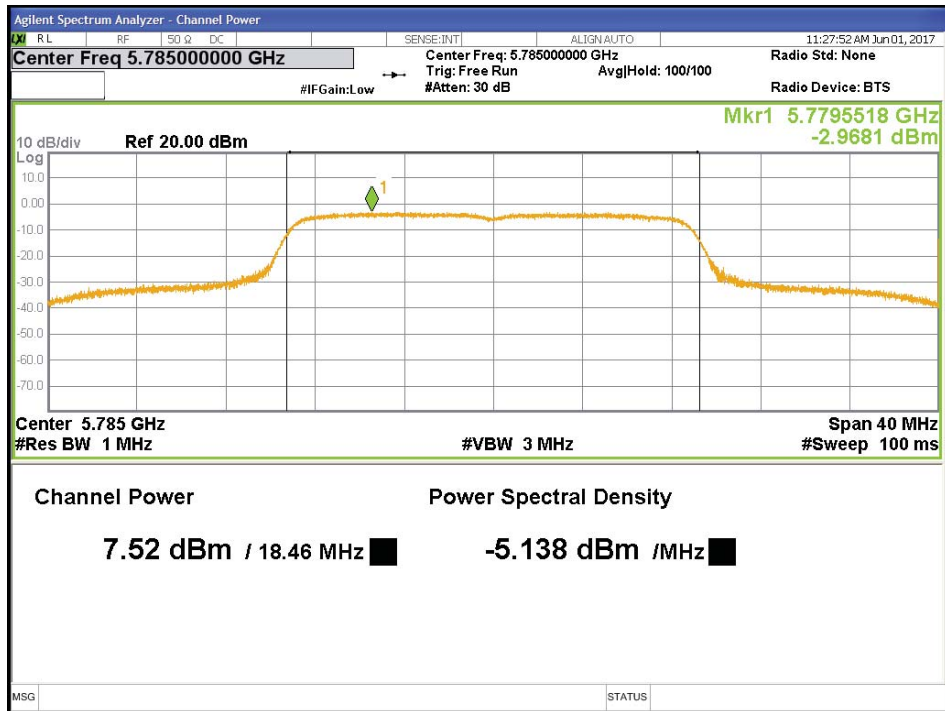

Figure 25: Conducted Output Power-5785 MHz-HT20-6.5 Mbps

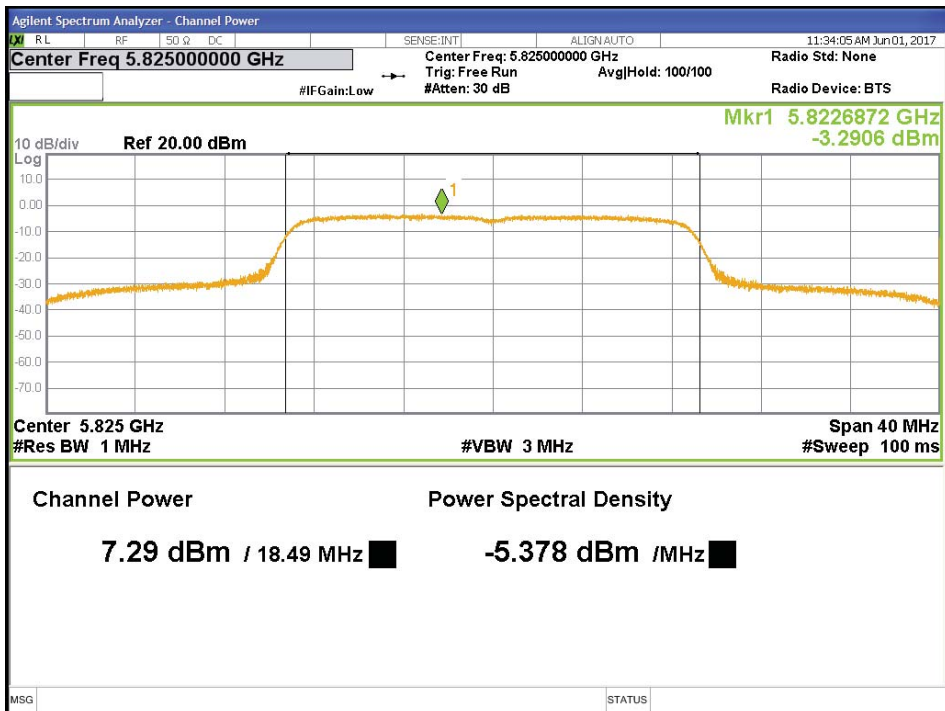

Figure 26: Conducted Output Power-5825 MHz-HT20-6.5 Mbps

4.2 Occupied Bandwidth

The occupied bandwidth is measured at an amplitude level reduced from the reference level by a specified ratio. The reference level is the level of the highest amplitude signal observed from the transmitter at the fundamental frequency.

The 99% bandwidth is the bandwidth in which 99% of the transmitted power occupied.

The 26 dB bandwidth is defined the bandwidth of 26 dB from highest transmitted level of the fundamental frequency.

The minimum 6 dB bandwidth shall be at least 500 kHz per Section CFR47 15.407(e) 2017 and RSS 247 Sect.6.2.4.1: 2017

There is no restriction limits for the bandwidth. The 26 dB bandwidth was used to determine the limit for maximum conducted output power per CFR47 Part 15.407(a).

4.2.1 Test Method

The conducted method was used to measure the occupied bandwidth. The measurement was performed with modulation per CFR47 15.407(a)&(e), RSS Gen Sect.6.6 and RSS-247 Sect.6.2.4.1. The preliminary investigation was performed to find the narrowest 26 dB bandwidth for each operational mode at different data rates. This worst finding was performed on 3 channels in each operating frequency range. The worst results indicated below.

Test Setup:

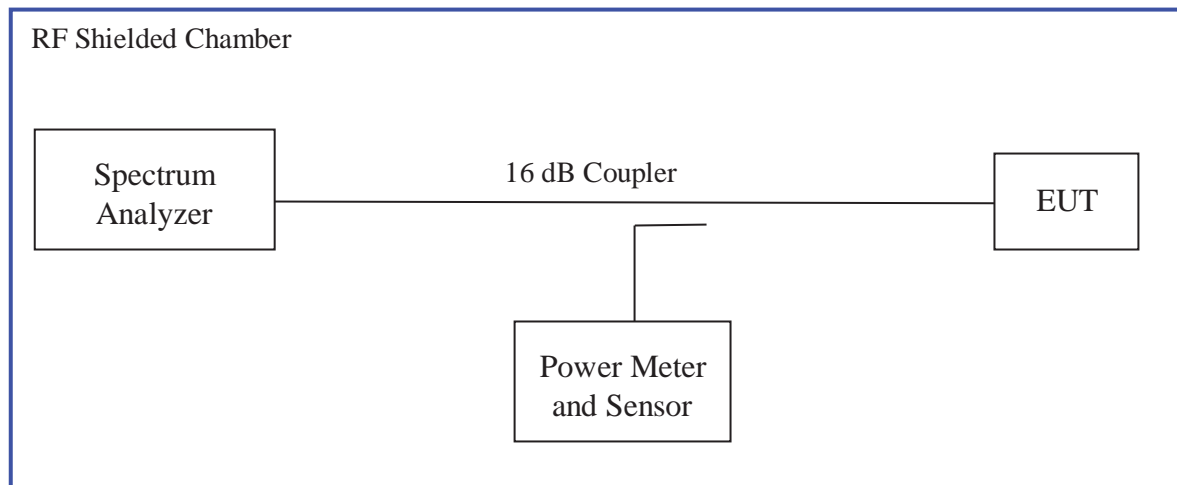

4.2.2 Results

These occupied bandwidth measurements were taken for reference only.

Table 4: Occupied Bandwidth – Test Results

Test Conditions: Conducted Measurement		Date: May 2, 2017		
Antenna Type: Chip		Power Setting: See test plan.		
Antenna Gain: 4.9 dBi		Signal State: Modulated at 100%		
Ambient Temp.: 23 °C		Relative Humidity: 33%		
Bandwidth (MHz) for 802.11a				
Frequency (MHz)	Limit (kHz)	99% BW	26 dB BW	Results
5180	NA	16.899	30.000	NA
5200	NA	16.899	29.990	NA
5240	NA	16.962	30.000	NA
5260	NA	16.825	30.00	NA
5300	NA	16.799	29.970	NA
5320	NA	16.699	28.630	NA
5500	NA	16.630	24.080	NA
5580	NA	16.660	25.530	NA
5700	NA	16.697	28.900	NA
Frequency (MHz)	Limit (kHz)	99% BW	6 dB BW	Results
5745	500	16.510	16.500	Pass
5785	500	16.503	16.440	Pass
5825	500	16.542	16.480	Pass
Note: The bandwidth was measured at 6 Mbps for 802.11a mode. The 99% bandwidths measurements are informative, and 26 dB bandwidths used to determine the output power limits.				
Bandwidth (MHz) for 802.11n HT20				
Frequency (MHz)	Limit (kHz)	99% BW	26 dB BW	Results
5180	NA	17.923	29.990	NA
5200	NA	17.988	30.000	NA
5240	NA	17.984	30.000	NA
5260	NA	17.814	29.300	NA

5300	NA	17.820	28.850	NA
5320	NA	17.815	28.520	NA
5500	NA	17.745	24.270	NA
5580	NA	17.779	26.700	NA
5700	NA	17.807	29.760	NA
Frequency (MHz)	Limit (kHz)	99% BW	6 dB BW	Results
5745	500	17.672	17.680	Pass
5785	500	17.680	17.620	Pass
5825	500	17.705	16.670	Pass
<p>Note: The bandwidth was observed at MCS0, 6.5Mbps mode. The 99% bandwidth measurements are informative, and 26 dB bandwidths used to determine the output power limits.</p>				

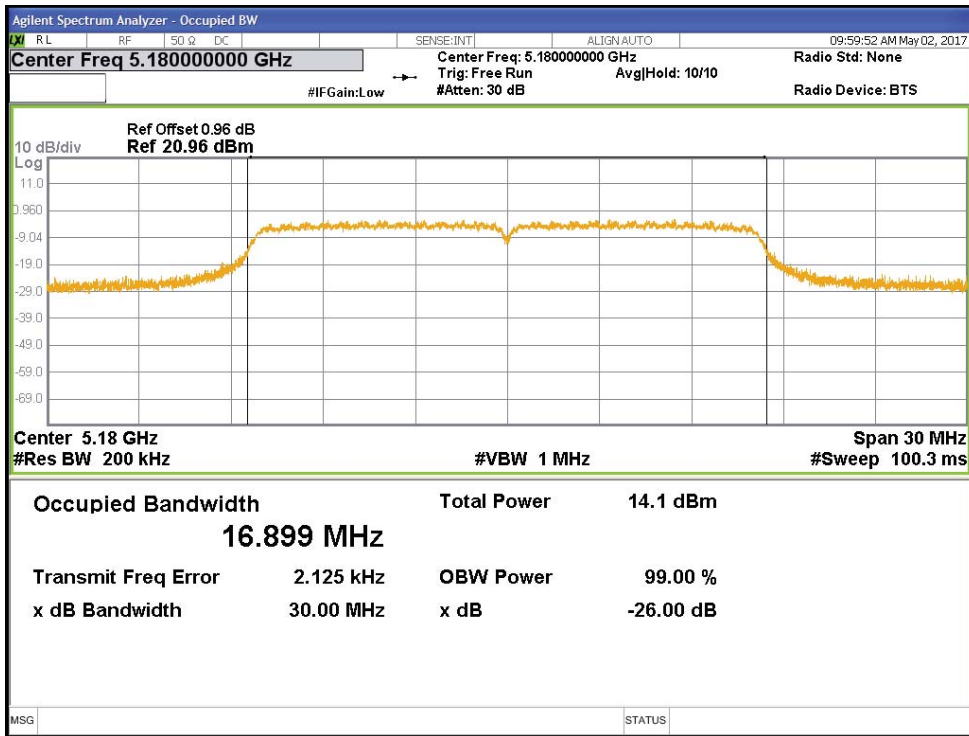

Figure 27: Occupied Bandwidth-5180 MHz-11A-2

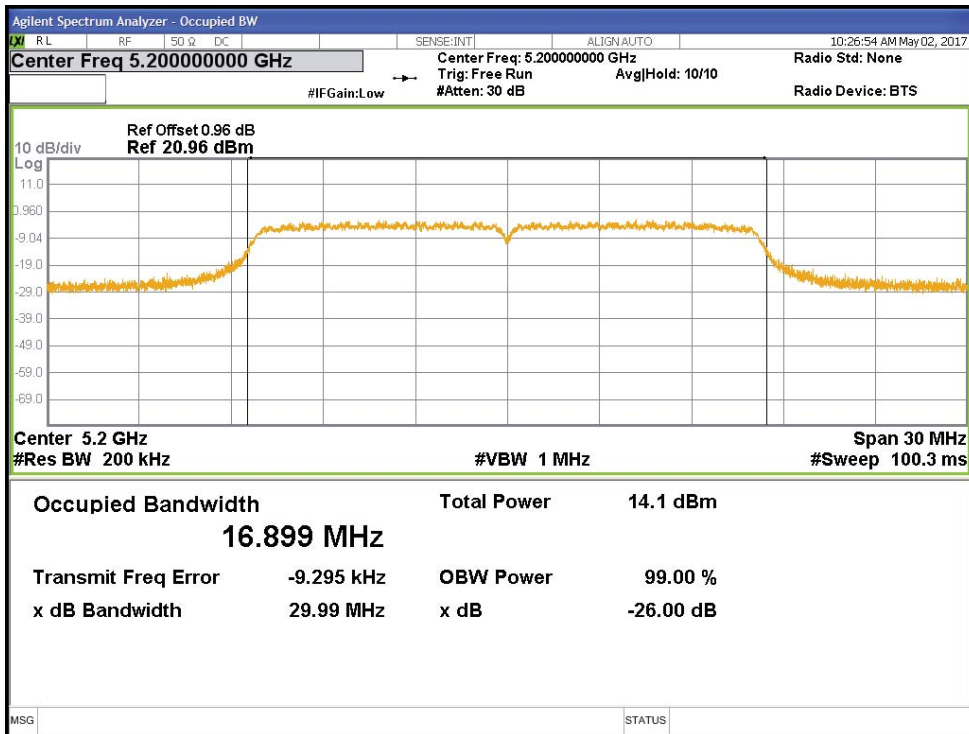

Figure 28: Occupied Bandwidth-5200 MHz-11a

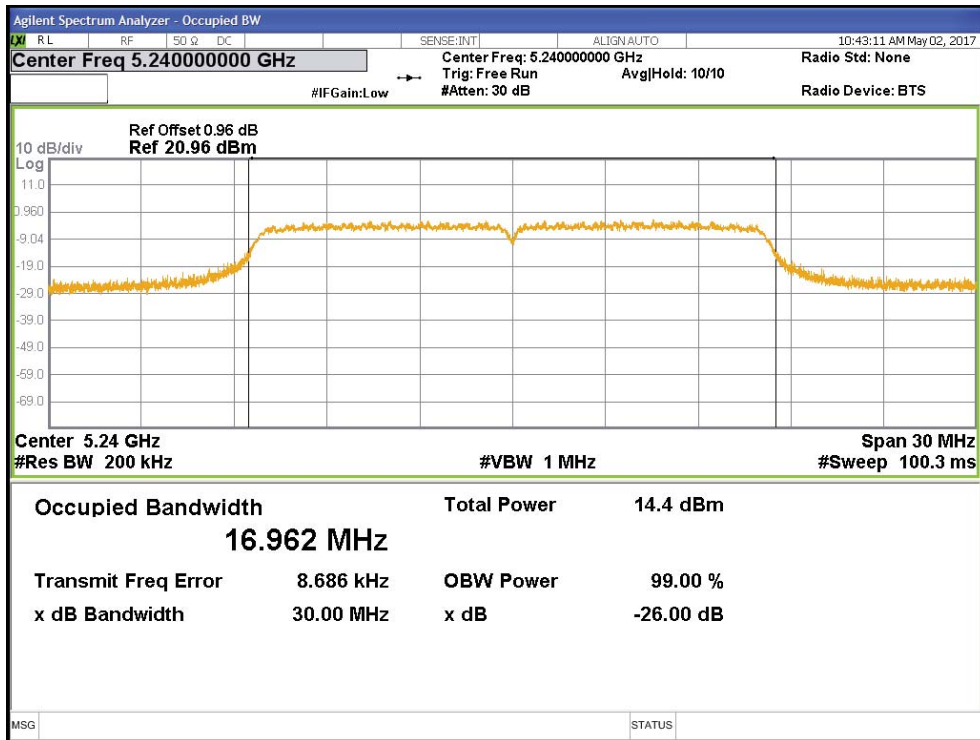

Figure 29: Occupied Bandwidth-5240 MHz-11a

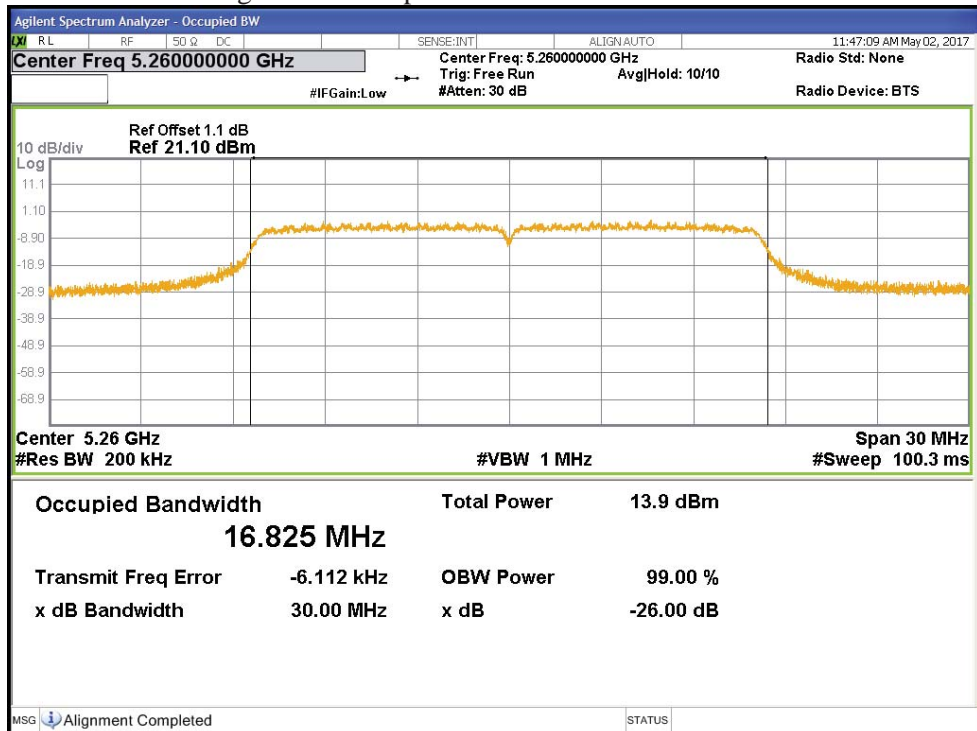

Figure 30: Occupied Bandwidth-5260 MHz-11a

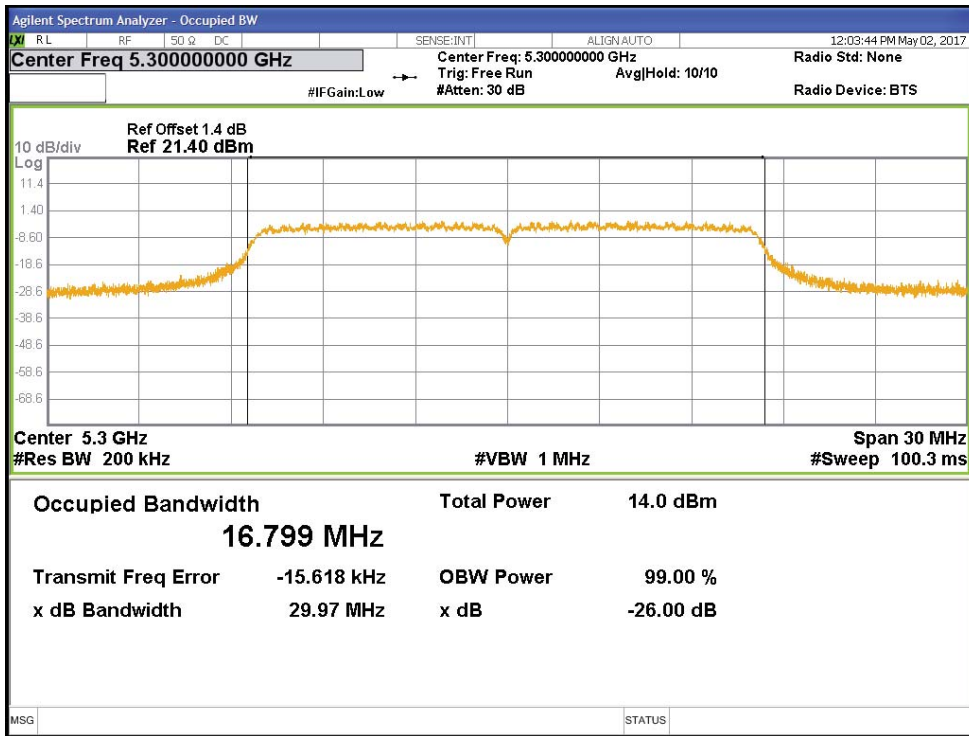

Figure 31: Occupied Bandwidth-5300 MHz-11a

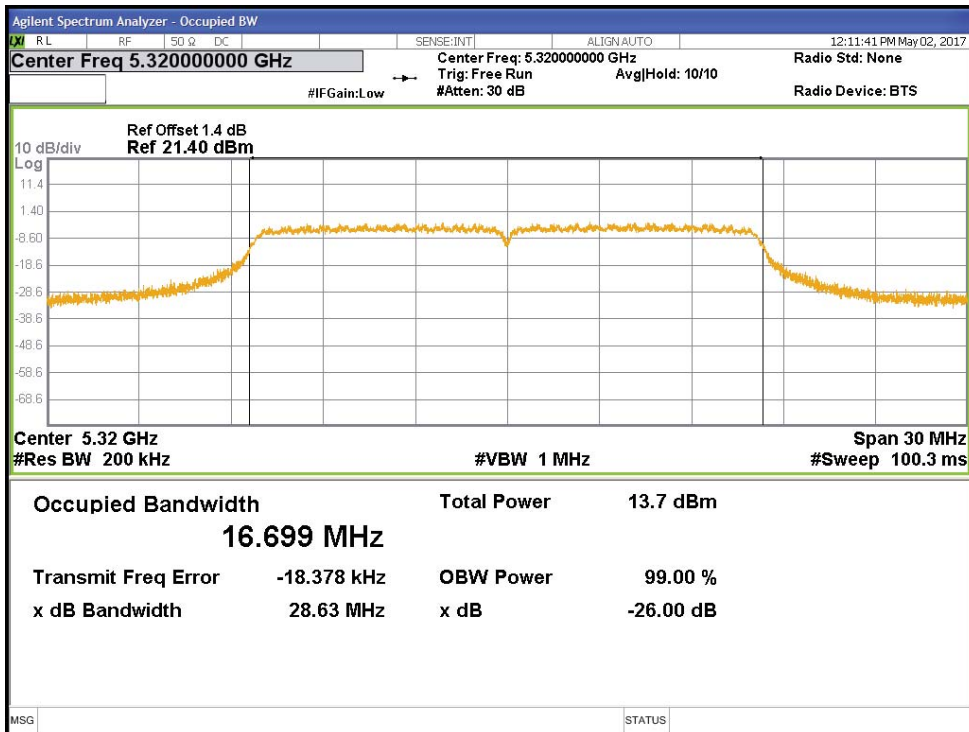

Figure 32: Occupied Bandwidth-5320 MHz-11a