



# Emissions Test Report

**EUT Name:** USB Wireless Audio Transmitter

**Model No.:** Stealth700P-MAX-TX

CFR 47 Part 15.247: 2021 and RSS 247: 2017

*Prepared for:*

Voyetra Turtle Beach, Inc.  
44 South Broadway, 4th Floor  
White Plains NY 10601 USA

*Prepared by:*

Bureau Veritas Consumer Products Services, Inc.  
775 Montague Expressway,  
Milpitas, CA 95035  
Tel: (408) 526-1188

*Report/Issue Date:* August 1, 2022  
*Revision Number* 0  
*Report Number:* SL22041909-CCP-213\_7MPP\_TX\_RF

## Revisions

Revision No.	Date MM/DD/YYYY	Reason for Change	Author
0	08/01/2022	Original Document	N/A

Note: Latest revision report will replace all previous reports.

# Statement of Compliance

*Manufacturer:* Voyetra Turtle Beach, Inc.  
44 South Broadway, 4th Floor  
White Plains NY 10601 USA

*Requester / Applicant:* Tim Blaney  
(530) 277-3482

*Name of Equipment:* USB Wireless Audio Transmitter  
*Model No's:* Stealth700P-MAX-TX  
*Type of Equipment:* Intentional Radiator  
*Application of Regulations:* CFR 47 Part 15.247: 2021 and RSS 247: 2017  
*Test Dates:* March 13, 2022 to March 25, 2022

*Guidance Documents:*

Emissions: ANSI C63.10-2013, KDB 558074 D01 DTS Measurement Guidance v05r02,

*Test Methods:*

Emissions: ANSI C63.10-2013, KDB 558074 D01 DTS Measurement Guidance v05r02,

This report is for your exclusive use. Any copying or replication of this report to or for any other person or entity, or use of our name or trademark, is permitted only with our prior written permission. This report sets forth our findings solely with respect to the test samples identified herein. The results set forth in this report are not indicative or representative of the quality or characteristics of the lot from which a test sample was taken or any similar or identical product unless specifically and expressly noted. Our report includes all of the tests requested by you and the results thereof based upon the information that you provided to us. You have 60 days from date of issuance of this report to notify us of any material error or omission caused by our negligence, provided, however, that such notice shall be in writing and shall specifically address the issue you wish to raise. A failure to raise such issue within the prescribed time shall constitute your unqualified acceptance of the completeness of this report, the tests conducted and the correctness of the report contents. Unless specific mention, the uncertainty of measurement has been explicitly taken into account to declare the compliance or non-compliance to the specification. The report must not be used by the client to claim product certification, approval, or endorsement by A2LA or any government agencies.

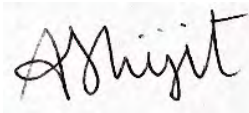

Abhijit Patibandla

Test Engineer

Date August 1, 2022



Suresh Kondapalli

Reviewer Signatory

Date August 1, 2022



Testing Cert #2742-01



US1109

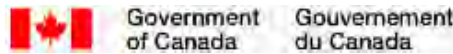

4842D

Table of Contents

<b>1</b>	<b>Executive Summary</b>	<b>7</b>
1.1	Scope	7
1.2	Purpose	7
1.3	Summary of Test Results	8
1.4	Special Accessories	8
1.5	Equipment Modifications	8
<b>2</b>	<b>Laboratory Information</b>	<b>9</b>
2.1	Accreditations & Endorsements	9
2.1.1	US Federal Communications Commission	9
2.1.2	NIST / A2LA	9
2.1.3	Canada	9
2.1.4	Japan – VCCI	9
2.1.5	Acceptance by Mutual Recognition Arrangement	9
2.2	Test Facilities	10
2.2.1	Emission Test Facility	10
2.3	Measurement Uncertainty	10
2.3.1	Sample Calculation – radiated & conducted emissions	10
2.3.2	Measurement Uncertainty	11
2.4	Calibration Traceability	11
<b>3</b>	<b>Product Information</b>	<b>12</b>
3.1	Product Description	12
3.2	Equipment Configuration	12
3.3	Operating Mode	12
3.4	Unique Antenna Connector	13
3.4.1	Results	13
3.5	Duty Cycle	14
3.5.1	Results	14
<b>4</b>	<b>Emissions</b>	<b>15</b>
4.1	Output Power Requirements	15
4.1.1	Test Method	15
4.1.2	Results	16
4.2	Occupied Bandwidth	20
4.2.1	Test Method	20
4.2.2	Results	20
4.3	Peak Power Spectral Density	28
4.3.1	Test Method	28
4.3.2	Results	28
4.4	Out of Band Emissions	33
4.4.1	Test Method	33
4.4.2	Results	34

## Table of Contents

<b>4.5</b>	<b>Transmit Spurious Emissions</b>	<b>41</b>
4.5.1	Test Methodology	41
4.5.2	Transmitter Spurious Emission Limit	42
4.5.3	Test Results	42
4.5.4	Sample Calculation	52
<b>4.6</b>	<b>AC Conducted Emissions</b>	<b>53</b>
4.6.1	Test Methodology	53
4.6.2	Test Results	53
<b>5</b>	<b><i>Test Equipment List</i></b>	<b>57</b>
<b>5.1</b>	<b>Equipment List</b>	<b>57</b>
<b>6</b>	<b><i>EMC Test Plan</i></b>	<b>58</b>
<b>6.1</b>	<b>Introduction</b>	<b>58</b>
<b>6.2</b>	<b>Customer</b>	<b>58</b>
<b>6.3</b>	<b>Equipment Under Test (EUT)</b>	<b>59</b>
<b>6.4</b>	<b>Test Specifications</b>	<b>62</b>

Index of Tables

<b>Table 1:</b> Summary of Test Results.....	8
<b>Table 2:</b> RF Output Power at the Antenna Port – Test Results.....	16
<b>Table 3:</b> Occupied Bandwidth – Test Results .....	21
<b>Table 4:</b> Peak Power Spectral Density – Test Results .....	29
<b>Table 5:</b> Out of Band Emissions – Test Results.....	34
<b>Table 6:</b> Transmit Spurious Emission at Band-Edge Requirements .....	43
<b>Table 7:</b> AC Conducted Emissions – Test Results.....	53
<b>Table 8:</b> Customer Information.....	58
<b>Table 9:</b> Technical Contact Information .....	58
<b>Table 10:</b> EUT Specifications .....	59
<b>Table 11:</b> Interface Specifications.....	60
<b>Table 12:</b> Supported Equipment.....	60
<b>Table 13:</b> Description of Sample used for Testing.....	60
<b>Table 14:</b> Description of Test Configuration used for Radiated Measurement. ....	60
<b>Table 15:</b> Final Test Mode for 2402 MHz to 2480MHz Band.....	61
<b>Table 16:</b> Test Specifications.....	62

# 1 Executive Summary

## 1.1 Scope

This report is intended to document the status of conformance with the requirements of the CFR 47 Part 15.247: 2021 and RSS 247: 2017 based on the results of testing performed on March 13, 2022 to March 25, 2022 on the USB Wireless Audio Transmitter Model Stealth700P-MAX-TX manufactured by Voyetra Turtle Beach, Inc. This report only applies to the specific samples tested under the stated test conditions. It is the responsibility of the manufacturer to assure that additional production units of this model are manufactured with identical or EMI equivalent electrical and mechanical components. This report is further intended to document changes and modifications to the EUT throughout its life cycle. All documentation will be included as a supplement.

## 1.2 Purpose

Testing was performed to evaluate the EMC performance of the EUT in accordance with the applicable requirements, procedures, and criteria defined in the application of regulations and application of standards listed in this report. The 2402 MHz to 2480 MHz frequency band is covered in this document.

### 1.3 Summary of Test Results

**Table 1:** Summary of Test Results

Test	Test Method ANSI C63.10:2013	Test Parameters	Measured Value	Result
Spurious Emission in Transmitted Mode	CFR47 15.209, CFR47 15.247 (d) RSS GEN Sect.8.9	Class B	-6.60 dB (Margin)	Complied
Restricted Bands of Operation	CFR47 15.205, RSS GEN Sect.8.10	Class B		Complied
AC Power Conducted Emission	CFR47 15.207, RSS-GEN Sect.8.8	Class B	-4.00 dB (Margin)	Complied
Occupied Bandwidth	CFR47 15.247 (a2), RSS GEN Sect.6.7, RSS 247 Sect. 5.2 (a)	$\geq 500$ kHz	1.029 MHz (99%) 0.710 MHz (DTS)	Complied
Maximum Output Power	CFR47 15.247 (b), RSS 247 Sect. 5.4 (d)	30 dBm w/ 6 dBi antenna	+6.42 dBm	Complied
Peak Power Spectral Density	CFR47 15.247 (e), RSS 247 Sect. 5.2 (b)	8 dBm/ 3 kHz	-12.85 dBm	Complied
Out of Band Emission	CFR47 15.247 (d), RSS 247 Sect.5.5	-30 dB	-26.06 dB (Margin)	Complied

### 1.4 Special Accessories

No special accessories were necessary in order to achieve compliance.

### 1.5 Equipment Modifications

None



## 2 Laboratory Information

### 2.1 Accreditations & Endorsements

#### 2.1.1 US Federal Communications Commission



Bureau Veritas Consumer Products Services, Inc. at 775 Montague Expressway, Milpitas CA 95035 is recognized by the commission for performing testing services for the general public on a fee basis. These laboratory test facilities have been fully described in reports submitted to and accepted by the FCC (Registration No. US1109). The laboratory scope of accreditation includes: Title 47 CFR Parts 15, 18, 20, 22, 24, 25, 27, 90, 95, 97 and 101. The accreditation is updated every 3 years.

#### 2.1.2 NIST / A2LA



Bureau Veritas Consumer Products Services, Inc is accredited by the National Voluntary Laboratory Accreditation Program, which is administered under the auspices of the National Institute of Standards and Technology. The laboratory has been assessed and accredited in accordance with ISO Guide 17025:2017 and ISO 9002 (Lab Code 2742-01). The scope of laboratory accreditation includes emission and immunity testing. The accreditation is updated annually.

#### 2.1.3 Canada

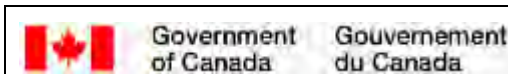

Bureau Veritas Consumer Products Services, Inc. at the 775 Montague Expressway, Milpitas, CA 95035 address is accredited by Industry Canada for

performing testing services for the general public on a fee basis. This laboratory test facilities have been fully described in reports submitted to and accepted by Industry Canada (File Number 4842D). This reference number is the indication to the Industry Canada Certification Officers that the site meets the requirements of RSS 212, Issue 1 (Provisional). The accreditation is updated every 3 years.

#### 2.1.4 Japan – VCCI



The Voluntary Control Council for Interference by Information Technology Equipment (VCCI) is a group that consists of Information Technology Equipment (ITE) manufacturers and EMC test laboratories. The purpose of the Council is to take voluntary control measures against electromagnetic interference from Information Technology Equipment, and thereby contribute to the development of a socially beneficial and responsible state of affairs in the realm of Information Technology Equipment in Japan. Bureau Veritas Consumer Products Services, Inc. at 775 Montague Expressway, Milpitas, CA 95035 has been assessed and approved in accordance with the Regulations for Voluntary Control Measures.

VCCI Registration No. for Milpitas: A-0133

#### 2.1.5 Acceptance by Mutual Recognition Arrangement



The United States has an established agreement with specific countries under the Asia Pacific Laboratory Accreditation Corporation (APLAC) Mutual Recognition Arrangement. Under this agreement, all Bureau Veritas Consumer Products Services, Inc. at 775 Montague Expressway, Milpitas, CA 95035 test results and test reports within the scope of the laboratory NIST / A2LA accreditation will be accepted by each member country.

## 2.2 Test Facilities

All of the test facilities are located at 775 Montague Expressway, Milpitas, California, 95035, USA.

### 2.2.1 Emission Test Facility

The Semi-Anechoic chamber and AC Line Conducted measurement facility used to collect the radiated and conducted data has been constructed in accordance with ANSI C63.7:1992. The site has been measured in accordance with and verified to comply with the theoretical normalized site attenuation requirements of ANSI C63.4-2014, at a test distance of 3 and 10 meters. The site is listed with the FCC and accredited by A2LA (Lab Code 2742-01). A report detailing this site can be obtained from Bureau Veritas Consumer Products Services, Inc.

### 2.3 Measurement Uncertainty

Two types of measurement uncertainty are expressed in this report, per *ISO Guide To The Expression Of Uncertainty In Measurement*, 1<sup>st</sup> Edition, 1995.

*The Combined Standard Uncertainty* is the standard uncertainty of the result of a measurement when that result is obtained from the values of a number of other quantities; it is equal to the positive square root of the sum of the variances or co-variances of these other quantities, weighted according to how the measurement result varies with changes in these quantities. The term *standard uncertainty* is the result of a measurement expressed as a standard deviation.

#### 2.3.1 Sample Calculation – radiated & conducted emissions

The field strength is calculated by subtracting the Amplifier Gain and adding the Cable Loss and Antenna Correction Factor to the measured reading. The basic equation is as follows:

$$\text{Field Strength (dB}\mu\text{V/m)} = \text{RAW} - \text{AMP} + \text{CBL} + \text{ACF}$$

Where: RAW = Measured level before correction (dB $\mu$ V)

AMP = Amplifier Gain (dB)

CBL = Cable Loss (dB)

ACF = Antenna Correction Factor (dB/m)

$$\mu\text{V/m} = 10^{\frac{\text{dB}\mu\text{V/m}}{20}}$$

#### Sample radiated emissions calculation @ 30 MHz

**Measurement +Antenna Factor–Amplifier Gain+Cable loss=Radiated Emissions (dBuV/m)**

$$25 \text{ dBuV/m} + 17.5 \text{ dB} - 20 \text{ dB} + 1.0 \text{ dB} = 23.5 \text{ dBuV/m}$$

---

### 2.3.2 Measurement Uncertainty

Where relevant, the following measurement uncertainty levels have been estimated for tests performed on the EUT as specified in CISPR 16-4-2:

MEASUREMENT	FREQUENCY	UNCERTAINTY
Conducted emissions	0.15 MHz ~ 30 MHz	2.70 dB
Radiated emissions	9 kHz ~ 30 MHz	2.16 dB
	30 MHz ~ 1 GHz	3.60 dB
	1 GHz ~ 18 GHz	4.82 dB
	18 GHz ~ 40 GHz	5.00 dB

This uncertainty represents an expanded uncertainty expressed at approximately the 95% confidence level using a coverage factor of  $k = 2$ .

### 2.4 Calibration Traceability

All measurement instrumentation is traceable to the National Institute of Standards and Technology (NIST). Measurement method complies with ANSI/NCSL Z540-1-1994 and ISO Standard 17025:2017. Equipment calibration records are kept on file at the test facility.

---

## 3 Product Information

### 3.1 Product Description

The Stealth 700P Gen 2 MAX Wireless Gaming System consists of two main communication modules, the Stealth700P-MAX-RX (“Headset”) and the Stealth700P-MAX-TX (“Transmitter”). These two modules comprise a closed-loop wireless audio gaming system that utilize a proprietary 2.4 GHz communication technology to offer wireless streaming audio and chat/talkback capabilities. The devices are designed to operate with a PlayStation gaming console or PC-based system.

The Stealth700P-MAX-RX is powered by a 1400 mAh battery to provide 40 hours of operation. It has 50mm drivers, a fixed omni-directional gooseneck microphone with flip up microphone mute and microphone monitoring. Additional advanced functionality includes a Bluetooth radio that provides simultaneous connection to a Turtle Beach mobile app and device for streaming audio. Other audio processing features and controls include Superhuman Hearing, variable Mic Monitoring and a glasses friendly ProSpecs™ ear cup design.

The Stealth700P-MAX-TX is powered by a host 5VDC USB port and receives the digital audio signal from the host device over the same USB port. It then communicates that information to the Stealth700P-MAX-RX over a proprietary 2.4 GHz link.

The Stealth 700P Gen 2 MAX has two versions that are 100% identical electrically and mechanically except for the color of their exterior plastics. The two model color variations are standard Black and Midnight Blue.

### 3.2 Equipment Configuration

A description of the equipment configuration is given in the Test Plan Section. The EUT was tested as called for in the test standard and was configured and operated in a manner consistent with its intended use. The EUT was connected to rated power and allowed to reach intended operating conditions. The placement of the EUT system components was guided by the test standard and selected to represent typical installation conditions.

In the case of an EUT that can operate in more than one configuration, preliminary testing was performed to determine the configuration that produced maximum radiation.

The final configuration was selected to produce the worst case radiation for emissions testing and to place the EUT in the most susceptible state for immunity testing.

### 3.3 Operating Mode

A description of the operation mode is given in the Test Plan Section. In the case of an EUT that can operate in more than one state, preliminary testing was performed to determine the operating mode that produced maximum radiation.

The final operating mode was selected to produce the worst case radiation for emissions testing and to place the EUT in the most susceptible state for immunity testing.

### 3.4 Unique Antenna Connector

An intentional radiator shall be designed to ensure that no antenna other than that furnished by the responsible party shall be used with the device. The use of a permanently attached antenna or of an antenna that uses a unique coupling to the intentional radiator shall be considered sufficient to comply with the provisions of this Section. The manufacturer may design the unit so that a broken antenna can be replaced by the user, but the use of a standard antenna jack or electrical connector is prohibited. This requirement does not apply to carrier current devices or to devices operated under the provisions of CFR47 Parts 15.211, 15.213, 15.217, 15.219, or 15.221.

#### 3.4.1 Results

The Stealth700P-MAX-TX uses the permanently attached PCB trace antenna inside the device. See EUT Photo for details.

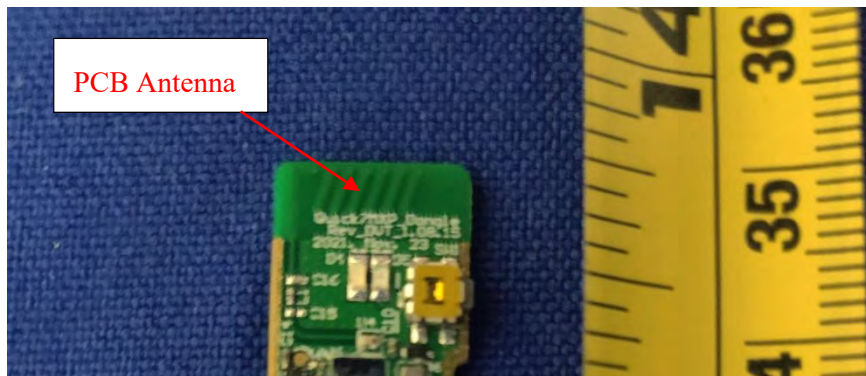

### 3.5 Duty Cycle

The Stealth700P-MAX-TX, SN: PP1 was measured.

#### 3.5.1 Results

Mode	On Time (ms)	Period (ms)	Duty Cycle (%)	Duty Factor (dB)
Standard	-	-	100	0

**Notes:** EUT was configured and measured for its duty cycle. All measurements use 100% duty cycle.

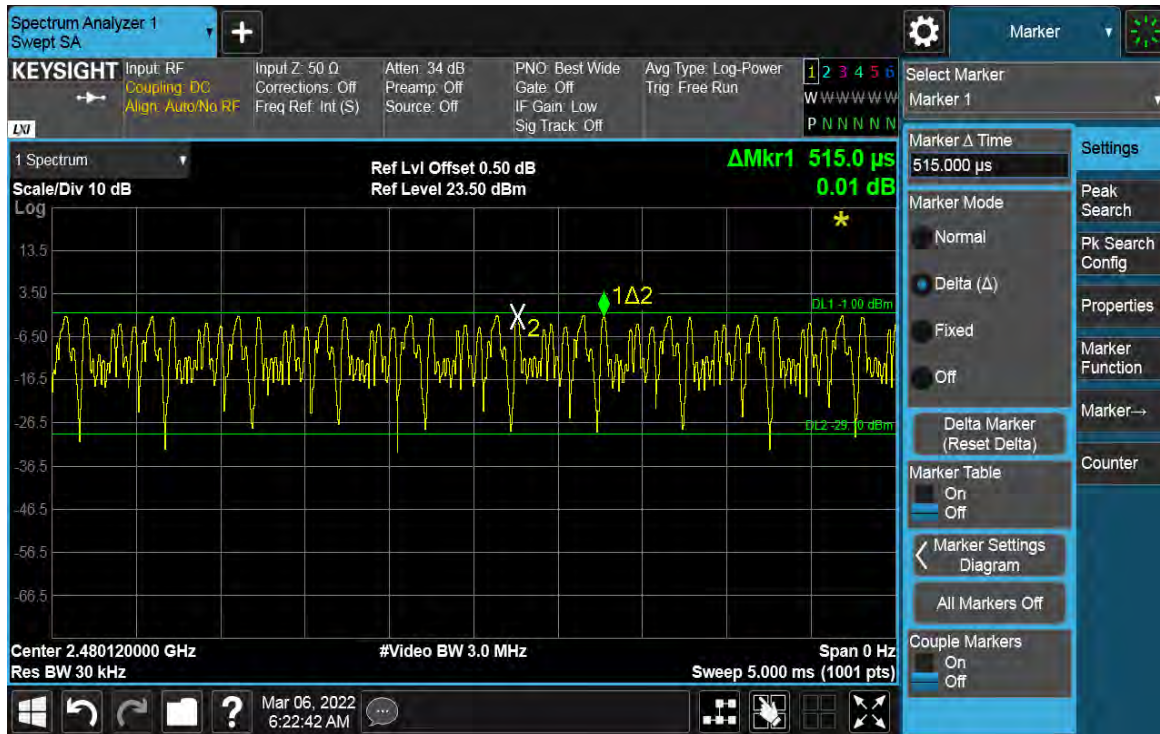

Figure 1: Duty Cycle



## 4 Emissions

Testing was performed in accordance with CFR 47 Part 15.247: 2021 and RSS 247: 2017. These test methods are listed under the laboratory's A2LA Scope of Accreditation. This test measures the levels emanating from the EUT, thus evaluating the potential for the EUT to cause radio frequency interference to other electronic devices. Procedures described in section 8 of the standard were used.

### 4.1 Output Power Requirements

*The maximum output power requirement is the maximum equivalent isotropic radiated power delivering at the transmitting antenna under specified conditions of measurements in the presence of modulation.*

*The maximum output power and harmonics shall not exceed CFR47 Part 15.247 (b):2021 and RSS 247: 2017 Sect. 5.4 (d).*

*The maximum transmitted powers are*

*Band 2400-2483.5 MHz: 1 W*

#### 4.1.1 Test Method

The ANSI C63.10-2013 Section 11.9.2.2 conducted method was used to measure the channel power output. The preliminary investigation was performed at different data rate/ chain to determine the highest power output for each mode. The worst findings were conducted on 3 channels in each operating range per CFR47 Part 15.247(b): 2021 and RSS 247 Sect. 5.4 (d). This test was conducted on 3 channels of Sample, S/N PP #1. The worst mode result indicated below.

Test Setup:

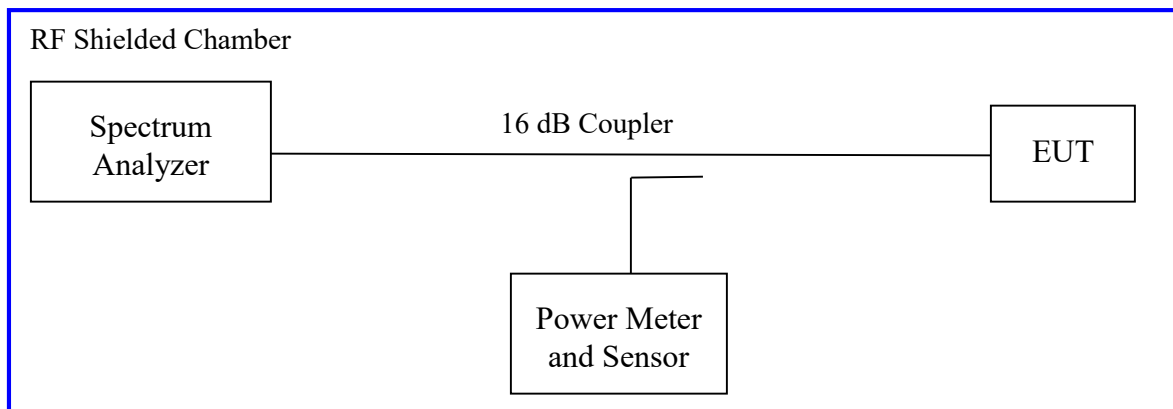

*Method AVGSA-2 of "KDB 558074 – DTS Measurement Guidance v05r02" applies since the EUT continuously transmits with duty cycle less than 98%. Sample detector was used.*

## 4.1.2 Results

As originally tested, the EUT was found to be compliant to the requirements of the test standard(s).

**Table 2: RF Output Power at the Antenna Port – Test Results**

<b>Test Date:</b> March 8, 2022			<b>Test By:</b> Abhijit Patibandla		
<b>Test Method:</b> Conducted Measurements			<b>Power Setting:</b> Fixed at 4 dBm		
<b>Antenna Type:</b> Integrated PCB			<b>Max. Antenna Gain:</b> 0.7 dBi		
<b>Operating Mode:</b> Uncorrelated			<b>Signal State:</b> Modulated		
<b>Ambient Temp.:</b> 23 °C			<b>Relative Humidity:</b> 44%		
<b>USB Wireless Audio Transmitter</b>					
Frequency (MHz)	Limit [dBm]	Output [dBm]	Duty Cycle [dB]	$\Sigma$ Power [dBm]	Margin [dB]
1 Mbps Data Rate					
2402	+30.00	5.95			-24.05
2442	+30.00	5.19			-24.81
2480	+30.00	4.87			-25.13
2 Mbps Data Rate					
2402	+30.00	6.42			-23.58
2442	+30.00	6.15			-23.85
2480	+30.00	5.34			-24.66
<b>Note:</b> The USB Wireless Audio Transmitter transmitted at 100% duty cycle.					





Figure 2: Maximum Transmitted Power, 2402 MHz at 1Mbps



Figure 3: Maximum Conducted Output Power at 2442 MHz at 1Mbps



Figure 4: Maximum Conducted Output Power at 2480 MHz at 1Mbps



Figure 5: Maximum Conducted Output Power at 2402 MHz at 2Mbps



Figure 6: Maximum Conducted Output Power at 2442 MHz at 2Mbps

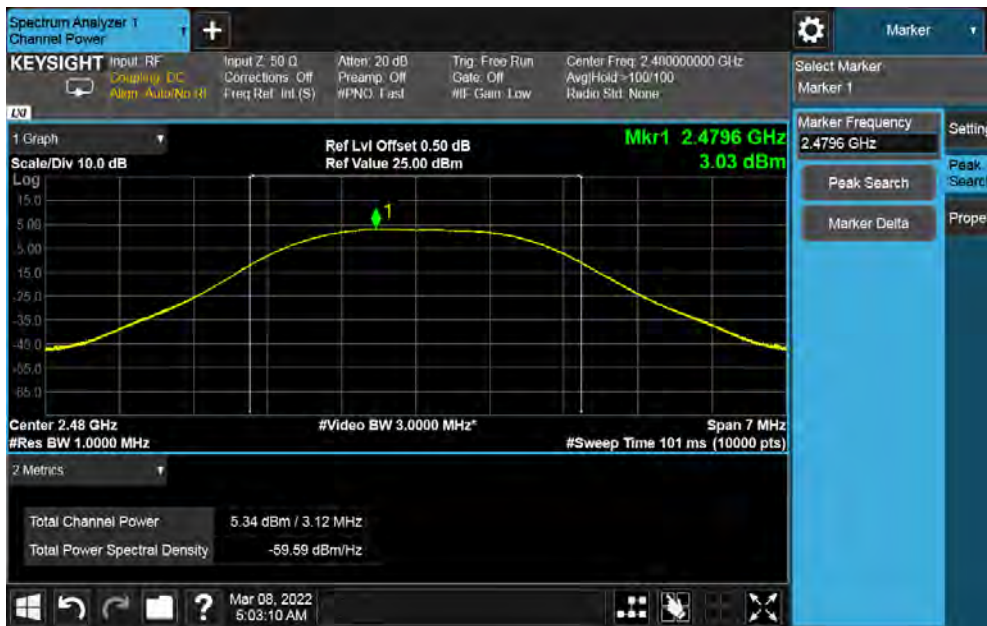

Figure 7: Maximum Conducted Output Power at 2480 MHz at 2Mbps

## 4.2 Occupied Bandwidth

The occupied bandwidth is measured at an amplitude level reduced from the reference level by a specified ratio. The reference level is the level of the highest amplitude signal observed from the transmitter at the fundamental frequency.

The 99% bandwidth is the bandwidth in which 99% of the transmitted power occupied.

The minimum 6 dB bandwidth shall be at least 500 kHz.

The bandwidth shall be at least 500 kHz per Section CFR47 15.247(a2) 2021 and RSS 247 Sect.5.2 (a) 2017

### 4.2.1 Test Method

The conducted method was used to measure the occupied bandwidth according to ANSI C63.10:2013 Section 11.8.1. The measurement was performed with modulation per CFR47 15.247(a) (2) 2021 and RSS 247 Sect. 5.2 (a) 2017. The preliminary investigation was performed to find the narrowest 6 dB bandwidth for each operational mode at different data rates. This worst finding was performed on 3 channels in each operating frequency range; 2400 MHz to 2483.5 MHz. This test was conducted on 3 channels in each mode of Sample S/N PP #1. The worst sample result indicated below.

Test Setup:

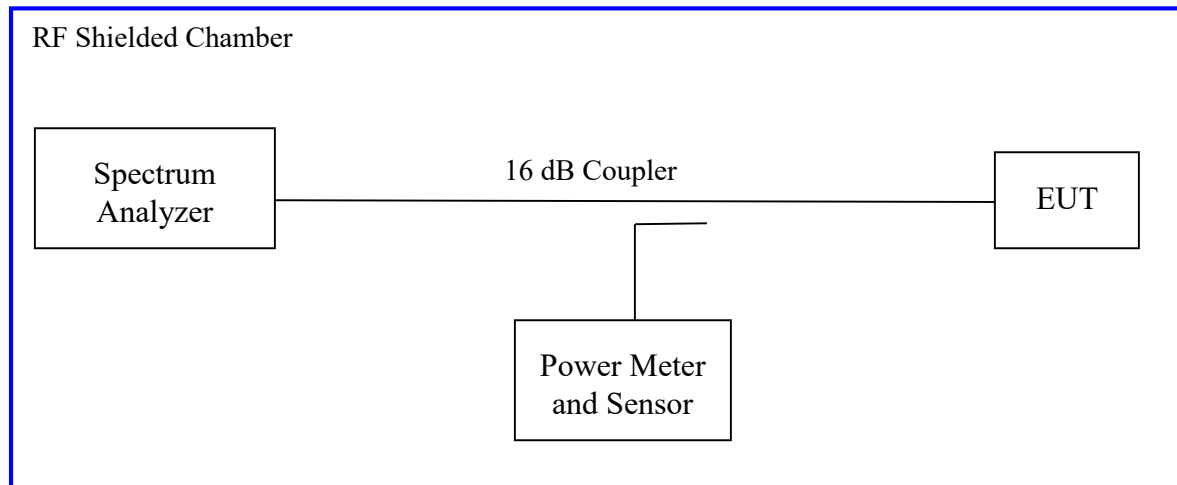

### 4.2.2 Results

As originally tested, the EUT was found to be compliant to the requirements of the test standard(s).



**Table 3: Occupied Bandwidth – Test Results**

<b>Test Date:</b> March 6, 2022			<b>Test By:</b> Abhijit Patibandla		
<b>Test Method:</b> Conducted Measurements			<b>Power Setting:</b> Fixed at 4 dBm		
<b>Antenna Type:</b> Integrated PCB			<b>Max. Antenna Gain:</b> 0.7 dBi		
<b>Operating Mode:</b> Uncorrelated			<b>Signal State:</b> Modulated		
<b>Ambient Temp.:</b> 23 °C			<b>Relative Humidity:</b> 40%		
Bandwidth (MHz) for USB Wireless Audio Transmitter					
Frequency (MHz)	Rate (Mbps)	Limit (kHz)	6 dB Bandwidth (MHz)	99% Bandwidth (MHz)	Results
2402	1	500	0.725	1.039	Pass
2442	1	500	0.725	1.035	Pass
2480	1	500	0.710	1.029	Pass
2402	2	500	1.375	2.051	Pass
2442	2	500	1.365	2.048	Pass
2480	2	500	1.270	2.053	Pass
<b>Note:</b> The bandwidth was measured at 100% duty cycle					

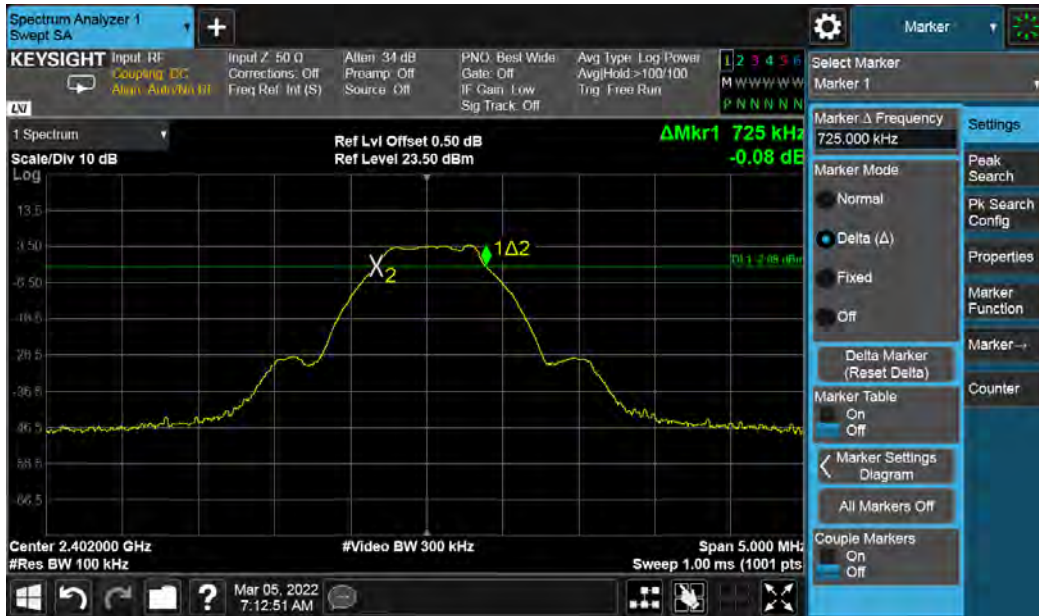

Figure 8: DTS Bandwidth 2402 MHz at 1 Mbps

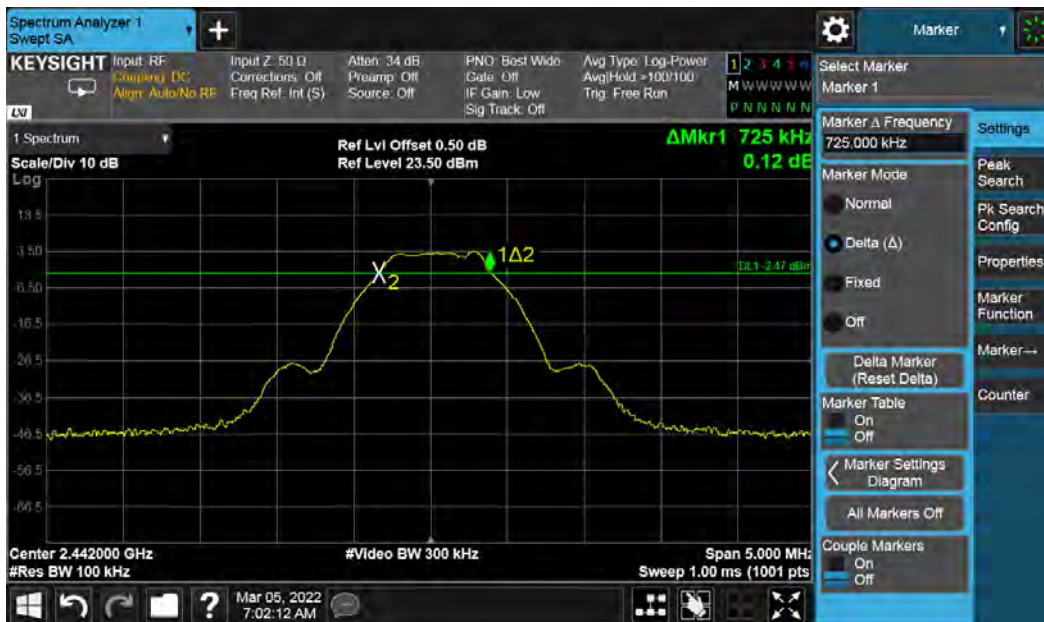

Figure 9: DTS Bandwidth 2442 MHz at 1 Mbps



Figure 10: DTS Bandwidth 2480 MHz at 1 Mbps



Figure 11: 99% Bandwidth 2402 MHz at 1Mbps



Figure 12: 99% Bandwidth 2442 MHz at 1Mbps



Figure 13: 99% Bandwidth 2480 MHz at 1Mbps





Figure 14: DTS Bandwidth 2402 MHz at 2 Mbps



Figure 15: DTS Bandwidth 2442 MHz at 2 Mbps



Figure 16: DTS Bandwidth 2480 MHz at 2 Mbps

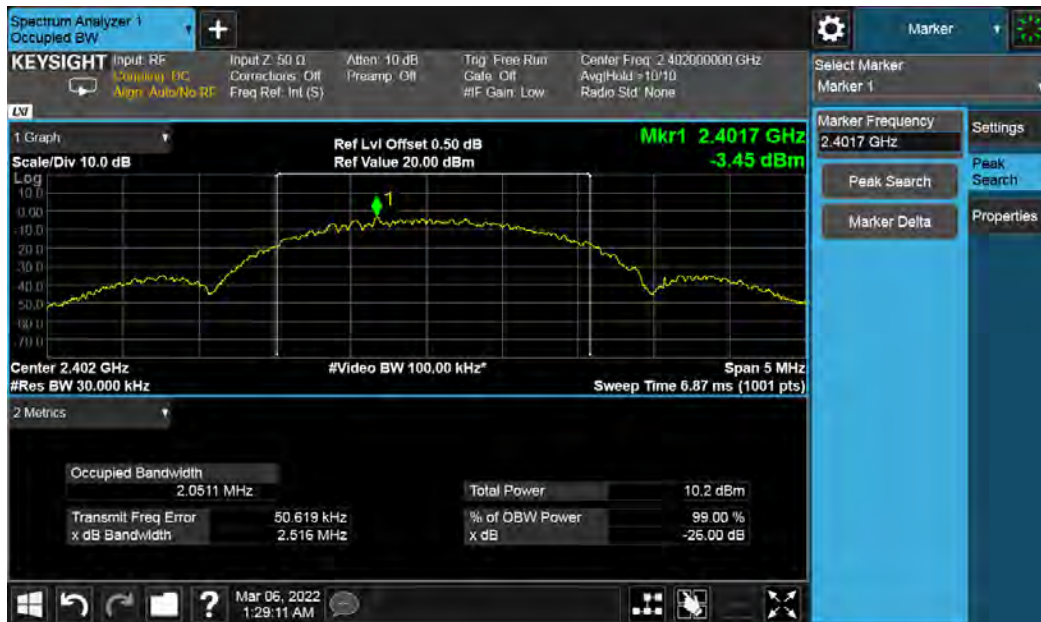

Figure 17: 99% Bandwidth 2402 MHz at 2 Mbps



Figure 18: 99% Bandwidth 2442 MHz at 2 Mbps



Figure 19: 99% Bandwidth 2480 MHz at 2 Mbps

### 4.3 Peak Power Spectral Density

*According to the CFR47 Part 15.247 (e) and RSS 247 Sect.5.2 (b), the power spectral density conducted from the intentional radiator to the antenna shall not be greater than 8 dBm in any 3 kHz band during any time interval of continuous transmission.*

#### 4.3.1 Test Method

The conducted method was used to measure the channel power output per ANSI C63.10-2013 Section 11.10.3. The measurement was performed with modulation per CFR47 Part 15.247 (e) and RSS 247 Sect.5.2 (b). The pre-evaluation was performed to find the worst modes. The worst findings were conducted on 3 channels in each operating frequency range of 2400 MHz to 2483.5 MHz. This test was conducted on 3 channels of Sample SN PP #1. The worst sample result indicated below.

Test Setup:

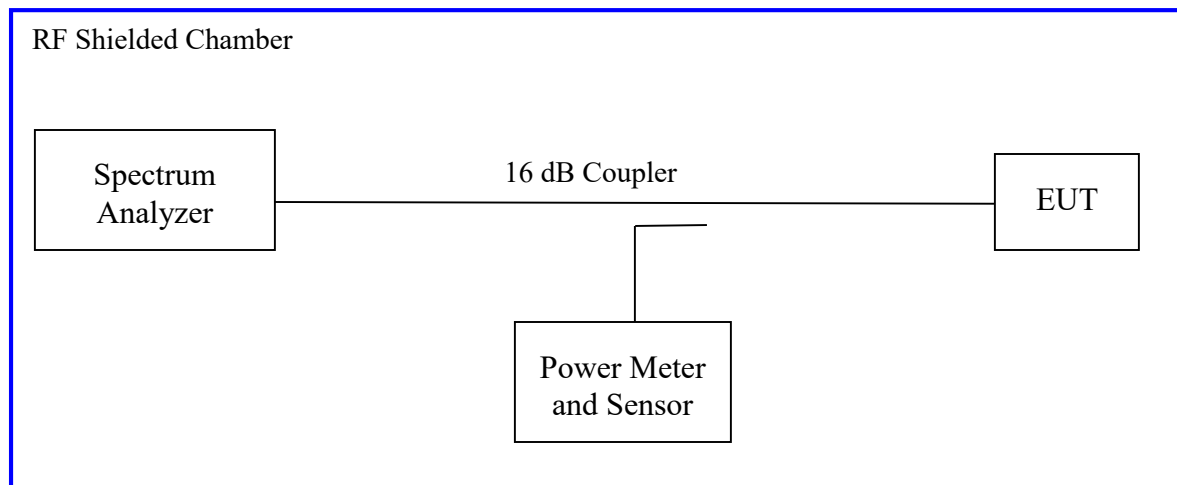

#### 4.3.2 Results

As originally tested, the EUT was found to be compliant to the requirements of the test standard(s).



**Table 4: Peak Power Spectral Density – Test Results**

<b>Test Date:</b> March 8, 2022				<b>Test By:</b> Abhijit Patibandla		
<b>Test Method:</b> Conducted Measurements				<b>Power Setting:</b> Fixed at 4 dBm		
<b>Antenna Type:</b> Integrated PCB				<b>Max. Antenna Gain:</b> 0.7 dBi		
<b>Operating Mode:</b> Uncorrelated				<b>Signal State:</b> Modulated		
<b>Ambient Temp.:</b> 23 °C				<b>Relative Humidity:</b> 44%		
Peak Power Spectral Density						
Freq. (MHz)	Config.	Output [dBm]	CF [dB]	Max. PPSD [dBm]	Limit [dBm]	Margin [dB]
2402	1 Mbps	2.38	-15.23	-12.85	8.00	-20.85
2442	1 Mbps	2.14	-15.23	-13.09	8.00	-21.09
2480	1 Mbps	1.58	-15.23	-13.65	8.00	-21.65
2402	2 Mbps	0.01	-15.23	-15.22	8.00	-23.22
2442	2 Mbps	-0.23	-15.23	-15.46	8.00	-23.46
2480	2 Mbps	-0.78	-15.23	-16.01	8.00	-24.01
<p><b>Note:</b> CF accounted for the measured RBW and duty cycle correction.          The bandwidth ratio is <math>10 \cdot \log(3\text{kHz}/100\text{kHz})</math> or -15.23 dB.          Since the USB Wireless Audio Transmitter transmitted at 100% duty cycle, the final correction factor is -15.23 dB.</p>						



Figure 20: Maximum Power Spectral Density-2402 MHz at 1 Mbps

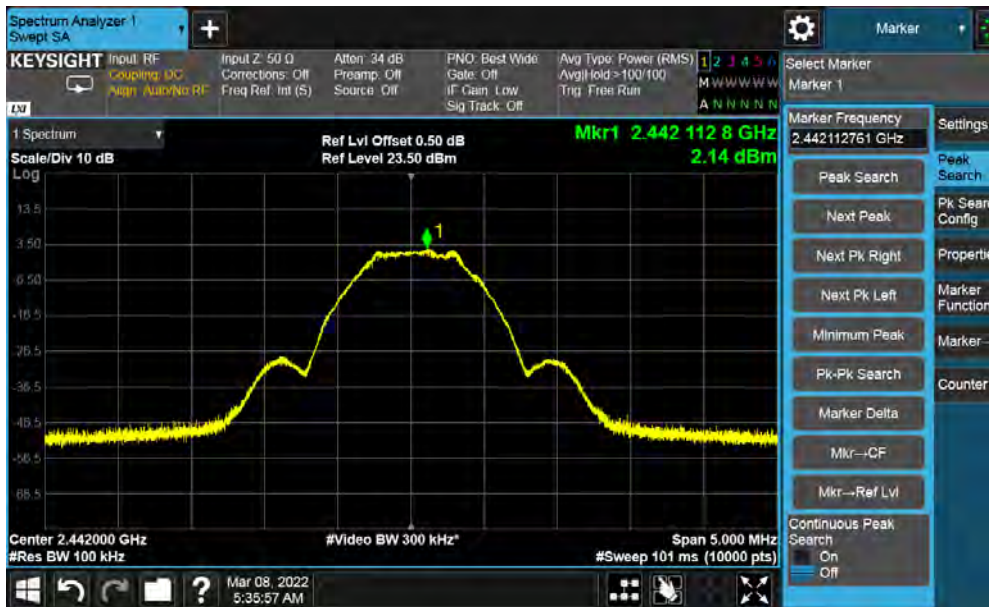

Figure 21: Maximum Power Spectral Density-2442 MHz at 1 Mbps

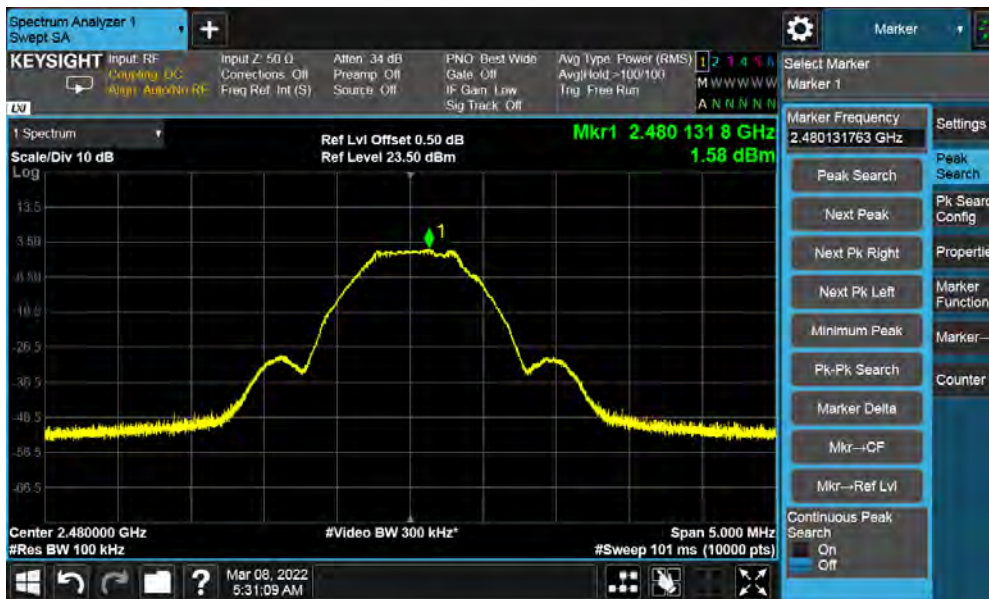

Figure 22: Maximum Power Spectral Density-2480 MHz at 1 Mbps

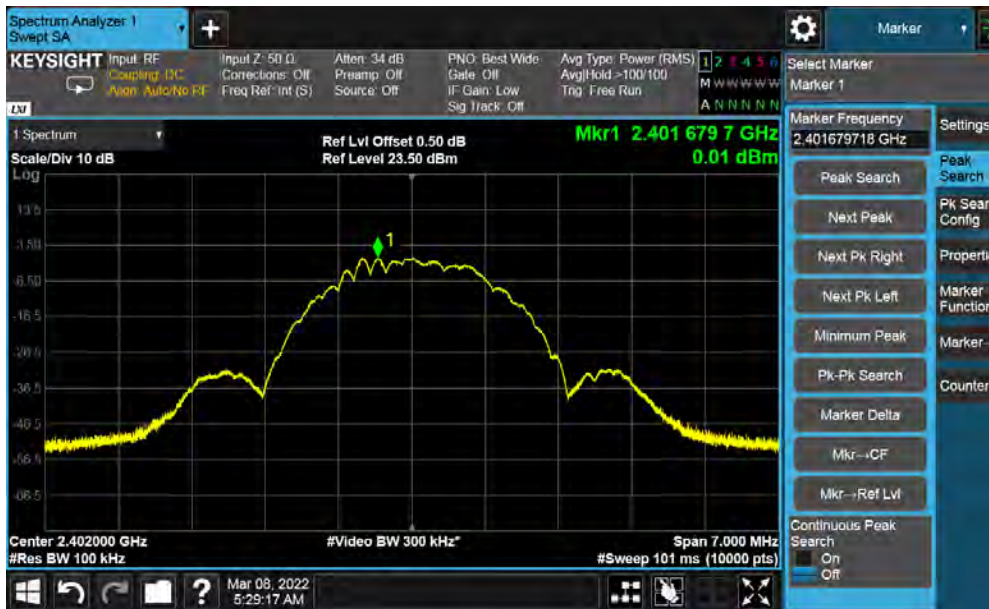

Figure 23: Maximum Power Spectral Density-2402 MHz at 2 Mbps





Figure 24: Maximum Power Spectral Density-2442 MHz at 2 Mbps



Figure 25: Maximum Power Spectral Density-2480 MHz at 2 Mbps



#### 4.4 Out of Band Emissions

The setup was identical to RF output power measurement. Intentional radiators operating under the alternative provisions to the general emission limits, must be designed to ensure that the 20 dB or 30 dB bandwidth of the emission, or whatever bandwidth may otherwise be specified in the specific rule section under which the equipment operates, is contained within the frequency band designated in the rule section under which the equipment is operated. The requirement to contain the designated bandwidth of the emission within the specified frequency band includes the effects from frequency sweeping, frequency hopping and other modulation techniques that may be employed as well as the frequency stability of the transmitter over expected variations in temperature and supply voltage. If the frequency stability is not specified in the regulations, it is recommended that the fundamental emission be kept within at least the central 80% of the permitted band in order to minimize the possibility of out-of-band operation.

*Since the transmitter complies with the conducted power limits base on the use of RMS averaging per CFR47 Part 15.247(b)(3), any frequency outside the band of 2400MHz to 2483.5MHz, the power output level must be below 30db from the in-band transmitting signal; CFR 47 Part 15.215, 15.247(d) and RSS-247 Sect.5.5..*

##### 4.4.1 Test Method

The conducted method was used to measure the out-of-band emission requirement. The measurement was performed with modulation per CFR47 15.247(4) (d) 2021 and RSS-247 Sect.5.5: 2017. This test was conducted on 3 channels of Sample S/N PP #1. The worst sample result indicated below.

Test Setup:

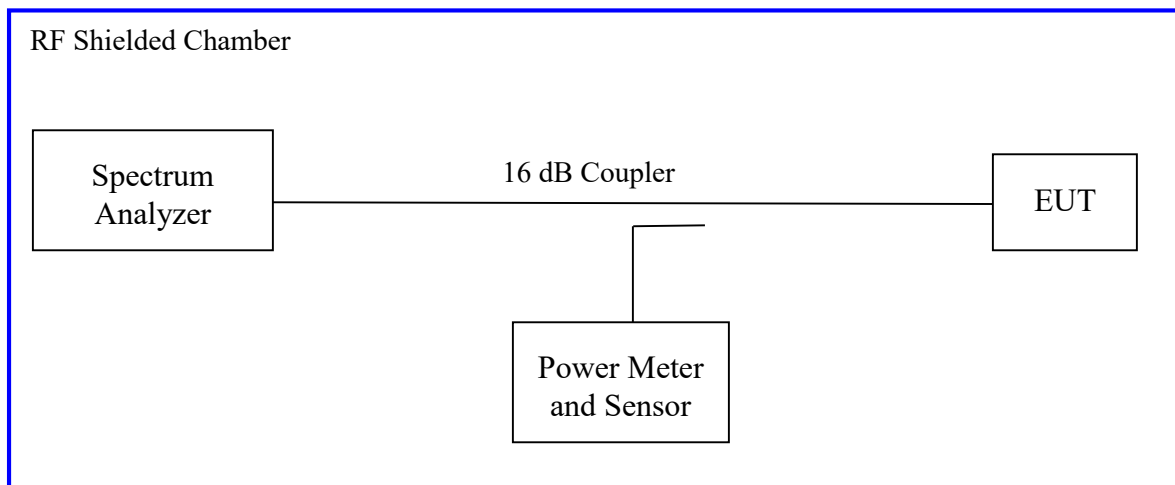

#### 4.4.2 Results

As originally tested, the EUT was found to be compliant to the requirements of the test standard(s).

**Table 5: Out of Band Emissions – Test Results**

<b>Test Date:</b> March 8, 2022		<b>Test By:</b> Abhijit Patibandla		
<b>Test Method:</b> Conducted Measurements		<b>Power Setting:</b> Fixed at 4 dBm		
<b>Antenna Type:</b> Integrated PCB		<b>Max. Antenna Gain:</b> 0.7 dBi		
<b>Operating Mode:</b> Uncorrelated		<b>Signal State:</b> Modulated		
<b>Ambient Temp.:</b> 23 °C		<b>Relative Humidity:</b> 44%		
Out of Band Results for USB Wireless Audio Transmitter				
Frequency (MHz)	Rate (Mbps)	Out of Band Level (dBm)	30 dBc Level (dBm)	Margin (dB)
2402	1	-46.22	-26.06	-20.16
2442	1	-45.63	-26.41	-19.22
2480	1	-47.04	-27.13	-19.91
2402	2	-49.52	-27.93	-21.59
2442	2	-47.85	-26.38	-21.47
2480	2	-33.19	-28.80	-4.39
<p>Note: dBc is defined as the level below the main carrier.          The band-edge level must be lower than the 30 dBc level.          The maximum out of band emission on each individual output is at least 30 dB below the maximum in-band PSD on that output.          (*) The band-edge is compared to the highest -30 dBc level of the test mode.</p>				



Figure 26: Conducted Band Edge - 2402 MHz at 1 Mbps



Figure 27: Out of band Emission - 2402 MHz at 1 Mbps



Figure 28: Conducted Band Edge - 2442 MHz at 1 Mbps



Figure 29: Out of band Emission - 2442 MHz at 1 Mbps





Figure 30: Conducted Band Edge - 2480 MHz at 1 Mbps

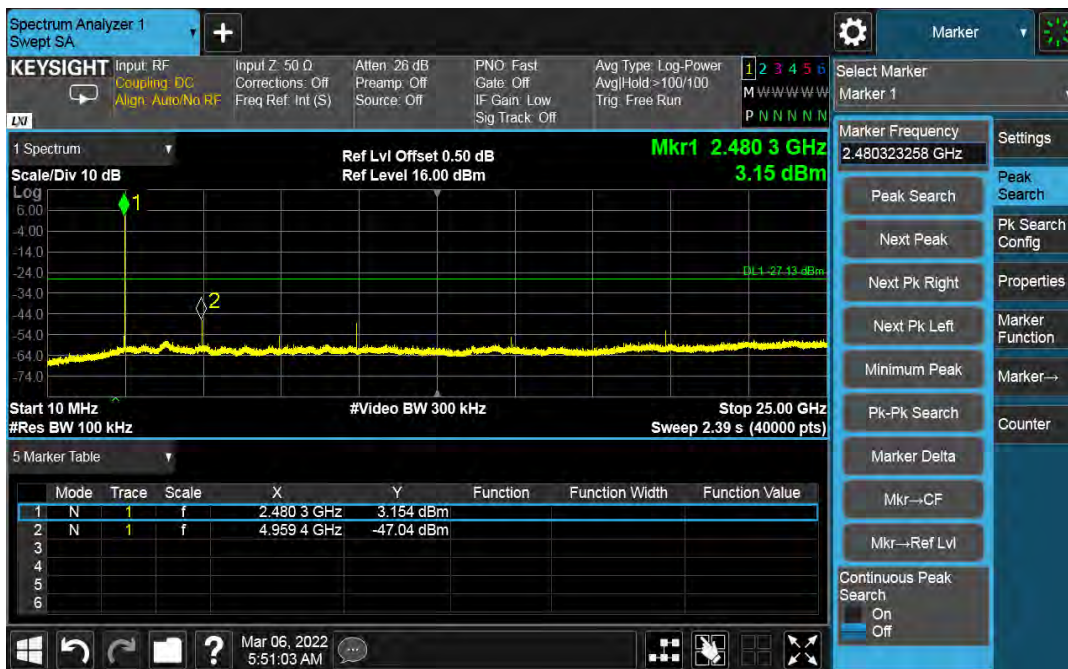

Figure 31: Out of band Emission - 2480 MHz at 1 Mbps



Figure 32: Conducted Band Edge - 2402 MHz at 2 Mbps



Figure 33: Out of band Emission - 2402 MHz at 2 Mbps





Figure 34: Conducted Band Edge - 2442 MHz at 2 Mbps



Figure 35: Out of band Emission - 2442 MHz at 2 Mbps



Figure 36: Conducted Band Edge - 2480 MHz at 2 Mbps



Figure 37: Out of band Emission - 2480 MHz at 2 Mbps



## **4.5 Transmit Spurious Emissions**

*Transmitter spurious emissions are emissions outside the frequency range of the equipment when the equipment is in transmit mode; per requirement of CFR47 15.205, 15.209, 15.247(d), RSS-Gen Sect. 8.9.*

### **4.5.1 Test Methodology**

#### **4.5.1.1 Preliminary Test**

A test program that controls instrumentation and data logging was used to automate the preliminary RF emission test procedure. The frequency range of interest was divided into sub-ranges to yield a frequency resolution of approximately 120 kHz and provide a reading at each frequency for no more than 12° of turntable rotation. For each frequency sub-range the turntable was rotated 360° while peak emission data was recorded and plotted over the frequency range of interest in horizontal and vertical antenna polarization's.

Preliminary emission profile testing was performed inside the anechoic chamber. The EUT was placed on a 1.0m x 1.5m non-conductive table 80cm (<1 GHz) and 150cm (>1 GHz) above the floor. The EUT was positioned as shown in the setup photographs. The receiving antenna was placed at a distance of 3m at a fixed height of 1m. Measurement equipment was located outside of the chamber. A video camera was placed inside the chamber to view the EUT.

Pres-scans were performed to determine the worst case configuration for data rate.

#### **4.5.1.2 Final Test**

For each frequency measured, the peak emission was maximized by manipulating the receiving antenna from 1 to 4 meters above the ground plane and placing it at the position that produced the maximum signal strength reading. The turntable was then rotated through 360° while observing the peak signal and placing the EUT at the position that produced maximum radiation. The six highest emissions relative to the limit were measured unless such emissions were more than 20 dB below the limit. If less than six emissions are within 20 dB of the limit, than the noise level of the receiver is measured at frequencies where emissions are expected. Multiples of all oscillator and microprocessor frequencies were also checked.

Final testing was performed on an NSA compliant test site. The EUT was placed on a 1.0m x 1.5m non-conductive table 80cm (<1 GHz) and 150cm (>1 GHz) above the ground plane. The placement of EUT and cables were the same as for preliminary testing and is shown in the setup photographs.

The final scans performed on the worst axis, Y-Axis up, for three operating channels in each operating mode;

2402 MHz, 2442 MHz, and 2480 MHz

#### **4.5.1.3 Deviations**

None.

**Test Setup:**

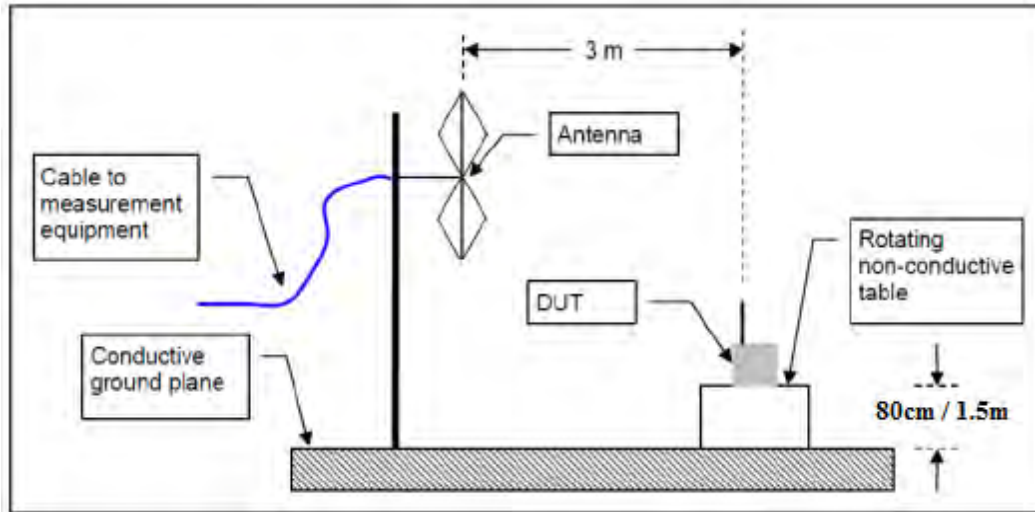

**4.5.2 Transmitter Spurious Emission Limit**

The spurious emissions of the transmitter shall not exceed the values in CFR47 Part 15.205, 15.209: 2021 and RSS Gen Sect. 8.10: 2019.

Frequency (MHz)	Field strength (microvolts/meter)	Measurement distance (meters)
0.009-0.490	2400/F (kHz)	300
0.490-1.705	24000/F (kHz)	30
1.705-30.0	30	30
30-88	100 **	3
88-216	150 **	3
216-960	200 **	3
Above 960	500	3

All harmonics and spurious emission which are outside of the restricted band shall be 20dB below the in-band emission.

**4.5.3 Test Results**

The final measurement data was taken under the worst case operating modes, configurations, and/or cable positions. It also reflects the results including any modifications and/or special accessories listed in Sections 1.4 and test plan.

As originally tested, the EUT was found to be compliant to the requirements of the test standard(s).

**Table 6: Transmit Spurious Emissions at Band-Edge Requirements**

<b>Test Date:</b> March 20, 2022								<b>Test By:</b> Abhijit Patibandla						
<b>Test Method:</b> Conducted Measurements								<b>Power Setting:</b> Fixed at 4 dBm						
<b>Antenna Type:</b> Integrated PCB								<b>Max. Antenna Gain:</b> 0.7 dBi						
<b>Operating Mode:</b> Uncorrelated								<b>Signal State:</b> Modulated						
<b>Ambient Temp.:</b> 23 °C								<b>Relative Humidity:</b> 44%						
<b>Band-Edge Results</b>														
<b>Antenna Polarity &amp; Test Distance: Vertical and Horizontal at 3m</b>														
No.	Frequency (MHz)	Pol (H/V)	Reading AV (dBuV/m)	Reading PK (dBuV/m)	Factor (dB)	Level AV (dBuV/m)	Level PK (dB(uV/m))	Limit AV (dBuV/m)	Limit PK (dBuV/m)	Margin AV (dB)	Margin PK (dB)	Hght (cm)	Angle (Deg)	Pass/Fail
1	2390.02	H	-1.00	12.40	32.90	31.90	45.30	54.00	74.00	-22.10	-28.70	137	210	Pass
2	2402.05	H	63.20	65.40	33.00	96.20	98.40	54.00	74.00			110	231	N/A*
3	2402.05	V	61.30	63.40	33.00	94.30	96.40	54.00	74.00			222	195	N/A*
4	2390.02	V	-0.30	13.30	32.90	32.60	46.20	54.00	74.00	-21.40	-27.80	127	211	Pass
5	2480.30	H	62.20	65.30	33.30	95.50	98.60	54.00	74.00			100	231	N/A*
6	2483.64	H	8.80	22.80	33.30	42.10	56.10	54.00	74.00	-11.90	-17.90	100	231	Pass
7	2480.30	V	60.50	63.70	33.30	93.80	97.00	54.00	74.00			167	236	N/A*
8	2483.64	V	7.70	21.30	33.30	41.00	54.60	54.00	74.00	-13.00	-19.40	166	235	Pass
<p>Note: The emissions were measured at the adjacent restricted band of the fundamental signal.          All the band-edge measurements met the restricted band requirements of CFR47 15.205          Band-edge measurement plots use a wider span than 2 MHz to evaluate additional spectrum bands for in-band leakage and spurious emission.</p> <p>(*) Fundamental/ Inband emission.</p> <p>Emission level (dBuV/m) = Reading Value (dBuV) + Factor (dB)          AF (dB/m) = Antenna Factor (dB/m) – Preamplifier Gain (dB).          Margin value = Emission level – Limit value.</p>														

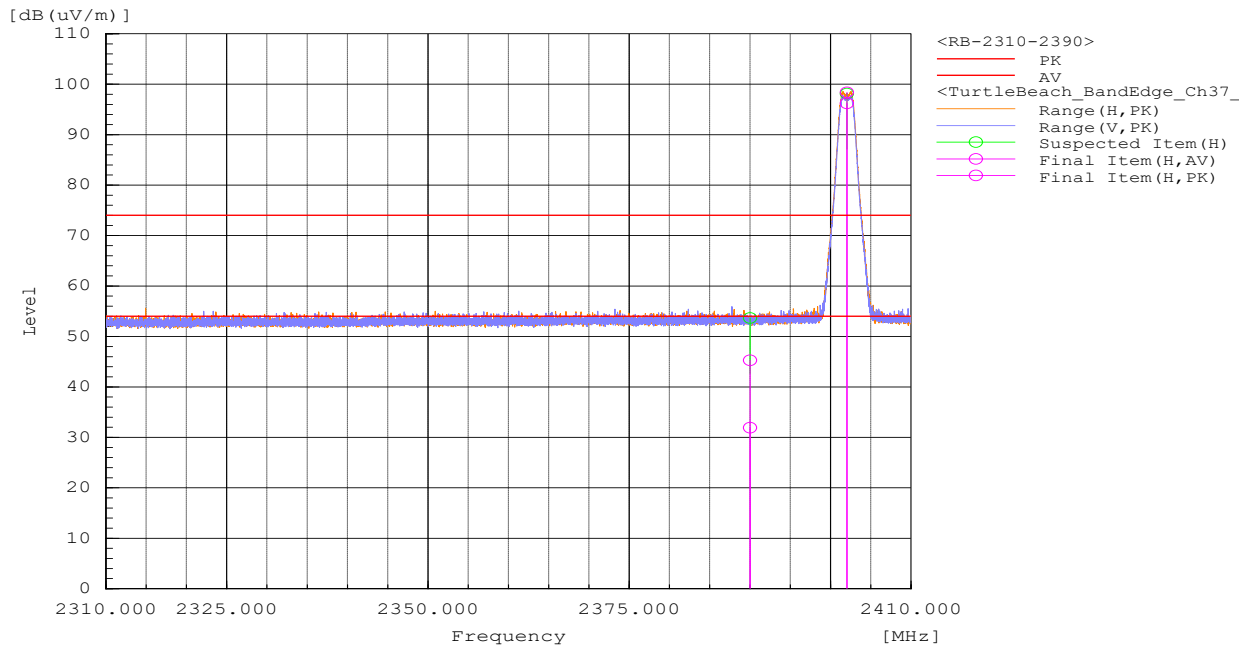

Figure 38: Band-edge-2402 MHz

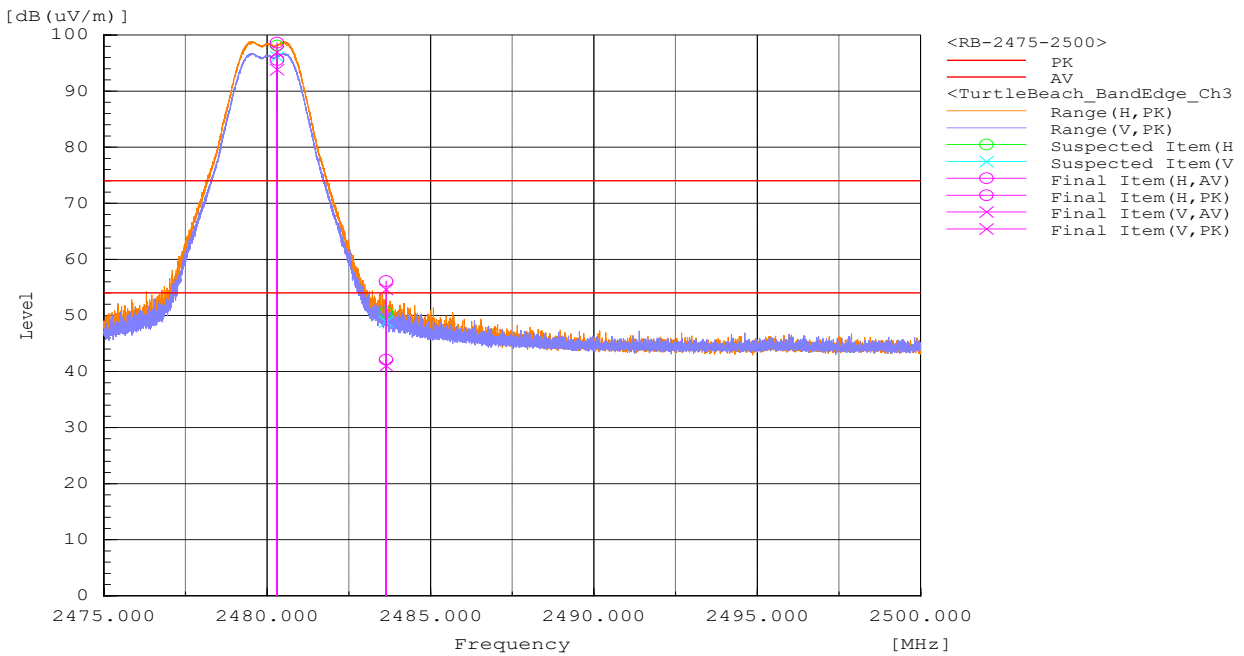

Figure 39: Band-edge-2480 MHz

Note: Blue Trace = Vertical Polarization; Red Trace = Horizontal Polarization

Radiated Emissions										Page 1 of 6	
<b>EUT Name</b>	USB Wireless Audio Transmitter					<b>Date</b>	03/19/2022				
<b>EUT Model</b>	Stealth700P-MAX-TX					<b>Temp / Hum in</b>	23°C / 42% RH				
<b>EUT Serial</b>	PP #2					<b>Temp / Hum out</b>	N/A				
<b>EUT Config.</b>	EUT on Vertical Position					<b>Line AC / Freq</b>	5.0 VDC				
<b>Standard</b>	CFR47 Part 15 Subpart C					<b>RBW / VBW</b>	120 kHz/ 300 kHz				
<b>Dist/Ant Used</b>	3m / JB6 & AL-130R					<b>Performed by</b>	Abhijit Patibandla				
Freq.	Raw	Corrd'	Level	Det.	Pol.	Hght.	Azt	Limit	Margin	Result	
MHz	dBuV/m	dB	dBuV/m		H/V	cm	deg	dBuV/m	dB		
9 kHz to 1 GHz, Transmitted Data at 2402 MHz											
88.64	7.60	14.10	21.70	QP	V	282	268	43.50	-21.80	Pass	
114.28	-9.50	18.70	9.20	QP	H	219	152	43.50	-34.30	Pass	
207.59	-8.50	17.50	9.00	QP	V	205	316	43.50	-34.50	Pass	
351.77	-8.40	21.90	13.50	QP	H	325	296	46.00	-32.50	Pass	
531.12	-7.40	25.80	18.40	QP	H	119	207	46.00	-27.60	Pass	
712.56	-3.40	28.80	25.40	QP	V	230	0	46.00	-20.60	Pass	
Spec Margin = Level - Limit, Level = Raw+ Cbl+ CF ± Uncertainty											
CF= Amp Gain + ANT Factor											
Combined Standard Uncertainty $u_c(y) = \pm 3.51$ dB Expanded Uncertainty $U = ku_c(y)$ $k = 2$ for 95% confidence											
<b>Note:</b> The worst case emission was observed on Channel 2402 MHz.											
There was no significant emission observed from 9 kHz to 30 MHz.											



Radiated Emissions										Page 2 of 6
<b>EUT Name</b>		USB Wireless Audio Transmitter					<b>Date</b>		03/19/2022	
<b>EUT Model</b>		Stealth700P-MAX-TX					<b>Temp / Hum in</b>		23°C / 42% RH	
<b>EUT Serial</b>		PP #2					<b>Temp / Hum out</b>		N/A	
<b>EUT Config.</b>		EUT on Vertical Position					<b>Line AC / Freq</b>		5.0 VDC	
<b>Standard</b>		CFR47 Part 15 Subpart C					<b>RBW / VBW</b>		1 MHz / 3 MHz	
<b>Dist/Ant Used</b>		3m / 3117, 1m / SAS-574					<b>Performed by</b>		Abhijit Patibandla	
Freq	Raw	Corrd'	Level	Det	Pol	Hght	Azt	Limit	Margin	Comment
MHz	dBuV/m	dB	dBuV/m		H/V	cm	deg	dBuV/m	dB	
Transmitted Data at 2402 MHz										
2127.75	62.60	-13.80	48.80	Pk	V	258	178	74.00	-25.20	Spurious
2127.75	45.60	-13.80	31.80	Ave	V	258	178	54.00	-22.20	Spurious
3192.01	55.70	-12.50	43.20	Pk	V	289	57	74.00	-30.80	Spurious
3192.01	40.10	-12.50	27.60	Ave	V	289	57	54.00	-26.40	Spurious
5173.78	55.70	-11.30	44.40	Pk	V	235	166	74.00	-29.60	Spurious
5173.78	38.30	-11.30	27.00	Ave	V	235	166	54.00	-27.00	Spurious
9607.29	55.60	-1.90	53.70	Pk	V	180	6	74.00	-20.30	Harmonics
9607.29	49.30	-1.90	47.40	Ave	V	180	6	54.00	-6.60	Harmonics
16701.19	40.20	7.60	47.80	Pk	V	362	320	74.00	-26.20	Spurious
16701.19	29.00	7.60	36.60	Ave	V	362	320	54.00	-17.40	Spurious
9607.40	51.30	-1.90	49.40	Pk	H	191	7	74.00	-24.60	Harmonics
9607.40	44.90	-1.90	43.00	Ave	H	191	7	54.00	-11.00	Harmonics
16716.19	40.50	7.60	48.10	Pk	H	236	359	74.00	-25.90	Spurious
16716.19	28.70	7.60	36.30	Ave	H	236	359	54.00	-17.70	Spurious
Transmitted Data at 2442 MHz										
3185.26	58.70	-12.60	46.10	Pk	V	158	171	74.00	-27.90	Spurious
3185.26	39.60	-12.60	27.00	Ave	V	158	171	54.00	-27.00	Spurious
3541.10	51.60	-12.60	39.00	Pk	V	235	298	74.00	-35.00	Spurious
3541.10	40.00	-12.60	27.40	Ave	V	235	298	54.00	-26.60	Spurious
5180.89	55.30	-11.30	44.00	Pk	V	400	237	74.00	-30.00	Spurious
5180.89	37.90	-11.30	26.60	Ave	V	400	237	54.00	-27.40	Spurious
6970.95	50.90	-7.00	43.90	Pk	V	247	320	74.00	-30.10	Spurious
6970.95	34.50	-7.00	27.50	Ave	V	247	320	54.00	-26.50	Spurious
9769.12	53.80	-1.50	52.30	Pk	V	181	311	74.00	-21.70	Harmonics
9769.12	47.60	-1.50	46.10	Ave	V	181	311	54.00	-7.90	Harmonics
16743.02	40.50	7.60	48.10	Pk	V	312	18	74.00	-25.90	Spurious
16743.02	29.10	7.60	36.70	Ave	V	312	18	54.00	-17.30	Spurious
9767.26	50.90	-1.50	49.40	Pk	H	170	1	74.00	-24.60	Harmonics
9767.26	45.20	-1.50	43.70	Ave	H	170	1	54.00	-10.30	Harmonics
16688.72	39.80	7.50	47.30	Pk	H	122	360	74.00	-26.70	Spurious
16688.72	28.30	7.50	35.80	Ave	H	122	360	54.00	-18.20	Spurious
Transmitted Data at 2480 MHz										
3196.40	57.00	-12.50	44.50	Pk	V	278	0	74.00	-29.50	Spurious

3196.40	39.70	-12.50	27.20	Ave	V	278	0	54.00	-26.80	Spurious
5173.69	51.20	-11.30	39.90	Pk	V	378	59	74.00	-34.10	Spurious
5173.69	37.40	-11.30	26.10	Ave	V	378	59	54.00	-27.90	Spurious
5183.51	59.00	-11.30	47.70	Pk	V	246	40	74.00	-26.30	Spurious
5183.51	36.90	-11.30	25.60	Ave	V	246	40	54.00	-28.40	Spurious
9920.93	52.20	-1.30	50.90	Pk	V	148	0	74.00	-23.10	Harmonics
9920.93	46.40	-1.30	45.10	Ave	V	148	0	54.00	-8.90	Harmonics
16722.35	39.60	7.60	47.20	Pk	V	101	274	74.00	-26.80	Spurious
16722.35	27.30	7.60	34.90	Ave	V	101	274	54.00	-19.10	Spurious
16764.53	40.30	7.60	47.90	Pk	H	396	5	74.00	-26.10	Spurious
16764.53	29.10	7.60	36.70	Ave	H	396	5	54.00	-17.30	Spurious
Spec Margin = Level - Limit, Level = Raw+ Cbl+ CF ± Uncertainty										
CF= Amp Gain + ANT Factor										
Combined Standard Uncertainty $u_c(y) = \pm 4.91\text{dB}$ Expanded Uncertainty $U = ku_c(y)$ $k = 2$ for 95% confidence										
Notes: All emissions passed the spurious emission limit.										
(*) Non-restricted band emission										

**Radiated Emissions**

<b>EUT Name</b>	USB Wireless Audio Transmitter	<b>Date</b>	03/19/2022
<b>EUT Model</b>	Stealth700P-MAX-TX	<b>Temp / Hum in</b>	23°C / 42% RH
<b>EUT Serial</b>	PP #2	<b>Temp / Hum out</b>	N/A
<b>EUT Config.</b>	EUT on Vertical Position	<b>Line AC / Freq</b>	5.0 VDC
<b>Standard</b>	CFR47 Part 15 Subpart C	<b>RBW / VBW</b>	120 kHz / 300 kHz
<b>Dist/Ant Used</b>	3m / JB3 & AL-130R	<b>Date</b>	Abhijit Patibandla

9 kHz to 1000 MHz Plot for Transmit Mode at 2402 MHz

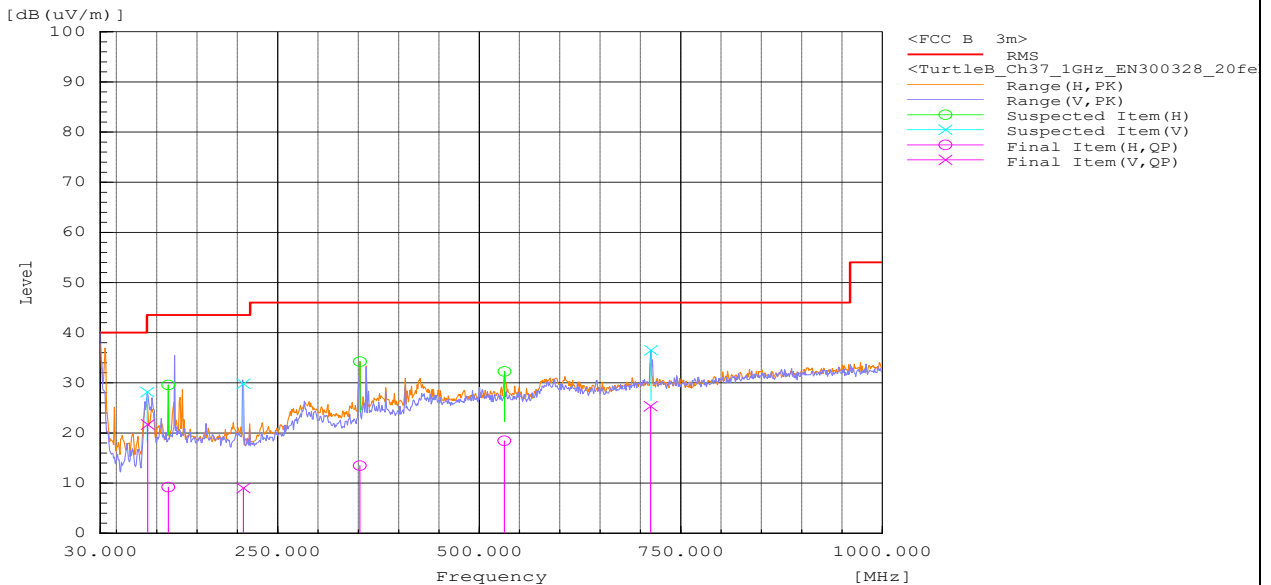
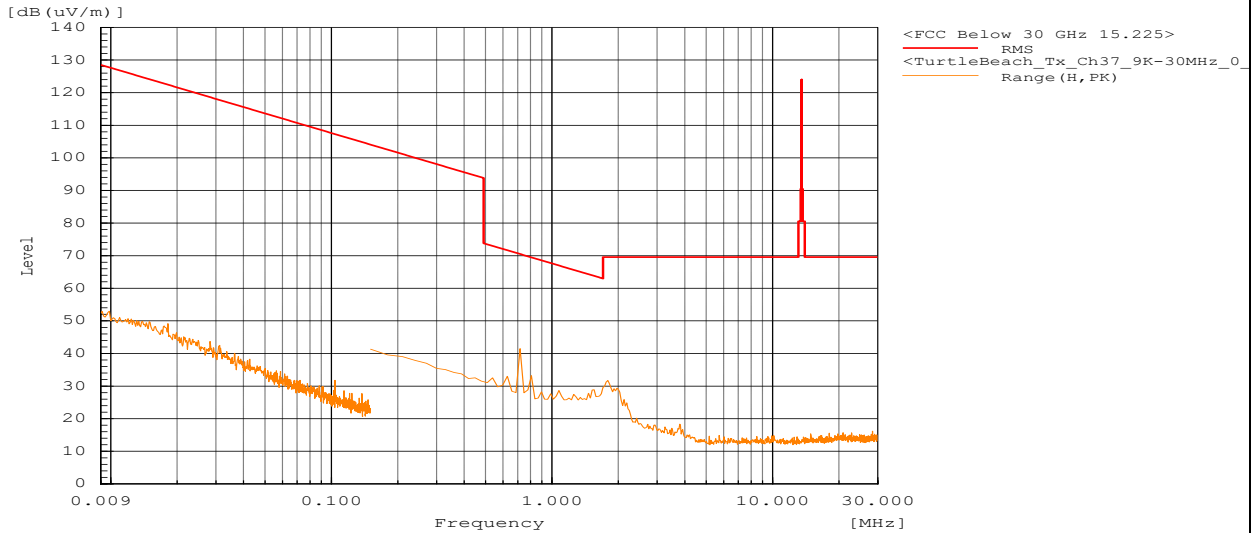

Notes: None.

Radiated Emissions

<b>EUT Name</b>	USB Wireless Audio Transmitter	<b>Date</b>	03/19/2022
<b>EUT Model</b>	Stealth700P-MAX-TX	<b>Temp / Hum in</b>	23°C / 42% RH
<b>EUT Serial</b>	PP #2	<b>Temp / Hum out</b>	N/A
<b>EUT Config.</b>	EUT on Vertical Position	<b>Line AC / Freq</b>	5.0 VDC
<b>Standard</b>	CFR47 Part 15 Subpart C	<b>RBW / VBW</b>	1 MHz / 3 MHz
<b>Dist/Ant Used</b>	3m / 3117, 1m / SAS-574	<b>Performed by</b>	Abhijit Patibandla

Above 1 GHz Plots for Transmit Mode at 2402 MHz

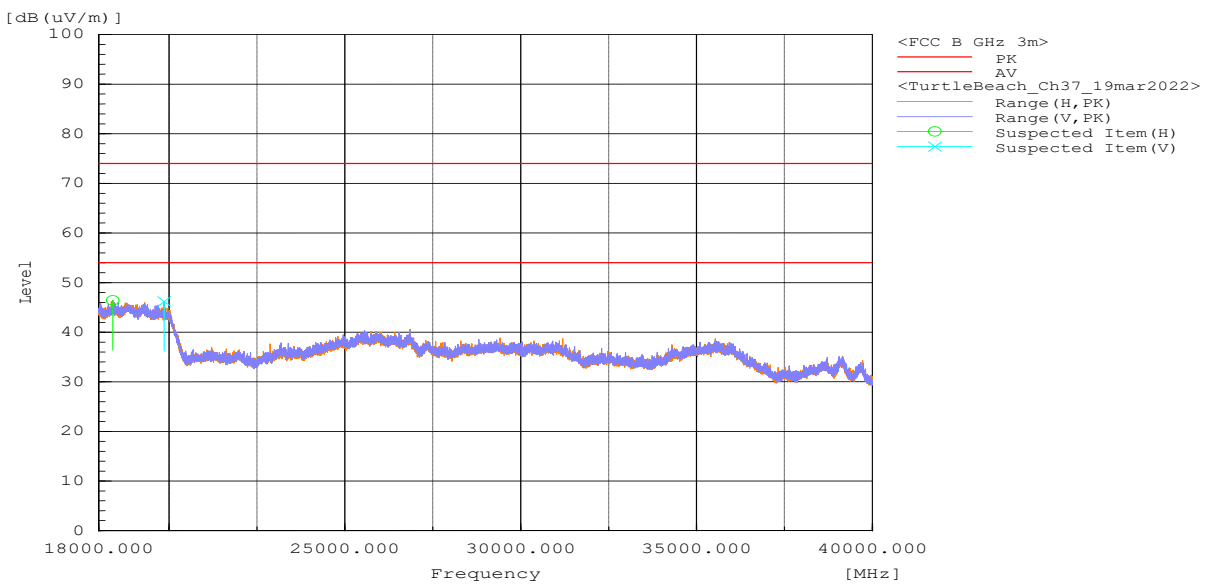
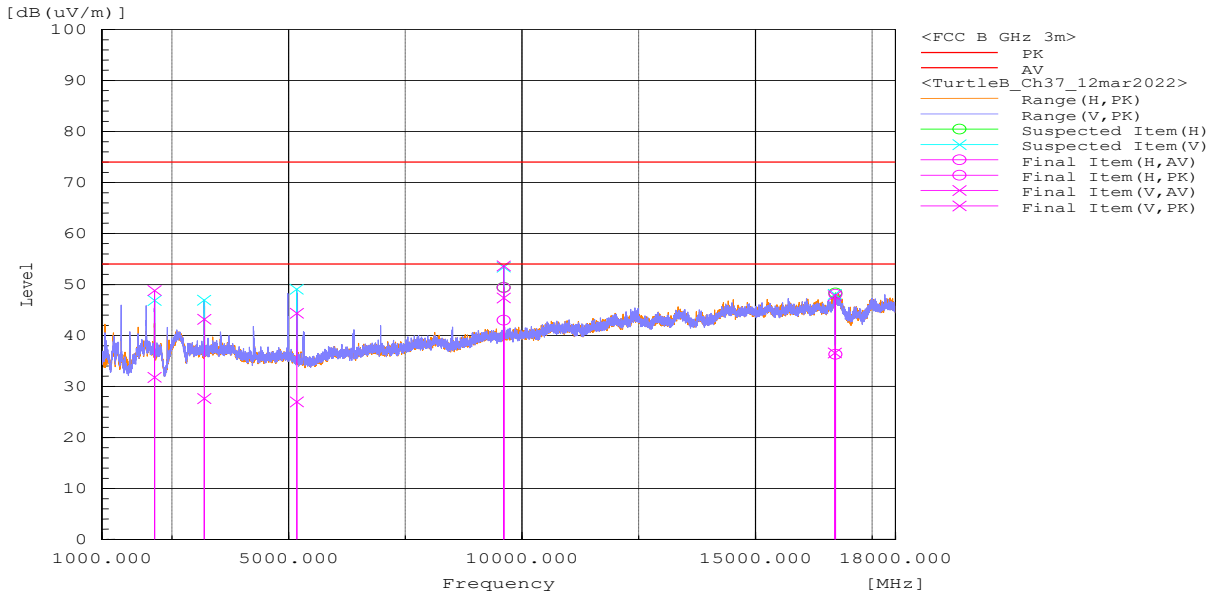

Notes: There was no emission observed from 18 GHz to 26 GHz.

Radiated Emissions

<b>EUT Name</b>	USB Wireless Audio Transmitter	<b>Date</b>	03/19/2022
<b>EUT Model</b>	Stealth700P-MAX-TX	<b>Temp / Hum in</b>	23°C / 42% RH
<b>EUT Serial</b>	PP #2	<b>Temp / Hum out</b>	N/A
<b>EUT Config.</b>	EUT on Vertical Position	<b>Line AC / Freq</b>	5.0 VDC
<b>Standard</b>	CFR47 Part 15 Subpart C	<b>RBW / VBW</b>	1 MHz / 3 MHz
<b>Dist/Ant Used</b>	3m / 3117, 1m / SAS-574	<b>Performed by</b>	Abhijit Patibandla

Above 1 GHz Plots for Transmit Mode at 2442 MHz

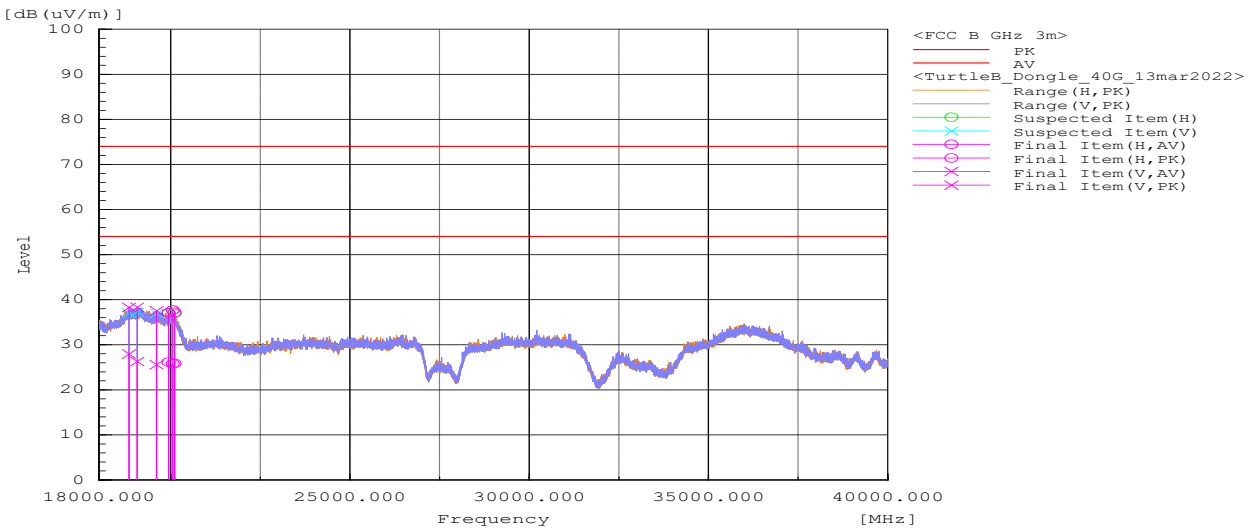
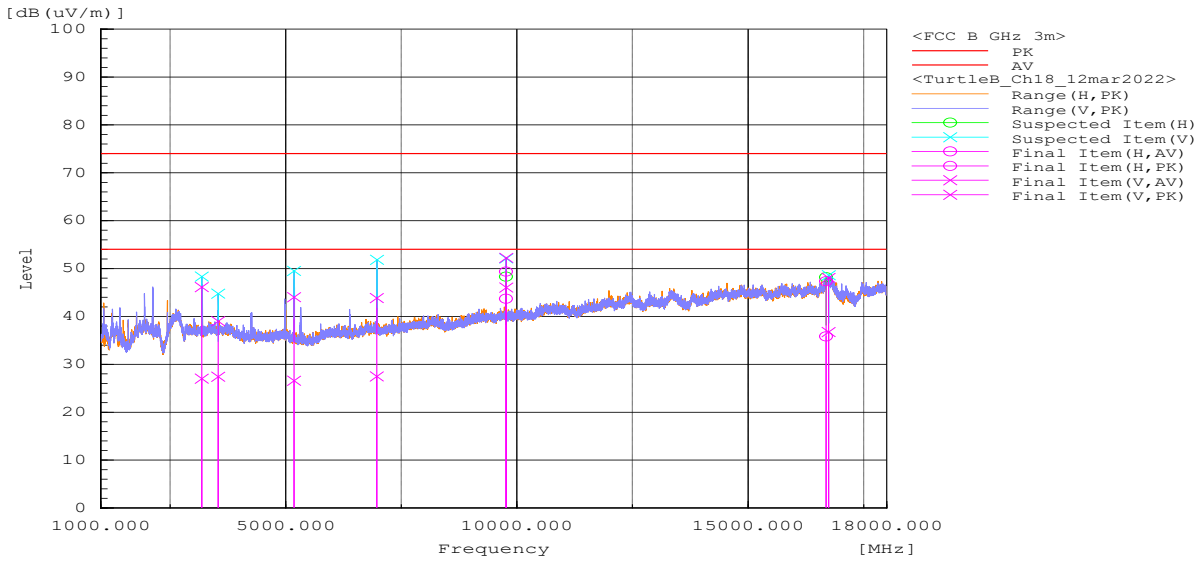

Notes: There was no emission observed from 18 GHz to 26 GHz.



Radiated Emissions

<b>EUT Name</b>	USB Wireless Audio Transmitter	<b>Date</b>	03/20/2022
<b>EUT Model</b>	Stealth700P-MAX-TX	<b>Temp / Hum in</b>	23°C / 42% RH
<b>EUT Serial</b>	PP #2	<b>Temp / Hum out</b>	N/A
<b>EUT Config.</b>	EUT on Vertical Position	<b>Line AC / Freq</b>	5.0 VDC
<b>Standard</b>	CFR47 Part 15 Subpart C	<b>RBW / VBW</b>	1 MHz / 3 MHz
<b>Dist/Ant Used</b>	3m / 3117, 1m / SAS-574	<b>Performed by</b>	Abhijit Patibandla

Above 1 GHz Plots for Transmit Mode at 2480 MHz

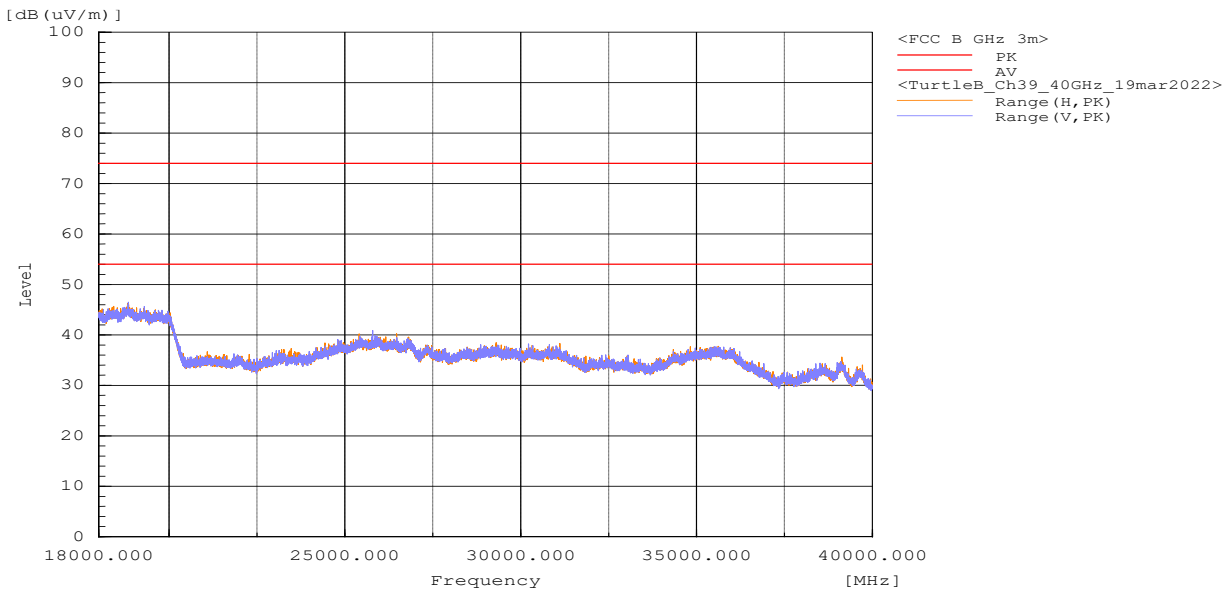
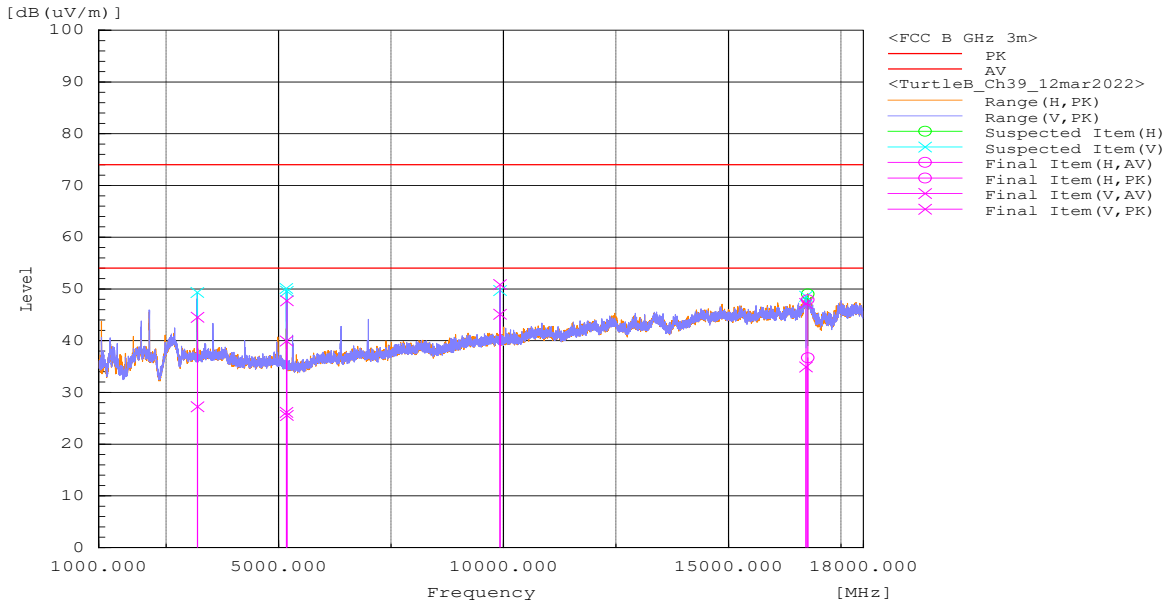

Notes: There was no emission observed from 18 GHz to 26 GHz.

---

#### 4.5.4 Sample Calculation

The field strength is calculated by subtracting the Amplifier Gain and adding the Cable Loss and Antenna Correction Factor to the measured reading. The basic equation is as follows:

$$\text{Field Strength (dB}\mu\text{V/m)} = \text{FIM} - \text{AMP} + \text{CBL} + \text{ACF}$$

Where: FIM = Field Intensity Meter (dB $\mu$ V)

AMP = Amplifier Gain (dB)

CBL = Cable Loss (dB)

ACF = Antenna Correction Factor (dB/m)

$$\mu\text{V/m} = 10^{\frac{\text{dB}\mu\text{V/m}}{20}}$$

## 4.6 AC Conducted Emissions

Testing was performed in accordance with ANSI C63.10: 2013. These test methods are listed under the laboratory's A2LA Scope of Accreditation.

This test measures the levels emanating from the EUT's AC input port, thus evaluating the potential for the EUT to cause radio frequency interference to other electronic devices.

The AC conducted emissions of equipment under test shall not exceed the values in CFR47 Part 15.207: 2021 and RSS Gen: 2019 Sect. 8.8.

### 4.6.1 Test Methodology

A test program that controls instrumentation and data logging was used to automate the AC Power Line Conducted emission test procedure. The frequency range of interest was divided into sub-ranges such as to yield a frequency resolution of 9 kHz. Each phase and neutral of the AC power line were measured with respect to ground. Measurements were performed using a set of 50 $\mu$ H / 50 $\Omega$  LISNs.

Testing is performed in Conducted Emission Station. The setup photographs clearly identify which site was used. The vertical ground plane used in the semi-anechoic chamber is a 2m x 2m solid aluminum frame and panel, and it is bonded to the horizontal ground plane.

In the case of tabletop equipment, the EUT is placed on a 1.0m x 1.5m non-conductive table 80cm above the ground plane and 40cm from a vertical ground reference plane. The rear of the EUT was positioned flush with the backside of the table and directly over the LISNs. The power and I/O cables were routed over the edge of the table and bundled approximately 40cm from the ground plane. Support equipment was powered from a separate LISN.

#### 4.6.1.1 Deviations

There were no deviations from this test methodology.

### 4.6.2 Test Results

As originally tested, the EUT was found to be compliant to the requirements of the test standard(s).

**Table 7: AC Conducted Emissions – Test Results**

<b>Test Conditions:</b> Conducted Measurement		<b>Test Date:</b> March 25, 2022
<b>Antenna Type:</b> Integrated		<b>Power Level:</b> 4
<b>AC Power:</b> USB Host Computer		<b>Configuration:</b> Tabletop
<b>Ambient Temperature:</b> 23° C		<b>Relative Humidity:</b> 35% RH
<b>Configuration</b>	<b>Frequency Range</b>	<b>Test Result</b>
Line 1 (Hot)	0.15 to 30 MHz	Pass
Line 2 (Neutral)	0.15 to 30 MHz	Pass

Conducted Emissions					Page 1 of 3			
<b>EUT Name</b>	USB Wireless Audio Transmitter				<b>Date</b>	March 25, 2022		
<b>EUT Model</b>	Stealth700P-MAX-TX				<b>Temp / Hum in</b>	23° C / 38% RH		
<b>EUT Serial</b>	PP #2				<b>Temp / Hum out</b>	N/A		
<b>EUT Config.</b>	Integrated Antenna				<b>Line AC / Freq</b>	Host @ 110 Vac/60 Hz		
<b>Standard</b>	CFR47 Part 15.207				<b>RBW / VBW</b>	9 kHz / 30 kHz		
<b>Lab/LISN</b>	CE Station /EMCO 3816				<b>Performed by</b>	Abhijit Patibandla		
Frequency	Raw	Corrd'	Level	Detector	Line	Limit	Margin	Result
MHz	dBuV	dB	dBuV		Line	dBuV	dB	
0.156	37.00	9.60	46.60	QP	Line	65.60	-19.00	Pass
0.156	23.10	9.60	32.70	Ave	Line	55.60	-22.90	Pass
0.221	27.20	9.50	36.70	QP	Line	62.80	-26.10	Pass
0.221	15.40	9.50	24.90	Ave	Line	52.80	-27.90	Pass
0.412	38.20	9.40	47.60	QP	Line	57.60	-10.00	Pass
0.412	34.20	9.40	43.60	Ave	Line	47.60	-4.00	Pass
3.388	30.00	9.40	39.40	QP	Line	56.00	-16.60	Pass
3.388	20.00	9.40	29.40	Ave	Line	46.00	-16.60	Pass
9.882	28.60	9.50	38.10	QP	Line	60.00	-21.90	Pass
9.882	21.30	9.50	30.80	Ave	Line	50.00	-19.20	Pass
24.360	20.80	9.80	30.60	QP	Line	60.00	-29.40	Pass
24.360	16.00	9.80	25.80	Ave	Line	50.00	-24.20	Pass
0.153	38.60	9.60	48.20	QP	Neutral	65.80	-17.60	Pass
0.153	24.40	9.60	34.00	Ave	Neutral	55.80	-21.80	Pass
0.391	36.20	9.40	45.60	QP	Neutral	58.00	-12.40	Pass
0.391	29.10	9.40	38.50	Ave	Neutral	48.00	-9.50	Pass
0.415	37.90	9.40	47.30	QP	Neutral	57.50	-10.20	Pass
0.415	33.80	9.40	43.20	Ave	Neutral	47.50	-4.30	Pass
3.330	29.80	9.40	39.20	QP	Neutral	56.00	-16.80	Pass
3.330	19.30	9.40	28.70	Ave	Neutral	46.00	-17.30	Pass
9.726	32.00	9.50	41.50	QP	Neutral	60.00	-18.50	Pass
9.726	25.70	9.50	35.20	Ave	Neutral	50.00	-14.80	Pass
24.180	21.70	9.80	31.50	QP	Neutral	60.00	-28.50	Pass
24.180	17.00	9.80	26.80	Ave	Neutral	50.00	-23.20	Pass
Spec Margin = QP./Ave. - Limit, ± Uncertainty								
Combined Standard Uncertainty $u_c(y) = \pm 3.51$ dB Expanded Uncertainty $U = ku_c(y)$ $k = 2$ for 95% confidence								
Notes: EUT was setup as table top equipment and transmitted at 2402 MHz								

Conducted Emissions

Page 2 of 3

<b>EUT Name</b>	USB Wireless Audio Transmitter	<b>Date</b>	March 25, 2022
<b>EUT Model</b>	Stealth700P-MAX-TX	<b>Temp / Hum in</b>	23° C / 38% RH
<b>EUT Serial</b>	PP #2	<b>Temp / Hum out</b>	N/A
<b>EUT Config.</b>	Integrated Antenna	<b>Line AC</b>	Host @ 110 Vac/60 Hz
<b>Standard</b>	CFR47 Part 15.207	<b>RBW / VBW</b>	9 kHz / 30 kHz
<b>Lab/LISN</b>	CE Station /EMCO 3816	<b>Performed by</b>	Abhijit Patibandla

150 kHz to 30 MHz Plot for Line 1 (Hot)

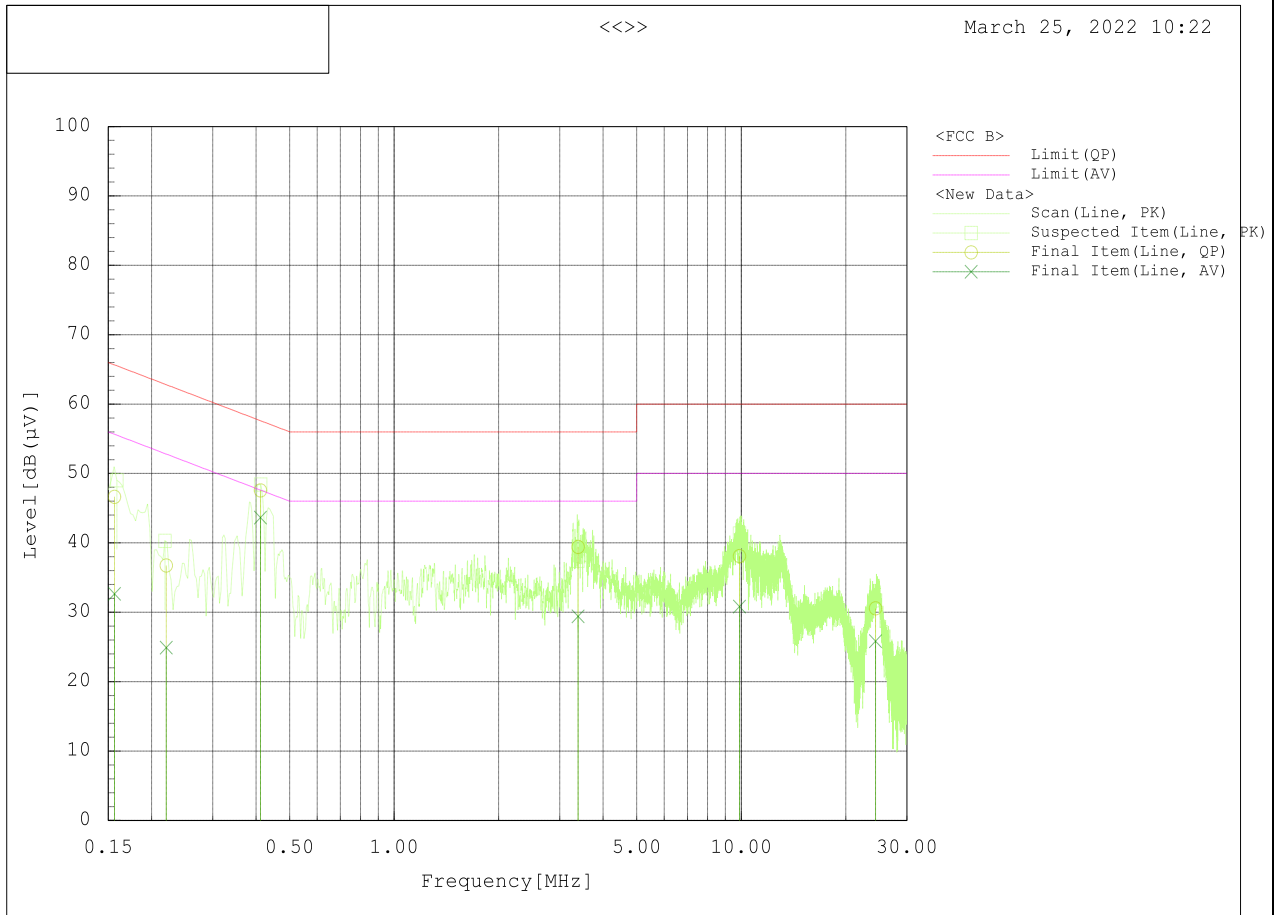

Notes: Meets FCC Class B limit.



Conducted Emissions

Page 3 of 3

<b>EUT Name</b>	USB Wireless Audio Transmitter	<b>Date</b>	March 25, 2022
<b>EUT Model</b>	Stealth700P-MAX-TX	<b>Temp / Hum in</b>	23° C / 38% RH
<b>EUT Serial</b>	PP #2	<b>Temp / Hum out</b>	N/A
<b>EUT Config.</b>	Integrated Antenna	<b>Line AC</b>	Host @ 110 Vac/60 Hz
<b>Standard</b>	CFR47 Part 15.207	<b>RBW / VBW</b>	9 kHz / 30 kHz
<b>Lab/LISN</b>	CE Station /EMCO 3816	<b>Performed by</b>	Abhijit Patibandla

150 kHz to 30 MHz Plot for Line 2 (Neutral)

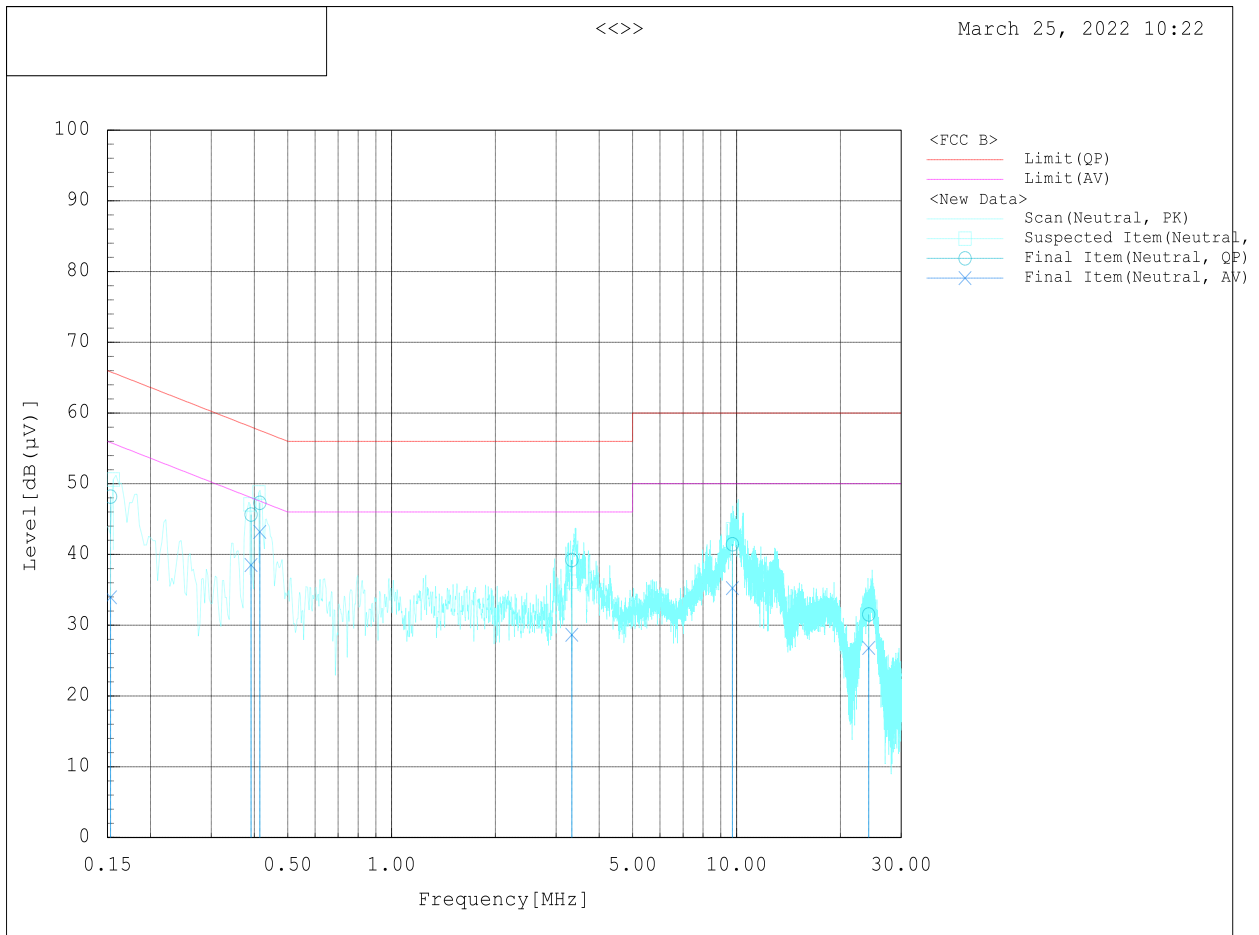

Notes: Meets FCC Class B limit.

## 5 Test Equipment List

### 5.1 Equipment List

Equipment	Manufacturer	Model #	Serial/Inst #	Last Cal mm/dd/yyyy	Next Cal mm/dd/yyyy
Loop Antenna	COM-POWER	AL-130R	10160080	02/07/2022	02/07/2023
Bilog Antenna	Sunol Sciences	JB6	A111717	09/04/2020	09/04/2022
Horn Ant. (1-18GHz)	ETS-Lindgren	3117	218554	04/21/2021	04/21/2022
Horn Ant. (18-40GHz)	A.H Systems, In.	SAS-574	579	08/05/2020	08/05/2022
Spectrum Analyzer	KEYSIGHT	N9010A	MY51440112	11/21/2021	11/21/2022
EMI Receiver	Rohde & Schwarz	ESW44	1328.4100K-101662-MH	09/22/2021	09/22/2022
Preamplifier	RF-Lambda	RAMP00M50GA	18040300055	05/07/2021	05/07/2022
Power Sensor	ETS Lindgren	7002-006	00159814	01/16/2022	01/16/2023
Humidity/ Baro/ Temp. Recorder	PCE Instruments	PCE-THB 40	Q907623	08/31/2021	08/31/2022
DC Power Source	Agilent	E3610A	MY40002494	02/25/2022	02/25/2023
Notch Filter	Micro-Tronics	BRM50702	NA	VBU	VBU

\* Calibration of equipment past due for re-calibration will be performed expeditiously. If any equipment is found to be out of tolerance at that time, affected customers will be notified accordingly.

---

## 6 EMC Test Plan

### 6.1 Introduction

This section provides a description of the Equipment Under Test (EUT), configurations, operating conditions, and performance acceptance criteria. It is an overview of information provided by the manufacturer so that the test laboratory may perform the requested testing.

### 6.2 Customer

**Table 8:** Customer Information

<b>Company Name</b>	Voyetra Turtle Beach, Inc.
<b>Address</b>	44 South Broadway, 4th Floor
<b>City, State, Zip</b>	White Plains NY 10601
<b>Country</b>	USA

**Table 9:** Technical Contact Information

<b>Name</b>	Tim Blaney
<b>E-mail</b>	tim@commcepts.net
<b>Phone</b>	(530) 277-3482

### 6.3 Equipment Under Test (EUT)

**Table 10:** EUT Specifications

<b>EUT Specification</b>	
Package Dimensions	31.5 mm (1.25”) x 13.5 mm (0.5”) x 6.0 mm (0.24”)
Power Input	Input Voltage: 5.0 Vdc via Host USB port.
Environment	Indoor
Operating Temperature Range:	0 to 50 degrees C
Multiple Feeds:	<input type="checkbox"/> Yes and how many <input checked="" type="checkbox"/> No
Product Marketing Name (PMN)	Stealth700P-MAX-TX
Hardware Version Identification Number (HVIN)	700P-MAX-TX
Firmware Version Identification Number (FVIN)	1.1.1.0
Operating Mode	TestCommon Unit Test 1.0.3.9
Transmitter Frequency Band	2402 MHz to 2480 MHz
Max. Measured Power Output	+6.42 dBm
Power Setting @ Operating Channel	+4.0 dBm
Antenna Type	Integrated PCB (0.7 dBi)
Modulation Type	<input type="checkbox"/> AM <input type="checkbox"/> FM <input type="checkbox"/> DSSS <input type="checkbox"/> OFDM <input checked="" type="checkbox"/> Other describe: GFSK
Date Rates	1 Mbps and 2 Mbps
TX/RX Chain (s)	1
Directional Gain Type	<input checked="" type="checkbox"/> Uncorrelated <input checked="" type="checkbox"/> No Beam-Forming <input type="checkbox"/> Other describe:
Type of Equipment	<input type="checkbox"/> Table Top <input type="checkbox"/> Wall-mount <input type="checkbox"/> Floor standing cabinet <input checked="" type="checkbox"/> Other describe: <i>Table Top Device's accessory</i>
<p>Note: 1. The Stealth700P-MAX-TX has two versions that are 100% identical electrically and mechanically except for the color of their exterior plastics. The two model color variations are standard Black and Midnight Blue.</p> <p>2. Stealth700X-MAX-TX and Stealth700P-MAX-TX are 100% identical electrically and mechanically except for the color of their exterior plastics. The Stealth700X-MAX-TX samples were selected for formal evaluation to represent both models.</p>	

**Table 11: Interface Specifications**

Interface Type	Cabled with what type of cable?	Is the cable shielded?	Maximum potential length of the cable?	Metallic (M), Coax (C), Fiber (F), or Not Applicable?
USB	Terminated	<input checked="" type="checkbox"/> Yes	<input checked="" type="checkbox"/> Metric:0.6 m	<input checked="" type="checkbox"/> M

**Table 12: Supported Equipment**

Equipment	Manufacturer	Model	Serial	Used for
Laptop	Lenovo	T430	PB-8HBRR	Set test mode

**Table 13: Description of Sample used for Testing**

Device	Serial Number	Configuration	Used For
Stealth700P-MAX-TX	PP #2	Radiated Sample	Radiated Emissions, Conducted Emission.
Stealth700P-MAX-TX	PP #1	Conducted Sample	Output Power, Occupied Bandwidth, Conducted Spurious Emissions, Peak Power Spectral Density

**Note:** Stealth700X-MAX-RX and Stealth700P-MAX-RX are 100% identical electrically and mechanically except for the color of their exterior plastics. The Stealth700X-MAX-RX samples were selected for formal evaluation to represent both models.

**Table 14: Description of Test Configuration used for Radiated Measurement.**

Device	Antenna	Mode	Setup Description
Stealth700P-MAX-TX	Integrated	Transmit & Receive	Stealth700P-MAX-TX positioned vertically, worst case.

**Note:** This is the final setup configuration used for testing.



**Table 15:** Final Test Mode for 2402 MHz to 2480 MHz Band

Test	Stealth700P-MAX-TX
Occupied Bandwidth	2402, 2442, 2480 MHz @ 1 and 2 Mbps
Output Power	2402, 2442, 2480 MHz @ 1 and 2 Mbps
Peak Power Spectral Density	2402, 2442, 2480 MHz @ 1 and 2 Mbps
Out-of-Band (-30 dBr)	2402, 2442, 2480 MHz @ 1 and 2 Mbps
Band-Edge (Radiated)	2402, 2480 MHz @ 2 Mbps (Worst Case)
Transmitted Spurious Emission	2402, 2442, 2480 MHz @ 1 Mbps (Worst Case)
AC Conducted Emission	2402 MHz @ 1 Mbps
<b>Note:</b> EUT transmits at 100% duty cycle.	

---

## 6.4 Test Specifications

**Table 16:** Test Specifications

<b>Emissions and Immunity</b>	
<b>Rules &amp; Regulations / Standards</b>	<b>Requirement</b>
CFR 47 Part 15.247: 2021	All
RSS 247 Issue 2, 2017	All

**END OF REPORT**