

Test report no.: US21P7P4.001 Rev.:01
 Prüfbericht-Nr.:

Page 1 of 60
 Seite 1 von 60

Test Report No.: <i>Prüfbericht-Nr.:</i>	US21P7P4.001 Rev.: 01	Order No.: <i>Auftrags-Nr.:</i>	P00490535 234179995
Client Reference No.: <i>Kunden-Referenz-Nr.:</i>	2004399	Order date: <i>Auftragsdatum:</i>	11/8/2021
Client: <i>Auftraggeber:</i>	Turtle Beach Corporation 44 South Broadway, 4th Floor White Plains, New York 10601 U.S.A		
Test item: <i>Bezeichnung / Typ-Nr.</i>	Stealth 700P Gen 2 RX2		
Identification/ Type No.: <i>Auftrags-Inhalt:</i>	N/A		
Order content:	Electromagnetic Compatibility (EMC) Test Report		
Test specification: <i>Prüfgrundlage:</i>	CFR 47 Part 15.247: 2021 and RSS 247: 2017		
Date of sample receipt: <i>Wareneingangsdatum:</i>	11/22/2021		
Test sample No.: <i>Prüfmuster-Nr.:</i>	A003186146		
Testing period: <i>Prüfzeitraum:</i>	November 29, 2021 to December 6, 2021		
Testing laboratory: <i>Prüflaboratorium:</i>	TUV Rheinland of North America 1279 Quarry Lane, Ste. A Pleasanton, CA 94566		
Test result*: <i>Prüfergebnis*:</i>	Pass		

Date: 12/10/2021 <i>Datum:</i>	Date: 12/10/2021 <i>Datum:</i>		
compiled by: <i>geprüft von:</i>	Jeremy Luong	authorized by: <i>genehmigt von:</i>	Richard Decker
Others/ <i>Sonstiges:</i>			

Condition of the test item at delivery:
Zustand des Prüfgegenstandes bei Anlieferung: Test sample complete and undamaged

* Legend: * Legende:	P(ass) = passed a.m test specification(s) P(ass) = entspricht o.g. Prüfgrundlage(n)	F(ail) = entspricht nicht o.g. Prüfgrundlage(n) F(ail) = entspricht nicht o.g. Prüfgrundlage(n)	N/A = not applicable N/A = nicht anwendbar	N/T = not tested N/T = nicht getestet
-------------------------	--	--	---	--

This test report only relates to the a. m. test sample. Without permission of the test center this test report is not permitted to be duplicated in extracts. This test report does not entitle to carry any test mark.
Dieser Prüfbericht bezieht sich nur auf das o.g. Prüfmuster und darf ohne Genehmigung der Prüfstelle nicht auszugsweise vervielfältigt werden. Dieser Bericht berechtigt nicht zur Verwendung eines Prüfzeichens.

Test report no.: US21P7P4.001 Rev.:01
Prüfbericht-Nr.:

Page 2 of 60
Seite 2 von 60

Remarks

- | | |
|---|---|
| 1 | The equipment used during the specified testing period was calibrated according to our test laboratory calibration program. The equipment fulfils the requirements included in the relevant standards. The traceability of the test equipment used is ensured by compliance with the regulations of our management system. Detailed information regarding test conditions, equipment and measurement uncertainty is available in the test laboratory and could be provided on request. |
| 2 | As contractually agreed, this document has been signed digitally only. TÜV Rheinland has not verified and unable to verify which legal or other pertaining requirements are applicable for this document. Such verification is within the responsibility of the user of this document. Upon request by its client, TÜV Rheinland can confirm the validity of the digital signature by a separate document. Such request shall be addressed to our Sales department. An environmental fee for such additional service will be charged. |
| 3 | Test clauses with remark of * are subcontracted to qualified subcontractors and described under the respective test clause in the report.
Deviations of testing specification(s) or customer requirements are listed in specific test clause in the report. |
| 4 | The test results contained in this report refer exclusively to the product(s) presented for testing. No liability may be assumed for models or products not referred to herein. This test report may not be published or duplicated in part without permission of the testing body. This test report by itself does not constitute authorization for the use of any TÜV Rheinland test mark. The report must not be used by the client to claim product certification, approval, or endorsement by A2LA. |
| 5 | TÜV Rheinland testing laboratories apply the Zero Guard Band rule unless otherwise required by the accreditation, standard, or requested by the customer as part of the quotation.
For the Zero Guard Band rule, the measurement uncertainty is not considered and will also not be declared in the test report. Should the measurement uncertainty be used to provide guard band, these values will be declared in the test report. |
| 6 | Electromagnetic Compatibility Test Report.
Electromagnetic Compatibility Emissions Test Report.
Electromagnetic Compatibility Engineering Test Results.
The above product was found to be Compliant to the above test standard(s). |

Test report no.: US21P7P4.001 Rev.:01
Prüfbericht-Nr.:

Page 3 of 60
Seite 3 von 60

1	Product details: <i>Produktdetails:</i>	Wireless Audio Headset
2	Dimensions / Weight: <i>Maße / Gewicht:</i>	215.8 mm x 243 mm x 111.5 mm / 399.2 g
3	Operating elements: <i>Bedienelemente:</i>	3.7 Vdc Battery or Host USB
4	Equipment / Accessories:	See Section 6.10
5	Used materials: <i>Verwendete Materialien:</i>	NA
6	Other: <i>Sonstiges:</i>	Test sample(s), as well sample information, description, product details and intended usage was provided by customer.
7	Test sample obtaining: <i>Prüfmusterbereitstellung:</i>	<input checked="" type="checkbox"/> Sending by customer <input type="checkbox"/> Sampling by TÜV Rheinland Group <input type="checkbox"/> others:

TABLE of CONTENTS

1	EXECUTIVE SUMMARY	8
1.1	SCOPE	8
1.2	PURPOSE	8
1.3	SUMMARY OF TEST RESULTS	9
1.4	SPECIAL ACCESSORIES	9
1.5	EQUIPMENT MODIFICATIONS	9
2	LABORATORY INFORMATION	10
2.1	ACCREDITATIONS & ENDORSEMENTS	10
2.1.1	<i>US Federal Communications Commission</i>	10
2.1.2	<i>NIST / A2LA</i>	10
2.1.3	<i>Canada</i>	10
2.1.4	<i>Japan – VCCI</i>	10
2.1.5	<i>Acceptance by Mutual Recognition Arrangement</i>	10
2.2	TEST FACILITIES	11
2.2.1	<i>Emission Test Facility</i>	11
2.2.2	<i>Immunity Test Facility</i>	11
2.3	MEASUREMENT UNCERTAINTY	11
2.3.1	<i>Sample Calculation – radiated & conducted emissions</i>	12
2.3.2	<i>Measurement Uncertainty</i>	12
2.4	CALIBRATION TRACEABILITY	13
3	PRODUCT INFORMATION	14
3.1	PRODUCT DESCRIPTION	14
3.2	EQUIPMENT CONFIGURATION	14
3.3	OPERATING MODE	14
3.4	UNIQUE ANTENNA CONNECTOR	15
3.5	DUTY CYCLE	16
4	EMISSIONS	17
4.1	OUTPUT POWER REQUIREMENTS	17
4.1.1	<i>Test Method</i>	17
4.1.2	<i>Results</i>	18
4.2	OCCUPIED BANDWIDTH	21
4.2.1	<i>Test Method</i>	21
4.2.2	<i>Results</i>	21
4.3	PEAK POWER SPECTRAL DENSITY	26
4.3.1	<i>Test Method</i>	26
4.3.2	<i>Results</i>	26
4.4	OUT OF BAND EMISSIONS	30
4.4.1	<i>Test Method</i>	30
4.4.2	<i>Results</i>	31
4.5	TRANSMIT SPURIOUS EMISSIONS	35
4.5.1	<i>Test Methodology</i>	35
4.5.2	<i>Transmitter Spurious Emission Limit</i>	36
4.5.3	<i>Test Results</i>	36

4.5.4	Sample Calculation	51
4.6	AC CONDUCTED EMISSIONS	52
4.6.1	Test Methodology	52
4.6.2	Test Results	52
5	TEST EQUIPMENT LIST	55
5.1	EQUIPMENT LIST	55
6	EMC TEST PLAN	56
6.1	INTRODUCTION	56
6.2	CUSTOMER	56
6.3	EQUIPMENT UNDER TEST (EUT)	57
6.4	TEST SPECIFICATIONS	60

Index of Tables

Table 1: Summary of Test Results.....	9
Table 2: RF Output Power at the Antenna Port – Test Results.....	18
Table 3: Occupied Bandwidth – Test Results.....	22
Table 4: Peak Power Spectral Density – Test Results.....	27
Table 5: Out of Band Emissions – Test Results	31
Table 6: Transmit Spurious Emission at Band-Edge Requirements.....	37
Table 7: AC Conducted Emissions – Test Results	52
Table 8: Customer Information	56
Table 9: Technical Contact Information.....	56
Table 10: EUT Specifications	57
Table 11: Interface Specifications.....	58
Table 12: Supported Equipment.....	58
Table 13: Description of Sample used for Testing	58
Table 14: Description of Test Configuration used for Radiated Measurement.	58
Table 15: Final Test Mode for 2402 to 2480 MHz Band.....	59
Table 16: Test Specifications	60

1 Executive Summary

1.1 Scope

This report is intended to document the status of conformance with the requirements of the CFR 47 Part 15.247: 2021 and RSS 247 Issue 2, 2017 based on the results of testing performed on November 29, 2021 to December 6, 2021 on the Wireless Audio Headset Model Stealth 700P Gen 2 RX2 manufactured by Voyetra Turtle Beach, Inc. This report only applies to the specific samples tested under the stated test conditions. It is the responsibility of the manufacturer to assure that additional production units of this model are manufactured with identical or EMI equivalent electrical and mechanical components. This report is further intended to document changes and modifications to the EUT throughout its life cycle. All documentation will be included as a supplement.

1.2 Purpose

Testing was performed to evaluate the EMC performance of the EUT in accordance with the applicable requirements, procedures, and criteria defined in the application of regulations and application of standards listed in this report. The 2402 MHz to 2480 MHz frequency band is covered in this document.

1.3 Summary of Test Results

Table 1: Summary of Test Results

Test	Test Method ANSI C63.10:2013	Test Parameters	Measured Value	Result
Spurious Emission in Transmitted Mode	CFR47 15.209, CFR47 15.247 (d) RSS GEN Sect.8.9	Class B	-2.64 dB (Margin)	Complied
Restricted Bands of Operation	CFR47 15.205, RSS GEN Sect.8.10	Class B		Complied
AC Power Conducted Emission	CFR47 15.207, RSS-GEN Sect.8.8	Class B	-18.58 dB (Margin)	Complied
Occupied Bandwidth	CFR47 15.247 (a2), RSS GEN Sect.6.7, RSS 247 Sect. 5.2 (a)	≥ 500 kHz	0.721 MHz (DTS) 1.029 MHz (99%)	Complied
Maximum Output Power	CFR47 15.247 (b), RSS 247 Sect. 5.4 (d)	30 dBm w/ 6 dBi antenna	+3.45 dBm	Complied
Peak Power Spectral Density	CFR47 15.247 (e), RSS 247 Sect. 5.2 (b)	8 dBm/ 3 kHz	-18.05 dBm	Complied
Out of Band Emission	CFR47 15.247 (d), RSS 247 Sect.5.5	-30 dB	-10.72 dB (Margin)	Complied

1.4 Special Accessories

No special accessories were necessary in order to achieve compliance.

1.5 Equipment Modifications

None

2 Laboratory Information

2.1 Accreditations & Endorsements

2.1.1 US Federal Communications Commission



TUV Rheinland of North America at 1279 Quarry Ln, Pleasanton, CA 94566 is recognized by the commission for performing testing services for the general public on a fee basis. These laboratory test facilities have been fully described in reports submitted to and accepted by the FCC (US1131). The laboratory scope of accreditation includes: Title 47 CFR Parts 15, 18, and 90. The accreditation is updated every 3 years.

2.1.2 NIST / A2LA



TUV Rheinland of North America is accredited by the National Voluntary Laboratory Accreditation Program, which is administered under the auspices of the National Institute of Standards and Technology. The laboratory has been assessed and accredited in accordance with ISO Guide 17025:2017 and ISO 9002 (Lab Code Testing Cert #3331.02).

The scope of laboratory accreditation includes emission and immunity testing. The accreditation is updated annually.

2.1.3 Canada



TUV Rheinland of North America at the 1279 Quarry Ln, Pleasanton, CA 94566 address is accredited by Industry Canada for performing testing services for the general public on a fee basis. This laboratory test facilities have been fully described in reports submitted to and accepted by Industry Canada (File Number 2932M). This reference number is the indication to the Industry Canada Certification Officers that the site meets the requirements of RSS 212, Issue 1 (Provisional). The accreditation is updated every 3 years.

2.1.4 Japan – VCCI



The Voluntary Control Council for Interference by Information Technology Equipment (VCCI) is a group that consists of Information Technology Equipment (ITE) manufacturers and EMC test laboratories. The purpose of the Council is to take voluntary control measures against electromagnetic interference from Information Technology Equipment, and thereby contribute to the development of a socially beneficial and responsible state of affairs in the realm of Information Technology Equipment in Japan. TUV Rheinland of North America at 1279 Quarry Ln, Pleasanton, CA 94566 has been assessed and approved in accordance with the Regulations for Voluntary Control Measures.

VCCI Registration No. for Pleasanton: A-0326

2.1.5 Acceptance by Mutual Recognition Arrangement



The United States has an established agreement with specific countries under the Asia Pacific Laboratory Accreditation Corporation (APLAC) Mutual Recognition Arrangement. Under this agreement, all TUV Rheinland at 1279 Quarry Ln, Pleasanton, CA 94566 test results and test reports within the scope of the laboratory NIST / A2LA accreditation will be accepted by each member country.

2.2 Test Facilities

All of the test facilities are located at 1279 Quarry Lane, Pleasanton, California 94566, USA.

2.2.1 Emission Test Facility

The Semi-Anechoic chamber and AC Line Conducted measurement facility used to collect the radiated and conducted data has been constructed in accordance with ANSI C63.7:1992. The site has been measured in accordance with and verified to comply with the theoretical normalized site attenuation requirements of ANSI C63.4-2014, at a test distance of 3 and 5 meters. The site is listed with the FCC and accredited by A2LA (Lab Code Testing Cert #3331.02). The 3/5-meter semi-anechoic chamber used to collect the radiated data has been verified to comply with the theoretical normalized site attenuation requirements of ANSI C63.4-2014, at a test distance of 3 meter and 5 meters. A report detailing this site can be obtained from TUV Rheinland of North America.

2.2.2 Immunity Test Facility

ESD, EFT, Surge, PQF: These tests are performed in an environmentally controlled room with a 3.7 m x 4.8 m x 3.175 mm thick aluminum floor connected to PE ground.

For ESD testing, tabletop equipment is placed on an insulated mat with a surface resistivity of 10^9 Ohms/square on a 1.6 m x 0.8 m x 0.8 m high non-conductive table with a 3.175 mm aluminum top (Horizontal Coupling Plane). The HCP is connected to the main ground plane via a low impedance ground strap through two 470-k Ω resistors. The Vertical Coupling Plane consists of an aluminum plate 50 cm x 50 cm x 3.175 mm thick. The VCP is connected to the main ground plane via a low impedance ground strap through two 470-k Ω resistors.

For EFT, Surge, PQF, the HCP and VCP are removed.

RF Field Immunity testing is performed in a 7.3m x 4.3m x 4.1m anechoic chamber.

RF Conducted and Magnetic Field Immunity testing is performed on a 4.8m x 3.7m x 3.175mm thick aluminum ground plane.

All test areas allow a minimum distance of 1 meter from the EUT to walls or conducting objects.

2.3 Measurement Uncertainty

Two types of measurement uncertainty are expressed in this report, per *ISO Guide To The Expression Of Uncertainty In Measurement*, 1st Edition, 1995.

The Combined Standard Uncertainty is the standard uncertainty of the result of a measurement when that result is obtained from the values of a number of other quantities; it is equal to the positive square root of the sum of the variances or co-variances of these other quantities, weighted according to how the measurement result varies with changes in these quantities. The term *standard uncertainty* is the result of a measurement expressed as a standard deviation.

2.3.1 Sample Calculation – radiated & conducted emissions

The field strength is calculated by subtracting the Amplifier Gain and adding the Cable Loss and Antenna Correction Factor to the measured reading. The basic equation is as follows:

$$\text{Field Strength (dB}\mu\text{V/m)} = \text{RAW} - \text{AMP} + \text{CBL} + \text{ACF}$$

Where: RAW = Measured level before correction (dB μ V)

AMP = Amplifier Gain (dB)

CBL = Cable Loss (dB)

ACF = Antenna Correction Factor (dB/m)

$$\mu\text{V/m} = 10^{\frac{\text{dB}\mu\text{V/m}}{20}}$$

Sample radiated emissions calculation @ 30 MHz

Measurement +Antenna Factor–Amplifier Gain+Cable loss=Radiated Emissions (dBuV/m)

$$25 \text{ dBuV/m} + 17.5 \text{ dB} - 20 \text{ dB} + 1.0 \text{ dB} = 23.5 \text{ dBuV/m}$$

2.3.2 Measurement Uncertainty

Per CISPR 16-4-2	U_{lab}	U_{cispr}
Radiated Disturbance @ 10 meters		
30 – 1,000 MHz	2.25 dB	4.51 dB
Radiated Disturbance @ 3 meters		
30 – 1,000 MHz	2.26 dB	4.52 dB
1 – 6 GHz	2.12 dB	4.25 dB
6 – 40 GHz	2.47 dB	4.93 dB
Conducted Disturbance @ Mains Terminals		
150 kHz – 30 MHz	1.09 dB	2.18 dB
Disturbance Power		
30 MHz – 300 MHz	3.92 dB	4.3 dB

Voltech PM6000A

The estimated combined standard uncertainty for harmonic current and flicker measurements is $\pm 5.0\%$.	Per CISPR 16-4-2 Methods
--	--------------------------

Measurement Uncertainty - EMC Immunity

The estimated combined standard uncertainty for ESD immunity measurements is $\pm 8.2\%$.	Per IEC 61000-4-2
The estimated combined standard uncertainty for radiated immunity measurements is ± 4.10 dB.	Per IEC 61000-4-3
The estimated combined standard uncertainty for conducted immunity measurements with CDN is ± 3.66 dB	Per IEC 61000-4-6
The estimated combined standard uncertainty for power frequency magnetic field immunity is $\pm 2.9\%$.	Per IEC 61000-4-8
The estimated combined standard uncertainty for EFT fast transient immunity measurements is $\pm 2.6\%$.	Per IEC 61000-4-4
The estimated combined standard uncertainty for surge immunity measurements is $\pm 2.6\%$.	Per IEC 61000-4-5
The estimated combined standard uncertainty for voltage variation and interruption measurements is $\pm 1.74\%$.	Per IEC 61000-4-11

Measurement Uncertainty – Radio Testing

The estimated combined standard uncertainty for frequency error measurements is ± 3.88 Hz
The estimated combined standard uncertainty for carrier power measurements is ± 0.70 dB.
The estimated combined standard uncertainty for adjacent channel power measurements is ± 1.47 dB.
The estimated combined standard uncertainty for modulation frequency response measurements is ± 0.46 dB.
The estimated combined standard uncertainty for transmitter conducted emission measurements is ± 2.06 dB

The expanded uncertainty at a level of 95% confidence is obtained by multiplying the combined standard uncertainty by a coverage factor of 2. Compliance criteria are not based on measurement uncertainty.

2.4 Calibration Traceability

All measurement instrumentation is traceable to the National Institute of Standards and Technology (NIST). Measurement method complies with ANSI/NC SL Z540-1-1994 and ISO Standard 17025:2017. Equipment calibration records are kept on file at the test facility.

3 Product Information

3.1 Product Description

The Stealth 700P Gen 2 Wireless Gaming System consists of two main communication modules, the Stealth 700P Gen 2 RX2 (“Headset”) and the Stealth 700P Gen 2 TX (“Transmitter”). These two modules comprise a closed-loop wireless audio gaming system that utilize a proprietary 2.4 GHz communication technology to offer wireless streaming audio and chat/talkback capabilities. The devices are designed to operate with a PS4 gaming console or PC-based system.

The Stealth 700P Gen 2 RX2 has 50mm drivers, fixed omni-directional gooseneck microphone with flip up microphone mute and microphone monitoring. Additional advanced functionality includes a Bluetooth radio that provides simultaneous connection to a Turtle Beach mobile app and device for streaming audio. Other audio processing features and controls include Superhuman Hearing, variable Mic Monitoring and a glasses friendly ProSpecs™ ear cup design.

Additionally, the Stealth 700P Gen 2 RX2 headset can be powered with either a 1050 mAh battery or a 1400 mAh battery to extend its operational time.

3.2 Equipment Configuration

A description of the equipment configuration is given in the Test Plan Section. The EUT was tested as called for in the test standard and was configured and operated in a manner consistent with its intended use. The EUT was connected to rated power and allowed to reach intended operating conditions. The placement of the EUT system components was guided by the test standard and selected to represent typical installation conditions.

In the case of an EUT that can operate in more than one configuration, preliminary testing was performed to determine the configuration that produced maximum radiation.

The final configuration was selected to produce the worst case radiation for emissions testing and to place the EUT in the most susceptible state for immunity testing.

3.3 Operating Mode

A description of the operation mode is given in the Test Plan Section. In the case of an EUT that can operate in more than one state, preliminary testing was performed to determine the operating mode that produced maximum radiation.

The final operating mode was selected to produce the worst case radiation for emissions testing and to place the EUT in the most susceptible state for immunity testing.

3.4 Unique Antenna Connector

An intentional radiator shall be designed to ensure that no antenna other than that furnished by the responsible party shall be used with the device. The use of a permanently attached antenna or of an antenna that uses a unique coupling to the intentional radiator shall be considered sufficient to comply with the provisions of this Section. The manufacturer may design the unit so that a broken antenna can be replaced by the user, but the use of a standard antenna jack or electrical connector is prohibited. This requirement does not apply to carrier current devices or to devices operated under the provisions of CFR47 Parts 15.211, 15.213, 15.217, 15.219, or 15.221.

3.4.1 Results

The Stealth 700P Gen 2 RX2 Wi-Fi radio uses the permanently attached PCB with cable antenna inside the device. See EUT Photo for details.

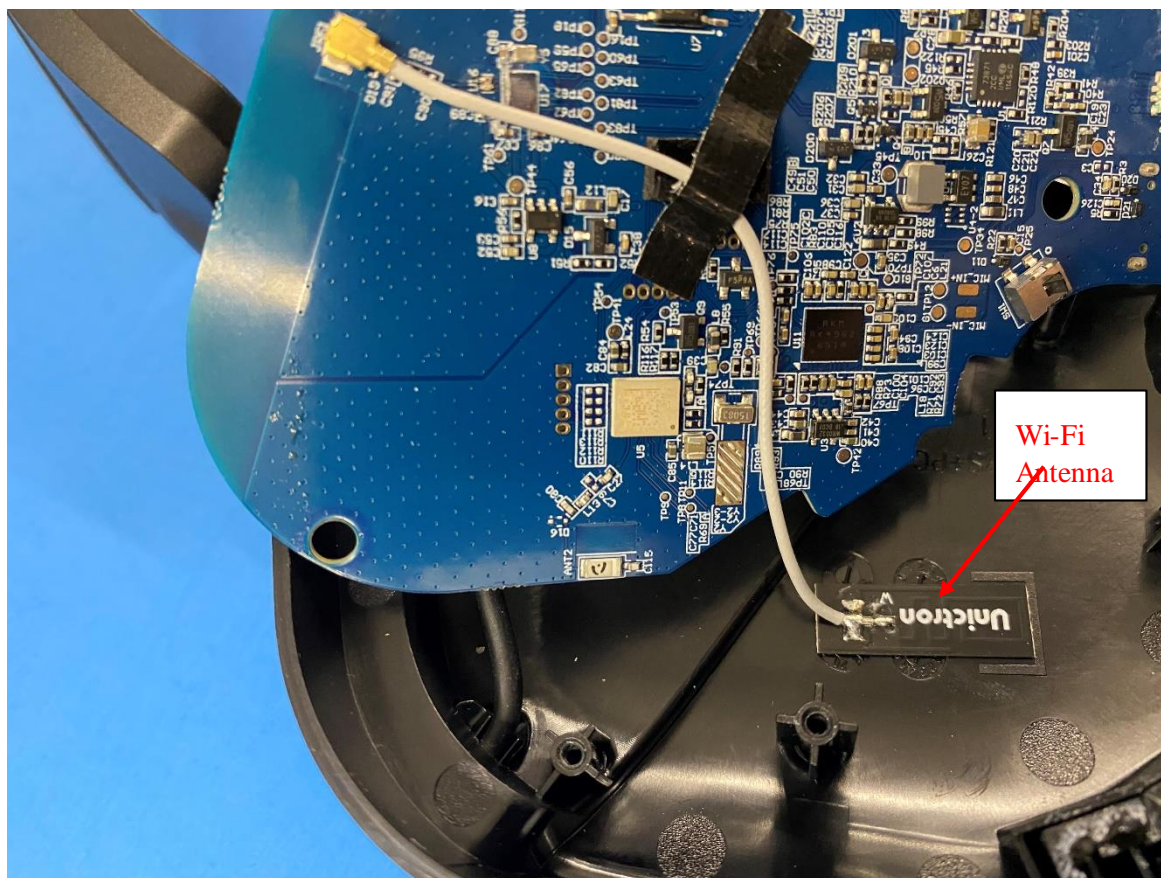

3.5 Duty Cycle

The Stealth 700P Gen 2 RX2, SN: PP1 was measured.

3.5.1 Results

Mode	On Time (ms)	Period (ms)	Duty Cycle (%)	Duty Factor (dB)
Standard	0.222	0.253	87.75	0.57

Notes: EUT was configured and measured for the duty cycle. All measurements use 87.75% duty cycle.

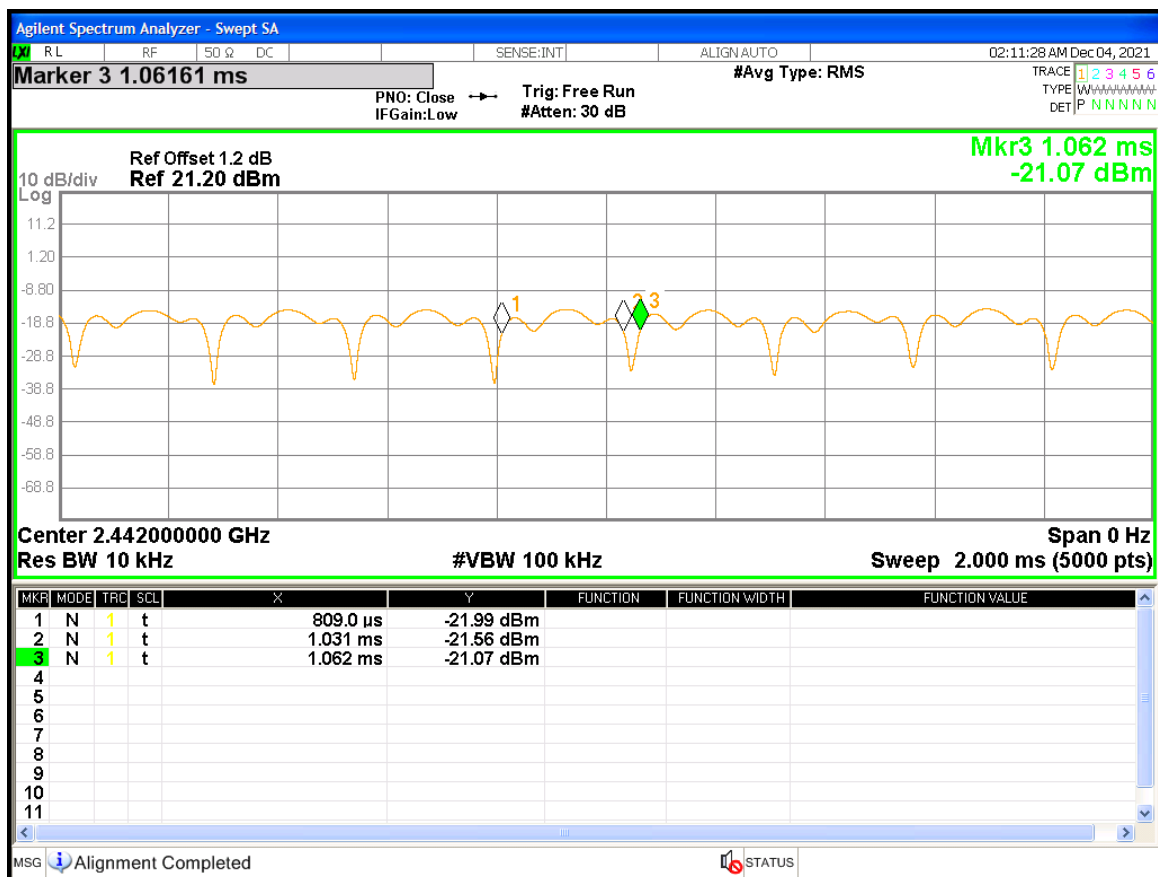

Figure 1: Duty Cycle

4 Emissions

Testing was performed in accordance with CFR 47 Part 15.247: 2021 and RSS247: 2017. These test methods are listed under the laboratory's A2LA Scope of Accreditation. This test measures the levels emanating from the EUT, thus evaluating the potential for the EUT to cause radio frequency interference to other electronic devices. Procedures described in section 8 of the standard were used.

4.1 Output Power Requirements

The maximum output power requirement is the maximum equivalent isotropic radiated power delivering at the transmitting antenna under specified conditions of measurements in the presence of modulation.

The maximum output power and harmonics shall not exceed CFR47 Part 15.247 (b):2021 and RSS 247: 2017 Sect. 5.4 (d).

The maximum transmitted powers are

Band 2400-2483.5 MHz: 1 W

4.1.1 Test Method

The ANSI C63.10-2013 Section 11.9.2.2 conducted method was used to measure the channel power output. The preliminary investigation was performed at different data rate/ chain to determine the highest power output for each mode. The worst findings were conducted on 3 channels in each operating range per CFR47 Part 15.247(b): 2021 and RSS 247 Sect. 5.4 (d). This test was conducted on 3 channels of Sample, S/N PP #3. The worst mode result indicated below.

Test Setup:

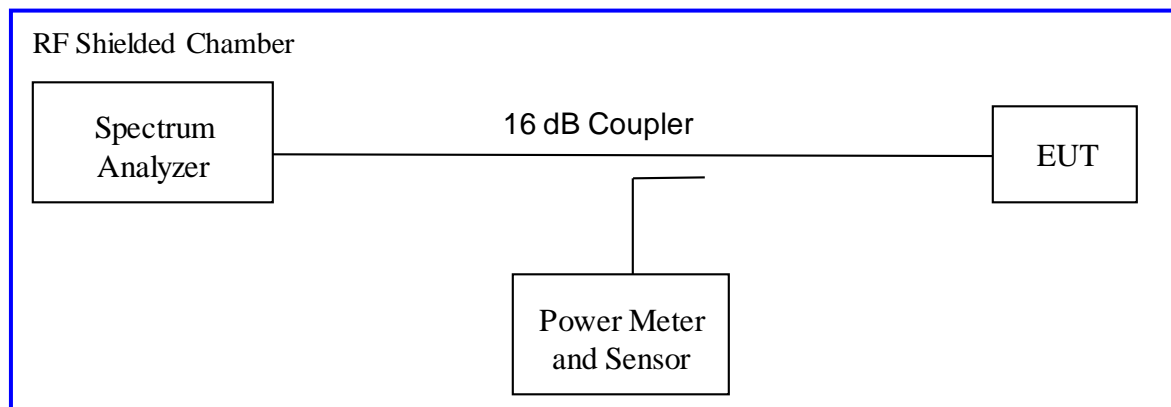

Method AVGSA-1 of "KDB 558074 – DTS Measurement Guidance v05r02" applies since the EUT continuously transmits with duty cycle greater than 98%. Sample detector was used.

4.1.2 Results

As originally tested, the EUT was found to be compliant to the requirements of the test standard(s).

Table 2: RF Output Power at the Antenna Port – Test Results

Test Date: December 4, 2021			Test By: Jeremy Luong		
Test Method: Conducted Measurements			Power Setting: Fixed at 4 dBm		
Antenna Type: Integrated PCB with Cable			Max. Antenna Gain: 4.0 dBi		
Operating Mode: Uncorrelated			Signal State: Modulated at 1 Mbps		
Ambient Temp.: 23 °C			Relative Humidity: 36%		
Wireless Audio Headset					
Frequency (MHz)	Limit [dBm]	Output [dBm]	Duty Cycle [dB]	∑ Power [dBm]	Margin [dB]
2402	+30.00	2.66	0.57	3.23	-26.77
2442	+30.00	2.85	0.57	3.42	-26.58
2480	+30.00	2.88	0.57	3.45	-26.55
Note: The headset transmitted at 87.75% duty cycle. The highest output power observed was at 1 Mbps.					

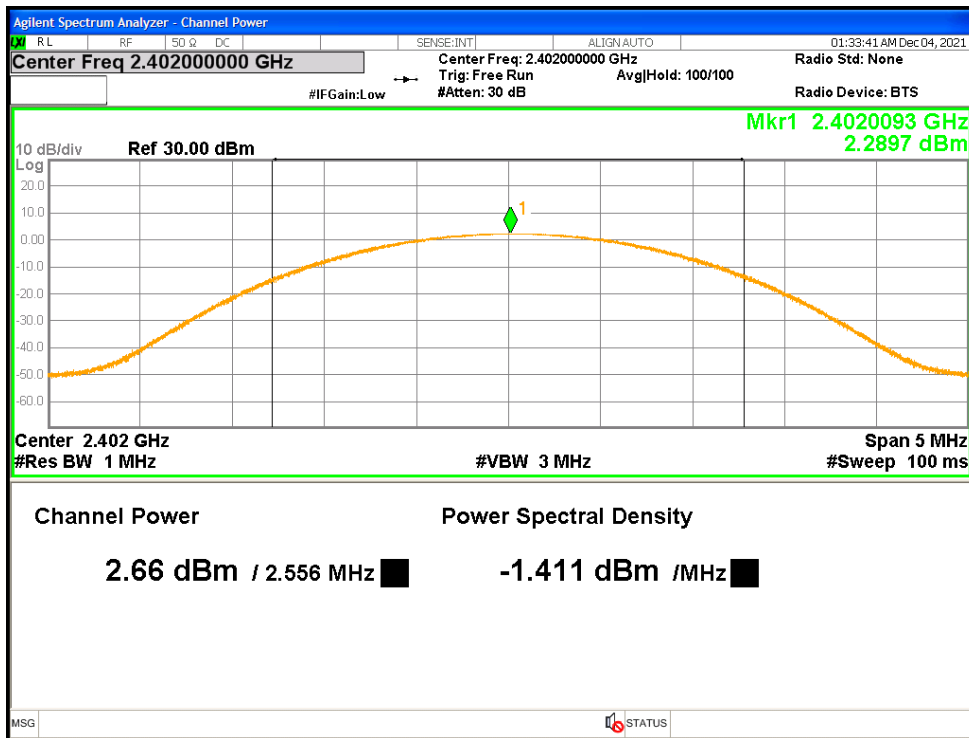

Figure 2: Maximum Transmitted Power, 2402 MHz

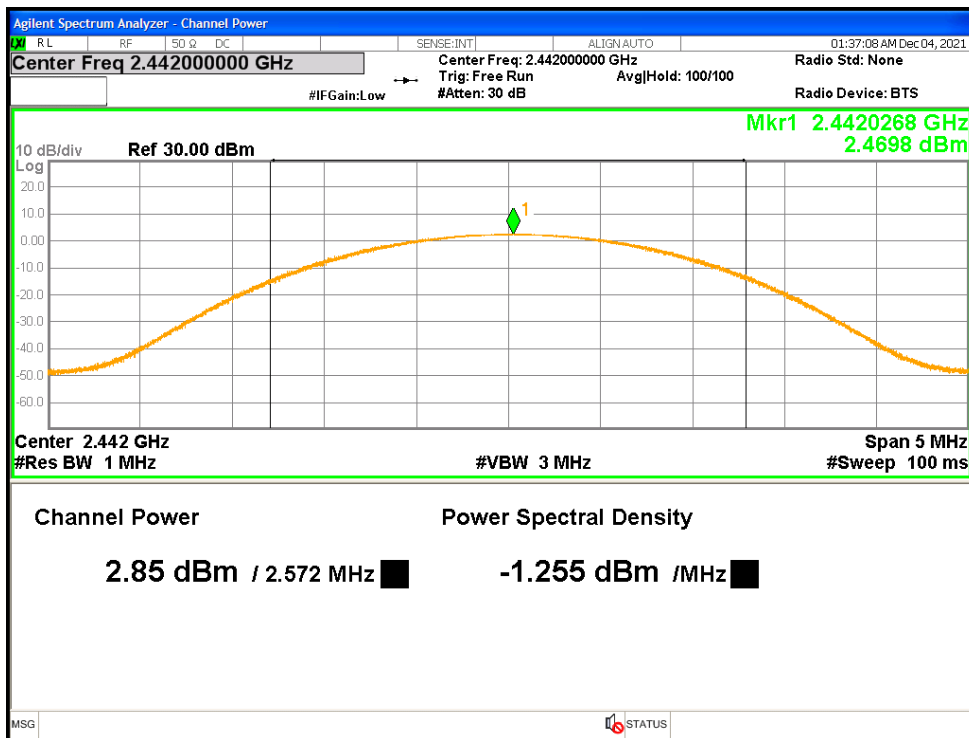

Figure 3: Maximum Conducted Output Power at 2442 MHz

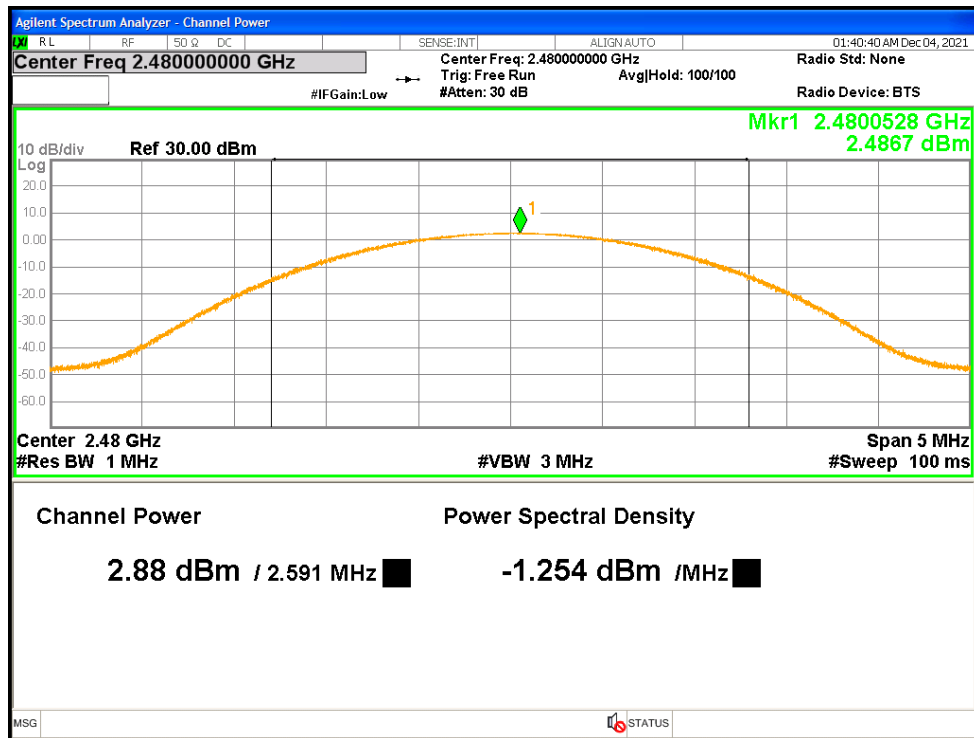

Figure 4: Maximum Conducted Output Power at 2480 MHz

4.2 Occupied Bandwidth

The occupied bandwidth is measured at an amplitude level reduced from the reference level by a specified ratio. The reference level is the level of the highest amplitude signal observed from the transmitter at the fundamental frequency.

The 99% bandwidth is the bandwidth in which 99% of the transmitted power occupied.

The minimum 6 dB bandwidth shall be at least 500 kHz.

The bandwidth shall be at least 500 kHz per Section CFR47 15.247(a) 2021 and RSS 247 Sect.5.2 (a) 2017

4.2.1 Test Method

The conducted method was used to measure the occupied bandwidth according to ANSI C63.10:2013 Section 11.8.1. The measurement was performed with modulation per CFR47 15.247(a) (2) 2021 and RSS 247 Sect. 5.2 (a) 2017. The preliminary investigation was performed to find the narrowest 6 dB bandwidth for each operational mode at different data rates. This worst finding was performed on 3 channels in each operating frequency range; 2400 MHz to 2483.5 MHz. This test was conducted on 3 channels in each mode of Sample S/N PP #3. The worst sample result indicated below.

Test Setup:

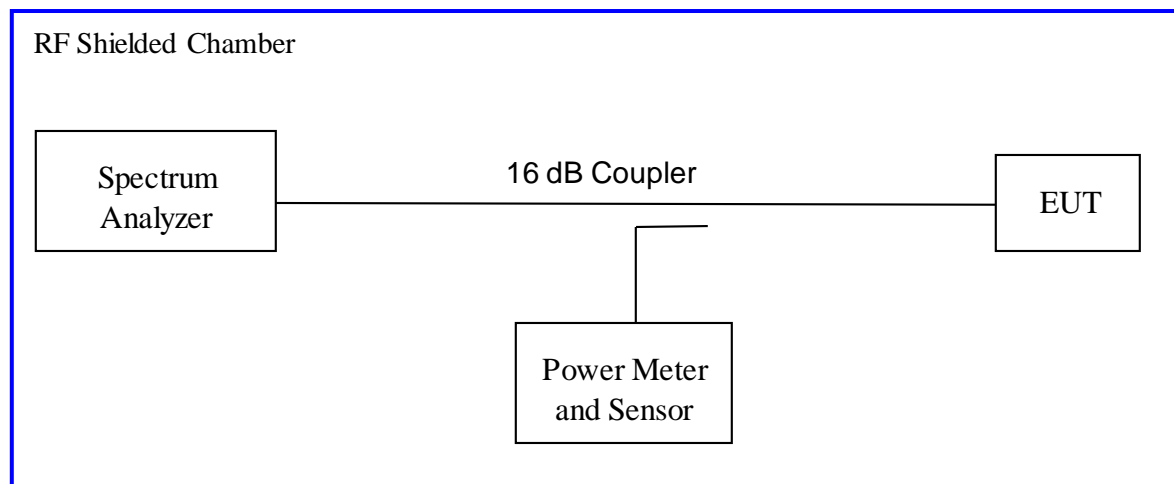

4.2.2 Results

As originally tested, the EUT was found to be compliant to the requirements of the test standard(s).

Test report no.: US21P7P4.001 Rev.:01

Page 22 of 60

Table 3: Occupied Bandwidth – Test Results

Test Date: December 4, 2021		Test By: Jeremy Luong		
Test Method: Conducted Measurements		Power Setting: Fixed at 4 dBm		
Antenna Type: Integrated PCB with Cable		Max. Antenna Gain: 4.0 dBi		
Operating Mode: Uncorrelated		Signal State: Modulated at 1 Mbps		
Ambient Temp.: 23 °C		Relative Humidity: 36%		
Bandwidth (MHz) for Wireless Audio Headset				
Frequency (MHz)	Limit (kHz)	99% Bandwidth	6 dB Bandwidth	Results
2402	500	1.029	0.721	Pass
2442	500	1.036	0.735	Pass
2480	500	1.039	0.733	Pass
Note: The narrower bandwidth was measured at 1 Mbps and 87.75% duty cycle				

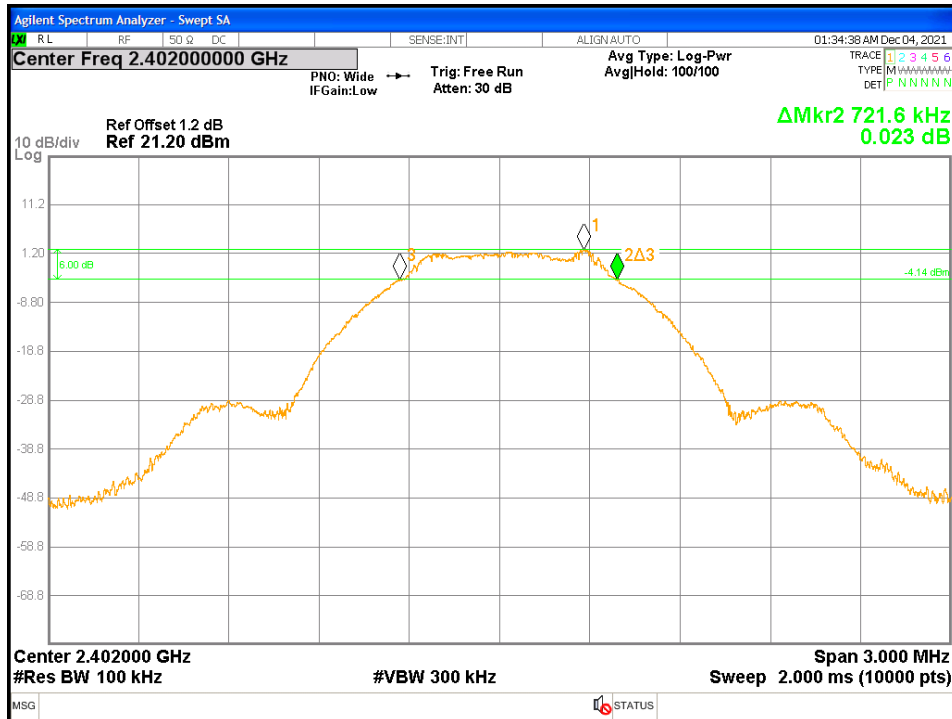

Figure 5: DTS Bandwidth-Headset -2402 MHz



Figure 6: DTS Bandwidth-Headset -2442 MHz

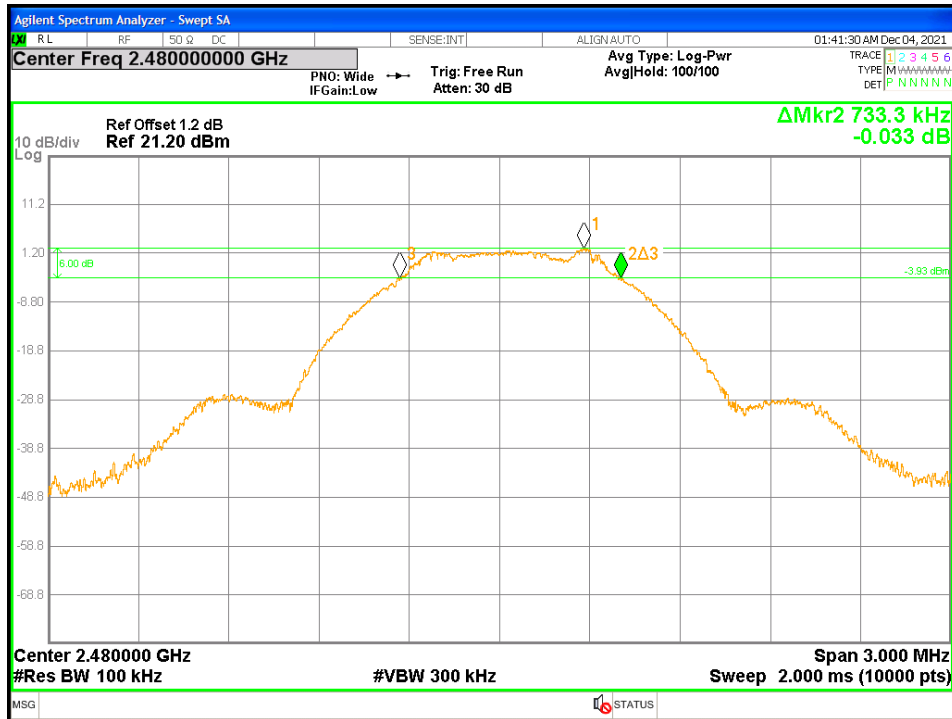

Figure 7: DTS Bandwidth-Headset -2480 MHz

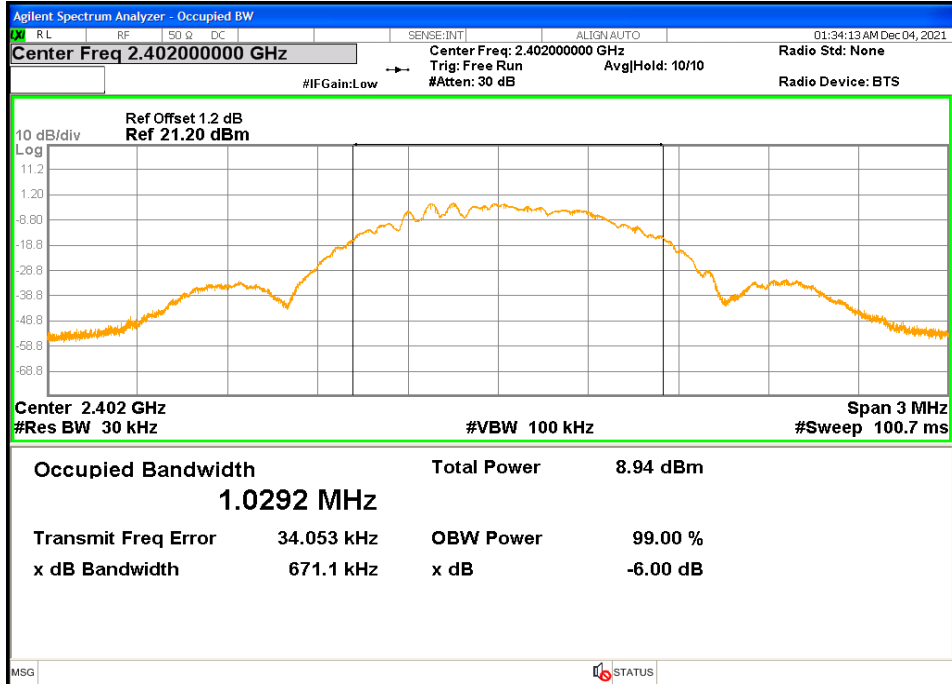

Figure 8: 99% Bandwidth-Headset -2402 MHz

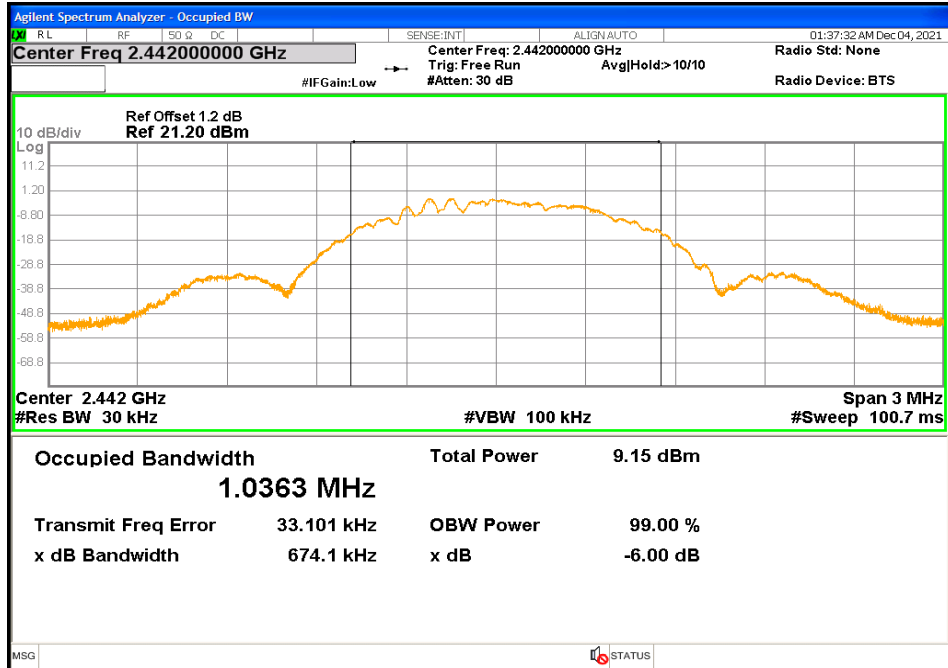

Figure 9: 99% Bandwidth-Headset -2442 MHz

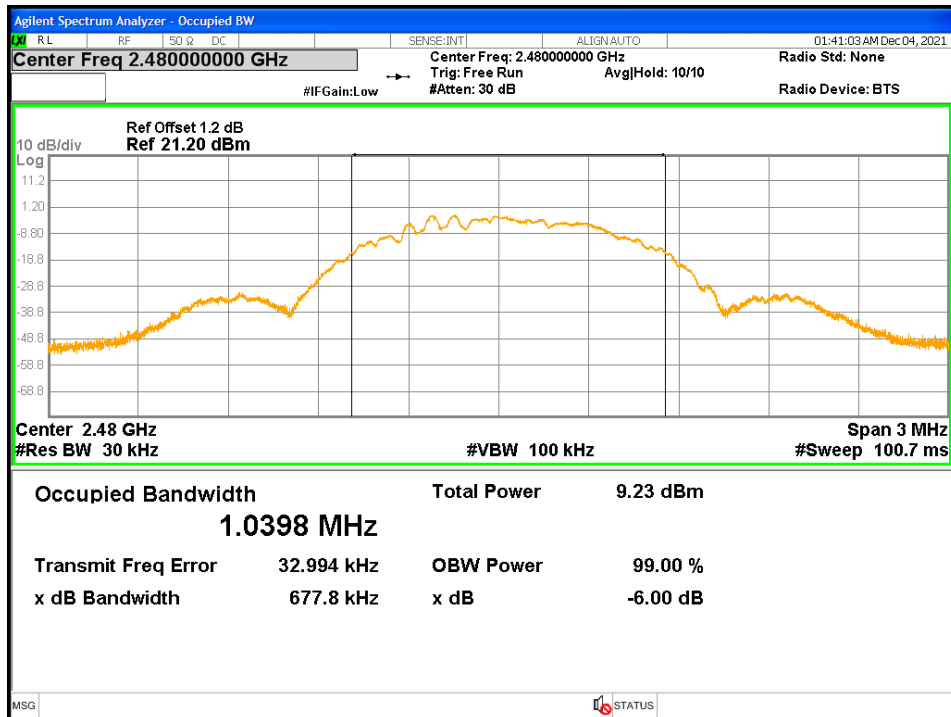

Figure 10: 99% Bandwidth-Headset -2480 MHz

4.3 Peak Power Spectral Density

According to the CFR47 Part 15.247 (e) and RSS 247 Sect.5.2 (b), the power spectral density conducted from the intentional radiator to the antenna shall not be greater than 8 dBm in any 3 kHz band during any time interval of continuous transmission.

4.3.1 Test Method

The conducted method was used to measure the channel power output per ANSI C63.10-2013 Section 11.10.3. The measurement was performed with modulation per CFR47 Part 15.247 (e) and RSS 247 Sect.5.2 (b). The pre-evaluation was performed to find the worst modes. The worst findings were conducted on 3 channels in each operating frequency range of 2400 MHz to 2483.5 MHz. This test was conducted on 3 channels of Sample SN PP #3. The worst sample result indicated below.

Test Setup:

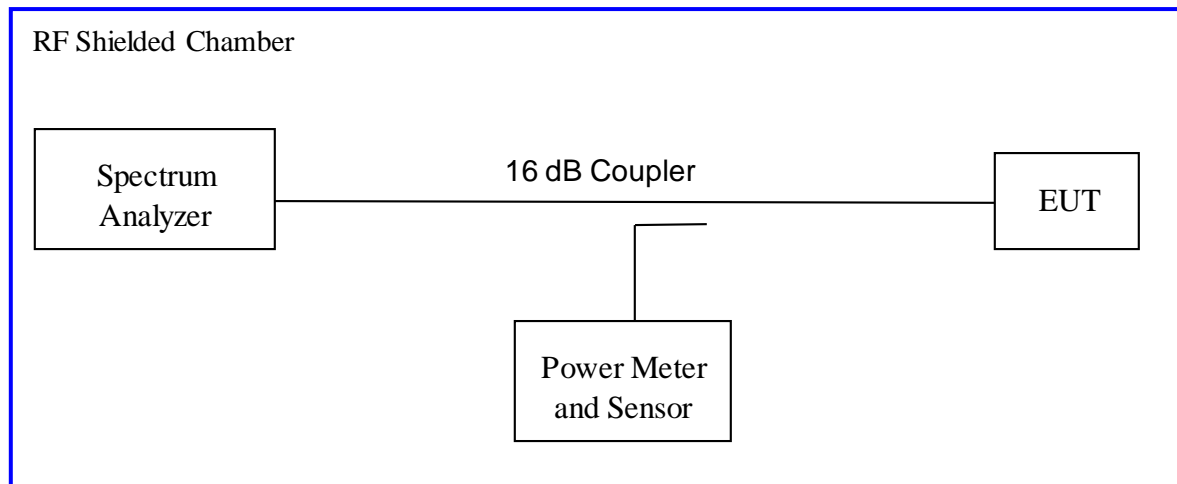

4.3.2 Results

As originally tested, the EUT was found to be compliant to the requirements of the test standard(s).

Table 4: Peak Power Spectral Density – Test Results

Test Date: December 4, 2021			Test By: Jeremy Luong			
Test Method: Conducted Measurements			Power Setting: Fixed at 4 dBm			
Antenna Type: Integrated PCB with Cable			Max. Antenna Gain: 4.0 dBi			
Operating Mode: Uncorrelated			Signal State: Modulated at 1 Mbps			
Ambient Temp.: 23 °C			Relative Humidity: 36%			
Peak Power Spectral Density						
Freq. (MHz)	Config.	Output [dBm]	CF [dB]	Max. PPSD [dBm]	Limit [dBm]	Margin [dB]
2402	Headset	-3.50	-14.66	-18.16	8.00	-26.16
2442	Headset	-3.39	-14.66	-18.05	8.00	-26.05
2480	Headset	-3.73	-14.66	-18.39	8.00	-26.39
<p>Note: The bandwidth ratio is $10 \cdot \log(3\text{kHz}/100\text{kHz})$ or -15.23 dB. The wireless headset transmitted at 87.75% duty cycle; 0.57 dB CF accounted for the measured RBW and duty cycle; -14.66 dB</p>						

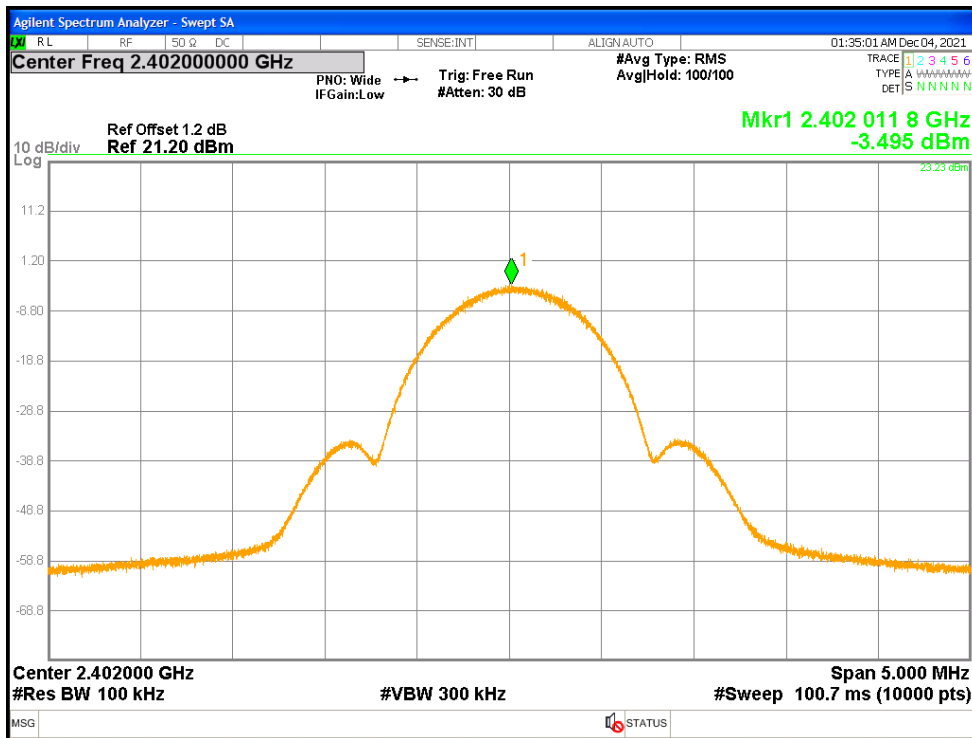

Figure 11: Maximum Power Spectral Density-2402 MHz

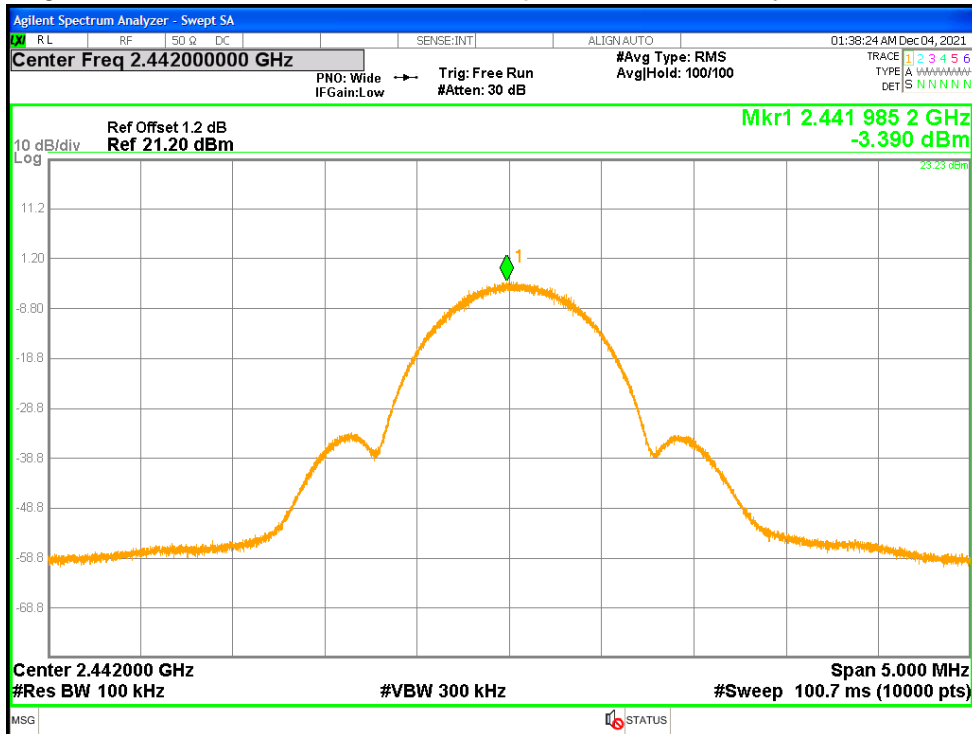

Figure 12: Maximum Power Spectral Density-2442 MHz

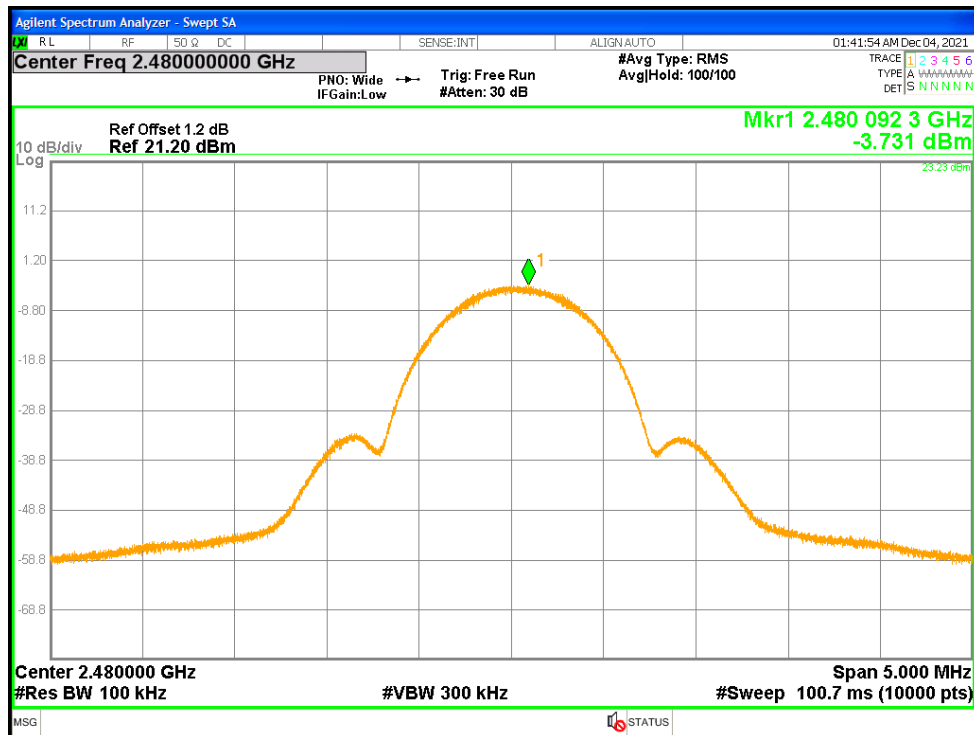

Figure 13: Maximum Power Spectral Density-2480 MHz

4.4 Out of Band Emissions

The setup was identical to RF output power measurement. Intentional radiators operating under the alternative provisions to the general emission limits, must be designed to ensure that the 20 dB or 30 dB bandwidth of the emission, or whatever bandwidth may otherwise be specified in the specific rule section under which the equipment operates, is contained within the frequency band designated in the rule section under which the equipment is operated. The requirement to contain the designated bandwidth of the emission within the specified frequency band includes the effects from frequency sweeping, frequency hopping and other modulation techniques that may be employed as well as the frequency stability of the transmitter over expected variations in temperature and supply voltage. If the frequency stability is not specified in the regulations, it is recommended that the fundamental emission be kept within at least the central 80% of the permitted band in order to minimize the possibility of out-of-band operation.

Since the transmitter complies with the conducted power limits base on the use of RMS averaging per CFR47 Part 15.247(b)(3), any frequency outside the band of 2400MHz to 2483.5MHz, the power output level must be below 30db from the in-band transmitting signal; CFR 47 Part 15.215, 15.247(d) and RSS-247 Sect.5.5..

4.4.1 Test Method

The conducted method was used to measure the out-of-band emission requirement. The measurement was performed with modulation per CFR47 15.247(4) (d) 2021 and RSS-247 Sect.5.5: 2017. This test was conducted on 3 channels of Sample S/NPP #3. The worst sample result indicated below.

Test Setup:

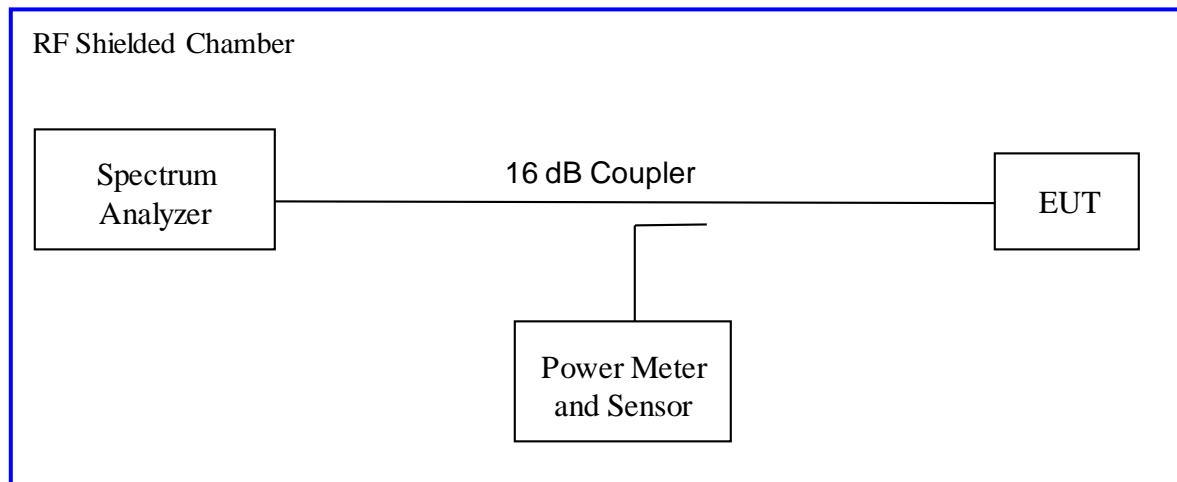

4.4.2 Results

As originally tested, the EUT was found to be compliant to the requirements of the test standard(s).

Table 5: Out of Band Emissions – Test Results

Test Date: December 4, 2021		Test By: Jeremy Luong	
Test Method: Conducted Measurements		Power Setting: Fixed at 4 dBm	
Antenna Type: Integrated PCB with Cable		Max. Antenna Gain: 4.0 dBi	
Operating Mode: Uncorrelated		Signal State: Modulated at 1 Mbps	
Ambient Temp.: 22 °C		Relative Humidity: 36%	
Out of Band Results for Wireless Audio Headset			
Operating Channel	Out of Band Level (dBm)	30 dBc Level (dBm)	Margin (dB)
2402 MHz	-39.65	-28.05	-11.60
2442 MHz	-40.71	-27.76	-12.95
2480 MHz	-38.49	-27.77	-10.72
<p>Note: dBc is defined as the level below the main carrier. The band-edge level must be lower than the 30 dBc level. The maximum out of band emission on each individual output is at least 30 dB below the maximum in-band PSD on that output. (*) The band-edge is compared to the highest -30 dBc level of the test mode.</p>			

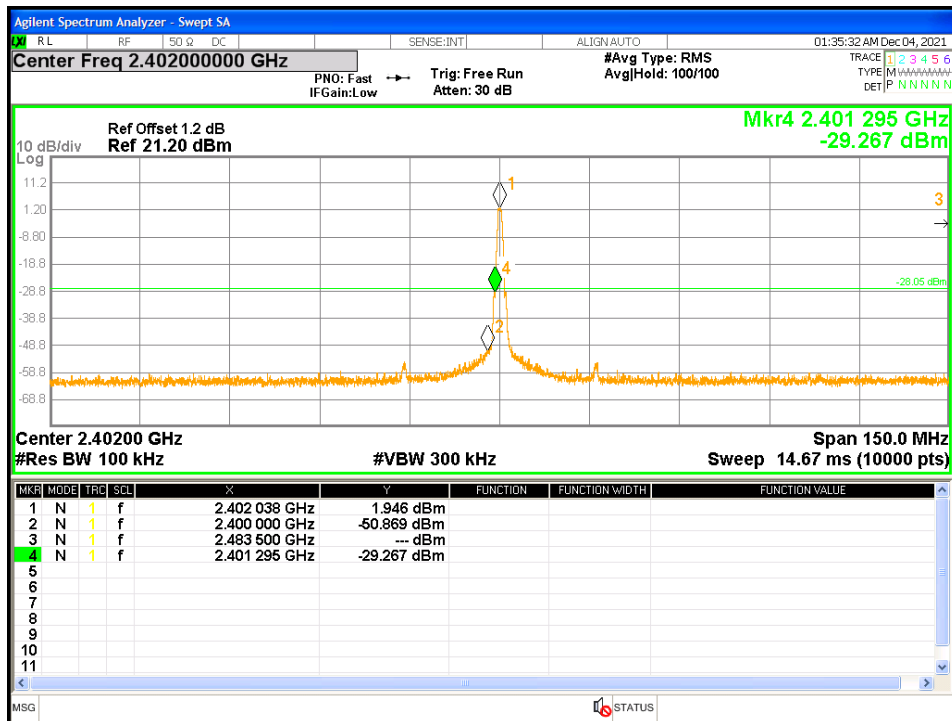

Figure 14: Conducted Band Edge at 2402 MHz

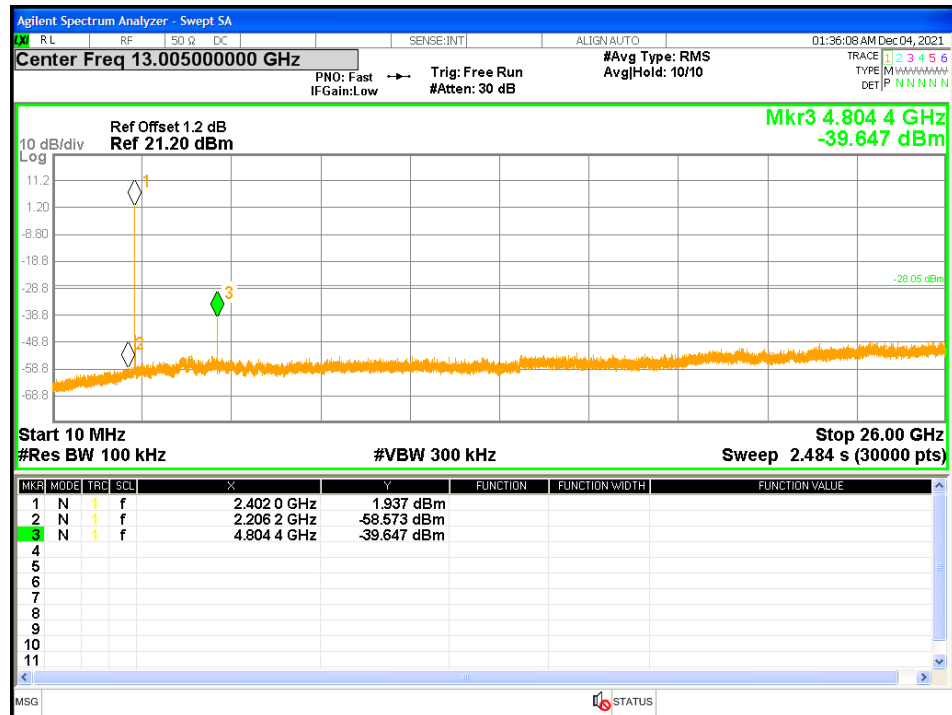

Figure 15: Out of band Emissions at 2402 MHz

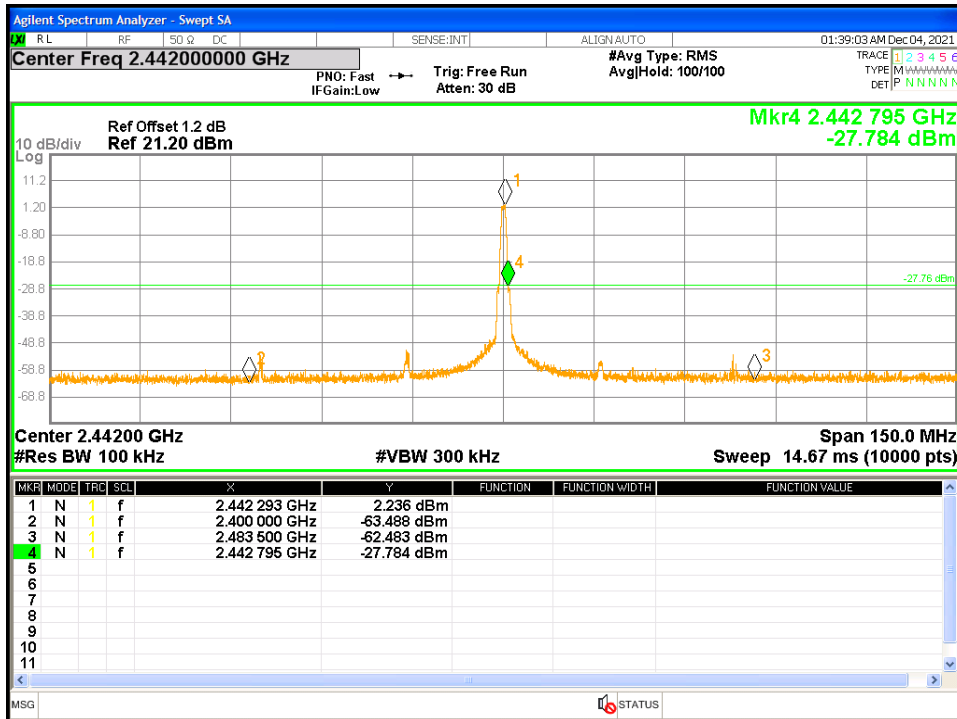

Figure 16: Conducted Band Edge at 2442 MHz

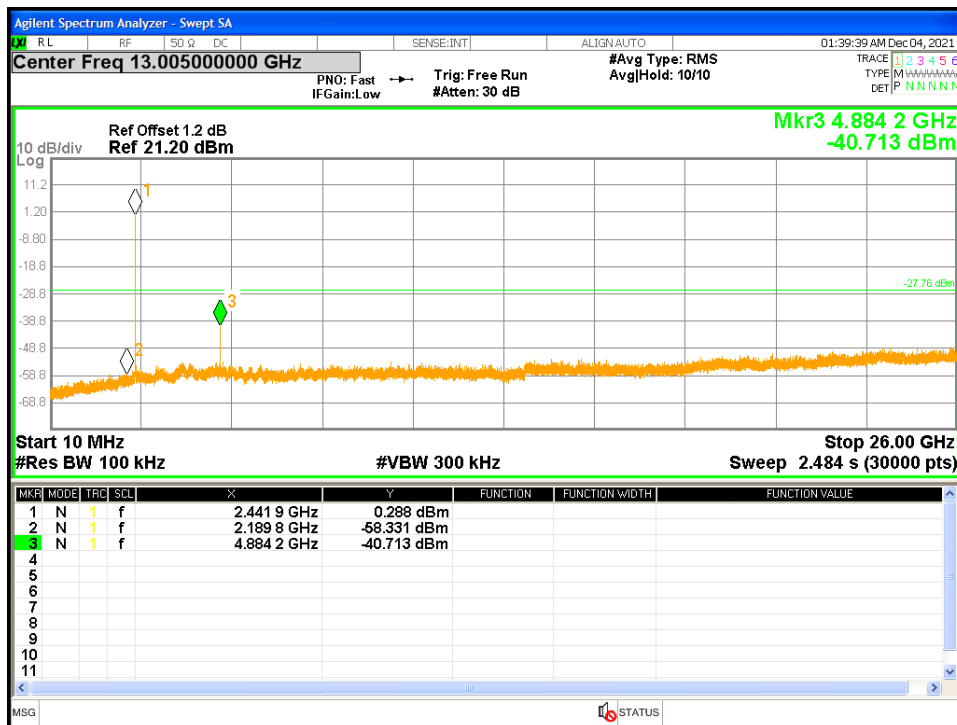

Figure 17: Out of band Emissions at 2442 MHz

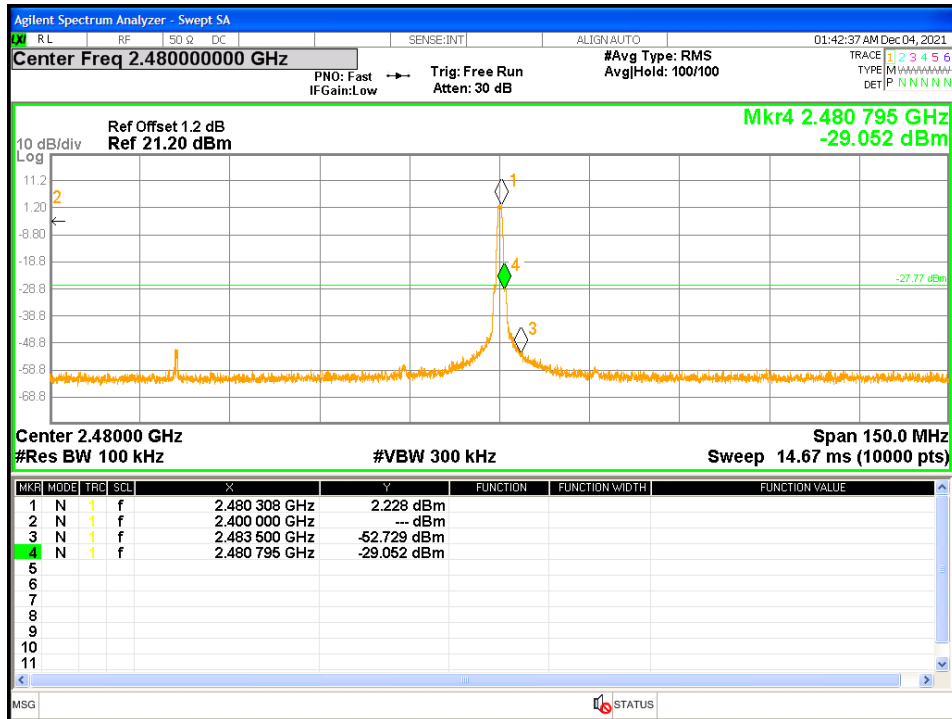

Figure 18: Conducted Band Edge at 2480 MHz

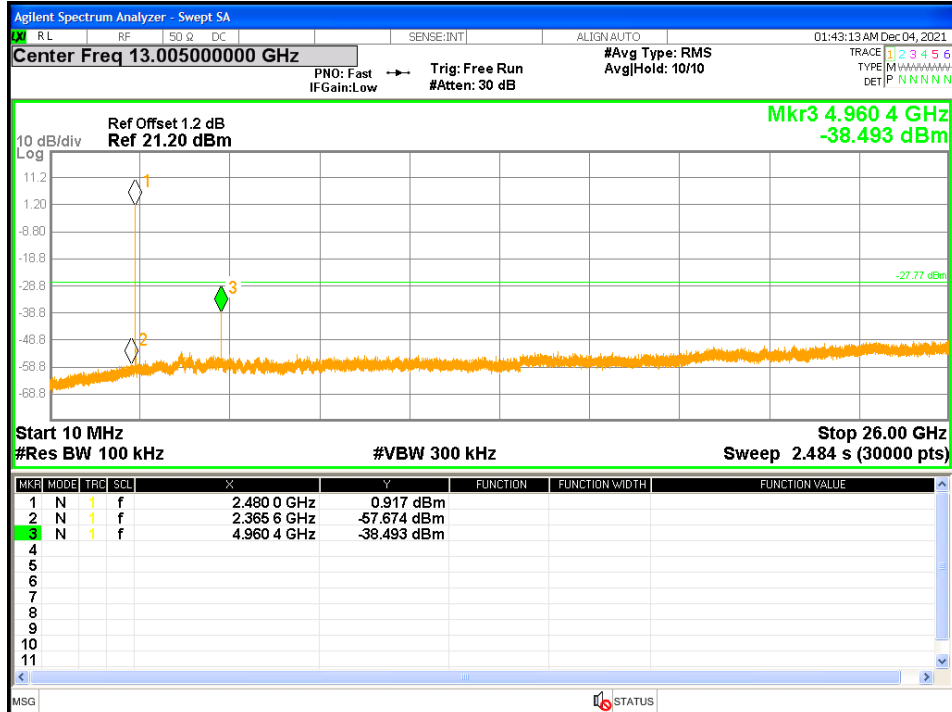

Figure 19: Out of band Emissions at 2480 MHz

4.5 Transmit Spurious Emissions

Transmitter spurious emissions are emissions outside the frequency range of the equipment when the equipment is in transmit mode; per requirement of CFR47 15.205, 15.209, 15.247(d), RSS-Gen Sect. 8.9.

4.5.1 Test Methodology

4.5.1.1 Preliminary Test

A test program that controls instrumentation and data logging was used to automate the preliminary RF emission test procedure. The frequency range of interest was divided into sub-ranges to yield a frequency resolution of approximately 120 kHz and provide a reading at each frequency for no more than 12° of turntable rotation. For each frequency sub-range the turntable was rotated 360° while peak emission data was recorded and plotted over the frequency range of interest in horizontal and vertical antenna polarization's.

Preliminary emission profile testing was performed inside the anechoic chamber. The EUT was placed on a 1.0m x 1.5m non-conductive table 80cm (<1 GHz) and 150cm (>1 GHz) above the floor. The EUT was positioned as shown in the setup photographs. The receiving antenna was placed at a distance of 3m at a fixed height of 1m. Measurement equipment was located outside of the chamber. A video camera was placed inside the chamber to view the EUT.

Pres-scans were performed to determine the worst case configuration for data rate.

4.5.1.2 Final Test

For each frequency measured, the peak emission was maximized by manipulating the receiving antenna from 1 to 4 meters above the ground plane and placing it at the position that produced the maximum signal strength reading. The turntable was then rotated through 360° while observing the peak signal and placing the EUT at the position that produced maximum radiation. The six highest emissions relative to the limit were measured unless such emissions were more than 20 dB below the limit. If less than six emissions are within 20 dB of the limit, than the noise level of the receiver is measured at frequencies where emissions are expected. Multiples of all oscillator and microprocessor frequencies were also checked.

Final testing was performed on an NSA compliant test site. The EUT was placed on a 1.0m x 1.5m non-conductive table 80cm (<1 GHz) and 150cm (>1 GHz) above the ground plane. The placement of EUT and cables were the same as for preliminary testing and is shown in the setup photographs.

The final scans performed on the worst axis, Y-Axis up, for three operating channels in each operating mode;

2402 MHz, 2442 MHz, and 2480 MHz

4.5.1.3 Deviations

None.

Test Setup:

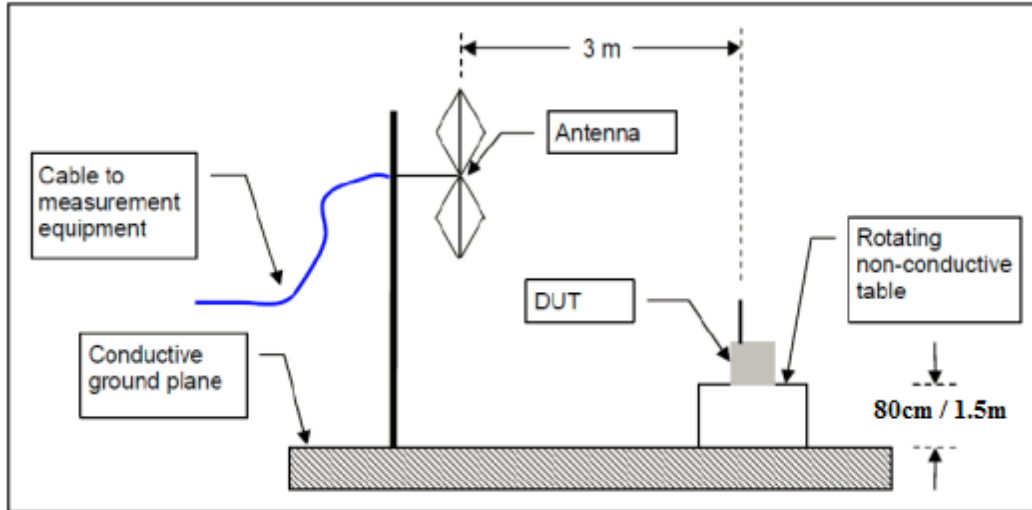

4.5.2 Transmitter Spurious Emission Limit

The spurious emissions of the transmitter shall not exceed the values in CFR47 Part 15.205, 15.209: 2021 and RSS Gen Sect. 8.10: 2019.

Frequency (MHz)	Measurement Field strength (microvolts/meter)	Measurement distance (meters)
0.009-0.490.....	2400/F(kHz)	300
0.490-1.705.....	24000/F(kHz)	30
1.705-30.0.....	30	30
30-88.....	100 **	3
88-216.....	150 **	3
216-960.....	200 **	3
Above 960.....	500	3

All harmonics and spurious emission which are outside of the restricted band shall be 20dB below the in-band emission.

4.5.3 Test Results

The final measurement data was taken under the worst case operating modes, configurations, and/or cable positions. It also reflects the results including any modifications and/or special accessories listed in Sections 1.4 and test plan.

As originally tested, the EUT was found to be compliant to the requirements of the test standard(s).

Table 6: Transmit Spurious Emission at Band-Edge Requirements

Test Date: December 3, 2021					Test By: Jeremy Luong					
Test Method: Radiated Measurements					Power Setting: Fixed at 4 dBm					
Antenna Type: Integrated PCB with Cable					Max. Antenna Gain: 4.0 dBi					
Operating Mode: Uncorrelated					Signal State: Modulated at 2 Mbps					
Ambient Temp.: 22 °C					Relative Humidity: 37%					
Band-Edge Results										
Freq.	Edge Freq.	Raw	CF	Level	Det.	Pol	Ant.	Tbl.	Limit	Margin
MHz	MHz	dBuV/m	dB	dBuV/m	Pk/Avg	V/H	cm	Deg	dBuV/m	dB
2402	2401.93*	71.35	30.09	101.44	Pk	V	156	2		
2402	2401.93*	51.53	30.09	81.62	Ave	V	156	2		
2402	2390.33	14.56	30.01	44.57	Pk	V	107	68	74.00	-29.43
2402	2390.33	-1.42	30.01	28.59	Ave	V	107	68	54.00	-25.41
2402	2402.04*	71.56	30.09	101.65	Pk	H	137	123		
2402	2402.04*	59.12	30.09	89.21	Ave	H	137	123		
2402	2389.65	14.37	30.01	44.38	Pk	H	149	222	74.00	-29.62
2402	2389.65	-1.42	30.01	28.59	Ave	H	149	222	54.00	-25.41
2480	2479.93*	70.58	30.15	100.73	Pk	V	192	5		
2480	2479.93*	55.51	30.15	85.66	Ave	V	192	5		
2480	2483.50	23.55	30.16	53.71	Pk	V	178	42	74.00	-20.29
2480	2483.50	-1.22	30.68	29.46	Ave	V	178	42	54.00	-24.54
2480	2479.85*	71.38	30.15	101.53	Pk	H	191	96		
2480	2479.85*	59.50	30.15	89.65	Ave	H	191	96		
2480	2483.50	15.91	30.68	46.59	Pk	H	202	84	74.00	-27.41
2480	2483.50	9.11	30.16	39.27	Ave	H	202	84	54.00	-14.73
<p>Note: The emissions were measured at the adjacent restricted band of the fundamental signal. All of the band-edge measurements met the restricted band requirements of CFR47 15.205 Band-edge measurement plots use a wider span than 2 MHz to evaluate additional spectrum bands for in-band leakage and spurious emissions. (*) Fundamental/ Inband emission.</p>										

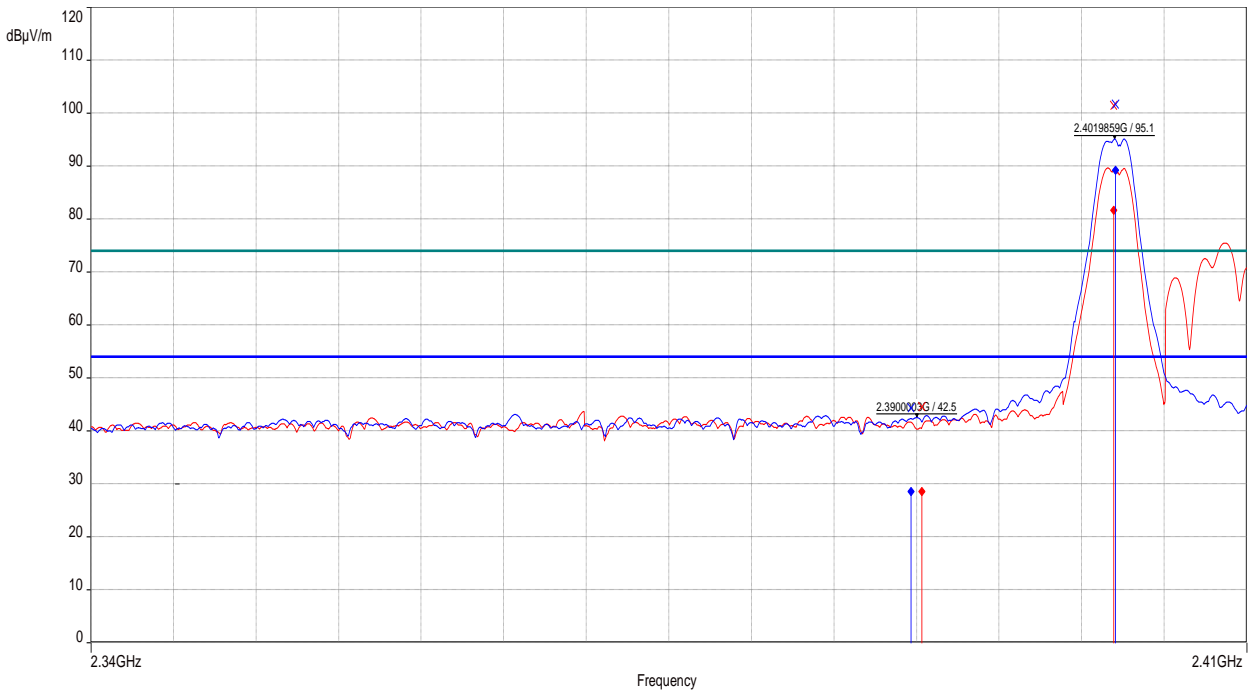

Figure 20: Band-edge-2402 MHz

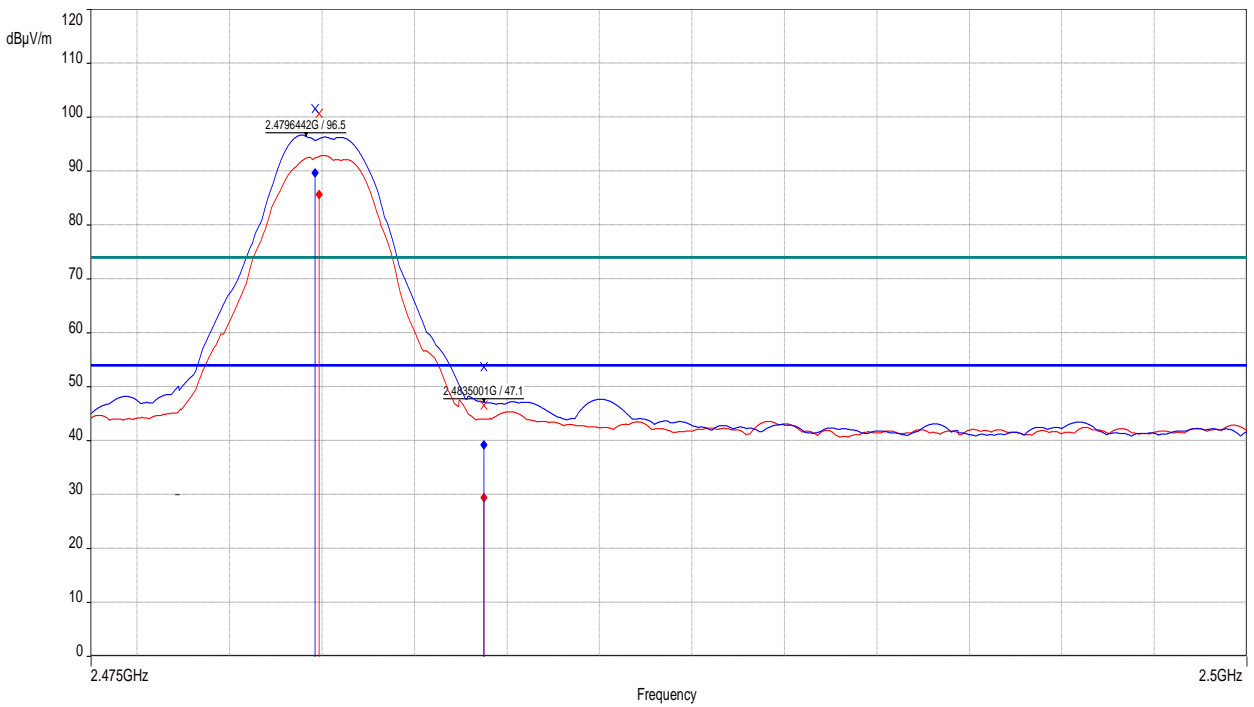

Figure 21: Band-edge-2480 MHz

SOP 1 Radiated Emissions						Tracking # US21P7P4.001 Page 1 of 10					
EUT Name	Wireless Audio Headset					Date	December 3, 2021				
EUT Model	Stealth 700P Gen 2 RX2					Temp / Hum in	23°C / 37% rh				
EUT Serial	PP #4					Temp / Hum out	N/A				
EUT Config.	Headset upright					Line AC / Freq	3.7 VDC				
Standard	CFR47 Part 15 Subpart C					RBW / VBW	120 kHz/ 300 kHz				
Dist/Ant Used	3m / JB3 & 6502					Performed by	Jeremy Luong				
Freq.	Raw	Corrd'	Level	Det.	Pol.	Hght.	Azt	Limit	Margin	Result	
MHz	dBuV/m	dB	dBuV/m		H/V	cm	deg	dBuV/m	dB		
9 kHz to 1 GHz, Transmitted Data at 2480 MHz											
0.437	44.24	12.31	56.55	Pk	Z-Axis	100	253	94.80	-38.25	Pass	
36.15	36.98	-8.54	28.44	QP	V	108	63	40.00	-11.56	Pass	
54.18	35.35	-17.85	17.50	QP	V	116	158	40.00	-22.50	Pass	
108.00	44.18	-12.87	31.31	QP	V	110	94	43.50	-12.19	Pass	
120.00	40.28	-11.32	28.96	QP	V	127	85	43.50	-14.54	Pass	
123.00	21.65	-11.20	10.45	QP	V	253	304	43.50	-33.05	Pass	
132.00	42.25	-11.24	31.01	QP	V	104	360	43.50	-12.49	Pass	
180.00	43.46	-13.55	29.91	QP	H	143	4	43.50	-13.59	Pass	
368.82	21.91	-8.86	13.05	QP	H	106	250	46.00	-32.95	Pass	
Spec Margin = Level - Limit, Level = Raw + Cb+ CF ± Uncertainty											
CF= Amp Gain + ANT Factor											
Combined Standard Uncertainty $U_c(y) = \pm 3.2$ dB Expanded Uncertainty $U = kU_c(y)$ $k = 2$ for 95% confidence											
Note: The worst case emission was observed on Channel 2480 MHz.											

SOP 1 Radiated Emissions							Tracking # US21P7P4.001 Page 2 of 10			
EUT Name	Wireless Audio Headset					Date	December 1, 2021			
EUT Model	Stealth 700P Gen 2 RX2					Temp / Hum in	23°C / 39% rh			
EUT Serial	PP #4					Temp / Hum out	N/A			
EUT Config.	Headset upright					Line AC / Freq	3.7 VDC			
Standard	CFR47 Part 15 Subpart C					RBW / VBW	1 MHz / 3 MHz			
Dist/Ant Used	3m / EMCO-3115, 1m / ComPower-AHA840					Performed by	Jeremy Luong			
Freq	Raw	Corrd'	Level	Det	Pol	Hght	Azt	Limit	Margin	Comment
MHz	dBuV/m	dB	dBuV/m		H/V	cm	deg	dBuV/m	dB	
Transmitted Data at 2402 MHz										
4803.56	77.90	-22.75	55.15	Pk	V	104	137	74.00	-18.85	Harmonics
4803.56	71.10	-22.75	48.35	Ave	V	104	137	54.00	-5.65	Harmonics
7205.40	64.69	-19.12	45.57	Pk	V	286	100	74.00	-28.43	Harmonics
7205.40	53.90	-19.12	34.78	Ave	V	286	100	54.00	-19.22	Harmonics
9609.13	70.37	-15.36	55.01	Pk	V	288	101	74.00	-18.99	Harmonics
9609.13	61.08	-15.36	45.72	Ave	V	288	101	54.00	-8.28	Harmonics
4803.56	78.24	-22.75	55.49	Pk	H	103	92	74.00	-18.51	Harmonics
4803.56	71.18	-22.75	48.43	Ave	H	103	92	54.00	-5.57	Harmonics
9609.13	72.34	-15.36	56.98	Pk	H	103	9	74.00	-17.02	Harmonics
9609.13	63.64	-15.36	48.28	Ave	H	103	9	54.00	-5.72	Harmonics
Transmitted Data at 2442 MHz										
4883.56	77.69	-22.38	55.31	Pk	V	150	95	74.00	-18.69	Harmonics
4883.56	70.87	-22.38	48.49	Ave	V	150	95	54.00	-5.51	Harmonics
7325.41	65.29	-18.69	46.60	Pk	V	120	139	74.00	-27.40	Harmonics
7325.41	55.02	-18.69	36.33	Ave	V	120	139	54.00	-17.67	Harmonics
9769.13	72.47	-15.13	57.34	Pk	V	285	88	74.00	-16.66	Harmonics
9769.13	63.57	-15.13	48.44	Ave	V	285	88	54.00	-5.56	Harmonics
1110.46	65.65	-33.60	32.05	Pk	H	160	116	74.00	-41.95	Spurious
1110.46	49.93	-33.60	16.33	Ave	H	160	116	54.00	-37.67	Spurious
4884.57	75.71	-22.37	53.34	Pk	H	105	112	74.00	-20.66	Harmonics
4884.57	68.43	-22.37	46.06	Ave	H	105	112	54.00	-7.94	Harmonics
9769.13	75.08	-15.13	59.95	Pk	H	175	18	74.00	-14.05	Harmonics
9769.13	66.49	-15.13	51.36	Ave	H	175	18	54.00	-2.64	Harmonics
Transmitted Data at 2480 MHz										
1100.00	63.53	-33.51	30.02	Pk	V	254	240	74.00	-43.98	Spurious
1100.00	50.03	-33.51	16.52	Ave	V	254	240	54.00	-37.48	Spurious
4960.57	72.44	-22.45	49.99	Pk	V	114	95	74.00	-24.01	Harmonics
4960.57	63.82	-22.45	41.37	Ave	V	114	95	54.00	-12.63	Harmonics
9921.13	67.86	-14.66	53.20	Pk	V	145	90	74.00	-20.80	Harmonics
9921.13	57.70	-14.66	43.04	Ave	V	145	90	54.00	-10.96	Harmonics
1152.00	69.35	-33.90	35.45	Pk	H	220	140	74.00	-38.55	Spurious
1152.00	48.87	-33.90	14.97	Ave	H	220	140	54.00	-39.03	Spurious
4960.57	70.01	-22.45	47.56	Pk	H	103	95	74.00	-26.44	Harmonics
4960.57	61.57	-22.45	39.12	Ave	H	103	95	54.00	-14.88	Harmonics

Test report no.: US21P7P4.001 Rev.:01

Page 41 of 60

9921.13	72.22	-14.66	57.56	Pk	H	198	46	74.00	-16.44	Harmonics
9921.13	63.15	-14.66	48.49	Ave	H	198	46	54.00	-5.51	Harmonics

Spec Margin = Level - Limit, Level = Raw + Cbl+ CF ± Uncertainty

CF= Amp Gain + ANT Factor

Combined Standard Uncertainty $U_c(y) = \pm 3.2\text{dB}$ Expanded Uncertainty $U = kU_c(y)$ $k = 2$ for 95% confidence

Notes: All emissions passed the spurious emission limit.

(*) Non-restricted band emission

SOP 1 Radiated Emissions

Tracking # US21P7P4.001 Page 3 of 10

EUT Name	Wireless Audio Headset	Date	December 3, 2021
EUT Model	Stealth 700P Gen 2 RX2	Temp / Hum in	23°C / 37% rh
EUT Serial	PP #4	Temp / Hum out	N/A
EUT Config.	Headset upright	Line AC / Freq	3.7 VDC
Standard	CFR47 Part 15 Subpart C	RBW / VBW	1 MHz / 3 MHz
Dist/Ant Used	3m / JB3 & 6502	Date	Jeremy Luong

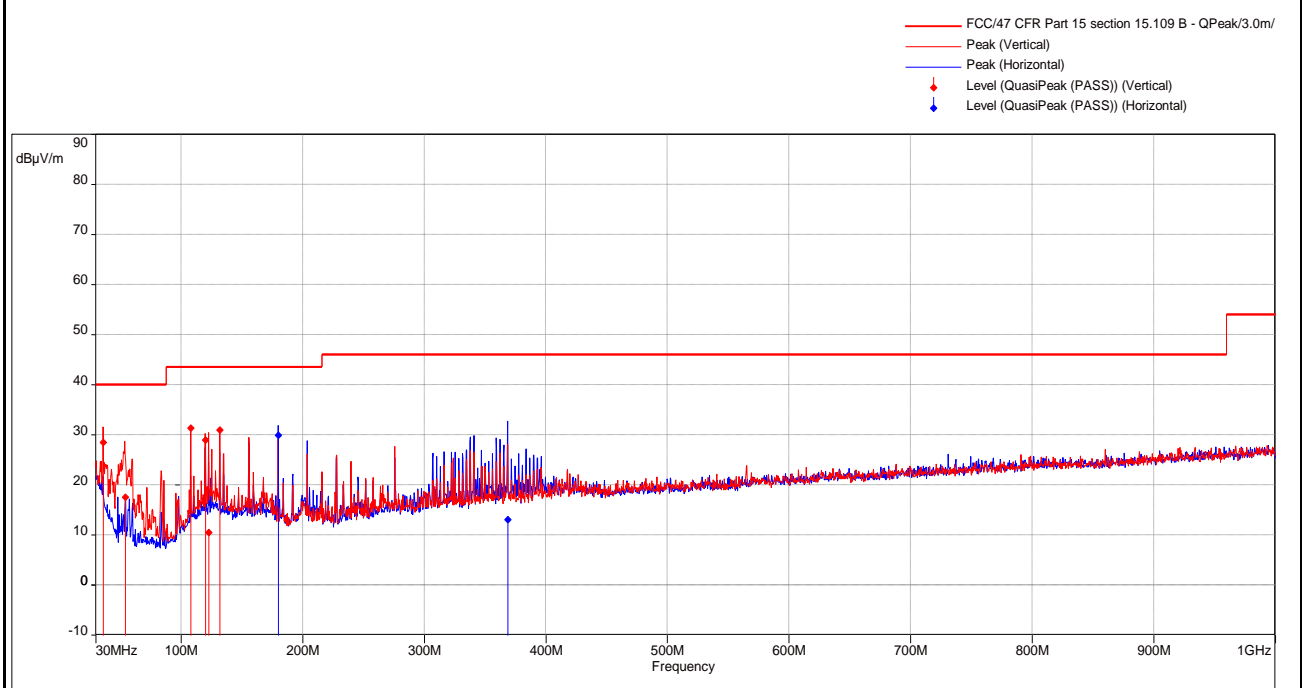
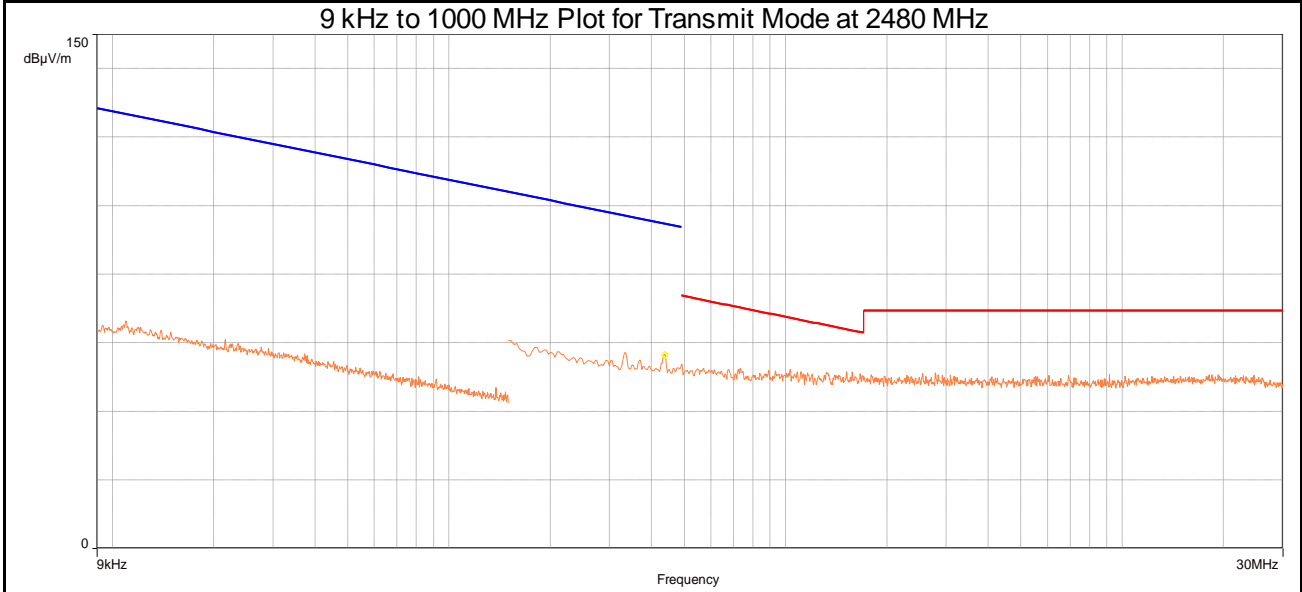

Notes: None.

SOP 1 Radiated Emissions

Tracking # US21P7P4.001 Page 4 of 10

EUT Name	Wireless Audio Headset	Date	December 1, 2021
EUT Model	Stealth 700P Gen 2 RX2	Temp / Hum in	23°C / 39% rh
EUT Serial	PP #4	Temp / Hum out	N/A
EUT Config.	Headset upright	Line AC / Freq	3.7 VDC
Standard	CFR47 Part 15 Subpart C	RBW / VBW	1 MHz / 3 MHz
Dist/Ant Used	3m / EMCO-3115, 1m / ComPower-AHA840	Performed by	Jeremy Luong

Above 1GHz Plots for Transmit Mode at 2402 MHz

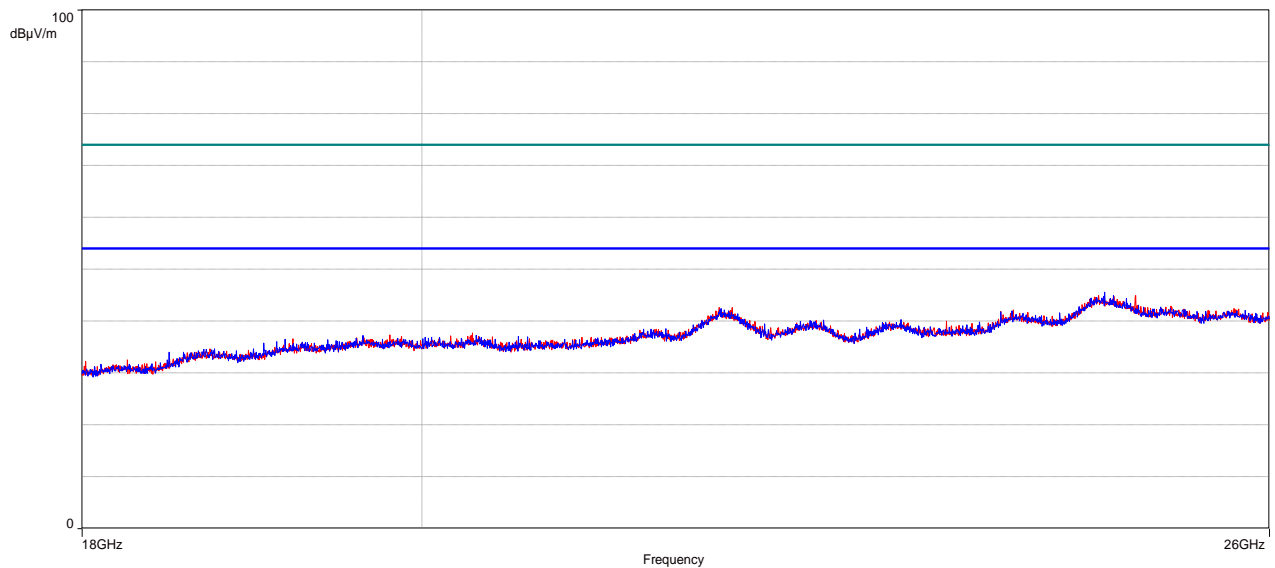
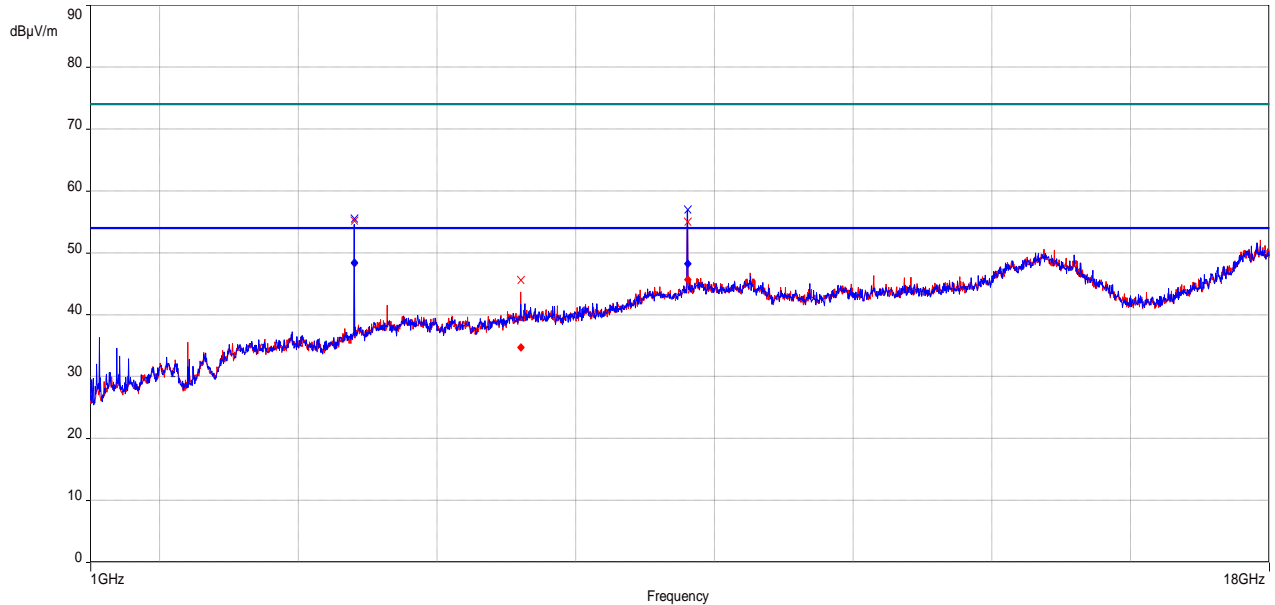

Notes: None.

SOP 1 Radiated Emissions

Tracking # US21P7P4.001 Page 5 of 10

EUT Name	Wireless Audio Headset	Date	December 1, 2021
EUT Model	Stealth 700P Gen 2 RX2	Temp / Hum in	23°C / 39% rh
EUT Serial	PP #4	Temp / Hum out	N/A
EUT Config.	Headset upright	Line AC / Freq	3.7 VDC
Standard	CFR47 Part 15 Subpart C	RBW / VBW	1 MHz / 3 MHz
Dist/Ant Used	3m / EMCO-3115, 1m / ComPower-AHA840	Performed by	Jeremy Luong

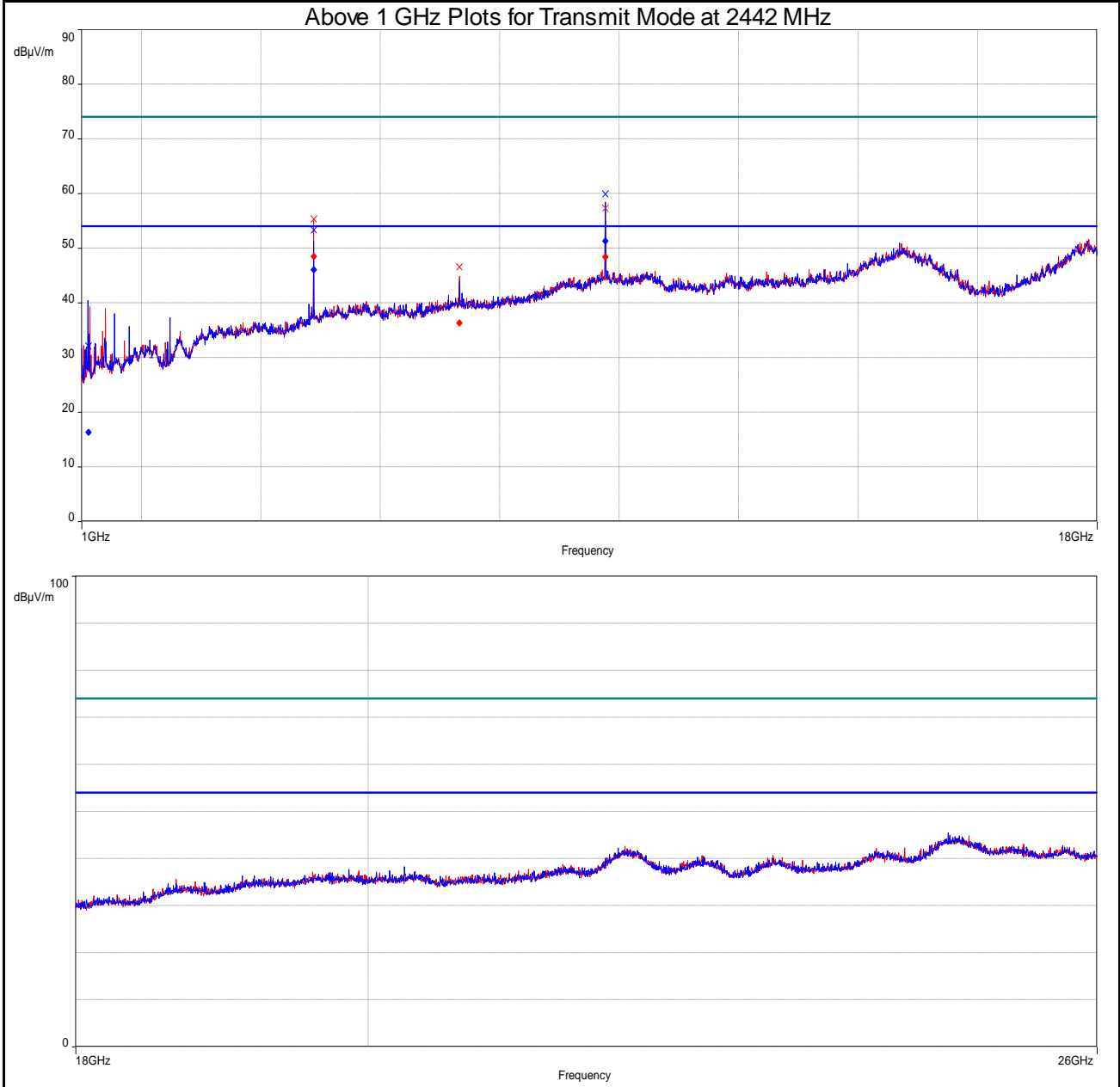

Notes: None.

SOP 1 Radiated Emissions

Tracking # US21P7P4.001 Page 6 of 10

EUT Name	Wireless Audio Headset	Date	December 1, 2021
EUT Model	Stealth 700P Gen 2 RX2	Temp / Hum in	23°C / 39% rh
EUT Serial	PP #4	Temp / Hum out	N/A
EUT Config.	Headset upright	Line AC / Freq	3.7 VDC
Standard	CFR47 Part 15 Subpart C	RBW / VBW	1 MHz / 3 MHz
Dist/Ant Used	3m / EMCO-3115, 1m / ComPower-AHA840	Performed by	Jeremy Luong

Above 1 GHz Plots for Transmit Mode at 2480 MHz

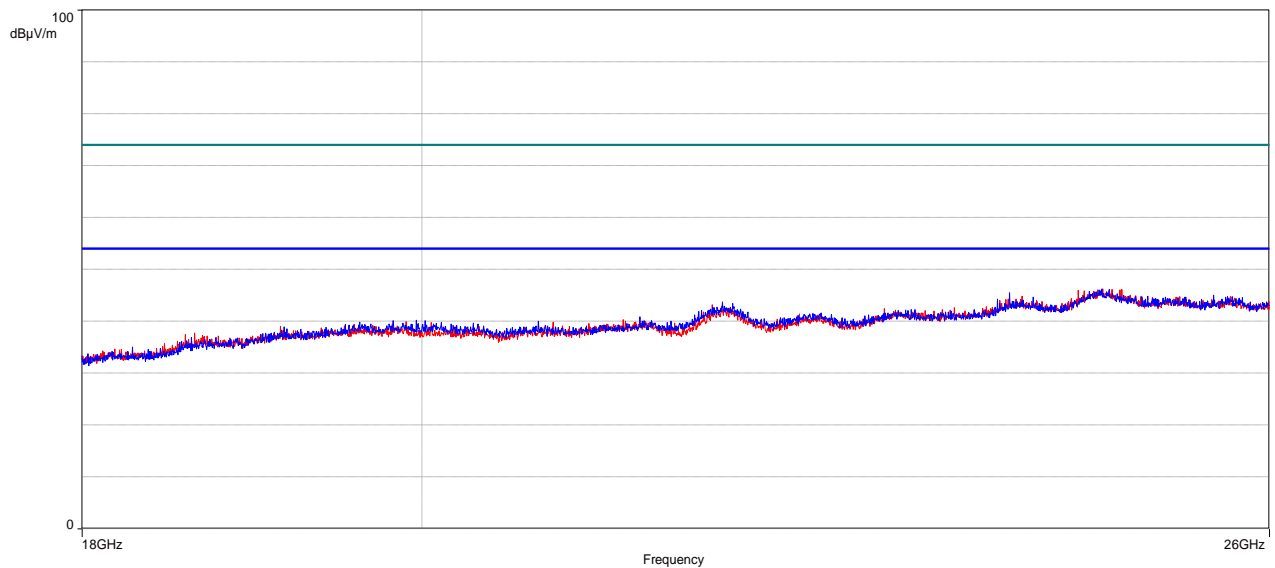
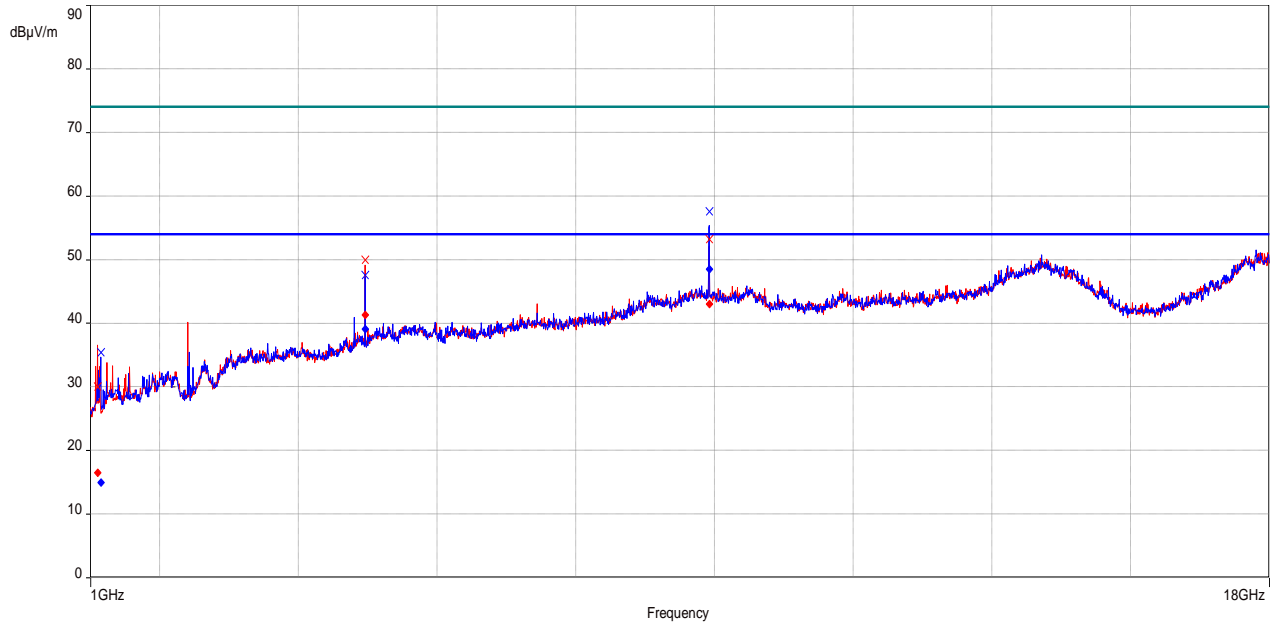

Notes: None.

SOP 1 Radiated Emissions							Tracking # US21P7P4.001 Page 7 of 10			
EUT Name	Wireless Audio Headset					Date	December 6, 2021			
EUT Model	Stealth 700P Gen 2 RX2					Temp / Hum in	21°C / 42% rh			
EUT Serial	PP #4					Temp / Hum out	N/A			
EUT Config.	Headset upright. Collocation					Line AC / Freq	3.7 VDC			
Standard	CFR47 Part 15 Subpart C					RBW / VBW	1 MHz / 3 MHz			
Dist/Ant Used	3m / EMCO-3115, 1m / ComPower-AHA840					Performed by	Jeremy Luong			
Freq	Raw	Corrd'	Level	Det	Pol	Hght	Azt	Limit	Margin	Comment
MHz	dBuV/m	dB	dBuV/m		H/V	cm	deg	dBuV/m	dB	
Transmitted Data. Wi-Fi and Bluetooth Radios at 2480 MHz. (Wi-Fi Radio is Worst Case)										
4959.56	72.40	-22.46	49.94	Pk	V	115	139	74.00	-24.06	Harmonics
4959.56	64.65	-22.46	42.19	Ave	V	115	139	54.00	-11.81	Harmonics
7439.40	64.71	-18.75	45.96	Pk	V	104	139	74.00	-28.04	Harmonics
7439.40	53.90	-18.75	35.15	Ave	V	104	139	54.00	-18.85	Harmonics
9919.12	70.30	-14.65	55.65	Pk	V	238	78	74.00	-18.35	Harmonics
9919.12	60.93	-14.65	46.28	Ave	V	238	78	54.00	-7.72	Harmonics
4959.56	72.63	-22.46	50.17	Pk	H	106	98	74.00	-23.83	Harmonics
4959.56	65.12	-22.46	42.66	Ave	H	106	98	54.00	-11.34	Harmonics
7439.40	64.01	-18.75	45.26	Pk	H	140	49	74.00	-28.74	Harmonics
7439.40	52.50	-18.75	33.75	Ave	H	140	49	54.00	-20.25	Harmonics
9921.12	70.73	-14.66	56.07	Pk	H	235	23	74.00	-17.93	Harmonics
9921.12	61.47	-14.66	46.81	Ave	H	235	23	54.00	-7.19	Harmonics
19833.35	38.75	-1.65	37.10	Pk	H	200	283	74.00	-36.90	Harmonics
19833.35	25.38	-1.65	23.73	Ave	H	200	283	54.00	-30.27	Harmonics
Transmitted Data. Wi-Fi and Bluetooth Radios at 2442 MHz. (BLE Radio is Worst Case)										
4883.56	77.02	-22.38	54.64	Pk	V	138	128	74.00	-19.36	Harmonics
4883.56	69.80	-22.38	47.42	Ave	V	138	128	54.00	-6.58	Harmonics
7325.40	67.03	-18.69	48.34	Pk	V	104	132	74.00	-25.66	Harmonics
7325.40	57.62	-18.69	38.93	Ave	V	104	132	54.00	-15.07	Harmonics
9767.12	73.44	-15.12	58.32	Pk	V	245	91	74.00	-15.68	Harmonics
9767.12	64.62	-15.12	49.50	Ave	V	245	91	54.00	-4.50	Harmonics
1878.87	62.11	-30.37	31.74	Pk	H	201	196	74.00	-42.26	Harmonics
1878.87	48.85	-30.37	18.48	Ave	H	201	196	54.00	-35.52	Harmonics
4884.56	77.22	-22.37	54.85	Pk	H	111	98	74.00	-19.15	Harmonics
4884.56	70.21	-22.37	47.84	Ave	H	111	98	54.00	-6.16	Harmonics
9767.12	73.80	-15.12	58.68	Pk	H	224	21	74.00	-15.32	Harmonics
9767.12	65.28	-15.12	50.16	Ave	H	224	21	54.00	-3.84	Harmonics
Transmitted Data. Wi-Fi Radio at 2480 MHz and Bluetooth Radio at 2442 MHz. (Worst Case for Each Radio)										
1860.78	61.31	-30.68	30.63	Pk	V	229	182	74.00	-43.37	Harmonics
1860.78	48.17	-30.68	17.49	Ave	V	229	182	54.00	-36.51	Harmonics
4884.05	64.05	-22.37	41.68	Pk	V	166	284	74.00	-32.32	Harmonics
4884.05	54.33	-22.37	31.96	Ave	V	166	284	54.00	-22.04	Harmonics
4959.56	71.73	-22.46	49.27	Pk	V	115	139	74.00	-24.73	Harmonics

Test report no.: US21P7P4.001 Rev.:01

Page 47 of 60

4959.56	63.96	-22.46	41.50	Ave	V	115	139	54.00	-12.50	Harmonics
7439.40	63.93	-18.75	45.18	Pk	V	105	141	74.00	-28.82	Harmonics
7439.40	52.83	-18.75	34.08	Ave	V	105	141	54.00	-19.92	Harmonics
9921.12	69.49	-14.66	54.83	Pk	V	259	85	74.00	-19.17	Harmonics
9921.12	59.88	-14.66	45.22	Ave	V	259	85	54.00	-8.78	Harmonics
4959.56	72.25	-22.46	49.79	Pk	H	107	100	74.00	-24.21	Harmonics
4959.56	64.43	-22.46	41.97	Ave	H	107	100	54.00	-12.03	Harmonics
9919.12	71.18	-14.65	56.53	Pk	H	228	24	74.00	-17.47	Harmonics
9919.12	61.85	-14.65	47.20	Ave	H	228	24	54.00	-6.80	Harmonics

Spec Margin = Level - Limit, Level = Raw + Cbl+ CF ± Uncertainty
 CF= Amp Gain + ANT Factor

Combined Standard Uncertainty $u_c(y) = \pm 3.2\text{dB}$ Expanded Uncertainty $U = k u_c(y)$ $k = 2$ for 95% confidence

Notes: All emissions passed the spurious emission limit.
 (*) Non-restricted band emission

SOP 1 Radiated Emissions

Tracking # US21P7P4.001 Page 8 of 10

EUT Name	Wireless Audio Headset	Date	December 6, 2021
EUT Model	Stealth 700P Gen 2 RX2	Temp / Hum in	23°C / 42% rh
EUT Serial	PP #5	Temp / Hum out	N/A
EUT Config.	Headset upright. Collocation	Line AC/ Freq	3.7 VDC
Standard	CFR47 Part 15 Subpart C	RBW / VBW	1 MHz / 3 MHz
Dist/Ant Used	3m / EMCO-3115, 1m / ComPower-AHA840	Performed by	Jeremy Luong

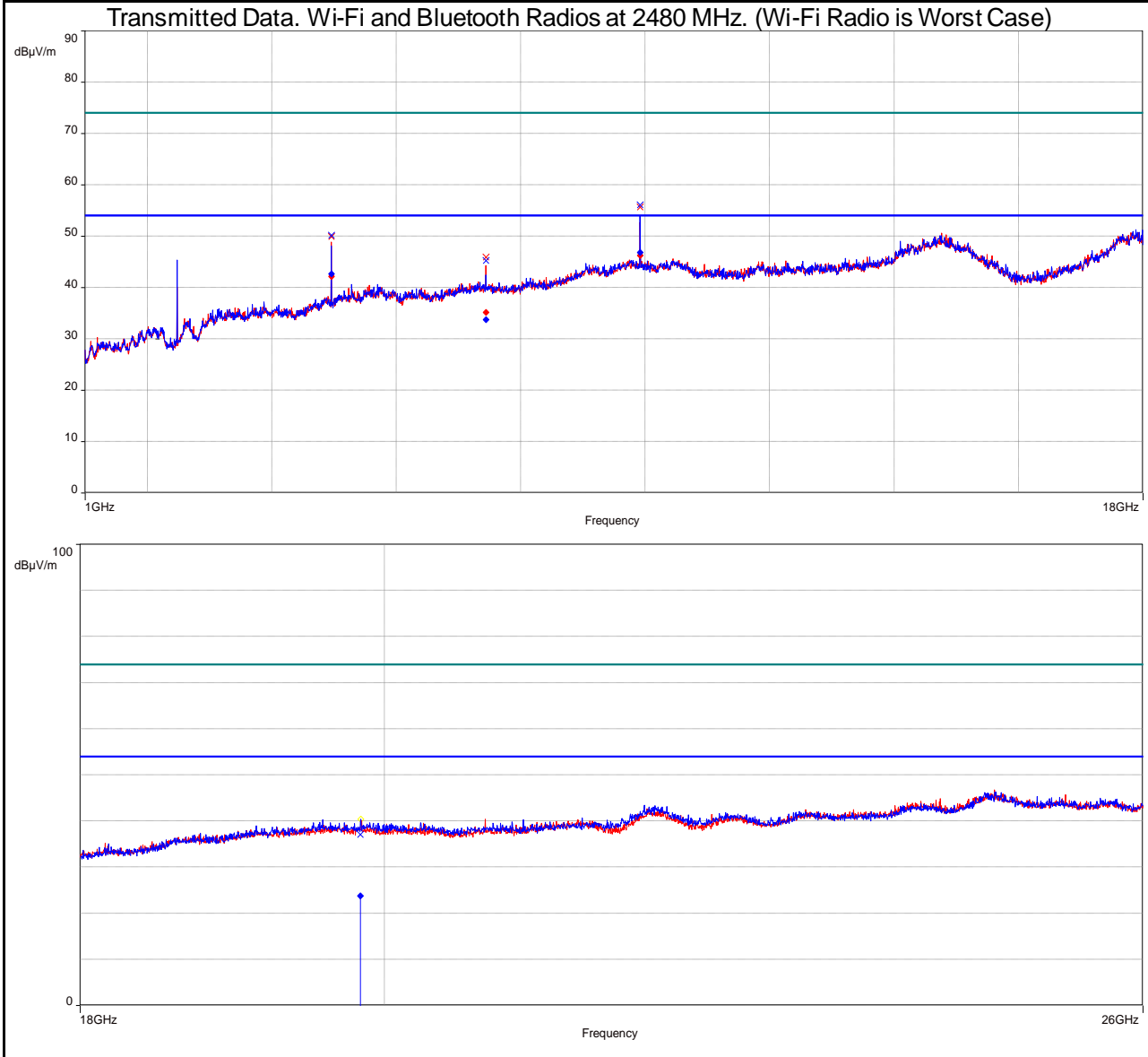

Notes: None.

SOP 1 Radiated Emissions

Tracking # US21P7P4.001 Page 9 of 10

EUT Name	Wireless Audio Headset	Date	December 6, 2021
EUT Model	Stealth 700P Gen 2 RX2	Temp / Hum in	23°C / 42% rh
EUT Serial	PP #5	Temp / Hum out	N/A
EUT Config.	Headset upright. Collocation	Line AC / Freq	3.7 VDC
Standard	CFR47 Part 15 Subpart C	RBW / VBW	1 MHz / 3 MHz
Dist/Ant Used	3m / EMCO-3115, 1m / ComPower-AHA840	Performed by	Jeremy Luong

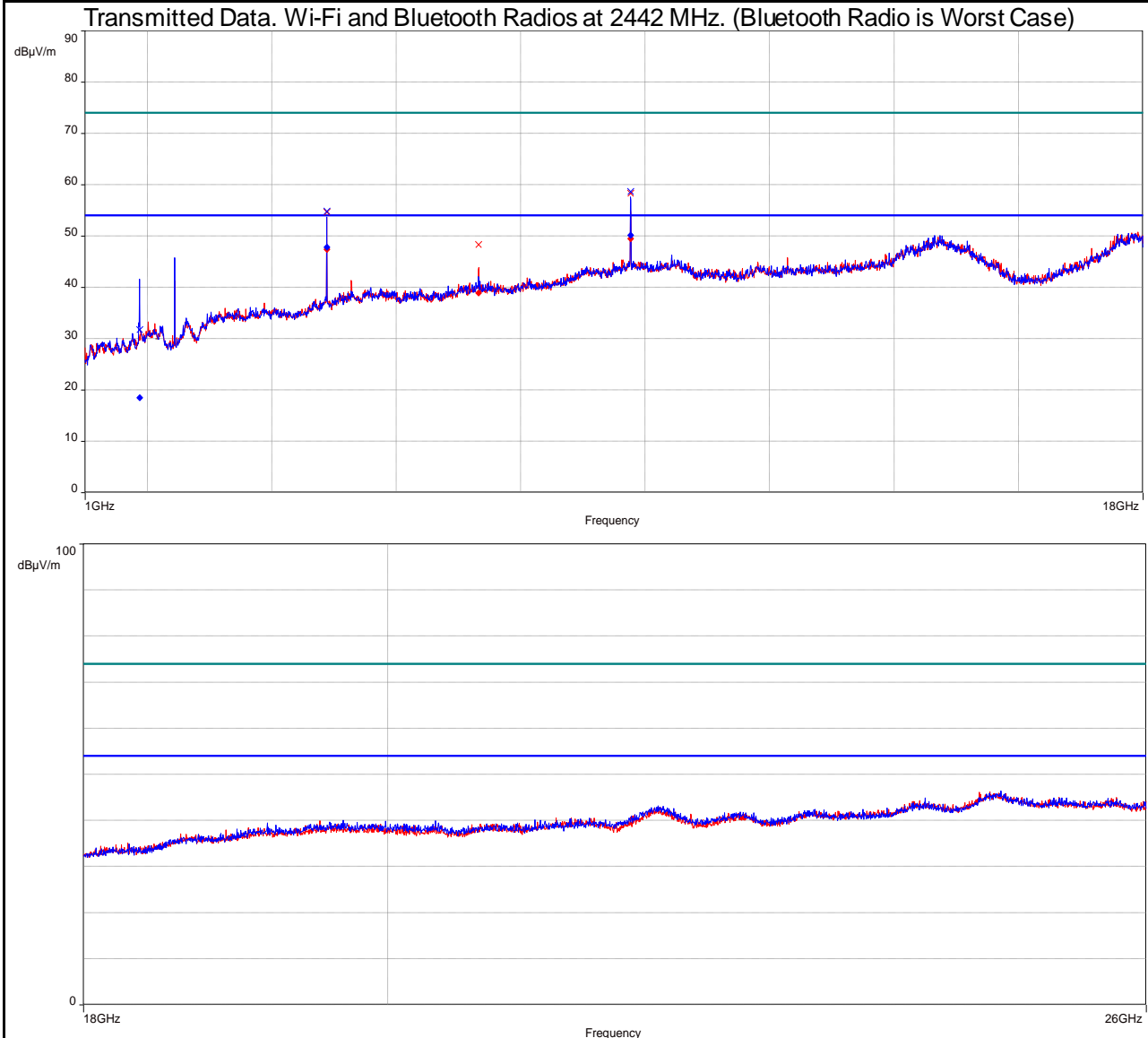

Notes: None.

SOP 1 Radiated Emissions

Tracking # US21P7P4.001 Page 10 of 10

EUT Name	Wireless Audio Headset	Date	December 6, 2021
EUT Model	Stealth 700P Gen 2 RX2	Temp / Hum in	23°C / 42% rh
EUT Serial	PP #5	Temp / Hum out	N/A
EUT Config.	Headset upright. Collocation	Line AC/ Freq	3.7 VDC
Standard	CFR47 Part 15 Subpart C	RBW / VBW	1 MHz / 3 MHz
Dist/Ant Used	3m / EMCO-3115, 1m / ComPower-AHA840	Performed by	Jeremy Luong

Transmitted Data. Wi-Fi Radio at 2480 MHz and Bluetooth Radio at 2442 MHz. (Worst Case for Each Radio)

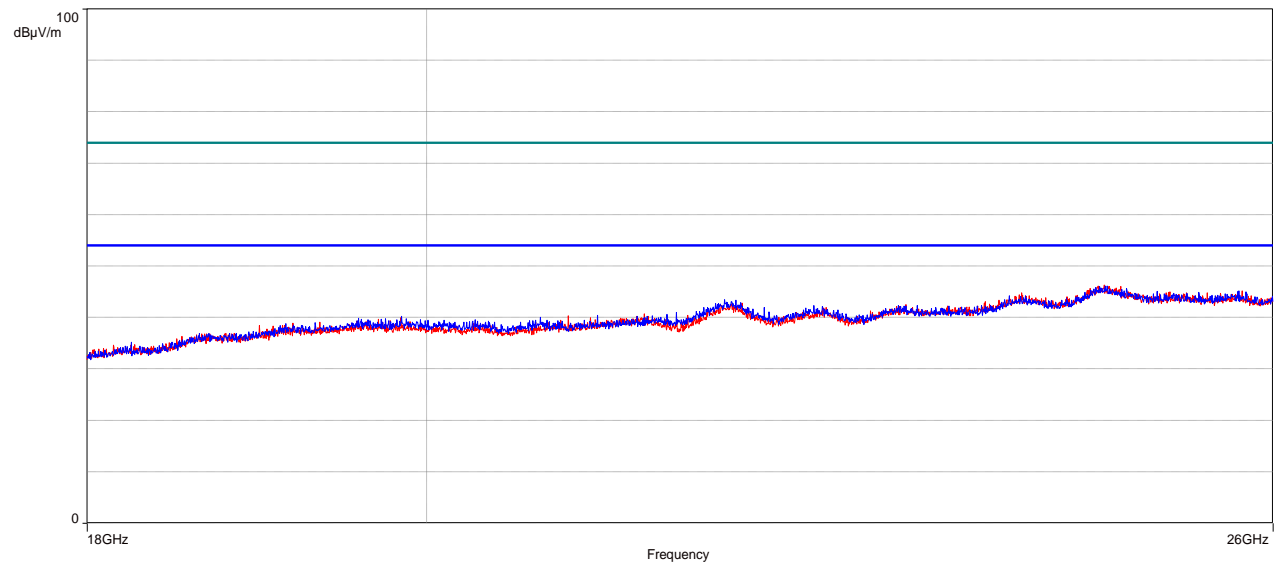
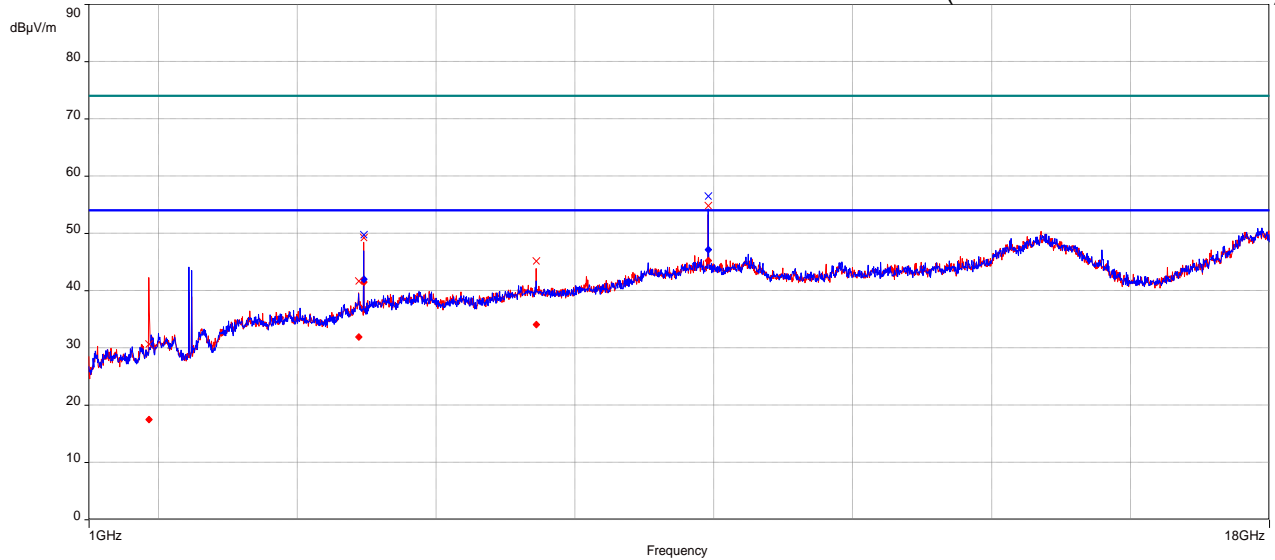

Notes: None.

4.5.4 Sample Calculation

The field strength is calculated by subtracting the Amplifier Gain and adding the Cable Loss and Antenna Correction Factor to the measured reading. The basic equation is as follows:

$$\text{Field Strength (dB}\mu\text{V/m)} = \text{FIM} - \text{AMP} + \text{CBL} + \text{ACF}$$

Where: FIM = Field Intensity Meter (dB μ V)

AMP = Amplifier Gain (dB)

CBL = Cable Loss (dB)

ACF = Antenna Correction Factor (dB/m)

$$\mu\text{V/m} = 10^{\frac{\text{dB}\mu\text{V/m}}{20}}$$

4.6 AC Conducted Emissions

Testing was performed in accordance with ANSI C63.10: 2013. These test methods are listed under the laboratory's A2LA Scope of Accreditation.

This test measures the levels emanating from the EUT's AC input port, thus evaluating the potential for the EUT to cause radio frequency interference to other electronic devices.

The AC conducted emissions of equipment under test shall not exceed the values in CFR47 Part 15.207: 2021 and RSS Gen: 2019 Sect. 8.8.

4.6.1 Test Methodology

A test program that controls instrumentation and data logging was used to automate the AC Power Line Conducted emission test procedure. The frequency range of interest was divided into sub-ranges such as to yield a frequency resolution of 9 kHz. Each phase and neutral of the AC power line were measured with respect to ground. Measurements were performed using a set of 50 μ H / 50 Ω LISNs.

Testing is performed in Lab 5. The setup photographs clearly identify which site was used. The vertical ground plane used in the semi-anechoic chamber is a 2m x 2m solid aluminum frame and panel, and it is bonded to the horizontal ground plane.

In the case of tabletop equipment, the EUT is placed on a 1.0m x 1.5m non-conductive table 80cm above the ground plane and 40cm from a vertical ground reference plane. The rear of the EUT was positioned flush with the backside of the table and directly over the LISNs. The power and I/O cables were routed over the edge of the table and bundled approximately 40cm from the ground plane. Support equipment was powered from a separate LISN.

4.6.1.1 Deviations

There were no deviations from this test methodology.

4.6.2 Test Results

As originally tested, the EUT was found to be compliant to the requirements of the test standard(s).

Table 7: AC Conducted Emissions – Test Results

Test Conditions: Conducted Measurement		Test Date: December 2, 2021
Antenna Type: Integrated PCB with Cable		Power Level: See Test Plan
AC Power: USB Host Computer		Configuration: Tabletop
Ambient Temperature: 23° C		Relative Humidity: 38% RH
Configuration	Frequency Range	Test Result
Line 1 (Hot)	0.15 to 30 MHz	Pass
Line 2 (Neutral)	0.15 to 30 MHz	Pass

Test report no.: US21P7P4.001 Rev.:01

Page 53 of 60

SOP 2 Conducted Emissions

Tracking # US21P7P4.001 Page 1 of 2

EUT Name	Wireless Audio Headset	Date	December 2, 2021
EUT Model	Stealth 700P Gen 2 RX2	Temp / Hum in	23° C / 38% rh
EUT Serial	PP #4	Temp / Hum out	N/A
EUT Config. Standard	Integrated Antenna with Cable CFR47 Part 15.207	Line AC / Freq	110 Vac/60 Hz @ Host
Lab/LISN	Lab #2/Com-Power, Line 1	RBW / VBW	9 kHz / 30 kHz
		Performed by	Jeremy Luong

Frequency MHz	Raw dBuV	Corr'd dB	Level dBuV	Detector	Line Line	Limit dBuV	Margin dB	Result
0.150	35.48	9.88	45.36	QP	Live	66.00	-20.64	Pass
0.150	19.12	9.88	29.00	Ave	Live	56.00	-27.00	Pass
0.197	29.27	9.93	39.20	QP	Live	63.69	-24.49	Pass
0.197	17.60	9.93	27.53	Ave	Live	53.69	-26.17	Pass
0.208	27.93	9.93	37.86	QP	Live	63.37	-25.50	Pass
0.208	15.75	9.93	25.68	Ave	Live	53.37	-27.68	Pass
0.377	20.71	9.97	30.68	QP	Live	58.32	-27.64	Pass
0.377	10.09	9.97	20.06	Ave	Live	48.32	-28.26	Pass
0.504	24.76	9.99	34.75	QP	Live	56.00	-21.25	Pass
0.504	17.01	9.99	27.00	Ave	Live	46.00	-19.00	Pass
1.687	8.58	10.01	18.59	QP	Live	56.00	-37.41	Pass
1.687	2.31	10.01	12.32	Ave	Live	46.00	-33.68	Pass
4.239	8.42	10.04	18.46	QP	Live	56.00	-37.54	Pass
4.239	-2.48	10.04	7.56	Ave	Live	46.00	-38.44	Pass
0.154	35.43	9.88	45.31	QP	Neutral	65.78	-20.47	Pass
0.154	17.93	9.88	27.81	Ave	Neutral	55.78	-27.97	Pass
0.159	34.25	9.89	44.14	QP	Neutral	65.57	-21.43	Pass
0.159	17.83	9.89	27.72	Ave	Neutral	55.57	-27.85	Pass
0.179	31.29	9.91	41.20	QP	Neutral	64.58	-23.38	Pass
0.179	15.75	9.91	25.66	Ave	Neutral	54.58	-28.91	Pass
0.229	24.80	9.94	34.74	QP	Neutral	62.45	-27.71	Pass
0.229	12.82	9.94	22.76	Ave	Neutral	52.45	-29.69	Pass
0.281	19.78	9.95	29.73	QP	Neutral	60.76	-31.03	Pass
0.281	9.75	9.95	19.70	Ave	Neutral	50.76	-31.05	Pass
0.400	19.45	9.97	29.42	QP	Neutral	57.81	-28.39	Pass
0.400	9.12	9.97	19.09	Ave	Neutral	47.81	-28.72	Pass
0.500	25.30	9.99	35.29	QP	Neutral	56.03	-20.75	Pass
0.500	17.47	9.99	27.46	Ave	Neutral	46.03	-18.58	Pass
0.843	10.28	10.00	20.28	QP	Neutral	56.00	-35.72	Pass
0.843	2.69	10.00	12.69	Ave	Neutral	46.00	-33.31	Pass

Spec Margin = QP/Ave. - Limit, ± Uncertainty

Combined Standard Uncertainty $U_c(y) = \pm 2.18$ dB Expanded Uncertainty $U = kU_c(y)$ $k = 2$ for 95% confidence

Notes: EUT was setup as table top equipment and transmitted at 2480 MHz

SOP 2 Conducted Emissions

Tracking # US21P7P4.001 Page 2 of 2

EUT Name	Wireless Audio Headset	Date	December 2, 2021
EUT Model	Stealth 700P Gen 2 RX2	Temp / Hum in	23° C / 38% rh
EUT Serial	PP #4	Temp / Hum out	N/A
EUT Config. Standard	Integrated Antenna with Cable CFR47 Part 15.207	Line AC	110 Vac/60 Hz @ Host
Lab/LISN	Lab #2 /Com-Power, Line 1	RBW / VBW	9 kHz / 30 kHz
		Performed by	Jeremy Luong

150 kHz to 30 MHz Plot for Live and Neutral

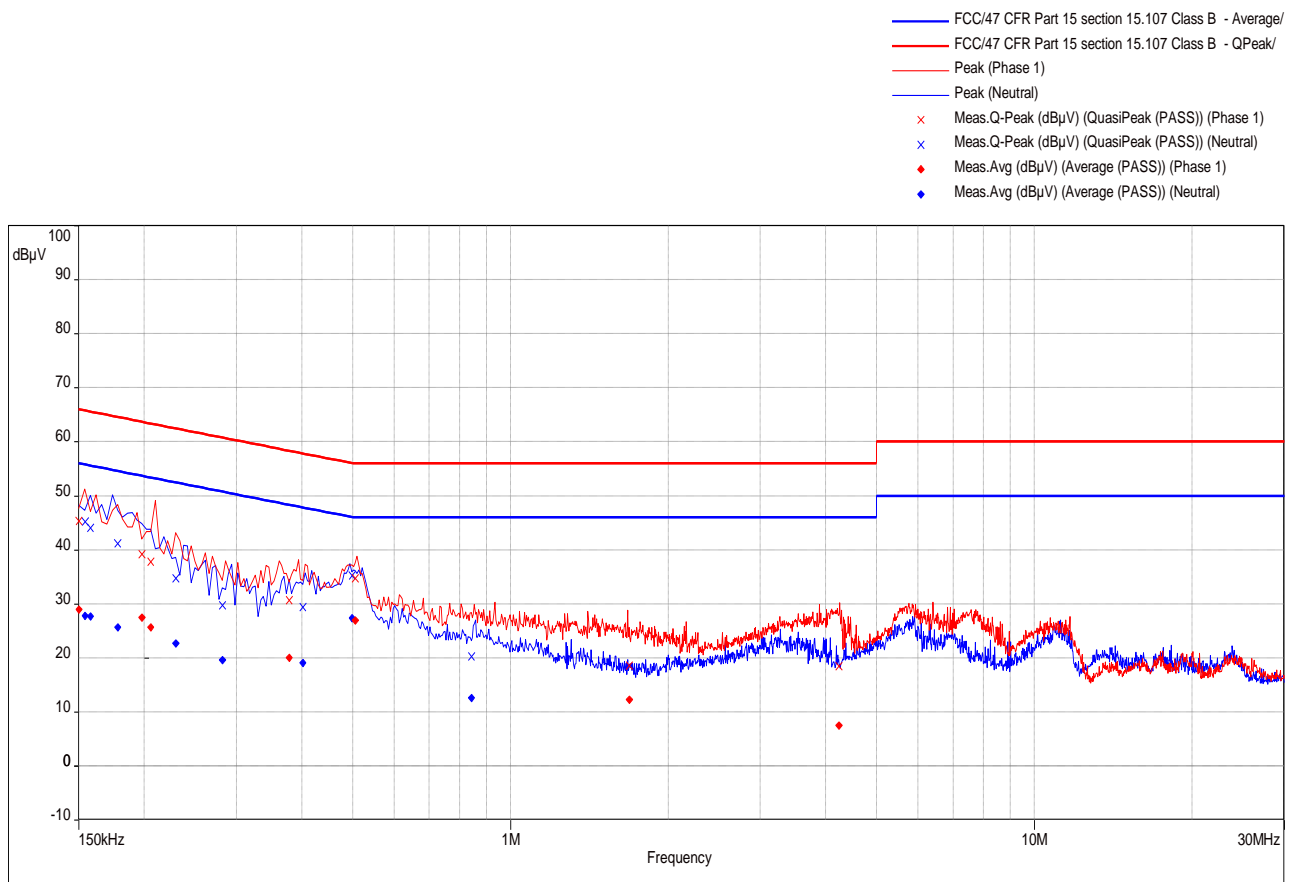

Notes: Meets FCC Class B limit.

5 Test Equipment List

5.1 Equipment List

Equipment	Manufacturer	Model #	Serial/Inst #	Last Cal mm/dd/yyyy	Next Cal mm/dd/yyyy
Loop Antenna	EMCO	6502	62531	08/31/2021	08/31/2022
Bilog Antenna	Sunol Sciences	JB3	A061907	03/09/2021	03/09/2022
Horn Ant. (1-18GHz)	Sunol Sciences	3115	9602-4676	03/04/2021	03/04/2023
Horn Ant. (18-40GHz)	Com-Power	AHA-840	105005	09/01/2021	09/01/2023
EMI Receiver	Rohde & Schwarz	ESW44	1328.4100K44- 101853-VQ	02/24/2021	02/24/2022
EMI Receiver	Agilent	N9038A	MY52260210	02/10/2021	02/10/2022
Spectrum Analyzer	Agilent	N9030A	MY52350885	02/10/2021	02/10/2022
EMI Receiver	Rohde & Schwarz	ESIB40	100180	02/26/2021	02/26/2022
Preamplifier	Sonoma Inst.	310	185516	02/11/2021	02/21/2022
Preamplifier	Miteq	TTA1800-30-HG	184252	02/12/2021	02/12/2022
RF Power Meter	Agilent	E4418B	MY45103895	02/09/2021	02/09/2022
Power Sensor	HP	8482A	1925A04647	02/09/2021	02/09/2022
Thermometer	Extech Instruments	SD700	A095319	07/26/2021	07/26/2022
Thermo Chamber	Espec	BTZ-133	0613436	VBU	VBU
DC Power Supply	Agilent	E3634A	MY400004331	VBU	VBU
Digital Multimeter	Fluke	177	92780314	02/13/2021	02/13/2022
Signal Generator	Anritsu	MG3694A	042803	06/10/2021	06/10/2022
Notch Filter	Micro-Tronics	BRM50702	37	VBU	VBU
Transient Limiter	HP	11947A	3107A038612	02/09/2021	02/09/2022
LISN	Com-Power	LI-220C	2007001	07/29/2021	07/29/2022

* Calibration of equipment past due for re-calibration will be performed expeditiously. If any equipment is found to be out of tolerance at that time, affected customers will be notified accordingly.

6 EMC Test Plan

6.1 Introduction

This section provides a description of the Equipment Under Test (EUT), configurations, operating conditions, and performance acceptance criteria. It is an overview of information provided by the manufacturer so that the test laboratory may perform the requested testing.

6.2 Customer

Table 8: Customer Information

Company Name	Voyetra Turtle Beach, Inc.
Address	44 South Broadway, 4th Floor
City, State, Zip	White Plains NY 10601 USA
Country	USA

Table 9: Technical Contact Information

Name	Tim Blaney
E-mail	tim@commcepts.net
Phone	(530) 277-3482

6.3 Equipment Under Test (EUT)

Table 10: EUT Specifications

EUT Specification	
Package Dimensions	215.8 mm (8.4") x 243 mm (9.5") x 111.5 mm (4.3")
Power Input	Headset Input Voltage: 3.7 Vdc (battery)
Environment	Indoor
Operating Temperature Range:	0 to 50 degrees C
Multiple Feeds:	<input type="checkbox"/> Yes and how many <input checked="" type="checkbox"/> No
Product Marketing Name (PMN)	Stealth 700P Gen 2 RX2
Hardware Version Identification Number (HVIN)	700P Gen 2 RX2
Firmware Version Identification Number (FVIN)	1.1.2.0
Operating Mode	TestCommon Unit Test 1.0.3.9
FCC ID	XGB-TB3780RX2
IC	3879A-3780RX2
Transmitter Frequency Band	2402 MHz to 2480 MHz
Max. Measured Power Output	+3.45 dBm
Power Setting @ Operating Channel	+4.0 dBm
Antenna Type	Integrated PCB with Cable. (Unictron Technologies. P/N: WW20D1)
Antenna Gain	Wi-Fi Antenna: +4.0 dBi.
Modulation Type	<input type="checkbox"/> AM <input type="checkbox"/> FM <input type="checkbox"/> DSSS <input type="checkbox"/> OFDM <input checked="" type="checkbox"/> Other describe: GFSK
Date Rates	1 Mbps and 2 Mbps
TX/RX Chain (s)	1
Directional Gain Type	<input checked="" type="checkbox"/> Uncorrelated <input checked="" type="checkbox"/> No Beam-Forming <input type="checkbox"/> Other describe:
Type of Equipment	<input type="checkbox"/> Table Top <input type="checkbox"/> Wall-mount <input type="checkbox"/> Floor standing cabinet <input checked="" type="checkbox"/> Other describe: Head wear device.
<p>*All EUT specifications are provided by the manufacturer or the TUV direct customer. Note: Information supplied by the customer and can affect the validity of results.</p>	

Test report no.: US21P7P4.001 Rev.:01

Page 58 of 60

Table 11: Interface Specifications

Interface Type	Cabled with what type of cable?	Is the cable shielded?	Maximum potential length of the cable?	Metallic (M), Coax (C), Fiber (F), or Not Applicable?
USB	Terminated	<input checked="" type="checkbox"/> Yes	<input checked="" type="checkbox"/> Metric:0.6 m	<input checked="" type="checkbox"/> M

Table 12: Supported Equipment

Equipment	Manufacturer	Model	Serial	Used for
Laptop	Lenovo	T430	PB-8HBRR	Set test mode

Table 13: Description of Sample used for Testing

Device	Serial Number	Configuration	Used For
Stealth 700P Gen 2 RX2	PP #4	Radiated Sample	Radiated Emissions.
Stealth 700P Gen 2 RX2	PP #3	Conducted Sample	Output Power, Occupied Bandwidth, Conducted Spurious Emissions, Peak Power Spectral Density
Note: None			

Table 14: Description of Test Configuration used for Radiated Measurement.

Device	Antenna	Mode	Setup Description
Stealth 700P Gen 2 RX2	Integrated PCB with Cable	Transmit & Receive	Stealth 700P Gen 2 RX2 positioned vertically, normal usage.
Note: This is the final setup configuration used for testing.			

Table 15: Final Test Mode for 2402 to 2480 MHz Band

Test	Stealth 700P Gen 2 RX2
Occupied Bandwidth	2402, 2442, 2480 MHz @ 1 Mbps
Output Power	2402, 2442, 2480 MHz @ 1 Mbps
Peak Power Spectral Density	2402, 2442, 2480 MHz @ 1 Mbps
Out-of-Band (-30 dBr)	2402, 2442, 2480 MHz @ 1 Mbps
Band-Edge (Radiated)	2402, 2480 MHz @ 2 Mbps
Transmitted Spurious Emission	2402, 2442, 2480 MHz @ 1 Mbps
AC Conducted Emission	2402 MHz @ 1 Mbps
Note: EUT transmits at 87.75% duty cycle.	

6.4 Test Specifications

Table 16: Test Specifications

Emissions and Immunity	
Rules & Regulations / Standards	Requirement
CFR 47 Part 15.247: 2021	All
RSS 247 Issue 2, 2017	All

END OF REPORT