

Prüfbericht-Nr.: <i>Test report no.:</i>	CN22NAWE (P15C-BT) 001	Auftrags-Nr.: <i>Order no.:</i>	238542896	Seite 1 von 29 Page 1 of 29
Kunden-Referenz-Nr.: <i>Client reference no.:</i>	N/A	Auftragsdatum: <i>Order date:</i>	2022-04-29	
Auftraggeber: <i>Client:</i>	Voyetra Turtle Beach, Inc. 44 South Broadway, 4th Floor, White Plains, New York 10601, U.S.A.			
Prüfgegenstand: <i>Test item:</i>	Recon Air Chat Communicator Wireless			
Bezeichnung / Typ-Nr.: <i>Identification / Type no.:</i>	Recon Air Wireless Chat P-RX & Recon Air Wireless Chat X-RX			
Auftrags-Inhalt: <i>Order content:</i>	FCC Part 15C Test report (BT)			
Prüfgrundlage: <i>Test specification:</i>	FCC 47CFR Part 15: Subpart C Section 15.247			
Wareneingangsdatum: <i>Date of sample receipt:</i>	2021-10-15			
Prüfmuster-Nr.: <i>Test sample no.:</i>	A003145666-010 A003162952-039			
Prüfzeitraum: <i>Testing period:</i>	2021-10-18 - 2021-11-19			
Ort der Prüfung: <i>Place of testing:</i>	EMC/RF Taipei Testing Site			
Prüflaboratorium: <i>Testing laboratory:</i>	Taipei Testing Laboratories			
Prüfergebnis*: <i>Test result*:</i>	Pass			
überprüft von: <i>compiled by:</i>		genehmigt von: <i>authorized by:</i>		
Datum: <i>Date:</i>	2022-05-10	Ausstellungsdatum: <i>Issue date:</i>	2022-05-10	
Stellung / Position:	Senior Project Manager	Stellung / Position:	Senior Project Manager	
Sonstiges / Other:	This report is mainly changed the product name and model name, and added FCC ID. The test results are all referred to the original report no.: CN21RLOD (P15C-BT) 001.			
Zustand des Prüfgegenstandes bei Anlieferung: <i>Condition of the test item at delivery:</i>	Prüfmuster vollständig und unbeschädigt <i>Test item complete and undamaged</i>			
* Legende:	1 = sehr gut P(ass) = entspricht o.g. Prüfgrundlage(n)	2 = gut F(ail) = entspricht nicht o.g. Prüfgrundlage(n)	3 = befriedigend N/A = nicht anwendbar	4 = ausreichend N/T = nicht getestet
* Legend:	1 = very good P(ass) = passed a.m. test specification(s)	2 = good F(ail) = failed a.m. test specification(s)	3 = satisfactory N/A = not applicable	4 = sufficient N/T = not tested
Dieser Prüfbericht bezieht sich nur auf das o.g. Prüfmuster und darf ohne Genehmigung der Prüfstelle nicht auszugsweise vervielfältigt werden. Dieser Bericht berechtigt nicht zur Verwendung eines Prüfzeichens. <i>This test report only relates to the a. m. test sample. Without permission of the test center this test report is not permitted to be duplicated in extracts. This test report does not entitle to carry any test mark.</i>				

TEST SUMMARY

Report Section	FCC Clause	Test Item	Result
5.1.1	15.247(b) & 15.203	Antenna Requirement	Pass
5.1.2	15.247(b)(1)	Peak Output Power	Pass
5.1.3	15.247(a)(1)	20 dB Bandwidth	Pass
5.1.3	2.1049	99% Occupied Bandwidth	Pass
5.1.4	15.247(d)	Conducted Spurious Emission and Band Edges	Pass
5.1.5	15.247(d) & 15.205 & 15.209	Radiated Spurious Emissions and Band Edges	Pass
5.1.6	15.247(a)(1)	Hopping Channel Separation	Pass
5.1.7	15.247(a)(1) (iii)	Number of Hopping Frequency Used	Pass
5.1.8	15.247(a)(1) (iii)	Dwell Time on Each Channel	Pass
5.2.1	15.207	Mains Conducted Emission	Pass

Note:

1. If the Frequency Hopping Systems operating in 2400-2483.5 MHz band and the output power less than 125 mW. The hopping channel carrier frequencies separated by a minimum of 25 kHz or two-thirds of the 20 dB bandwidth of hopping channel whichever is greater.
2. Determining compliance based on the results of the compliance measurement, not taking into account measurement instrumentation uncertainty.

Contents

HISTORY OF THIS TEST REPORT	5
1. GENERAL REMARKS	6
1.1 COMPLEMENTARY MATERIALS	6
1.2 DECISION RULE OF CONFORMITY	6
2. TEST SITES	7
2.1 TEST LABORATORY	7
2.2 TEST FACILITY	7
2.3 TRACEABILITY	8
2.4 CALIBRATION	8
2.5 MEASUREMENT UNCERTAINTY	8
3. GENERAL PRODUCT INFORMATION	9
3.1 PRODUCT FUNCTION AND INTENDED USE	9
3.2 SYSTEM DETAILS AND RATINGS	9
3.3 NOISE GENERATING AND NOISE SUPPRESSING PARTS	10
3.4 SUBMITTED DOCUMENTS	10
4. TEST SET-UP AND OPERATION MODES	11
4.1 PRINCIPLE OF CONFIGURATION SELECTION	11
4.2 CARRIER FREQUENCY AND CHANNEL	11
4.3 TEST OPERATION AND TEST SOFTWARE	12
4.4 SPECIAL ACCESSORIES AND AUXILIARY EQUIPMENT	13
4.5 TEST SETUP DIAGRAM	14
5. TEST RESULTS	15
5.1 TRANSMITTER REQUIREMENT & TEST SUITES	15
5.1.1 <i>Antenna Requirement</i>	<i>15</i>
5.1.2 <i>Peak Output Power</i>	<i>16</i>
5.1.3 <i>20 dB Bandwidth and 99% Occupied Bandwidth</i>	<i>18</i>
5.1.4 <i>Conducted Spurious Emissions and Frequency Band Edges Measured in 100kHz Bandwidth</i>	<i>19</i>
5.1.5 <i>Radiated Spurious Emissions and Band Edges</i>	<i>20</i>
5.1.6 <i>Hopping Channel Separation</i>	<i>25</i>
5.1.7 <i>Number of Hopping Frequency</i>	<i>26</i>
5.1.8 <i>Dwell Time</i>	<i>27</i>
5.2 MAINS EMISSION	28
5.2.1 <i>Mains Conducted Emission</i>	<i>28</i>

Prüfbericht - Nr.: CN22NAWE (P15C-BT) 001
Test Report No.

Seite 4 von 29
Page 4 of 29

Appendix A - TEST RESULT OF CONDUCTED & MAINS CONDUCTED EMISSION

APPENDIX B - TEST RESULT OF RADIATED EMISSIONS

APPENDIX SP - PHOTOGRAPHS TEST SETUP

APPENDIX EP - PHOTOGRAPHS OF EUT

Prüfbericht - Nr.: CN22NAWE (P15C-BT) 001
Test Report No.

Seite 5 von 29
Page 5 of 29

HISTORY OF THIS TEST REPORT

Report No.	Description	Date Issued
CN22NAWE (P15C-BT) 001	Original Release	2022-05-10

1. General Remarks

1.1 Complementary Materials

All attachments are integral parts of this test report. This applies especially to the following appendix:

Appendix A - Test Result of Conducted & Mains Conducted Emission

Appendix B - Test Result of Radiated Emissions

Appendix SP - Photographs Test Setup

Appendix EP - Photographs of EUT

Applied Standard and Test Levels

Radio
FCC 47CFR Part 15: Subpart C Section 15.247
FCC 47CFR Part 2: Subpart J Section 2.1049
ANSI C63.10:2013
KDB 558074 D01 15.247 Meas Guidance v05r02

1.2 Decision Rule of Conformity

The decision rule of conformity of this test report is following the requirements of the requested standard in the quotation, and agreed among testing laboratory and manufacturer (applicant) to exclude the consideration of Measurement Uncertainty, unless it is required by the specific standard.

2. Test Sites

2.1 Test Laboratory

Taipei Testing Laboratories

11F. No.758, Sec. 4, Bade Rd., Songshan Dist.
Taipei City 105
Taiwan (R.O.C.)

2.2 Test Facility

Taipei Testing Laboratories

No.458-18, Sec. 2, Fenliao Rd., Linkou Dist.,
New Taipei City 244
Taiwan (R.O.C.)
FCC Registration No.: 226631
ISED Registration No.: 25563

2.3 Traceability

All measurement equipment calibrations are traceable to NML(Taiwan)/NIST(USA) or where calibration is performed outside Taiwan, to equivalent nationally recognized standards organizations.

2.4 Calibration

Equipment requiring calibration is calibrated periodically in a suitably accredited Calibration Lab. Additionally all equipment is verified for proper performance on a regular basis using in house standards or comparisons.

2.5 Measurement Uncertainty

All measurement uncertainty values are shown with a coverage factor of $k=2$ to indicate a 95% level of confidence.

Emission Measurement Uncertainty

Parameter	Uncertainty
Radiated Emission (9 kHz ~ 30 MHz)	± 1.15 dB
Radiated Emission (30 MHz ~ 200 MHz)	± 1.30 dB
Radiated Emission (200 MHz ~ 1 GHz)	± 1.30 dB
Radiated Emission (1 GHz ~ 18 GHz)	± 1.54 dB
Radiated Emission (18 GHz ~ 40 GHz)	± 2.52 dB
Mains Conducted Emission	± 1.65 dB

3. General Product Information

3.1 Product Function and Intended Use

The EUT is a Recon Air Chat Communicator Wireless. It contains a Bluetooth compatible module enabling the user to communicate data through a Wireless interface.

For details refer to the User Guide, Data Sheet and Circuit Diagram.

3.2 System Details and Ratings

Basic Information of EUT

Item	EUT information
Kind of Equipment/Test Item	Recon Air Chat Communicator Wireless
Type Identification	Recon Air Wireless Chat P-RX & Recon Air Wireless Chat X-RX
FCC ID	XGB-3347RX XGB-2412RX

Note:

- All models are listed as below.

Models	FCC ID	Difference
Recon Air Wireless Chat P-RX	XGB-3347RX	Different models and FCC ID are for marketing purpose.
Recon Air Wireless Chat X-RX	XGB-2412RX	

Technical Specification of EUT

Item	EUT information
Operating Frequency	2402 MHz ~ 2480 MHz
Channel Number	79
Operation Voltage	USB: 5 Vdc Battery: 3.7 Vdc
Modulation	GFSK, $\pi/4$ -DQPSK, 8DPSK
Maximum Output Power (mW)	1.95
Antenna Information	Refer to 5.1.1
Accessory Device	Refer to 4.4

3.3 Noise Generating and Noise Suppressing Parts

Refer to the Circuit Diagram.

3.4 Submitted Documents

- Circuit Diagram
- Instruction Manual
- Rating Label
- Technical Description

4. Test Set-up and Operation Modes

4.1 Principle of Configuration Selection

The test modes were adapted accordingly in reference to the instructions for use.

During testing, Channel and Power Controlling Software provided by the customer was used to control the operating channel as well as the output power level. The RF output power selection is for the setting of RF output expected by the customer and is going to be fixed on the firmware of the final end product.

Table for Parameters of Test Software Setting

Frequency (MHz)	Power Setting		
	GFSK	$\pi/4$ -DQPSK	8DPSK
2402	0x07	0x07	0x07
2441	0x07	0x07	0x07
2480	0x07	0x07	0x07

4.2 Carrier Frequency and Channel

Channel	Freq. (MHz)	Channel	Freq. (MHz)	Channel	Freq. (MHz)	Channel	Freq. (MHz)
0	2402	20	2422	40	2442	60	2462
1	2403	21	2423	41	2443	61	2463
2	2404	22	2424	42	2444	62	2464
3	2405	23	2425	43	2445	63	2465
4	2406	24	2426	44	2446	64	2466
5	2407	25	2427	45	2447	65	2467
6	2408	26	2428	46	2448	66	2468
7	2409	27	2429	47	2449	67	2469
8	2410	28	2430	48	2450	68	2470
9	2411	29	2431	49	2451	69	2471
10	2412	30	2432	50	2452	70	2472
11	2413	31	2433	51	2453	71	2473
12	2414	32	2434	52	2454	72	2474
13	2415	33	2435	53	2455	73	2475
14	2416	34	2436	54	2456	74	2476
15	2417	35	2437	55	2457	75	2477
16	2418	36	2438	56	2458	76	2478
17	2419	37	2439	57	2459	77	2479
18	2420	38	2440	58	2460	78	2480
19	2421	39	2441	59	2461		

4.3 Test Operation and Test Software

Setup for testing: Test samples are provided with an UART interface which makes it possible to control them through a test software installed on a notebook computer.
 This software was running on the laptop computer connected to the EUT. It was used to enable the operation modes listed as below.

Test Software	AWRDLABV2.exe
---------------	---------------

The samples were used as follows:

A003145666-010

A003162952-039

Full test was applied on all test modes, but only worst case was shown.

EUT Configure Mode	Applicable To			Description	
	Antenna Port Conducted Measurement	Radiated Spurious Emissions above 1 GHz	Radiated Spurious Emissions below 1 GHz		Mains Conducted Emission
-	√	√	√	√	-

Note:

- For Radiated emission test, pre-tested GFSK, π/4-DQPSK, 8DPSK modulation type and found 8DPSK was the worse, therefore chosen for the final test and presented in the test report.
- The EUT had been pre-tested on the positioned of each 3 axis. The worst case was found when position on **Z-plane**.
- "-" means no effect.

Antenna Port Conducted Measurement

- Pre-Scan full test was applied on all test modes, but only worst case was shown.
- Following channel(s) was (were) selected for the final test as listed below.

EUT Configure Mode	Available Frequency (MHz)	Tested Frequency (MHz)	Modulation Type	Packet Type
-	2402 to 2480	2402, 2441, 2480	GFSK	1DH5
-	2402 to 2480	2402, 2441, 2480	8DPSK	3DH5

Radiated Spurious Emissions (Above 1 GHz)

- Pre-Scan full test was applied on all test modes, but only worst case was shown.
- Following channel(s) was (were) selected for the final test as listed below.

EUT Configure Mode	Available Frequency (MHz)	Tested Frequency (MHz)	Modulation Type	Packet Type
-	2402 to 2480	2402, 2441, 2480	GFSK	1DH5
-	2402 to 2480	2402, 2441, 2480	8DPSK	3DH5

Radiated Spurious Emissions (Below 1 GHz)

- Pre-Scan full test was applied on all test modes, but only worst case was shown.
- Following channel(s) was (were) selected for the final test as listed below.

EUT Configure Mode	Available Frequency (MHz)	Tested Frequency (MHz)	Modulation Type	Packet Type
-	2402 to 2480	2480	8DPSK	3DH5

Mains Conducted Emission

- Pre-Scan full test was applied on all test modes, but only worst case was shown.
- Following channel(s) was (were) selected for the final test as listed below.

EUT Configure Mode	Available Frequency (MHz)	Tested Frequency (MHz)	Modulation Type	Packet Type
-	2402 to 2480	2480	8DPSK	3DH5

Test Condition

Test Item	Ambient Temperature	Relative Humidity	Tested by
Conducted Measurement	23.1 °C	60 %	Stanislas Charles
Radiated Spurious Emissions above 1 GHz	24.1-25.5 °C	53-54 %	Ivan Chiang
Radiated Spurious Emissions below 1 GHz	24.1-25.5 °C	53-54 %	Ivan Chiang
Mains Conducted Emission	23.6-24.1 °C	49-52 %	Ray Huang

4.4 Special Accessories and Auxiliary Equipment

The product has been tested together with the following additional accessories:

Accessory of EUT

No.	Product	Brand	Model	Description
-	USB-C Charging Cable	Turtle Beach	Recon Air Cable	-

Support Unit

Support Unit								
No	Description	Brand	Model	S/N	Shielded	Ferrite Core (Qty)	Length (cm)	Remark
A	DC Cable	Ampacs	N/A	N/A	NO	0	9	Radiated
1	UART	TUV	CP2102	N/A	-	-	-	
2	USB Cable	TUV	TUV-001	N/A	YES	NO	300	
3	Type C Cable	TUV	TUV-006	N/A	YES	NO	95	
4	USB Cable	TUV	TUV-003	N/A	YES	NO	175	
5	Notebook	HP	15-DA1046TX	CND911MY2	-	-	-	Mains Conducted
A	DC Cable	Ampacs	N/A	N/A	NO	0	9	
1	Notebook	Lenovo	TP00094A	SL10Q37402	-	-	-	
2	UART	TUV	CP2102	N/A	-	-	-	

4.5 Test Setup Diagram

<Radiated Spurious Emissions mode>

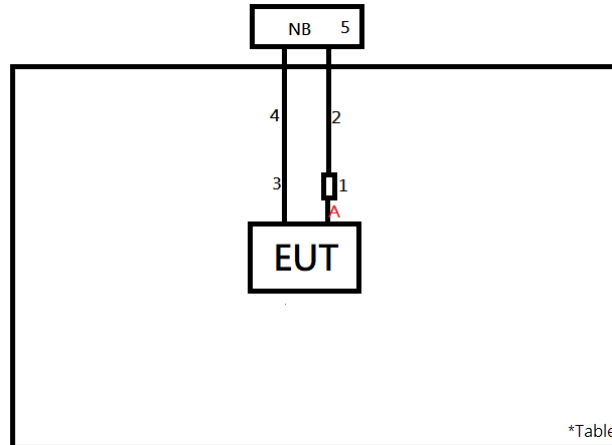

<Mains Conducted Emission mode>

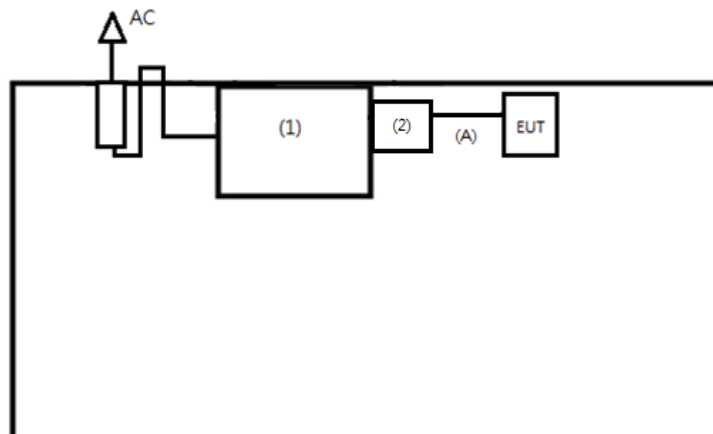

5. Test Results

5.1 Transmitter Requirement & Test Suites

5.1.1 Antenna Requirement

Requirement Use of approved antennas only

According to the manufacturer declaration, the EUT has an antenna with a directional gain of 1.9 dBi. The antenna is a chip antenna with no possibility of replacement with a non-approved antenna by the end-user. Therefore, the EUT is considered to comply with this provision.
Refer to EUT photo for details.

5.1.2 Peak Output Power

Limit

For frequency hopping systems operating in the 2400-2483.5 MHz band employing at least 75 non-overlapping hopping channels, and all frequency hopping systems in the 5725-5850 MHz band: 1 watt.
 For all other frequency hopping systems in the 2400-2483.5 MHz band: 0.125 watts.

Kind of Test Site Shielded room

Test Setup

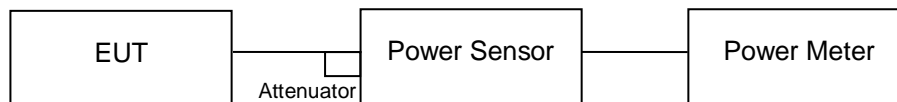

Test Instruments

Kind of Equipment	Manufacturer	Type	S/N	Calibration Date	Calibration Due Date	Test Date	
						From	Until
Power Meter	Anritsu	ML2495A	1901008	2021/3/24	2022/3/23	2021/10/18	2021/10/18
Power Sensor	Anritsu	MA2411B	1725269	2021/3/24	2022/3/23	2021/10/18	2021/10/18

Test Procedures

A peak power sensor was used on the output port of the EUT. A power meter was used to read the response of the peak power sensor. Record the power level.

Average power sensor was used to perform output power measurement, trigger and gating function of wide band power meter is enabled to measure max output power of TX on burst. Duty factor is not added to measured value.

Test Result
Peak Output Power
<GFSK>

Channel	Channel Frequency	Peak Output Power		Limit
	(MHz)	(dBm)	(mW)	(mW)
Low Channel	2402	-0.02	0.995	125
Middle Channel	2441	-0.10	0.977	125
High Channel	2480	-0.18	0.959	125

<8DPSK>

Channel	Channel Frequency	Peak Output Power		Limit
	(MHz)	(dBm)	(mW)	(mW)
Low Channel	2402	2.47	1.766	125
Middle Channel	2441	2.40	1.738	125
High Channel	2480	2.90	1.950	125

Average Power
<GFSK>

Channel	Channel Frequency	Average Power	
	(MHz)	(dBm)	(mW)
Low Channel	2402	-0.09	0.979
Middle Channel	2441	-0.16	0.964
High Channel	2480	-0.25	0.944

<8DPSK>

Channel	Channel Frequency	Average Power	
	(MHz)	(dBm)	(mW)
Low Channel	2402	-0.16	0.964
Middle Channel	2441	-0.23	0.948
High Channel	2480	-0.31	0.931

5.1.3 20 dB Bandwidth and 99% Occupied Bandwidth

Kind of Test Site Shielded room

Test Setup

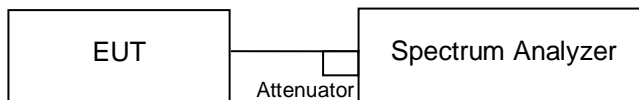

Test Instruments

Kind of Equipment	Manufacturer	Type	S/N	Calibration Date	Calibration Due Date	Test Date	
						From	Until
Spectrum Analyzer	R&S	FSV40	101512	2021/1/29	2022/1/28	2021/10/18	2021/10/18

Test Procedure

- a. Check the calibration of the measuring instrument using either an internal calibrator or a known signal from an external generator.
- b. Turn on the EUT and connect it to measurement instrument. Then set it to any one convenient frequency within its operating range. Set a reference level on the measuring instrument equal to the highest peak value.
- c. Measure the frequency difference of two frequencies that were attenuated 20 dB from the reference level. Record the frequency difference as the emission bandwidth.
- d. Repeat above procedures until all frequencies measured were complete.
- e. The transmitter output was connected to the spectrum analyzer through an attenuator. The bandwidth of the fundamental frequency was measured by spectrum analyzer with resolution bandwidth in the range of 1 % to 5 % of the anticipated emission bandwidth, and a video bandwidth at least 3x the resolution bandwidth and set the detector to PEAK. The width of a frequency band such that, below the lower and above the upper frequency limits, the mean powers emitted are each equal to a specified percentage 0.5 % of the total mean power of a given emission.

Test Results

Please refer to Appendix A.

5.1.4 Conducted Spurious Emissions and Frequency Band Edges Measured in 100kHz Bandwidth

Limit

20dB (below that in the 100 kHz bandwidth within the band that contains the highest level of the desired power.)

Kind of Test Site Shielded room

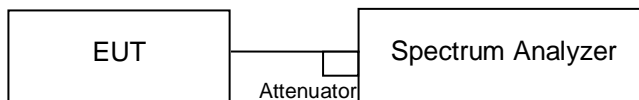
Test Setup

Test Instruments

Kind of Equipment	Manufacturer	Type	S/N	Calibration Date	Calibration Due Date	Test Date	
						From	Until
Spectrum Analyzer	R&S	FSV40	101512	2021/1/29	2022/1/28	2021/10/18	2021/10/18

Test Procedure

The transmitter output was connected to the spectrum analyzer via a low lose cable. Set both RBW and VBW of spectrum analyzer to 100 kHz and 300 kHz with suitable frequency span including 100 MHz bandwidth from band edge. The band edges was measured and recorded.

Test Results

Please refer to Appendix A.

5.1.5 Radiated Spurious Emissions and Band Edges

Limit

Radiated emissions which fall in the restricted bands, as defined in §15.205(a), must comply with the radiated emission limits specified in §15.209(a).

Emissions radiated outside the restricted and authorized frequency bands must either comply with the radiated emission limits specified for the restricted bands or in §15.247(d).

Kind of Test Site 3m Semi-Anechoic Chamber

Test Setup

<Radiated Emissions below 30 MHz>

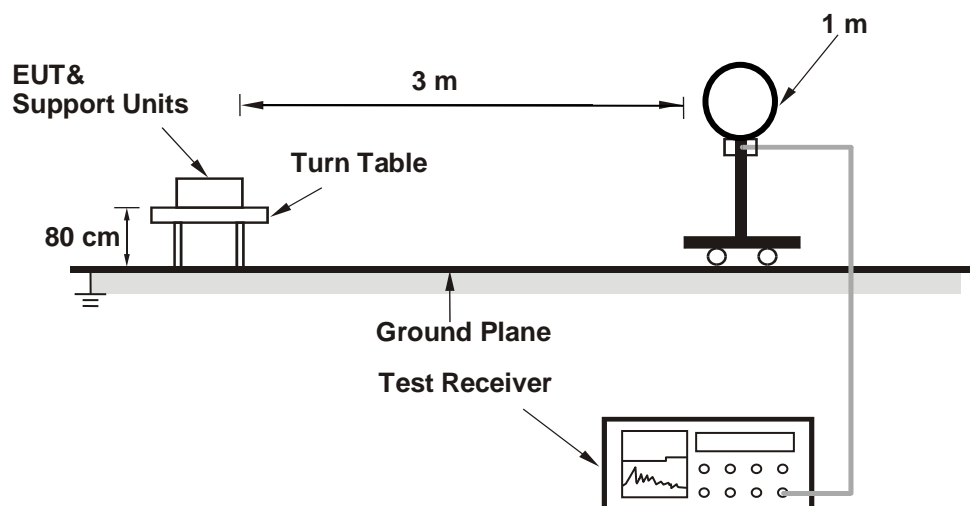

<Radiated Emissions 30 MHz to 1 GHz>

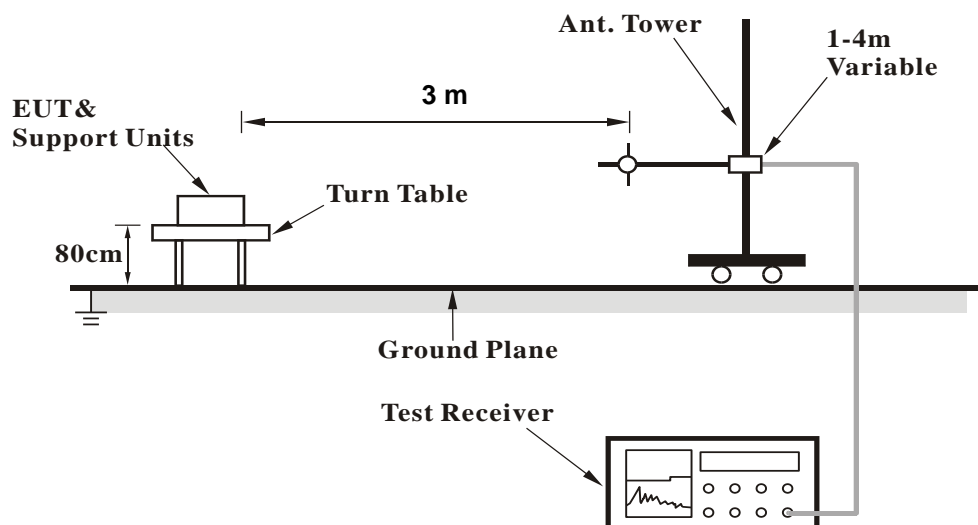

<Radiated Emissions above 1 GHz>

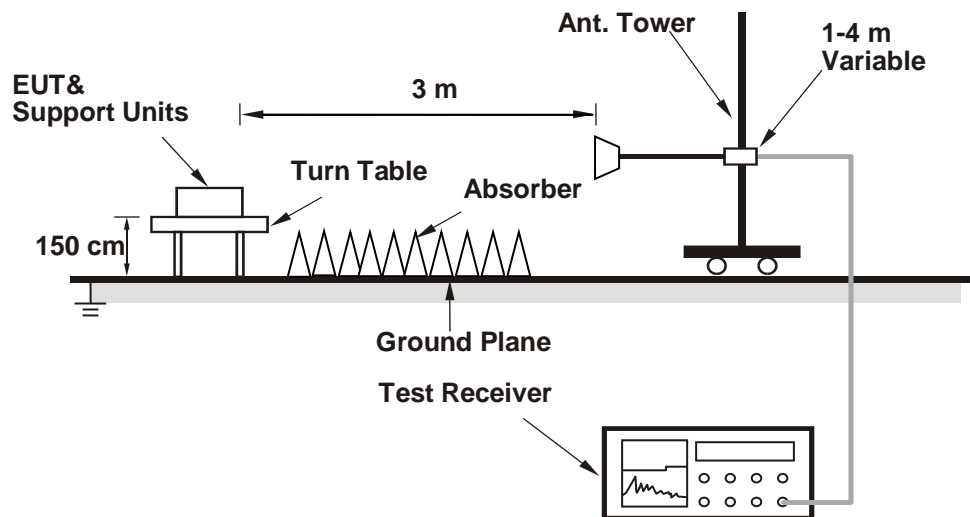

For the actual test configuration, please refer to the attached file (Test Setup Photo).

Test Instruments

Kind of Equipment	Manufacturer	Type	S/N	Calibration Date	Calibration Due Date
Signal Analyzer	R&S	FSV40	101508	2021/3/16	2022/3/15
Receiver	R&S	ESR7	102109	2021/3/16	2022/3/15
Bilog Antenna	SCHWARZBECK	VULB-9168	00951	2021/2/18	2022/2/17
Horn Antenna	ETS-Lindgren	3117	00218930	2020/12/1	2021/11/30
LF-AMP	Agilent	8447D	2944A10772	2021/2/18	2022/2/17
HF-AMP + AC source	EMCI	EMC051845SE	980633	2021/2/9	2022/2/8
HF-AMP + AC source	EMCI	EMC184045SE	980657	2021/2/1	2022/1/31
Horn Antenna	SCHWARZBECK	BBHA 9170	00887	2021/4/8	2022/4/7
Microwave Cable	HUBER+SUHNER	SUCOFLEX 104EA	800056/4EA	2021/3/17	2022/3/16
Microwave Cable	HUBER+SUHNER	SUCOFLEX 104	804680/4	2021/3/17	2022/3/16
Microwave Cable	HUBER+SUHNER	SUCOFLEX 104	MY37202/4	2021/3/17	2022/3/16
Microwave Cable	HUBER+SUHNER	SUCOFLEX 102EA	800898/2EA	2021/4/16	2022/4/15
Microwave Cable	HUBER+SUHNER	SUCOFLEX 102EA	800901/2EA	2021/4/16	2022/4/15
Microwave Cable	HUBER+SUHNER	SUCOFLEX 102EA	801027/2EA	2021/4/16	2022/4/15
Loop Antenna	SCHWARZBECK	FNZB1519B	00215	2021/9/17	2022/9/16

Test Procedures**For Radiated Emissions below 30 MHz**

- a. The EUT was placed on the top of a rotating table 0.8 meters above the ground at a 3 meter chamber room. The table was rotated 360 degrees to determine the position of the highest radiation.
- b. The EUT was set 3 meters away from the interference-receiving antenna, which was mounted on the top of a variable-height antenna tower.
- c. Parallel (OPEN), perpendicular (CLOSE), and ground-parallel (GROUND) orientations of the antenna are set to make the measurement.
- d. For each suspected emission, the EUT was arranged to its worst case and the rotatable table was turned from 0 degrees to 360 degrees to find the maximum reading.
- e. The test-receiver system was set to Quasi-Peak Detect Function and Specified Bandwidth with Maximum Hold Mode.

Note:

1. The resolution bandwidth and video bandwidth of test receiver/spectrum analyzer is 9 kHz at frequency below 30 MHz.
2. All modes of operation were investigated and the worst-case emissions are reported.

For Radiated Emissions above 30 MHz

- a. The EUT was placed on the top of a rotating table 0.8 meters (for 30 MHz ~ 1 GHz) / 1.5 meters (for above 1 GHz) above the ground at 3 meter chamber room for test. The table was rotated 360 degrees to determine the position of the highest radiation.
- b. The EUT was set 3 meters away from the interference-receiving antenna, which was mounted on the top of a variable-height antenna tower.
- c. The height of antenna is varied from one meter to four meters above the ground to determine the maximum value of the field strength. Both horizontal and vertical polarizations of the antenna are set to make the measurement.
- d. For each suspected emission, the EUT was arranged to its worst case and then the antenna was tuned to heights from 1 meter to 4 meters and the rotatable table was turned from 0 degrees to 360 degrees to find the maximum reading.
- e. The test-receiver system was set to quasi-peak detect function and specified bandwidth with maximum hold mode when the test frequency is below 1 GHz.
- f. The test-receiver system was set to peak and average detected function and specified bandwidth with maximum hold mode when the test frequency is above 1 GHz. If the peak reading value also meets average limit, measurement with the average detector is unnecessary.

Note:

1. The resolution bandwidth and video bandwidth of test receiver/spectrum analyzer is 120 kHz for Quasi-peak detection (QP) or Peak detection (PK) at frequency below 1 GHz.
2. The resolution bandwidth of test receiver/spectrum analyzer is 1 MHz and the video bandwidth is 3 MHz for Peak detection (PK) at frequency above 1 GHz.
3. The resolution bandwidth of test receiver/spectrum analyzer is 1 MHz and the video bandwidth is $\geq 1/T$ (Duty cycle < 98 %) or 10 Hz (Duty cycle \geq 98 %) for Average detection (AV) at frequency above 1 GHz.
4. For fundamental frequency: The average value is "Average = Peak value + 20log(Duty cycle)
Where the duty factor is calculated from following formula for DH5 packet type which has worst duty factor:
 $20\log(\text{Duty cycle}) = 20\log(\text{dwell time} / 100\text{ms}) = 20\log(3.125 / 100) = -30.1 \text{ dB}$
5. All modes of operation were investigated and the worst-case emissions are reported.

6. The Radiated Emissions testing was performed in the X(E1), Y(H) and Z(E2) axis orientation. The worst-case Axis orientation is recorded in this test report.

Test Results

Factor (dB/m) = Antenna Factor (dB/m) + Cable Loss (dB)

Level (dBuV/m) = Reading (dBuV) + Factor (dB/m)

Please refer to Appendix B.

5.1.6 Hopping Channel Separation

Limit ≥ 25 kHz or 2/3 of 20 dB bandwidth, whichever is greater

Kind of Test Site Shielded room

Test Setup

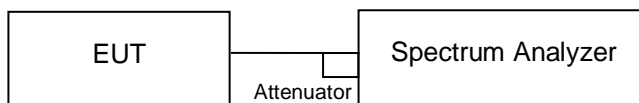

Test Instruments

Kind of Equipment	Manufacturer	Type	S/N	Calibration Date	Calibration Due Date	Test Date	
						From	Until
Spectrum Analyzer	R&S	FSV40	101512	2021/1/29	2022/1/28	2021/10/18	2021/10/18

Test Procedure

Measurement Procedure REF

- a. Check the calibration of the measuring instrument using either an internal calibrator or a known signal from an external generator.
- b. Turn on the EUT and connect it to measurement instrument. Then set it to any one convenient frequency within its operating range.
- c. By using the MaxHold function record the separation of two adjacent channels.
- d. Measure the frequency difference of these two adjacent channels by SA MARK function. And then plot the result on SA screen.
- e. Repeat above procedures until all frequencies measured were complete.

Test Results

Please refer to Appendix A.

5.1.7 Number of Hopping Frequency

Limit ≥ 15 non-overlapping channels

Kind of Test Site Shielded room

Test Setup

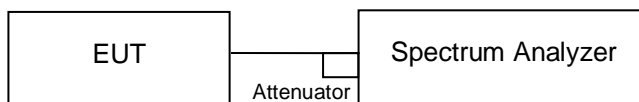

Test Instruments

Kind of Equipment	Manufacturer	Type	S/N	Calibration Date	Calibration Due Date	Test Date	
						From	Until
Spectrum Analyzer	R&S	FSV40	101512	2021/1/29	2022/1/28	2021/10/18	2021/10/18

Test Procedure

- a. Check the calibration of the measuring instrument (SA) using either an internal calibrator or a known signal from an external generator.
- b. Turn on the EUT and connect its antenna terminal to measurement via a low loss cable. Then set it to any one measured frequency within its operating range and make sure the instrument is operated in its linear range.
- c. Set the SA on MaxHold Mode, and then keep the EUT in hopping mode. Record all the signals from each channel until each one has been recorded.
- d. Set the SA on View mode and then plot the result on SA screen.
- e. Repeat above procedures until all frequencies measured were complete.

Test Results

Please refer to Appendix A.

5.1.8 Dwell Time

Limit 0.4s

Kind of Test Site Shielded room

Test Setup

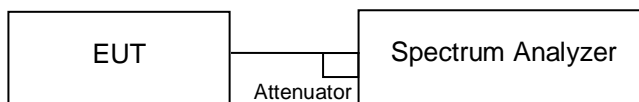

Test Instruments

Kind of Equipment	Manufacturer	Type	S/N	Calibration Date	Calibration Due Date	Test Date	
						From	Until
Spectrum Analyzer	R&S	FSV40	101512	2021/1/29	2022/1/28	2021/10/18	2021/10/18

Test Procedures

- Check the calibration of the measuring instrument (SA) using either an internal calibrator or a known signal from an external generator.
- Turn on the EUT and connect its antenna terminal to measurement via a low loss cable. Then set it to any one measured frequency within its operating range and make sure the instrument is operated in its linear range.
- Adjust the center frequency of SA on any frequency be measured and set SA to zero span mode. And then, set RBW and VBW of spectrum analyzer to proper value.
- Measure the time duration of one transmission on the measured frequency. And then plot the result with time difference of this time duration.
- Repeat above procedures until all different time-slot modes have been completed.

Test Results

Please refer to Appendix A.

5.2 Mains Emission

5.2.1 Mains Conducted Emission

Limit

Mains Conducted Emission as defined in §15.207 must comply with the mains conducted emission limits.

Kind of Test Site Shielded room

Test Setup

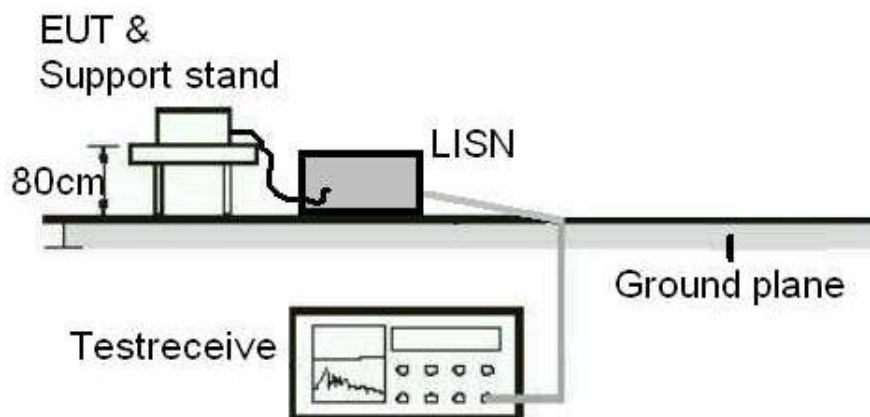

Test Instruments

Kind of Equipment	Manufacturer	Type	S/N	Calibration Date	Calibration Due Date
RF Cable	N/A	N/A	EMC-003	2021/3/16	2022/3/15
Two-Line V-Network	Rohde & Schwarz	ENV216	101938	2021/9/23	2022/9/22
EMI Test Receiver	R&S	ESCI	1816063	2021/11/15	2022/11/14

Test Procedures

- a. The EUT was placed 0.4 meters from the conducting wall of the shielded room with EUT being connected to the power mains through a line impedance stabilization network (LISN). Other support units were connected to the power mains through another LISN. The two LISNs provide 50 ohm/50 uH of coupling impedance for the measuring instrument.
- b. Both lines of the power mains connected to the EUT were checked for maximum conducted interference.
- c. The frequency range from 150 kHz to 30 MHz was searched. Emission levels under (Limit – 20 dB) was not recorded.

Note: The resolution bandwidth and video bandwidth of test receiver is 9 kHz for quasi-peak detection (QP) and average detection (AV) at frequency 0.15 MHz – 30 MHz.

Test Results

Please refer to Appendix B.

Appendix A: Test Results of Conducted Test

Test Result of 20 dB Bandwidth

GFSK

Channel	Channel Frequency (MHz)	20 dB Bandwidth (kHz)	Result
Low Channel	2402	920.10	Pass
Middle Channel	2441	923.10	Pass
High Channel	2480	923.10	Pass

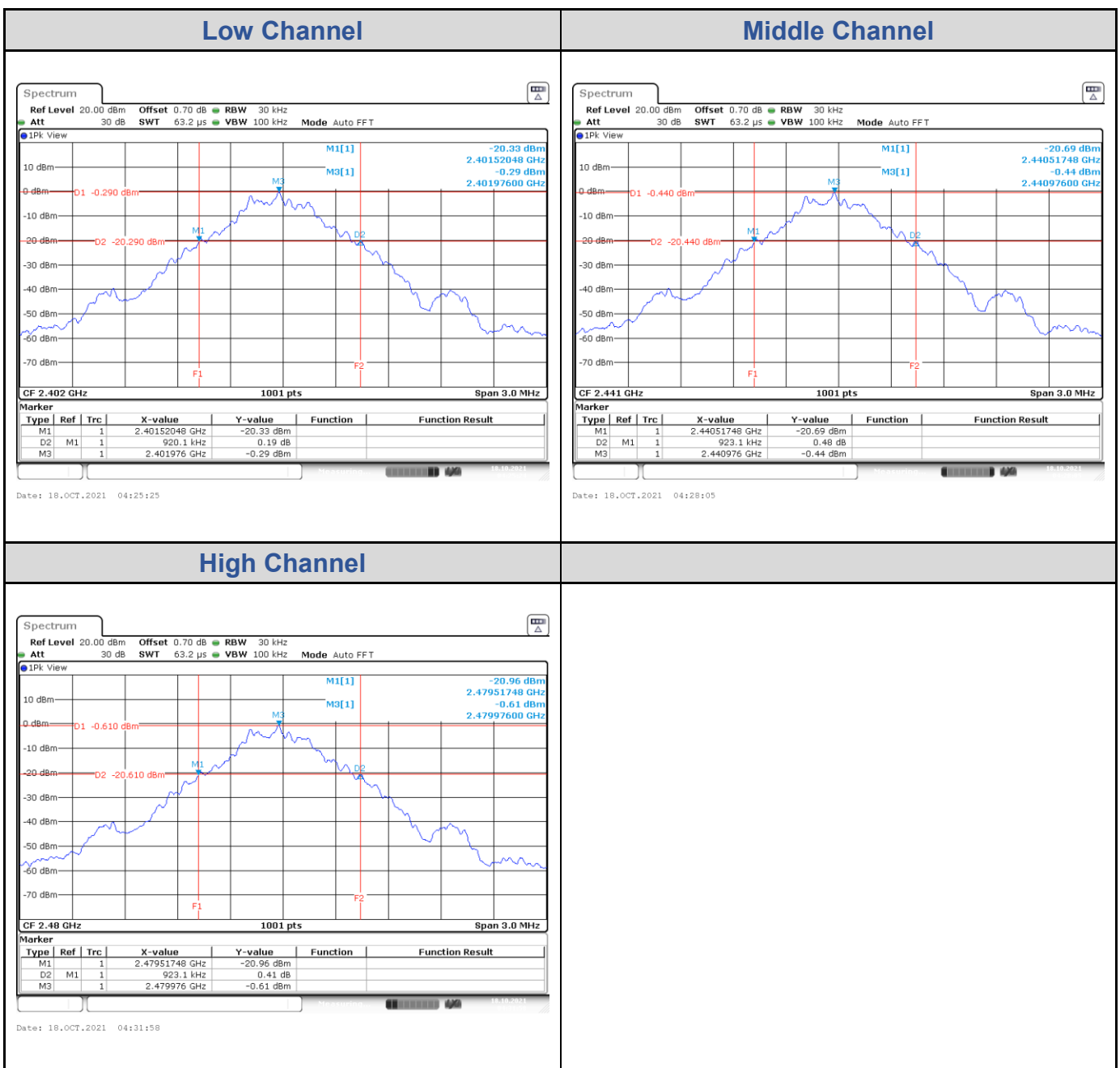

8DPSK

Channel	Channel Frequency (MHz)	20 dB Bandwidth (kHz)	Result
Low Channel	2402	1255.70	Pass
Middle Channel	2441	1252.70	Pass
High Channel	2480	1258.70	Pass

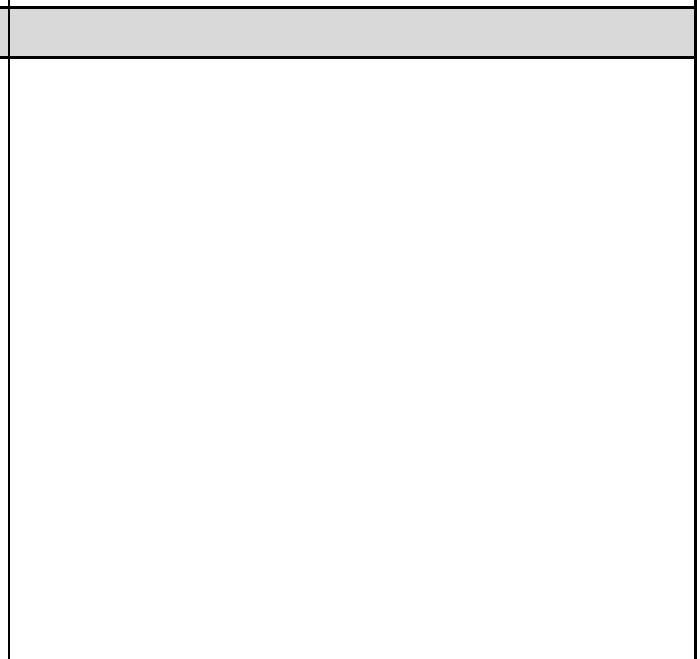
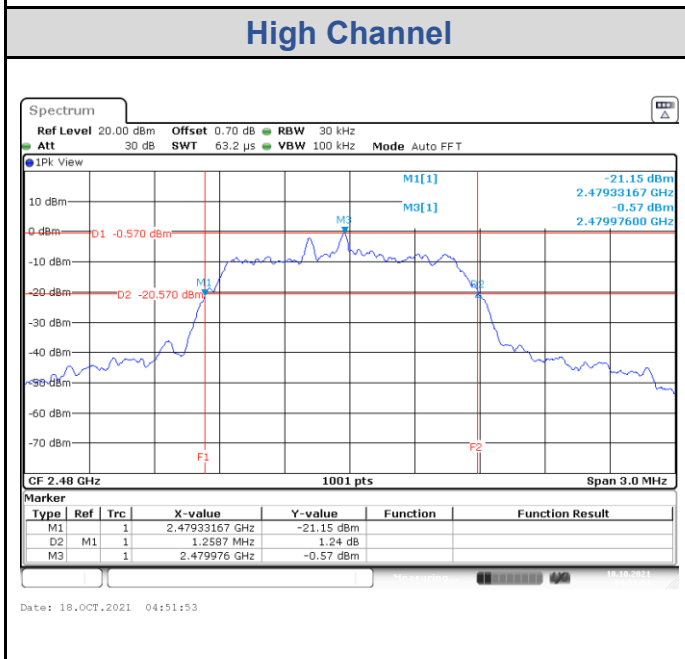
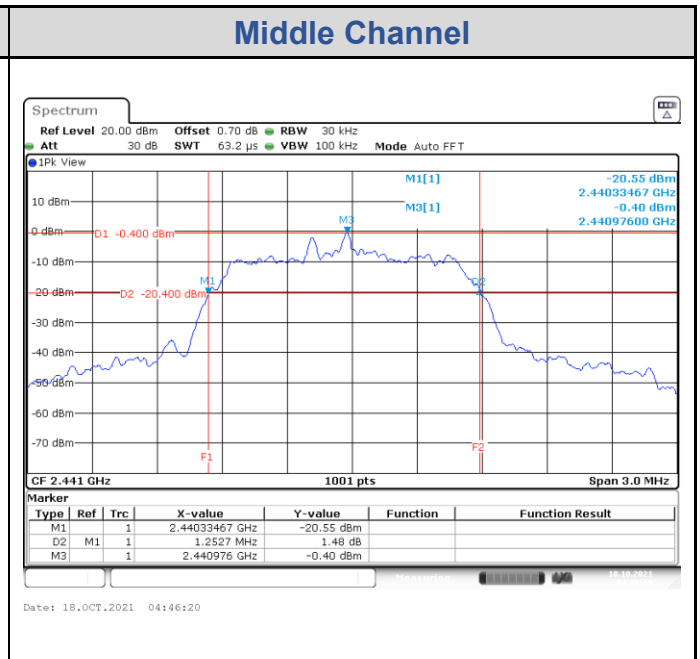
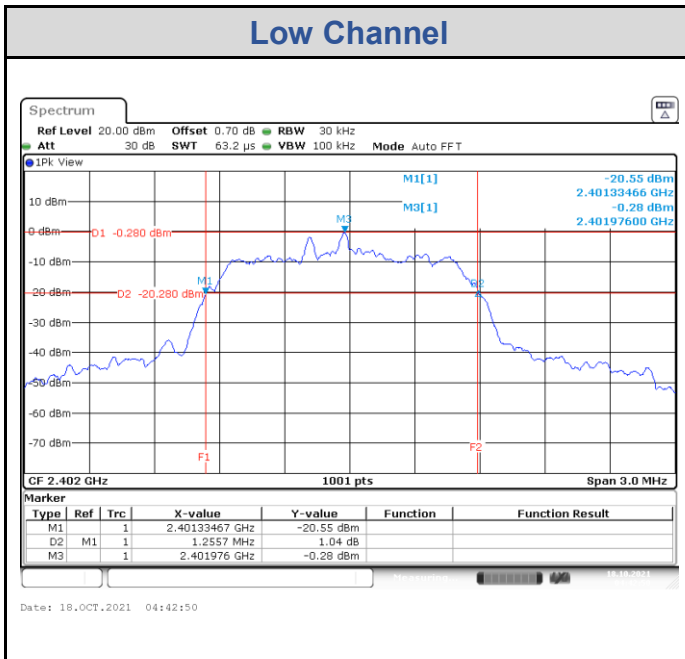

Test Result of 99% Occupied Bandwidth

GFSK

Channel	Channel Frequency (MHz)	99% Bandwidth (kHz)
Low Channel	2402	878.12
Middle Channel	2441	875.12
High Channel	2480	869.13

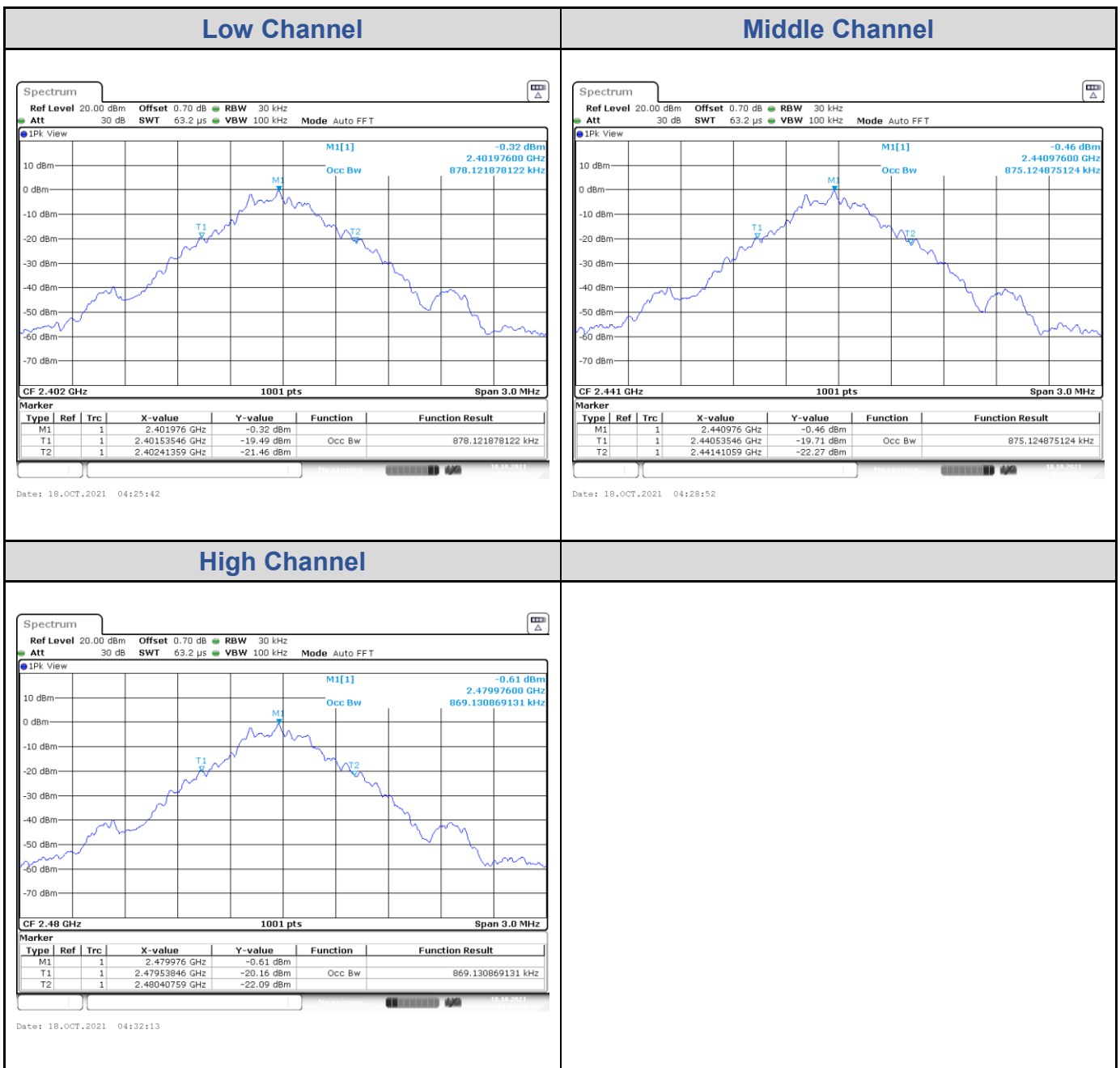

8DPSK

Channel	Channel Frequency (MHz)	99% Bandwidth (kHz)
Low Channel	2402	1165.83
Middle Channel	2441	1168.83
High Channel	2480	1168.83

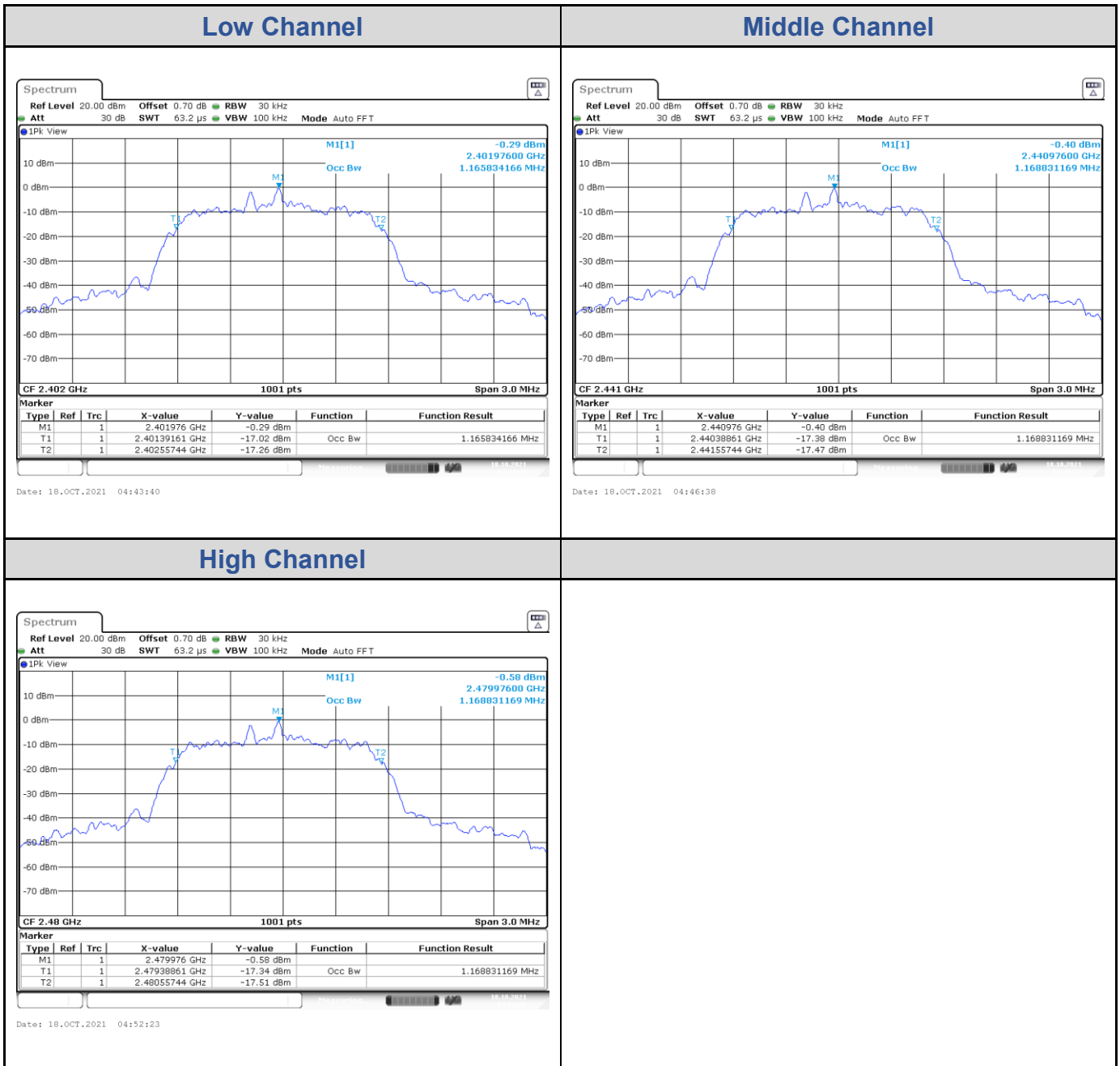

Test Result of Conducted Spurious Emissions, Tx Mode

GFSK

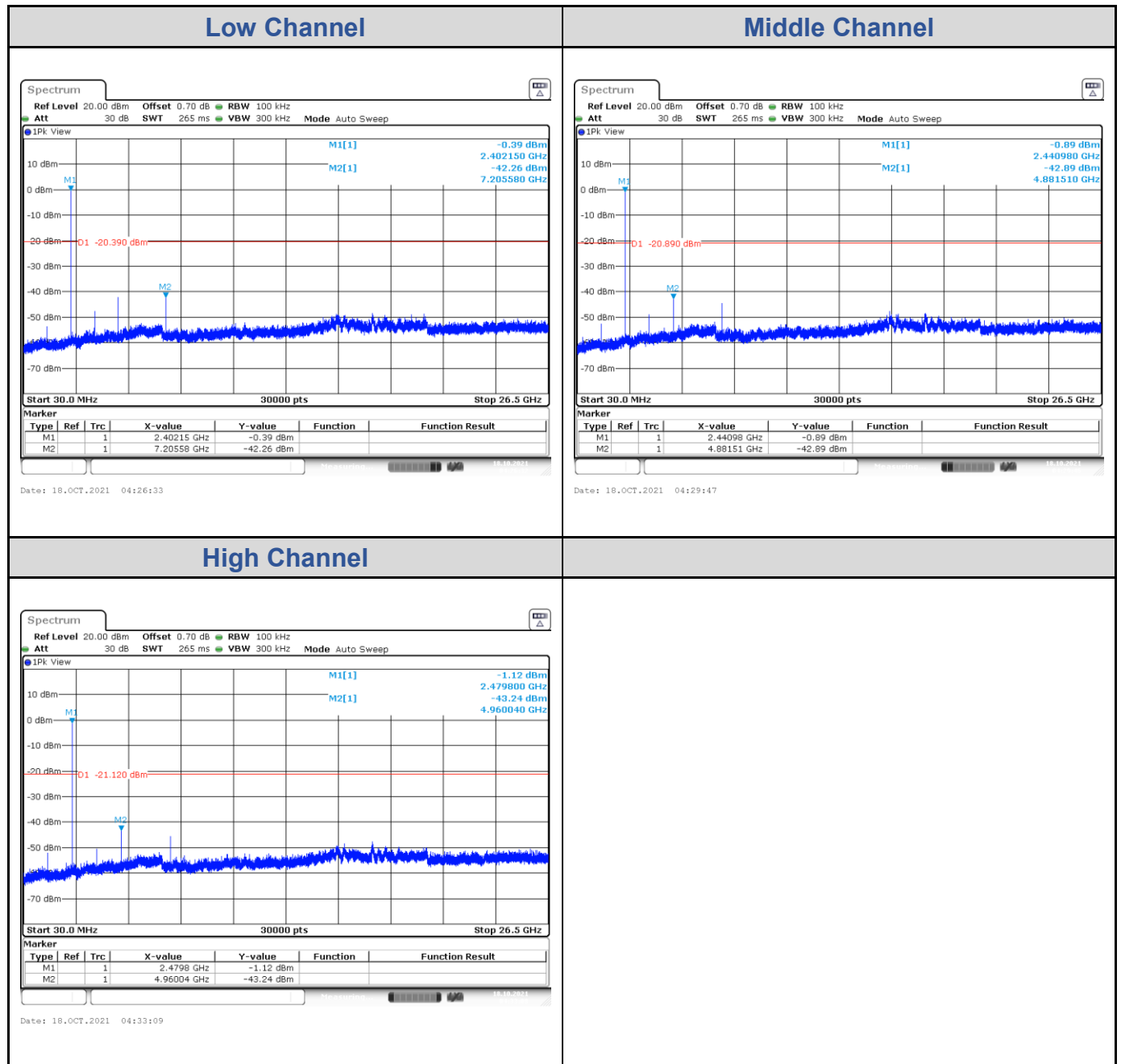

8DPSK

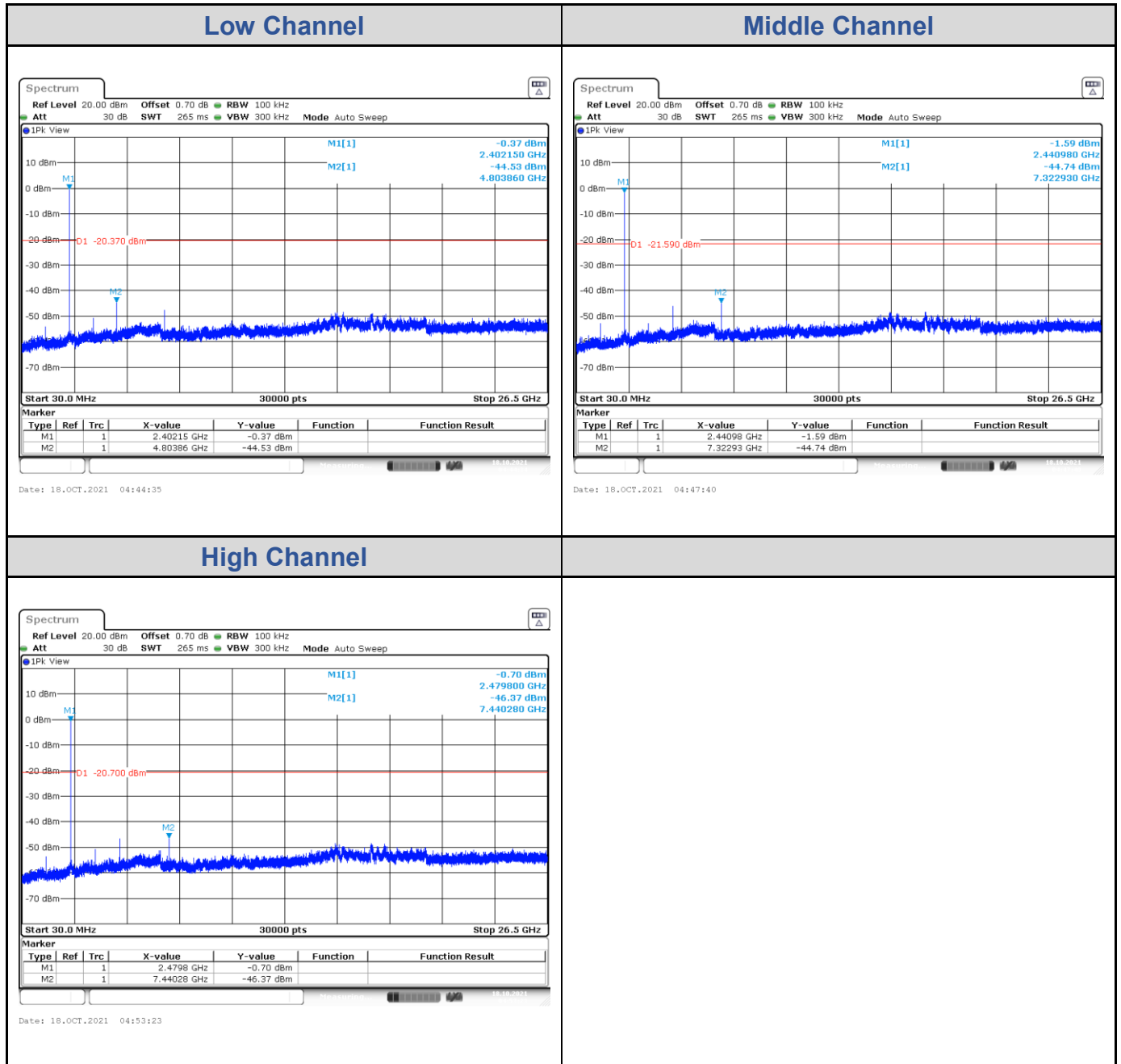

Test Result of Conducted Band Edge, Tx Mode

GFSK

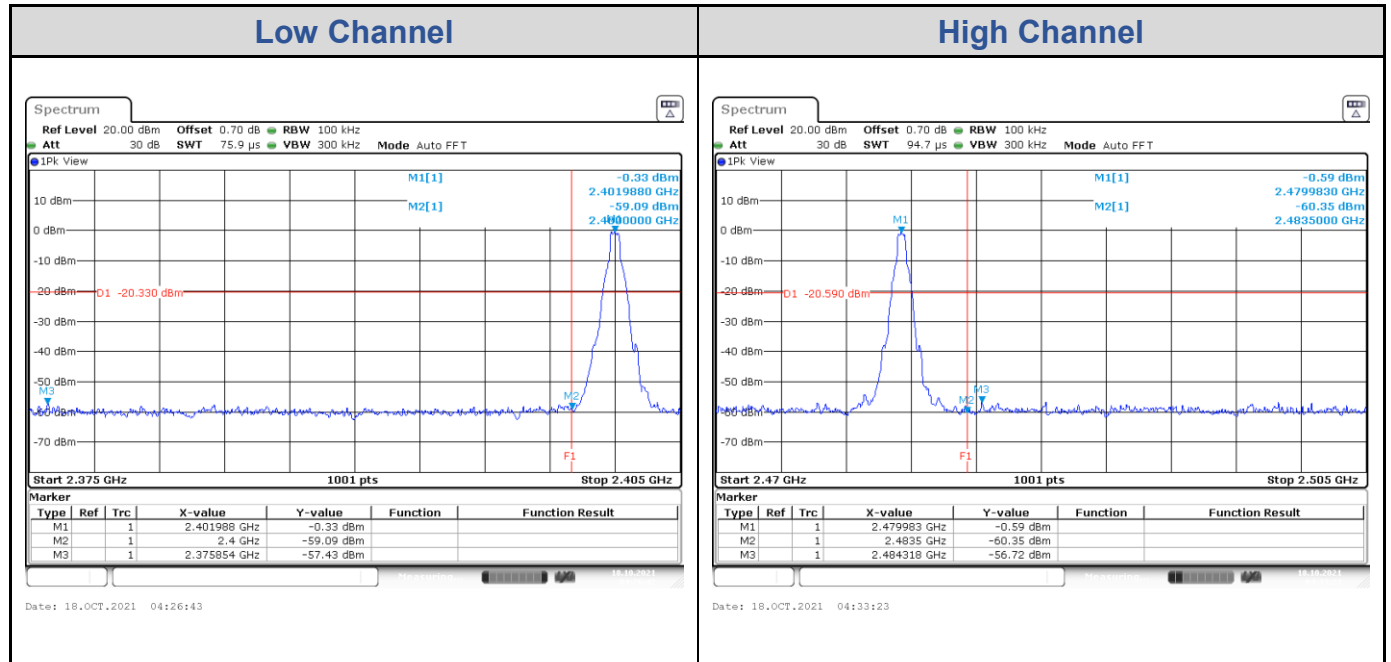

8DPSK

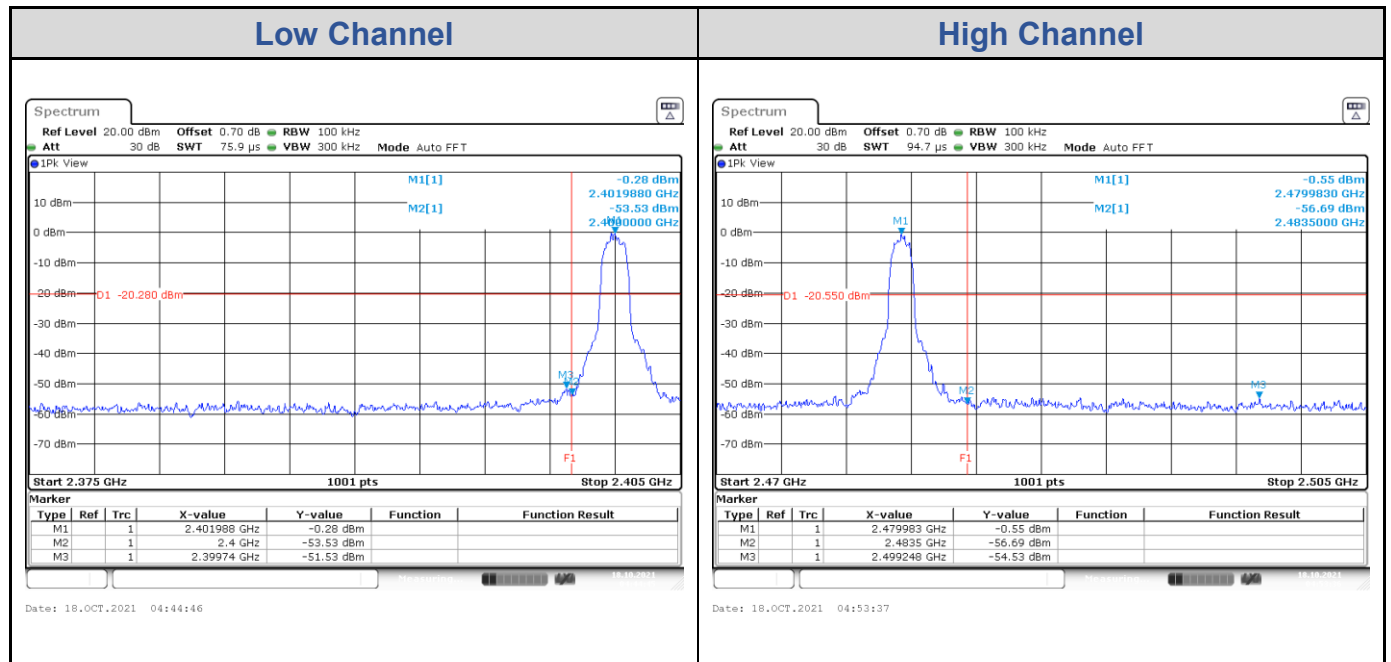

Test Result of Hopping Band Edge

GFSK

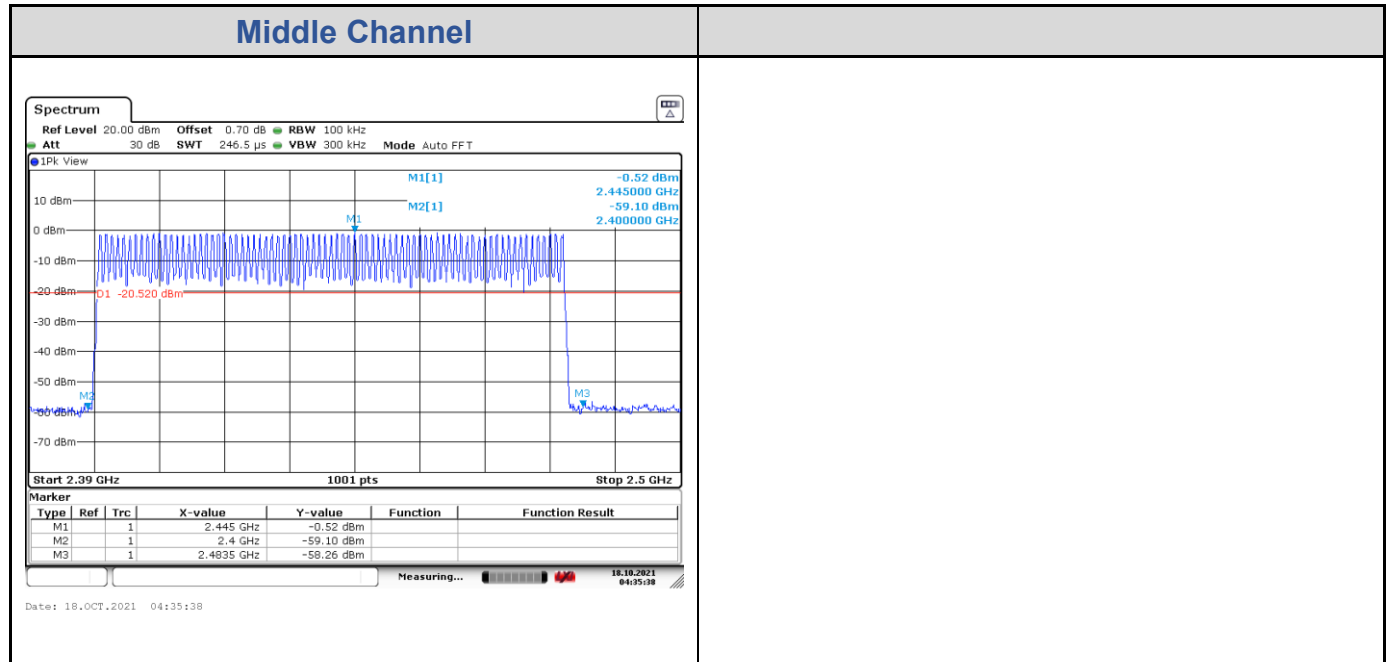

8DPSK

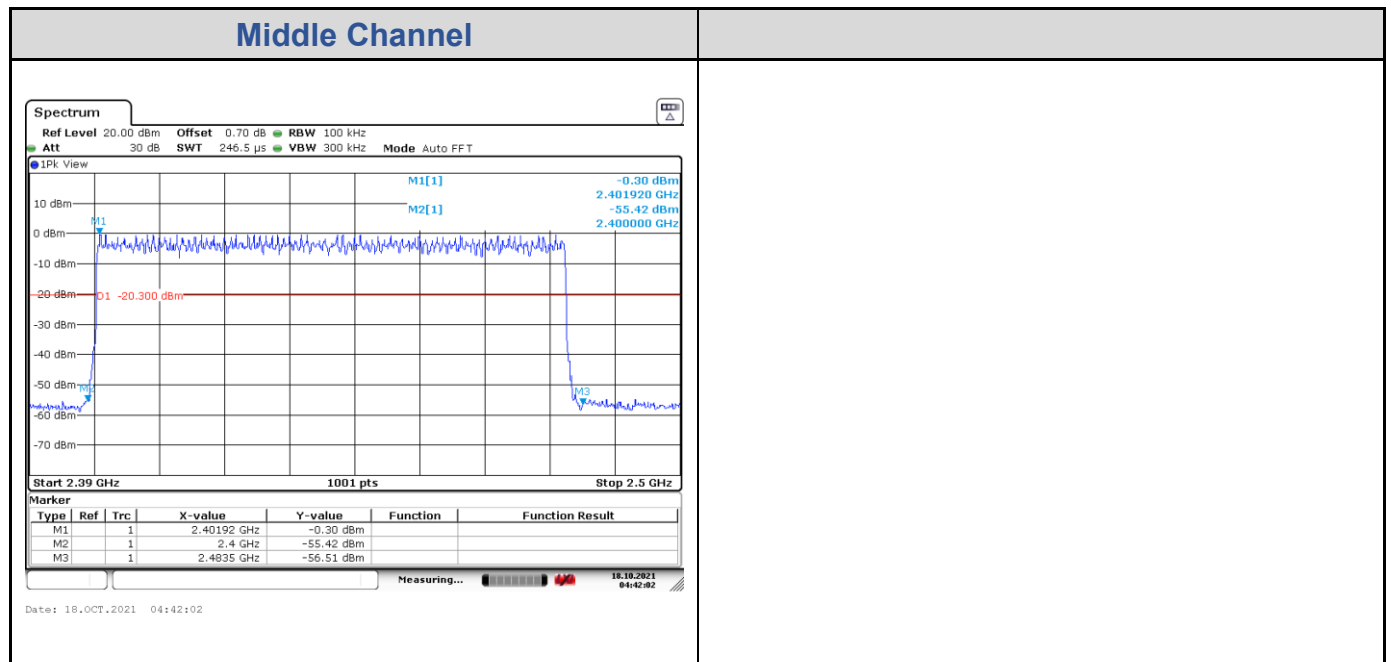

Test Result of Hopping Channel Separation

GFSK

Channel	Channel Frequency (MHz)	Adjacent Channel Separation (MHz)	20 dB Bandwidth (kHz)	Minimum Limit (MHz)	Result
0	2402	1.00	920.10	0.613	Pass
39	2441	1.00	923.10	0.615	Pass
78	2480	1.00	923.10	0.615	Pass

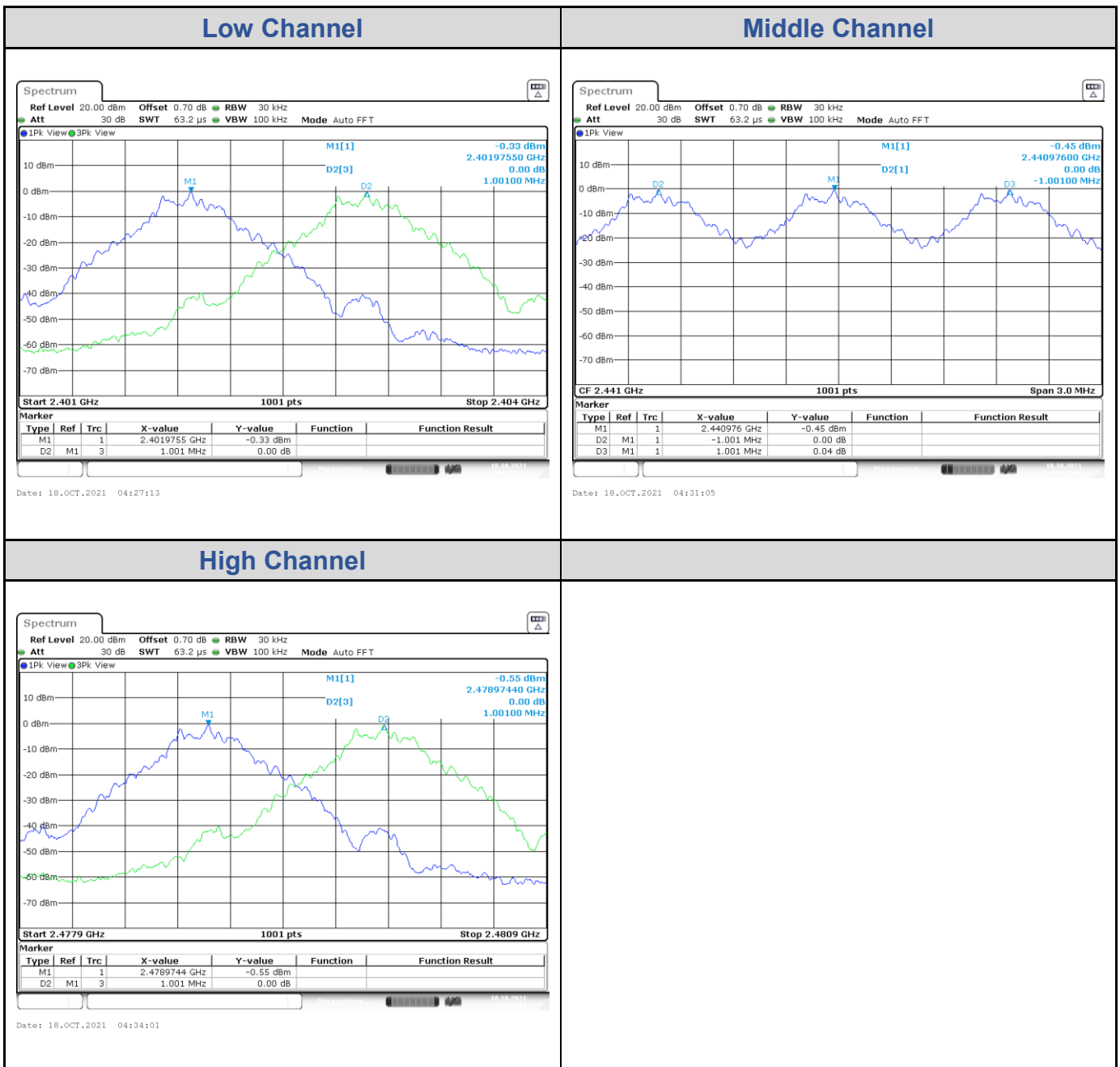

8DPSK

Channel	Channel Frequency (MHz)	Adjacent Channel Separation (MHz)	20 dB Bandwidth (kHz)	Minimum Limit (MHz)	Result
0	2402	1.00	1255.70	0.837	Pass
39	2441	1.00	1252.70	0.835	Pass
78	2480	1.00	1258.70	0.839	Pass

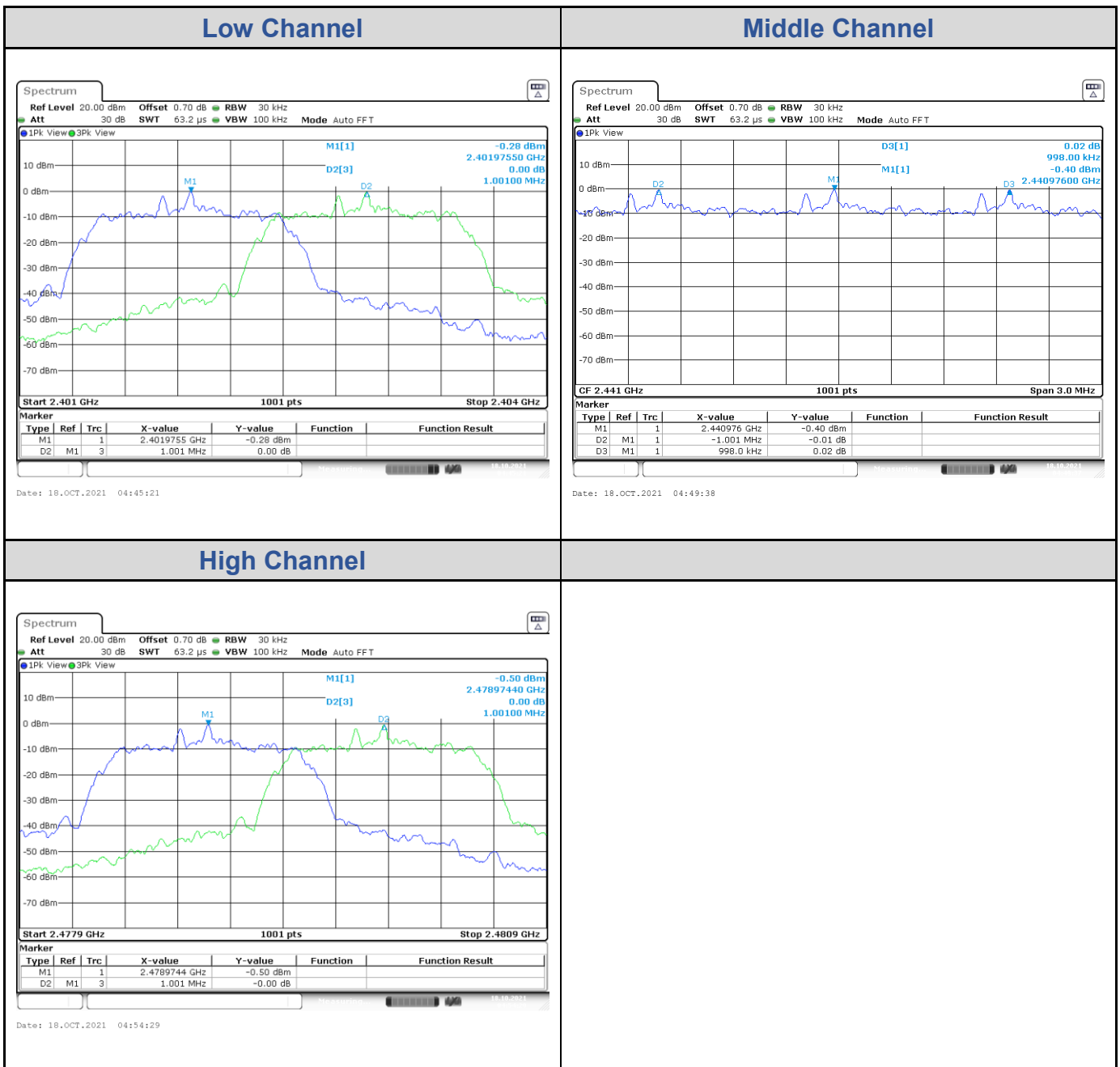

Test Result of Number of Hopping Frequency

Frequency Range	Measured Quantity of Hopping Channel	Limit	Result
2400 to 2483.5 MHz	79	≥15	Pass

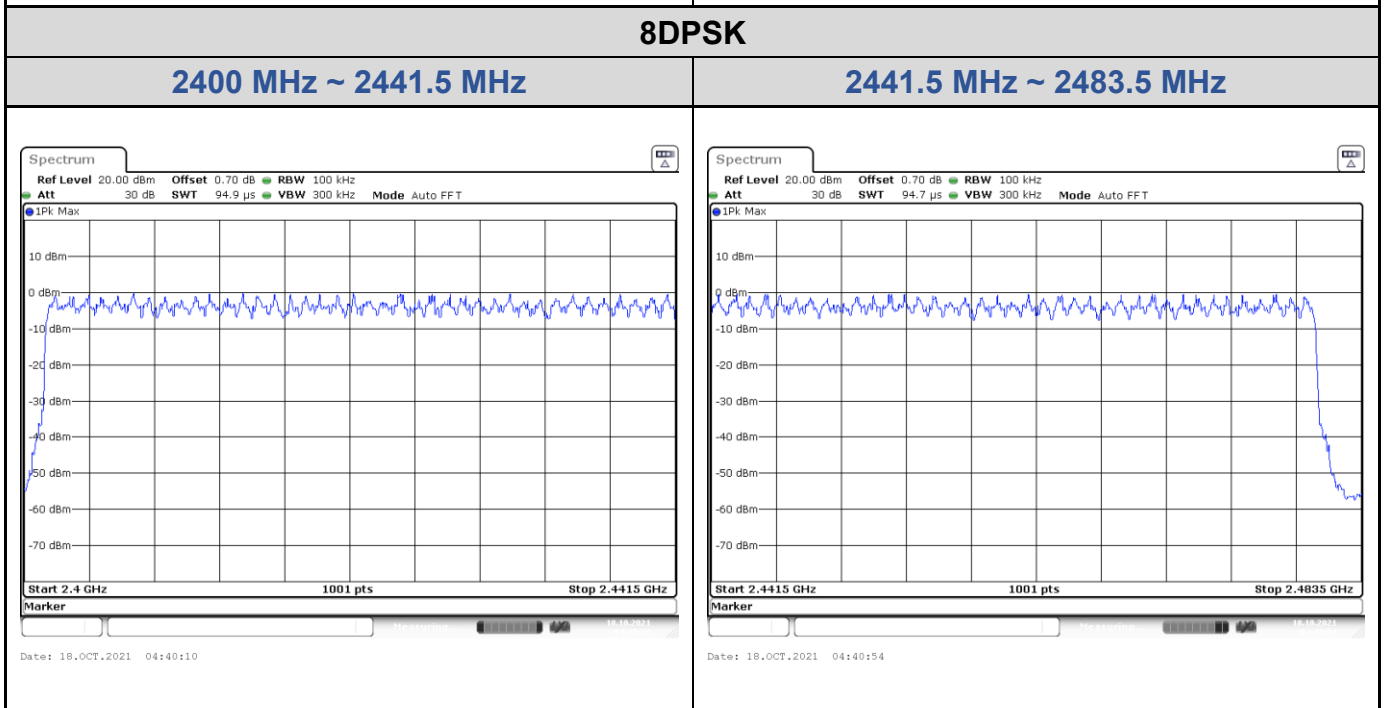
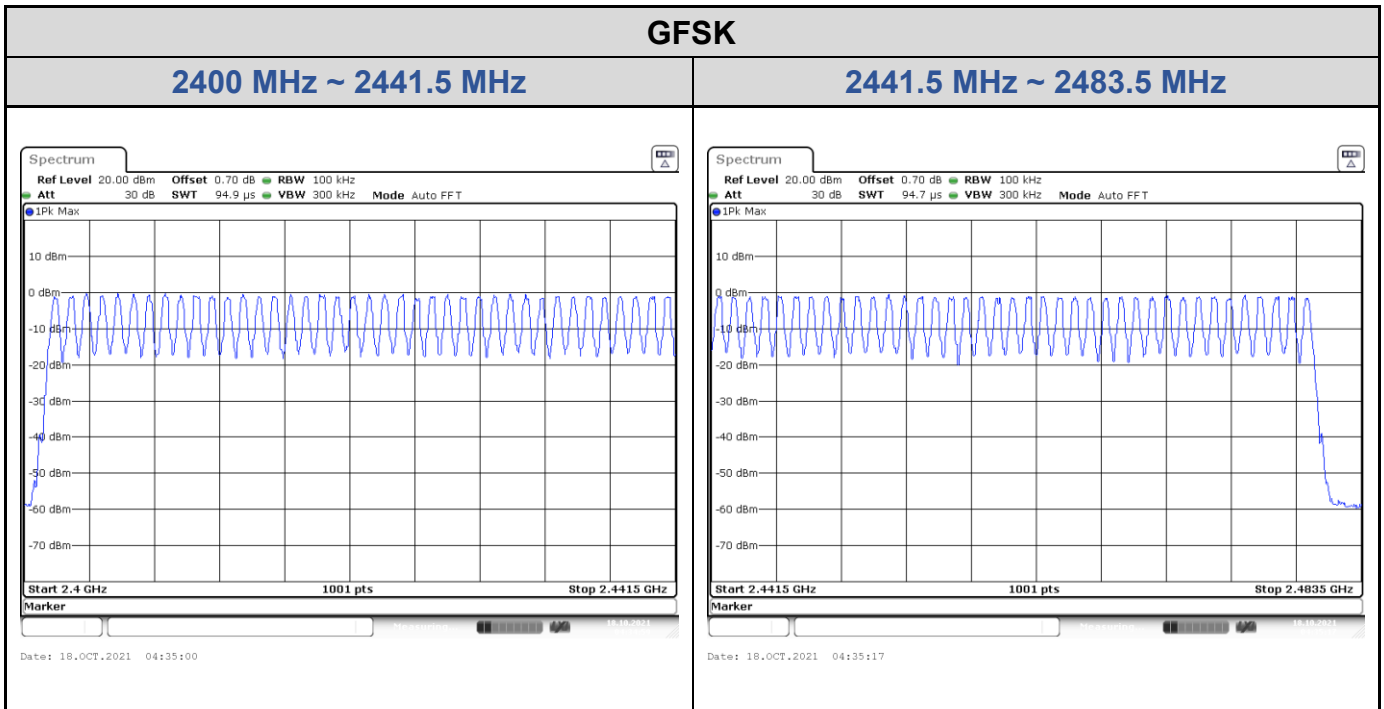

Test Result of Dwell Time

GFSK

Data Mode	Number of transfer in a 31.6 (79Hopping*0.4s)	Package transfer time (msec)	Dwell time (s)	Limit (s)	Result
1DH5	17 (times / 5 sec) * 6.32 = 107.44 times	2.93	0.314799	0.4	Pass

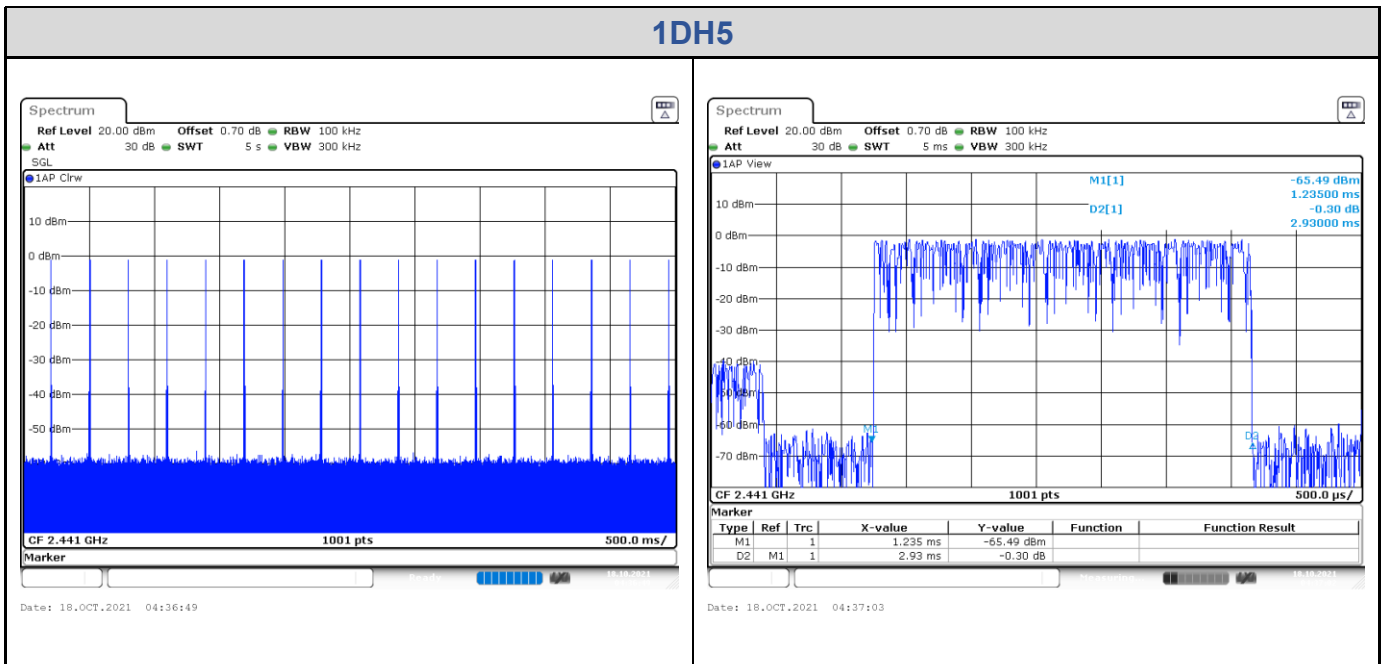

8DPSK

Data Mode	Number of transfer in a 31.6 (79Hopping*0.4s)	Package transfer time (msec)	Dwell time (s)	Limit (s)	Result
3DH5	17 (times / 5 sec) * 6.32 = 107.44 times	2.94	0.315874	0.4	Pass

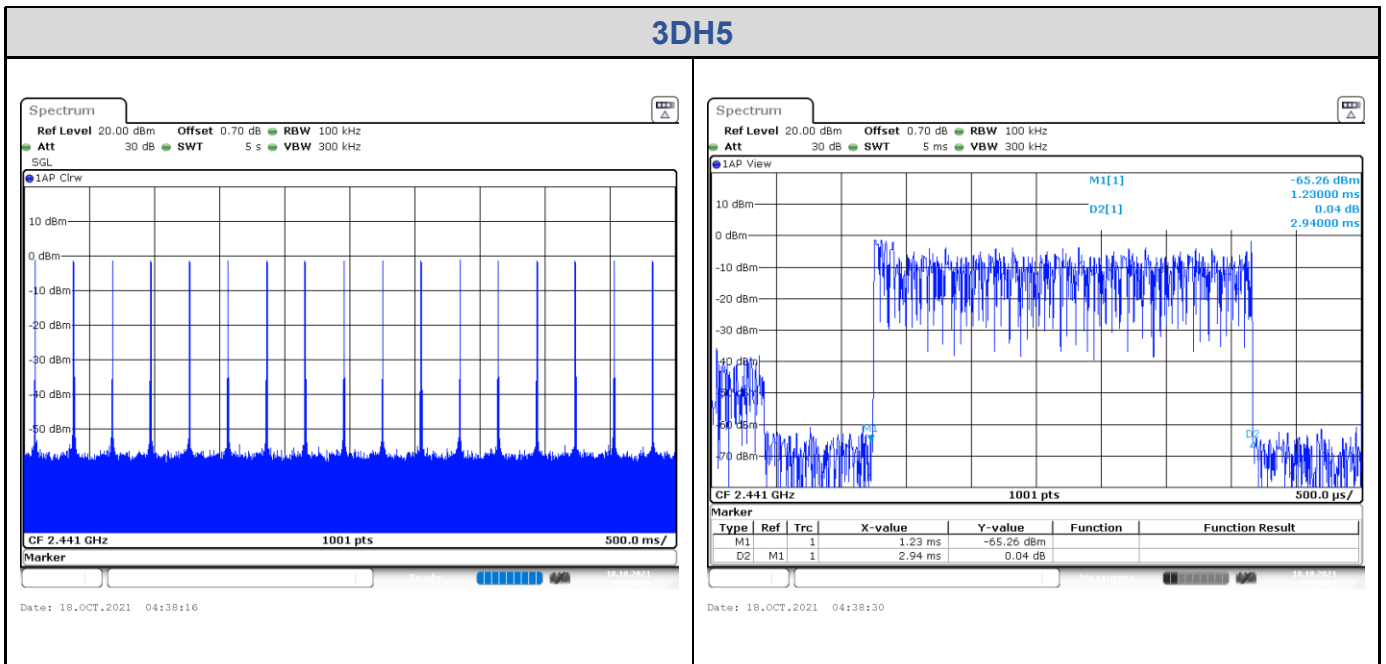

GFSK

High Channel (Horizontal)

High Channel (Vertical)



TUV Rheinland Taiwan Ltd.
No. 438-18, Sec 2, Fenliao, Linkou Dist., New Taipei City 244, Taiwan(R.O.C.)
Tel: +886-2172-1000 Fax: +886-2172-1322

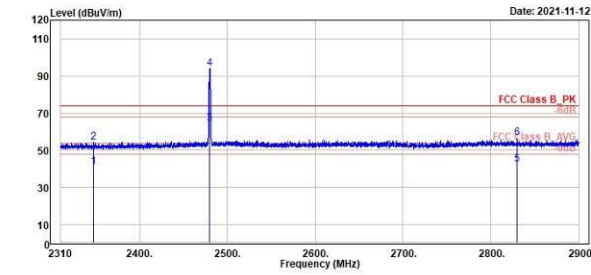

Read	Limit	Over	APos	TPos	Remark	Pol/Phase	Note			
Level	Line	Limit	cm	deg						
dBuV/m	dBuV/m	dB	cm	deg						
1	2347.64	40.86	3.59	37.27	54.00	-13.14	268	2 Average	Horizontal	
2	2347.64	54.14	16.87	37.27	74.00	-19.86	268	2 Peak	Horizontal	
3	2480.00	64.11	25.96	38.15	54.00	18.11	268	2 Average	Horizontal	
4	2480.00	94.21	56.06	38.15	74.00	20.21	268	2 Peak	Horizontal	
5	2829.91	42.47	4.13	38.34	54.00	-11.53	268	2 Average	Horizontal	
6	2829.91	56.36	18.02	38.34	74.00	-17.64	268	2 Peak	Horizontal	



TUV Rheinland Taiwan Ltd.
No. 438-18, Sec 2, Fenliao, Linkou Dist., New Taipei City 244, Taiwan(R.O.C.)
Tel: +886-2172-1000 Fax: +886-2172-1322

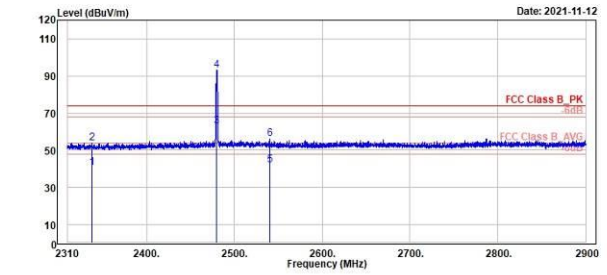

Read	Limit	Over	APos	TPos	Remark	Pol/Phase	Note			
Level	Line	Limit	cm	deg						
dBuV/m	dBuV/m	dB	cm	deg						
1	2337.85	40.76	3.52	37.24	54.00	-13.24	373	207 Average	Vertical	
2	2337.85	53.97	16.73	37.24	74.00	-20.03	373	207 Peak	Vertical	
3	2480.00	62.95	24.80	38.15	54.00	8.95	373	207 Average	Vertical	
4	2480.00	93.05	54.90	38.15	74.00	19.05	373	207 Peak	Vertical	
5	2540.34	42.06	3.92	38.14	54.00	-11.94	373	207 Average	Vertical	
6	2540.34	56.02	17.88	38.14	74.00	-17.98	373	207 Peak	Vertical	

8DPSK

Low Channel (Horizontal)

Low Channel (Vertical)



TUV Rheinland Taiwan Ltd.
No. 438-18, Sec 2, Fenliao, Linkou Dist., New Taipei City 244, Taiwan(R.O.C.)
Tel: +886-2172-1000 Fax: +886-2172-1322

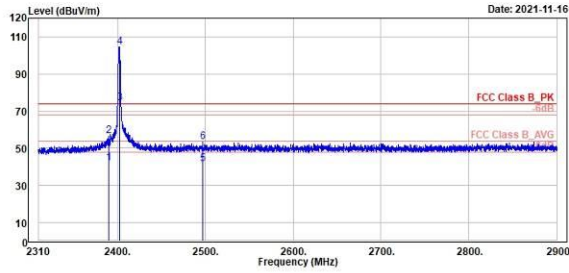

Read	Limit	Over	APos	TPos	Remark	Pol/Phase	Note
Level	Line	Limit	cm	deg			
Factor	dB/m	dB					
dBuV	dBuV/m	dB	cm	deg			
4.35	37.56	54.00	-12.09	130	196 Average	Horizontal	
19.16	37.56	74.00	-17.28	130	196 Peak	Horizontal	
36.83	37.64	54.00	26.47	130	196 Average	Horizontal	
66.93	37.64	74.00	36.57	130	196 Peak	Horizontal	
3.38	38.24	54.00	-12.38	130	196 Average	Horizontal	
15.13	38.24	74.00	-20.63	130	196 Peak	Horizontal	



TUV Rheinland Taiwan Ltd.
No. 438-18, Sec 2, Fenliao, Linkou Dist., New Taipei City 244, Taiwan(R.O.C.)
Tel: +886-2172-1000 Fax: +886-2172-1322

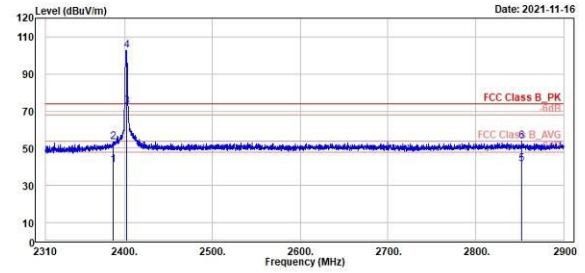

Read	Limit	Over	APos	TPos	Remark	Pol/Phase	Note
Level	Line	Limit	cm	deg			
Factor	dB/m	dB					
dBuV	dBuV/m	dB	cm	deg			
3.40	37.54	54.00	-13.06	100	191 Average	VERTICAL	
15.90	37.54	74.00	-20.56	100	191 Peak	VERTICAL	
34.95	37.64	54.00	18.59	100	191 Average	VERTICAL	
65.05	37.64	74.00	26.69	100	191 Peak	VERTICAL	
3.34	38.38	54.00	-12.28	100	191 Average	VERTICAL	
15.57	38.38	74.00	-20.05	100	191 Peak	VERTICAL	

8DPSK

High Channel (Horizontal)

High Channel (Vertical)



TUV Rheinland Taiwan Ltd.
No. 438-18, Sec 2, Fenliao, Linkou Dist., New Taipei City 244, Taiwan(R.O.C.)
Tel: +886-2172-1010 Fax: +886-2172-1322

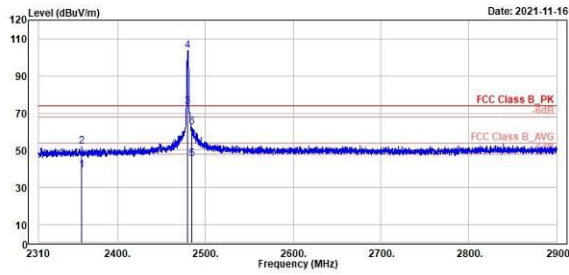

Read	Limit	Over	APos	TPos	Remark	Pol/Phase	Note			
Level	Line	Limit								
Factor										
dB/m	dBuV/m	dB	cm	deg						
1	2359.44	39.28	1.86	37.34	54.00	-14.88	137	195 Average	Horizontal	
2	2359.44	52.03	14.69	37.34	74.00	-21.97	137	195 Peak	Horizontal	
3	2480.00	73.28	35.13	38.15	54.00	19.28	137	195 Average	Horizontal	
4	2480.00	103.38	65.23	38.15	74.00	29.38	137	195 Peak	Horizontal	
5	2484.05	45.16	6.99	38.17	54.00	-8.84	137	195 Average	Horizontal	
6	2484.05	62.67	24.50	38.17	74.00	-11.33	137	195 Peak	Horizontal	



TUV Rheinland Taiwan Ltd.
No. 438-18, Sec 2, Fenliao, Linkou Dist., New Taipei City 244, Taiwan(R.O.C.)
Tel: +886-2172-1010 Fax: +886-2172-1322

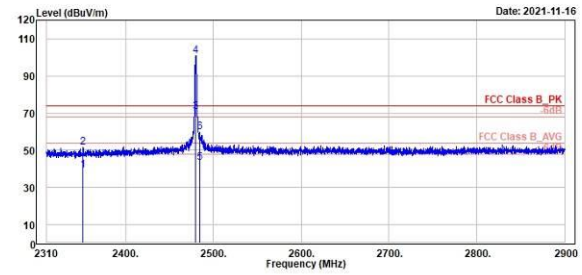

Read	Limit	Over	APos	TPos	Remark	Pol/Phase	Note			
Level	Line	Limit								
Factor										
dB/m	dBuV/m	dB	cm	deg						
1	2351.42	39.22	1.94	37.28	54.00	-14.78	100	189 Average	Vertical	
2	2351.42	51.44	14.16	37.28	74.00	-22.56	100	189 Peak	Vertical	
3	2480.00	70.87	32.72	38.15	54.00	16.87	100	189 Average	Vertical	
4	2480.00	100.97	62.82	38.15	74.00	26.97	100	189 Peak	Vertical	
5	2484.17	43.39	5.22	38.17	54.00	-10.61	100	189 Average	Vertical	
6	2484.17	59.74	21.57	38.17	74.00	-14.26	100	189 Peak	Vertical	

Spurious Emissions, Tx Mode, 9kHz ~ 30MHz
8DPSK
High Channel (Open) 9kHz~30MHz
High Channel (Close) 9kHz~30MHz

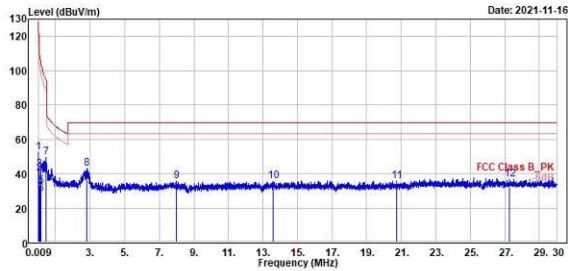

TÜV Rheinland Taiwan Ltd.
 No. 438-18, Sec. 2, Fenliao, Linkou Dist., New Taipei City 244, Taiwan(R.O.C.)
 Tel: +886-2172-1000 Fax: +886-2172-1322



1	2	3	4	5	6	7	8	9	10	11	12
Level	Read	Level	Factor	Limit	Over	APos	TPos	Remark	Pol/Phase	Note	
dBuV/m	dBuV	dB/m	dBuV/m	dB	cm	deg					
52.44	32.47	19.97	127.57	-75.13	100	15	QP	Open			
40.15	19.84	20.31	113.81	-73.66	100	201	QP	Open			
42.43	22.14	20.29	111.83	-69.40	100	160	QP	Open			
32.04	11.80	20.24	107.79	-75.75	100	196	QP	Open			
32.43	12.22	20.21	105.46	-73.03	100	128	QP	Open			
28.06	7.87	20.19	104.10	-76.04	100	170	QP	Open			
49.39	29.27	20.12	94.86	-45.47	100	198	QP	Open			
43.03	22.87	20.16	69.50	-26.47	100	301	QP	Open			
35.42	15.11	20.31	69.50	-34.08	100	17	QP	Open			
35.74	15.32	20.42	69.50	-33.76	100	224	QP	Open			
35.69	15.19	20.50	69.50	-33.81	100	85	QP	Open			
36.73	16.19	20.54	69.50	-32.77	100	72	QP	Open			

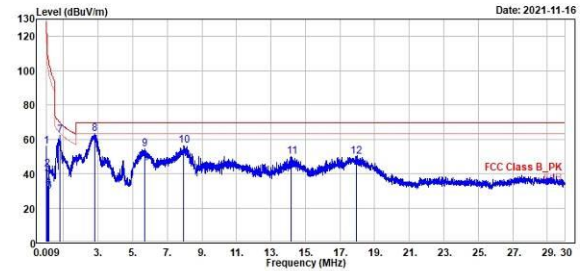

TÜV Rheinland Taiwan Ltd.
 No. 438-18, Sec. 2, Fenliao, Linkou Dist., New Taipei City 244, Taiwan(R.O.C.)
 Tel: +886-2172-1000 Fax: +886-2172-1322



1	2	3	4	5	6	7	8	9	10	11	12
Level	Read	Level	Factor	Limit	Over	APos	TPos	Remark	Pol/Phase	Note	
dBuV/m	dBuV	dB/m	dBuV/m	dB	cm	deg					
55.81	35.84	19.97	127.56	-71.75	100	218	QP	Close			
42.47	22.16	20.31	118.06	-75.59	100	334	QP	Close			
39.59	19.30	20.29	111.83	-72.24	100	117	QP	Close			
31.91	11.64	20.27	109.41	-77.50	100	51	QP	Close			
30.41	10.17	20.24	107.53	-77.12	100	168	QP	Close			
29.57	9.36	20.21	105.46	-75.80	100	172	QP	Close			
62.08	41.97	20.11	69.73	-7.65	100	30	QP	Close			
63.04	42.88	20.16	69.50	-6.46	100	137	QP	Close			
54.13	33.90	20.23	69.50	-15.37	100	124	QP	Close			
56.18	35.87	20.31	69.50	-13.32	100	1	QP	Close			
49.74	29.32	20.42	69.50	-19.76	100	90	QP	Close			
50.03	29.55	20.48	69.50	-19.47	100	190	QP	Close			

Spurious Emissions, Tx Mode, 30MHz ~ 1GHz

8DPSK

High Channel (Horizontal)

High Channel (Vertical)



TUV Rheinland Taiwan Ltd.
No. 438-18, Sec 2, Fenliao, Linkou Dist., New Taipei City 244, Taiwan(R.O.C.)
Tel: +886-2172-1000 Fax: +886-2172-1322

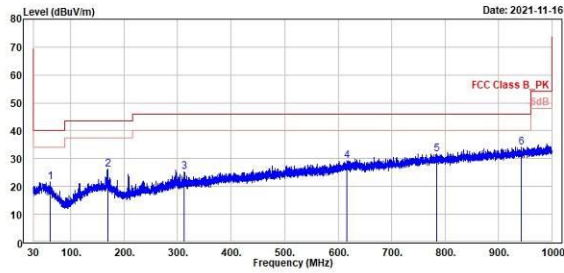

Freq	Level	Read	Limit	Over	APos	TPos	Remark	Pol/Phase	Note
MHz	dBuV/m	dBuV	dB/m	dBuV/m	dB	cm	deg		
1	68.65	21.61	30.40	-8.79	48.00	-18.39	300	129 QP	Horizontal
2	169.08	26.30	33.62	-7.32	43.50	-17.20	200	313 QP	Horizontal
3	311.98	25.33	31.50	-6.17	46.00	-26.67	100	167 QP	Horizontal
4	616.66	29.32	30.17	-0.85	46.00	-16.68	100	34 QP	Horizontal
5	784.47	31.78	29.97	1.81	46.00	-14.22	200	137 QP	Horizontal
6	942.96	34.06	29.88	4.18	46.00	-11.94	133	360 QP	Horizontal



TUV Rheinland Taiwan Ltd.
No. 438-18, Sec 2, Fenliao, Linkou Dist., New Taipei City 244, Taiwan(R.O.C.)
Tel: +886-2172-1000 Fax: +886-2172-1322

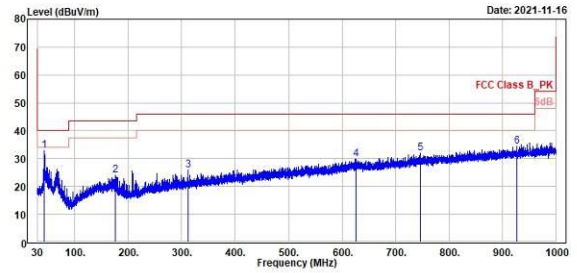

Freq	Level	Read	Limit	Over	APos	TPos	Remark	Pol/Phase	Note
MHz	dBuV/m	dBuV	dB/m	dBuV/m	dB	cm	deg		
1	42.71	32.79	48.41	-7.62	48.00	-7.21	100	303 QP	Vertical
2	175.02	24.07	31.74	-7.67	43.50	-19.43	205	156 QP	Vertical
3	312.08	25.82	31.99	-6.17	46.00	-20.18	328	329 QP	Vertical
4	625.68	29.93	30.69	-0.76	46.00	-16.07	100	137 QP	Vertical
5	746.05	31.95	30.77	1.18	46.00	-14.05	148	156 QP	Vertical
6	927.15	34.47	30.57	3.90	46.00	-11.53	207	215 QP	Vertical

Spurious Emissions, Tx Mode, 1GHz ~ 26.5GHz
GFSK
Low Channel (Horizontal)
Low Channel (Vertical)

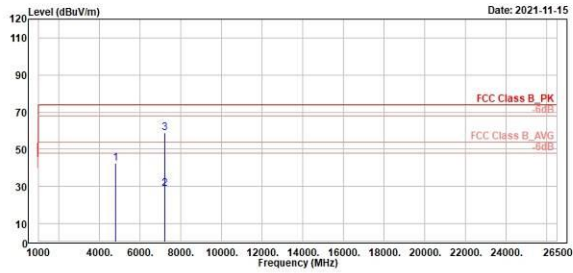

TUV Rheinland Taiwan Ltd.
 No. 438-18, Sec 2, Fenliao, Linkou Dist., New Taipei City 244, Taiwan(R.O.C.)
 Tel: +886-2172-1010 Fax: +886-2172-1322



Freq	Level	Read Level	Factor	Limit Line	Over Limit	APos	TPos	Remark	Pol/Phase	Note
MHz	dBuV/m	dBuV	dB/m	dBuV/m	dB	cm	deg			
1	4804.00	42.28	52.06	-9.78	74.00	-31.72	100	227 Peak	Horizontal	
2	7206.00	28.86	36.10	-7.24	54.00	-25.14	100	349 Average	Horizontal	
3	7206.00	58.96	66.20	-7.24	74.00	-15.04	100	349 Peak	Horizontal	

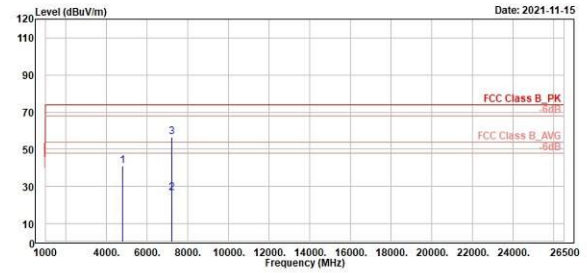

TUV Rheinland Taiwan Ltd.
 No. 438-18, Sec 2, Fenliao, Linkou Dist., New Taipei City 244, Taiwan(R.O.C.)
 Tel: +886-2172-1010 Fax: +886-2172-1322



Freq	Level	Read Level	Factor	Limit Line	Over Limit	APos	TPos	Remark	Pol/Phase	Note
MHz	dBuV/m	dBuV	dB/m	dBuV/m	dB	cm	deg			
1	4804.00	41.19	50.97	-9.78	74.00	-32.81	300	341 Peak	Vertical	
2	7206.00	26.38	33.62	-7.24	54.00	-27.62	400	290 Average	Vertical	
3	7206.00	56.48	63.72	-7.24	74.00	-17.52	400	290 Peak	Vertical	

GFSK
Middle Channel (Horizontal)
Middle Channel (Vertical)

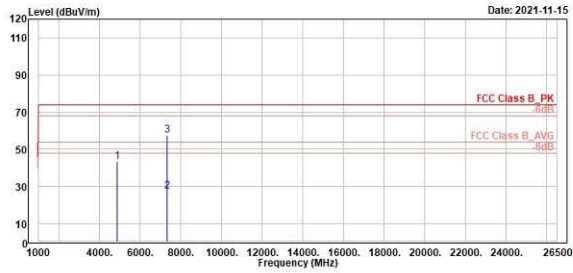

TUV Rheinland Taiwan Ltd.
 No. 438-18, Sec 2, Fenliao, Linkou Dist., New Taipei City 244, Taiwan(R.O.C.)
 Tel: +886-2172-1010 Fax: +886-2172-1322



Freq	Level	Read Level	Factor	Limit Line	Over Limit	APos	TPos	Remark	Pol/Phase	Note
MHz	dBuV/m	dBuV	dB/m	dBuV/m	dB	cm	deg			
1	4882.00	43.27	52.93	-9.66	74.00	-30.73	300	254 Peak	Horizontal	
2	7323.00	27.43	34.71	-7.28	54.00	-26.57	100	345 Average	Horizontal	
3	7323.00	57.53	64.81	-7.28	74.00	-16.47	100	345 Peak	Horizontal	

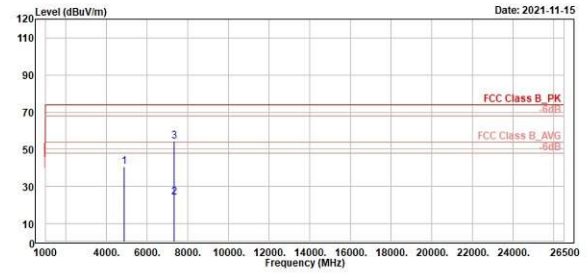

TUV Rheinland Taiwan Ltd.
 No. 438-18, Sec 2, Fenliao, Linkou Dist., New Taipei City 244, Taiwan(R.O.C.)
 Tel: +886-2172-1010 Fax: +886-2172-1322



Freq	Level	Read Level	Factor	Limit Line	Over Limit	APos	TPos	Remark	Pol/Phase	Note
MHz	dBuV/m	dBuV	dB/m	dBuV/m	dB	cm	deg			
1	4882.00	40.64	50.30	-9.66	74.00	-33.36	370	360 Peak	Vertical	
2	7323.00	24.38	31.66	-7.28	54.00	-29.62	400	286 Average	Vertical	
3	7323.00	54.48	61.76	-7.28	74.00	-19.52	400	286 Peak	Vertical	

GFSK
High Channel (Horizontal)
High Channel (Vertical)

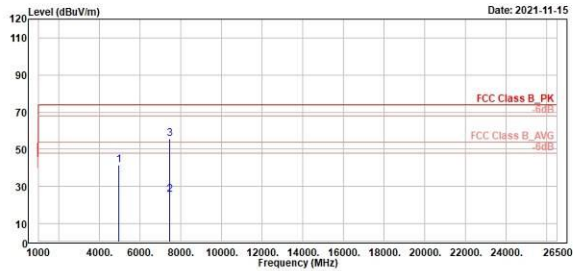

TÜV Rheinland Taiwan Ltd.
 No. 438-18, Sec 2, Fenliao, Linkou Dist., New Taipei City 244, Taiwan(R.O.C.)
 Tel: +886-2172-1010 Fax: +886-2172-1322



Freq	Level	Read Level	Factor	Limit Line	Over Limit	APos	TPos	Remark	Pol/Phase	Note
MHz	dBuV/m	dBuV	dB/m	dBuV/m	dB	cm	deg			
1	4968.00	41.64	51.10	-9.46	74.00	-32.36	100	229 Peak	Horizontal	
2	7440.00	25.76	33.01	-7.25	54.00	-28.24	100	7 Average	Horizontal	
3	7440.00	55.86	63.11	-7.25	74.00	-18.14	100	7 Peak	Horizontal	

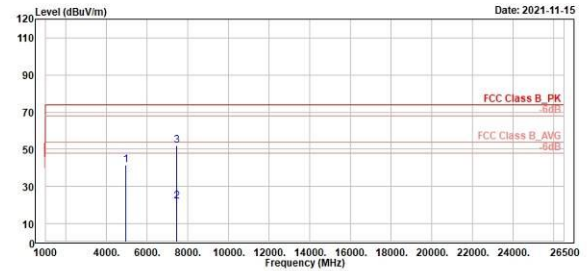

TÜV Rheinland Taiwan Ltd.
 No. 438-18, Sec 2, Fenliao, Linkou Dist., New Taipei City 244, Taiwan(R.O.C.)
 Tel: +886-2172-1010 Fax: +886-2172-1322



Freq	Level	Read Level	Factor	Limit Line	Over Limit	APos	TPos	Remark	Pol/Phase	Note
MHz	dBuV/m	dBuV	dB/m	dBuV/m	dB	cm	deg			
1	4968.00	41.58	51.04	-9.46	74.00	-32.42	300	305 Peak	Vertical	
2	7440.00	22.05	29.30	-7.25	54.00	-31.95	400	286 Average	Vertical	
3	7440.00	52.15	59.40	-7.25	74.00	-21.85	400	286 Peak	Vertical	

8DPSK
Low Channel (Horizontal)
Low Channel (Vertical)

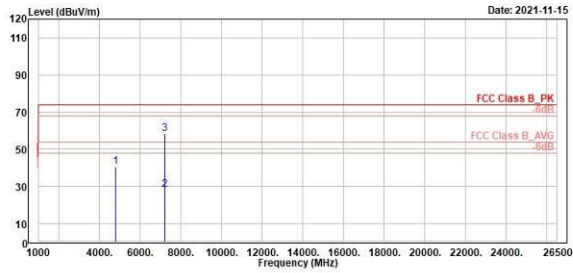

TUV Rheinland Taiwan Ltd.
 No. 438-18, Sec 2, Fenliao, Linkou Dist., New Taipei City 244, Taiwan(R.O.C.)
 Tel: +886-2172-1010 Fax: +886-2172-1322



Freq	Level	Read	Limit	Over	Apos	TPos	Remark	Pol/Phase	Note
MHz	dBuV/m	dBuV	dB/m	dBuV/m	dB	cm	deg		
1	4804.00	40.71	50.49	-9.78	74.00	-33.29	290	235 Peak	Horizontal
2	7206.00	28.46	35.70	-7.24	54.00	-25.54	180	348 Average	Horizontal
3	7206.00	58.56	65.80	-7.24	74.00	-15.44	180	348 Peak	Horizontal

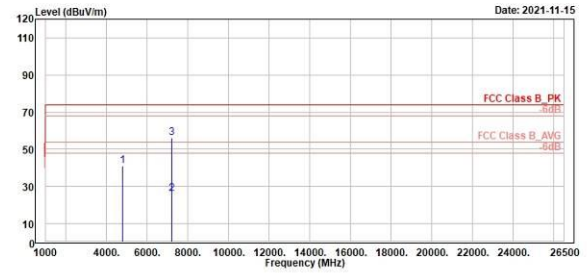

TUV Rheinland Taiwan Ltd.
 No. 438-18, Sec 2, Fenliao, Linkou Dist., New Taipei City 244, Taiwan(R.O.C.)
 Tel: +886-2172-1010 Fax: +886-2172-1322



Freq	Level	Read	Limit	Over	Apos	TPos	Remark	Pol/Phase	Note
MHz	dBuV/m	dBuV	dB/m	dBuV/m	dB	cm	deg		
1	4804.00	41.05	50.83	-9.78	74.00	-32.95	300	164 Peak	Vertical
2	7206.00	25.80	33.04	-7.24	54.00	-28.20	400	290 Average	Vertical
3	7206.00	55.90	63.14	-7.24	74.00	-18.10	400	290 Peak	Vertical

8DPSK

Middle Channel (Horizontal)

Middle Channel (Vertical)



TUV Rheinland Taiwan Ltd.
No. 438-18, Sec 2, Fenliao, Linkou Dist., New Taipei City 244, Taiwan(R.O.C.)
Tel: +886-2172-1010 Fax: +886-2172-1322

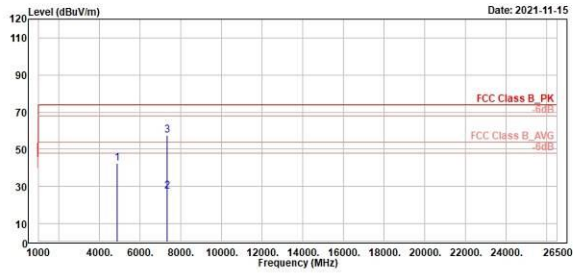

1	2	3
Level	Level	Level
Factor	Factor	Factor
Line	Line	Line
Limit	Limit	Limit
Over	Over	Over
Apos	Apos	Apos
TPos	TPos	TPos
Remark	Remark	Remark
Pol/Phase	Pol/Phase	Pol/Phase
Note	Note	Note
4882.00	7323.00	7323.00
42.39	27.41	57.51
52.85	34.69	64.79
-9.66	-7.28	-7.28
74.00	54.00	74.00
-31.61	-26.59	-16.49
400	100	100
296	347	347
Peak	Average	Peak
Horizontal	Horizontal	Horizontal



TUV Rheinland Taiwan Ltd.
No. 438-18, Sec 2, Fenliao, Linkou Dist., New Taipei City 244, Taiwan(R.O.C.)
Tel: +886-2172-1010 Fax: +886-2172-1322

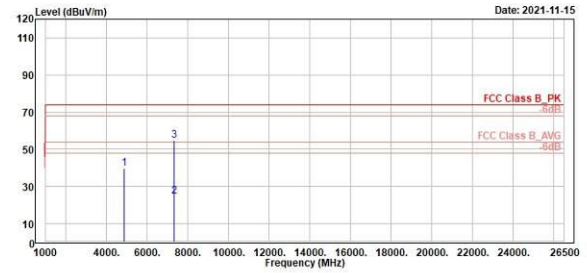

1	2	3
Level	Level	Level
Factor	Factor	Factor
Line	Line	Line
Limit	Limit	Limit
Over	Over	Over
Apos	Apos	Apos
TPos	TPos	TPos
Remark	Remark	Remark
Pol/Phase	Pol/Phase	Pol/Phase
Note	Note	Note
4882.00	7323.00	7323.00
39.74	24.50	54.60
49.40	31.78	61.88
-9.66	-7.28	-7.28
74.00	54.00	74.00
-34.26	-29.50	-19.40
400	400	400
2	285	285
Peak	Average	Peak
Vertical	Vertical	Vertical

8DPSK

High Channel (Horizontal)

High Channel (Vertical)



TUV Rheinland Taiwan Ltd.
No. 438-18, Sec 2, Fenliao, Linkou Dist., New Taipei City 244, Taiwan(R.O.C.)
Tel: +886-2172-1010 Fax: +886-2172-1322

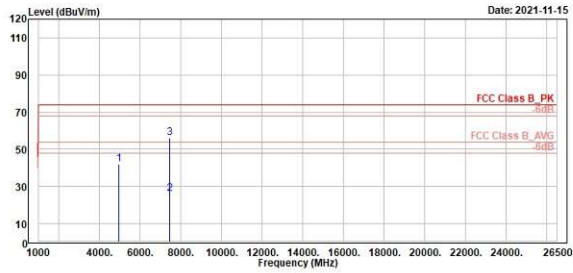

Freq	Level	Read Level	Factor	Limit Line	Over Limit	APos	TPos	Remark	Pol/Phase	Note
MHz	dBuV/m	dBuV	dB/m	dBuV/m	dB	cm	deg			
1	4960.00	42.05	51.51	-9.46	74.00	-31.95	100	281 Peak	Horizontal	
2	7440.00	26.07	33.32	-7.25	54.00	-27.93	100	7 Average	Horizontal	
3	7440.00	56.17	63.42	-7.25	74.00	-17.83	100	7 Peak	Horizontal	



TUV Rheinland Taiwan Ltd.
No. 438-18, Sec 2, Fenliao, Linkou Dist., New Taipei City 244, Taiwan(R.O.C.)
Tel: +886-2172-1010 Fax: +886-2172-1322

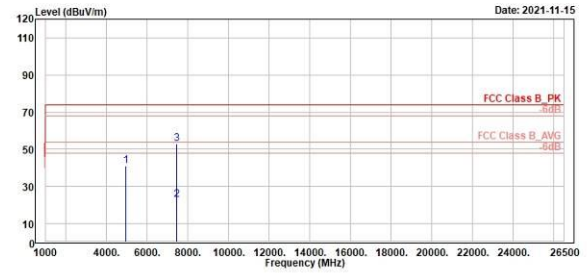

Freq	Level	Read Level	Factor	Limit Line	Over Limit	APos	TPos	Remark	Pol/Phase	Note
MHz	dBuV/m	dBuV	dB/m	dBuV/m	dB	cm	deg			
1	4960.00	40.86	50.32	-9.46	74.00	-33.14	300	360 Peak	Vertical	
2	7440.00	22.87	30.12	-7.25	54.00	-31.13	400	290 Average	Vertical	
3	7440.00	52.97	60.22	-7.25	74.00	-21.03	400	290 Peak	Vertical	

Mains Conducted Emission, 150kHz ~ 30MHz

Worst Band

(Line)

(Neutral)



TUV Rheinland Taiwan Ltd.
No. 458-18, Sec. 2, Fenhiao, Linkou Dist., New Taipei City 244, Taiwan (R.O.C.)
Tel: +886-2112-1000 Fax: +886-2112-1322

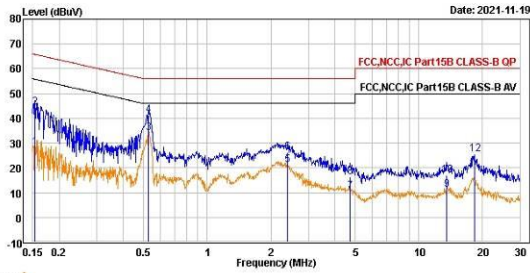

Trace: 1

Line	Freq	Level	Read Level	Factor	Limit	Over	Remark	Pol/Phase	Note
	MHz	dBuV	dBuV	dB	dBuV	dB			
1	0.15	28.28	18.69	9.59	55.79	-27.51	Average	neutral	
2	0.15	44.28	34.69	9.59	65.79	-21.51	QP	neutral	
3	0.53	34.05	24.45	9.60	46.00	-11.55	Average	neutral	
4	0.53	41.41	31.81	9.60	56.00	-14.59	QP	neutral	
5	2.40	21.26	11.62	9.64	46.00	-24.74	Average	neutral	
6	2.40	26.35	16.71	9.64	56.00	-29.65	QP	neutral	
7	4.74	10.61	0.99	9.68	46.00	-35.39	Average	neutral	
8	4.74	15.24	6.56	9.68	56.00	-39.76	QP	neutral	
9	13.58	11.38	1.61	9.77	50.00	-38.62	Average	neutral	
10	13.58	16.98	7.21	9.77	60.00	-43.02	QP	neutral	
11	18.32	19.30	9.50	9.80	50.00	-30.70	Average	neutral	
12	18.32	25.44	15.64	9.80	60.00	-34.56	QP	neutral	



TUV Rheinland Taiwan Ltd.
No. 458-18, Sec. 2, Fenhiao, Linkou Dist., New Taipei City 244, Taiwan (R.O.C.)
Tel: +886-2112-1000 Fax: +886-2112-1322

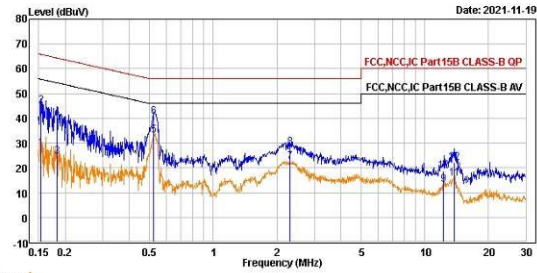

Trace: 1

Line	Freq	Level	Read Level	Factor	Limit	Over	Remark	Pol/Phase	Note
	MHz	dBuV	dBuV	dB	dBuV	dB			
1	0.15	27.98	18.37	9.61	55.79	-27.81	Average	line1	
2	0.15	44.92	35.31	9.61	65.79	-20.87	QP	line1	
3	0.18	24.54	14.93	9.61	54.59	-29.85	Average	line1	
4	0.18	40.28	30.67	9.61	64.39	-24.11	QP	line1	
5	0.52	33.02	23.40	9.62	46.00	-12.98	Average	line1	
6	0.52	40.50	30.88	9.62	56.00	-15.50	QP	line1	
7	2.31	22.56	12.91	9.65	46.00	-23.44	Average	line1	
8	2.31	28.26	18.61	9.65	56.00	-27.74	QP	line1	
9	12.17	13.29	3.56	9.73	50.00	-36.71	Average	line1	
10	12.17	18.91	9.18	9.73	60.00	-41.09	QP	line1	
11	13.72	15.59	5.86	9.73	50.00	-34.41	Average	line1	
12	13.72	22.17	12.44	9.73	60.00	-37.83	QP	line1	