



Test Report No.: RF2311WDG0023-3



TEST REPORT

Applicant:	Voyetra Turtle Beach, Inc.
Address:	44 South Broadway, 4th Floor WHITE PLAINS, NEW YORK 10601 USA

Manufacturer or Supplier	Voyetra Turtle Beach, Inc.
Address	44 South Broadway, 4th Floor WHITE PLAINS, NEW YORK 10601 USA
Product:	VelocityOne RACE
Brand Name:	TURTLE BEACH
Model:	VelocityOne RACE
Additional Model & Model Difference	N/A
Date of tests:	Nov. 07, 2023 ~ Dec. 25, 2023

the tests have been carried out according to the requirements of the following standard:

FCC Part 15, Subpart C, Section 15.249

CONCLUSION: The submitted sample was found to COMPLY with the test requirement

Tested by Loren Luo
Project Engineer / EMC Department

Approved by Glyn He
Assistant Manager / EMC Department

Date: Jan. 15, 2024

This report is governed by, and incorporates by reference, the Conditions of Testing as posted at the date of issuance of this report at <http://www.bureauveritas.com/home/about-us/our-business/cps/about-us/terms-conditions/> and is intended for your exclusive use. Any copying or replication of this report to or for any other person or entity, or use of our name or trademark, is permitted only with our prior written permission. This report sets forth our findings solely with respect to the test samples identified herein. The results set forth in this report are not indicative or representative of the quality or characteristics of the lot from which a test sample was taken or any similar or identical product unless specifically and expressly noted. Our report includes all of the tests requested by you and the results thereof based upon the information that you provided to us. Measurement uncertainty is only provided upon request for accredited tests. Statements of conformity are based on simple acceptance criteria without taking measurement uncertainty into account, unless otherwise requested in writing. You have 60 days from date of issuance of this report to notify us of any material error or omission caused by our negligence or if you require measurement uncertainty; provided, however, that such notice shall be in writing and shall specifically address the issue you wish to raise. A failure to raise such issue within the prescribed time shall constitute your unqualified acceptance of the completeness of this report, the tests conducted and the correctness of the report contents.

TABLE OF CONTENTS

RELEASE CONTROL RECORD	4
1 SUMMARY OF TEST RESULTS.....	5
2 MEASUREMENT UNCERTAINTY	5
3 GENERAL INFORMATION	6
3.1 GENERAL DESCRIPTION OF EUT	6
3.2 DESCRIPTION OF TEST MODES	7
3.3 GENERAL DESCRIPTION OF APPLIED STANDARDS	8
3.4 DESCRIPTION OF SUPPORT UNITS	8
3.5 CONFIGURATION OF SYSTEM UNDER TEST	8
3.6 DUTY CYCLE OF TESET SIGNAL.....	8
4. TEST TYPES AND RESULTS.....	10
4.1 CONDUCTED EMISSION MEASUREMENT	10
4.1.1 LIMITS OF CONDUCTED EMISSION MEASUREMENT	10
4.1.2 TEST INSTRUMENTS.....	10
4.1.3 TEST PROCEDURES	11
4.1.4 DEVIATION FROM TEST STANDARD	11
4.1.5 TEST SETUP.....	12
4.1.6 EUT OPERATING CONDITIONS	12
4.1.7 TEST RESULTS	13
4.2 RADIATED EMISSION MEASUREMENT	15
4.2.1 LIMITS OF RADIATED EMISSION MEASUREMENT	15
4.2.2 TEST INSTRUMENTS.....	16
4.2.3 TEST PROCEDURES	17
4.2.4 DEVIATION FROM TEST STANDARD	17
4.2.5 TEST SETUP.....	18
4.2.6 EUT OPERATING CONDITIONS	19
4.2.7 TEST RESULTS	20
4.3 20DB BANDWIDTH MEASUREMENT	27
4.3.1 LIMITS OF 20DB BANDWIDTH MEASUREMENT	27
4.3.2 TEST INSTRUMENTS.....	27
4.3.3 TEST PROCEDURE.....	27
4.3.4 DEVIATION FROM TEST STANDARD	28
4.3.5 TEST SETUP.....	28



**BUREAU
VERITAS**

Test Report No.: RF2311WDG0023-3

4.3.6	EUT OPERATING CONDITIONS	28
4.3.7	TEST RESULTS	29
5.	PHOTOGRAPHS OF THE TEST CONFIGURATION	31
6.	APPENDIX A - MODIFICATIONS RECORDERS FOR ENGINEERING CHANGES TO THE EUT BY THE LAB	32



Test Report No.: RF2311WDG0023-3

RELEASE CONTROL RECORD

ISSUE NO.	REASON FOR CHANGE	DATE ISSUED
RF2311WDG0023-3	Original release	Jan. 15, 2024

1 SUMMARY OF TEST RESULTS

The EUT has been tested according to the following specifications:

APPLIED STANDARD: FCC PART 15, SUBPART C (SECTION 15.249)			
STANDARD SECTION	TEST TYPE AND LIMIT	RESULT	REMARK
§15.203	Antenna Requirement	PASS	No antenna connector is used
§15.207 (a)	Conducted Emission	PASS	Compliant
§15.205	Restricted Band of Operation	PASS	Compliant
§15.209 §15.249(a)	Radiated Emission	PASS	Compliant
§15.215(c)	20dB Bandwidth Test	PASS	Compliant

2 MEASUREMENT UNCERTAINTY

Where relevant, the following measurement uncertainty levels have been estimated for tests performed on the EUT as specified in CISPR 16-4-2:

MEASUREMENT	FREQUENCY	UNCERTAINTY
Conducted emissions	0.15MHz ~ 30MHz	3.09dB
Radiated emissions	9KHz ~ 30MHz	2.72dB
	30MHz ~ 1GMHz	4.24dB
	1GHz ~ 18GHz	4.10dB
	18GHz ~ 40GHz	4.10dB

This uncertainty represents an expanded uncertainty expressed at approximately the 95% confidence level using a coverage factor of $k = 2$.

3 GENERAL INFORMATION

3.1 GENERAL DESCRIPTION OF EUT

PRODUCT	VelocityOne RACE
MODEL NO.	VelocityOne RACE
ADDITIONAL MODEL	N/A
FCC ID	XGB-231028WH
NOMINAL VOLTAGE	DC 24V from adapter
MODULATION TECHNOLOGY	GFSK
OPERATING FREQUENCY	2402MHz ~ 2480MHz
ANTENNA TYPE	PCB Antenna, with 1.26dBi gain
I/O PORTS	Refer to user's manual
CABLE SUPPLIED	Refer to notes 4

NOTES:

- For a more detailed features description, please refer to the manufacturer's specifications or the user's manual.
- For the test results, the EUT had been tested with all conditions, but only the worst case was shown in test report.
- Please refer to the EUT photo document (Reference No.: 2311WDG0023-2) for detailed product photo.
- The EUT can be powered by adapter as list as attach:

ADAPTER&CABLE:	
BRAND:	N/A
MODEL:	C120A2400500PI
INPUT:	AC 100-240V 50/60HZ 2.0A MAX
OUTPUT:	DC 24V 5A 120W
AC LINE:	UNSHIELDED, DETACHABLE 1.2M
DC LINE:	UNSHIELDED, NON-DETACHABLE 1.2M
USB_C 1# LINE:	SHIELDED, DETACHABLE 2.5M
USB_C 2# LINE:	SHIELDED, DETACHABLE 0.2M
USB_A LINE:	SHIELDED, DETACHABLE 2.5M

3.2 DESCRIPTION OF TEST MODES

Pre-Scan has been conducted to determine the worst-case mode from all possible combinations between available modulations, data rates, XYZ axis and packet type. The worst case was found when the EUT was positioned on X axis for radiated emission. The EUT was tested under the following mode.

EUT CONFIGURE MODE	APPLICABLE TO				DESCRIPTION
	RE<1G	RE≥1G	PLC	BW	
A	√	√	√	√	DC 24V from adapter

Where **RE<1G**: Radiated Emission below 1GHz **RE≥1G**: Radiated Emission above 1GHz
PLC: Power Line Conducted Emission **BW**: 20db bandwidth

Following channel(s) was (were) selected for the test as listed below.

TESTED CHANNEL	TESTED FREQUENCY
Low	2402 MHz
Middle	2440 MHz
High	2480 MHz

Channel List

CHANNEL	FREQ. (MHZ)	CHANNEL	FREQ. (MHZ)	CHANNEL	FREQ. (MHZ)	CHANNEL	FREQ. (MHZ)
0	2402	10	2422	20	2442	30	2462
1	2404	11	2424	21	2444	31	2464
2	2406	12	2426	22	2446	32	2466
3	2408	13	2428	23	2448	33	2468
4	2410	14	2430	24	2450	34	2470
5	2412	15	2432	25	2452	35	2472
6	2414	16	2434	26	2454	36	2474
7	2416	17	2436	27	2456	37	2476
8	2418	18	2438	28	2458	38	2478
9	2420	19	2440	29	2460	39	2480

Note: The more detailed channel, please refer to the product specifications

TEST CONDITION:

APPLICABLE TO	ENVIRONMENTAL CONDITIONS	INPUT POWER	TESTED BY
RE	25deg. C, 55%RH	DC 24V from adapter	Ryker
BW	25deg. C, 56%RH	DC 24V from adapter	Ryker
PLC	25deg. C, 56%RH	DC 24V from adapter	Bob

3.3 GENERAL DESCRIPTION OF APPLIED STANDARDS

The EUT is a RF Product. According to the specifications of the manufacturer, it must comply with the requirements of the following standards:

FCC Part 15, Subpart C, Section 15.249

ANSI C63.10-2013

All test items have been performed and recorded as per the above standards.

3.4 DESCRIPTION OF SUPPORT UNITS

The EUT has been tested as an independent unit together with other necessary accessories or support units. The following support units or accessories were used to form a representative test configuration during the tests.

NO.	PRODUCT	BRAND	MODEL NO.	SERIAL NO.	FCC ID
1	Notebook	DELL	Latitude 5420	127710614	N/A
2	Notebook	DELL	Latitude 3420	127764357/7	N/A
3	Earphone	N/A	EMC-1#	N/A	N/A
4	Earphone	N/A	EMC-2#	N/A	N/A

NO.	SIGNAL CABLE DESCRIPTION OF THE ABOVE SUPPORT UNITS
1	AC Line: Unshielded, Detachable 1.0m; DC Line: Unshielded, Detachable 2.0m.
2	AC Line: Unshielded, Detachable 0.8m; DC Line: Shielded, Detachable 1.8m.
3-4	Earphone Line: Unshielded, Detachable 1.2m.

3.5 CONFIGURATION OF SYSTEM UNDER TEST

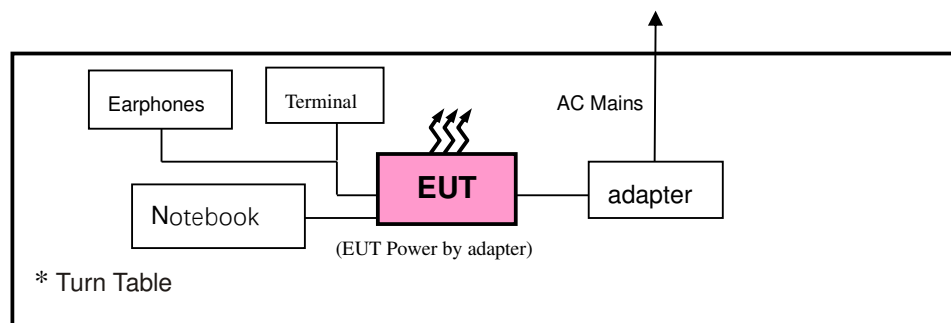

3.6 DUTY CYCLE OF TESET SIGNAL

$$T_p = 1.17572 \text{ ms}$$

$$T_{on} = 398.55 / 1000 = 0.39855 \text{ ms}$$

$$\text{Duty Cycle} = T_{on} / T_p * 100\% = 0.39855 / 1.17572 * 100\% \approx 33.9\%$$

$$AV \text{ factor} = 20 \log (\text{Duty cycle}) = 20 \log (33.9\%) \approx -9.39 \text{ dB}$$

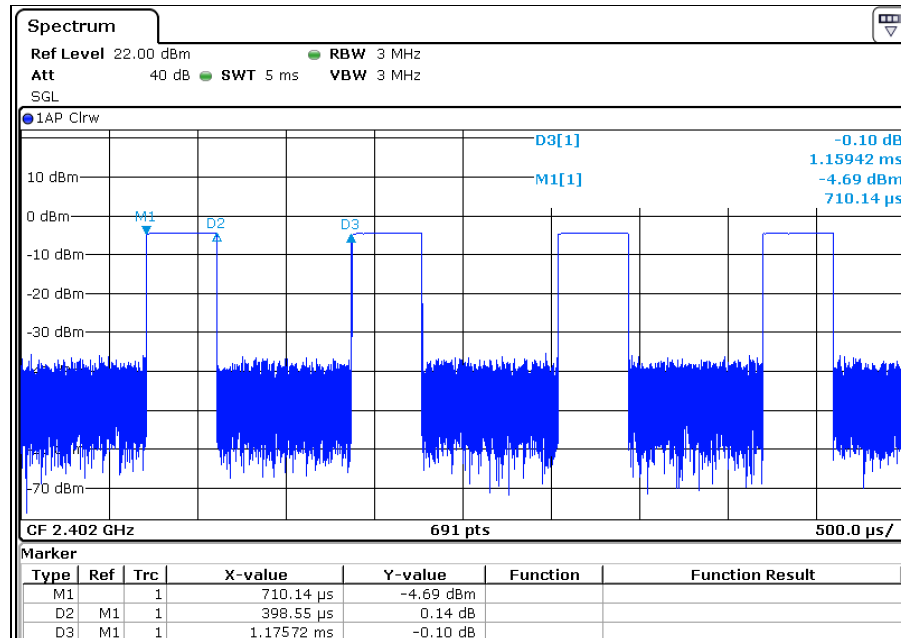

4. TEST TYPES AND RESULTS

4.1 CONDUCTED EMISSION MEASUREMENT

4.1.1 LIMITS OF CONDUCTED EMISSION MEASUREMENT

FREQUENCY OF EMISSION (MHz)	CONDUCTED LIMIT (dB μ V)	
	Quasi-peak	Average
0.15 ~ 0.5	66 to 56	56 to 46
0.5 ~ 5	56	46
5 ~ 30	60	50

- NOTE:**
1. The lower limit shall apply at the transition frequencies.
 2. The limit decreases in line with the logarithm of the frequency in the range of 0.15 to 0.50MHz.
 3. All emanations from a class A/B digital device or system, including any network of conductors and apparatus connected thereto, shall not exceed the level of field strengths specified above.

4.1.2 TEST INSTRUMENTS

Equipment	Manufacturer	Model No.	Serial No.	Next Cal.
EMI Test Receiver	Rohde&Schwarz	ESCI	100666	Apr. 06, 24
Artificial Mains Network	Rohde&Schwarz	ENV216	102477	Apr. 06, 24
Artificial Mains Network	SCHWARZBECK	NSLK 8127	8127713	Apr. 02, 24
Voltage Probe	SCHWARZBECK	TK 9421	9421-0332	Apr. 05, 24
Current Probe	Rohde&Schwarz	EZ-17	0816.2063.02	Apr. 02, 24
ISN	Rohde&Schwarz	ENY81-CA6	101928	Apr. 06, 24
ISN	TESEQ	ISN T800	34373	Jan. 11, 24
Coaxial RF Cable	COMMATE	CFD300-NL	5D-001	Oct. 16, 24
Shielding Room	Burgeon	5m*4m*3m	D3040008DG-1	Jul 22, 24
Test software	ADT	ADT_Cond_V7.3.7	N/A	N/A

- NOTE:**
1. The test was performed in shielded room 543.
 2. The calibration interval of the above test equipment (except shielded room and chamber) is 12 months. And the calibrations are traceable to CEPREI/CHINA, GRGT/CHINA and NIM/CHINA.
 3. Test site: No. 122, Houjie Avenue West Houjie Town, Dongguan City Guangdong Province, 523960, People's Republic of China.

4.1.3 TEST PROCEDURES

- a. The EUT was placed 0.4 meters from the conducting wall of the shielded room with EUT being connected to the power mains through a line impedance stabilization network (LISN). Other support units were connected to the power mains through another LISN. The two LISNs provide 50 ohm/ 50uH of coupling impedance for the measuring instrument.
- b. Both lines of the power mains connected to the EUT were checked for maximum conducted interference.
- c. The frequency range from 150kHz to 30MHz was searched. Emission levels under (Limit - 20dB) was not recorded.

NOTE: All modes of operation were investigated and the worst-case emissions are reported.

4.1.4 DEVIATION FROM TEST STANDARD

No deviation.

4.1.5 TEST SETUP

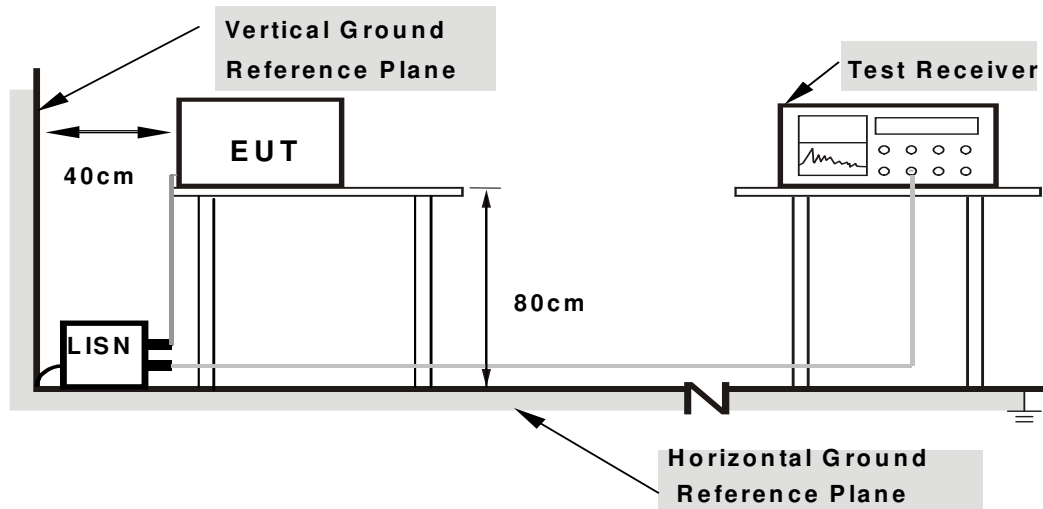

- Note: 1.Support units were connected to second LISN.
2.Both of LISNs (AMN) are 80 cm from EUT and at least 80
from other units and other metal planes**

For the actual test configuration, please refer to the attached file (Test Setup Photo).

4.1.6 EUT OPERATING CONDITIONS

- a. Turned on the power and connected of all equipment.
- b. EUT was operated according to the type used was description in manufacturer's specifications or the User's Manual.

4.1.7 TEST RESULTS

CONDUCTED WORST-CASE DATA: 2.4G Link CH39

PHASE	Line	6dB BANDWIDTH	9kHz
--------------	------	----------------------	------

No.	Freq. [MHz]	Corr. Factor (dB)	Reading Value		Emission Level		Limit		Margin	
			[dB (uV)]		[dB (uV)]		[dB (uV)]		(dB)	
			Q.P.	AV.	Q.P.	AV.	Q.P.	AV.	Q.P.	AV.
1	0.20600	9.61	31.57	19.44	41.18	29.05	63.37	53.37	-22.18	-24.31
2	0.24164	9.63	33.79	22.67	43.42	32.30	62.04	52.04	-18.61	-19.73
3	0.28200	9.64	32.69	19.75	42.33	29.39	60.76	50.76	-18.43	-21.37
4	1.27396	9.66	23.47	11.94	33.13	21.60	56.00	46.00	-22.87	-24.40
5	3.79000	9.71	17.20	6.89	26.91	16.60	56.00	46.00	-29.09	-29.40
6	28.29000	9.95	22.66	7.52	32.61	17.47	60.00	50.00	-27.39	-32.53

REMARKS: The emission levels of other frequencies were very low against the limit.

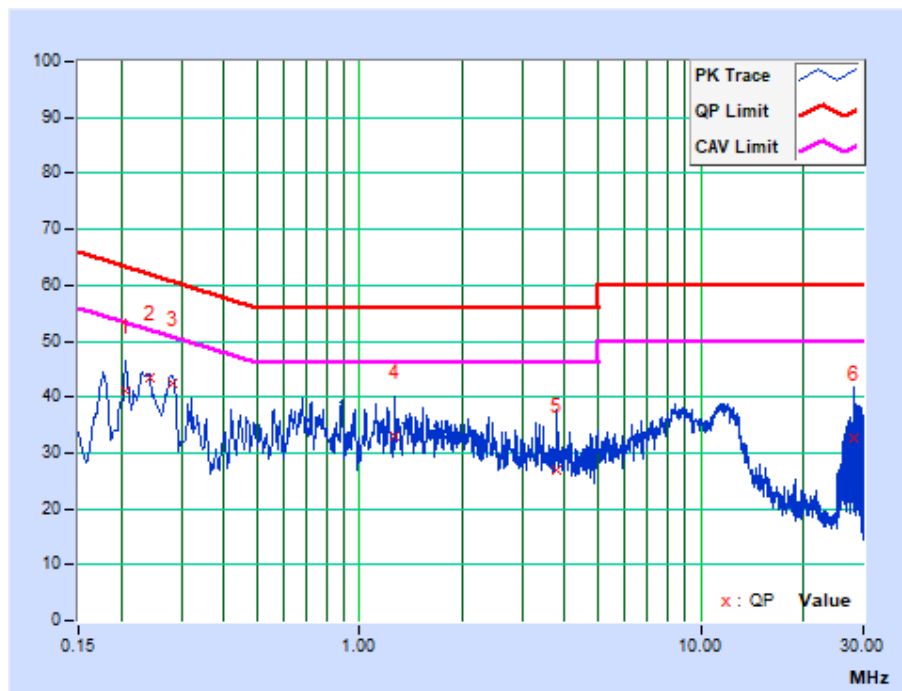

PHASE	Neutral	6dB BANDWIDTH	9kHz
--------------	---------	----------------------	------

No.	Freq. [MHz]	Corr. Factor (dB)	Reading Value		Emission Level		Limit		Margin	
			[dB (uV)]		[dB (uV)]		[dB (uV)]		(dB)	
			Q.P.	AV.	Q.P.	AV.	Q.P.	AV.	Q.P.	AV.
1	0.24228	9.61	32.88	21.60	42.49	31.21	62.02	52.02	-19.53	-20.81
2	0.28600	9.62	31.91	19.02	41.53	28.64	60.64	50.64	-19.11	-22.00
3	0.72200	9.63	24.58	12.39	34.21	22.02	56.00	46.00	-21.79	-23.98
4	1.07000	9.65	22.56	11.19	32.21	20.84	56.00	46.00	-23.79	-25.16
5	8.58200	9.88	27.96	27.61	37.84	37.49	60.00	50.00	-22.16	-12.51
6	12.07800	9.95	28.39	27.22	38.34	37.17	60.00	50.00	-21.66	-12.83

REMARKS: The emission levels of other frequencies were very low against the limit.

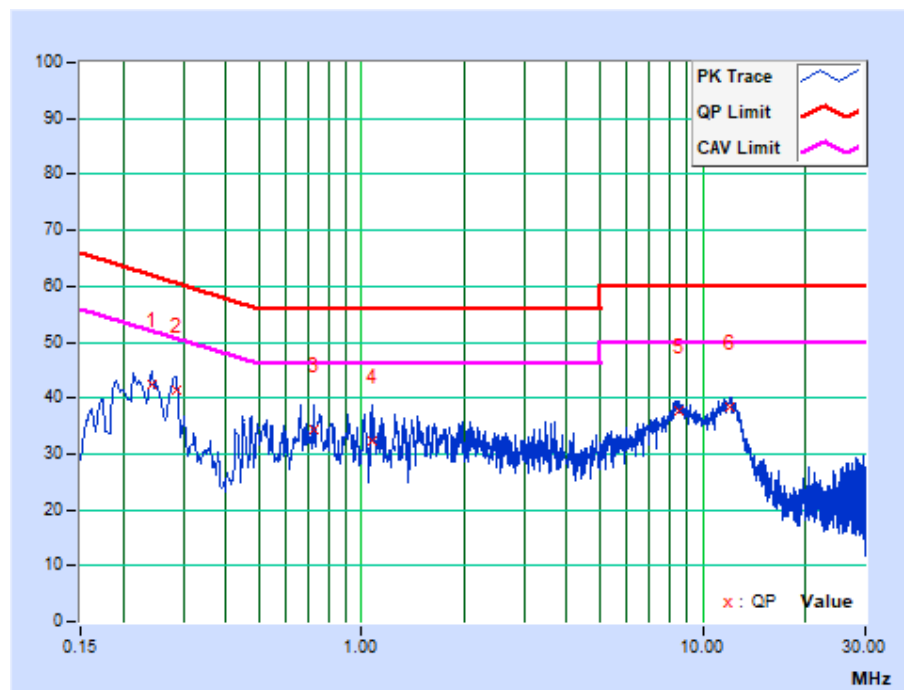

4.2 RADIATED EMISSION MEASUREMENT

4.2.1 LIMITS OF RADIATED EMISSION MEASUREMENT

Emissions radiated outside of the specified bands, shall be according to the general radiated limits in 15.209 as following:

FREQUENCIES (MHz)	FIELD STRENGTH (microvolts/meter)	MEASUREMENT DISTANCE (meters)
0.009 ~ 0.490	2400/F(kHz)	300
0.490 ~ 1.705	24000/F(kHz)	30
1.705 ~ 30.0	30	30
30 ~ 88	100	3
88 ~ 216	150	3
216 ~ 960	200	3
Above 960	500	3

According to §15.249(a), the field strength of emissions from intentional radiators operated within these frequency bands shall comply with the following:

Fundamental Frequency	Field strength of fundamental (milli-volts/meter)	Field strength of harmonics (micro-volts/meter)
902-928 MHz	50	500
2400-2483.5 MHz	50	500
5725-5875 MHz	50	500
24.0-24.25 GHz	250	2500

The emission limit in this paragraph is based on measurement instrumentation employing an average detector. The provisions in §15.35 for limiting peak emissions apply.

NOTES:

1. The lower limit shall apply at the transition frequencies.
2. Emission level (dBuV/m) = 20 log Emission level (uV/m).
3. As shown in 15.35(b), for frequencies above 1000MHz, the field strength limits are based on average detector, however, the peak field strength of any emission shall not exceed the maximum permitted average limits, specified above by more than 20dB under any condition of modulation.



4.2.2 TEST INSTRUMENTS

Equipment	Manufacturer	Model No.	Serial No.	Next Cal.
Spectrum Analyzer	Rohde&Schwarz	FSV3044	101326	July 13, 24
EMI Test Receiver	Rohde&Schwarz	ESU8	100372	Apr. 06, 24
Bilog Antenna	SCHWARZBECK	VULB 9168	9168-555	Jan. 08, 24
Pre-Amplifier	Agilent	8447D	2944A10488	July. 26, 24
3m Semi-anechoic Chamber	ETS-Lindgren	9m*6m*6m	D3040003DG-1	July 30, 24
Coaxial RF Cable	Joinfront	JFAA6-NMNM-8000	2100033742	July 10, 24
Coaxial RF Cable	Joinfront	JFAR-NMBNCM-2000	2100033742	July 10, 24
Coaxial RF Cable	Joinfront	JFAR-BNCMSMM-500	2100033742	July 10, 24
Test software	ADT	ADT_Radiated_V7.6.15.9.2	N/A	N/A
Horn Antenna	ETS-Lindgren	3117	00240041	May 06, 24
Horn Antenna	SCHWARZBECK	BBHA 9170	01024	Oct. 16, 25
Pre-Amplifier (1GHz-18GHz)	Rohde&Schwarz	SCU18	102265	Apr. 01, 24
Pre-Amplifier (18GHz-40GHz)	Rohde&Schwarz	SCU40	100437	Oct. 10, 24
Coaxial RF Cable	Joinfront	JFAA6-NMNM-8000	2100033742	July 10, 24
Coaxial RF Cable	Joinfront	JFAA6-NMSMM-2000	2100033742	July 10, 24
Coaxial RF Cable	Joinfront	JFAA6-NMSMM-800	2100033742	July 10, 24

NOTES:

1. The test was performed in 966 Chamber-3.
2. The calibration interval of the above test instruments are 12 /24months and the calibrations are traceable to CEPREI/CHINA, GRGT/CHINA and NIM/CHINA.
3. The horn antenna is used only for the measurement of emission frequency above1 GHz if tested.
4. The FCC Site Registration No. is 749762.
5. Test site: No. 122, Houjie Avenue West Houjie Town, Dongguan City Guangdong Province, 523960, People's Republic of China.

4.2.3 TEST PROCEDURES

- a. The EUT was placed on the top of a rotating table 1.5 meters (above 1GHz) and 0.8 meters (below 1GHz) above the ground at a 3 meters semi-anechoic chamber. The table was rotated 360 degrees to determine the position of the highest radiation.
- b. The EUT was set 3 meters away from the interference-receiving antenna, which was mounted on the top of a variable-height antenna tower.
- c. The antenna is a broadband antenna, and its height is varied from one meter to four meters above the ground to determine the maximum value of the field strength. Both horizontal and vertical polarizations of the antenna are set to make the measurement.
- d. For each suspected emission, the EUT was arranged to its worst case and then the antenna was tuned to heights from 1 meter to 4 meters and the rotatable table was turned from 0 degrees to 360 degrees to find the maximum reading.
- e. The test-receiver system was set to Peak Detect Function and Specified Bandwidth with Maximum Hold Mode.
- f. For below 30MHz, a loop antenna with its vertical plane is place 3m from the EUT and rotated about its vertical axis for maximum response at each azimuth about the EUT. And the centre of the loop shall be 1.3m above the ground.
- g. If the emission level of the EUT in peak mode was lower than the limit specified, then testing could be stopped and the peak values of the EUT would be reported. Otherwise the emissions would be re-tested one by one using peak, quasi-peak or average method as specified and then reported in a data sheet.

NOTES:

1. The resolution bandwidth and video bandwidth of test receiver/spectrum analyzer is 120kHz for Quasi-peak detection at frequency below 1GHz.
2. The resolution bandwidth of test receiver/spectrum analyzer is 1MHz and video bandwidth is 3MHz for Peak detection at frequency above 1GHz.
3. Average value =PK Emission +AV Factor.
4. All modes of operation were investigated and the worst-case emissions are reported.
5. The testing of the EUT was performed on all 3 orthogonal axes; the worst-case test configuration was reported on the file test setup photo.

4.2.4 DEVIATION FROM TEST STANDARD

No deviation.

4.2.5 TEST SETUP

Below 30MHz test setup

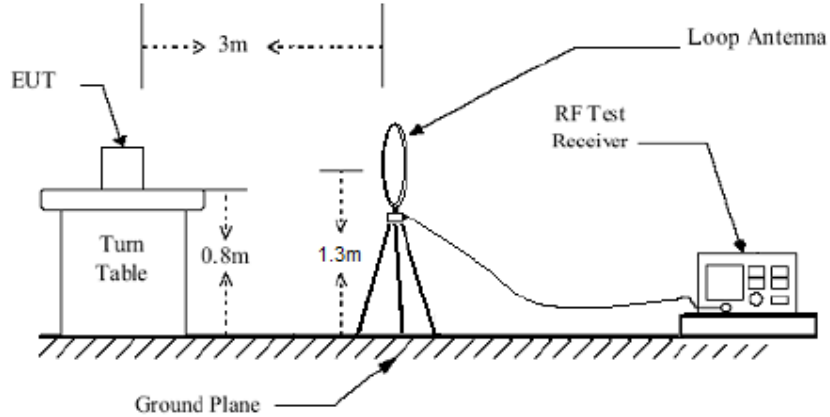

Below 1GHz test setup

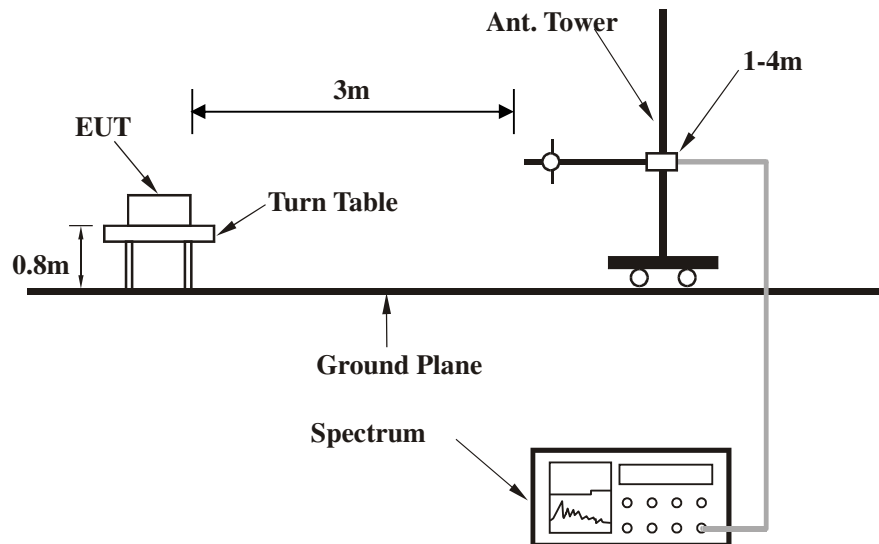

Above 1GHz test setup

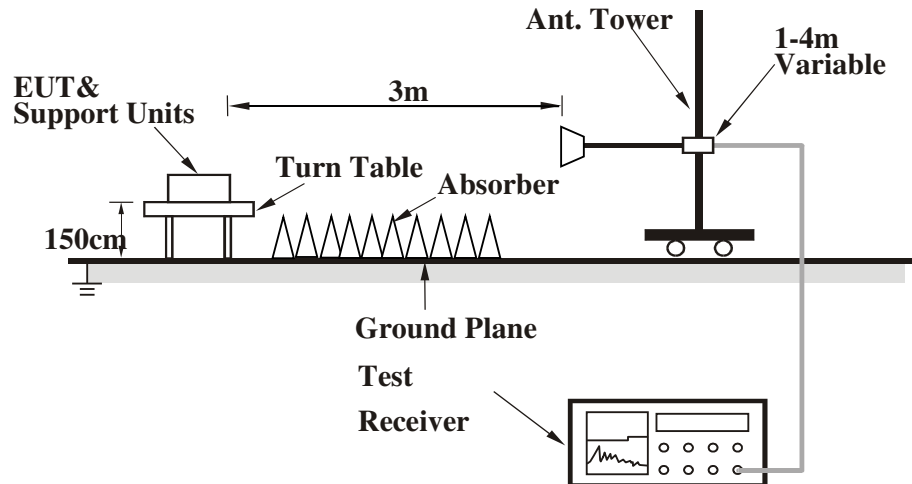

Note: For the actual test configuration, please refer to the attached file (Test Setup Photo).

4.2.6 EUT OPERATING CONDITIONS

- c) Turned on the power of all equipment.
- d) EUT was operated according to the type used was description in manufacturer's specifications or the User's Manual.

4.2.7 TEST RESULTS

BELOW 1GHz WORST-CASE DATA

CHANNEL	TX Middle Channel	DETECTOR FUNCTION	Quasi-Peak (QP)
FREQUENCY RANGE	9KHz ~ 1GHz		

ANTENNA POLARITY & TEST DISTANCE: HORIZONTAL AT 3 M								
NO.	FREQ. (MHz)	EMISSION LEVEL (dBuV/m)	LIMIT (dBuV/m)	MARGIN (dB)	ANTENNA HEIGHT (m)	TABLE ANGLE (Degree)	RAW VALUE (dBuV)	CORRECTION FACTOR (dB/m)
1	130.98	27.57 QP	43.50	-15.93	2.40 H	114	37.62	-10.05
2	244.58	25.77 QP	46.00	-20.23	3.15 H	214	34.98	-9.21
3	282.45	29.31 QP	46.00	-16.69	1.11H	104	37.10	-7.79
4	308.67	27.84 QP	46.00	-18.16	2.54 H	22	35.11	-7.27
5	625.21	27.86 QP	46.00	-18.14	3.25H	282	29.23	-1.37
6	672.78	29.48 QP	46.00	-16.52	1.25 H	301	30.04	-0.56

REMARKS:

1. Emission level (dBuV/m) = Raw Value (dBuV) + Correction Factor (dB/m).
2. Correction Factor (dB/m) = Antenna Factor (dB/m) + Cable Factor (dB).
3. The emission levels of other frequencies were greater than 20dB margin.
4. 9KHz~30MHz have been test and test data more than 20dB margin.
5. Margin value = Emission level – Limit value.

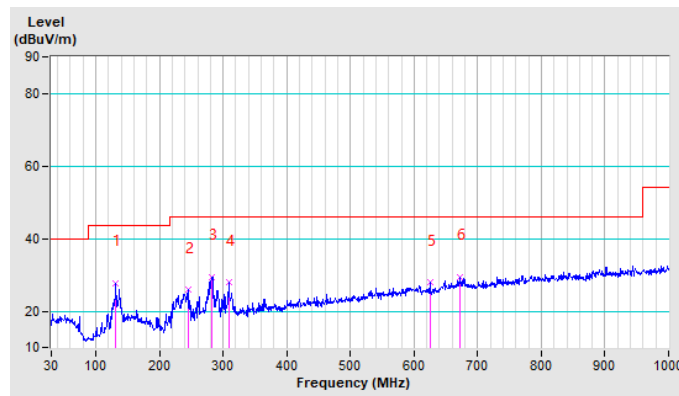

CHANNEL	TX Middle Channel	DETECTOR FUNCTION	Quasi-Peak (QP)
FREQUENCY RANGE	9KHz ~ 1GHz		

ANTENNA POLARITY & TEST DISTANCE: VERTICAL AT 3 M								
NO.	FREQ. (MHz)	EMISSION LEVEL (dBuV/m)	LIMIT (dBuV/m)	MARGIN (dB)	ANTENNA HEIGHT (m)	TABLE ANGLE (Degree)	RAW VALUE (dBuV)	CORRECTION FACTOR (dB/m)
1	31.94	26.48 QP	40.00	-13.52	2.25 V	343	36.58	-10.10
2	67.87	33.46 QP	40.00	-6.54	2.22 V	284	44.14	-10.68
3	135.84	28.32 QP	43.50	-15.18	2.78 V	42	37.75	-9.43
4	239.73	23.13 QP	46.00	-22.87	1.14V	264	32.54	-9.41
5	256.24	28.11 QP	46.00	-17.89	1.55 V	153	36.89	-8.78
6	298.96	25.77 QP	46.00	-20.23	3.18 V	242	33.36	-7.59

REMARKS:

1. Emission level (dBuV/m) = Raw Value (dBuV) + Correction Factor (dB/m).
2. Correction Factor (dB/m) = Antenna Factor (dB/m) + Cable Factor (dB).
3. The emission levels of other frequencies were greater than 20dB margin.
4. 9KHz~30MHz have been test and test data more than 20dB margin.
5. Margin value = Emission level – Limit value.

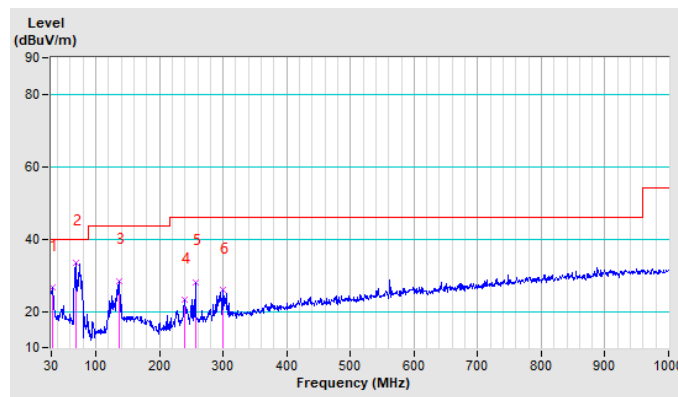

ABOVE 1GHz WORST-CASE DATA:

CHANNEL	TX Low Channel	DETECTOR FUNCTION	Peak (PK)
FREQUENCY RANGE	1GHz ~ 25GHz		Average (AV)

ANTENNA POLARITY & TEST DISTANCE : HORIZONTAL AT 3 M

NO.	FREQ. (MHz)	EMISSION LEVEL (dBuV/m)	LIMIT (dBuV/m)	MARGIN (dB)	ANTENNA HEIGHT (m)	TABLE ANGLE (Degree)	RAW VALUE (dBuV)	CORRECTION FACTOR (dB/m)
1	2400.00	49.04 PK	74.00	-24.96	1.00 H	180	52.26	-3.22
2	2400.00	39.65 AV	54.00	-14.35	1.00 H	180	42.87	-3.22
3	*2402.00	72.64 PK	114.00	-41.36	1.00 H	180	75.86	-3.22
4	*2402.00	63.25 AV	94.00	-30.75	1.00 H	180	66.47	-3.22
5	4804.00	48.58 PK	74.00	-25.42	1.20 H	130	50.80	-2.22
6	4804.00	39.19 AV	54.00	-14.81	1.20 H	130	41.41	-2.22
7	7206.00	53.80 PK	74.00	-20.20	1.20 H	155	52.43	1.37
8	7206.00	44.41 AV	54.00	-9.59	1.20 H	155	43.04	1.37

ANTENNA POLARITY & TEST DISTANCE : VERTICAL AT 3 M

NO.	FREQ. (MHz)	EMISSION LEVEL (dBuV/m)	LIMIT (dBuV/m)	MARGIN (dB)	ANTENNA HEIGHT (m)	TABLE ANGLE (Degree)	RAW VALUE (dBuV)	CORRECTION FACTOR (dB/m)
1	2400.00	47.03 PK	74.00	-26.97	1.30 V	190	50.25	-3.22
2	2400.00	37.64 AV	54.00	-16.36	1.30 V	190	40.86	-3.22
3	*2402.00	71.23 PK	114.00	-42.77	1.30 V	190	74.45	-3.22
4	*2402.00	61.84 AV	94.00	-32.16	1.30 V	190	65.06	-3.22
5	4804.00	50.92 PK	74.00	-23.08	2.00 V	150	53.14	-2.22
6	4804.00	41.53 AV	54.00	-12.47	2.00 V	150	43.75	-2.22
7	7203.00	55.20 PK	74.00	-18.80	2.00 V	269	53.81	1.39
8	7203.00	45.81 AV	54.00	-8.19	2.00 V	269	44.42	1.39

REMARK:

1. Emission level (dBuV/m) = Raw Value (dBuV) + Correction Factor (dB/m).
2. Correction Factor (dB/m) = Antenna Factor (dB/m) + Cable Factor (dB).
3. The emission levels of other frequencies were greater than 20dB margin.
4. Margin value = Emission level – Limit value.
5. " * " : Fundamental frequency.
6. Average value = PK Emission + 20*log(duty cycle) Where the duty factor is calculated from following formula: 20 log (Duty cycle) = 20Log(33.9%) ≈ -9.39dB, Please see page 9 for plotted duty.

Band edge Plot

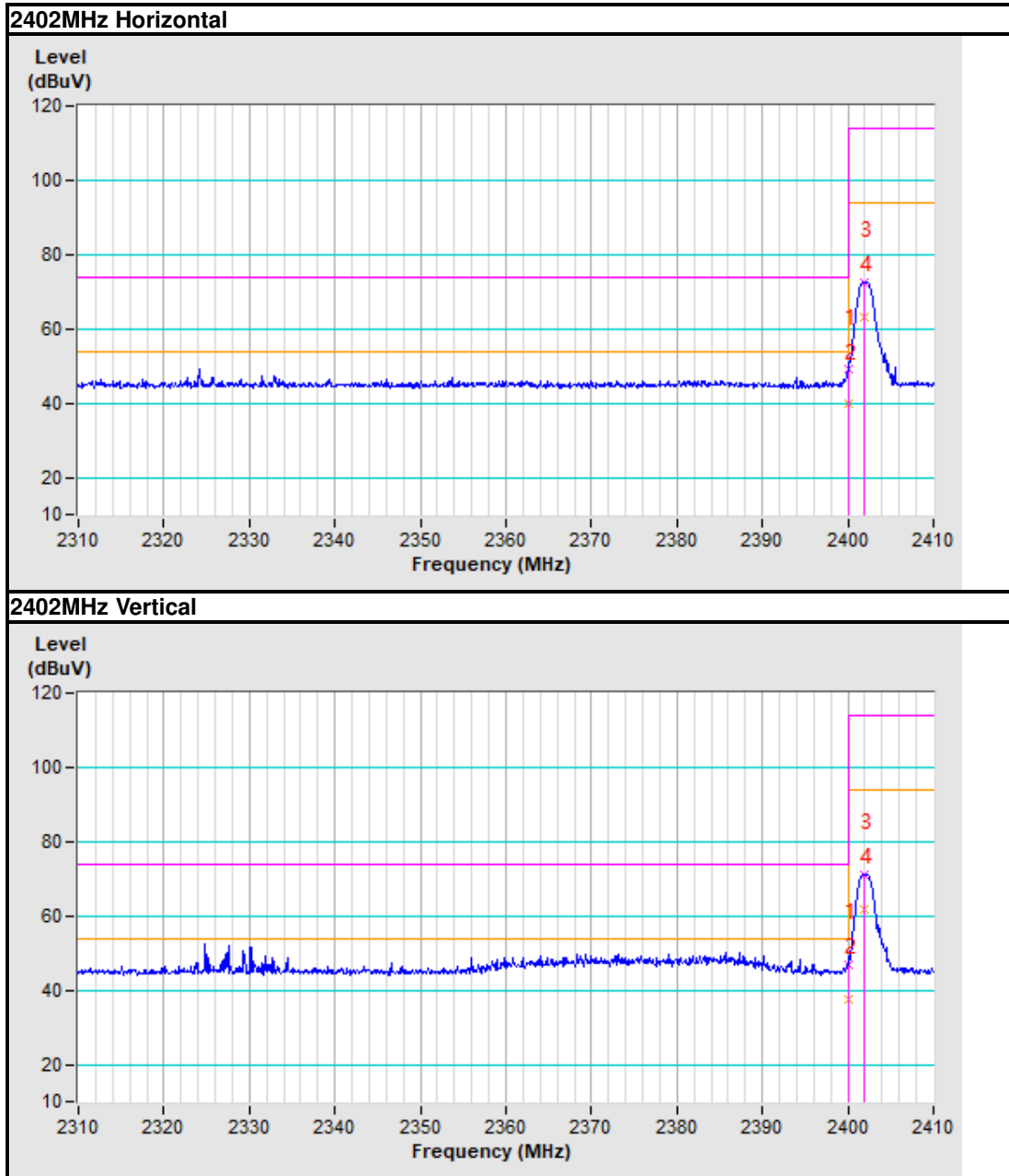

CHANNEL	TX Middle Channel	DETECTOR FUNCTION	Peak (PK)
FREQUENCY RANGE	1GHz ~ 25GHz		Average (AV)

ANTENNA POLARITY & TEST DISTANCE : HORIZONTAL AT 3 M

NO.	FREQ. (MHz)	EMISSION LEVEL (dBuV/m)	LIMIT (dBuV/m)	MARGIN (dB)	ANTENNA HEIGHT (m)	TABLE ANGLE (Degree)	RAW VALUE (dBuV)	CORRECTION FACTOR (dB/m)
1	*2440.00	71.79 PK	114.00	-42.21	1.55 H	188	74.91	-3.12
2	*2440.00	62.40 AV	94.00	-31.60	1.55 H	188	65.52	-3.12
3	4880.00	48.82 PK	74.00	-25.18	1.00 H	125	51.01	-2.19
4	4880.00	39.43 AV	54.00	-14.57	1.00 H	125	41.62	-2.19
5	7320.00	51.66 PK	74.00	-22.34	1.00 H	175	50.80	0.86
6	7320.00	42.27 AV	54.00	-11.73	1.00 H	175	41.41	0.86

ANTENNA POLARITY & TEST DISTANCE : VERTICAL AT 3 M

NO.	FREQ. (MHz)	EMISSION LEVEL (dBuV/m)	LIMIT (dBuV/m)	MARGIN (dB)	ANTENNA HEIGHT (m)	TABLE ANGLE (Degree)	RAW VALUE (dBuV)	CORRECTION FACTOR (dB/m)
1	*2440.00	71.49 PK	114.00	-42.51	1.00 V	125	74.61	-3.12
2	*2440.00	62.10 AV	94.00	-31.90	1.00 V	125	65.22	-3.12
3	4880.00	48.55 PK	74.00	-25.45	1.00 V	125	50.74	-2.19
4	4880.00	39.16 AV	54.00	-14.84	1.00 V	125	41.35	-2.19
5	7320.00	53.90 PK	74.00	-20.10	1.00 V	185	53.04	0.86
6	7320.00	44.51 AV	54.00	-9.49	1.00 V	185	43.65	0.86

REMARKS:

1. Emission level (dBuV/m) = Raw Value (dBuV) + Correction Factor (dB/m).
2. Correction Factor (dB/m) = Antenna Factor (dB/m) + Cable Factor (dB).
3. The emission levels of other frequencies were greater than 20dB margin.
4. Margin value = Emission level – Limit value.
5. " * ": Fundamental frequency.
6. Average value = PK Emission + 20*log(duty cycle) Where the duty factor is calculated from following formula: 20 log (Duty cycle) = 20Log(33.9%) ≈ -9.39dB, Please see page 9 for plotted duty.

CHANNEL	TX High Channel	DETECTOR FUNCTION	Peak (PK)
FREQUENCY RANGE	1GHz ~ 25GHz		Average (AV)

ANTENNA POLARITY & TEST DISTANCE : HORIZONTAL AT 3 M								
NO.	FREQ. (MHz)	EMISSION LEVEL (dBuV/m)	LIMIT (dBuV/m)	MARGIN (dB)	ANTENNA HEIGHT (m)	TABLE ANGLE (Degree)	RAW VALUE (dBuV)	CORRECTION FACTOR (dB/m)
1	*2480.00	70.71 PK	114.00	-43.29	1.20 H	150	73.73	-3.02
2	*2480.00	61.32 AV	94.00	-32.68	1.20 H	150	64.34	-3.02
3	2483.50	45.37 PK	74.00	-28.63	1.20 H	150	48.37	-3.00
4	2483.50	35.98 AV	54.00	-18.02	1.20 H	150	38.98	-3.00
5	4960.00	48.45 PK	74.00	-25.55	1.00 H	125	50.60	-2.15
6	4960.00	39.06 AV	54.00	-14.94	1.00 H	125	41.21	-2.15
7	7440.00	51.30 PK	74.00	-22.70	1.20 H	150	50.97	0.33
8	7440.00	41.91 AV	54.00	-12.09	1.20 H	150	41.58	0.33
ANTENNA POLARITY & TEST DISTANCE : VERTICAL AT 3 M								
NO.	FREQ. (MHz)	EMISSION LEVEL (dBuV/m)	LIMIT (dBuV/m)	MARGIN (dB)	ANTENNA HEIGHT (m)	TABLE ANGLE (Degree)	RAW VALUE (dBuV)	CORRECTION FACTOR (dB/m)
1	*2480.00	70.88 PK	114.00	-43.12	1.00 V	125	73.90	-3.02
2	*2480.00	61.49 AV	94.00	-32.51	1.00 V	125	64.51	-3.02
3	2483.50	45.43 PK	74.00	-28.57	1.00 V	125	48.43	-3.00
4	2483.50	36.04 AV	54.00	-17.96	1.00 V	125	39.04	-3.00
5	4960.00	48.64 PK	74.00	-25.36	1.00 V	125	50.79	-2.15
6	4960.00	39.25 AV	54.00	-14.75	1.00 V	125	41.40	-2.15
7	7440.00	52.30 PK	74.00	-21.70	1.00 V	125	51.97	0.33
8	7440.00	42.91 AV	54.00	-11.09	1.00 V	125	42.58	0.33

REMARK:

1. Emission level (dBuV/m) = Raw Value (dBuV) + Correction Factor (dB/m).
2. Correction Factor (dB/m) = Antenna Factor (dB/m) + Cable Factor (dB).
3. The emission levels of other frequencies were greater than 20dB margin.
4. Margin value = Emission level – Limit value.
5. " * " : Fundamental frequency.
6. Average value = PK Emission + 20*log(duty cycle) Where the duty factor is calculated from following formula: 20 log (Duty cycle) = 20Log(33.9%) ≈ -9.39dB, Please see page 9 for plotted duty.



Band edge Plot

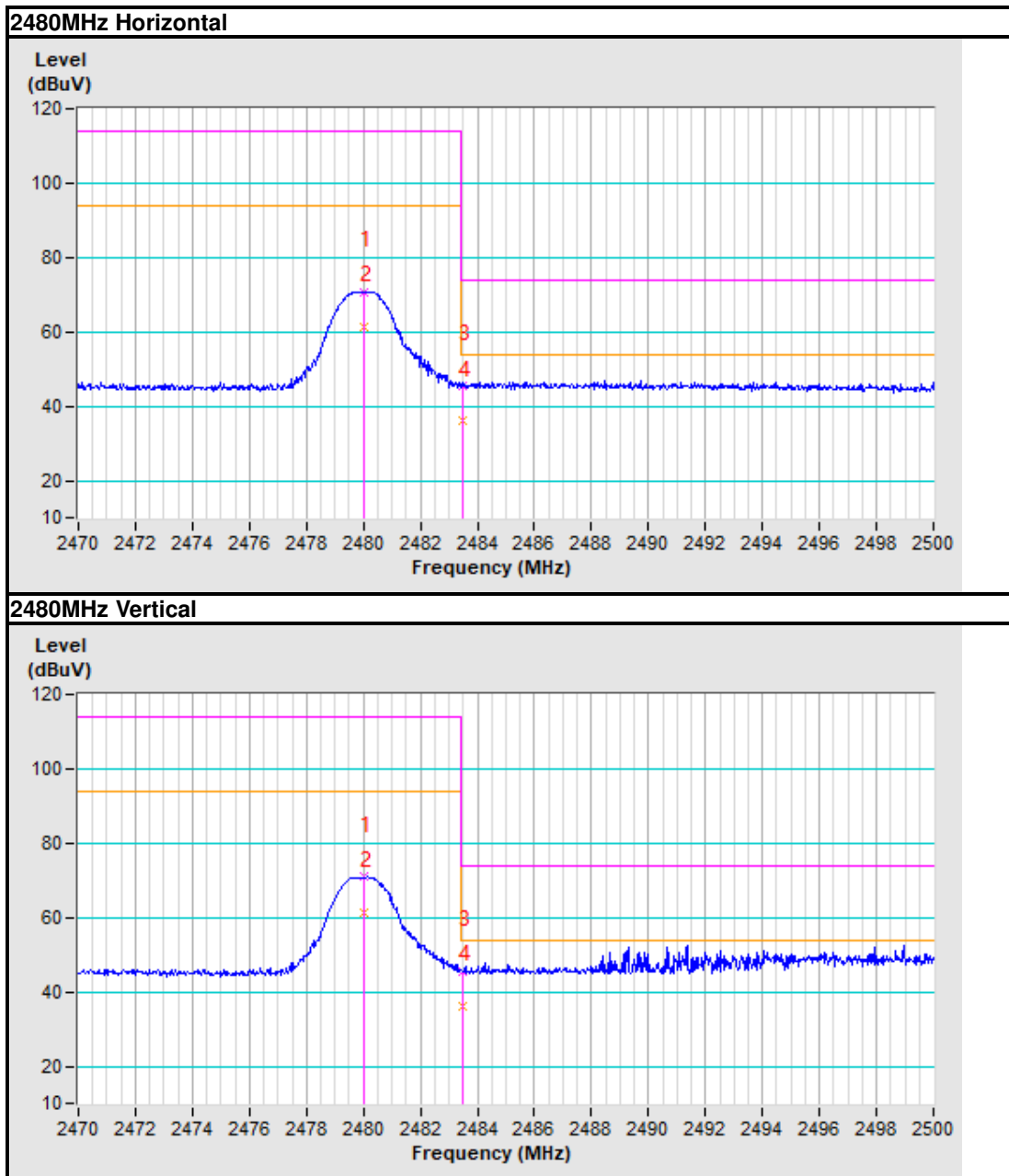

4.3 20dB BANDWIDTH MEASUREMENT

4.3.1 LIMITS OF 20DB BANDWIDTH MEASUREMENT

According to FCC 15.215(c), must be designed to ensure that the 20 dB bandwidth of the emission, or whatever bandwidth may otherwise be specified in the specific rule section under which the equipment operates, is contained within the frequency band designated in the rule section under which the equipment is operated.

4.3.2 TEST INSTRUMENTS

Equipment	Manufacturer	Model No.	Serial No.	Next Cal.
Wireless Connectivity Tester	Rohde&Schwarz	CMW270	101601	Oct. 15, 24
Spectrum Analyzer	Rohde&Schwarz	FSV40	101003	Jan. 15, 24
Spectrum Analyzer	Rohde&Schwarz	FSV40	101094	Jan. 11, 24
Frequency Analyzer	Keysight	N9010B	MY60240432	Oct. 10, 24
Programmable Temperature&Humidity Chamber	Hongjin	HYC-TH-225DH	DG-180746	Jan. 11, 24
Attenuator	MINI	BW-S10W2+	S130129FGE2	N/A
DC Source	Agilent	E3640A	MY40004013	Feb. 08, 24
Test software	ADT	ADT_RF Test Software V6.6.5.3	N/A	N/A
Test software	ADT	ADT_RF Test Software V6.6.5.4	N/A	N/A

NOTES:

1. The test was performed in RF Test Shielded Room.
2. The calibration interval of the above test instruments is 12 months and the calibrations are traceable to CEPREI/CHINA, GRGT/CHINA and NIM/CHINA.
3. Test site: No. 122, Houjie Avenue West Houjie Town, Dongguan City Guangdong Province, 523960, People's Republic of China.

4.3.3 TEST PROCEDURE

- a. Check the calibration of the measuring instrument using either an internal calibrator or a known signal from an external generator.
- b. Turn on the EUT and connect it to measurement instrument. Then set it to any one convenient frequency within its operating range. Set a reference level on the measuring instrument equal to the highest peak value.
- c. Measure the frequency difference of two frequencies that were attenuated 20dB from the reference level. Record the frequency difference as the emission bandwidth.
- d. Repeat above procedures until all frequencies measured were complete.



4.3.4 DEVIATION FROM TEST STANDARD

No deviation.

4.3.5 TEST SETUP

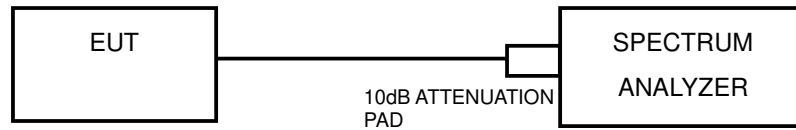

4.3.6 EUT OPERATING CONDITIONS

- a) Turned on the power of all equipment.
- b) EUT was operated according to the type used was description in manufacturer's specifications or the User's Manual.

4.3.7 TEST RESULTS

CHANNEL	CHANNEL FREQUENCY (MHz)	20dB BANDWIDTH (MHz)
Low	2402	1.1722
Middle	2440	1.1896
High	2480	1.1679

Test Data: Low channel

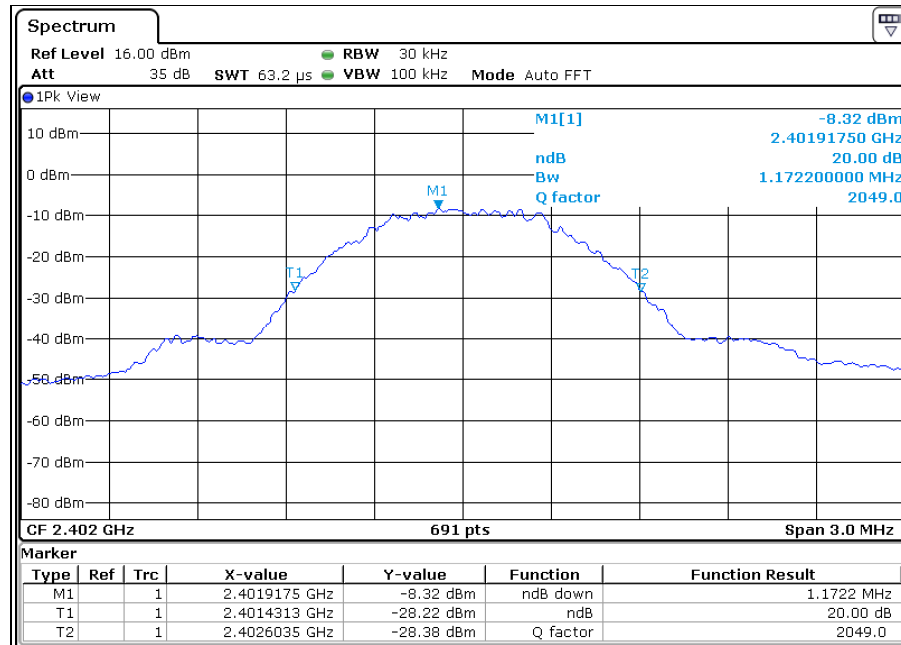

Test Data: Middle channel

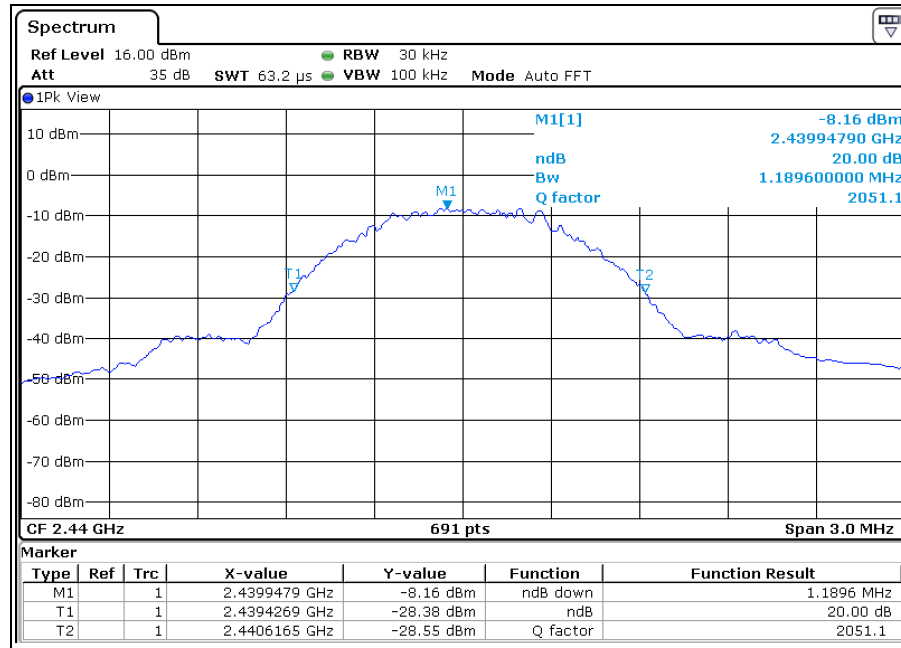

Test Data: High channel

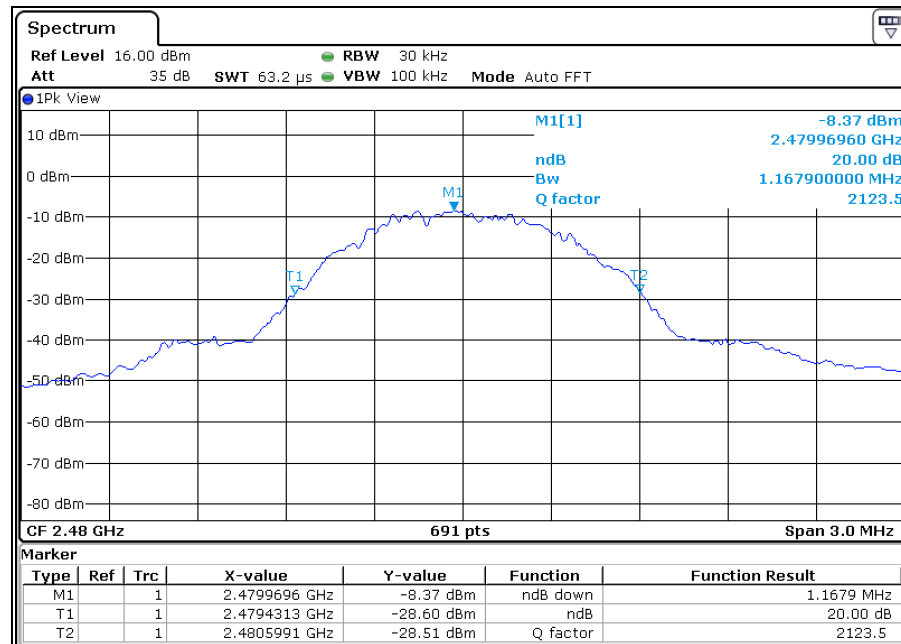



BUREAU
VERITAS

Test Report No.: RF2311WDG0023-3

5. PHOTOGRAPHS OF THE TEST CONFIGURATION

Please refer to the attached file (Test Setup Photo).



Test Report No.: RF2311WDG0023-3

6. APPENDIX A - MODIFICATIONS RECORDERS FOR ENGINEERING CHANGES TO THE EUT BY THE LAB

No any modifications are made to the EUT by the lab during the test.

---END---