



Test report issued under the responsibility of:  
EMITECH MONTPELLIER laboratory  
MRA US-EU Designation Number: FR0006  
Canadian CAB Identifier: FR0003

## RADIO TEST REPORT

FCC 47 CFR PART 15.247  
RSS-247\_Issue 2, February 2017

**Company** ..... : **XPLORER**  
**Address**..... : 40 chemin du Moulin  
31320 MERVILLA  
FRANCE

**Test item description** ..... : **Headset for wireless metal detection sensor**  
**Trade Mark** ..... : WSA II  
**Manufacturer**..... : XPLORER  
**FCC ID**..... : XFJWSA2  
**IC** ..... : 8392A-WSA2  
**Model/Type reference**..... : XPWSA2 / Headset WSA Pro XL  
**Ratings**..... : 3.45Vdc to 4.2Vdc

**Testing Laboratory** ..... : **EMITECH MONTPELLIER laboratory**  
**Address**..... : 145 rue de Massacan  
34740 VENDARGUES  
FRANCE

**Report Reference No**..... : **RR410-20-101751-16A**  
**Test procedure** ..... : FCC IC Certification  
**Diffusion**..... : Mr LOUBET  
**Applicant's name** ..... : XPLORER  
**Date of issue**..... : October 25, 2021  
**Total number of pages**..... : 98  
**Revision** ..... : 0  
**Modified page(s)**..... : Creation  
**Compiled by**..... : Alexis TOUZET  
**Approved by (+ signature)** ..... : Olivier HEYER (Laboratory Manager)

*Duplication of this test report is only permitted for an integral photographic facsimile. It includes the number of pages referenced here above. This document is the result of testing a specimen or a sample of the product submitted. It does not imply an assessment of the conformity of the whole manufactured products of the tested sample.*

REPORT INDEX:	
<b>1. GENERAL INFORMATIONS .....</b>	<b>3</b>
<b>2. REFERENCE DOCUMENT(S).....</b>	<b>4</b>
<b>3. EQUIPMENT TECHNICAL DESCRIPTION.....</b>	<b>5</b>
3.1. TEST CONDITIONS .....	5
3.2. EUT MARKING PLATE .....	5
3.3. EUT GENERAL VIEW.....	6
3.4. EUT MECHANICAL AND ELECTRICAL DESIGN.....	7
3.5. EUT INPUT/OUTPUT PORTS.....	7
3.6. SUPPORTING EQUIPMENT USED DURING TEST.....	8
3.7. EUT RADIO SPECIFICATIONS.....	9
<b>4. OPINION(S) AND INTERPRETATION(S) .....</b>	<b>10</b>
<b>5. RESULT SUMMARY .....</b>	<b>11</b>
<b>6. MEASUREMENT UNCERTAINTY .....</b>	<b>14</b>
<b>7. RF EXPOSURE .....</b>	<b>15</b>
<b>8. TEST CONDITIONS AND RESULTS .....</b>	<b>15</b>
8.1. CONDUCTED EMISSION (MEASUREMENT).....	15
8.2. 6dB BANDWIDTH.....	19
8.3. OCCUPIED BANDWIDTH.....	24
8.4. MAXIMUM EFFECTIVE ISOTROPIC RADIATED POWER .....	29
8.5. BAND-EDGE COMPLIANCE.....	35
8.6. POWER SPECTRAL DENSITY.....	41
8.7. TRANSMITTER RADIATED SPURIOUS EMISSIONS AT FREQUENCIES <30MHZ.....	47
8.8. TRANSMITTER RADIATED SPURIOUS EMISSIONS AT FREQUENCIES >30MHZ.....	57
8.9. RADIATED SPURIOUS EMISSIONS (RECEIVER).....	81
8.10. FREQUENCY ERROR.....	96

REVISION HISTORY:			
Revision	Date	Modified pages	Modifications
0	October 25, 2021	/	Creation



## 2. REFERENCE DOCUMENT(S)

### NORMATIVE REFERENCES:

The following referenced documents are necessary for the application of the present test report.

**FCC 47 CFR PART 15: 2017**

Code of federal regulations – Title 47 telecommunication  
Part 15- Radio frequency devices

**FCC part 15.247**

Operation within the bands 902–928 MHz, 2400–2483.5 MHz, and 5725–5850MHz. (frequency hopping and digitally modulated)

**RSS-247\_Issue 2, February 2017**

Digital Transmission Systems (DTSs), Frequency Hopping Systems (FHSs) and Licence Exempt Local Area Network (LE-LAN) Devices

**RSS/CNR-Gen, Issue 5, April 2018, Amd1: 2019, Amd2: 2021**

Exigences générales et information relatives à la certification du matériel de radiocommunication

**ANSI C 63.10:2013**

American National Standard of Procedures for Compliance Testing of Unlicensed Wireless Devices

**ANSI C 63.4:2014**

American National Standard for Methods of measurement of Radio-Noise from low-voltage Electrical and Electronic Equipment in the Range of 9 kHz to 40 GHz

Although the product standard uses obsolete technical standards, the latest versions of standards achievable by the laboratory will be used for testing.

### INFORMATIVE REFERENCES:

The following referenced documents are not necessary for the application of the present test report but they assist the user with regard to a particular subject area.



### 3.3.EUT General view



### 3.4. EUT Mechanical and Electrical Design

Power supply..... : 3.7Vdc  
 Power supply range..... : 3.45Vdc to 4.2Vdc  
 Power type..... : Battery powered  
 Power (W)..... : 5  
 Nominal current (A)..... : 1  
 Dimensions (L x W x H) (m)..... : 0.15x0.15x0.07  
 Weight (kg)..... : 0.8  
 Temperature range (°C)..... : -5°C to +40°C  
 Ground bounding strap..... : No

**Comments:**

N/A

### 3.5. EUT Input/Output ports

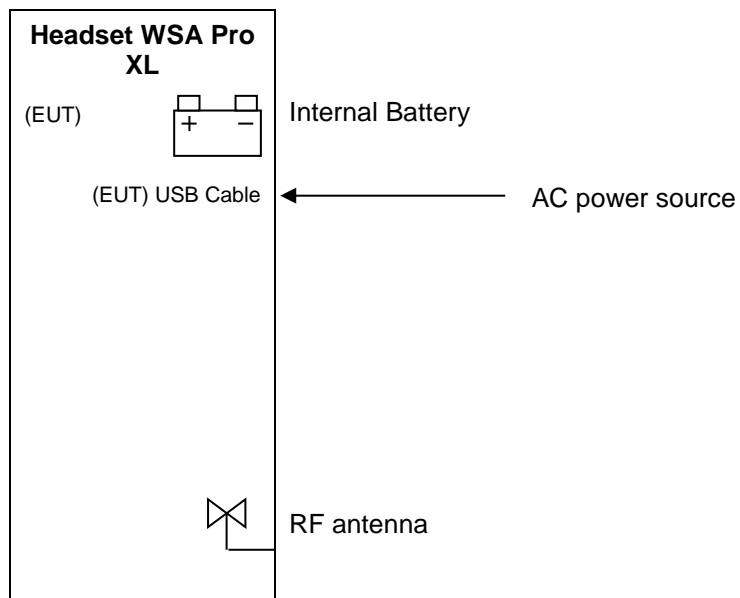

PORT	NAME	TYPE	LENGTH	CABLE TYPE	COMMENTS
0	Main frame	N/E	N/A	Plastic	
1	Battery	DC	N/A	N/A	
2	AC power source	AC/DC	1m	2P	
3	RF antenna	RF	N/A	N/A	2.4GHz

AC/DC : AC/DC Converter port      AC.....: Alternative current port      DC.....: Discontinuous current port  
 I/O .....: Input or Output port      TP .....: Telecommunication port      RF .....: Radio frequency port  
 N/E .....: Non Electrical port

### 3.6. Supporting Equipment Used During Test

Sample subject to the tests was tested with following equipment.

PRODUCT TYPE	MANUFACTURER	MODEL	N°EMITECH / COMMENTS
Battery charger (AC/DC)	Sinohero Industrial Ltd.	SJ-0510-E	Used for conducted emission

#### BATTERY CHARGER (AC/DC) (AE)





### 3.7. EUT Radio Specifications

<b>a) GENERAL INFORMATIONS</b>	
According to manufacturer's declarations :	
EUT type.....	<i>Transmitter</i>
Technology .....	<i>SRD 2.4GHz</i>
Environmental profile.....	<i>Data transmissions</i>
Temperature range.....	<i>-5°C to +40°C</i>
Antenna type .....	<i>Integral</i>
Antenna Gain.....	<i>not communicated</i>
<b>Comments:</b>	
<i>N/A</i>	
<b>b) TRANSMITTER PARAMETERS (Tx)</b>	
Frequency bands.....	<i>2400 MHz to 2483.5MHz</i>
RF Power.....	<i>Not communicated</i>
Number of channels / Separation .....	<i>Multiple</i>
Modulation type .....	<i>GFSK</i>
Duty cycle .....	<i>Not communicated</i>
Tested frequency.....	<i>2404MHz Low channel</i> <i>2440MHz Mid channel</i> <i>2476 High channel</i>
<b>c) RECEIVER PARAMETERS (Rx)</b>	
Frequency bands.....	<i>2400 MHz to 2483.5MHz</i>
Category/Class .....	<i>Category 2</i>
Bandwidth.....	<i>2404MHz to 2476MHz</i>

**4. OPINION(S) AND INTERPRETATION(S)**

TEST(S) PERFORMED	DEVIATION(S) TO TEST METHOD(S)
FCC part 15.247 subclause d) and RSS-247	N/A
FCC part 15.247 and RSS-247	N/A
FCC part 15.109, 15.209, 15.205, 15.215, CNR-Gen	N/A
FCC part 15.109, 15.209, 15.205, 15.215, CNR-Gen	The EUT is encapsulated in a casing. We were not able to measure its voltage supply during radiated tests
FCC part 15.109, 15.209, 15.205, 15.215 RSS-247, CNR Gen	N/A
FCC part 15 Radio part 15.215 and RSS Gen	N/A
ANSI C63.4: 2014	N/A

Comments: N/A

## 5. RESULT SUMMARY

TEST DESIGNATION	SEVERITY	VERDICT	BASIC STANDARDS / COMMENTS
<b>SUBPART A - GENERAL</b>			
Labeling requirements		PASS	15.19 / See certification documents
Information to user		PASS	15.21 / See certification documents
Home-built devices		N/A	15.23
Kits		N/A	15.25
Special Accessories		PASS	15.27 / See certification documents
Inspection by the Commission		N/A	15.29
Measurement standards		PASS	15.31
Test procedure for CPU boards and computer power supplies		N/A	15.32
Frequency range of radiated measurements		PASS	15.33
Measurement detector functions and bandwidths		PASS	15.35
Transition provisions for compliance with the rules		PASS	15.37 / See certification documents
<b>SUBPART B – UNINTENTIONAL RADIATORS</b>			
Equipment authorization			15.101
- Verification		N/A	
- Declaration of Conformity		N/A	
CPU boards and power supplies used in personal computers		N/A	15.102
Exempted device		N/A	15.103
Information to the user		PASS	15.105 / See certification documents
Conducted limits	Class B	PASS	15.107
Radiated emission limits	Class A	PASS	15.109
Antenna power conduction limits for receivers		N/A	15.111
Power line carrier systems		N/A	15.113
TV interface devices, including cable system terminal devices		N/A	15.115
TV broadcast receivers		N/A	15.117
Cable ready consumer electronics equipment		N/A	15.118
Program blocking technology requirements for TV receivers		N/A	15.120
Scanning receivers and frequency converters used with scanning receivers		N/A	15.121
Labeling of digital cable ready products		N/A	15.123

TEST DESIGNATION	SEVERITY	VERDICT	BASIC STANDARDS / COMMENTS
<b>SUBPART C –INTENTIONAL RADIATORS</b>			
<b>Equipment authorization requirement</b>		<b>PASS</b>	<b>15.201 / Transmitter part is subject to Certification procedure</b>
<b>Certified operating frequency range</b>		<b>N/A</b>	<b>15.202</b>
<b>Antenna requirement</b>		<b>PASS</b>	<b>15.203 / Dedicated and glued antenna</b>
<b>External radio frequency power amplifiers and antenna modifications</b>		<b>N/A</b>	<b>15.204</b>
<b>Restricted bands of operation</b>		<b>PASS</b>	<b>15.204</b>
<b>Conducted limits</b>	<b>Class B</b>	<b>PASS</b>	<b>15.207</b>
<b>Radiated emission limits; general requirements</b>	<b>Class B</b>	<b>PASS</b>	<b>15.209</b>
<b>Tunnel radio systems</b>		<b>N/A</b>	<b>15.211</b>
<b>Modular transmitters</b>		<b>N/A</b>	<b>15.212</b>
<b>Cable locating equipment</b>		<b>N/A</b>	<b>15.213</b>
<b>Cordless telephones</b>		<b>N/A</b>	<b>15.214</b>
<b>Additional provisions to the general radiated emission limits</b>		<b>PASS</b>	<b>15.215</b>
<b>Operation within the band 902-928MHz, 2400-2483.5MHz and 5725-5850MHz</b>			<b>15.247</b>
- Frequency hopping and digitally modulated		-	<b>a)</b>
- Frequency hopping system		N/A	a) (1)
- Digital modulation system		PASS	a) (2)
- <b>Maximum peak conducted output power</b>		-	<b>b)</b>
- For hopping system in the 2400-2483.5 MHz and 5725-5850 MHz bands		N/A	b) (1)
- For hopping system in the 902-928MHz band		N/A	b) (2)
- For system using digital modulation in the 902-928 MHz, 2400-2483.5 MHz and 5725-5850 MHz bands		PASS	b) (3)
- <b>Operation with directional antenna gains &gt; 6 dBi</b>		<b>N/A</b>	<b>c)</b>
- <b>Out-of-band emissions</b>		<b>PASS</b>	<b>d)</b>
- <b>Power spectral density conducted</b>		<b>PASS</b>	<b>e)</b>
- <b>Hybrid system</b>		<b>N/A</b>	<b>f)</b>
- <b>Frequency hopping additional requirements</b>		<b>N/A</b>	<b>g)</b>
- <b>Frequency hopping intelligence</b>		<b>N/A</b>	<b>h)</b>
- <b>RF exposure compliance</b>		<b>PASS</b>	<b>i)</b>

Sample subject to the test complies with the requirements of the reference document(s) listed in §2 of this test report and, where applicable, with deviation(s) specified in this document.

To declare, or not, the compliance with the specifications, it was not explicitly taken account of uncertainty associated with the results.

Opinion(s) and interpretation(s): N/A

TEST(S) PERFORMED	MODIFICATION(S)
FCC part 15.247 subclause d) and RSS-247	N/A
FCC part 15.247 and RSS-247	N/A
FCC part 15.109, 15.209, 15.205, 15.215, CNR-Gen	N/A
FCC part 15.109, 15.209, 15.205, 15.215 RSS-247, CNR Gen	N/A
FCC part 15 Radio part 15.215 and RSS Gen	N/A
ANSI C63.4: 2014	N/A

## 6. MEASUREMENT UNCERTAINTY

PARAMETER	MAXIMAL EMITECH UNCERTAINTY	MINIMAL STANDARD UNCERTAINTY
Radio frequency	$\pm 1 \times 10^{-7}$	$\pm 1 \times 10^{-7}$
RF power, conducted		
RF power	$\pm 0.8\text{dB}$	$\pm 1 \text{ dB}$
RF power (EN 300328 / EN 301893)	$\pm 1.3\text{dB}$	$\pm 1.5 \text{ dB}$
Power spectral density	$\pm 2.3\text{dB}$	$\pm 3 \text{ dB}$
Occupied bandwidth		
RF power	$\pm 3.8 \%$	$\pm 5 \%$
RF power (EN 300328 / EN 301893)	$\pm 3.8 \%$	$\pm 5 \%$
Maximum frequency deviation		
300 Hz < audio frequency < 6 kHz	$\pm 1.2 \%$	$\pm 5 \%$
6 kHz < audio frequency < 25 kHz	$\pm 1.2 \%$	$\pm 3 \text{ dB}$
Adjacent channel power	$\pm 1.6 \text{ dB}$	$\pm 3 \text{ dB}$
Sensibility of receiver (conducted)	$\pm 2.0 \text{ dB}$	$\pm 3 \text{ dB}$
Blocking	$\pm 4.0 \text{ dB}$	$\pm 4 \text{ dB}$
Transient		
Amplitude	$\pm 8.5 \%$	$\pm 20 \%$
At the frequency	$\pm 166 \text{ Hz}$	$\pm 250 \text{ Hz}$
Conducted emission (spurious)		
$f \leq 1 \text{ GHz}$	$\pm 0.8 \text{ dB}$	
1 GHz - 12.75 GHz	$\pm 1.6 \text{ dB}$	$\pm 3 \text{ dB}$
Radiated emission (PAR / PIRE / RNE)		
$f \leq 62.5 \text{ MHz}$	$\pm 5.1 \text{ dB}$	$\pm 6 \text{ dB}$
62.5 MHz - 1 GHz	$\pm 5.1 \text{ dB}$	$\pm 6 \text{ dB}$
1 GHz - 18 GHz	$\pm 5.2 \text{ dB}$	$\pm 6 \text{ dB}$
18 GHz – 26 GHz	$\pm 5.1 \text{ dB}$	$\pm 6 \text{ dB}$
26 GHz – 40 GHz	$\pm 5.4 \text{ dB}$	$\pm 6 \text{ dB}$
180-1000 MHz / 1 – 12.75 GHz (EN 301 908-1)	$\pm 3.0 / 2.9 \text{ dB}$	$\pm 3 \text{ dB}$
RF power (EN 300328 / EN 301893)	$\pm 5.3 \text{ dB}$	$\pm 6 \text{ dB}$
PIRE and power spectral density with diode	$\pm 5.2 \text{ dB}$	$\pm 6 \text{ dB}$
Radiated emission (magnetic field)		
9kHz – 30MHz	$\pm 3 \text{ dB}$	$\pm 6 \text{ dB}$
RF level for a given BER	$\pm 0.8 \text{ dB}$	$\pm 1.5 \text{ dB}$
Supply voltages	$\pm 3 \%$	$\pm 3 \%$
Temperature	$\pm 1 \text{ }^\circ\text{C}$	$\pm 1^\circ\text{C}$
Humidity	$\pm 5 \%$	$\pm 5 \%$
Time / Duty cycle	$\pm 4.4 \%$	$\pm 5 \%$
Adaptivity	$\pm 2.9 \text{ dB}$	/
Conducted emission (FCC)		
(Artificial Mains Network) 150kHz – 30MHz	$\pm 3.4 \text{ dB}$	$\pm 3.4 \text{ dB}$
Radiated emission (electric field for FCC standard)		
9kHz – 30MHz	$\pm 2.7 \text{ dB}$	/
30MHz – 1GHz	$\pm 5.0 \text{ dB}$	/
1GHz – 18GHz	$\pm 5.6 \text{ dB}$	/
18GHz – 26GHz	$\pm 5.7 \text{ dB}$	/
26GHz – 40GHz	$\pm 5.7 \text{ dB}$	/

For the calculation of expanded uncertainty, the confidence interval is 95 % (k=2).

## 7. RF EXPOSURE

Maximum EIRP = -3.91Bm (0.000123 mW) at 2404MHz

In accordance with KDB 447498 D01 General RF Exposure Guidance v06:  
 $PSD = EIRP / (4 * \pi * R^2) = 0.000123 / (4 * \pi * (20 \text{ cm})^2) = 0.0000000245 \text{ mW/cm}^2$   
 Limit = 1 mW/cm<sup>2</sup>

## 8. TEST CONDITIONS AND RESULTS

### 8.1. Conducted emission (measurement)

<b>Reference standard:</b>	FCC part 15.107, 15.207 and RSS-Gen
<b>Test method:</b>	ANSI C63.4: 2014
<p><b>General test setup:</b> EUT is set on an insulating support at 80cm from the ground reference plane. All power was connected to the system through Artificial Mains Network (AMN). The AMN is placed at 80cm from the boundary of the EUT and bonded to a ground reference plane.</p> <p>All tested telecommunications lines (if applicable) were connected to an Asymmetric Artificial Network (AAN) and conducted voltage measurements on telecommunications lines were made at the output of the AAN.</p> <p>Where an AAN was not appropriate or available, measurements were made using a Capacitive Voltage Probe and/or a Current probe.</p> <p>Additional ground terminals (if any) are connected to earth terminal of the AMN.</p>	

TESTED CABLE	PARAMETER	SEVERITY	RESULT TAB.	VERDICT
120Vac/60Hz power supply / All channels	150kHz-30MHz	Class B	EMI7579	<b>PASS</b>
120Vac/60Hz power supply / Charging mode	150kHz-30MHz	Class B	EMI7580	<b>PASS</b>

LABORATORY PARAMETERS:	REQUIRED PRIOR TO THE TEST	DURING THE TEST
Ambient Temperature	15 to 35 °C	See Graph(s)
Relative Humidity	30 to 60 %	See Graph(s)
Atmospheric pressure	N/A	See Graph(s)
<b>Test method deviation:</b> N/A		
Supplementary information: N/A		

TEST EQUIPMENT USED					
CATEGORY	BRAND	TYPE	IDENTIFIER	CAL. DATE	CAL. DUE
Cable	EMITECH	Current absorber sheath	9491	23/06/2020	23/08/2022
Cable	C&C	N-3m	14331	18/03/2021	18/05/2023
LISN	PMM	L2-16	1209	08/06/2020	08/08/2022
Receiver	Rohde & Schwarz	ESHS10	3371	27/04/2020	27/06/2021
Receiver	Rohde & Schwarz	FPL1003	16027	14/08/2020	14/10/2021
Software	Nexio		0000		
Surges Suppressor	Hewlett Packard	11947A	0238	20/12/2019	20/02/2023
Thermohygrometer	Testo	608-H1	7562	26/01/2019	26/09/2021
Thermohygrometer	Bioblock Scientific	Météostar	0963	26/01/2019	26/09/2021

BAT-EMC software version: V3.18.0.26

Blank cells = Permanent validity





CONDUCTED EMISSION (MEASUREMENT) - GRAPH			
120VAC/60HZ POWER SUPPLY / ALL CHANNELS			EMI7579
<b>EUT mode:</b>	Tx mode	<b>T (°C):</b>	18.1
<b>Test Date:</b>	05/05/2021	<b>H (%):</b>	55.8
<b>Test Operator:</b>	ATO	<b>P (hPa):</b>	1008

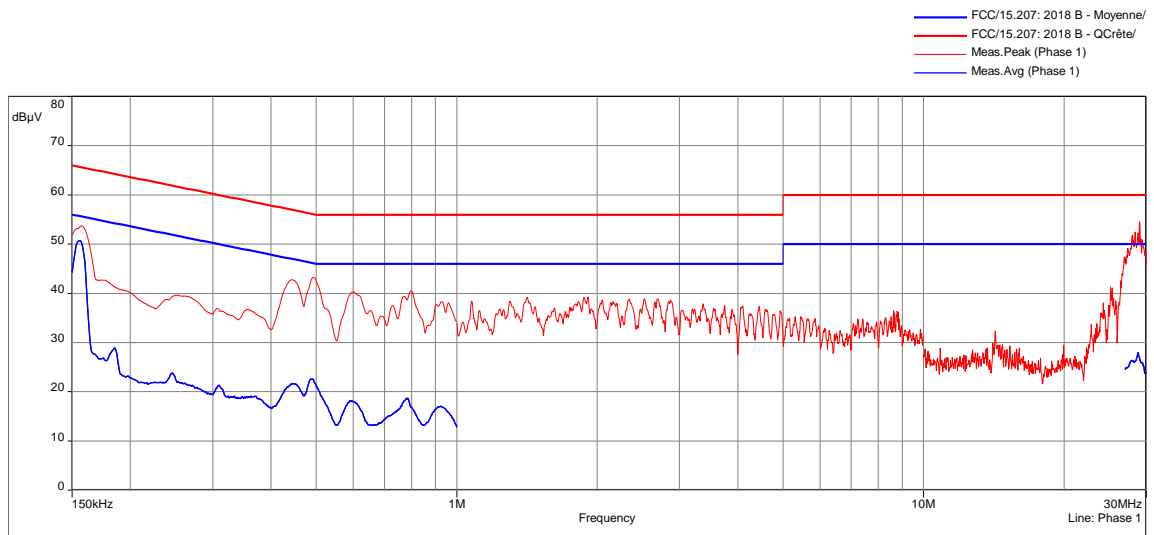

120Vac/60Hz power supply / All channels - 05/05/2021 10:29 - 7579

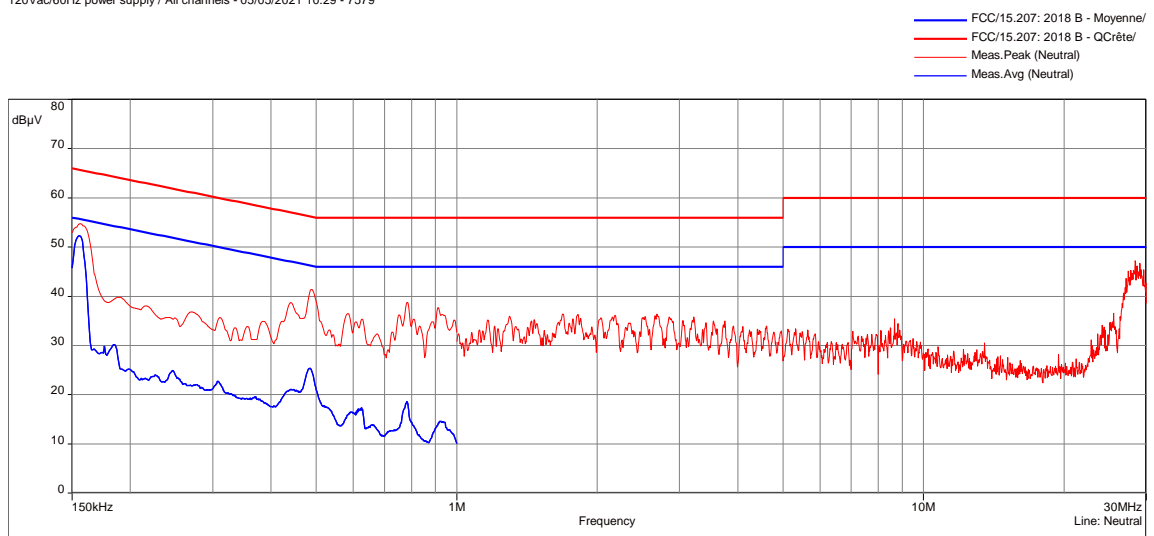

120Vac/60Hz power supply / All channels - 05/05/2021 10:29 - 7579

POSITION	FREQUENCIES	RBW	VBW	DETECTOR
Neutral	150kHz-1MHz	10kHz	30kHz	Peak
Neutral	1MHz-10MHz	10kHz	30kHz	Peak
Neutral	10MHz-30MHz	10kHz	30kHz	Peak
Phase 1	150kHz-1MHz	10kHz	30kHz	Peak
Phase 1	1MHz-10MHz	10kHz	30kHz	Peak
Phase 1	10MHz-30MHz	10kHz	30kHz	Peak
Neutral	150kHz-1MHz	10kHz	30kHz	Average
Phase 1	27MHz-30MHz	10kHz	30kHz	Average
Phase 1	150kHz-1MHz	10kHz	30kHz	Average
Phase 1	27MHz-30MHz	10kHz	30kHz	Average

<b>Measure with:</b>	A.M.N.
<b>Comments:</b>	N/A

EUT modification(s): N/A

CONDUCTED EMISSION (MEASUREMENT) - GRAPH			
120VAC/60HZ POWER SUPPLY / CHARGING MODE			EMI7580
<b>EUT mode:</b>	Tx mode		<b>T (°C):</b> 18.1
<b>Test Date:</b>	05/05/2021		<b>H (%):</b> 55.8
<b>Test Operator:</b>	ATO		<b>P (hPa):</b> 1008

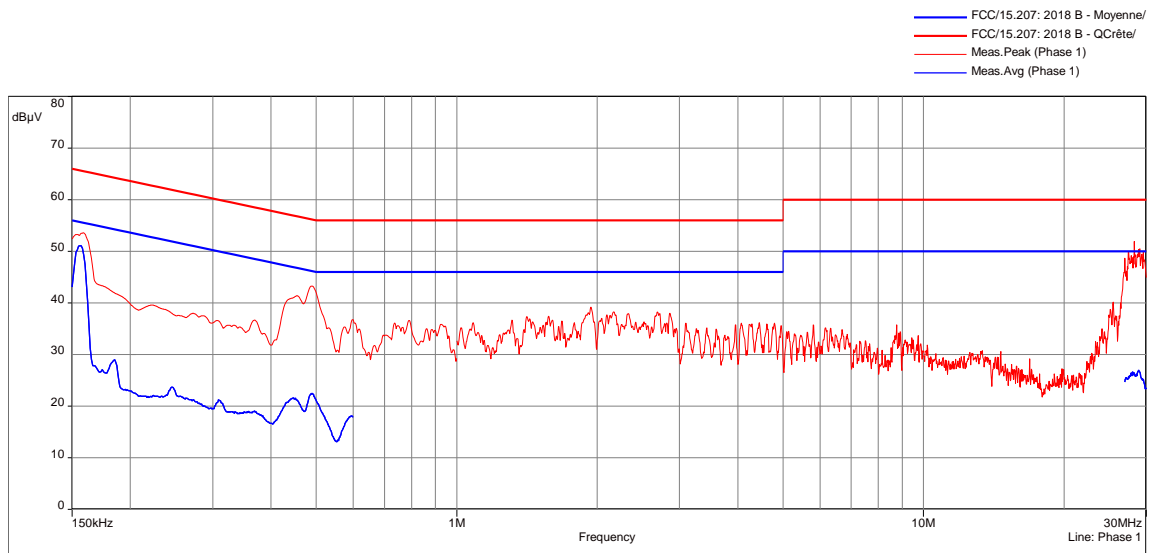

120Vac/60Hz power supply / Charging mode - 05/05/2021 09:44 - 7580

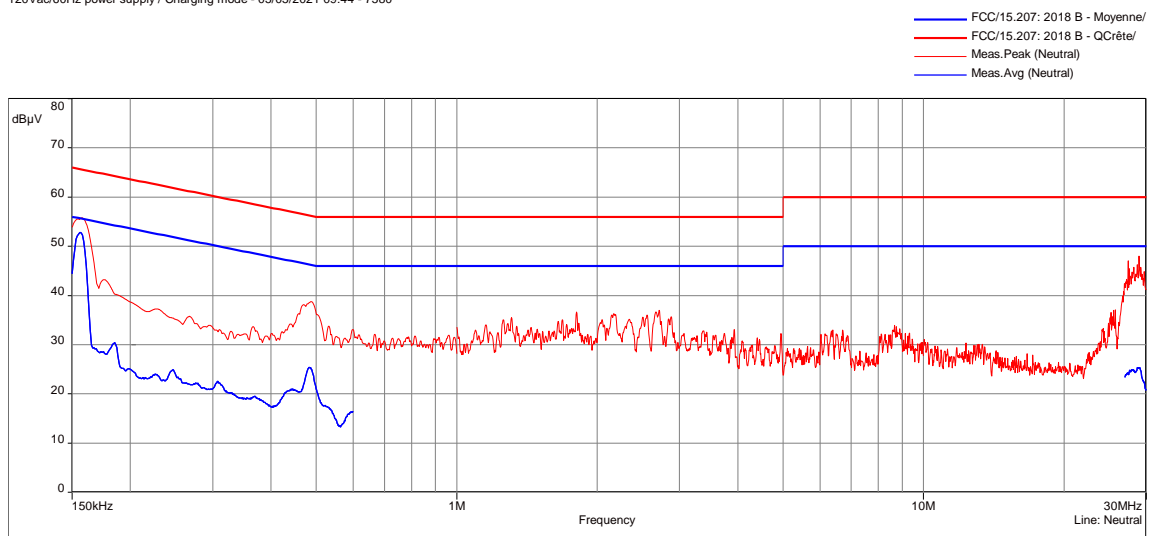

120Vac/60Hz power supply / Charging mode - 05/05/2021 09:44 - 7580

POSITION	FREQUENCIES	RBW	VBW	DETECTOR
Neutral	150kHz-1MHz	10kHz	30kHz	Peak
Neutral	1MHz-10MHz	10kHz	30kHz	Peak
Neutral	10MHz-30MHz	10kHz	30kHz	Peak
Phase 1	150kHz-1MHz	10kHz	30kHz	Peak
Phase 1	1MHz-10MHz	10kHz	30kHz	Peak
Phase 1	10MHz-30MHz	10kHz	30kHz	Peak
Neutral	150kHz-600kHz	10kHz	30kHz	Average
Neutral	27MHz-30MHz	10kHz	30kHz	Average
Phase 1	150kHz-600kHz	10kHz	30kHz	Average
Phase 1	27MHz-30MHz	10kHz	30kHz	Average

<b>Measure with:</b>	A.M.N.
<b>Comments:</b>	N/A
EUT modification(s): N/A	

## 8.2.6dB bandwidth

<b>Reference standard:</b>	FCC part 15 Radio part 15.247 and RSS-247
<b>Test method:</b>	FCC part 15.247 and RSS-247
<b>Test description:</b> a) (2): Systems using digital modulation techniques may operate in the 902-928 MHz, 2400-2483.5 MHz, and 5725-5850 MHz bands. The minimum 6 dB bandwidth shall be at least 500 kHz. EUT is connected to the measuring receiver via 50Ω attenuator(s). Tests are done in max-hold mode in order to capture all channels.	

TEST CASE AND CONDITIONS	SEVERITY	RESULT TAB.	VERDICT
Low Channel	>500kHz	EMI8079	<b>PASS</b>
Mid Channel	>500kHz	EMI8080	<b>PASS</b>
High Channel	>500kHz	EMI8081	<b>PASS</b>

LABORATORY PARAMETERS:	REQUIRED PRIOR TO THE TEST	DURING THE TEST
Ambient Temperature	15 to 35 °C	21.8 °C
Relative Humidity	20 to 75 %	42.1 %
Atmospheric pressure	N/A	1005 hPa
<b>Test method deviation:</b> N/A		
Supplementary information:		

TEST EQUIPMENT USED					
CATEGORY	BRAND	TYPE	IDENTIFIER	CAL. DATE	CAL. DUE
Antenna	ETS-Lindgren	3117	5456	24/07/2019	24/09/2022
Cable	SUCOFLEX	N-3m	14379	25/06/2019	25/08/2021
Cable	SUCOFLEX	N-5,5m	14381	25/06/2019	25/08/2021
Cable	Huber + Suhner	SF102K	16041	28/02/2019	28/04/2021
Receiver	Rohde & Schwarz	FSW43	14830	29/07/2020	29/09/2021
Shielded enclosure	RAY PROOF	C.V2	1423	04/10/2019	04/12/2022
Software	Nexio		0000		
Thermohygrometer	Testo	608-H1	7562	25/01/2019	25/03/2021
Thermohygrometer	Bioblock Scientific	Météostar	0963	26/01/2019	26/09/2021

Blank cells = Permanent validity

TEST SETUP PHOTO(S) – 6dB BANDWIDTH



6dB BANDWIDTH - GRAPH	
LOW CHANNEL	
<b>EMI8079</b>	
<b>EUT mode:</b>	Modulated
<b>Test Date:</b>	21/04/2021
<b>Test Operator:</b>	ATO

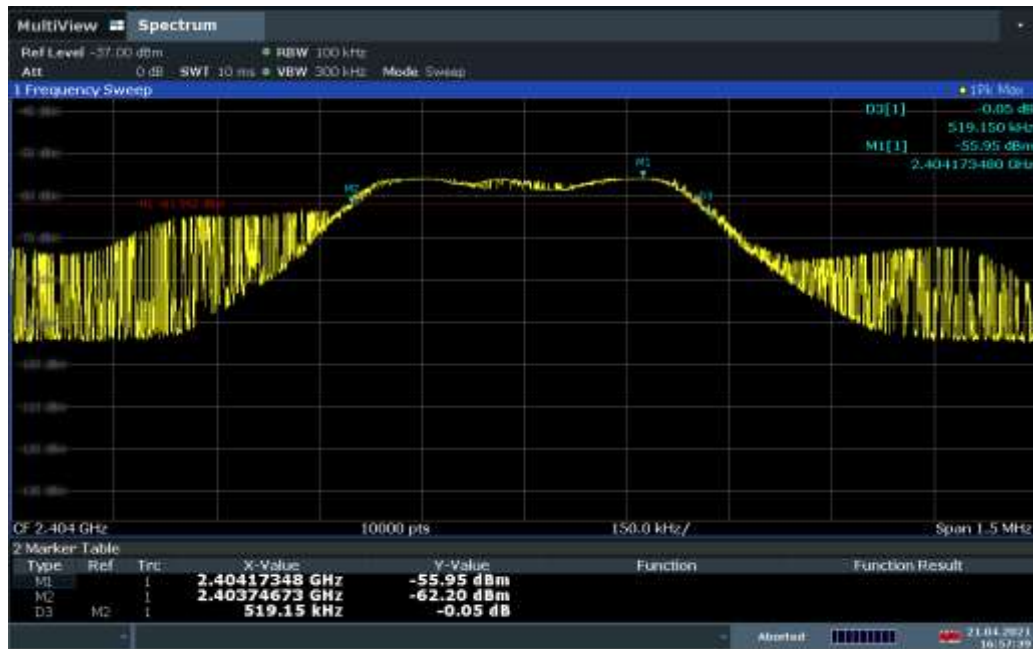

16:57:40 21.04.2021

EUT modification(s): N/A

6dB BANDWIDTH - TABULATED RESULTS			
LOW CHANNEL			
Frequency	RBW	6 dB Bandwidth	Limit
2404 MHz	100kHz	519.15 kHz	>500kHz

6DB BANDWIDTH - GRAPH	
MID CHANNEL	
EMI8080	
EUT mode:	Modulated
Test Date:	21/04/2021
Test Operator:	ATO

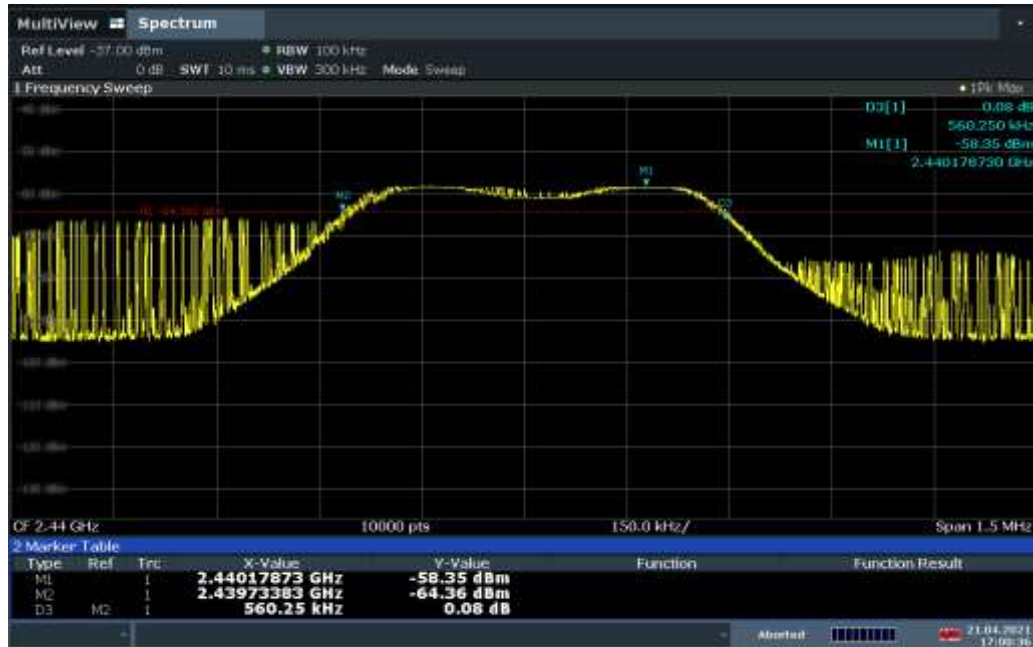

EUT modification(s): N/A

6dB BANDWIDTH - TABULATED RESULTS			
MID CHANNEL			
Frequency	RBW	6 dB Bandwith	Limit
2440 MHz	100kHz	560.25 kHz	>500kHz

6dB BANDWIDTH - GRAPH	
<b>HIGH CHANNEL</b>	
<b>EMI8081</b>	
<b>EUT mode:</b>	Modulated
<b>Test Date:</b>	21/04/2021
<b>Test Operator:</b>	ATO
	
17:02:44 21.04.2021	
EUT modification(s): N/A	

6dB BANDWIDTH - TABULATED RESULTS			
HIGH CHANNEL			
Frequency	RBW	6 dB Bandwith	Limit
2476 MHz	100kHz	513.75 kHz	>500kHz

### 8.3. Occupied bandwidth

<b>Reference standard:</b>	FCC part 15 Radio part 15.247 and RSS-247
<b>Test method:</b>	FCC part 15.247 and RSS-247
<p><b>Test description:</b> The occupied bandwidth (OBW) is the Frequency Range in which 99 % of the total mean power of a given emission falls. The residual part of the total power being denoted as <math>\beta</math>, which, in cases of symmetrical spectra, splits up into <math>\beta/2</math> on each side of the spectrum. Unless otherwise specified, <math>\beta/2</math> is taken as 0,5 %.</p> <p>The maximum occupied bandwidth includes all associated side bands above the appropriate emissions level and the frequency error or drift under extreme test conditions.</p>	

TEST CASE AND CONDITIONS	SEVERITY	RESULT TAB.	VERDICT
Low Channel	>500kHz	EMI8082	<b>PASS</b>
Mid Channel	>500kHz	EMI8083	<b>PASS</b>
High Channel	>500kHz	EMI8084	<b>PASS</b>

LABORATORY PARAMETERS:	REQUIRED PRIOR TO THE TEST	DURING THE TEST
Ambient Temperature	15 to 35 °C	21.8 °C
Relative Humidity	20 to 75 %	42.1 %
Atmospheric pressure	N/A	1005 hPa
<b>Test method deviation:</b> N/A		
Supplementary information:		

TEST EQUIPMENT USED					
CATEGORY	BRAND	TYPE	IDENTIFIER	CAL. DATE	CAL. DUE
Antenna	ETS-Lindgren	3117	5456	24/07/2019	24/09/2022
Cable	SUCOFLEX	N-3m	14379	25/06/2019	25/08/2021
Cable	SUCOFLEX	N-5,5m	14381	25/06/2019	25/08/2021
Cable	Huber + Suhner	SF102K	16041	28/02/2019	28/04/2021
Receiver	Rohde & Schwarz	FSW43	14830	29/07/2020	29/09/2021
Shielded enclosure	RAY PROOF	C.V2	1423	04/10/2019	04/12/2022
Software	Nexio		0000		
Thermohygrometer	Testo	608-H1	7562	25/01/2019	25/03/2021
Thermohygrometer	Bioblock Scientific	Météostar	0963	26/01/2019	26/09/2021

Blank cells = Permanent validity



TEST SETUP PHOTO(S) – OCCUPIED BANDWIDTH



OCCUPIED BANDWIDTH - GRAPH	
LOW CHANNEL	
EMI8082	
EUT mode:	Modulated
Test Date:	30/04/2021
Test Operator:	ATO



EUT modification(s): N/A

OCCUPIED BANDWIDTH - TABULATED RESULTS			
LOW CHANNEL			
Frequency	RBW	OBW 99%	Limit
2404 MHz	100 kHz	1383.80 kHz	> 500kHz

OCCUPIED BANDWIDTH - GRAPH	
MID CHANNEL	EMI8083
EUT mode:	Modulated
Test Date:	30/04/2021
Test Operator:	ATO
	
EUT modification(s): N/A	

OCCUPIED BANDWIDTH - TABULATED RESULTS			
MID CHANNEL			
Frequency	RBW	OBW 99%	Limit
2440 MHz	100 kHz	1655.56 kHz	> 500kHz

OCCUPIED BANDWIDTH - GRAPH	
<b>HIGH CHANNEL</b>	
<b>EMI8084</b>	
<b>EUT mode:</b>	Modulated
<b>Test Date:</b>	30/04/2021
<b>Test Operator:</b>	ATO
 <p>The graph shows a spectrum plot with a peak at 2.474 GHz and -90.09 dBm. The x-axis is frequency (2.476 GHz) and the y-axis is power (dBm). The span is 4.0 MHz. A table below the graph provides marker data: M1 (2.474 GHz, -90.09 dBm), T1 (2.47536158 GHz, -67.23 dBm), and T2 (2.4764799 GHz, -70.94 dBm). The function result is 1.118319153 MHz.</p>	
EUT modification(s): N/A	

OCCUPIED BANDWIDTH - TABULATED RESULTS			
HIGH CHANNEL			
Frequency	RBW	OBW 99%	Limit
2476 MHz	100 kHz	1118.31 kHz	> 500kHz

#### 8.4. Maximum effective isotropic radiated power

<b>Reference standard:</b>	FCC part 15 Radio part 15.247 and RSS-247
<b>Test method:</b>	FCC part 15.247 and RSS-247
<p><b>Test description:</b> EUT is set on an insulating support at 150cm above the ground reference plane. Measurement are done on a normalized test site by the substitution method.</p> <p>The test antenna is oriented in the two polarizations (vertical and horizontal), and the product is rotated at 360° in the horizontal plane (See photo(s) for initial position of the EUT(0°)). If applicable the test antenna was raised and lowered through the specified range of height until a maximum signal level is detected.</p> <p>For portable equipments a research of maximum level is done on the 3 axes. Only the highest levels are recorded.</p>	

TESTED CONFIGURATION	PARAMETER	SEVERITY	RESULT TAB.	VERDICT
EIRP / All Positions / Low channel	2.402GHz- 2.406GHz	30dBm	EMI6597	<b>PASS</b>
EIRP / All Positions / Mid channel	2.438GHz- 2.442GHz	30dBm	EMI6598	<b>PASS</b>
EIRP / All Positions / High channel	2.474GHz- 2.478GHz	30dBm	EMI6599	<b>PASS</b>

LABORATORY PARAMETERS:	REQUIRED PRIOR TO THE TEST	DURING THE TEST
Ambient Temperature	15 to 35 °C	See Graph(es)
Relative Humidity	20 to 75 %	See Graph(es)
Atmospheric pressure	N/A	See Graph(es)
<b>Test method deviation:</b> N/A		
Supplementary information: N/A		

TEST EQUIPMENT USED					
CATEGORY	BRAND	TYPE	IDENTIFIER	CAL. DATE	CAL. DUE
Antenna	ETS-Lindgren	3117	5456	24/07/2019	24/09/2022
Attenuator	EMITECH	SUB.V2-H	14495	13/01/2021	13/03/2022
Attenuator	EMITECH	SUB.V2-V	14496	13/01/2021	13/03/2022
Cable	MegaPhase	N-3m	14852	30/10/2018	30/06/2021
Cable	SUCOFLEX	N-5,5m	14381	25/06/2019	25/08/2021
Cable	Huber + Suhner	SF102K	16041	28/02/2019	28/04/2021
Receiver	Rohde & Schwarz	FSW43	14830	29/07/2020	29/09/2021
Shielded enclosure	RAY PROOF	C.V2	1423	04/10/2019	04/12/2022
Software	Nexio		0000		
Thermohygrometer	Testo	608-H1	7562	25/01/2019	25/03/2021
Thermohygrometer	Bioblock Scientific	Météostar	0963	25/01/2019	25/03/2021

Blank cells = Permanent validity

TEST SETUP PHOTO(S) - POSITION 1



TEST SETUP PHOTO(S) - POSITION 2



TEST SETUP PHOTO(S) - POSITION 3



TEST SETUP PHOTO(S) - EIRP

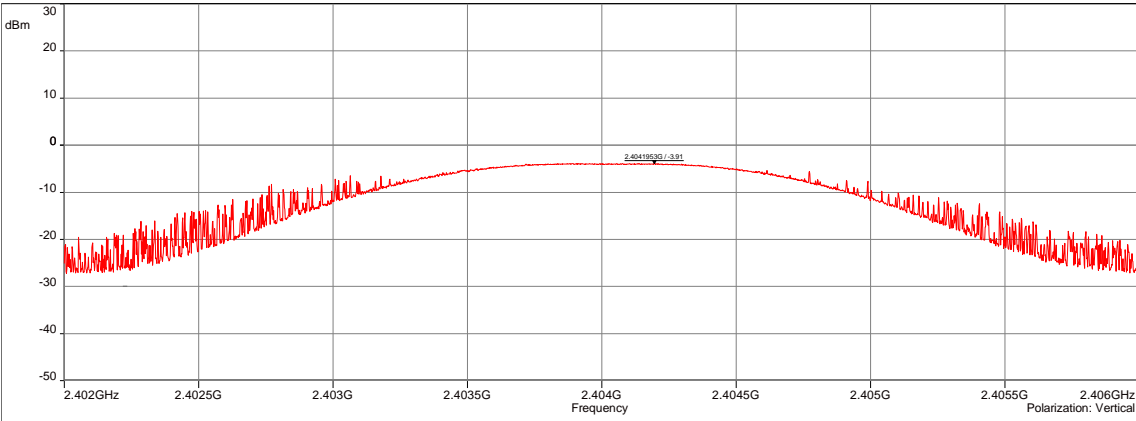
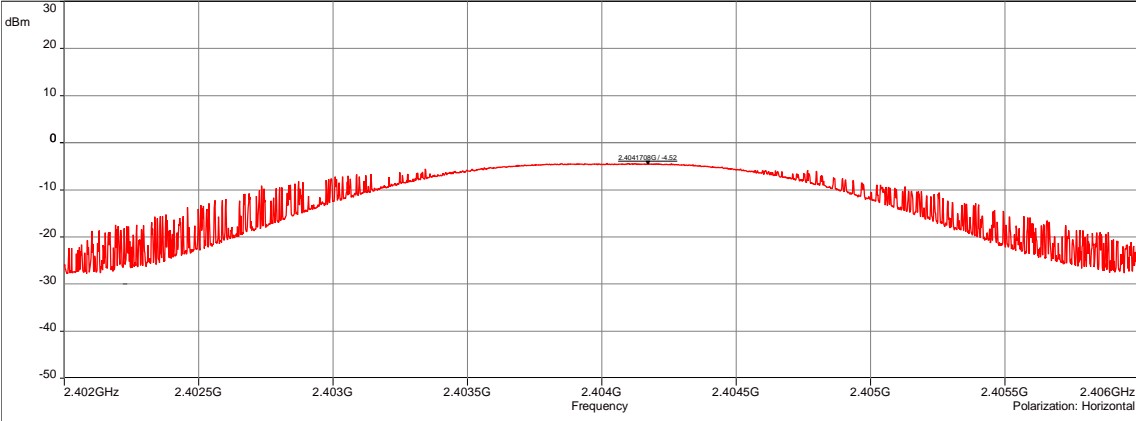

EFFECTIVE ISOTROPIC RADIATED POWER - GRAPH				
EIRP / ALL POSITIONS / LOW CHANNEL			EMI6597	
<b>EUT mode:</b>	Unmodulated		<b>T (°C):</b> 20.4	
<b>Test Date:</b>	23/02/2021		<b>H (%):</b> 51.3	
<b>Test Operator:</b>	ATO & OAT		<b>P (hPa):</b> 1024	
<p>Sub-range 1            Frequencies: 2.402 GHz - 2.406 GHz (Analyser mode) 8000 Points            Settings: RBW: 1MHz, VBW: 3MHz, Auto, Attenuation: 10 dB, Sweep count 1, Preamp: Off, LN Preamp: Off, Preselector: Off            Polarization: Vertical            Distance: 3 m</p>  <p>EIRP / All Positions / Low channel - 02/23/2021 08:41 - 6597</p> <p>Sub-range 2            Frequencies: 2.402 GHz - 2.406 GHz (Analyser mode) 8000 Points            Settings: RBW: 1MHz, VBW: 3MHz, Auto, Attenuation: 10 dB, Sweep count 1, Preamp: Off, LN Preamp: Off, Preselector: Off            Polarization: Horizontal            Distance: 3 m</p>  <p>EIRP / All Positions / Low channel - 02/23/2021 08:41 - 6597</p>				
POSITION	FREQUENCIES	RBW	VBW	DETECTOR
Vertical	2.402GHz-2.406GHz	1MHz	3MHz	Peak
Horizontal	2.402GHz-2.406GHz	1MHz	3MHz	Peak
<b>Configuration:</b>	N/A			
<b>Comments:</b>	N/A			
EUT modification(s): N/A				

EFFECTIVE ISOTROPIC RADIATED POWER - TABULATED RESULTS			
EIRP / ALL POSITIONS / LOW CHANNEL			EMI6597
Frequency (MHz)	Polarization	Level (dBm)	Limit (dBm)
2404.19	Vertical	-3.91	30
2404.17	Horizontal	-4.52	30

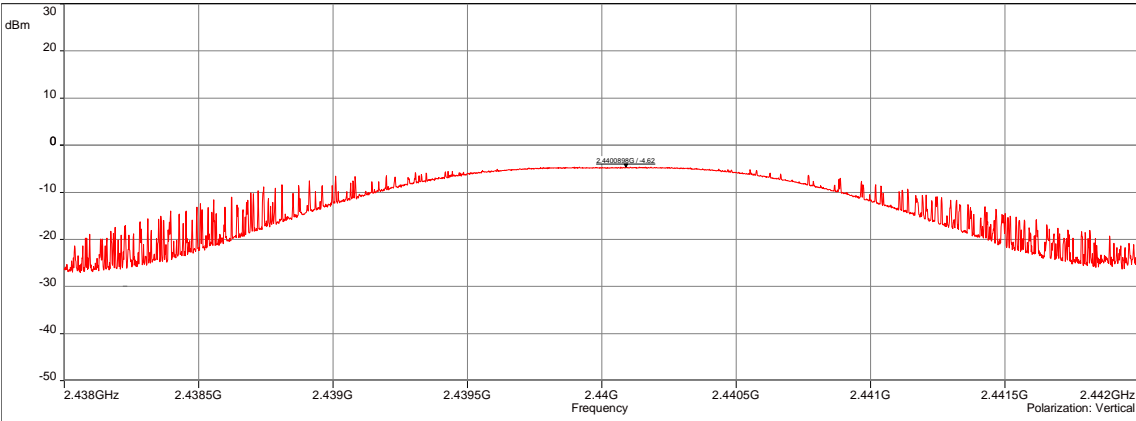
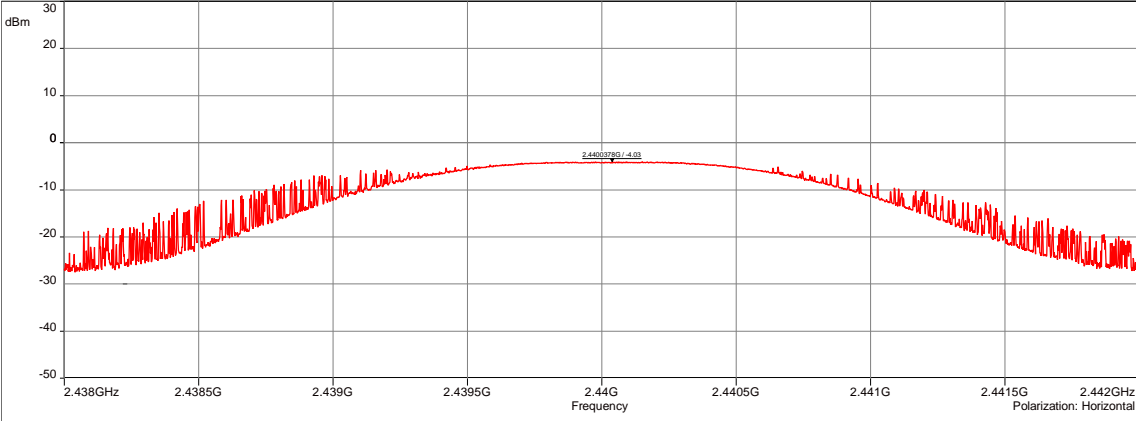

EFFECTIVE ISOTROPIC RADIATED POWER - GRAPH				
EIRP / ALL POSITIONS / MID CHANNEL			EMI6598	
<b>EUT mode:</b>	Unmodulated		<b>T (°C):</b> 20.4	
<b>Test Date:</b>	23/02/2021		<b>H (%):</b> 51.3	
<b>Test Operator:</b>	ATO & OAT		<b>P (hPa):</b> 1024	
<p>Sub-range 1            Frequencies: 2.438 GHz - 2.442 GHz (Analyser mode) 8000 Points            Settings: RBW: 1MHz, VBW: 3MHz, Auto, Attenuation: 10 dB, Sweep count 1, Preamp: Off, LN Preamp: Off, Preselector: Off            Polarization: Vertical            Distance: 3 m</p>  <p>EIRP / All Positions / Mid channel - 02/23/2021 08:51 - 6598</p> <p>Sub-range 2            Frequencies: 2.438 GHz - 2.442 GHz (Analyser mode) 8000 Points            Settings: RBW: 1MHz, VBW: 3MHz, Auto, Attenuation: 10 dB, Sweep count 1, Preamp: Off, LN Preamp: Off, Preselector: Off            Polarization: Horizontal            Distance: 3 m</p>  <p>EIRP / All Positions / Mid channel - 02/23/2021 08:51 - 6598</p>				
<b>POSITION</b>	<b>FREQUENCIES</b>	<b>RBW</b>	<b>VBW</b>	<b>DETECTOR</b>
Vertical	2.438GHz-2.442GHz	1MHz	3MHz	Peak
Horizontal	2.438GHz-2.442GHz	1MHz	3MHz	Peak
<b>Configuration:</b>	N/A			
<b>Comments:</b>	N/A			
EUT modification(s): N/A				

EFFECTIVE ISOTROPIC RADIATED POWER - TABULATED RESULTS			
EIRP / ALL POSITIONS / MID CHANNEL			EMI6598
Frequency (MHz)	Polarization	Level (dBm)	Limit (dBm)
2440.08	Vertical	-4.62	30
2440.03	Horizontal	-4.03	30

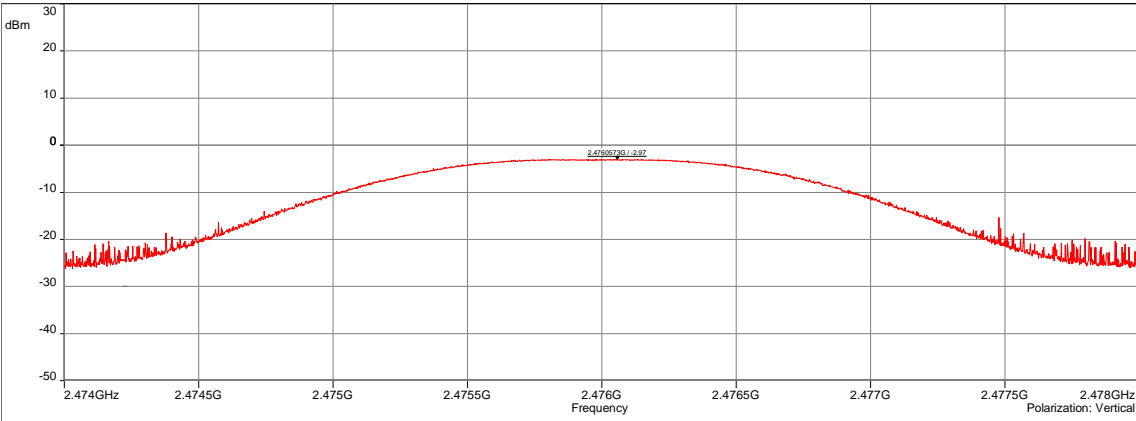
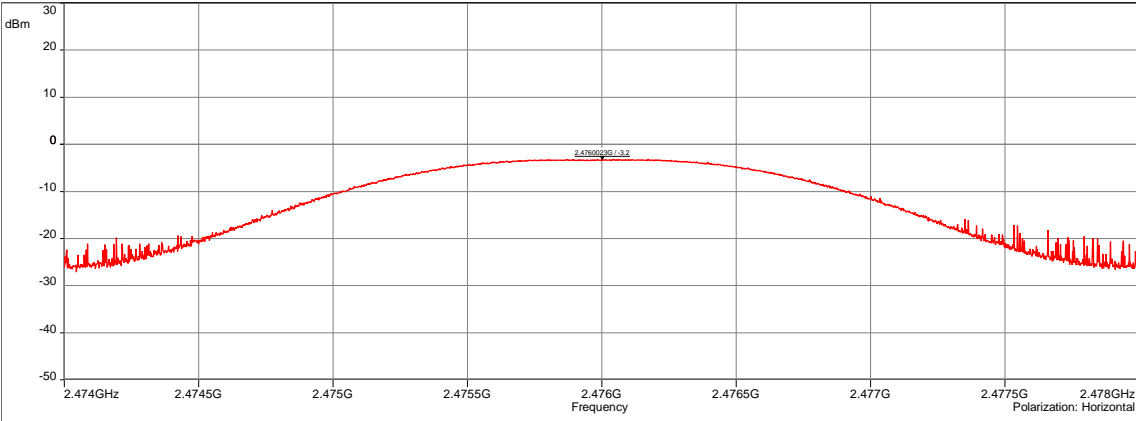
EFFECTIVE ISOTROPIC RADIATED POWER - GRAPH				
EIRP / ALL POSITIONS / HIGH CHANNEL			EMI6599	
<b>EUT mode:</b>	Unmodulated		<b>T (°C):</b> 20.4	
<b>Test Date:</b>	23/02/2021		<b>H (%):</b> 51.3	
<b>Test Operator:</b>	ATO & OAT		<b>P (hPa):</b> 1024	
<p>Sub-range 1            Frequencies: 2.474 GHz - 2.478 GHz (Analyser mode) 8000 Points            Settings: RBW: 1MHz, VBW: 3MHz, Auto, Attenuation: 10 dB, Sweep count 1, Preamp: Off, LN Preamp: Off, Preselector: Off            Polarization: Vertical            Distance: 3 m</p>  <p>EIRP / All Positions / High channel - 02/23/2021 09:01 - 6599</p> <p>Sub-range 2            Frequencies: 2.474 GHz - 2.478 GHz (Analyser mode) 8000 Points            Settings: RBW: 1MHz, VBW: 3MHz, Auto, Attenuation: 10 dB, Sweep count 1, Preamp: Off, LN Preamp: Off, Preselector: Off            Polarization: Horizontal            Distance: 3 m</p>  <p>EIRP / All Positions / High channel - 02/23/2021 09:01 - 6599</p>				
POSITION	FREQUENCIES	RBW	VBW	DETECTOR
Vertical	2.474GHz-2.478GHz	1MHz	3MHz	Peak
Horizontal	2.474GHz-2.478GHz	1MHz	3MHz	Peak
<b>Configuration:</b>	N/A			
<b>Comments:</b>	N/A			
EUT modification(s): N/A				

EFFECTIVE ISOTROPIC RADIATED POWER - TABULATED RESULTS			
EIRP / ALL POSITIONS / HIGH CHANNEL			EMI6599
Frequency (MHz)	Polarization	Level (dBm)	Limit (dBm)
2476.05	Vertical	-2.97	30
2476.00	Horizontal	-3.2	30

## 8.5. Band-edge compliance

<b>Reference standard:</b>	FCC part 15 Radio part 15.247 and RSS-247
<b>Test method:</b>	FCC part 15.247 subclause d) and RSS-247
<b>Test description: d)</b> In any 100 kHz bandwidth outside the frequency band in which the intentional radiator is operating, the radio frequency power that is produced by the intentional radiator shall be at least 20 dB below that in the 100 kHz bandwidth within the band that contains the highest level of the desired power, based on either an RF conducted or a radiated measurement, provided the transmitter demonstrates compliance with the peak conducted power limits. If the transmitter complies with the conducted power limits based on the use of RMS averaging over a time interval, the attenuation required under this paragraph shall be 30 dB instead of 20 dB. EUT is connected to the measuring receiver via 50Ω attenuator(s). Only the highest levels are recorded.	

TESTED CONFIGURATION	PARAMETER	SEVERITY	RESULT TAB.	VERDICT
All Positions / Low channel	2.38GHz-2.5GHz	>20dBc	EMI7328	<b>PASS</b>
All Positions / Mid channel	2.38GHz-2.5GHz	>20dBc	EMI7330	<b>PASS</b>
All Positions / High channel	2.38GHz-2.5GHz	>20dBc	EMI7332	<b>PASS</b>

LABORATORY PARAMETERS:	REQUIRED PRIOR TO THE TEST	DURING THE TEST
Ambient Temperature	15 to 35 °C	See Graph(es)
Relative Humidity	20 to 75 %	See Graph(es)
Atmospheric pressure	N/A	See Graph(es)
<b>Test method deviation: N/A</b>		
Supplementary information: N/A		

TEST EQUIPMENT USED					
CATEGORY	BRAND	TYPE	IDENTIFIER	CAL. DATE	CAL. DUE
Antenna	ETS-Lindgren	3117	5456	24/07/2019	24/09/2022
Cable	SUCOFLEX	N-3m	14379	25/06/2019	25/08/2021
Cable	SUCOFLEX	N-5,5m	14381	25/06/2019	25/08/2021
Cable	Huber + Suhner	SF102K	16041	28/02/2019	28/04/2021
Receiver	Rohde & Schwarz	FSW43	14830	29/07/2020	29/09/2021
Shielded enclosure	RAY PROOF	C.V2	1423	04/10/2019	04/12/2022
Software	Nexio		0000		
Thermohygrometer	Testo	608-H1	7562	25/01/2019	25/03/2021
Thermohygrometer	Bioblock Scientific	Météostar	0963	25/01/2019	25/03/2021

BAT-EMC software version: V3.18.0.26

Blank cells = Permanent validity

TEST SETUP PHOTO(S) - POSITION 1



TEST SETUP PHOTO(S) - POSITION 2



TEST SETUP PHOTO(S) - POSITION 3



TEST SETUP PHOTO(S) - BAND EDGE

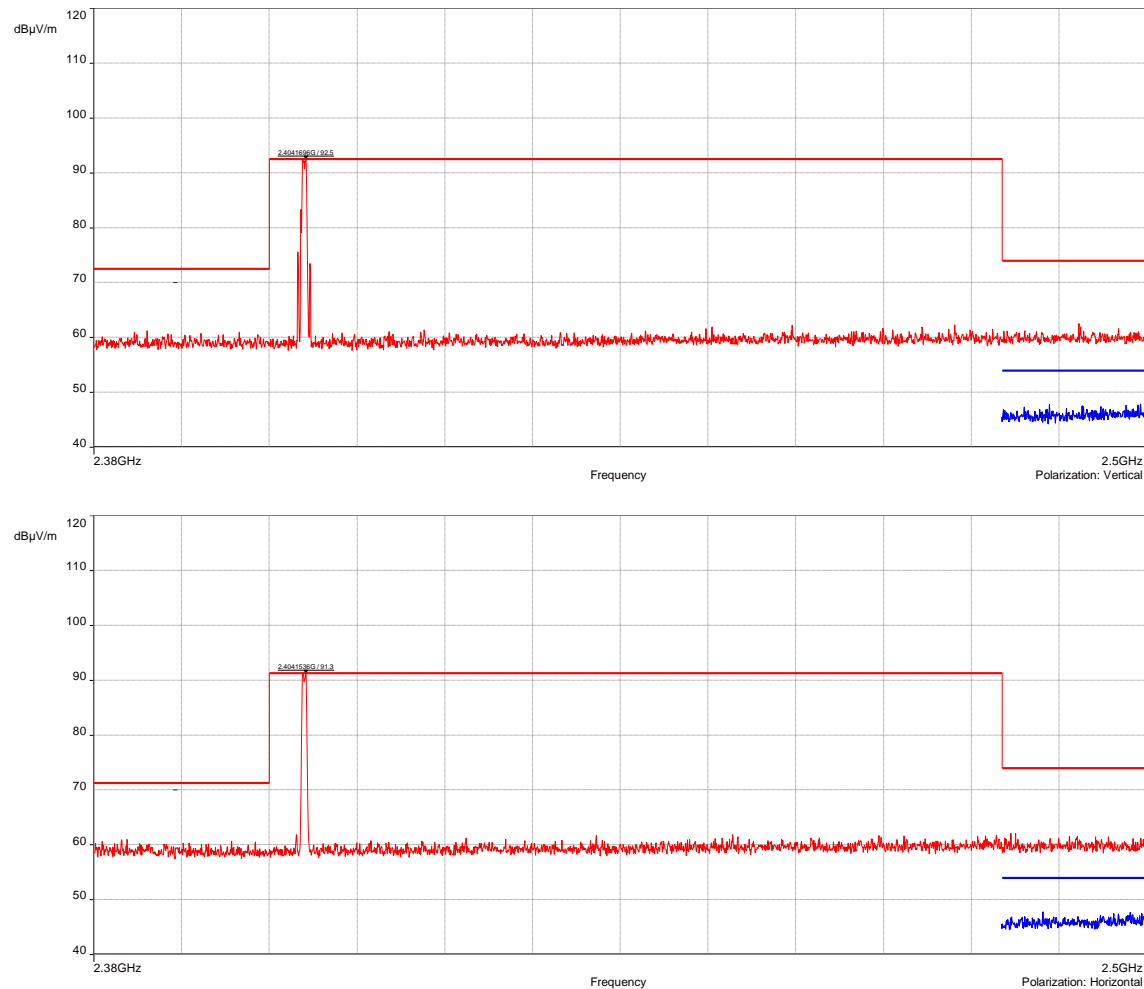

BAND EDGE - GRAPH					
ALL POSITIONS / LOW CHANNEL				EMI7328	
<b>EUT mode:</b>	Modulated			<b>T (°C):</b>	22.7
<b>Test Date:</b>	21/04/2021			<b>H (%):</b>	37.5
<b>Test Operator:</b>	ATO & OAT			<b>P (hPa):</b>	1010
					
POSITION	FREQUENCIES	RBW	VBW	DETECTOR	
Vertical	2.38GHz-2.5GHz	100kHz	300kHz	Peak	
Horizontal	2.38GHz-2.5GHz	100kHz	300kHz	Peak	
Vertical	2.48GHz-2.5GHz	100kHz	20kHz	Peak	
Horizontal	2.48GHz-2.5GHz	100kHz	20kHz	Peak	
<b>Configuration:</b>	N/A				
<b>Comments:</b>	N/A				
EUT modification(s): N/A					

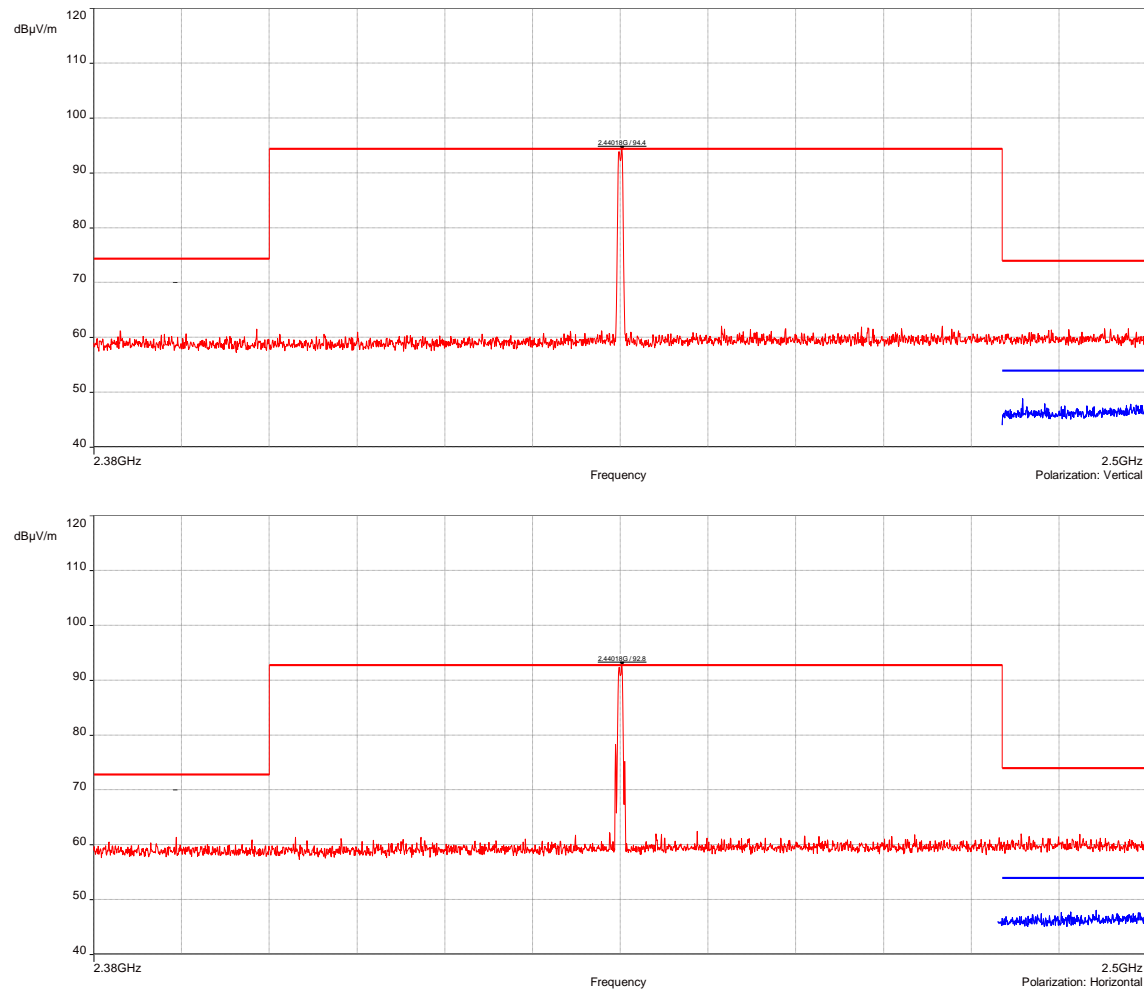
BAND EDGE - GRAPH				
ALL POSITIONS / MID CHANNEL			EMI7330	
<b>EUT mode:</b>	Modulated		<b>T (°C):</b>	22.7
<b>Test Date:</b>	21/04/2021		<b>H (%):</b>	37.5
<b>Test Operator:</b>	ATO & OAT		<b>P (hPa):</b>	1010
				
POSITION	FREQUENCIES	RBW	VBW	DETECTOR
Vertical	2.38GHz-2.5GHz	100kHz	300kHz	Peak
Horizontal	2.38GHz-2.5GHz	100kHz	300kHz	Peak
Vertical	2.48GHz-2.5GHz	100kHz	20kHz	Peak
Horizontal	2.48GHz-2.5GHz	100kHz	20kHz	Peak
<b>Configuration:</b>	N/A			
<b>Comments:</b>	N/A			
EUT modification(s): N/A				

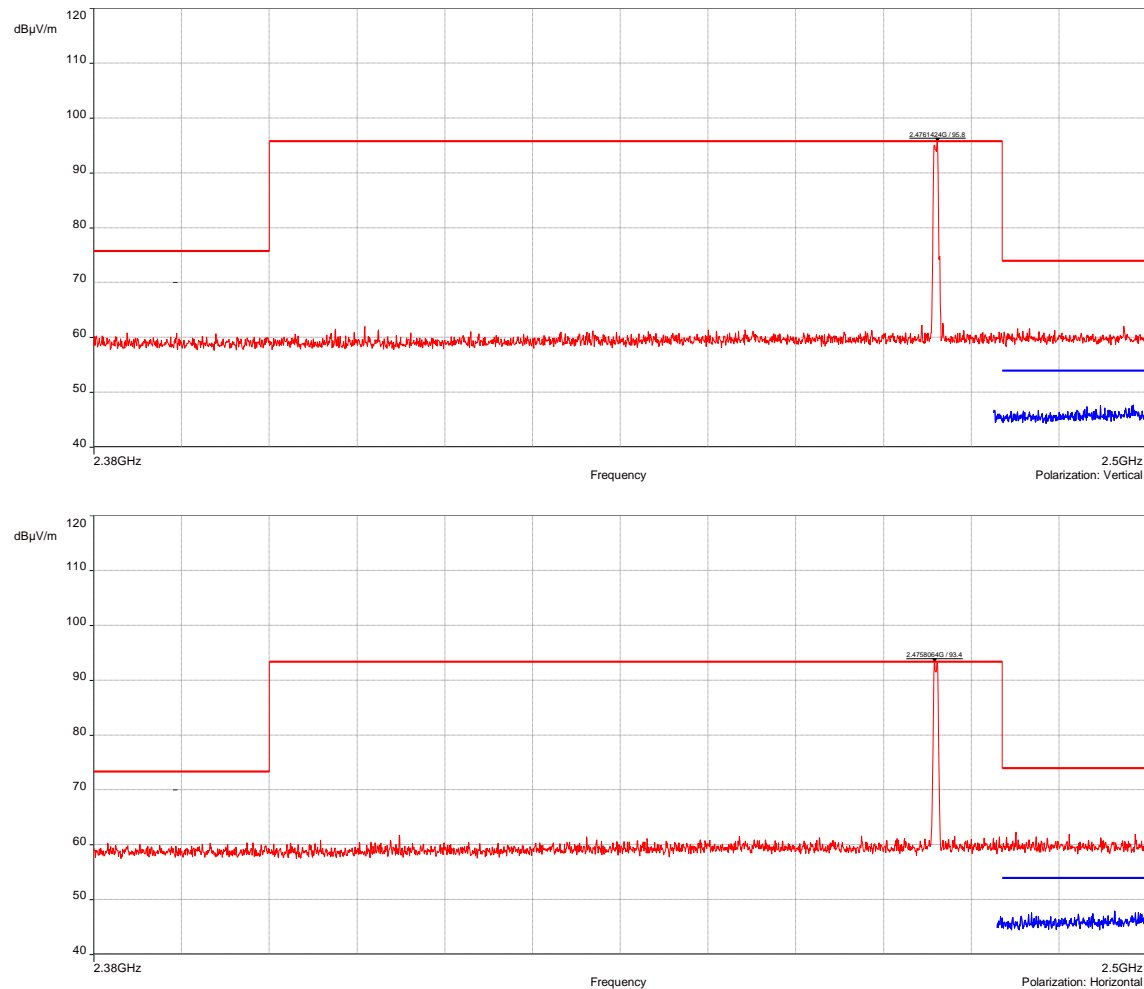
BAND EDGE - GRAPH					
ALL POSITIONS / HIGH CHANNEL				EMI7332	
<b>EUT mode:</b>	Modulated			<b>T (°C):</b>	22.7
<b>Test Date:</b>	21/04/2021			<b>H (%):</b>	37.5
<b>Test Operator:</b>	ATO & OAT			<b>P (hPa):</b>	1010
					
POSITION	FREQUENCIES	RBW	VBW	DETECTOR	
Vertical	2.38GHz-2.5GHz	100kHz	300kHz	Peak	
Horizontal	2.38GHz-2.5GHz	100kHz	300kHz	Peak	
Vertical	2.48GHz-2.5GHz	100kHz	20kHz	Peak	
Horizontal	2.48GHz-2.5GHz	100kHz	20kHz	Peak	
<b>Configuration:</b>	N/A				
<b>Comments:</b>	N/A				
EUT modification(s): N/A					



## 8.6. Power spectral density

<b>Reference standard:</b>	FCC part 15 Radio part 15.247 and RSS-247
<b>Test method:</b>	FCC part 15.247 and RSS-247
<b>Test description: e)</b> For digitally modulated systems, the power spectral density conducted from the intentional radiator to the antenna shall not be greater than 8 dBm in any 3 kHz band during any time interval of continuous transmission. This power spectral density shall be determined in accordance with the provisions of paragraph (b) of this section. The same method of determining the conducted output power shall be used to determine the power spectral density. EUT is connected to the measuring receiver via 50Ω attenuator(s). Only the highest levels are recorded.	

TESTED CONFIGURATION	PARAMETER	SEVERITY	RESULT TAB.	VERDICT
All Positions / Low channel	2.4035GHz- 2.4045GHz	8dBm/3kHz	EMI7324	<b>PASS</b>
All Positions / Mid channel	2.4395GHz- 2.4405GHz	8dBm/3kHz	EMI7325	<b>PASS</b>
All Positions / High channel	2.4755GHz- 2.4765GHz	8dBm/3kHz	EMI7326	<b>PASS</b>

LABORATORY PARAMETERS:	REQUIRED PRIOR TO THE TEST	DURING THE TEST
Ambient Temperature	15 to 35 °C	See Graph(s)
Relative Humidity	20 to 75 %	See Graph(s)
Atmospheric pressure	N/A	See Graph(s)
<b>Test method deviation: N/A</b>		
Supplementary information: N/A		

TEST EQUIPMENT USED					
CATEGORY	BRAND	TYPE	IDENTIFIER	CAL. DATE	CAL. DUE
Antenna	ETS-Lindgren	3117	5456	24/07/2019	24/09/2022
Attenuator	EMITECH	SUB.V2-H	14495	13/01/2021	13/03/2022
Attenuator	EMITECH	SUB.V2-V	14496	13/01/2021	13/03/2022
Cable	SUCOFLEX	N-3m	14379	25/06/2019	25/08/2021
Cable	MegaPhase	N-3m	14852	30/10/2018	30/06/2021
Cable	SUCOFLEX	N-5,5m	14381	25/06/2019	25/08/2021
Cable	Huber + Suhner	SF102K	16041	28/02/2019	28/04/2021
Receiver	Rohde & Schwarz	FSW43	14830	29/07/2020	29/09/2021
Shielded enclosure	RAY PROOF	C.V2	1423	04/10/2019	04/12/2022
Software	Nexio		0000		
Thermohygrometer	Testo	608-H1	7562	25/01/2019	25/03/2021
Thermohygrometer	Bioblock Scientific	Météostar	0963	25/01/2019	25/03/2021

BAT-EMC software version: V3.18.0.26

Blank cells = Permanent validity

TEST SETUP PHOTO(S) - POSITION 1



TEST SETUP PHOTO(S) - POSITION 2



TEST SETUP PHOTO(S) - POSITION 3



TEST SETUP PHOTO(S) - PSD

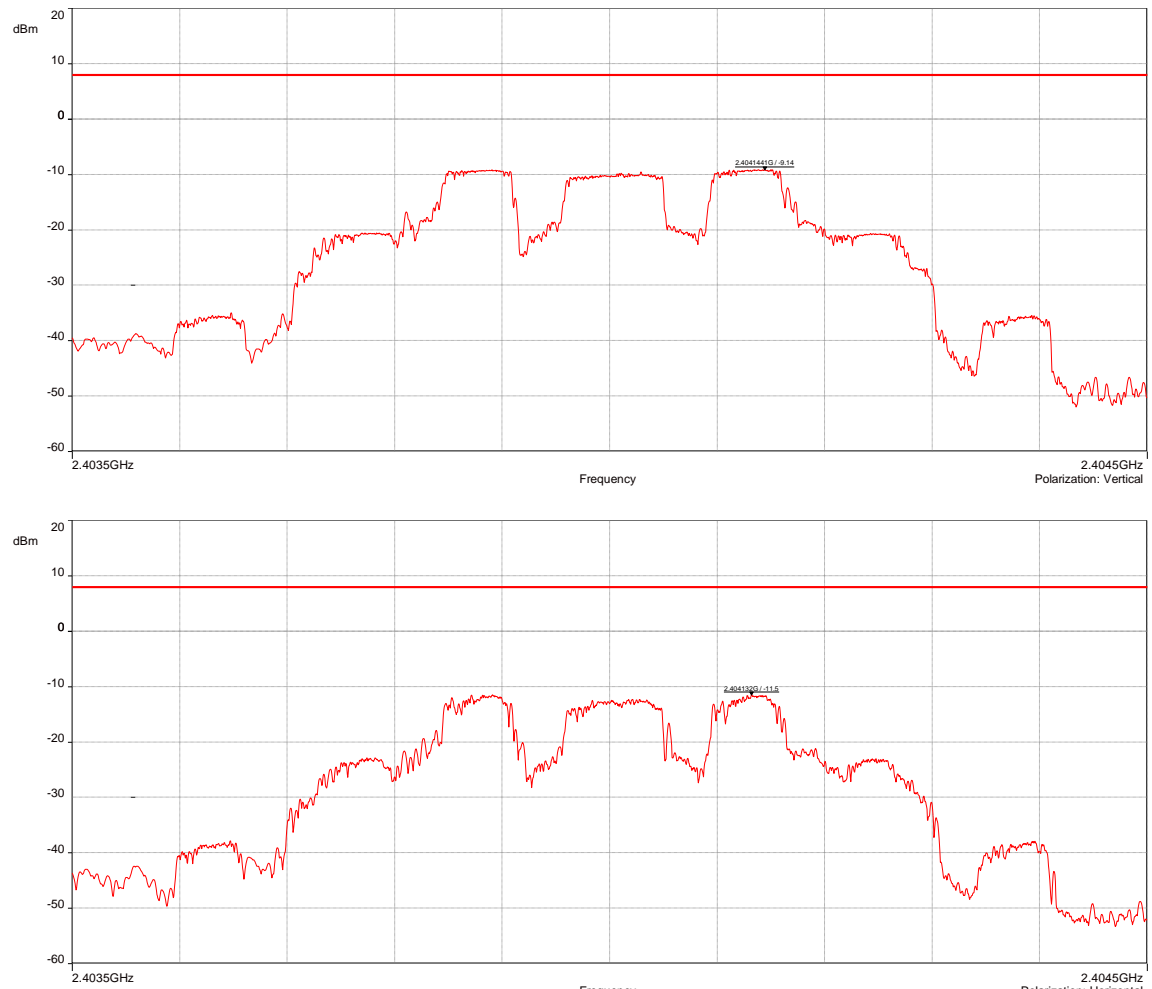

POWER SPECTRAL DENSITY - GRAPH					
ALL POSITIONS / LOW CHANNEL				EMI7324	
EUT mode:	Modulated			T (°C):	21.2
Test Date:	21/04/2021			H (%):	38.1
Test Operator:	ATO & OAT			P (hPa):	1010
					
POSITION	FREQUENCIES	RBW	VBW	DETECTOR	
Vertical	2.4035GHz-2.4045GHz	3kHz	9kHz	Peak	
Horizontal	2.4035GHz-2.4045GHz	3kHz	9kHz	Peak	
Configuration:	N/A				
Comments:	N/A				
EUT modification(s): N/A					

POWER SPECTRAL DENSITY - TABULATED RESULTS			
ALL POSITIONS / LOW CHANNEL			EMI7324
Frequency (MHz)	Polarization	Level (dBm)	Limit (dBm)
2404.14	Vertical	-9.14	8
2404.13	Horizontal	-11.5	8

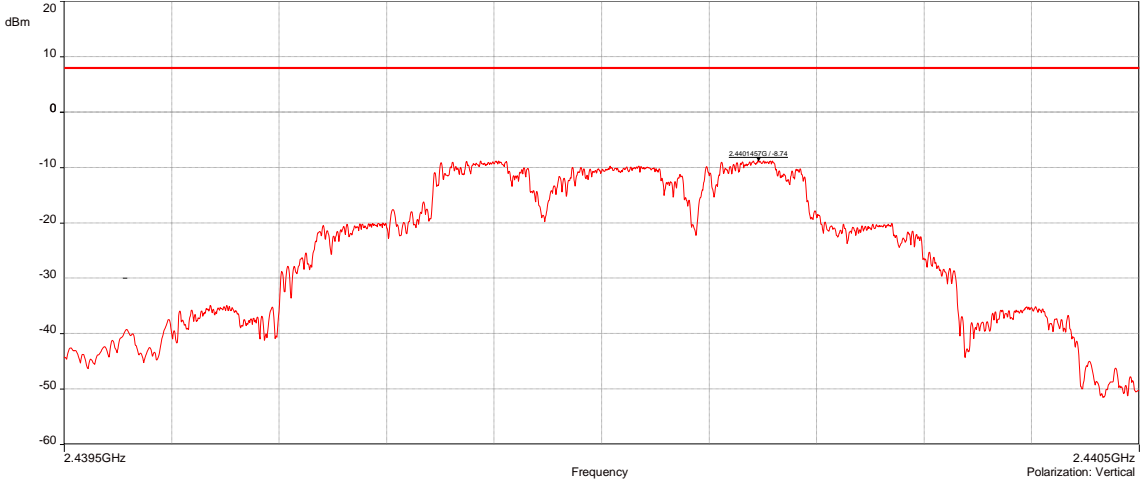
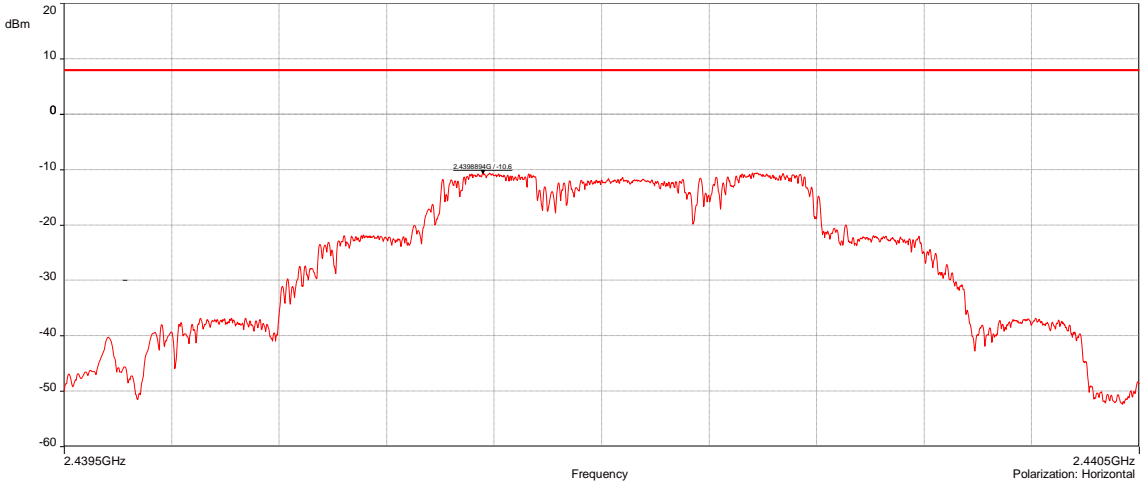
POWER SPECTRAL DENSITY - GRAPH					
PSD / ALL POSITIONS / MID CHANNEL				EMI7325	
EUT mode:	Modulated			T (°C):	21.2
Test Date:	21/04/2021			H (%):	38.1
Test Operator:	ATO & OAT			P (hPa):	1010
					Polarization: Vertical
					Polarization: Horizontal
POSITION	FREQUENCIES	RBW	VBW	DETECTOR	
Vertical	2.4395GHz-2.4405GHz	3kHz	9kHz	Peak	
Horizontal	2.4395GHz-2.4405GHz	3kHz	9kHz	Peak	
Configuration:	N/A				
Comments:	N/A				
EUT modification(s): N/A					

POWER SPECTRAL DENSITY - TABULATED RESULTS			
PSD / ALL POSITIONS / MID CHANNEL			EMI7325
Frequency (MHz)	Polarization	Level (dBm)	Limit (dBm)
2440.14	Vertical	-8.74	8
2439.88	Horizontal	-10.6	8

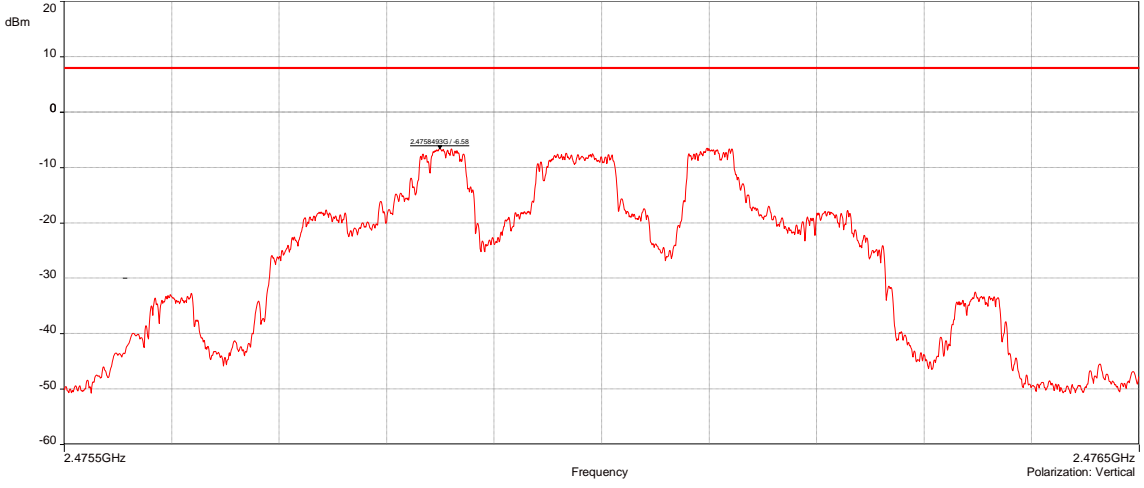
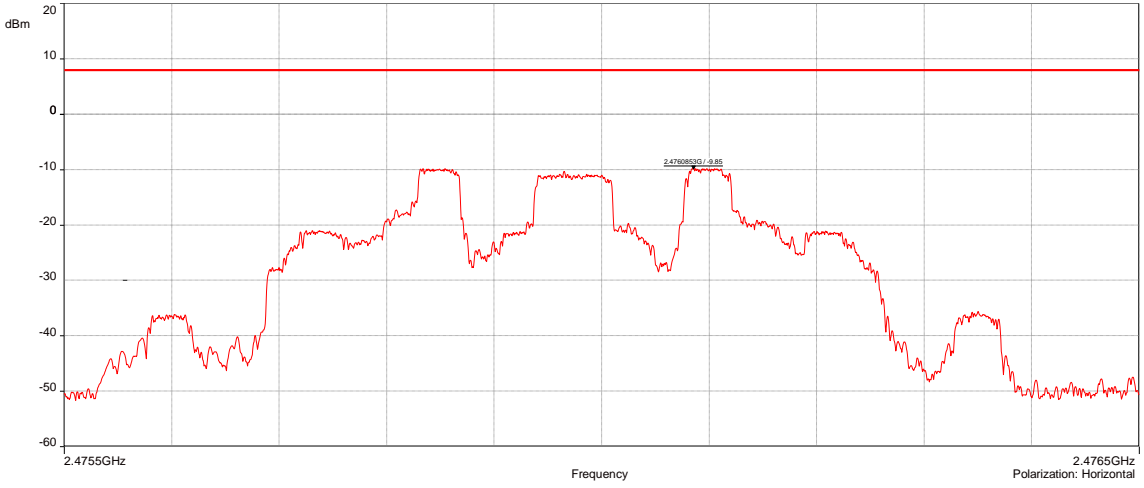
POWER SPECTRAL DENSITY - GRAPH					
ALL POSITIONS / HIGH CHANNEL				EMI7326	
EUT mode:	Modulated			T (°C):	21.2
Test Date:	03/03/2021			H (%):	38.1
Test Operator:	ATO & OAT			P (hPa):	1010
					
					
POSITION	FREQUENCIES	RBW	VBW	DETECTOR	
Vertical	2.4755GHz-2.4765GHz	3kHz	9kHz	Peak	
Horizontal	2.4755GHz-2.4765GHz	3kHz	9kHz	Peak	
Configuration:	N/A				
Comments:	N/A				
EUT modification(s): N/A					

POWER SPECTRAL DENSITY - TABULATED RESULTS			
ALL POSITIONS / HIGH CHANNEL			EMI7326
Frequency (MHz)	Polarization	Level (dBm)	Limit (dBm)
2475.84	Vertical	-6.58	8
2476.08	Horizontal	-9.85	8

## 8.7. Transmitter radiated spurious emissions at frequencies <30MHz

<b>Reference standard:</b>	FCC part 15 Radio part 15.247 and RSS-247
<b>Test method:</b>	FCC part 15.109, 15.209, 15.205, 15.215 RSS-247, CNR Gen
<p><b>General test setup:</b> Spurious domain emission limits are limits on emissions at frequencies other than those of the carrier and sidebands associated with normal test modulation.</p> <p>EUT is set on an insulating support at 80cm above the ground reference plane.</p> <p>Preliminary (peak) measurements were performed at an antenna to EUT separation distance of 3-meter in a anechoic chamber. The EUT was rotated 360° in order to maximize radiated levels. Test antenna was oriented in 3 axes (0°, 45° and 90°).</p> <p>Final measurements (quasi-peak) were then performed in a 10-meter Open Area Test Site that complies to CISPR 16 in the same measurement conditions.</p> <p>All frequencies were investigated, where applicable.</p>	

TESTED CONFIGURATION	PARAMETER	SEVERITY	RESULT TAB.	VERDICT
Tx mode / All positions / All channels / 0°	9kHz-30MHz	Tx	EMI7056	<b>PASS</b>
Tx mode / All positions / All channels / 45°	9kHz-30MHz	Tx	EMI7057	<b>PASS</b>
Tx mode / All positions / All channels / 90°	9kHz-30MHz	Tx	EMI7058	<b>PASS</b>
Charging + Tx mode / All positions / All channels / 0°	9kHz-30MHz	Tx	EMI7063	<b>PASS</b>
Charging + Tx mode / All positions / All channels / 45°	9kHz-30MHz	Tx	EMI7064	<b>PASS</b>
Charging + Tx mode / All positions / All channels / 45°	9kHz-30MHz	Tx	EMI7065	<b>PASS</b>

LABORATORY PARAMETERS:	REQUIRED PRIOR TO THE TEST	DURING THE TEST
Ambient Temperature	15 to 35 °C	See Graph(es)
Relative Humidity	20 to 75 %	See Graph(es)
Atmospheric pressure	N/A	See Graph(es)

**Test method deviation:** N/A

Supplementary information:

From 9 kHz to 30MHz: limit indicated on the curves is calculated with 40 dB/decade extrapolation factor and 51.5 dB conversion factor.

TEST EQUIPMENT USED					
CATEGORY	BRAND	TYPE	IDENTIFIER	CAL. DATE	CAL. DUE
Antenna	Rohde & Schwarz	HFH2-Z2	5825	24/04/2020	24/06/2022
Cable	MegaPhase	N-3m	14853	12/05/2020	12/07/2022
Cable	Huber + Suhner	SF102K	16041	28/02/2019	28/04/2021
Cable	MegaPhase	TM18-N1N1-197	12840	14/08/2020	14/10/2022
Receiver	Rohde & Schwarz	FSW43	14830	29/07/2020	29/09/2021
Shielded enclosure	RAY PROOF	C.V2	1423	04/10/2019	04/12/2022
Software	Nexio		0000		
Thermohygrometer	Testo	608-H1	7562	25/01/2019	25/03/2021
Thermohygrometer	Bioblock Scientific	Météostar	0963	25/01/2019	25/03/2021

BAT-EMC software version: V3.18.0.26

Blank cells = Permanent validity



TEST SETUP PHOTO(S) -EUT POSITIONS

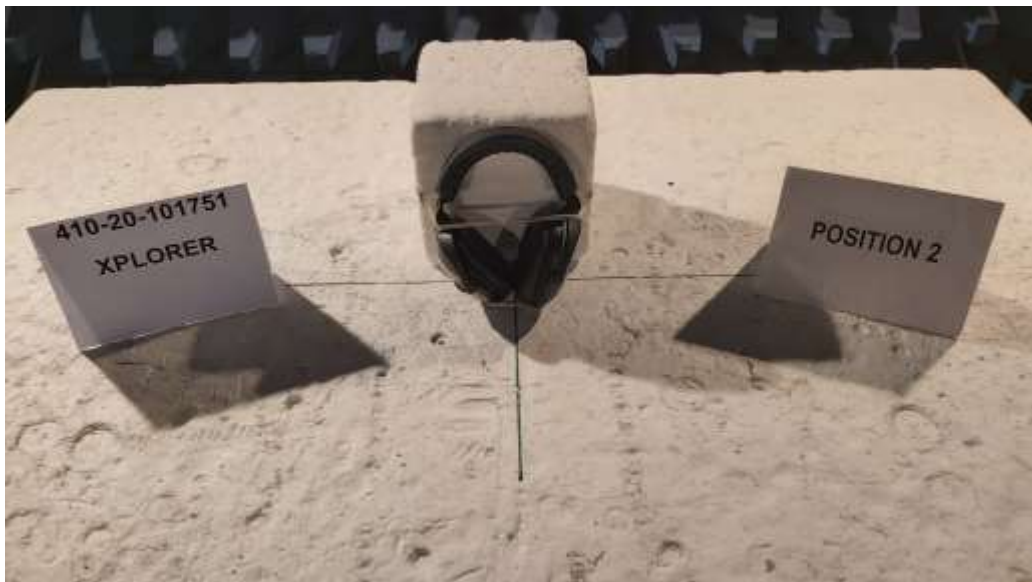
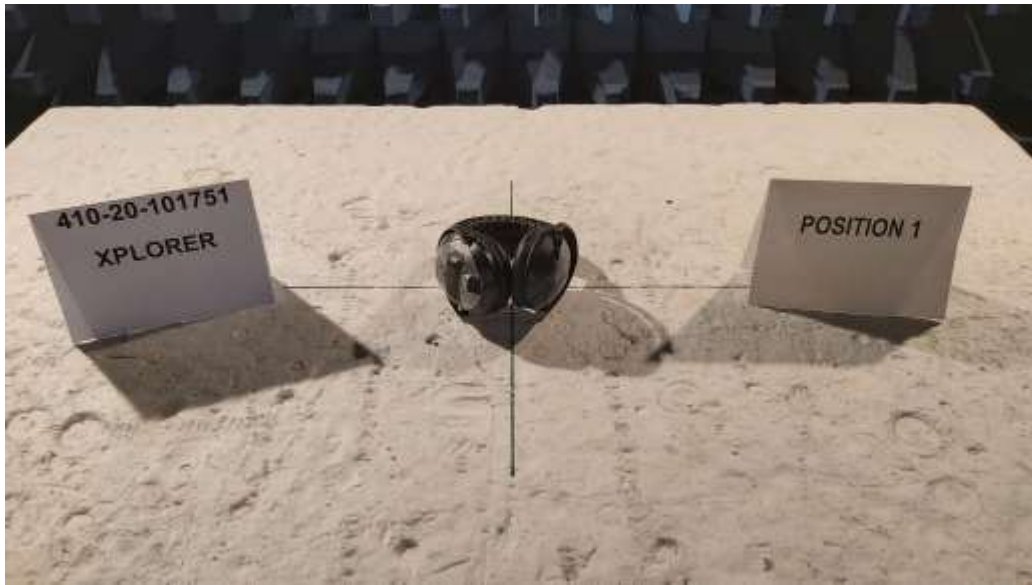

TEST SETUP PHOTO(S)

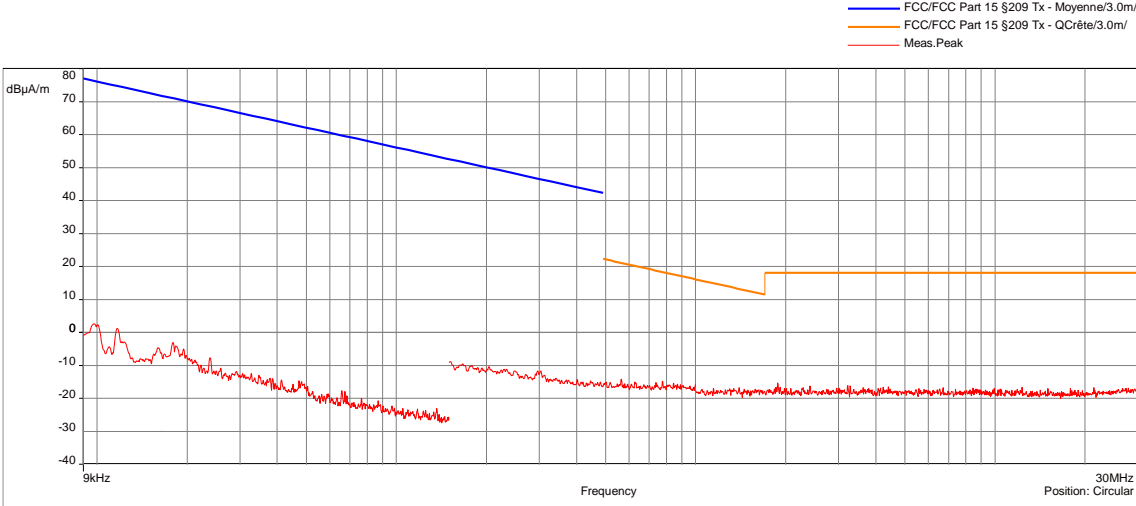

TRANSMITTER RADIATED SPURIOUS EMISSIONS AT FREQUENCIES <30MHz - GRAPH					
TX MODE / ALL POSITIONS / ALL CHANNELS / 0°				EMI7056	
EUT mode:	Modulated			T (°C):	21.6
Test Date:	26/03/2021			H (%):	36.7
Test Operator:	ATO & OAT			P (hPa):	1014
 <p>Legend:  <span style="color: blue;">—</span> FCC/FCC Part 15 §209 Tx - Moyenne/3.0m/  <span style="color: orange;">—</span> FCC/FCC Part 15 §209 Tx - QCrête/3.0m/  <span style="color: red;">—</span> Meas.Peak</p>					
POSITION	FREQUENCIES	RBW	VBW	DETECTOR	
Circular	9kHz-150kHz	300Hz	1kHz	Peak	
Circular	150kHz-1MHz	10kHz	30kHz	Peak	
Circular	1MHz-30MHz	10kHz	30kHz	Peak	
Configuration:	N/A				
Comments:	Limit indicated on these plots are calculated with 40 dB/decade extrapolation factor and 51.5dB conversion factor.				
EUT modification(s): N/A					

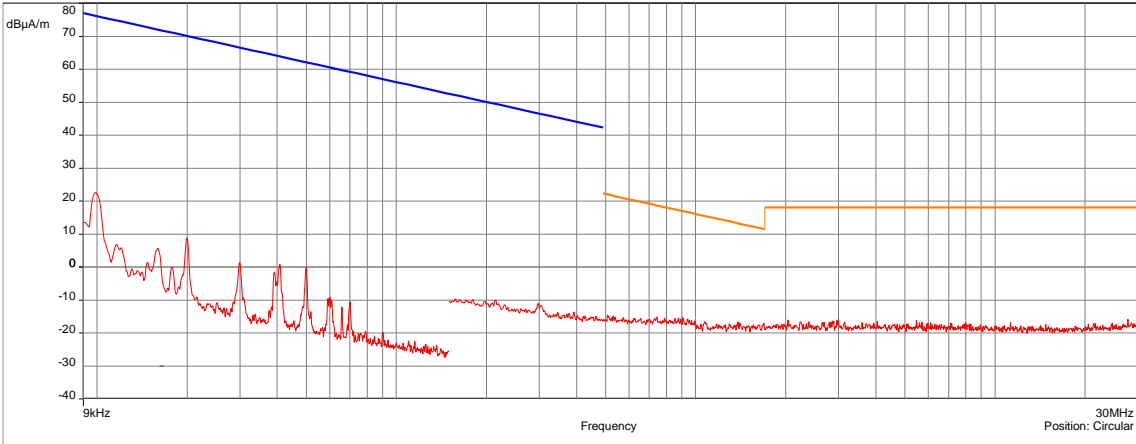
TRANSMITTER RADIATED SPURIOUS EMISSIONS AT FREQUENCIES <30MHZ - GRAPH					
TX MODE / ALL POSITIONS / ALL CHANNELS / 45°				EMI7057	
<b>EUT mode:</b>	Modulated			<b>T (°C):</b>	21.6
<b>Test Date:</b>	26/03/2021			<b>H (%):</b>	36.7
<b>Test Operator:</b>	ATO & OAT			<b>P (hPa):</b>	1014
					
POSITION	FREQUENCIES	RBW	VBW	DETECTOR	
Circular	9kHz-150kHz	300Hz	1kHz	Peak	
Circular	150kHz-1MHz	10kHz	30kHz	Peak	
Circular	1MHz-30MHz	10kHz	30kHz	Peak	
<b>Configuration:</b>	N/A				
<b>Comments:</b>	Limit indicated on these plots are calculated with 40 dB/decade extrapolation factor and 51.5dB conversion factor				
EUT modification(s): N/A					

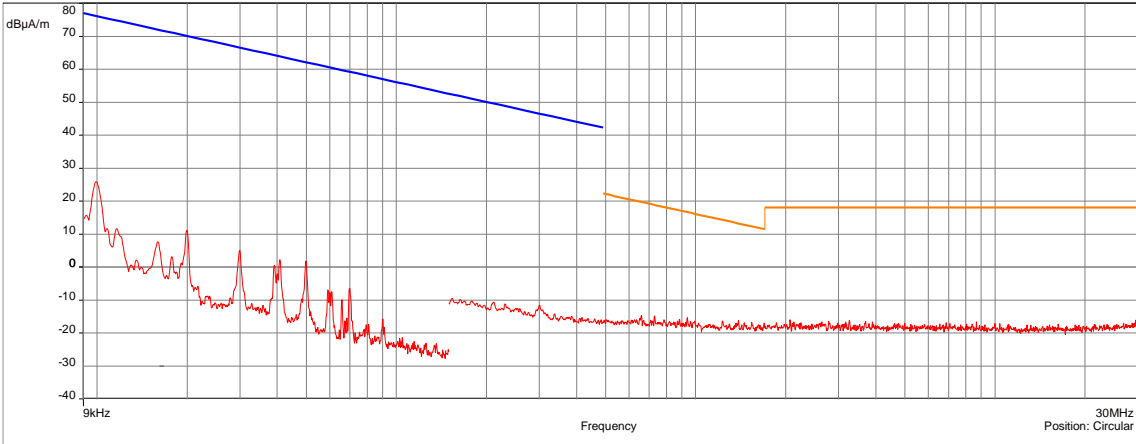
TRANSMITTER RADIATED SPURIOUS EMISSIONS AT FREQUENCIES <30MHZ - GRAPH					
TX MODE / ALL POSITIONS / ALL CHANNELS / 90°				EMI7058	
EUT mode:	Modulated			T (°C):	21.6
Test Date:	26/03/2021			H (%):	36.7
Test Operator:	ATO & OAT			P (hPa):	1014
					
POSITION	FREQUENCIES	RBW	VBW	DETECTOR	
Circular	9kHz-150kHz	300Hz	1kHz	Peak	
Circular	150kHz-1MHz	10kHz	30kHz	Peak	
Circular	1MHz-30MHz	10kHz	30kHz	Peak	
Configuration:	N/A				
Comments:	Limit indicated on these plots are calculated with 40 dB/decade extrapolation factor and 51.5dB conversion factor.				
EUT modification(s): N/A					

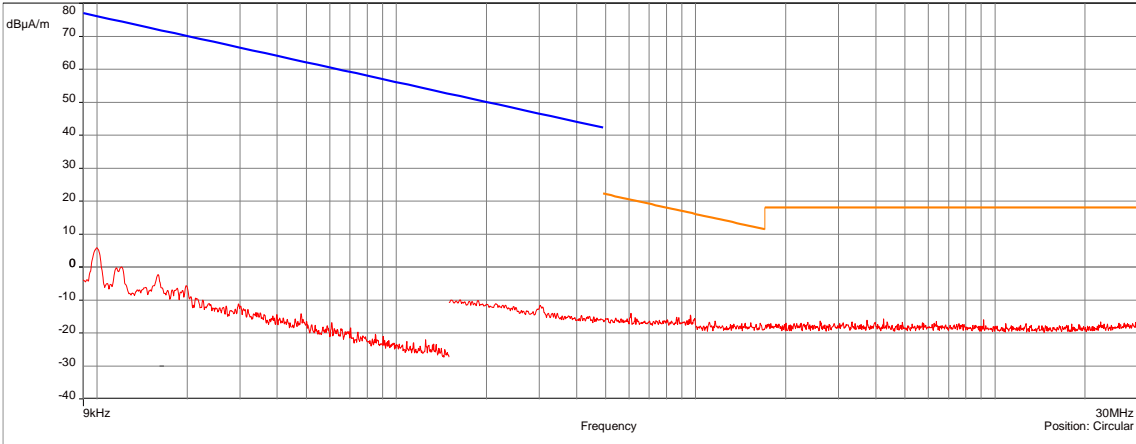
TRANSMITTER RADIATED SPURIOUS EMISSIONS AT FREQUENCIES <30MHz - GRAPH					
CHARGING + Tx MODE / ALL POSITIONS / ALL CHANNELS / 0°				EMI7063	
<b>EUT mode:</b>	Modulated			<b>T (°C):</b>	22.8
<b>Test Date:</b>	26/03/2021			<b>H (%):</b>	36.0
<b>Test Operator:</b>	ATO & OAT			<b>P (hPa):</b>	1014
<div style="text-align: right; font-size: small;"> <span style="color: blue;">—</span> FCC/FCC Part 15 §209 Tx - Moyenne/3.0m/  <span style="color: orange;">—</span> FCC/FCC Part 15 §209 Tx - QCrête/3.0m/  <span style="color: red;">—</span> Meas.Peak                 </div> 					
POSITION	FREQUENCIES	RBW	VBW	DETECTOR	
Circular	9kHz-150kHz	300Hz	1kHz	Peak	
Circular	150kHz-1MHz	10kHz	30kHz	Peak	
Circular	1MHz-30MHz	10kHz	30kHz	Peak	
<b>Configuration:</b>	N/A				
<b>Comments:</b>	Limit indicated on these plots are calculated with 40 dB/decade extrapolation factor and 51.5dB conversion factor.				
EUT modification(s): N/A					

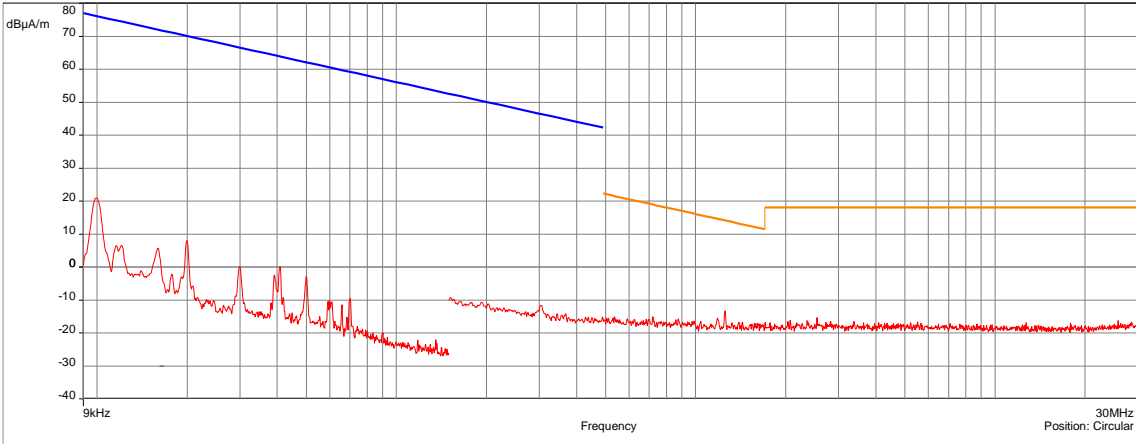
TRANSMITTER RADIATED SPURIOUS EMISSIONS AT FREQUENCIES <30MHz - GRAPH					
CHARGING + TX MODE / ALL POSITIONS / ALL CHANNELS / 45°				EMI7064	
<b>EUT mode:</b>	Modulated			<b>T (°C):</b>	22.8
<b>Test Date:</b>	26/03/2021			<b>H (%):</b>	36.0
<b>Test Operator:</b>	ATO & OAT			<b>P (hPa):</b>	1014
— FCC/FCC Part 15 §209 Tx - Moyenne/3.0m/ — FCC/FCC Part 15 §209 Tx - QCrête/3.0m/ — Meas.Peak					
					
<b>POSITION</b>	<b>FREQUENCIES</b>	<b>RBW</b>	<b>VBW</b>	<b>DETECTOR</b>	
Circular	9kHz-150kHz	300Hz	1kHz	Peak	
Circular	150kHz-1MHz	10kHz	30kHz	Peak	
Circular	1MHz-30MHz	10kHz	30kHz	Peak	
<b>Configuration:</b>	N/A				
<b>Comments:</b>	Limit indicated on these plots are calculated with 40 dB/decade extrapolation factor and 51.5dB conversion factor.				
EUT modification(s): N/A					

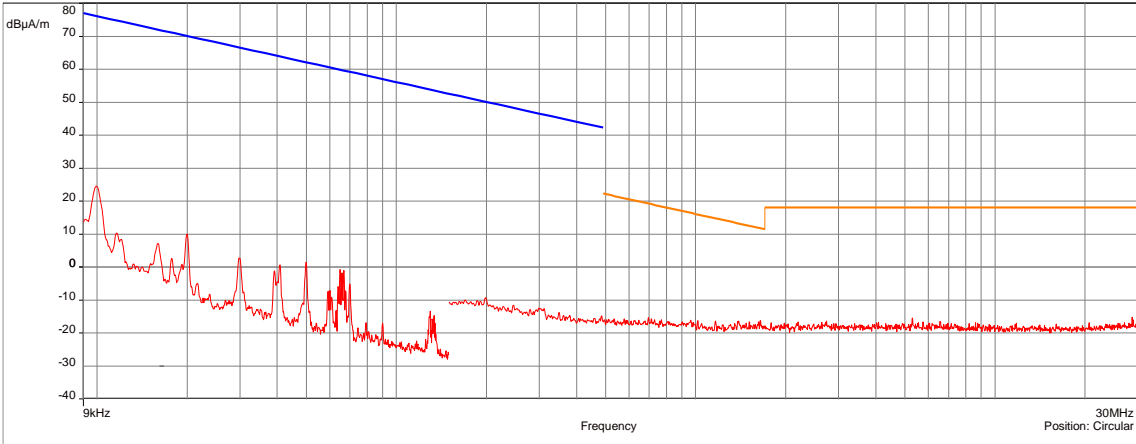
TRANSMITTER RADIATED SPURIOUS EMISSIONS AT FREQUENCIES <30MHz - GRAPH					
CHARGING + Tx MODE / ALL POSITIONS / ALL CHANNELS / 9°				EMI7065	
EUT mode:	Modulated			T (°C):	22.8
Test Date:	26/03/2021			H (%):	36.0
Test Operator:	ATO & OAT			P (hPa):	1014
					
POSITION	FREQUENCIES	RBW	VBW	DETECTOR	
Circular	9kHz-150kHz	300Hz	1kHz	Peak	
Circular	150kHz-1MHz	10kHz	30kHz	Peak	
Circular	1MHz-30MHz	10kHz	30kHz	Peak	
Configuration:	N/A				
Comments:	Limit indicated on these plots are calculated with 40 dB/decade extrapolation factor and 51.5dB conversion factor.				
EUT modification(s): N/A					



## 8.8. Transmitter radiated spurious emissions at frequencies >30MHz

<b>Reference standard:</b>	FCC part 15 Radio part 15.209 & CNR-Gen
<b>Test method:</b>	FCC part 15.109, 15.209, 15.205, 15.215, CNR-Gen
<p><b>General test setup:</b> EUT is set on an insulating support at 80cm above the ground reference plane.</p> <p>Preliminary (peak) measurements were performed at an antenna to EUT separation distance of 3-meter. The EUT was rotated 360° about its azimuth with the receive antenna located at various heights in horizontal and vertical polarities.</p> <p>Final measurements (quasi-peak or average) were then performed in a semi-anechoic chamber or Open Area Test Site that complies to CISPR 16. The EUT was rotated 360° about its azimuth and adjusting the receive antenna height from 1 to 4 m.</p> <p>All frequencies were investigated, where applicable.</p> <p>For portable equipments a research of maximum level is done on the 3 axes. Only the highest levels are recorded.</p>	

TESTED CONFIGURATION	PARAMETER	SEVERITY	RESULT TAB.	VERDICT
Tx mode / All Positions / All Channels / For freq <1GHz	30MHz-1GHz	15.209	EMI7259	<b>PASS</b>
Charging + Tx mode / All Positions / All Channels / For freq <1GHz	30MHz-1GHz	15.209	EMI7260	<b>PASS</b>
Tx mode / All Positions / Low channel / 1GHz to 18GHz	1GHz-18GHz	15.209	EMI7194	<b>PASS</b>
Tx mode / All Positions / Mid channel / 1GHz to 18GHz	1GHz-18GHz	15.209	EMI7195	<b>PASS</b>
Tx mode / All Positions / High channel / 1GHz to 18GHz	1GHz-18GHz	15.209	EMI7196	<b>PASS</b>
Charging + Tx mode / All Positions / Low channel / 1GHz to 18GHz	1GHz-18GHz	15.209	EMI7206	<b>PASS</b>
Charging + Tx mode / All Positions / Mid channel / 1GHz to 18GHz	1GHz-18GHz	15.209	EMI7207	<b>PASS</b>
Charging + Tx mode / All Positions / High channel / 1GHz to 18GHz	1GHz-18GHz	15.209	EMI7208	<b>PASS</b>
Tx mode / All Positions / Low channel / 18GHz to 26.5GHz	18GHz-26.5GHz	15.209	EMI7246	<b>PASS</b>
Tx mode / All Positions / Mid channel / 18GHz to 26.5GHz	18GHz-26.5GHz	15.209	EMI7247	<b>PASS</b>
Tx mode / All Positions / High channel / 18GHz to 26.5GHz	18GHz-26.5GHz	15.209	EMI7248	<b>PASS</b>
Charging + Tx mode / All Positions / Low channel / 18GHz to 26.5GHz	18GHz-26.5GHz	15.209	EMI7286	<b>PASS</b>
Charging + Tx mode / All Positions / Mid channel / 18GHz to 26.5GHz	18GHz-26.5GHz	15.209	EMI7287	<b>PASS</b>
Charging + Tx mode / All Positions / High channel / 18GHz to 26.5GHz	18GHz-26.5GHz	15.209	EMI7288	<b>PASS</b>

LABORATORY PARAMETERS:	REQUIRED PRIOR TO THE TEST	DURING THE TEST
Ambient Temperature	15 to 35 °C	<i>See Graph(s)</i>
Relative Humidity	20 to 75 %	<i>See Graph(s)</i>
Atmospheric pressure	N/A	<i>See Graph(s)</i>
<b>Test method deviation:</b> N/A		
Supplementary information: N/A		

TEST EQUIPMENT USED					
CATEGORY	BRAND	TYPE	IDENTIFIER	CAL. DATE	CAL. DUE
Antenna	ETS-Lindgren	3117	5456	24/07/2019	24/09/2022
Antenna	ETS lindgren	3160-09	14690	26/09/2017	26/05/2021
Antenna	Electro Metrics	BIA-30HF	0824	13/06/2018	13/08/2021
Antenna	Rohde & Schwarz	HL223	3126	13/06/2018	13/08/2021
Cable	MegaPhase	F135N1N28	16664	25/10/2019	25/12/2021
Cable	MegaPhase	F135N1N28	16666	25/10/2019	25/12/2021
Cable	JYE BAO	K30K30-5003-40G1	14887	25/06/2019	25/08/2021
Cable	Huber + Suhner	K-5m	14460	25/06/2019	25/08/2021
Cable	C&C	N-1.5m	10554	20/12/2019	20/02/2022
Cable	/	N-1m	3625	27/01/2021	27/03/2023
Cable	/	N-1m	3626	27/01/2021	27/03/2023
Cable	SUCOFLEX	N-3m	14379	25/06/2019	25/08/2021
Cable	MegaPhase	N-3m	14852	29/10/2018	29/12/2020
Cable	MegaPhase	N-3m	14852	30/10/2018	30/06/2021
Cable	SUCOFLEX	N-5,5m	14381	25/06/2019	25/08/2021
Cable	SUCOFLEX	N-6,5m	14380	25/07/2019	25/09/2021
Cable	MegaPhase	N-8m	15813	12/11/2018	12/01/2021
Cable	MegaPhase	N-8m	15813	14/01/2021	14/03/2023
Cable	Huber + Suhner	SF102K	16041	28/02/2019	28/04/2021
Cable	MegaPhase	TM18-N1N1-118	12841	14/08/2020	14/10/2022
Cable	MegaPhase	TM18-N1N1-118	12842	02/12/2020	02/02/2023
Filter	Micro-Tronics	HPM 15162	10273	12/01/2019	12/03/2022
Filter	Micro-Tronics	HPM18865	12843	09/06/2018	09/08/2021
Filter	Wainwright Instruments	WRCGV 2402/2480- 2380/2500- 40/10EE-200W	9771	08/01/2019	08/03/2022
Preamplifier	Techniwave	APS16-0087	14040	02/12/2020	02/02/2022
Preamplifier	Wright Technologie	ASL40-B3015	14851	12/08/2020	12/10/2021
Preamplifier	IMPULSE	CA118-546ACN	9169	13/01/2021	13/03/2022
Preamplifier	Mini-circuit	ZFL-1000LN	1321	25/06/2019	25/02/2021
Receiver	Agilent Technologies	E4440A	5824	22/10/2020	22/12/2022
Receiver	Rohde & Schwarz	ESI	9704	03/03/2020	03/05/2021
Receiver	Rohde & Schwarz	FPL1003	16027	14/08/2020	14/10/2021
Receiver	Rohde & Schwarz	FSW43	14830	29/07/2020	29/09/2021
Shielded enclosure	RAY PROOF	C.V2	1423	04/10/2019	04/12/2022
Shielded enclosure	COMTEST	SAC 3m	14494	02/10/2019	02/12/2022
Software	Nexio		0000		
Thermohygrometer	Testo	608-H1	7562	25/01/2019	25/03/2021
Thermohygrometer	Testo	608-H2	12269	07/05/2020	07/07/2022
Thermohygrometer	Bioblock Scientific	Météostar	0963	25/01/2019	25/03/2021

BAT-EMC software version: V3.18.0.26

Blank cells = Permanent validity

TRANSMITTER RADIATED SPURIOUS EMISSIONS AT FREQUENCIES >30MHZ- TABULATED RESULTS					
CHARGING + TX MODE / ALL POSITIONS / ALL CHANNELS / FOR FREQ <1GHZ				EMI7260	
Frequency MHz	Polarization	Level peak dBμV/m	Level Qpeak dBμV/m	Limit dBμV/m	Margin dB
30.19	Vertical	31.08	23.76	40	-16.24
30.32	Vertical	32.67	24.4	40	-15.6
30.74	Vertical	35.75	26.94	40	-13.06
30.96	Vertical	37.76	28.02	40	-11.98
31.23	Vertical	39.38	29.06	40	-10.94
31.34	Vertical	39.73	29.8	40	-10.2
31.55	Vertical	39.3	30.05	40	-9.95
31.74	Vertical	39.63	30.13	40	-9.87
31.93	Vertical	38.76	29.93	40	-10.07
32.13	Vertical	39.51	30.1	40	-9.9
32.36	Vertical	39.38	29.6	40	-10.4
32.76	Vertical	40.08	29.8	40	-10.2
32.93	Vertical	40.33	30.63	40	-9.37
33.08	Vertical	40.78	23.33	40	-16.67
33.38	Vertical	42.28	25.45	40	-14.55
33.51	Vertical	40.03	24.21	40	-15.79
33.83	Vertical	40.48	24.86	40	-15.14
34.02	Vertical	42.45	27.07	40	-12.93
34.17	Vertical	41.99	26.05	40	-13.95
34.34	Vertical	44.01	27.66	40	-12.34
34.53	Vertical	42.8	26.74	40	-13.26
34.65	Vertical	41.99	27.66	40	-12.34
34.95	Vertical	43.16	28.07	40	-11.93
35.27	Vertical	44.5	27.82	40	-12.18
35.55	Vertical	45.28	29.99	40	-10.01
35.78	Vertical	45.03	31.03	40	-8.97
35.93	Vertical	44.8	30.75	40	-9.25
36.21	Vertical	45.98	32.21	40	-7.79
36.46	Vertical	47.11	32.86	40	-7.14
36.86	Vertical	47.17	32.78	40	-7.22
37.18	Vertical	46.1	31.59	40	-8.41
37.37	Vertical	44.75	29.77	40	-10.23
37.65	Vertical	45.57	31.25	40	-8.75
37.88	Vertical	45.59	31.32	40	-8.68
38.08	Vertical	44.85	30.65	40	-9.35
38.27	Vertical	43.55	29.79	40	-10.21
38.61	Vertical	42.14	28.94	40	-11.06
38.82	Vertical	40.62	27.69	40	-12.31
39.05	Vertical	40.4	27.82	40	-12.18
39.29	Vertical	39.39	26.73	40	-13.27
39.52	Vertical	38.48	25.67	40	-14.33
40.03	Vertical	37.03	24.28	40	-15.72
40.24	Vertical	35.79	23.84	40	-16.16
40.61	Vertical	34.79	22.56	40	-17.44

TRANSMITTER RADIATED SPURIOUS EMISSIONS AT FREQUENCIES >30MHZ- TABULATED RESULTS					
CHARGING + TX MODE / ALL POSITIONS / ALL CHANNELS / FOR FREQ <1GHZ				EMI7260	
40.99	Vertical	34.96	21.97	40	-18.03
41.16	Vertical	34.8	21.86	40	-18.14
41.39	Vertical	35.69	22.02	40	-17.98
41.77	Vertical	37.44	24.35	40	-15.65
42.01	Vertical	39.94	26.27	40	-13.73
42.33	Vertical	41.03	26.82	40	-13.18
42.58	Vertical	40.13	25.72	40	-14.28
42.90	Vertical	38.37	24.34	40	-15.66
43.20	Vertical	37.48	23.54	40	-16.46
43.56	Vertical	37.29	23.1	40	-16.9
43.88	Vertical	35.57	22.13	40	-17.87
44.43	Vertical	35.35	21.01	40	-18.99
44.83	Vertical	34.92	20.76	40	-19.24
45.30	Vertical	34.72	21.06	40	-18.94
45.79	Vertical	34.78	20.97	40	-19.03
68.04	Vertical	31.05	19.02	40	-20.98
68.19	Vertical	32.03	19.08	40	-20.92
68.40	Vertical	30.46	18.98	40	-21.02
68.59	Vertical	30.49	18.93	40	-21.07
68.70	Vertical	31.22	18.93	40	-21.07
68.83	Vertical	30.63	19.1	40	-20.9
68.98	Vertical	29.37	18.89	40	-21.11
69.08	Vertical	30.01	18.83	40	-21.17
69.21	Vertical	29.21	18.84	40	-21.16
69.42	Vertical	30.23	18.79	40	-21.21
69.55	Vertical	29.2	18.79	40	-21.21
69.68	Vertical	29.22	18.79	40	-21.21
69.74	Vertical	29.91	18.85	40	-21.15
69.93	Vertical	28.83	18.8	40	-21.2
70.08	Vertical	30.04	24.44	40	-15.56
70.27	Vertical	30.66	24.75	40	-15.25
70.49	Vertical	30.36	24.77	40	-15.23
70.61	Vertical	30.52	24.72	40	-15.28
70.83	Vertical	30.85	24.46	40	-15.54
70.91	Vertical	31	24.62	40	-15.38
71.04	Vertical	30.49	24.19	40	-15.81
71.21	Vertical	30.17	23.89	40	-16.11
71.27	Vertical	29.69	23.85	40	-16.15
71.46	Vertical	29.92	23.41	40	-16.59
71.57	Vertical	29.4	23.17	40	-16.83
71.72	Vertical	29.81	22.67	40	-17.33
71.87	Vertical	29.15	22.43	40	-17.57
71.95	Vertical	28.75	22.13	40	-17.87
72.12	Vertical	28.88	21.72	40	-18.28

Spurious which has more than 20 dB of margin compared to the applicable limit is not necessarily reported

TEST SETUP PHOTO(S) – TX MODE / POSITION 1



TEST SETUP PHOTO(S) – TX MODE – POSITION 2



TEST SETUP PHOTO(S) – TX MODE – POSITION 3

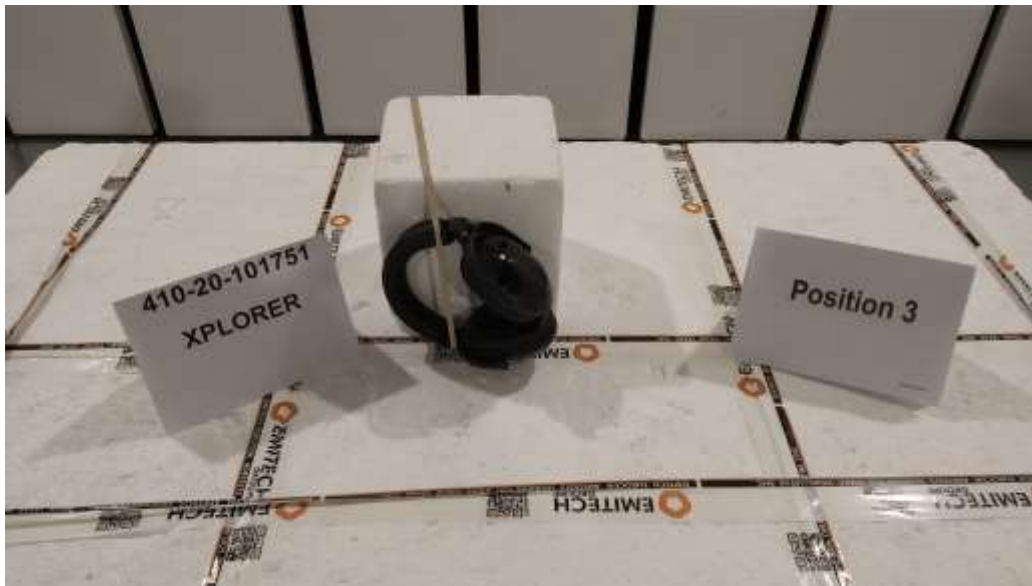

TEST SETUP PHOTO(S) – CHARGING + TX MODE – POSITION 1



TEST SETUP PHOTO(S) - CHARGING + TX MODE – POSITION 2



TEST SETUP PHOTO(S) - CHARGING + TX MODE – POSITION 3





**TEST SETUP PHOTO(S) – TX MODE – 30MHZ TO 200MHZ**



**TEST SETUP PHOTO(S) – TX MODE – 200MHZ TO 1GHZ**





TEST SETUP PHOTO(S) – TX MODE – 1GHZ TO 18GHZ



TEST SETUP PHOTO(S) - TX MODE / 18GHZ TO 26.5GHZ

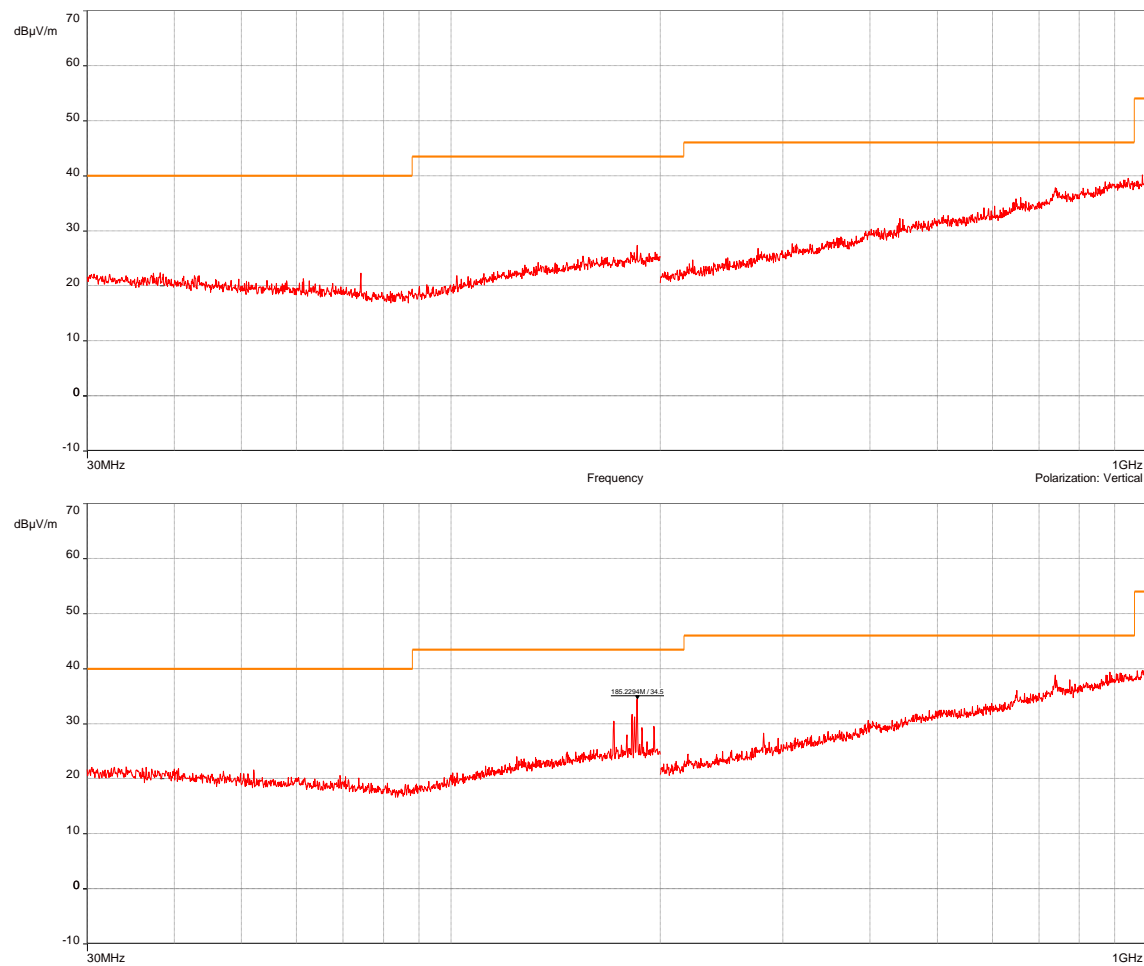

TRANSMITTER RADIATED SPURIOUS EMISSIONS AT FREQUENCIES >30MHz - GRAPH					
TX MODE / ALL POSITIONS / ALL CHANNELS / FOR FREQ <1GHz				EMI7259	
EUT mode:	D-M2			T (°C):	17.0
Test Date:	Modulated			H (%):	42.2
Test Operator:	ATO & OAT			P (hPa):	1007
					
POSITION	FREQUENCIES	RBW	VBW	DETECTOR	
Vertical	30MHz-200MHz	100kHz	300kHz	Peak	
Horizontal	30MHz-200MHz	100kHz	300kHz	Peak	
Horizontal	200MHz-1GHz	100kHz	300kHz	Peak	
Vertical	200MHz-1GHz	100kHz	300kHz	Peak	
Configuration:	N/A				
Comments:	N/A				
EUT modification(s): N/A					

TRANSMITTER RADIATED SPURIOUS EMISSIONS AT FREQUENCIES >30MHz - GRAPH					
CHARGING + Tx MODE / ALL POSITIONS / ALL CHANNELS / FOR FREQ <1GHz				EMI7260	
EUT mode:	Modulated			T (°C):	17.0
Test Date:	09/04/2021			H (%):	42.2
Test Operator:	ATO & OAT			P (hPa):	1007
					
POSITION	FREQUENCIES	RBW	VBW	DETECTOR	
Vertical	30MHz-200MHz	100kHz	300kHz	Peak	
Horizontal	30MHz-200MHz	100kHz	300kHz	Peak	
Vertical	200MHz-1GHz	100kHz	300kHz	Peak	
Horizontal	200MHz-1GHz	100kHz	300kHz	Peak	
Configuration:	N/A				
Comments:	N/A				
EUT modification(s): N/A					

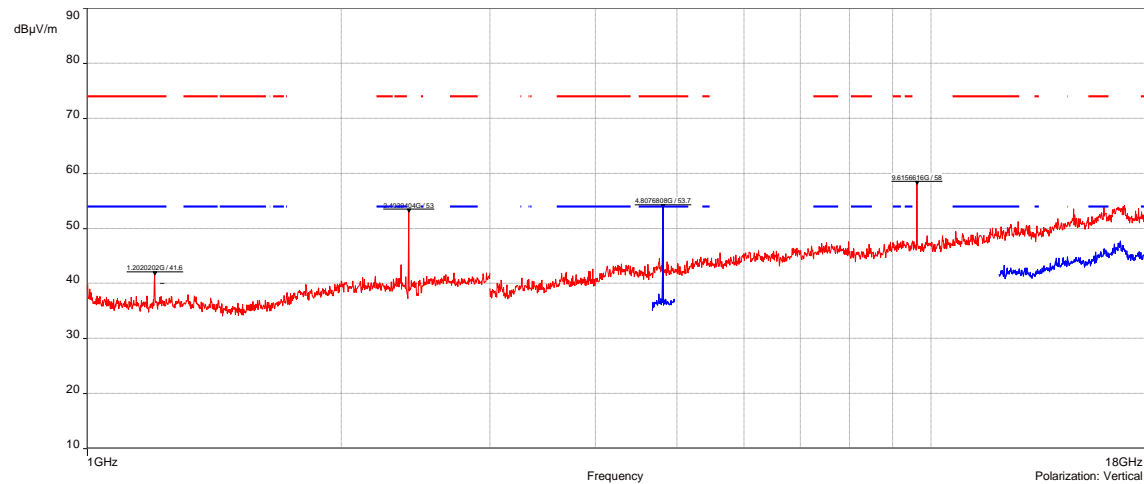
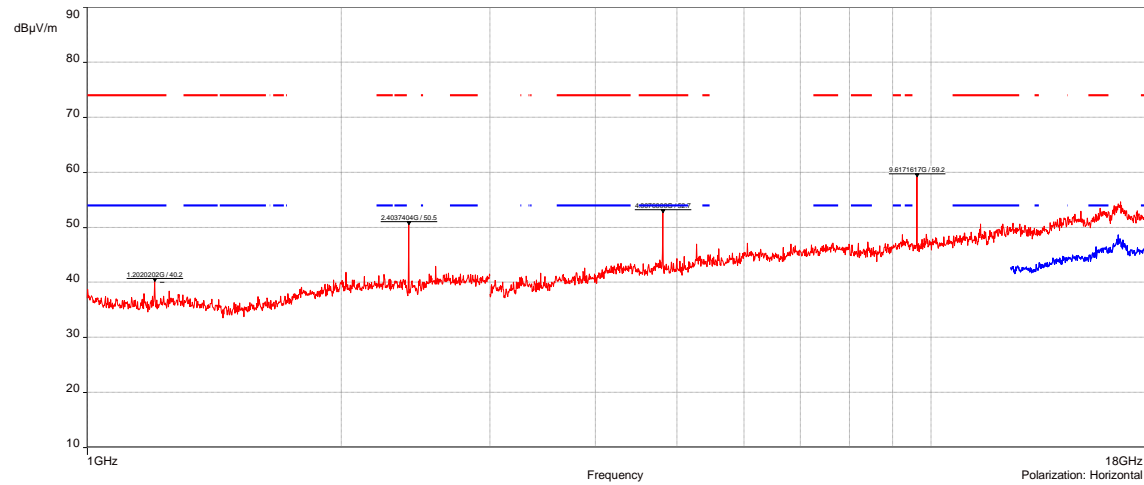
TRANSMITTER RADIATED SPURIOUS EMISSIONS AT FREQUENCIES >30MHz - GRAPH					
TX MODE / ALL POSITIONS / LOW CHANNEL / 1GHz TO 18GHz				EMI7194	
EUT mode:	Modulated			T (°C):	23.8
Test Date:	06/04/2021			H (%):	24.1
Test Operator:	ATO & OAT			P (hPa):	1009
 <p>The graph shows dBuV/m vs Frequency (1GHz to 18GHz) for Vertical Polarization. The y-axis ranges from 10 to 90 dBuV/m. A red trace shows the measured emissions, and a blue trace shows the limit. Several peaks are labeled with their frequencies and values: 1.20202020 / 41.6, 2.40374040 / 50.6, 4.80748080 / 53.7, and 9.61496160 / 58.</p>					
 <p>The graph shows dBuV/m vs Frequency (1GHz to 18GHz) for Horizontal Polarization. The y-axis ranges from 10 to 90 dBuV/m. A red trace shows the measured emissions, and a blue trace shows the limit. Several peaks are labeled with their frequencies and values: 1.20202020 / 40.6, 2.40374040 / 50.6, 4.80748080 / 53.7, and 9.61496160 / 58.</p>					
POSITION	FREQUENCIES	RBW	VBW	DETECTOR	
Vertical	1GHz-3GHz	1MHz	3MHz	Peak	
Horizontal	1GHz-3GHz	1MHz	3MHz	Peak	
Vertical	3GHz-18GHz	1MHz	3MHz	Peak	
Horizontal	3GHz-18GHz	1MHz	3MHz	Peak	
Vertical	4.6GHz-5GHz	1MHz	50kHz	Peak	
Vertical	10GHz-18GHz	1MHz	50kHz	Peak	
Horizontal	10GHz-18GHz	1MHz	50kHz	Peak	
Configuration:	N/A				
Comments:	2.4GHz is due to operating frequency				
EUT modification(s): N/A					

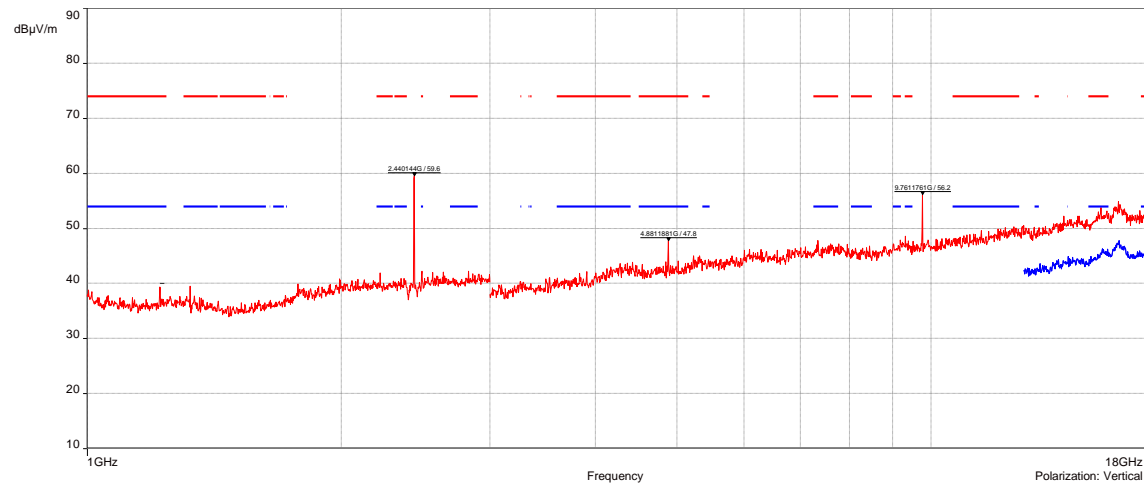
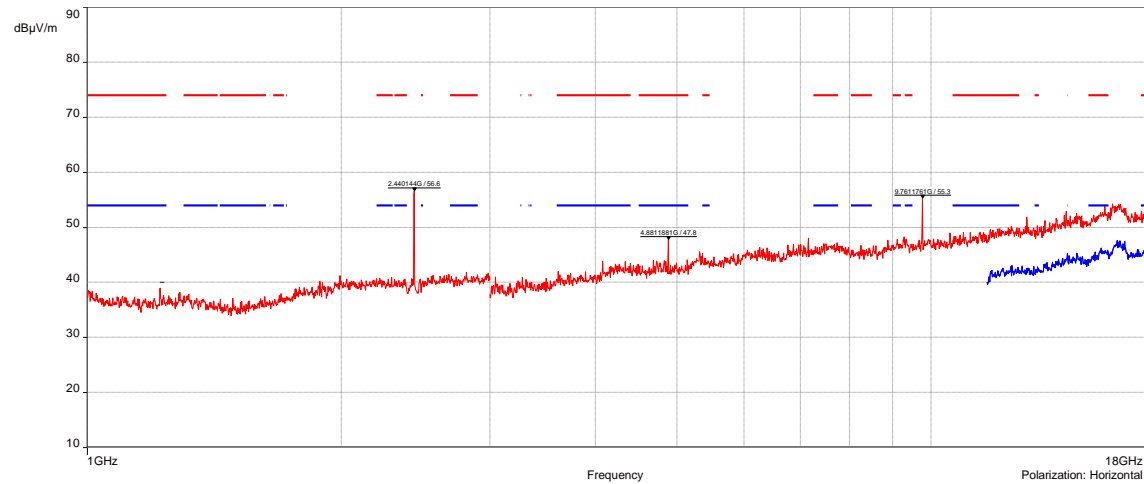
TRANSMITTER RADIATED SPURIOUS EMISSIONS AT FREQUENCIES >30MHz - GRAPH					
TX MODE / ALL POSITIONS / MID CHANNEL / 1GHz TO 18GHz				EMI7195	
EUT mode:	Modulated			T (°C):	23.8
Test Date:	06/04/2021			H (%):	24.1
Test Operator:	ATO & OAT			P (hPa):	1009
					
					
POSITION	FREQUENCIES	RBW	VBW	DETECTOR	
Vertical	1GHz-3GHz	1MHz	3MHz	Peak	
Horizontal	1GHz-3GHz	1MHz	3MHz	Peak	
Vertical	3GHz-18GHz	1MHz	3MHz	Peak	
Horizontal	3GHz-18GHz	1MHz	3MHz	Peak	
Vertical	10GHz-18GHz	1MHz	50kHz	Peak	
Horizontal	10GHz-18GHz	1MHz	50kHz	Peak	
Configuration:	N/A				
Comments:	2.4GHz is due to operating frequency				
EUT modification(s): N/A					

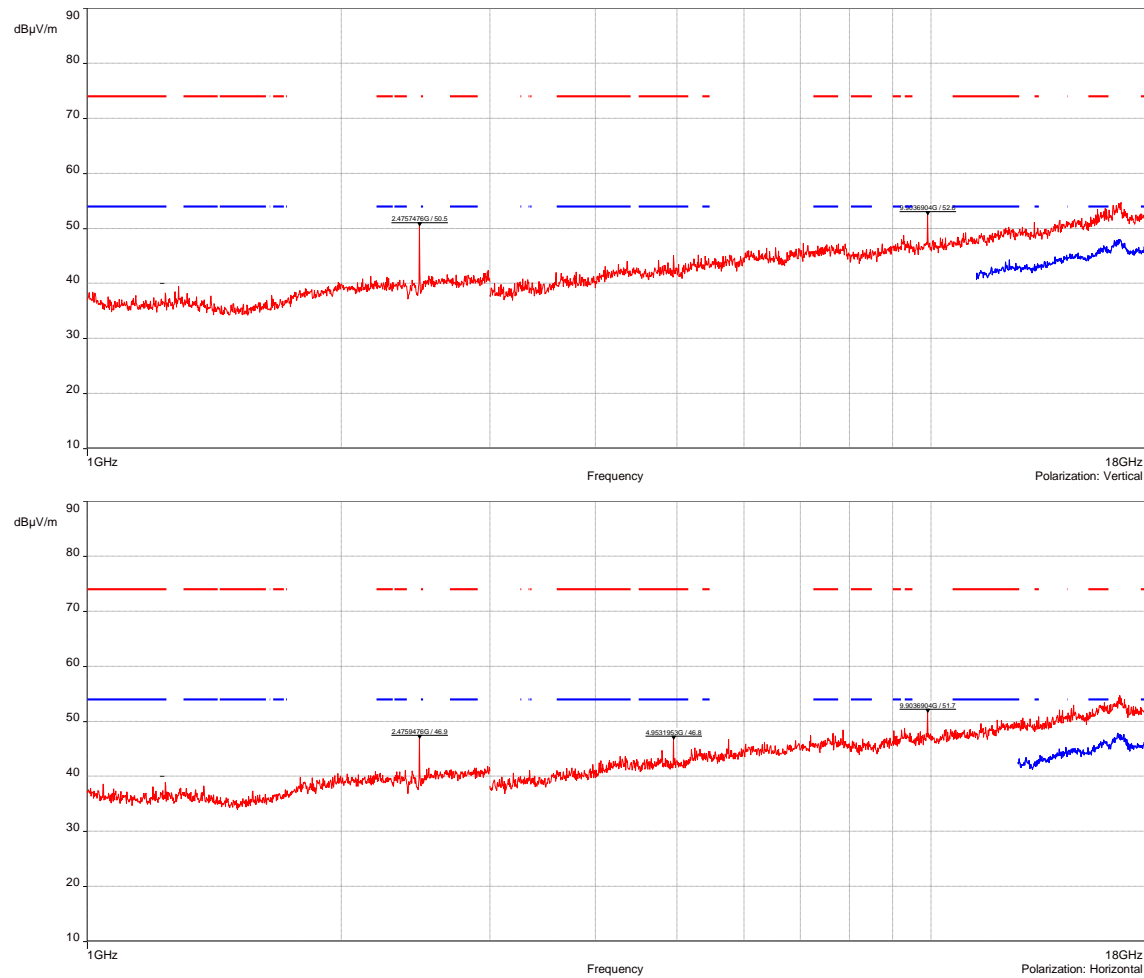
TRANSMITTER RADIATED SPURIOUS EMISSIONS AT FREQUENCIES >30MHz - GRAPH					
TX MODE / ALL POSITIONS / HIGH CHANNEL / 1GHz TO 18GHz				EMI7196	
EUT mode:	Modulated			T (°C):	23.8
Test Date:	06/04/2021			H (%):	24.1
Test Operator:	ATO & OAT			P (hPa):	1009
					
POSITION	FREQUENCIES	RBW	VBW	DETECTOR	
Vertical	1GHz-3GHz	1MHz	3MHz	Peak	
Horizontal	1GHz-3GHz	1MHz	3MHz	Peak	
Vertical	3GHz-18GHz	1MHz	3MHz	Peak	
Horizontal	3GHz-18GHz	1MHz	3MHz	Peak	
Vertical	10GHz-18GHz	1MHz	50kHz	Peak	
Horizontal	10GHz-18GHz	1MHz	50kHz	Peak	
Configuration:	N/A				
Comments:	2.4GHz is due to operating frequency				
EUT modification(s): N/A					

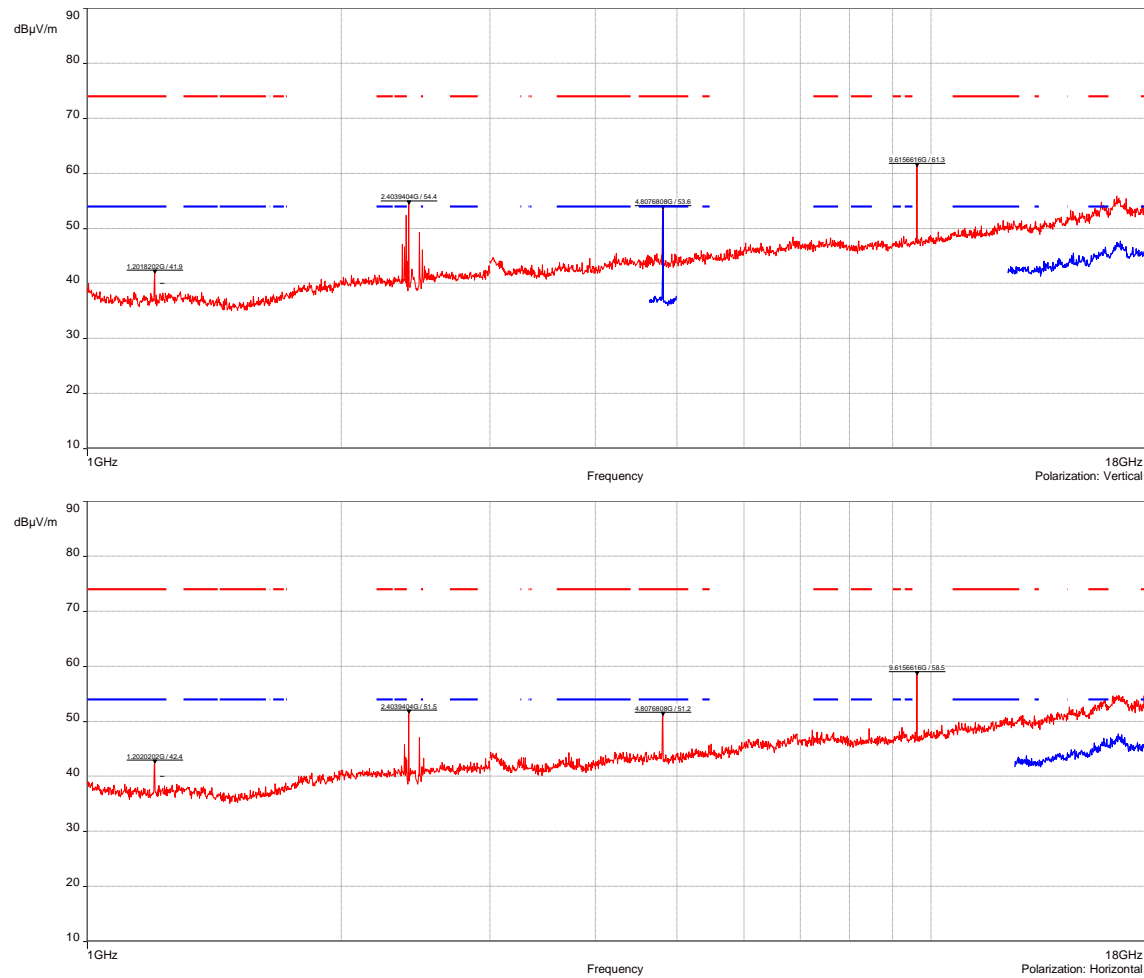
TRANSMITTER RADIATED SPURIOUS EMISSIONS AT FREQUENCIES >30MHz - GRAPH					
CHARGING + TX MODE / ALL POSITIONS / LOW CHANNEL / 1GHz TO 18GHz				EMI7206	
EUT mode:	Modulated			T (°C):	20.4
Test Date:	07/04/2021			H (%):	17.0
Test Operator:	ATO & OAT			P (hPa):	1017
					
POSITION	FREQUENCIES	RBW	VBW	DETECTOR	
Vertical	1GHz-3GHz	1MHz	3MHz	Peak	
Horizontal	1GHz-3GHz	1MHz	3MHz	Peak	
Vertical	3GHz-18GHz	1MHz	3MHz	Peak	
Horizontal	3GHz-18GHz	1MHz	3MHz	Peak	
Vertical	10GHz-18GHz	1MHz	50kHz	Peak	
Horizontal	10GHz-18GHz	1MHz	50kHz	Peak	
Configuration:	N/A				
Comments:	2.4GHz is due to operating frequency				
EUT modification(s): N/A					

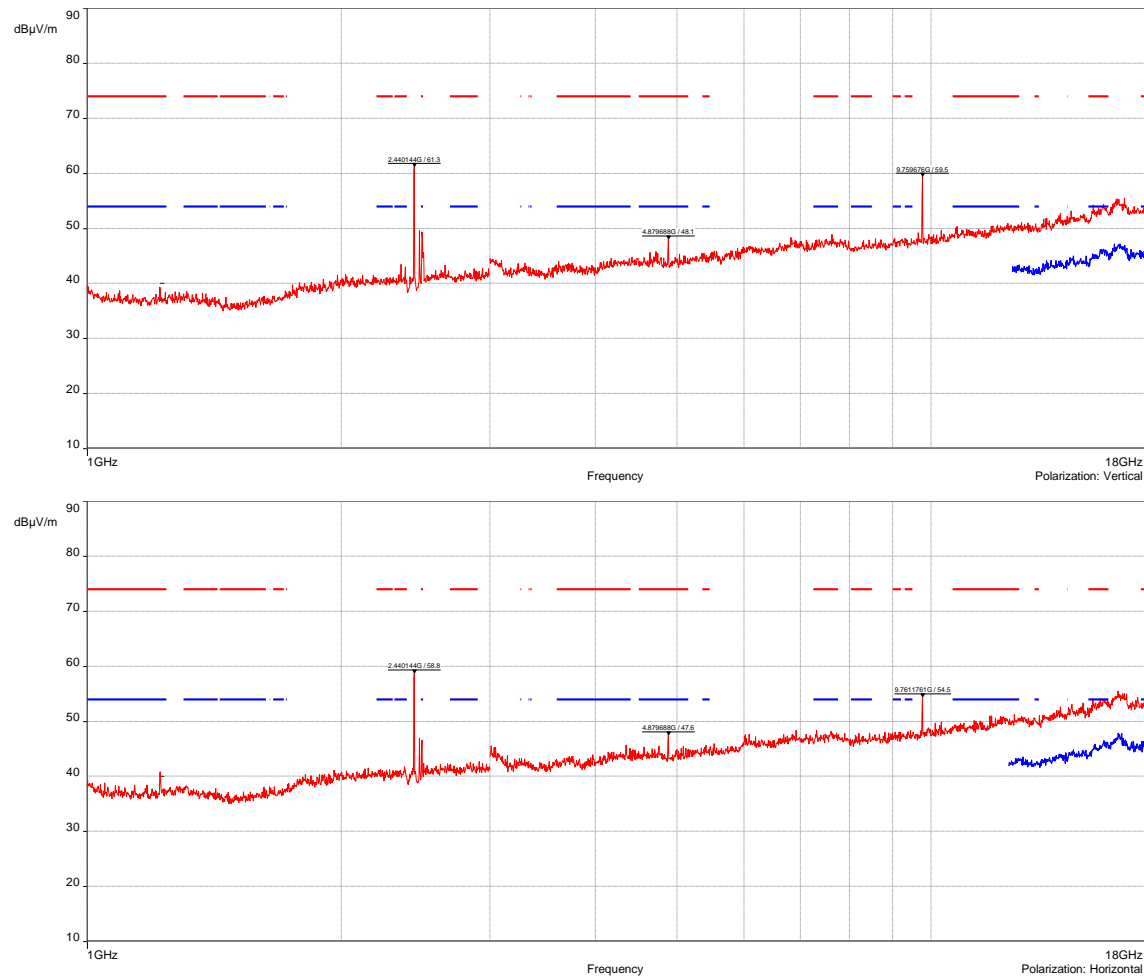

TRANSMITTER RADIATED SPURIOUS EMISSIONS AT FREQUENCIES >30MHz - GRAPH					
CHARGING + Tx MODE / ALL POSITIONS / MID CHANNEL / 1GHz TO 18GHz				EMI7207	
EUT mode:	D-M2			T (°C):	20.4
Test Date:	07/04/2021			H (%):	17.0
Test Operator:	ATO & OAT			P (hPa):	1017
					
POSITION	FREQUENCIES	RBW	VBW	DETECTOR	
Vertical	1GHz-3GHz	1MHz	3MHz	Peak	
Horizontal	1GHz-3GHz	1MHz	3MHz	Peak	
Vertical	3GHz-18GHz	1MHz	3MHz	Peak	
Horizontal	3GHz-18GHz	1MHz	3MHz	Peak	
Vertical	10GHz-18GHz	1MHz	50kHz	Peak	
Horizontal	10GHz-18GHz	1MHz	50kHz	Peak	
Configuration:	N/A				
Comments:	2.4GHz is due to operating frequency				
EUT modification(s): N/A					

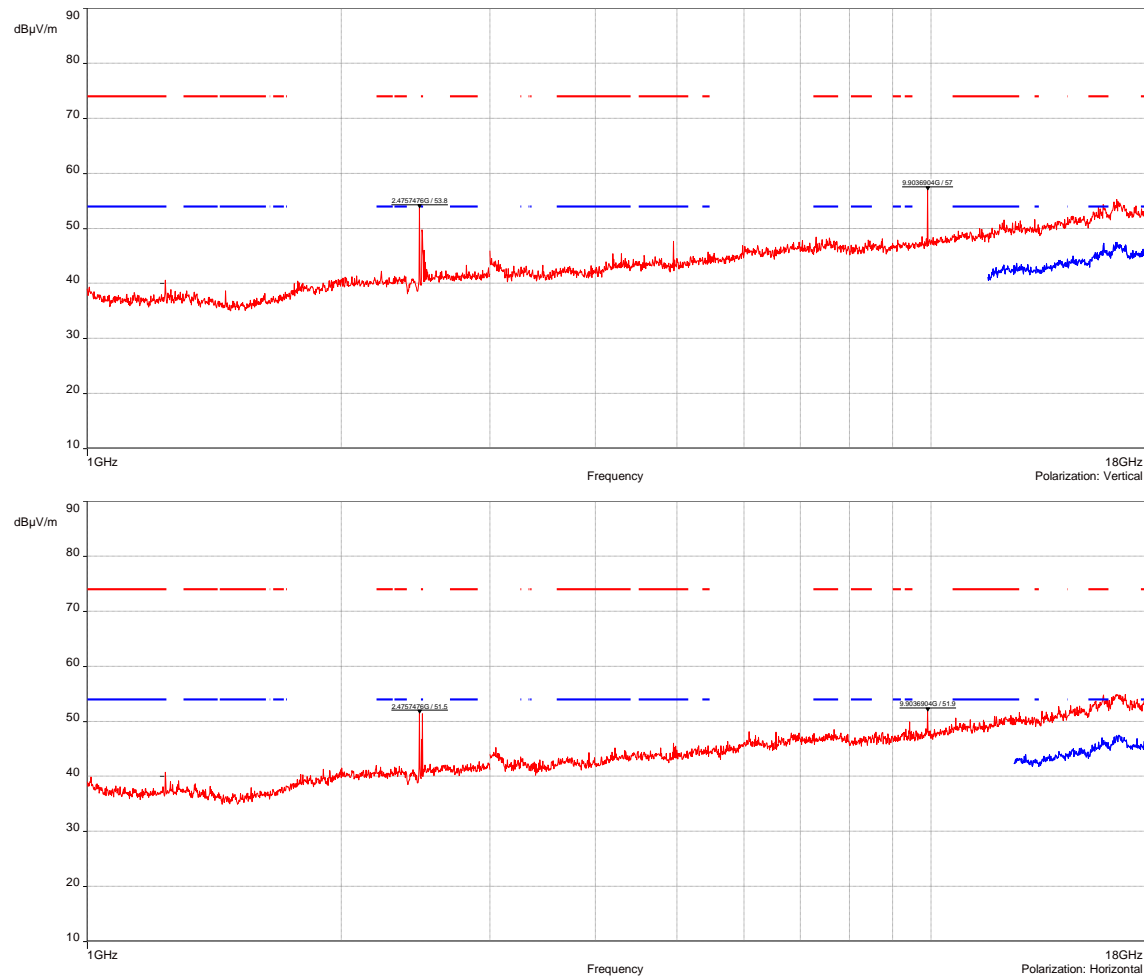
TRANSMITTER RADIATED SPURIOUS EMISSIONS AT FREQUENCIES >30MHz - GRAPH					
CHARGING + TX MODE / ALL POSITIONS / HIGH CHANNEL / 1GHz TO 18GHz				EMI7208	
EUT mode:	D-M2			T (°C):	20.4
Test Date:	07/04/2021			H (%):	17.0
Test Operator:	ATO & OAT			P (hPa):	1017
					
POSITION	FREQUENCIES	RBW	VBW	DETECTOR	
Vertical	1GHz-3GHz	1MHz	3MHz	Peak	
Horizontal	1GHz-3GHz	1MHz	3MHz	Peak	
Vertical	3GHz-18GHz	1MHz	3MHz	Peak	
Horizontal	3GHz-18GHz	1MHz	3MHz	Peak	
Vertical	10GHz-18GHz	1MHz	50kHz	Peak	
Horizontal	10GHz-18GHz	1MHz	50kHz	Peak	
Configuration:	N/A				
Comments:	2.4GHz is due to operating frequency				
EUT modification(s): N/A					

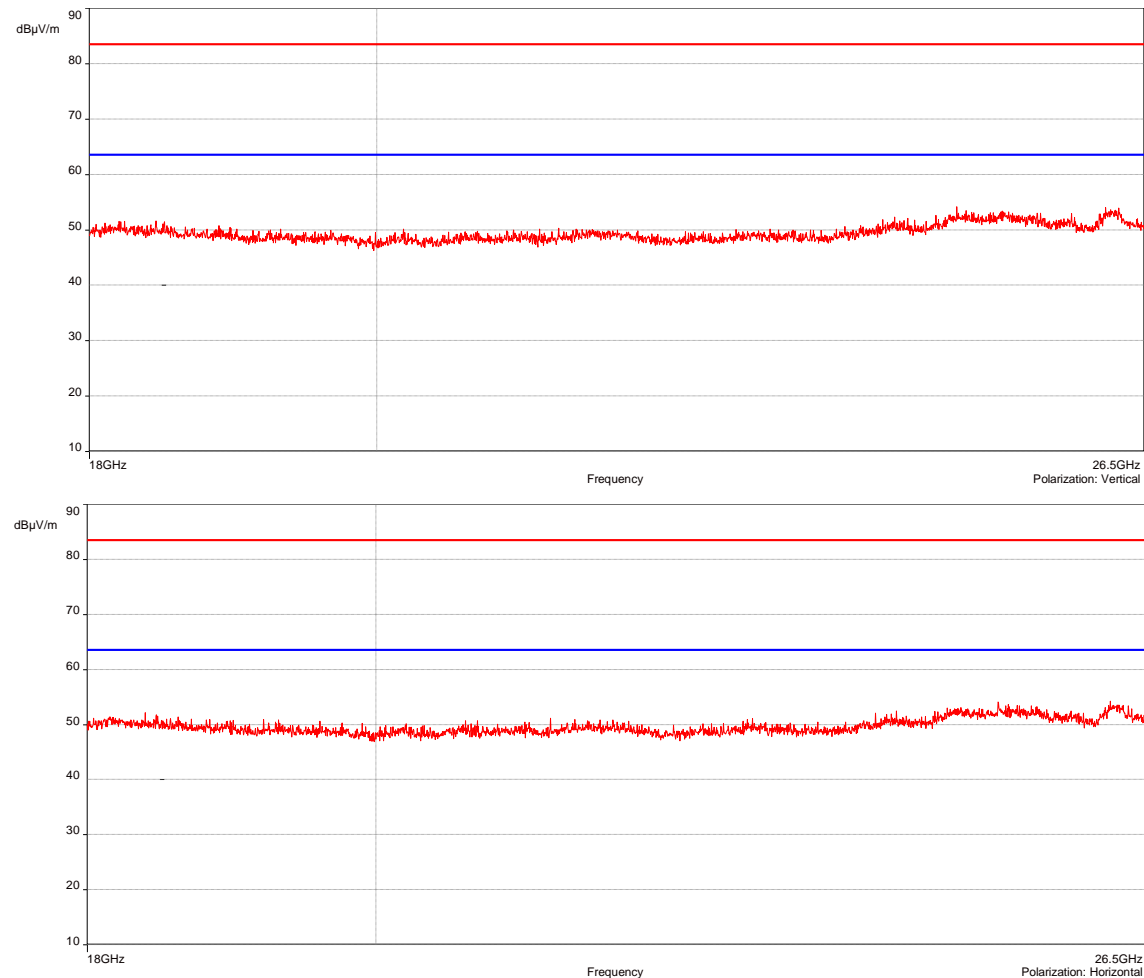
TRANSMITTER RADIATED SPURIOUS EMISSIONS AT FREQUENCIES >30MHz - GRAPH					
TX MODE / ALL POSITIONS / LOW CHANNEL / 18GHz TO 26.5GHz				EMI7246	
EUT mode:	Modulated			T (°C):	21.6
Test Date:	08/04/2021			H (%):	25.4
Test Operator:	ATO & OAT			P (hPa):	1015
					
POSITION	FREQUENCIES	RBW	VBW	DETECTOR	
Vertical	18GHz-26.5GHz	1MHz	3MHz	Peak	
Horizontal	18GHz-26.5GHz	1MHz	3MHz	Peak	
Configuration:	N/A				
Comments:	N/A				
EUT modification(s): N/A					

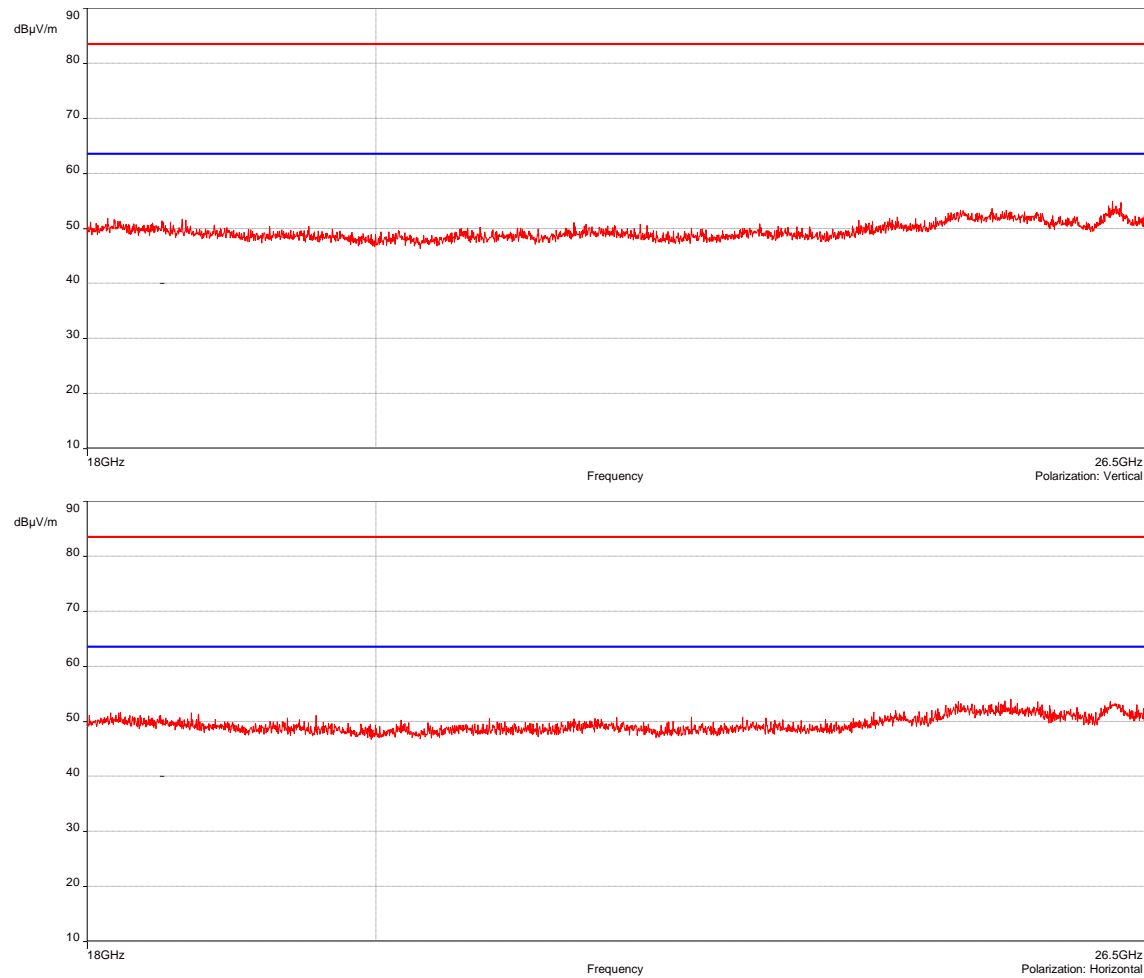
TRANSMITTER RADIATED SPURIOUS EMISSIONS AT FREQUENCIES >30MHZ - GRAPH					
TX MODE / ALL POSITIONS / MID CHANNEL / 18GHZ TO 26.5GHZ				EMI7247	
<b>EUT mode:</b>	Modulated			<b>T (°C):</b>	21.6
<b>Test Date:</b>	08/04/2021			<b>H (%):</b>	25.4
<b>Test Operator:</b>	ATO & OAT			<b>P (hPa):</b>	1015
					
POSITION	FREQUENCIES	RBW	VBW	DETECTOR	
Vertical	18GHz-26.5GHz	1MHz	3MHz	Peak	
Horizontal	18GHz-26.5GHz	1MHz	3MHz	Peak	
<b>Configuration:</b>	N/A				
<b>Comments:</b>	N/A				
EUT modification(s): N/A					

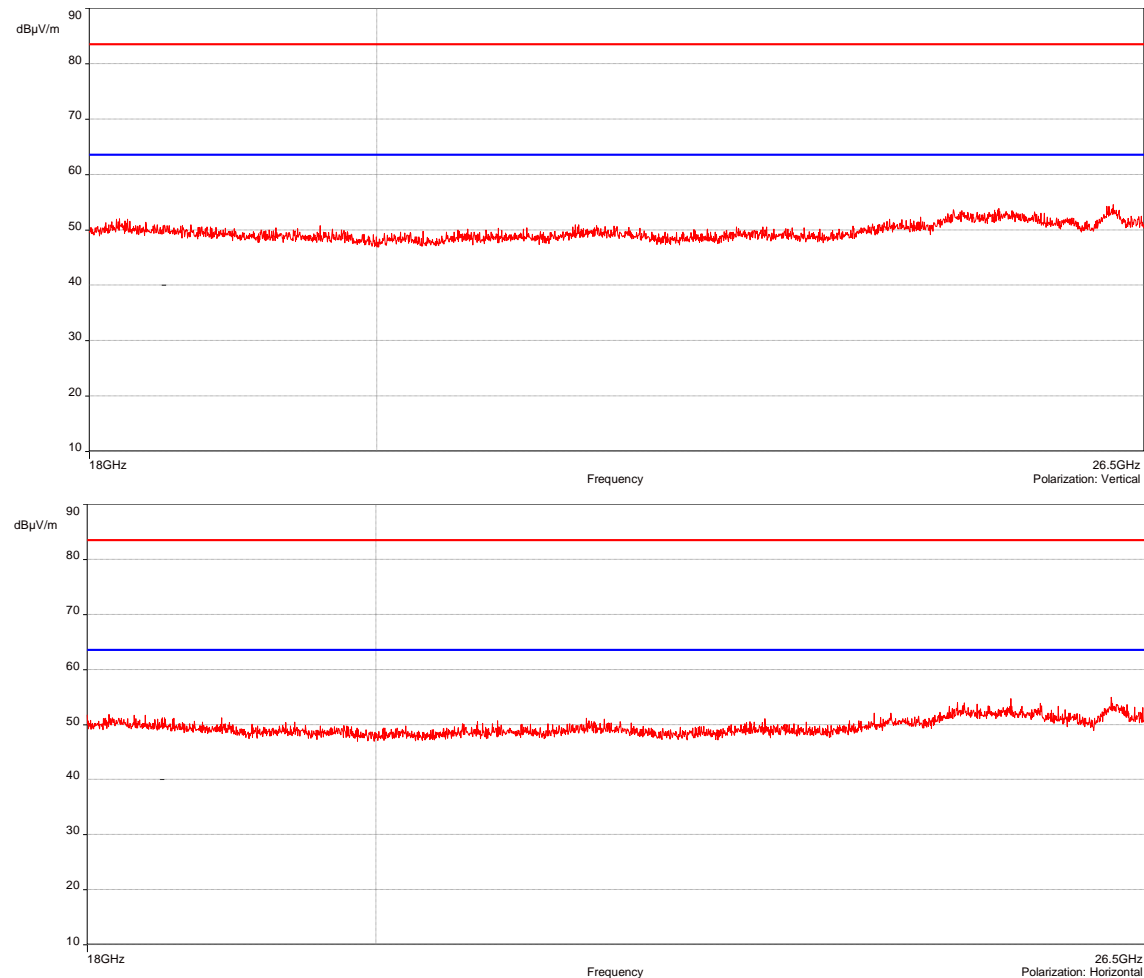
TRANSMITTER RADIATED SPURIOUS EMISSIONS AT FREQUENCIES >30MHz - GRAPH					
TX MODE / ALL POSITIONS / HIGH CHANNEL / 18GHz TO 26.5GHz				EMI7248	
EUT mode:	Modulated			T (°C):	21.6
Test Date:	08/04/2021			H (%):	25.4
Test Operator:	ATO & OAT			P (hPa):	1015
					
POSITION	FREQUENCIES	RBW	VBW	DETECTOR	
Vertical	18GHz-26.5GHz	1MHz	3MHz	Peak	
Horizontal	18GHz-26.5GHz	1MHz	3MHz	Peak	
Configuration:	N/A				
Comments:	N/A				
EUT modification(s): N/A					

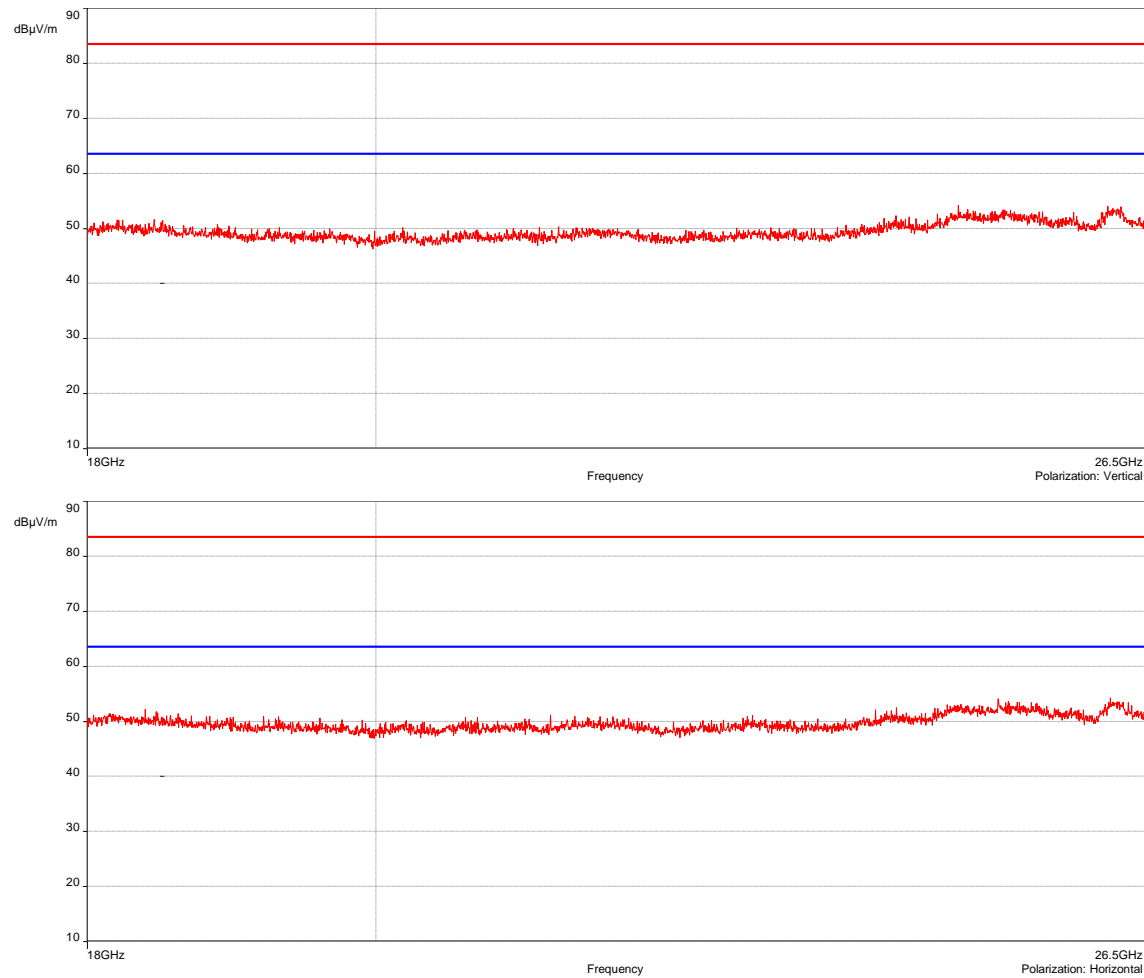
TRANSMITTER RADIATED SPURIOUS EMISSIONS AT FREQUENCIES >30MHz - GRAPH				
CHARGING + Tx MODE / ALL POSITIONS / LOW CHANNEL / 18GHz TO 26.5GHz			EMI7286	
EUT mode:	Modulated		T (°C):	21.6
Test Date:	08/04/2021		H (%):	25.4
Test Operator:	ATO & OAT		P (hPa):	1015
				
POSITION	FREQUENCIES	RBW	VBW	DETECTOR
Vertical	18GHz-26.5GHz	1MHz	3MHz	Peak
Horizontal	18GHz-26.5GHz	1MHz	3MHz	Peak
Configuration:	N/A			
Comments:	N/A			
EUT modification(s): N/A				

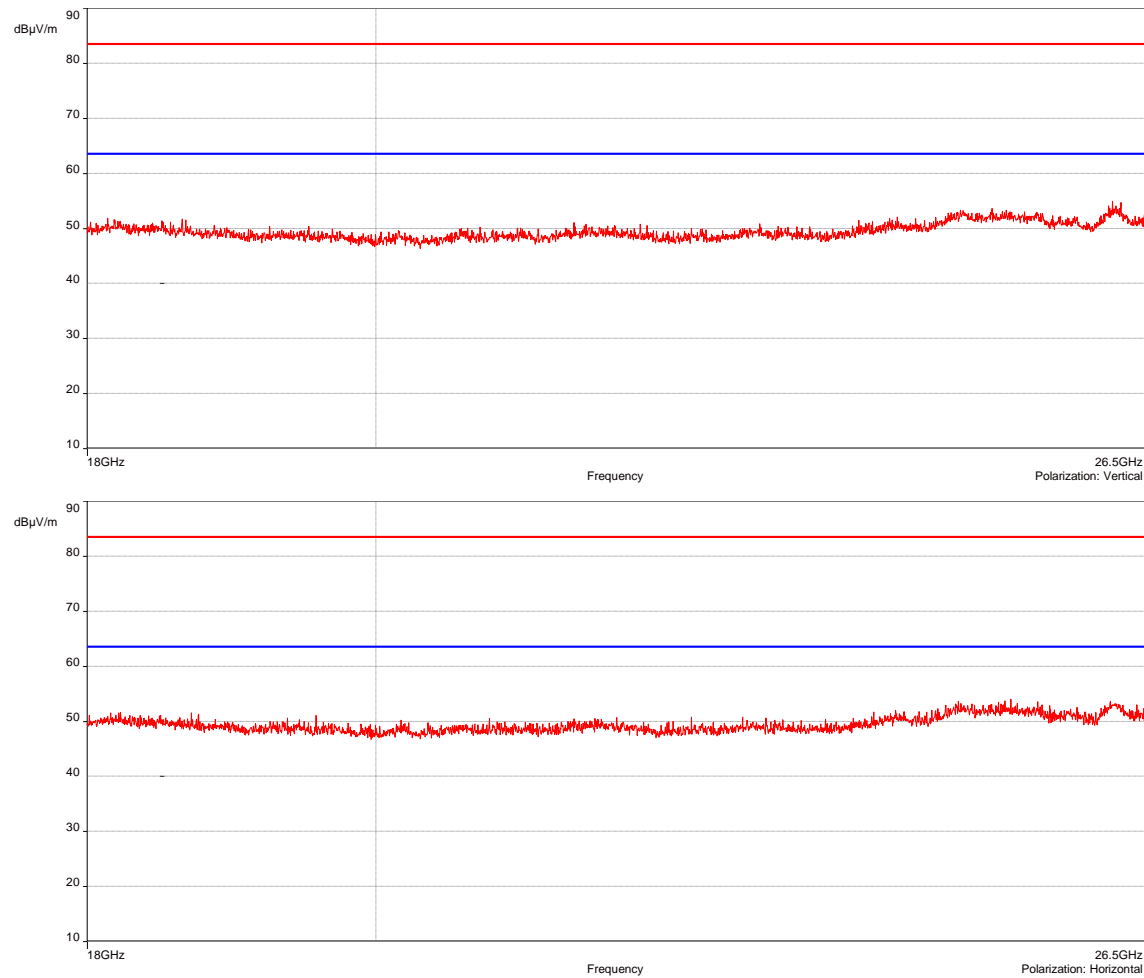
TRANSMITTER RADIATED SPURIOUS EMISSIONS AT FREQUENCIES >30MHZ - GRAPH					
CHARGING + TX MODE / ALL POSITIONS / MID CHANNEL / 18GHZ TO 26.5GHZ				EMI7287	
<b>EUT mode:</b>	Modulated			<b>T (°C):</b>	21.6
<b>Test Date:</b>	08/04/2021			<b>H (%):</b>	25.4
<b>Test Operator:</b>	ATO & OAT			<b>P (hPa):</b>	1015
					
POSITION	FREQUENCIES	RBW	VBW	DETECTOR	
Vertical	18GHz-26.5GHz	1MHz	3MHz	Peak	
Horizontal	18GHz-26.5GHz	1MHz	3MHz	Peak	
<b>Configuration:</b>	N/A				
<b>Comments:</b>	N/A				
EUT modification(s): N/A					

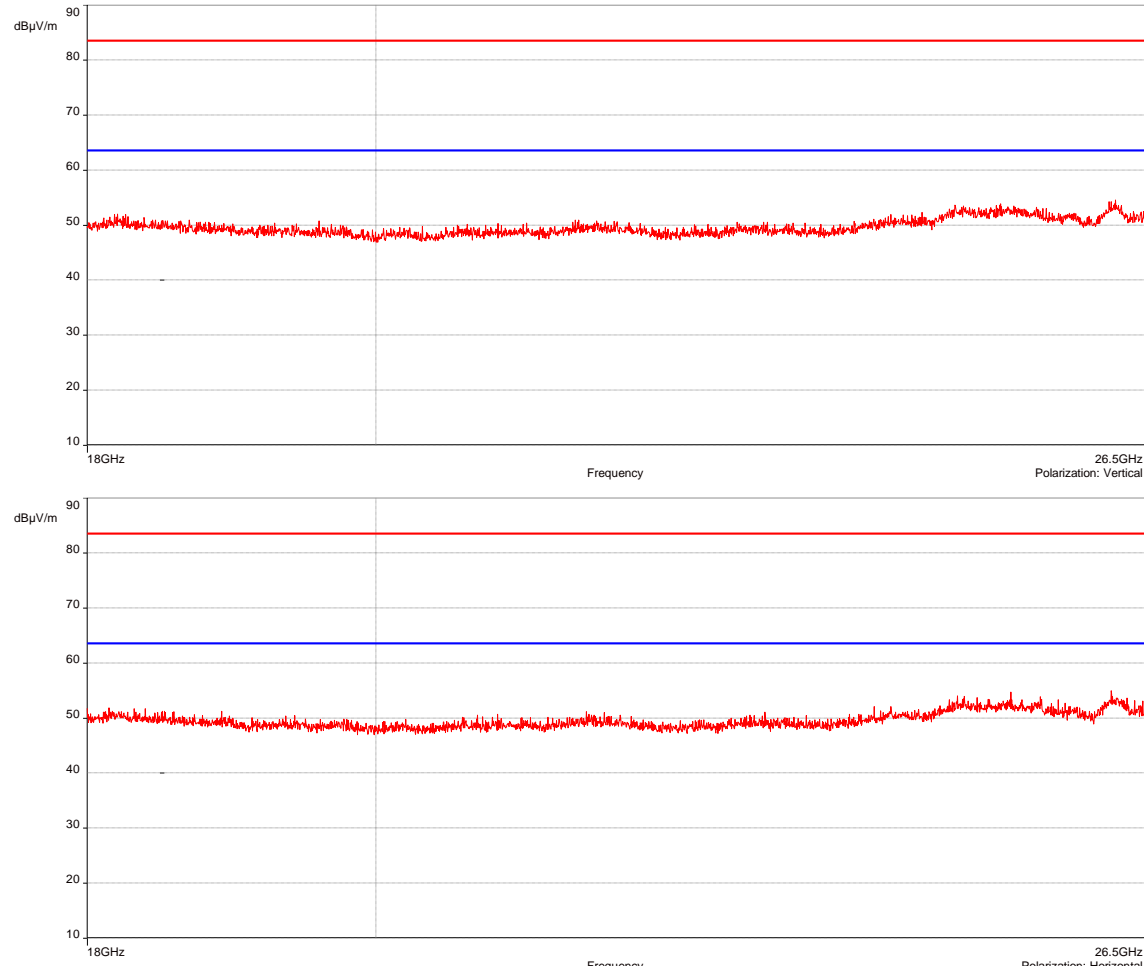
TRANSMITTER RADIATED SPURIOUS EMISSIONS AT FREQUENCIES >30MHz - GRAPH					
CHARGING + TX MODE / ALL POSITIONS / HIGH CHANNEL / 18GHz TO 26.5GHz				EMI7288	
<b>EUT mode:</b>	Modulated			<b>T (°C):</b>	21.6
<b>Test Date:</b>	08/04/2021			<b>H (%):</b>	25.4
<b>Test Operator:</b>	ATO & OAT			<b>P (hPa):</b>	1015
					
POSITION	FREQUENCIES	RBW	VBW	DETECTOR	
Vertical	18GHz-26.5GHz	1MHz	3MHz	Peak	
Horizontal	18GHz-26.5GHz	1MHz	3MHz	Peak	
<b>Configuration:</b>	N/A				
<b>Comments:</b>	N/A				
EUT modification(s): N/A					



### 8.9. Radiated spurious emissions (receiver)

<b>Reference standard:</b>	FCC part 15 Radio part 15.209 & CNR-Gen
<b>Test method:</b>	FCC part 15.109, 15.209, 15.205, 15.215, CNR-Gen
<p><b>General test setup:</b> EUT is set on an insulating support at 80cm above the ground reference plane. Measurement are done on a normalized test site by the substitution method.</p> <p>The test antenna is oriented in the two polarizations (vertical and horizontal), and the product is rotated at 360° in the horizontal plane (See photo(s) for initial position of the EUT(0°)). If applicable the test antenna was raised and lowered through the specified range of height until a maximum signal level is detected.</p> <p>For portable equipments a research of maximum level is done on the 3 axes. Only the highest levels are recorded.</p>	

TESTED CONFIGURATION	PARAMETER	SEVERITY	RESULT TAB.	VERDICT
Rx mode / All Positions / All channels/ For freq <1GHz	30MHz-1GHz	15.209	EMI7266	<b>PASS</b>
Charging + Rx mode / All Positions / All channels	30MHz-1GHz	15.209	EMI7267	<b>PASS</b>
Rx mode / All Positions / All channels / 1GHz to 18GHz	1GHz-18GHz	15.209	EMI7073	<b>PASS</b>
Charging + Rx mode / All Positions / All channels / 1GHz to 18GHz	1GHz-18GHz	15.209	EMI7075	<b>PASS</b>
Rx mode / All Positions / All channels / 18GHz to 26.5GHz	18GHz-26.5GHz	15.209	EMI7300	<b>PASS</b>
Charging + Rx mode / All Positions / All channels / 18GHz to 26.5GHz	18GHz-26.5GHz	15.209	EMI7311	<b>PASS</b>

LABORATORY PARAMETERS:	REQUIRED PRIOR TO THE TEST	DURING THE TEST
Ambient Temperature	15 to 35 °C	See Graph(s)
Relative Humidity	20 to 75 %	See Graph(s)
Atmospheric pressure	N/A	See Graph(s)
<b>Test method deviation:</b> N/A		
Supplementary information: N/A		

TEST EQUIPMENT USED					
CATEGORY	BRAND	TYPE	IDENTIFIER	CAL. DATE	CAL. DUE
Antenna	ETS-Lindgren	3117	5456	24/07/2019	24/09/2022
Antenna	ETS lindgren	3160-09	14690	26/09/2017	26/11/2021
Antenna	Electro Metrics	BIA-30HF	0824	13/06/2018	13/08/2021
Antenna	Rohde & Schwarz	HL223	3126	13/06/2018	13/08/2021
Cable	MegaPhase	F135N1N28	16664	25/10/2019	25/12/2021
Cable	MegaPhase	F135N1N28	16666	25/10/2019	25/12/2021
Cable	JYE BAO	K30K30-5003-40G1	14887	25/06/2019	25/08/2021
Cable	Huber + Suhner	K-5m	14460	25/06/2019	25/08/2021
Cable	/	N-1m	3625	27/01/2021	27/03/2023
Cable	SUCOFLEX	N-5,5m	14381	25/06/2019	25/08/2021
Cable	SUCOFLEX	N-6,5m	14380	25/07/2019	25/09/2021
Cable	MegaPhase	N-8m	15813	14/01/2021	14/03/2023
Cable	Huber + Suhner	SF102K	16041	28/02/2019	28/04/2021
Cable	Huber + Suhner	SF102K	16042	24/03/2021	24/05/2023
Cable	MegaPhase	TM18-N1N1-118	12841	14/08/2020	14/10/2022
Cable	MegaPhase	TM18-N1N1-118	12842	02/12/2020	02/02/2023
Preamplifier	Wright Technologie	ASL40-B3015	14851	12/08/2020	12/10/2021
Preamplifier	IMPULSE	CA118-546ACN	9169	13/01/2021	13/03/2022
Receiver	Agilent Technologies	E4440A	5824	22/10/2020	22/12/2022
Receiver	Rohde & Schwarz	ESI	9704	03/03/2020	03/05/2021
Receiver	Rohde & Schwarz	FSW43	14830	29/07/2020	29/09/2021
Shielded enclosure	RAY PROOF	C.V2	1423	04/10/2019	04/12/2022
Shielded enclosure	COMTEST	SAC 3m	14494	02/10/2019	02/12/2022
Software	Nexio		0000		
Thermohygrometer	Testo	608-H1	7562	25/01/2019	25/03/2021
Thermohygrometer	Testo	608-H2	12268	07/05/2020	07/07/2022
Thermohygrometer	Testo	608-H2	12269	07/05/2020	07/07/2022
Thermohygrometer	Bioblock Scientific	Météostar	0963	25/01/2019	25/03/2021
Thermohygrometer	Bioblock Scientific	Météostar	0963	26/01/2019	26/09/2021

BAT-EMC software version: V3.18.0.26

Blank cells = Permanent validity

RADIATED SPURIOUS EMISSIONS (RECEIVER)- TABULATED RESULTS					
CHARGING + RX MODE / ALL POSITIONS / ALL CHANNELS / FOR FREQ <1GHz				EMI7267	
Frequency MHz	Polarization	Level peak dBµV/m	Level Qpeak dBµV/m	Limit dBµV/m	Margin dB
30.14	Vertical	31.21	23.89	40	-16.11
30.88	Vertical	37.43	27.82	40	-12.18
30.99	Vertical	37.7	28.14	40	-11.86
31.55	Vertical	39.68	30.29	40	-9.71
31.89	Vertical	39.29	30.45	40	-9.55
32.07	Vertical	38.52	29.96	40	-10.04
32.38	Vertical	39.17	30.16	40	-9.84
32.62	Vertical	41.01	30.12	40	-9.88
32.81	Vertical	39.58	23.86	40	-16.14
33.20	Vertical	41.09	23.79	40	-16.21
33.43	Vertical	41.78	26.17	40	-13.83
33.60	Vertical	40.51	24.73	40	-15.27
33.79	Vertical	42.05	26.77	40	-13.23
34.25	Vertical	41.92	26.41	40	-13.59
34.71	Vertical	42.3	27.71	40	-12.29
34.96	Vertical	43.84	27.66	40	-12.34
35.29	Vertical	43.86	28.76	40	-11.24
35.56	Vertical	45.25	30.24	40	-9.76
35.66	Vertical	44.05	28.45	40	-11.55
36.38	Vertical	45.57	30.85	40	-9.15
36.90	Vertical	46.41	31.13	40	-8.87
37.16	Vertical	44.58	29.9	40	-10.1
37.28	Vertical	45.43	30.61	40	-9.39
37.57	Vertical	44.67	29.69	40	-10.31
37.77	Vertical	45.38	31.07	40	-8.93
38.01	Vertical	44.71	30.29	40	-9.71
38.96	Vertical	40.17	27.45	40	-12.55
39.45	Vertical	38.1	25.87	40	-14.13
39.67	Vertical	37.46	25.11	40	-14.89
40.01	Vertical	36.89	24.13	40	-15.87
40.34	Vertical	36.47	23.23	40	-16.77
40.59	Vertical	34.34	22.2	40	-17.8
40.86	Vertical	34.66	21.94	40	-18.06
41.24	Vertical	35.01	21.51	40	-18.49
41.65	Vertical	37.05	23.38	40	-16.62
41.90	Vertical	38.97	25.51	40	-14.49
42.11	Vertical	40.29	26.43	40	-13.57
42.43	Vertical	40.79	26.59	40	-13.41
42.62	Vertical	40.36	25.65	40	-14.35
42.94	Vertical	38.26	24.27	40	-15.73
43.30	Vertical	37.46	23.49	40	-16.51
43.74	Vertical	35.42	22.05	40	-17.95
44.25	Vertical	34.76	21.23	40	-18.77
44.86	Vertical	34.8	20.81	40	-19.19

RADIATED SPURIOUS EMISSIONS (RECEIVER)- TABULATED RESULTS					
CHARGING + RX MODE / ALL POSITIONS / ALL CHANNELS / FOR FREQ <1GHZ				EMI7267	
45.15	Vertical	34.22	20.3	40	-19.7
45.44	Vertical	34.67	21.05	40	-18.95
45.73	Vertical	35.12	21.32	40	-18.68
46.15	Vertical	34.39	20.25	40	-19.75
46.39	Vertical	34.15	20.18	40	-19.82
47.04	Vertical	35.73	21.71	40	-18.29
47.32	Vertical	35.77	21.26	40	-18.74
47.49	Vertical	35.44	21.71	40	-18.29
48.43	Vertical	35.32	21.74	40	-18.26
48.67	Vertical	35.56	21.71	40	-18.29
48.92	Vertical	34.94	22.61	40	-17.39
49.06	Vertical	35.13	22.51	40	-17.49
49.47	Vertical	34.31	22.09	40	-17.91
50.16	Vertical	34.23	21.59	40	-18.41
50.30	Vertical	34.08	21.17	40	-18.83
50.73	Vertical	33.61	21.1	40	-18.9
51.01	Vertical	33.69	20.75	40	-19.25
51.15	Vertical	33.68	20.14	40	-19.86
51.66	Vertical	33.42	19.95	40	-20.05
51.81	Vertical	33.39	19.89	40	-20.11
51.93	Vertical	32.68	19.72	40	-20.28
52.10	Vertical	33.11	19.71	40	-20.29
52.63	Vertical	32.64	19.34	40	-20.66
53.02	Vertical	32.16	19.03	40	-20.97

TEST SETUP PHOTO(S) – RX MODE / POSITION 1



TEST SETUP PHOTO(S) – RX MODE – POSITION 2



TEST SETUP PHOTO(S) – RX MODE – POSITION 3

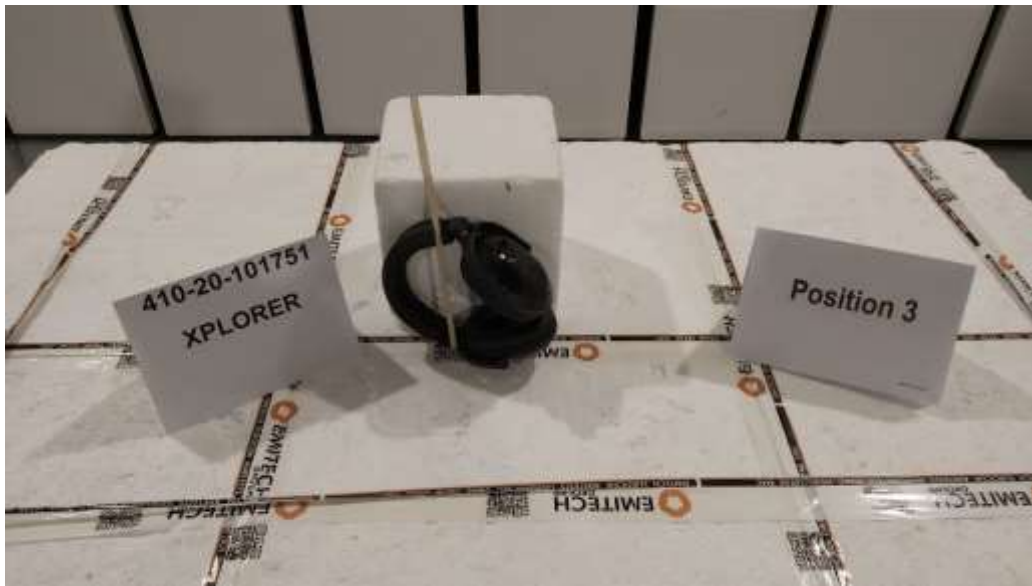

TEST SETUP PHOTO(S) – CHARGING + RX MODE – POSITION 1

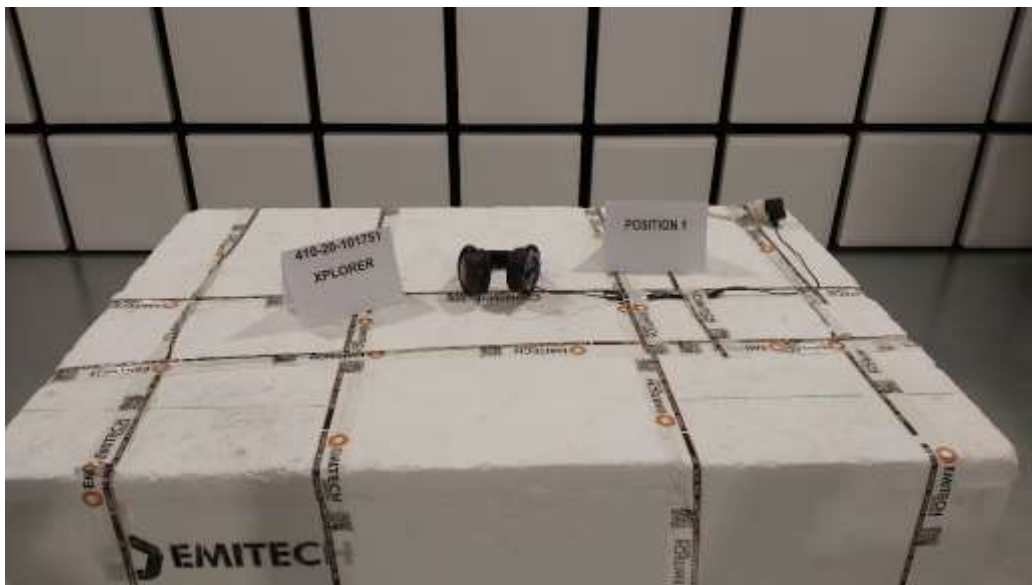

TEST SETUP PHOTO(S) - CHARGING + RX MODE – POSITION 2



TEST SETUP PHOTO(S) - CHARGING + RX MODE – POSITION 3



TEST SETUP PHOTO(S) – RX MODE – 30MHZ TO 200MHZ



TEST SETUP PHOTO(S) – RX MODE – 200MHZ TO 1GHZ





TEST SETUP PHOTO(S) – RX MODE – 1GHZ TO 18GHZ



TEST SETUP PHOTO(S) - RX MODE / 18GHZ TO 26.5GHZ



TRANSMITTER RADIATED SPURIOUS EMISSIONS AT FREQUENCIES >30MHZ - GRAPH			
RX MODE / ALL POSITIONS / ALL FREQ / FOR FREQ <1GHZ			EMI7266
EUT mode:	Rx mode		T (°C): 17.0
Test Date:	09/04/2021		H (%): 42.2
Test Operator:	ATO & OAT		P (hPa): 1007

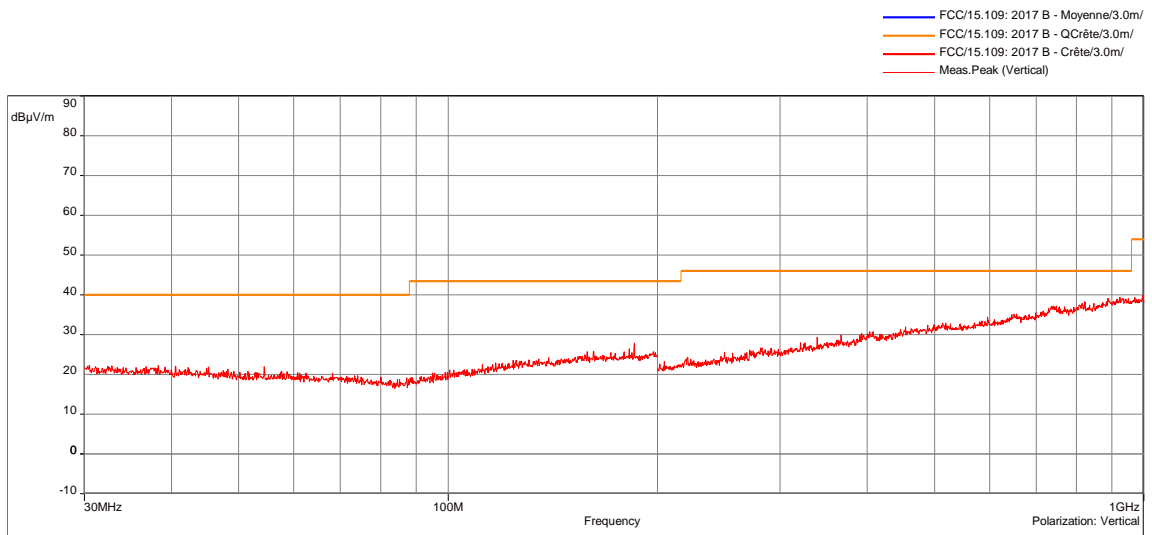

Rx mode / All Positions / All Freq / For freq <1GHz - 04/09/2021 10:56 - 7266

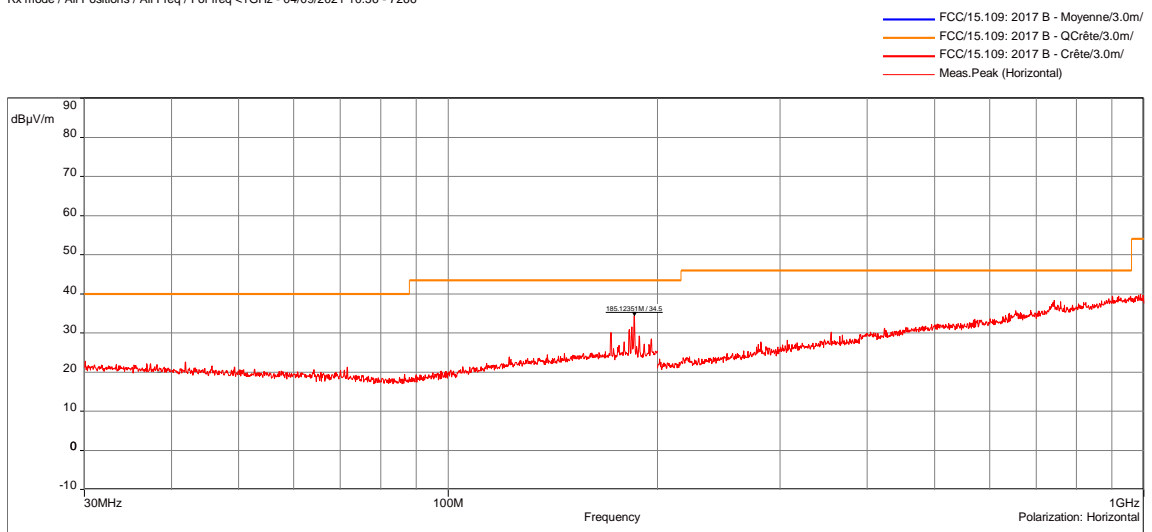

Rx mode / All Positions / All Freq / For freq <1GHz - 04/09/2021 10:56 - 7266

POSITION	FREQUENCIES	RBW	VBW	DETECTOR
Vertical	30MHz-200MHz	100kHz	300kHz	Peak
Horizontal	30MHz-200MHz	100kHz	300kHz	Peak
Vertical	200MHz-1GHz	100kHz	300kHz	Peak
Horizontal	200MHz-1GHz	100kHz	300kHz	Peak
Configuration:	N/A			
Comments:	N/A			
EUT modification(s): N/A				

TRANSMITTER RADIATED SPURIOUS EMISSIONS AT FREQUENCIES >30MHz - GRAPH			
CHARGING + RX MODE / ALL POSITIONS / ALL FREQ / FOR FREQ <1GHz			EMI7267
EUT mode:	Rx mode	T (°C):	17.0
Test Date:	09/04/2021	H (%):	42.2
Test Operator:	ATO & OAT	P (hPa):	1007

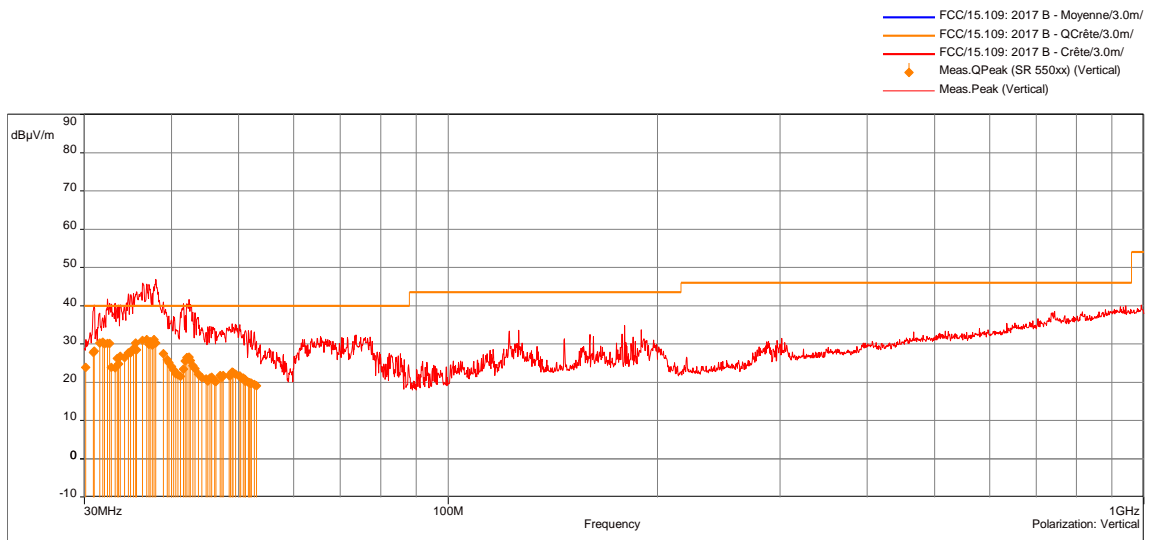

Charging + Rx mode / All Positions / All Freq / For freq <1GHz - 04/09/2021 12:02 - 7267

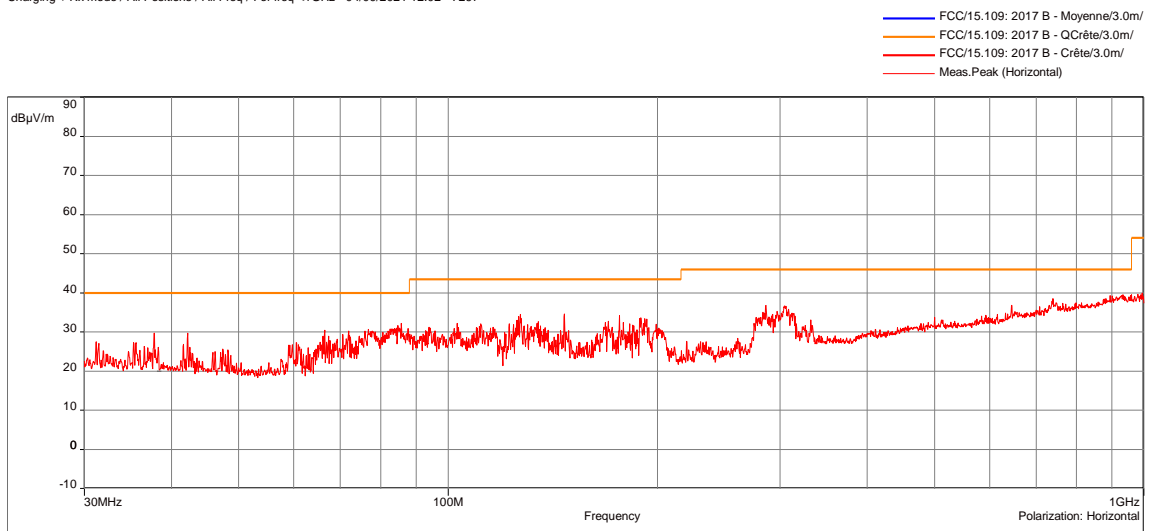

Charging + Rx mode / All Positions / All Freq / For freq <1GHz - 04/09/2021 12:02 - 7267

POSITION	FREQUENCIES	RBW	VBW	DETECTOR
Vertical	30MHz-200MHz	100kHz	300kHz	Peak
Horizontal	30MHz-200MHz	100kHz	300kHz	Peak
Vertical	200MHz-1GHz	100kHz	300kHz	Peak
Horizontal	200MHz-1GHz	100kHz	300kHz	Peak
<b>Configuration:</b>	N/A			
<b>Comments:</b>	N/A			
EUT modification(s): N/A				

**RECEIVER RADIATED SPURIOUS EMISSIONS AT FREQUENCIES >30MHz - GRAPH**

<b>RX MODE / ALL POSITIONS / ALL CHANNELS / 1GHz TO 18GHz</b>		<b>EMI7073</b>	
<b>EUT mode:</b>	Rx mode	<b>T (°C):</b>	23.7
<b>Test Date:</b>	26/03/2021	<b>H (%):</b>	35.9
<b>Test Operator:</b>	ATO & OAT	<b>P (hPa):</b>	1015

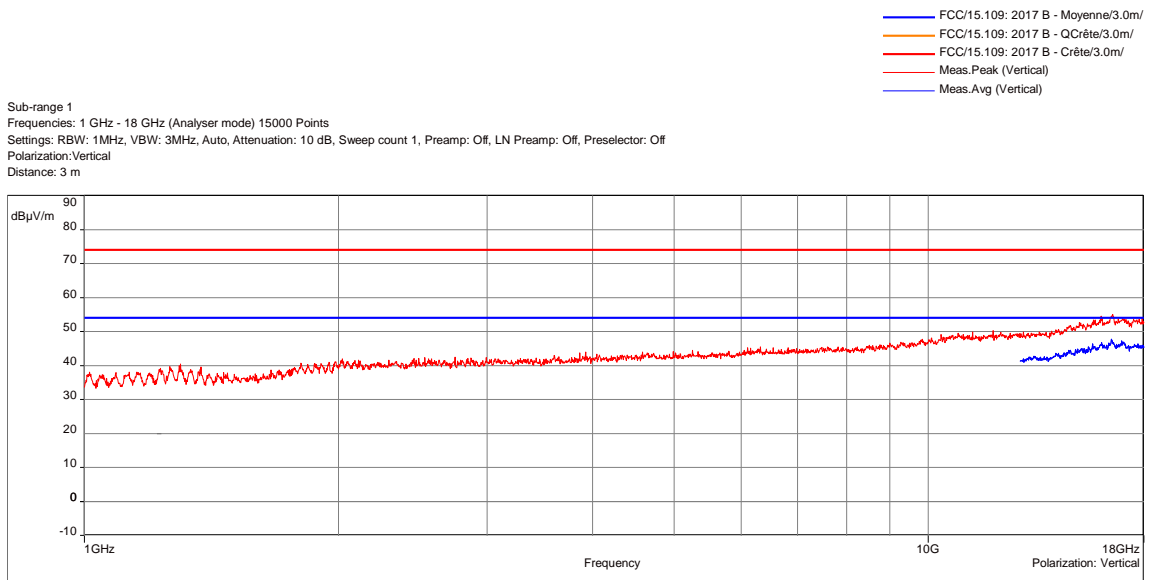

Rx mode / All Positions / All channels / 1GHz to 18GHz - 03/26/2021 13:26 - 7073

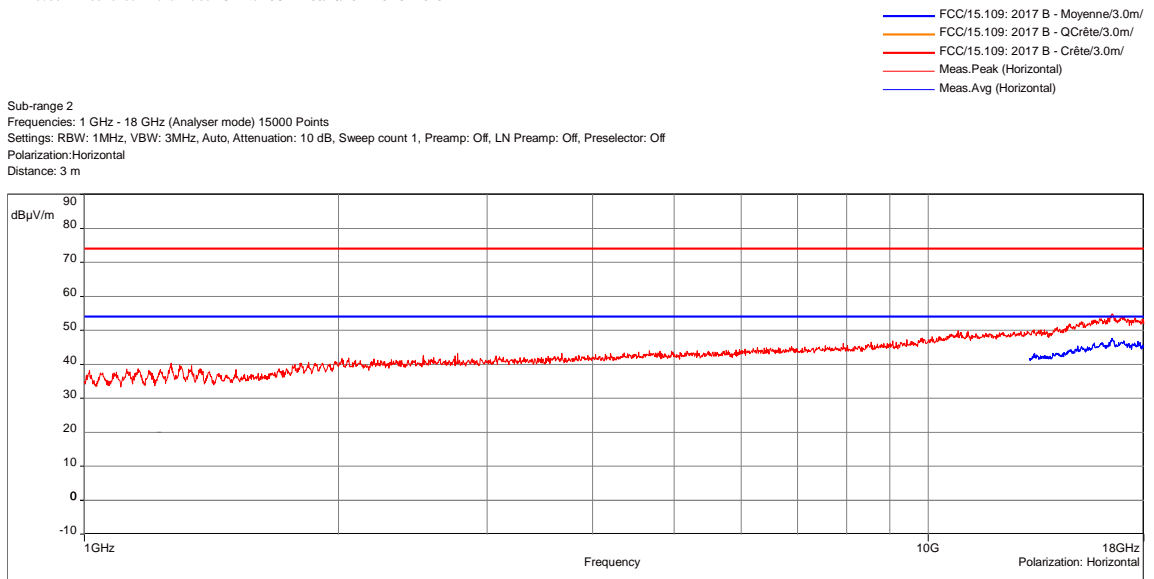

Rx mode / All Positions / All channels / 1GHz to 18GHz - 03/26/2021 13:26 - 7073

POSITION	FREQUENCIES	RBW	VBW	DETECTOR
Vertical	1GHz-18GHz	1MHz	3MHz	Peak
Horizontal	1GHz-18GHz	1MHz	3MHz	Peak
Vertical	10GHz-18GHz	1MHz	50kHz	Peak
Horizontal	10GHz-18GHz	1MHz	50kHz	Peak

**Configuration:** N/A

**Comments:** N/A

EUT modification(s): N/A

**RECEIVER RADIATED SPURIOUS EMISSIONS AT FREQUENCIES >30MHz - GRAPH**

<b>CHARGING + RX MODE / ALL POSITIONS / ALL CHANNELS / 1GHz TO 18GHz</b>		<b>EMI7075</b>	
<b>EUT mode:</b>	Rx mode	<b>T (°C):</b>	22.0
<b>Test Date:</b>	26/03/2021	<b>H (%):</b>	42.3
<b>Test Operator:</b>	ATO & OAT	<b>P (hPa):</b>	1015

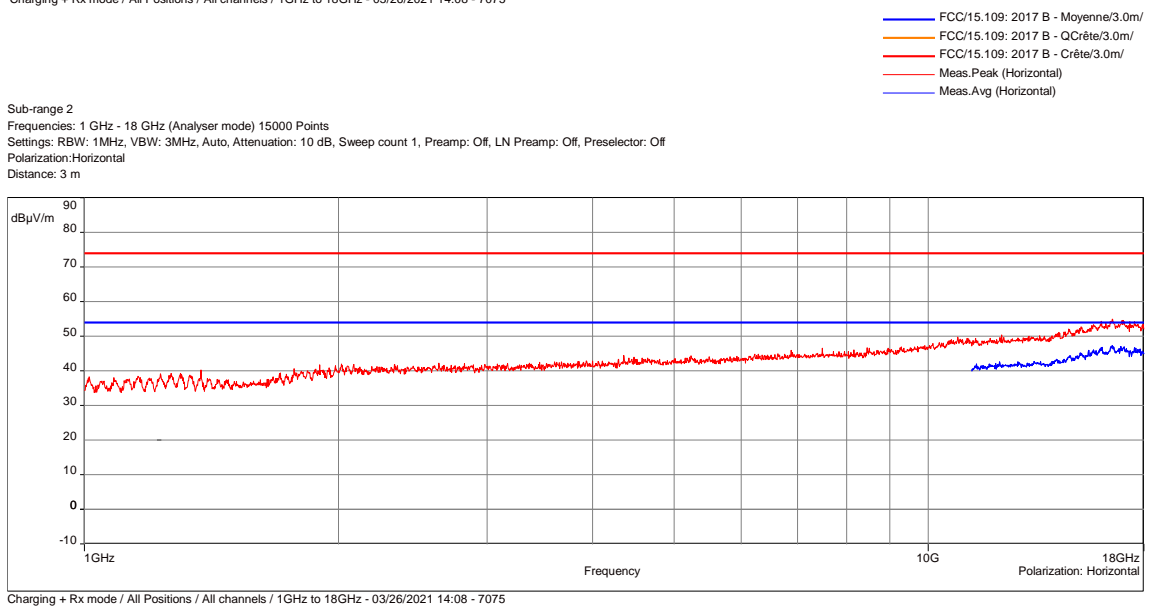
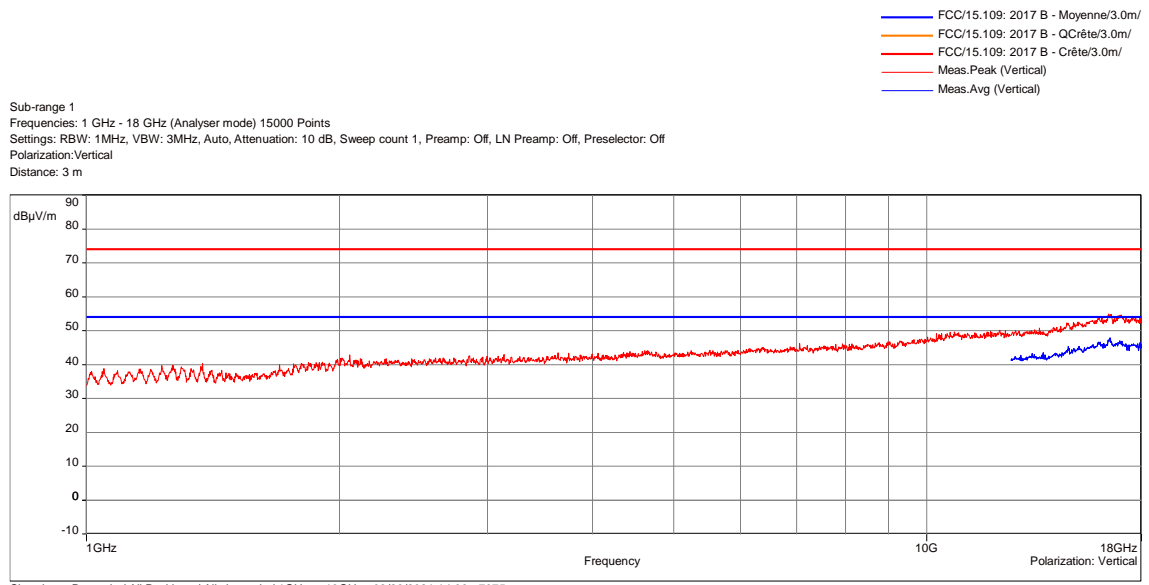

POSITION	FREQUENCIES	RBW	VBW	DETECTOR
Vertical	1GHz-18GHz	1MHz	3MHz	Peak
Horizontal	1GHz-18GHz	1MHz	3MHz	Peak
Vertical	10GHz-18GHz	1MHz	50kHz	Peak
Horizontal	10GHz-18GHz	1MHz	50kHz	Peak
<b>Configuration:</b>	N/A			
<b>Comments:</b>	N/A			
EUT modification(s): N/A				

TRANSMITTER RADIATED SPURIOUS EMISSIONS AT FREQUENCIES >30MHZ - GRAPH			
RX MODE / ALL POSITIONS / ALL CHANNELS / 18GHZ TO 26.5GHZ			EMI7300
EUT mode:	Rx mode	T (°C):	21.8
Test Date:	20/04/2021	H (%):	31.3
Test Operator:	ATO & OAT	P (hPa):	1012

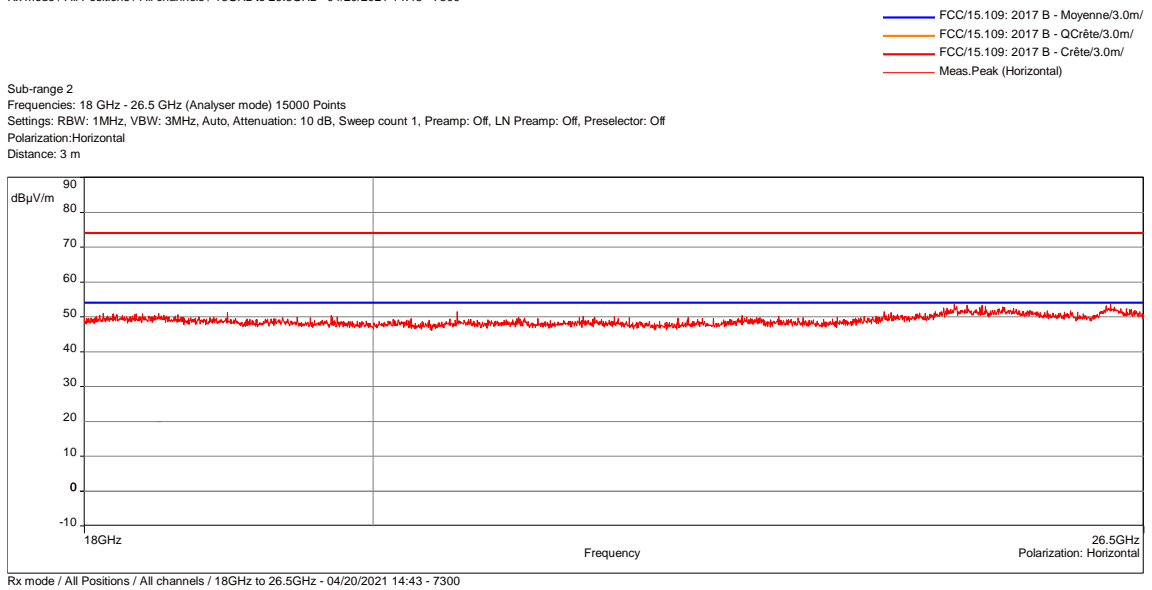
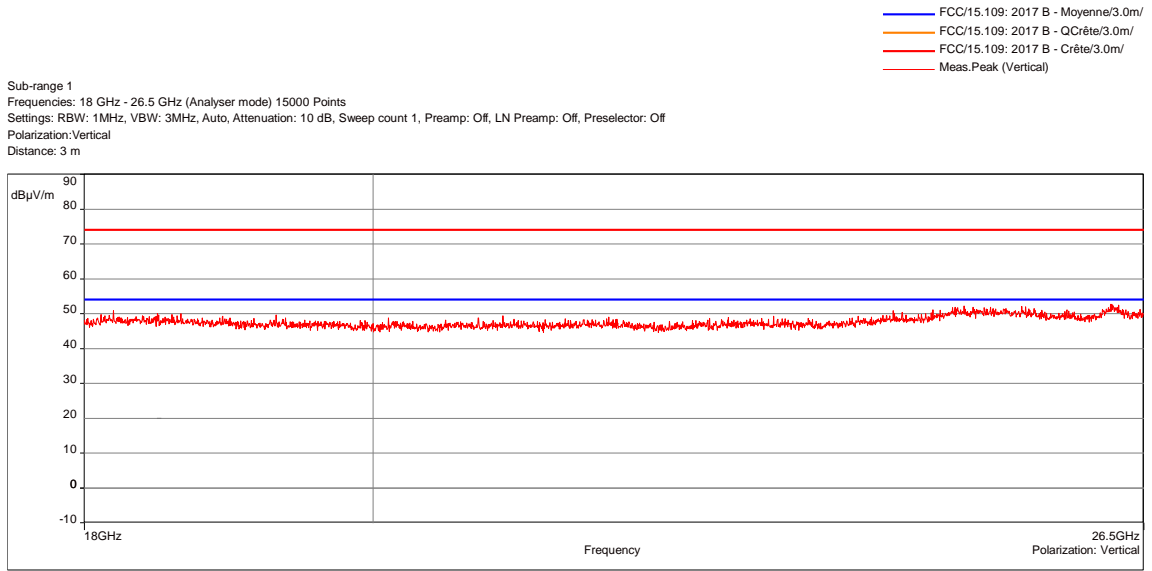

POSITION	FREQUENCIES	RBW	VBW	DETECTOR
Vertical	18GHz-26.5GHz	1MHz	3MHz	Peak
Horizontal	18GHz-26.5GHz	1MHz	3MHz	Peak
Configuration:	N/A			
Comments:	N/A			
EUT modification(s): N/A				

TRANSMITTER RADIATED SPURIOUS EMISSIONS AT FREQUENCIES >30MHZ - GRAPH			
CHARGING + RX MODE / ALL POSITIONS / ALL CHANNELS / 18GHZ TO 26.5GHZ			EMI7311
EUT mode:	Rx mode	T (°C):	21.8
Test Date:	20/04/2021	H (%):	31.3
Test Operator:	ATO & OAT	P (hPa):	1012

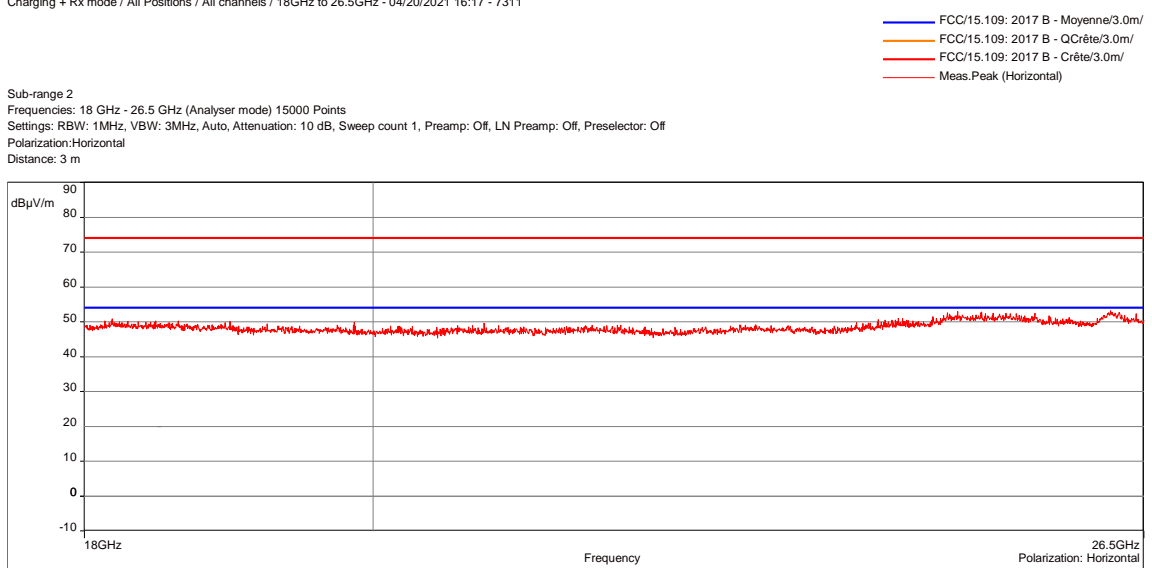
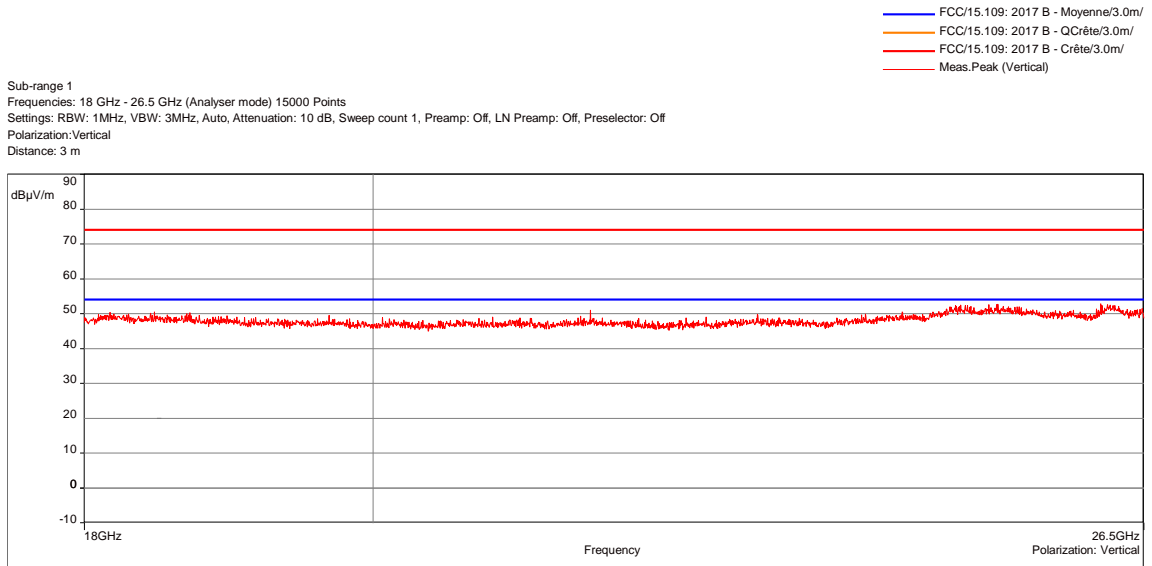

POSITION	FREQUENCIES	RBW	VBW	DETECTOR
Vertical	18GHz-26.5GHz	1MHz	3MHz	Peak
Horizontal	18GHz-26.5GHz	1MHz	3MHz	Peak
Configuration:	N/A			
Comments:	N/A			
EUT modification(s): N/A				

## 8.10. Frequency error

<b>Reference standard:</b>	FCC part 15 Radio part 15.215 and RSS Gen
<b>Test method:</b>	FCC part 15 Radio part 15.215 and RSS Gen
<p><b>Test description:</b> Frequency error is the difference between the measured unmodulated carrier frequency under extreme conditions and the nominal Centre Frequency as stated by the manufacturer. This measurement procedure only applies if the EUT can generate an unmodulated carrier.</p> <p>EUT is set inside the climatic enclosure. It is connected to the measuring receiver via 50Ω attenuator(s). RBW=200Hz</p>	

TEST CASE	EUT MODE	SEVERITY	RESULT TAB.	VERDICT
Low channel / 25°C/ 3.7Vdc	Continuous Tx	0.001 %	EMI7542	<b>PASS</b>
Low channel / 25°C/ 4.2Vdc	Continuous Tx	0.001 %	EMI7543	<b>PASS</b>
Low channel / 25°C/ 3.45Vdc	Continuous Tx	0.001 %	EMI7544	<b>PASS</b>
Mid channel / 25°C/ 3.7Vdc	Continuous Tx	0.001 %	EMI7545	<b>PASS</b>
Mid channel / 25°C/ 4.2Vdc	Continuous Tx	0.001 %	EMI7546	<b>PASS</b>
Mid channel / 25°C/ 3.45Vdc	Continuous Tx	0.001 %	EMI7547	<b>PASS</b>
High channel / 25°C/ 3.7Vdc	Continuous Tx	0.001 %	EMI7548	<b>PASS</b>
High channel / 25°C/ 4.2Vdc	Continuous Tx	0.001 %	EMI7549	<b>PASS</b>
High channel / 25°C/ 3.45Vdc	Continuous Tx	0.001 %	EMI7550	<b>PASS</b>
Low channel / -5°C/ 3.7Vdc	Continuous Tx	0.001 %	EMI7551	<b>PASS</b>
Low channel / -5°C/ 4.2Vdc	Continuous Tx	0.001 %	EMI7552	<b>PASS</b>
Low channel / -5°C/ 3.45Vdc	Continuous Tx	0.001 %	EMI7553	<b>PASS</b>
Mid channel / -5°C/ 3.7Vdc	Continuous Tx	0.001 %	EMI7554	<b>PASS</b>
Mid channel / -5°C/ 4.2Vdc	Continuous Tx	0.001 %	EMI7555	<b>PASS</b>
Mid channel / -5°C/ 3.45Vdc	Continuous Tx	0.001 %	EMI7556	<b>PASS</b>
High channel / -5°C/ 3.7Vdc	Continuous Tx	0.001 %	EMI7557	<b>PASS</b>
High channel / -5°C/ 4.2Vdc	Continuous Tx	0.001 %	EMI7558	<b>PASS</b>
High channel / -5°C/ 3.45Vdc	Continuous Tx	0.001 %	EMI7559	<b>PASS</b>
Low channel / 40°C/ 3.7Vdc	Continuous Tx	0.001 %	EMI7560	<b>PASS</b>
Low channel / 40°C/ 4.2Vdc	Continuous Tx	0.001 %	EMI7561	<b>PASS</b>
Low channel / 40°C/ 3.45Vdc	Continuous Tx	0.001 %	EMI7562	<b>PASS</b>
Mid channel / 40°C/ 3.7Vdc	Continuous Tx	0.001 %	EMI7563	<b>PASS</b>
Mid channel / 40°C/ 4.2Vdc	Continuous Tx	0.001 %	EMI7564	<b>PASS</b>
Mid channel / 40°C/ 3.45Vdc	Continuous Tx	0.001 %	EMI7565	<b>PASS</b>
High channel / 40°C/ 3.7Vdc	Continuous Tx	0.001 %	EMI7566	<b>PASS</b>
High channel / 40°C/ 4.2Vdc	Continuous Tx	0.001 %	EMI7567	<b>PASS</b>
High channel / 40°C/ 3.45Vdc	Continuous Tx	0.001 %	EMI7568	<b>PASS</b>

LABORATORY PARAMETERS:	REQUIRED PRIOR TO THE TEST	DURING THE TEST
Ambient Temperature	15 to 35 °C	22.1 °C
Relative Humidity	20 to 75 %	39.9 %
Atmospheric pressure	N/A	1014 hPa
<b>Test method deviation:</b> N/A		
Supplementary information: EUT power supply is replaced by a stabilized power supply.		



TEST EQUIPMENT USED					
CATEGORY	BRAND	TYPE	IDENTIFIER	CAL. DATE	CAL. DUE
Attenuator	Radiall	R412710124	17328	22/06/2020	22/08/2023
Attenuator	Radiall	R412710124	17329	22/06/2020	22/08/2023
Cable	N	3m	16421	04/05/2019	04/07/2021
Cable	Huber + Suhner	SF102K	16041	28/02/2019	28/04/2021
Cable	Radiall	SMA-0,5m	16557	30/07/2019	30/09/2021
Climatic enclosure	CLIMATS	EXCAL 7714-HA	14261	19/09/2019	19/11/2020
Multimeter	FLUKE	8808A	12446	29/09/2020	29/11/2021
Power supply	TTI	PL303QMD	8496		
Receiver	Rohde & Schwarz	FPL1003	16027	14/08/2020	14/10/2021
Thermo-Hygro-Baromètre	LUFFT	OPUS 20	14563	11/12/2019	11/02/2021
Thermohygrometer	Testo	608-H2	12268	07/05/2020	07/07/2022
Thermohygrometer	Bioblock Scientific	Météostar	0963	25/01/2019	25/03/2021
Wattmeter	Rohde & Schwarz	HMC 8015	17005	05/03/2020	05/05/2021

Blank cells = Permanent validity

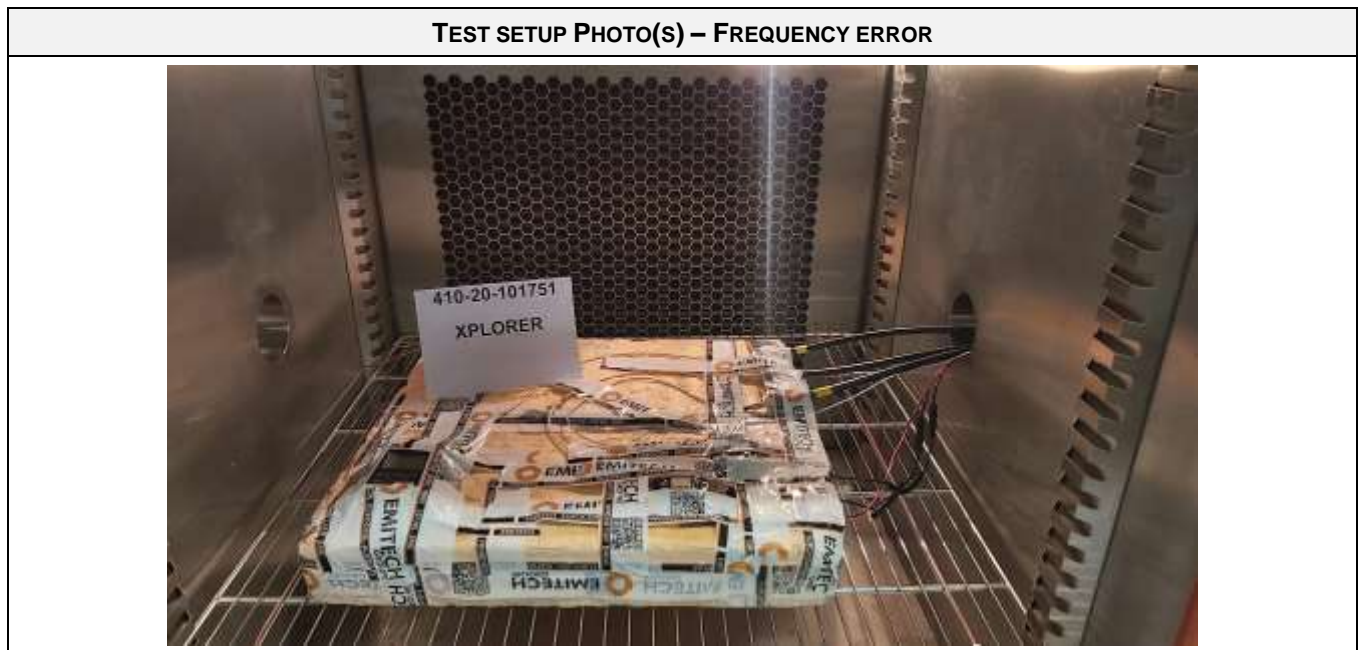

FREQUENCY ERROR - TABULATED RESULTS				
TEST CASE	FREQUENCY	FREQUENCY ERROR	LIMIT	RESULT TAB.
Low channel / 25°C/ 3.7Vdc	2.403968804GHz	0%	0.001 %	EMI7542
Low channel / 25°C/ 4.2Vdc	2.403968718GHz	0.0000036%	0.001 %	EMI7543
Low channel / 25°C/ 3.45Vdc	2.403968867GHz	0.0000026%	0.001 %	EMI7544
Mid channel / 25°C/ 3.7Vdc	2.439968068GHz	0%	0.001 %	EMI7545
Mid channel / 25°C/ 4.2Vdc	2.439968053GHz	0.0000006%	0.001 %	EMI7546
Mid channel / 25°C/ 3.45Vdc	2.439968036GHz	0.0000013%	0.001 %	EMI7547
High channel / 25°C/ 3.7Vdc	2.475967502GHz	0%	0.001 %	EMI7548
High channel / 25°C/ 4.2Vdc	2.475967495GHz	0.0000003%	0.001 %	EMI7549
High channel / 25°C/ 3.45Vdc	2.475967485GHz	0.0000007%	0.001 %	EMI7550
Low channel / -5°C/ 3.7Vdc	2.403971521GHz	0.0001130%	0.001 %	EMI7551
Low channel / -5°C/ 4.2Vdc	2.403971450GHz	0.0001101%	0.001 %	EMI7552
Low channel / -5°C/ 3.45Vdc	2.403971356GHz	0.0001062%	0.001 %	EMI7553
Mid channel / -5°C/ 3.7Vdc	2.439971167GHz	0.0001270%	0.001 %	EMI7554
Mid channel / -5°C/ 4.2Vdc	2.439970994GHz	0.0001199%	0.001 %	EMI7555
Mid channel / -5°C/ 3.45Vdc	2.439970953GHz	0.0001182%	0.001 %	EMI7556
High channel / -5°C/ 3.7Vdc	2.475970233GHz	0.0001103%	0.001 %	EMI7557
High channel / -5°C/ 4.2Vdc	2.475970203GHz	0.0001091%	0.001 %	EMI7558
High channel / -5°C/ 3.45Vdc	2.475970159GHz	0.0001073%	0.001 %	EMI7559
Low channel / 40°C/ 3.7Vdc	2.403960099GHz	0.0003621%	0.001 %	EMI7560
Low channel / 40°C/ 4.2Vdc	2.403960086GHz	0.0003627%	0.001 %	EMI7561
Low channel / 40°C/ 3.45Vdc	2.403960082GHz	0.0003628%	0.001 %	EMI7562
Mid channel / 40°C/ 3.7Vdc	2.439959512GHz	0.0003507%	0.001 %	EMI7563
Mid channel / 40°C/ 4.2Vdc	2.439959482GHz	0.0003519%	0.001 %	EMI7564
Mid channel / 40°C/ 3.45Vdc	2.439959482GHz	0.0003519%	0.001 %	EMI7565
High channel / 40°C/ 3.7Vdc	2.475958952GHz	0.0003453%	0.001 %	EMI7566
High channel / 40°C/ 4.2Vdc	2.475958949GHz	0.0003454%	0.001 %	EMI7567
High channel / 40°C/ 3.45Vdc	2.475958944GHz	0.0003456%	0.001 %	EMI7568

End of test report