



Test report issued under the responsibility of:
EMITECH MONTPELLIER laboratory
MRA US-EU Designation Number: FR0006
Canadian CAB Identifier: FR0003

RADIO TEST REPORT

FCC 47 CFR PART 15.247
RSS-247_Issue 2, February 2017

Company : **XPLORER**
Address..... : 40 chemin du Moulin
31320 MERVILLA
FRANCE

Test item description : **Remote control for wireless metal detection system**
Trade Mark : DEUS II
Manufacturer..... : XPLORER
Model/Type reference..... : XPRSW / Remote control DEUS II
FCC ID..... : XFJRSW
IC : 8392A-RSW
Ratings..... : 3.45Vdc to 4.2Vdc

Testing Laboratory : **EMITECH MONTPELLIER laboratory**
Address..... : 145 rue de Massacan
34740 VENDARGUES
FRANCE

Report Reference No..... : **RR410-20-101751-17A**
Test procedure : FCC IC Certification
Diffusion..... : Mr LOUBET
Applicant's name : XPLORER
Date of issue..... : October 21, 2021
Total number of pages..... : 108
Revision : 0
Modified page(s)..... : Creation
Compiled by..... : Alexis TOUZET
Approved by (+ signature) : Olivier HEYER (Laboratory Manager)

Duplication of this test report is only permitted for an integral photographic facsimile. It includes the number of pages referenced here above. This document is the result of testing a specimen or a sample of the product submitted. It does not imply an assessment of the conformity of the whole manufactured products of the tested sample.

REPORT INDEX:	
1. GENERAL INFORMATIONS	3
2. REFERENCE DOCUMENT(S).....	4
3. EQUIPMENT TECHNICAL DESCRIPTION.....	5
3.1. TEST CONDITIONS	5
3.2. EUT MARKING PLATE	5
3.3. EUT GENERAL VIEW.....	6
3.4. EUT MECHANICAL AND ELECTRICAL DESIGN.....	7
3.5. EUT INPUT/OUTPUT PORTS.....	7
3.6. SUPPORTING EQUIPMENT USED DURING TEST.....	8
3.7. EUT RADIO SPECIFICATIONS.....	9
4. OPINION(S) AND INTERPRETATION(S)	10
5. RESULT SUMMARY	11
6. MEASUREMENT UNCERTAINTY	14
7. RF EXPOSURE	15
8. TEST CONDITIONS AND RESULTS	15
8.1. CONDUCTED EMISSION (MEASUREMENT).....	15
8.2. 6dB BANDWIDTH.....	19
8.3. OCCUPIED BANDWIDTH.....	24
8.4. MAXIMUM EFFECTIVE ISOTROPIC RADIATED POWER	29
8.5. BAND-EDGE COMPLIANCE.....	37
8.6. POWER SPECTRAL DENSITY.....	43
8.7. TRANSMITTER RADIATED SPURIOUS EMISSIONS AT FREQUENCIES <30MHZ.....	52
8.8. TRANSMITTER RADIATED SPURIOUS EMISSIONS AT FREQUENCIES >30MHZ.....	62
8.9. RADIATED SPURIOUS EMISSIONS (RECEIVER).....	90
8.10. FREQUENCY ERROR.....	106

REVISION HISTORY:			
Revision	Date	Modified pages	Modifications
0	October 21, 2021	/	Creation

1. GENERAL INFORMATIONS

This document submits the results of Radio tests performed on the equipment **Remote control for wireless metal detection system DEUS II** (denominated hereafter E.U.T.: equipment under test) according to document(s) listed in §2 of this test report.

TESTING PROCEDURE AND TESTING LOCATION:					
Testing Location	EMITECH MONTPELLIER laboratory				
Address.	145 rue de Massacan 34740 VENDARGUES FRANCE				
Test procedure.	FCC IC Certification				
Tested by	Olivier AELBRECHT & Alexis TOUZET				
Test supervisor	Olivier AELBRECHT				
Date of receipt of test item	N/A				
Date (s) of performance of tests	From February the 15 th of 2021 to April the 30 th of 2021				
APPLICANT'S GENERAL INFORMATIONS:					
Company name	XPLOER				
Company address.	40 chemin du Moulin 31320 MERVILLA FRANCE				
Person(s) present during the tests.	No representative for company attended the tests.				
Responsible.	Mr LOUBET				
GENERAL REMARKS:					
<p>The information in italics is declared by the manufacturer and is under his responsibility The test results presented in this report relate only to the object tested. The results contained in this report reflect the results for this particular model and serial number. It is the responsibility of the manufacturer to ensure that all production models meet the intent of the requirements detailed within this report.</p> <p>"(see Enclosure #)" refers to additional information appended to the report. "(see appended table)" refers to a table appended to the report. Throughout this report the decimal separator is point.</p>					
POSSIBLE TEST CASE VERDICTS:					
Test case does not apply to the test object.:	N/A				
Test case not performed.....	N/P				
Test object does meet the requirement.....	P (Pass)				
Test object does not meet the requirement.	F (Fail)				
DEFINITIONS AND ABBREVIATIONS:					
E.U.T.	Equipment under test	AE	Ancillary equipment	Pk	Peak detector
RBW	Resolution bandwidth	VBW	Video bandwidth	QP	Quasi-peak detector
OATS	Open area test site	FAR	Full anechoic room	Av	Average detector
VP	Vertical Polarization	HP	Horizontal Polarization	RMS	Root Mean Square
RF	Radio frequency	NTR	Nothing to report	N/C	Not communicated

2. REFERENCE DOCUMENT(S)

NORMATIVE REFERENCES:

The following referenced documents are necessary for the application of the present test report.

FCC 47 CFR PART 15: 2017

Code of federal regulations – Title 47 telecommunication
Part 15- Radio frequency devices

FCC part 15.247

Operation within the bands 902–928 MHz, 2400–2483.5 MHz, and 5725–5850MHz. (frequency hopping and digitally modulated)

RSS-247_Issue 2, February 2017

Digital Transmission Systems (DTSs), Frequency Hopping Systems (FHSs) and Licence Exempt Local Area Network (LE-LAN) Devices

RSS/CNR-Gen, Issue 5, April 2018, Amd1: 2019, Amd2: 2021

Exigences générales et information relatives à la certification du matériel de radiocommunication

ANSI C 63.10:2013

American National Standard of Procedures for Compliance Testing of Unlicensed Wireless Devices

ANSI C 63.4:2014

American National Standard for Methods of measurement of Radio-Noise from low-voltage Electrical and Electronic Equipment in the Range of 9 kHz to 40 GHz

Although the product standard uses obsolete technical standards, the latest versions of standards achievable by the laboratory will be used for testing.

INFORMATIVE REFERENCES:

The following referenced documents are not necessary for the application of the present test report but they assist the user with regard to a particular subject area.

3. EQUIPMENT TECHNICAL DESCRIPTION

3.1. Test Conditions

Test item description. : Remote control for wireless metal detection system
Model/Type reference..... : XPRSW / Remote control DEUS II
Trade Mark. : DEUS II
FCC ID..... : XFJRSW
IC. : 8392A-RSW
Serial number (S/N)..... : Not communicated
Part number (P/N). : Not communicated
Software version..... : 20210126
Firmware version. : *Not communicated*
Type of sample. : Pre-serial
Function(s)..... : Remote control for wireless object detection system
Manufacturer name. : XPLOER
Address. : 8 rue du Développement - ZI de Vic
31320 CASTANET-TOLOSAN
FRANCE

General product information:

N/A

3.2. EUT Marking plate

No marking plate on EUT during tests

3.3.EUT General view



3.4. EUT Mechanical and Electrical Design

Power supply..... : 3.7Vdc
 Power supply range..... : 3.45Vdc to 4.2Vdc
 Power type..... : Battery powered
 Power (W)..... : 5
 Nominal current (A). : 1
 Dimensions (L x W x H) (m). : 0.11x0.07x0.02
 Weight (kg). : 0.15
 Temperature range (°C). : -5°C to +40°C
 Ground bounding strap..... : No

Comments:

N/A

3.5. EUT Input/Output ports

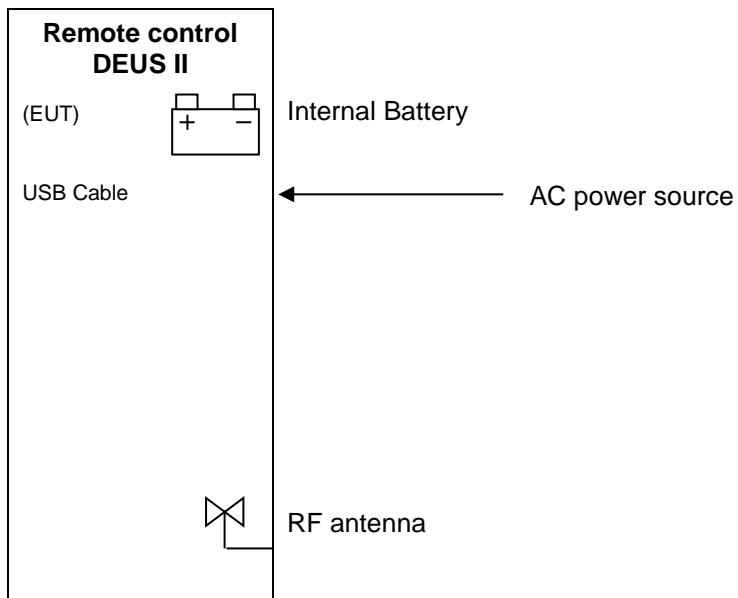

PORT	NAME	TYPE	LENGTH	CABLE TYPE	COMMENTS
0	Main frame	N/E	N/A	Plastic	
1	Battery	DC	N/A	N/A	
2	AC power source	AC/DC	1m	2P	
3	RF antenna	RF	N/A	N/A	2.4GHz

AC/DC : AC/DC Converter port AC..... : Alternative current port DC..... : Discontinuous current port
 I/O : Input or Output port TP : Telecommunication port RF : Radio frequency port
 N/E : Non Electrical port

3.6. Supporting Equipment Used During Test

Sample subject to the tests was tested with following equipment.

PRODUCT TYPE	MANUFACTURER	MODEL	N°EMITECH / COMMENTS
Battery charger (AC/DC)	Sinohero Industrial Ltd.	SJ-0510-E	Used for conducted emission

BATTERY CHARGER (AC/DC) (AE)



3.7. EUT Radio Specifications

a) GENERAL INFORMATIONS	
According to manufacturer's declarations :	
EUT type.....	<i>Transmitter</i>
Technology	<i>SRD 2.4GHz</i>
Environmental profile.....	<i>Data transmissions</i>
Temperature range.....	<i>-5°C to +40°C</i>
Antenna type	<i>Integral</i>
Antenna Gain.....	<i>Not communicated</i>
Comments:	
<i>N/A</i>	
b) TRANSMITTER PARAMETERS (Tx)	
Frequency bands.....	<i>2400 MHz to 2483.5MHz</i>
RF Power.....	<i>Not communicated</i>
Number of channels / Separation	<i>Multiple</i>
Modulation type	<i>GFSK</i>
Duty cycle	<i>Not communicated</i>
Tested frequency.....	<i>2404MHz Low channel</i> <i>2440MHz Mid channel</i> <i>2476MHz High channel</i>
c) RECEIVER PARAMETERS (Rx)	
Frequency bands.....	<i>2400 MHz to 2483.5MHz</i>
Category/Class	<i>Category 2</i>
Bandwidth.....	<i>2404MHz to 2476MHz</i>

4. OPINION(S) AND INTERPRETATION(S)

TEST(S) PERFORMED	DEVIATION(S) TO TEST METHOD(S)
FCC part 15.247 subclause d) and RSS-247	N/A
FCC part 15.247 and RSS-247	N/A
FCC part 15.109, 15.209, 15.205, 15.215, CNR-Gen	N/A
FCC part 15.109, 15.209, 15.205, 15.215, CNR-Gen	The EUT is encapsulated in a casing. We were not able to measure its voltage supply during radiated tests
FCC part 15.109, 15.209, 15.205, 15.215 RSS-247, CNR Gen	N/A
FCC part 15 Radio part 15.215 and RSS Gen	N/A
ANSI C63.4: 2014	N/A

Comments: N/A

5. RESULT SUMMARY

TEST DESIGNATION	SEVERITY	VERDICT	BASIC STANDARDS / COMMENTS
SUBPART A - GENERAL			
Labeling requirements		PASS	15.19 / See certification documents
Information to user		PASS	15.21 / See certification documents
Home-built devices		N/A	15.23
Kits		N/A	15.25
Special Accessories		PASS	15.27 / See certification documents
Inspection by the Commission		N/A	15.29
Measurement standards		PASS	15.31
Test procedure for CPU boards and computer power supplies		N/A	15.32
Frequency range of radiated measurements		PASS	15.33
Measurement detector functions and bandwidths		PASS	15.35
Transition provisions for compliance with the rules		PASS	15.37 / See certification documents
SUBPART B – UNINTENTIONAL RADIATORS			
Equipment authorization			15.101
- Verification		N/A	
- Declaration of Conformity		N/A	
CPU boards and power supplies used in personal computers		N/A	15.102
Exempted device		N/A	15.103
Information to the user		PASS	15.105 / See certification documents
Conducted limits	Class B	PASS	15.107
Radiated emission limits	Class B	PASS	15.109
Antenna power conduction limits for receivers		N/A	15.111
Power line carrier systems		N/A	15.113
TV interface devices, including cable system terminal devices		N/A	15.115
TV broadcast receivers		N/A	15.117
Cable ready consumer electronics equipment		N/A	15.118
Program blocking technology requirements for TV receivers		N/A	15.120
Scanning receivers and frequency converters used with scanning receivers		N/A	15.121
Labeling of digital cable ready products		N/A	15.123

TEST DESIGNATION	SEVERITY	VERDICT	BASIC STANDARDS / COMMENTS
SUBPART C –INTENTIONAL RADIATORS			
Equipment authorization requirement		PASS	15.201 / Transmitter part is subject to Certification procedure
Certified operating frequency range		N/A	15.202
Antenna requirement		PASS	15.203 / Dedicated and glued antenna
External radio frequency power amplifiers and antenna modifications		N/A	15.204
Restricted bands of operation		PASS	15.204
Conducted limits	Class B	PASS	15.207
Radiated emission limits; general requirements	Class B	PASS	15.209
Tunnel radio systems		N/A	15.211
Modular transmitters		N/A	15.212
Cable locating equipment		N/A	15.213
Cordless telephones		N/A	15.214
Additional provisions to the general radiated emission limits		PASS	15.215
Operation within the band 902-928MHz, 2400-2483.5MHz and 5725-5850MHz			15.247
- Frequency hopping and digitally modulated		-	a)
- Frequency hopping system		N/A	a) (1)
- Digital modulation system		PASS	a) (2)
- Maximum peak conducted output power		-	b)
- For hopping system in the 2400-2483.5 MHz and 5725-5850 MHz bands		N/A	b) (1)
- For hopping system in the 902-928MHz band		N/A	b) (2)
- For system using digital modulation in the 902-928 MHz, 2400-2483.5 MHz and 5725-5850 MHz bands		PASS	b) (3)
- Operation with directional antenna gains > 6 dBi		N/A	c)
- Out-of-band emissions		PASS	d)
- Power spectral density conducted		PASS	e)
- Hybrid system		N/A	f)
- Frequency hopping additional requirements		N/A	g)
- Frequency hopping intelligence		N/A	h)
- RF exposure compliance		PASS	i)

Sample subject to the test complies with the requirements of the reference document(s) listed in §2 of this test report and, where applicable, with deviation(s) specified in this document.

To declare, or not, the compliance with the specifications, it was not explicitly taken account of uncertainty associated with the results.

Opinion(s) and interpretation(s): N/A

TEST(S) PERFORMED	MODIFICATION(S)
FCC part 15.247 subclause d) and RSS-247	N/A
FCC part 15.247 and RSS-247	N/A
FCC part 15.109, 15.209, 15.205, 15.215, CNR-Gen	N/A
FCC part 15.109, 15.209, 15.205, 15.215 RSS-247, CNR Gen	N/A
FCC part 15 Radio part 15.215 and RSS Gen	N/A
ANSI C63.4: 2014	N/A

6. MEASUREMENT UNCERTAINTY

PARAMETER	MAXIMAL EMITECH UNCERTAINTY	MINIMAL STANDARD UNCERTAINTY
Radio frequency	$\pm 1 \times 10^{-7}$	$\pm 1 \times 10^{-7}$
RF power, conducted		
RF power	$\pm 0.8\text{dB}$	$\pm 1 \text{ dB}$
RF power (EN 300328 / EN 301893)	$\pm 1.3\text{dB}$	$\pm 1.5 \text{ dB}$
Power spectral density	$\pm 2.3\text{dB}$	$\pm 3 \text{ dB}$
Occupied bandwidth		
RF power	$\pm 3.8 \%$	$\pm 5 \%$
RF power (EN 300328 / EN 301893)	$\pm 3.8 \%$	$\pm 5 \%$
Maximum frequency deviation		
300 Hz < audio frequency < 6 kHz	$\pm 1.2 \%$	$\pm 5 \%$
6 kHz < audio frequency < 25 kHz	$\pm 1.2 \%$	$\pm 3 \text{ dB}$
Adjacent channel power	$\pm 1.6 \text{ dB}$	$\pm 3 \text{ dB}$
Sensibility of receiver (conducted)	$\pm 2.0 \text{ dB}$	$\pm 3 \text{ dB}$
Blocking	$\pm 4.0 \text{ dB}$	$\pm 4 \text{ dB}$
Transient		
Amplitude	$\pm 8.5 \%$	$\pm 20 \%$
At the frequency	$\pm 166 \text{ Hz}$	$\pm 250 \text{ Hz}$
Conducted emission (spurious)		
$f \leq 1 \text{ GHz}$	$\pm 0.8 \text{ dB}$	
1 GHz - 12.75 GHz	$\pm 1.6 \text{ dB}$	$\pm 3 \text{ dB}$
Radiated emission (PAR / PIRE / RNE)		
$f \leq 62.5 \text{ MHz}$	$\pm 5.1 \text{ dB}$	$\pm 6 \text{ dB}$
62.5 MHz - 1 GHz	$\pm 5.1 \text{ dB}$	$\pm 6 \text{ dB}$
1 GHz - 18 GHz	$\pm 5.2 \text{ dB}$	$\pm 6 \text{ dB}$
18 GHz – 26 GHz	$\pm 5.1 \text{ dB}$	$\pm 6 \text{ dB}$
26 GHz – 40 GHz	$\pm 5.4 \text{ dB}$	$\pm 6 \text{ dB}$
180-1000 MHz / 1 – 12.75 GHz (EN 301 908-1)	$\pm 3.0 / 2.9 \text{ dB}$	$\pm 3 \text{ dB}$
RF power (EN 300328 / EN 301893)	$\pm 5.3 \text{ dB}$	$\pm 6 \text{ dB}$
PIRE and power spectral density with diode	$\pm 5.2 \text{ dB}$	$\pm 6 \text{ dB}$
Radiated emission (magnetic field)		
9kHz – 30MHz	$\pm 3 \text{ dB}$	$\pm 6 \text{ dB}$
RF level for a given BER	$\pm 0.8 \text{ dB}$	$\pm 1.5 \text{ dB}$
Supply voltages	$\pm 3 \%$	$\pm 3 \%$
Temperature	$\pm 1 \text{ }^\circ\text{C}$	$\pm 1^\circ\text{C}$
Humidity	$\pm 5 \%$	$\pm 5 \%$
Time / Duty cycle	$\pm 4.4 \%$	$\pm 5 \%$
Adaptivity	$\pm 2.9 \text{ dB}$	/
Conducted emission (FCC)		
(Artificial Mains Network) 150kHz – 30MHz	$\pm 3.4 \text{ dB}$	$\pm 3.4 \text{ dB}$
Radiated emission (electric field for FCC standard)		
9kHz – 30MHz	$\pm 2.7 \text{ dB}$	/
30MHz – 1GHz	$\pm 5.0 \text{ dB}$	/
1GHz – 18GHz	$\pm 5.6 \text{ dB}$	/
18GHz – 26GHz	$\pm 5.7 \text{ dB}$	/
26GHz – 40GHz	$\pm 5.7 \text{ dB}$	/

For the calculation of expanded uncertainty, the confidence interval is 95 % (k=2).

7. RF EXPOSURE

Maximum EIRP = 3.89 dBm (2.449 mW) at 2404 MHz

In accordance with KDB 447498 D01 General RF Exposure Guidance v06:

$PSD = EIRP / (4 * \pi * R^2) = 2.449 / (4 * \pi * (20 \text{ cm})^2) = 0.000487 \text{ mW/cm}^2$

Limit = 1 mW/cm²

8. TEST CONDITIONS AND RESULTS

8.1. Conducted emission (measurement)

Reference standard:	FCC part 15.107, 15.207 and RSS-Gen
Test method:	ANSI C63.4: 2014
<p>General test setup: EUT is set on an insulating support at 80cm from the ground reference plane. All power was connected to the system through Artificial Mains Network (AMN). The AMN is placed at 80cm from the boundary of the EUT and bonded to a ground reference plane.</p> <p>All tested telecommunications lines (if applicable) were connected to an Asymmetric Artificial Network (AAN) and conducted voltage measurements on telecommunications lines were made at the output of the AAN.</p> <p>Where an AAN was not appropriate or available, measurements were made using a Capacitive Voltage Probe and/or a Current probe.</p> <p>Additional ground terminals (if any) are connected to earth terminal of the AMN.</p>	

TESTED CABLE	PARAMETER	SEVERITY	RESULT TAB.	VERDICT
120Vac/60Hz power supply / All channels	150kHz-30MHz	Class B	EMI7570	PASS
120Vac/60Hz power supply / Charging mode	150kHz-30MHz	Class B	EMI7575	PASS

LABORATORY PARAMETERS:	REQUIRED PRIOR TO THE TEST	DURING THE TEST
Ambient Temperature	15 to 35 °C	See Graph(s)
Relative Humidity	30 to 60 %	See Graph(s)
Atmospheric pressure	N/A	See Graph(s)
Test method deviation: N/A		
Supplementary information: N/A		

TEST EQUIPMENT USED					
CATEGORY	BRAND	TYPE	IDENTIFIER	CAL. DATE	CAL. DUE
Cable	EMITECH	Current absorber sheath	9491	23/06/2020	23/08/2022
Cable	C&C	N-3m	14331	18/03/2021	18/05/2023
LISN	PMM	L2-16	1209	08/06/2020	08/08/2022
Receiver	Rohde & Schwarz	ESHS10	3371	27/04/2020	27/06/2021
Receiver	Rohde & Schwarz	FPL1003	16027	14/08/2020	14/10/2021
Software	Nexio		0000		
Surges Suppressor	Hewlett Packard	11947A	0238	20/12/2019	20/02/2023
Thermohygrometer	Testo	608-H1	7562	26/01/2019	26/09/2021
Thermohygrometer	Bioblock Scientific	Météostar	0963	26/01/2019	26/09/2021

BAT-EMC software version: V3.18.0.26

Blank cells = Permanent validity



CONDUCTED EMISSION (MEASUREMENT) - GRAPH				
120VAC/60HZ POWER SUPPLY / ALL CHANNELS			EMI7570	
EUT mode:	Tx mode		T (°C):	22.3
Test Date:	30/04/2021		H (%):	56.5
Test Operator:	ATO		P (hPa):	1004
<ul style="list-style-type: none"> — FCC/15.207: 2018 B - Moyenne/ — FCC/15.207: 2018 B - QCrête/ — Meas.Peak (Phase 1) — Meas.Avg (Phase 1) 				
120Vac/60Hz power supply / All Channels - 04/30/2021 14:53 - 7570				
<ul style="list-style-type: none"> — FCC/15.207: 2018 B - Moyenne/ — FCC/15.207: 2018 B - QCrête/ — Meas.Peak (Neutral) — Meas.Avg (Neutral) 				
120Vac/60Hz power supply / All Channels - 04/30/2021 14:53 - 7570				
POSITION	FREQUENCIES	RBW	VBW	DETECTOR
Neutral	150kHz-1MHz	10kHz	30kHz	Peak
Neutral	1MHz-10MHz	10kHz	30kHz	Peak
Neutral	10MHz-30MHz	10kHz	30kHz	Peak
Phase 1	150kHz-1MHz	10kHz	30kHz	Peak
Phase 1	1MHz-10MHz	10kHz	30kHz	Peak
Phase 1	10MHz-30MHz	10kHz	30kHz	Peak
Neutral	150kHz-200kHz	10kHz	30kHz	Average
Phase 1	150kHz-200kHz	10kHz	30kHz	Average
Neutral	20MHz-30MHz	10kHz	30kHz	Average
Measure with:	A.M.N.			
Comments:	N/A			
EUT modification(s): N/A				

CONDUCTED EMISSION (MEASUREMENT) - GRAPH			
120VAC/60HZ POWER SUPPLY / CHARGING MODE			EMI7575
EUT mode:	Charging mode	T (°C):	22.3
Test Date:	30/04/2021	H (%):	56.5
Test Operator:	ATO	P (hPa):	1004

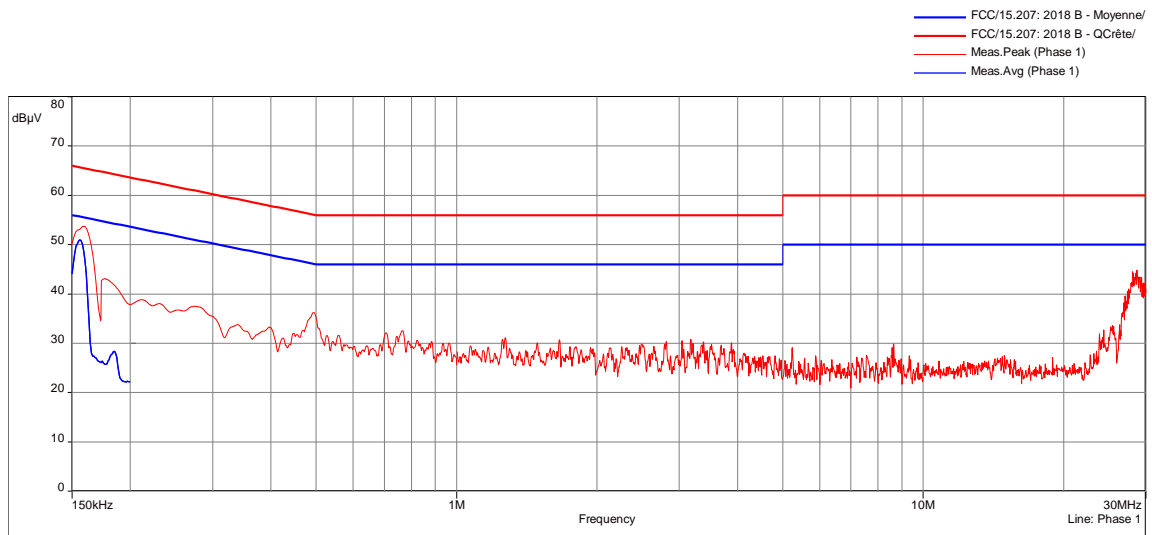

120Vac/60Hz power supply / Charging mode - 04/30/2021 16:50 - 7575

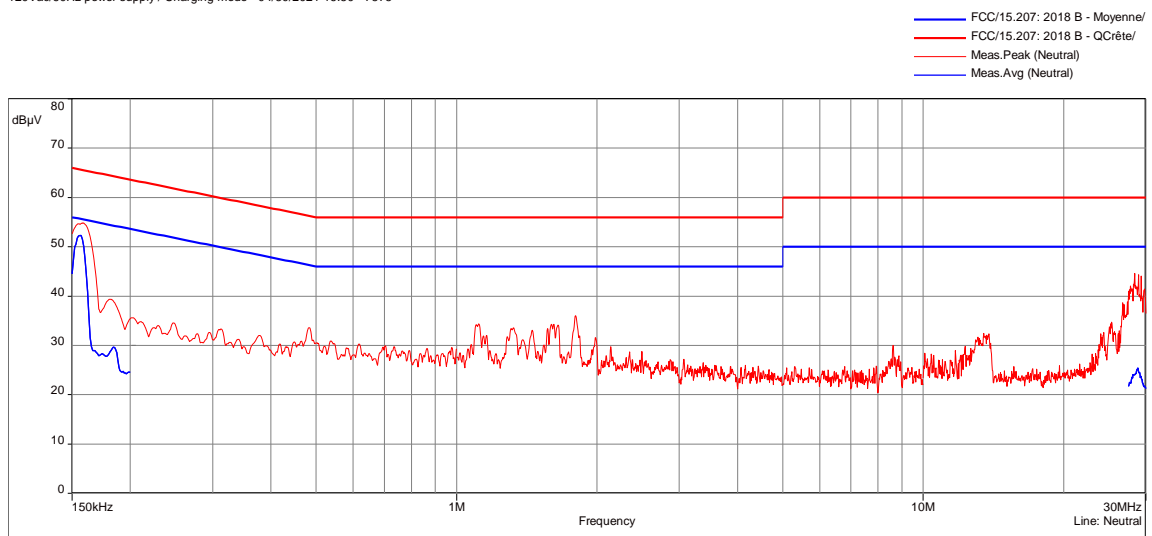

120Vac/60Hz power supply / Charging mode - 04/30/2021 16:50 - 7575

POSITION	FREQUENCIES	RBW	VBW	DETECTOR
Neutral	150kHz-1MHz	10kHz	30kHz	Peak
Neutral	1MHz-10MHz	10kHz	30kHz	Peak
Neutral	10MHz-30MHz	10kHz	30kHz	Peak
Phase 1	150kHz-1MHz	10kHz	30kHz	Peak
Phase 1	1MHz-10MHz	10kHz	30kHz	Peak
Phase 1	10MHz-30MHz	10kHz	30kHz	Peak
Neutral	150kHz-200kHz	10kHz	30kHz	Average
Phase 1	150kHz-200kHz	10kHz	30kHz	Average
Neutral	27.5MHz-30MHz	10kHz	30kHz	Average

Measure with:	A.M.N.
Comments:	N/A

EUT modification(s): N/A

8.2.6dB bandwidth

Reference standard:	FCC part 15 Radio part 15.247 and RSS-247
Test method:	FCC part 15.247 and RSS-247
Test description: a) (2): Systems using digital modulation techniques may operate in the 902-928 MHz, 2400-2483.5 MHz, and 5725-5850 MHz bands. The minimum 6 dB bandwidth shall be at least 500 kHz. EUT is connected to the measuring receiver via 50Ω attenuator(s). Tests are done in max-hold mode in order to capture all channels.	

TEST CASE AND CONDITIONS	SEVERITY	RESULT TAB.	VERDICT
Low Channel	>500kHz	EMI8085	PASS
Mid Channel	>500kHz	EMI8086	PASS
High Channel	>500kHz	EMI8087	PASS

LABORATORY PARAMETERS:	REQUIRED PRIOR TO THE TEST	DURING THE TEST
Ambient Temperature	15 to 35 °C	21.8 °C
Relative Humidity	20 to 75 %	42.1 %
Atmospheric pressure	N/A	1005 hPa
Test method deviation: N/A		
Supplementary information:		

TEST EQUIPMENT USED					
CATEGORY	BRAND	TYPE	IDENTIFIER	CAL. DATE	CAL. DUE
Antenna	ETS-Lindgren	3117	5456	24/07/2019	24/09/2022
Cable	SUCOFLEX	N-3m	14379	25/06/2019	25/08/2021
Cable	SUCOFLEX	N-5,5m	14381	25/06/2019	25/08/2021
Cable	Huber + Suhner	SF102K	16041	28/02/2019	28/04/2021
Receiver	Rohde & Schwarz	FSW43	14830	29/07/2020	29/09/2021
Shielded enclosure	RAY PROOF	C.V2	1423	04/10/2019	04/12/2022
Software	Nexio		0000		
Thermohygrometer	Testo	608-H1	7562	25/01/2019	25/03/2021
Thermohygrometer	Bioblock Scientific	Météostar	0963	26/01/2019	26/09/2021

Blank cells = Permanent validity

TEST SETUP PHOTO(S) – 6dB BANDWIDTH



6dB BANDWIDTH - GRAPH	
LOW CHANNEL	
EMI8085	
EUT mode:	Modulated
Test Date:	21/04/2021
Test Operator:	ATO

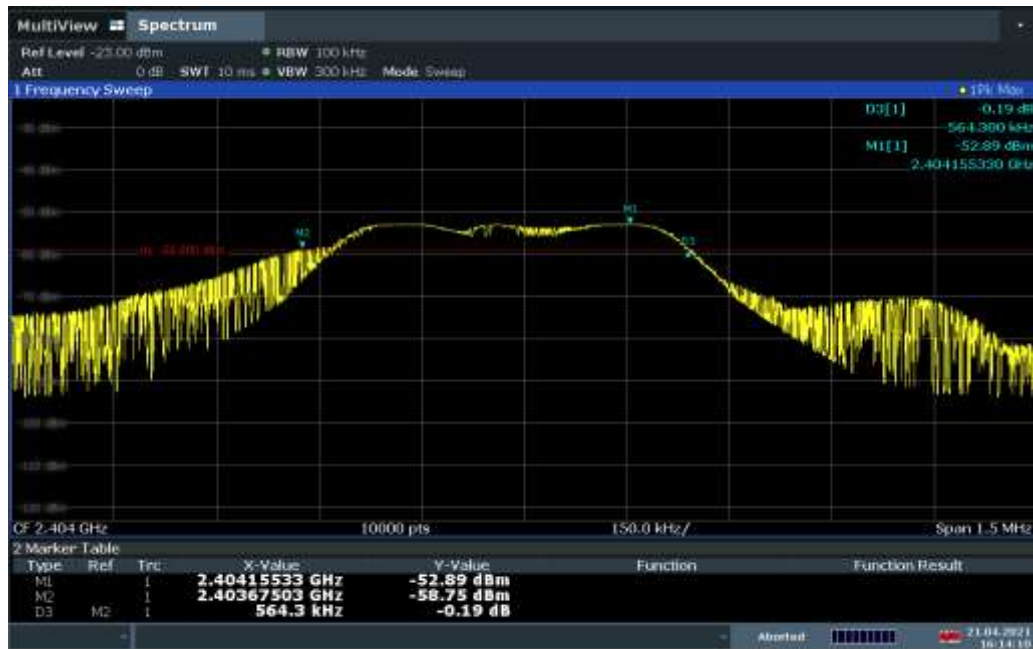

16:14:11 21.04.2021

EUT modification(s): N/A

6dB BANDWIDTH - TABULATED RESULTS			
LOW CHANNEL			
Frequency	RBW	6 dB Bandwidth	Limit
2404 MHz	100kHz	564.3 kHz	>500kHz

6dB BANDWIDTH - GRAPH	
MID CHANNEL	
EMI8086	
EUT mode:	Modulated
Test Date:	21/04/2021
Test Operator:	ATO
	
EUT modification(s): N/A	

6dB BANDWIDTH - TABULATED RESULTS			
MID CHANNEL			
Frequency	RBW	6 dB Bandwith	Limit
2440 MHz	100kHz	632.4 kHz	>500kHz

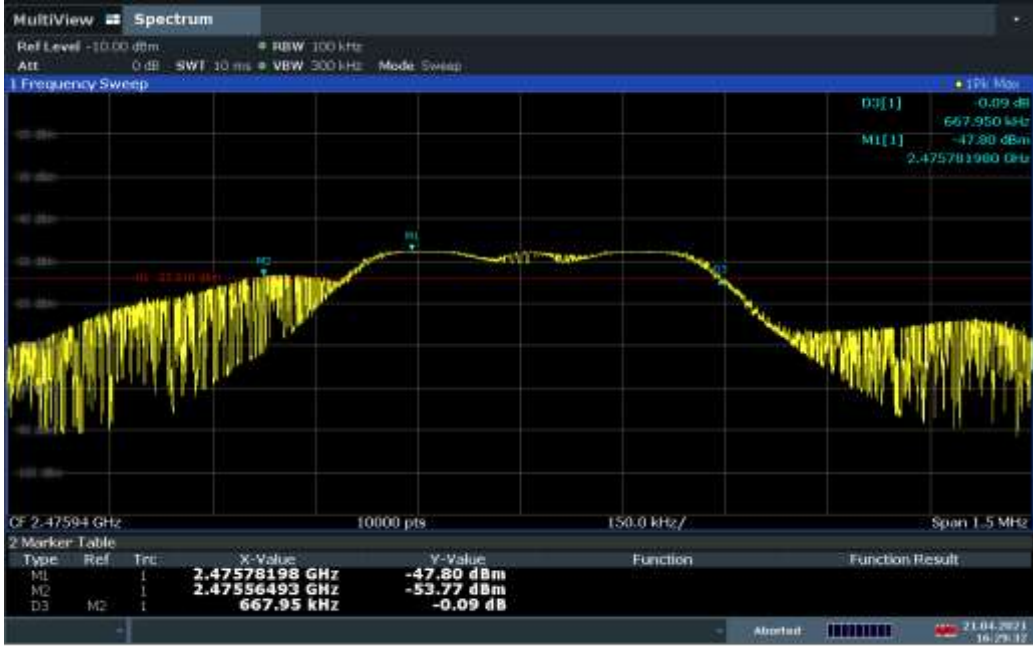
6dB BANDWIDTH - GRAPH	
HIGH CHANNEL	
EMI8087	
EUT mode:	Modulated
Test Date:	21/04/2021
Test Operator:	ATO
	
EUT modification(s): N/A	

6dB BANDWIDTH - TABULATED RESULTS			
HIGH CHANNEL			
Frequency	RBW	6 dB Bandwith	Limit
2476 MHz	100kHz	667.95 kHz	>500kHz

8.3. Occupied bandwidth

Reference standard:	FCC part 15 Radio part 15.247 and RSS-247
Test method:	FCC part 15.247 and RSS-247
<p>Test description: The occupied bandwidth (OBW) is the Frequency Range in which 99 % of the total mean power of a given emission falls. The residual part of the total power being denoted as β, which, in cases of symmetrical spectra, splits up into $\beta/2$ on each side of the spectrum. Unless otherwise specified, $\beta/2$ is taken as 0,5 %.</p> <p>The maximum occupied bandwidth includes all associated side bands above the appropriate emissions level and the frequency error or drift under extreme test conditions.</p>	

TEST CASE AND CONDITIONS	SEVERITY	RESULT TAB.	VERDICT
Low Channel	>500kHz	EMI8088	PASS
Mid Channel	>500kHz	EMI8089	PASS
High Channel	>500kHz	EMI8090	PASS

LABORATORY PARAMETERS:	REQUIRED PRIOR TO THE TEST	DURING THE TEST
Ambient Temperature	15 to 35 °C	21.8 °C
Relative Humidity	20 to 75 %	42.1 %
Atmospheric pressure	N/A	1005 hPa
Test method deviation: N/A		
Supplementary information:		

TEST EQUIPMENT USED					
CATEGORY	BRAND	TYPE	IDENTIFIER	CAL. DATE	CAL. DUE
Antenna	ETS-Lindgren	3117	5456	24/07/2019	24/09/2022
Cable	SUCOFLEX	N-3m	14379	25/06/2019	25/08/2021
Cable	SUCOFLEX	N-5,5m	14381	25/06/2019	25/08/2021
Cable	Huber + Suhner	SF102K	16041	28/02/2019	28/04/2021
Receiver	Rohde & Schwarz	FSW43	14830	29/07/2020	29/09/2021
Shielded enclosure	RAY PROOF	C.V2	1423	04/10/2019	04/12/2022
Software	Nexio		0000		
Thermohygrometer	Testo	608-H1	7562	25/01/2019	25/03/2021
Thermohygrometer	Bioblock Scientific	Météostar	0963	26/01/2019	26/09/2021

Blank cells = Permanent validity

TEST SETUP PHOTO(S) – OCCUPIED BANDWIDTH

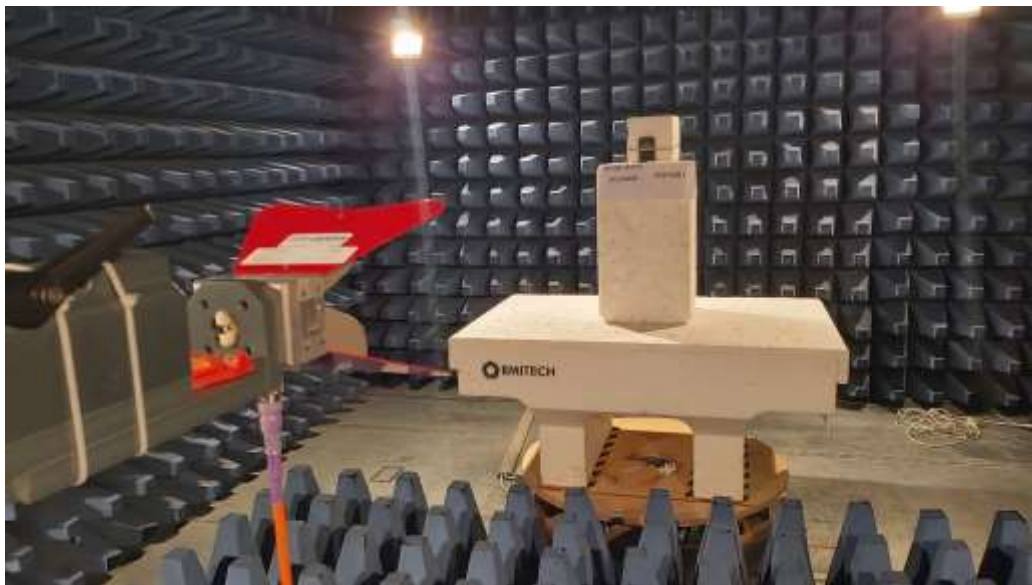

OCCUPIED BANDWIDTH - GRAPH	
LOW CHANNEL	
EMI8088	
EUT mode:	Modulated
Test Date:	30/04/2021
Test Operator:	ATO



EUT modification(s): N/A

OCCUPIED BANDWIDTH - TABULATED RESULTS			
LOW CHANNEL			
Frequency	RBW	OBW 99%	Limit
2404 MHz	100 kHz	1121.09 kHz	> 500kHz

OCCUPIED BANDWIDTH - GRAPH	
MID CHANNEL	
EMI8089	
EUT mode:	Modulated
Test Date:	30/04/2021
Test Operator:	ATO



EUT modification(s): N/A

OCCUPIED BANDWIDTH - TABULATED RESULTS			
MID CHANNEL			
Frequency	RBW	OBW 99%	Limit
2440 MHz	100 kHz	1197.59 kHz	> 500kHz

OCCUPIED BANDWIDTH - GRAPH	
HIGH CHANNEL	
EMI8090	
EUT mode:	Modulated
Test Date:	30/04/2021
Test Operator:	ATO



11:06:53 30.04.2021

EUT modification(s): N/A

OCCUPIED BANDWIDTH - TABULATED RESULTS			
HIGH CHANNEL			
Frequency	RBW	OBW 99%	Limit
2476 MHz	100 kHz	1175.55 kHz	> 500kHz

8.4. Maximum effective isotropic radiated power

Reference standard:	FCC part 15 Radio part 15.247 and RSS-247
Test method:	FCC part 15.247 and RSS-247
<p>Test description: EUT is set on an insulating support at 150cm above the ground reference plane. Measurement are done on a normalized test site by the substitution method.</p> <p>The test antenna is oriented in the two polarizations (vertical and horizontal), and the product is rotated at 360° in the horizontal plane (See photo(s) for initial position of the EUT(0°)). If applicable the test antenna was raised and lowered through the specified range of height until a maximum signal level is detected.</p> <p>For portable equipments a research of maximum level is done on the 3 axes. Only the highest levels are recorded.</p>	

TESTED CONFIGURATION	PARAMETER	SEVERITY	RESULT TAB.	VERDICT
EIRP / Position 1 / Low channel	2.402GHz-2.406GHz	30dBm	EMI6308	PASS
EIRP / Position 2 / Low channel	2.402GHz-2.406GHz	30dBm	EMI6310	PASS
EIRP / Position 3 / Low channel	2.402GHz-2.406GHz	30dBm	EMI6311	PASS
EIRP / All Positions / Mid channel	2.438GHz-2.442GHz	30dBm	EMI6959	PASS
EIRP / All Positions / High channel	2.474GHz-2.478GHz	30dBm	EMI6960	PASS

LABORATORY PARAMETERS:	REQUIRED PRIOR TO THE TEST	DURING THE TEST
Ambient Temperature	15 to 35 °C	See Graph(es)
Relative Humidity	20 to 75 %	See Graph(es)
Atmospheric pressure	N/A	See Graph(es)
Test method deviation: N/A		
Supplementary information: N/A		

TEST EQUIPMENT USED					
CATEGORY	BRAND	TYPE	IDENTIFIER	CAL. DATE	CAL. DUE
Antenna	ETS-Lindgren	3117	5456	24/07/2019	24/09/2022
Attenuator	EMITECH	SUB.V2-H	14495	13/01/2021	13/03/2022
Attenuator	EMITECH	SUB.V2-V	14496	13/01/2021	13/03/2022
Cable	MegaPhase	N-3m	14852	30/10/2018	30/06/2021
Cable	SUCOFLEX	N-5,5m	14381	25/06/2019	25/08/2021
Cable	Huber + Suhner	SF102K	16041	28/02/2019	28/04/2021
Receiver	Rohde & Schwarz	FSW43	14830	29/07/2020	29/09/2021
Shielded enclosure	RAY PROOF	C.V2	1423	04/10/2019	04/12/2022
Software	Nexio		0000		
Thermohygrometer	Testo	608-H1	7562	25/01/2019	25/03/2021
Thermohygrometer	Bioblock Scientific	Météostar	0963	25/01/2019	25/03/2021

Blank cells = Permanent validity

TEST SETUP PHOTO(S) - POSITION 1



TEST SETUP PHOTO(S) - POSITION 2



TEST SETUP PHOTO(S) - POSITION 3



TEST SETUP PHOTO(S) - EIRP

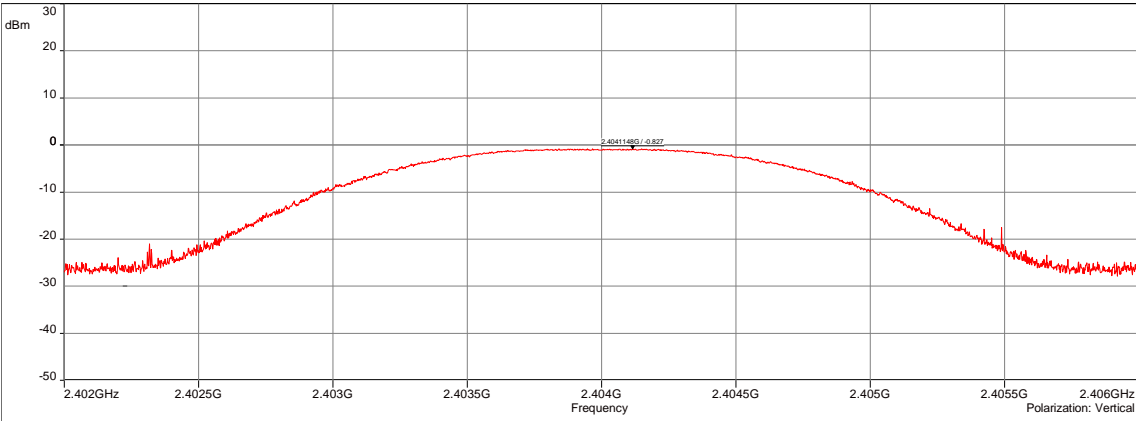
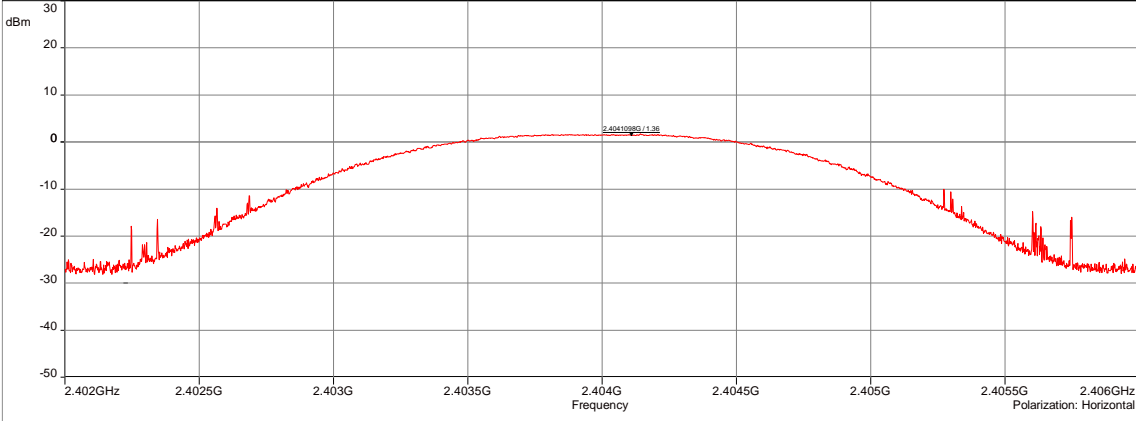

EFFECTIVE ISOTROPIC RADIATED POWER - GRAPH																			
EIRP / POSITION 1 / LOW CHANNEL			EMI6308																
EUT mode:	Unmodulated		T (°C):	21.3															
Test Date:	16/02/2021		H (%):	37.4															
Test Operator:	ATO & OAT		P (hPa):	998															
<p>Sub-range 1 Frequencies: 2.402 GHz - 2.406 GHz (Analyser mode) 8000 Points Settings: RBW: 1MHz, VBW: 3MHz, Auto, Attenuation: 10 dB, Sweep count 1, Preamp: Off, LN Preamp: Off, Preselector: Off Polarization:Vertical Distance: 3 m</p>  <p>EIRP / Position 1 / Low channel - 06/08/2021 17:11 - 6308</p> <p>Sub-range 2 Frequencies: 2.402 GHz - 2.406 GHz (Analyser mode) 8000 Points Settings: RBW: 1MHz, VBW: 3MHz, Auto, Attenuation: 10 dB, Sweep count 1, Preamp: Off, LN Preamp: Off, Preselector: Off Polarization:Horizontal Distance: 3 m</p>  <p>EIRP / Position 1 / Low channel - 06/08/2021 17:11 - 6308</p> <table border="1"> <thead> <tr> <th>POSITION</th> <th>FREQUENCIES</th> <th>RBW</th> <th>VBW</th> <th>DETECTOR</th> </tr> </thead> <tbody> <tr> <td>Vertical</td> <td>2.402GHz-2.406GHz</td> <td>1MHz</td> <td>3MHz</td> <td>Peak</td> </tr> <tr> <td>Horizontal</td> <td>2.402GHz-2.406GHz</td> <td>1MHz</td> <td>3MHz</td> <td>Peak</td> </tr> </tbody> </table> <p>Configuration: N/A Comments: N/A EUT modification(s): N/A</p>					POSITION	FREQUENCIES	RBW	VBW	DETECTOR	Vertical	2.402GHz-2.406GHz	1MHz	3MHz	Peak	Horizontal	2.402GHz-2.406GHz	1MHz	3MHz	Peak
POSITION	FREQUENCIES	RBW	VBW	DETECTOR															
Vertical	2.402GHz-2.406GHz	1MHz	3MHz	Peak															
Horizontal	2.402GHz-2.406GHz	1MHz	3MHz	Peak															

EFFECTIVE ISOTROPIC RADIATED POWER - TABULATED RESULTS			
EIRP / POSITION 1 / LOW CHANNEL			EMI6308
Frequency (MHz)	Polarization	Level (dBm)	Limit (dBm)
2404.11	Vertical	-0.827	30
2404.10	Horizontal	1.36	30

EFFECTIVE ISOTROPIC RADIATED POWER - GRAPH				
EIRP / POSITION 2 / LOW CHANNEL			EMI6310	
EUT mode:	Unmodulated		T (°C):	21.3
Test Date:	16/02/2021		H (%):	37.4
Test Operator:	ATO & OAT		P (hPa):	998

Sub-range 1
 Frequencies: 2.402 GHz - 2.406 GHz (Analyser mode) 8000 Points
 Settings: RBW: 1MHz, VBW: 3MHz, Auto, Attenuation: 10 dB, Sweep count 1, Preamp: Off, LN Preamp: Off, Preselector: Off
 Polarization: Vertical
 Distance: 3 m

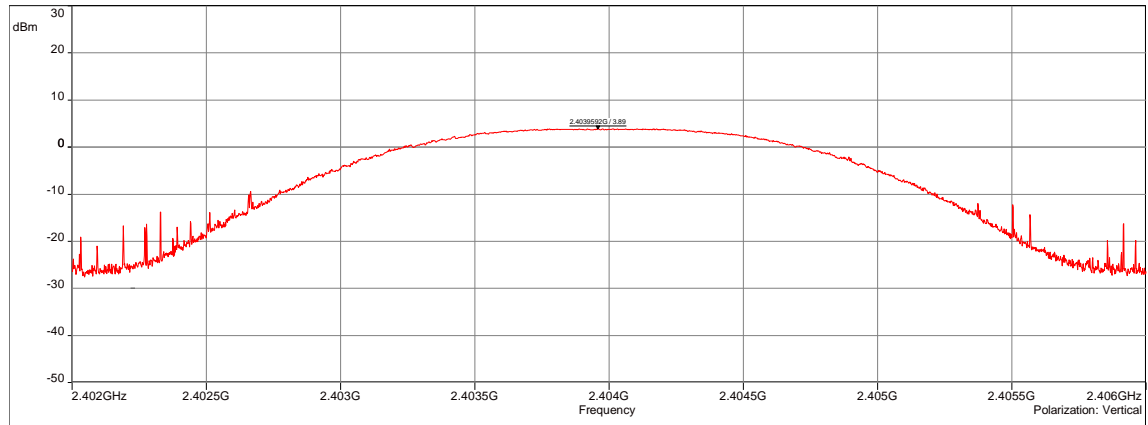

EIRP / Position 2 / Low channel - 06/08/2021 17:11 - 6310

Sub-range 2
 Frequencies: 2.402 GHz - 2.406 GHz (Analyser mode) 8000 Points
 Settings: RBW: 1MHz, VBW: 3MHz, Auto, Attenuation: 10 dB, Sweep count 1, Preamp: Off, LN Preamp: Off, Preselector: Off
 Polarization: Horizontal
 Distance: 3 m

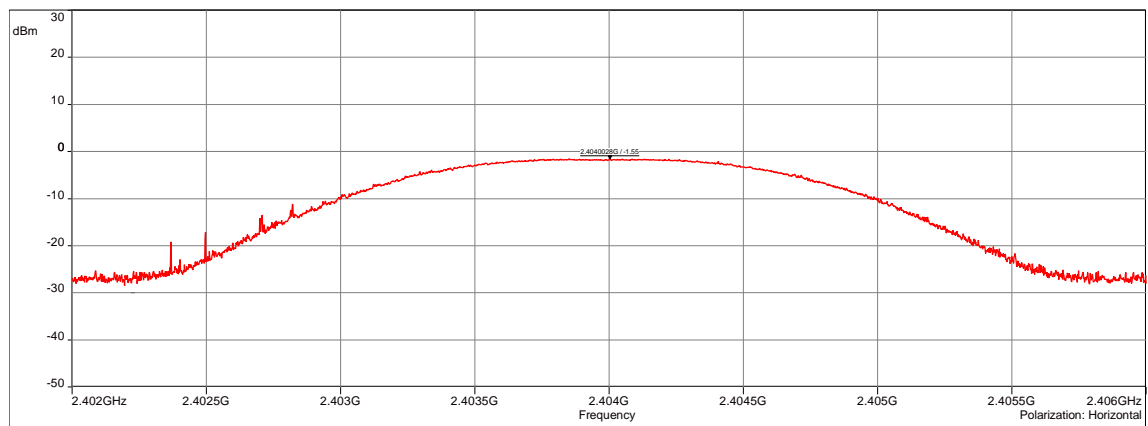

EIRP / Position 2 / Low channel - 06/08/2021 17:11 - 6310

POSITION	FREQUENCIES	RBW	VBW	DETECTOR
Vertical	2.402GHz-2.406GHz	1MHz	3MHz	Peak
Horizontal	2.402GHz-2.406GHz	1MHz	3MHz	Peak

Configuration: N/A

Comments: N/A

EUT modification(s): N/A

EFFECTIVE ISOTROPIC RADIATED POWER - TABULATED RESULTS			
EIRP / POSITION 2 / LOW CHANNEL			EMI6310
Frequency (MHz)	Polarization	Level (dBm)	Limit (dBm)
2403.95	Vertical	3.89	30
2404.00	Horizontal	-1.55	30

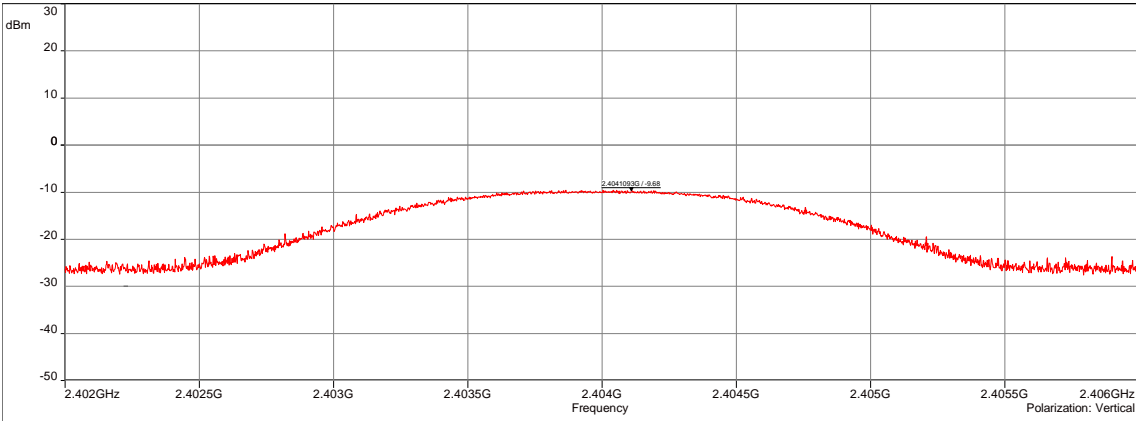
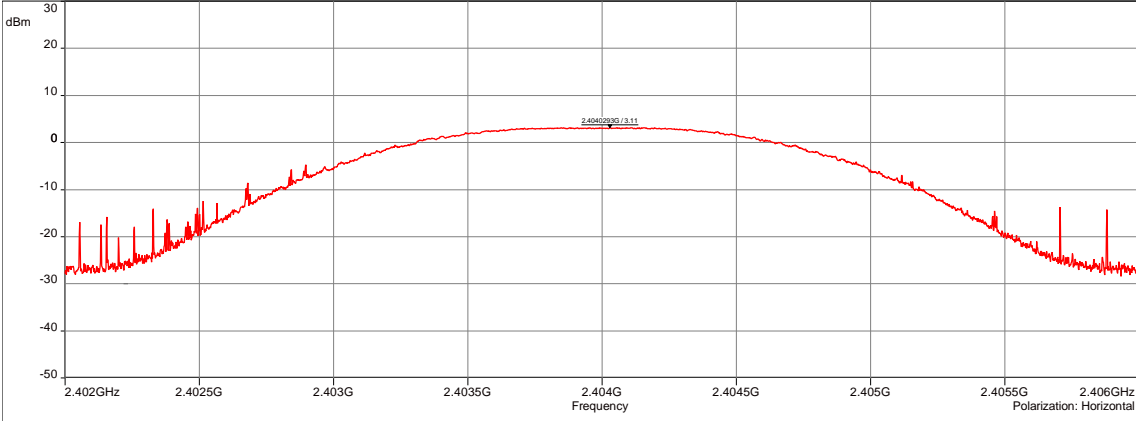
EFFECTIVE ISOTROPIC RADIATED POWER - GRAPH					
EIRP / POSITION 3 / LOW CHANNEL				EMI6311	
EUT mode:	Unmodulated			T (°C):	21.3
Test Date:	16/02/2021			H (%):	37.4
Test Operator:	ATO & OAT			P (hPa):	998
<p>Sub-range 1 Frequencies: 2.402 GHz - 2.406 GHz (Analyser mode) 8000 Points Settings: RBW: 1MHz, VBW: 3MHz, Auto, Attenuation: 10 dB, Sweep count 1, Preamp: Off, LN Preamp: Off, Preselector: Off Polarization: Vertical Distance: 3 m</p>  <p>EIRP / Position 3 / Low channel - 02/16/2021 16:24 - 6311</p>					
<p>Sub-range 2 Frequencies: 2.402 GHz - 2.406 GHz (Analyser mode) 8000 Points Settings: RBW: 1MHz, VBW: 3MHz, Auto, Attenuation: 10 dB, Sweep count 1, Preamp: Off, LN Preamp: Off, Preselector: Off Polarization: Horizontal Distance: 3 m</p>  <p>EIRP / Position 3 / Low channel - 02/16/2021 16:24 - 6311</p>					
POSITION	FREQUENCIES	RBW	VBW	DETECTOR	
Vertical	2.402GHz-2.406GHz	1MHz	3MHz	Peak	
Horizontal	2.402GHz-2.406GHz	1MHz	3MHz	Peak	
Configuration:	N/A				
Comments:	N/A				
EUT modification(s): N/A					

EFFECTIVE ISOTROPIC RADIATED POWER - TABULATED RESULTS			
EIRP / POSITION 3 / LOW CHANNEL			EMI6311
Frequency (MHz)	Polarization	Level (dBm)	Limit (dBm)
2404.10	Vertical	-9.68	30
2404.02	Horizontal	3.11	30

EFFECTIVE ISOTROPIC RADIATED POWER - GRAPH			
EIRP / ALL POSITIONS / MID CHANNEL			EMI6598
EUT mode:	Unmodulated		T (°C): 21.3
Test Date:	16/02/2021		H (%): 37.4
Test Operator:	ATO & OAT		P (hPa): 998

Sub-range 1
 Frequencies: 2.438 GHz - 2.442 GHz (Analyser mode) 8000 Points
 Settings: RBW: 1MHz, VBW: 3MHz, Auto, Attenuation: 10 dB, Sweep count 1, Preamp: Off, LN Preamp: Off, Preselector: Off
 Polarization: Vertical
 Distance: 3 m

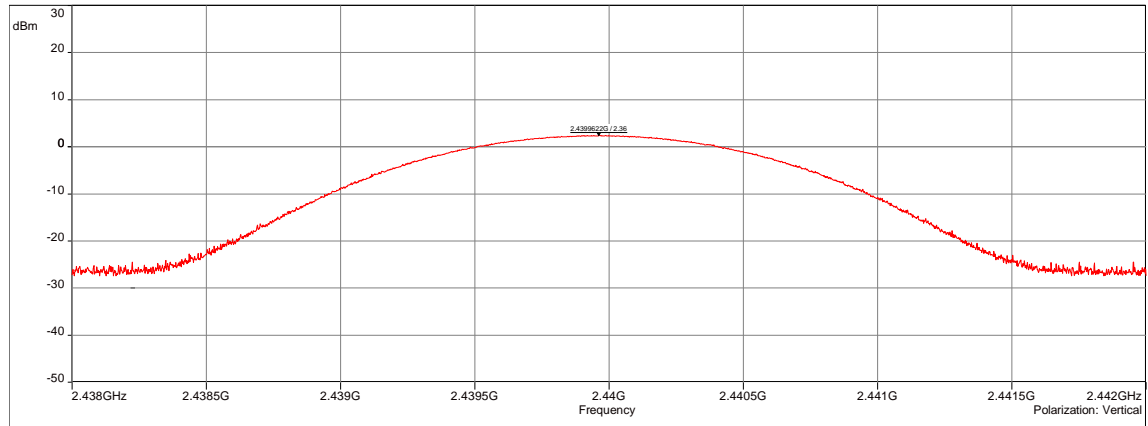

EIRP / All Positions / Mid channel - 03/16/2021 11:13 - 6959

Sub-range 2
 Frequencies: 2.438 GHz - 2.442 GHz (Analyser mode) 8000 Points
 Settings: RBW: 1MHz, VBW: 3MHz, Auto, Attenuation: 10 dB, Sweep count 1, Preamp: Off, LN Preamp: Off, Preselector: Off
 Polarization: Horizontal
 Distance: 3 m

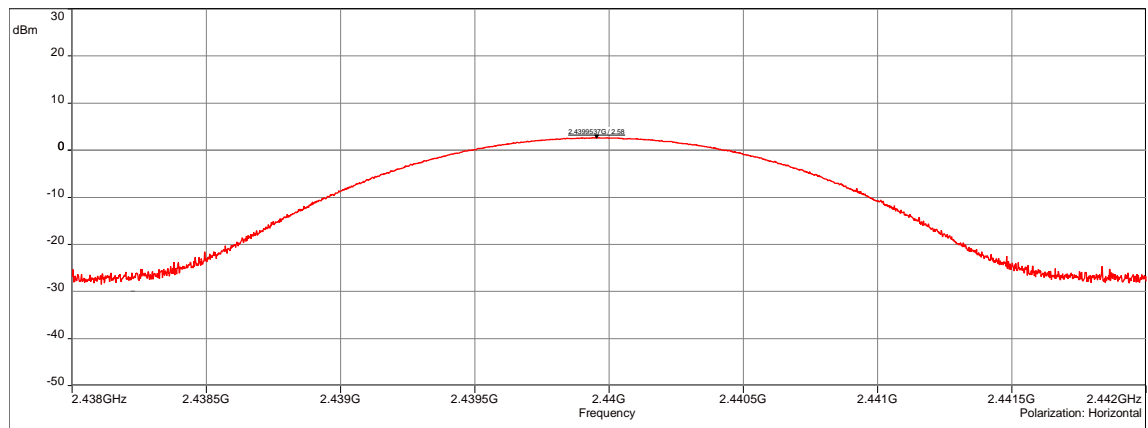

EIRP / All Positions / Mid channel - 03/16/2021 11:13 - 6959

POSITION	FREQUENCIES	RBW	VBW	DETECTOR
Vertical	2.438GHz-2.442GHz	1MHz	3MHz	Peak
Horizontal	2.438GHz-2.442GHz	1MHz	3MHz	Peak
Configuration:	N/A			
Comments:	N/A			
EUT modification(s): N/A				

EFFECTIVE ISOTROPIC RADIATED POWER - TABULATED RESULTS			
EIRP / ALL POSITIONS / MID CHANNEL			EMI6598
Frequency (MHz)	Polarization	Level (dBm)	Limit (dBm)
2439.96	Vertical	2.36	30
2439.95	Horizontal	2.58	30

EFFECTIVE ISOTROPIC RADIATED POWER - GRAPH				
EIRP / ALL POSITIONS / HIGH CHANNEL			EMI6960	
EUT mode:	Unmodulated		T (°C):	21.3
Test Date:	16/02/2021		H (%):	37.4
Test Operator:	ATO & OAT		P (hPa):	998

Sub-range 1
 Frequencies: 2.474 GHz - 2.478 GHz (Analyser mode) 8000 Points
 Settings: RBW: 1MHz, VBW: 3MHz, Auto, Attenuation: 10 dB, Sweep count 1, Preamp: Off, LN Preamp: Off, Preselector: Off
 Polarization: Vertical
 Distance: 3 m

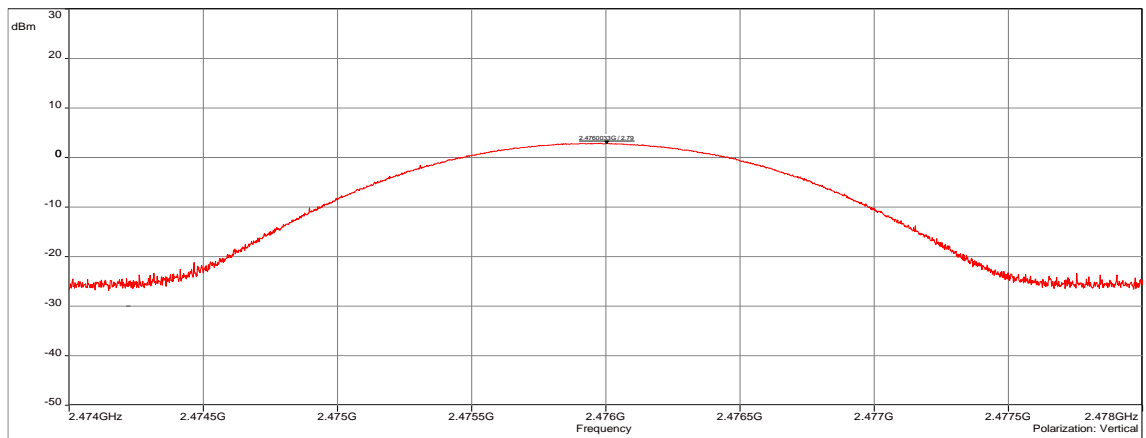

EIRP / All Positions / High channel - 03/16/2021 11:25 - 6960

Sub-range 2
 Frequencies: 2.474 GHz - 2.478 GHz (Analyser mode) 8000 Points
 Settings: RBW: 1MHz, VBW: 3MHz, Auto, Attenuation: 10 dB, Sweep count 1, Preamp: Off, LN Preamp: Off, Preselector: Off
 Polarization: Horizontal
 Distance: 3 m

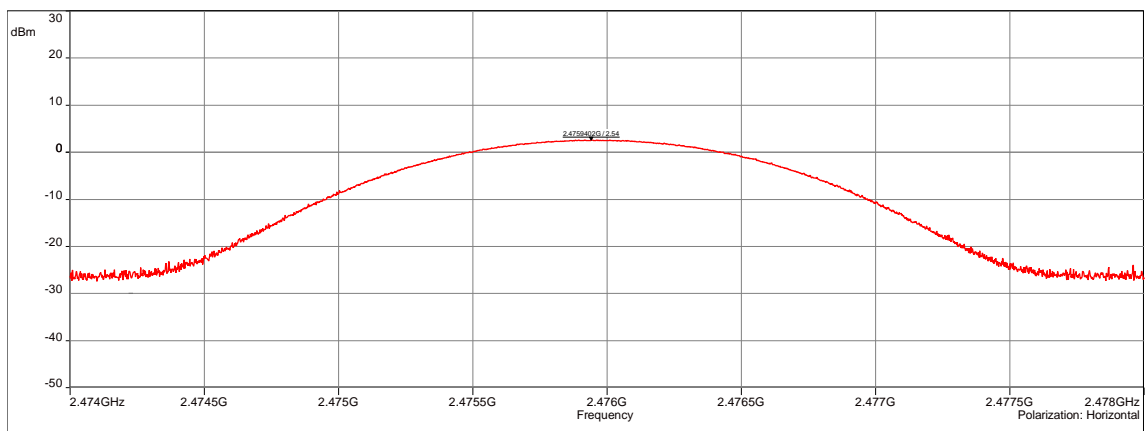

EIRP / All Positions / High channel - 03/16/2021 11:25 - 6960

POSITION	FREQUENCIES	RBW	VBW	DETECTOR
Vertical	2.474GHz-2.478GHz	1MHz	3MHz	Peak
Horizontal	2.474GHz-2.478GHz	1MHz	3MHz	Peak
Configuration:	N/A			
Comments:	N/A			
EUT modification(s): N/A				

EFFECTIVE ISOTROPIC RADIATED POWER - TABULATED RESULTS			
EIRP / ALL POSITIONS / HIGH CHANNEL			EMI6960
Frequency (MHz)	Polarization	Level (dBm)	Limit (dBm)
2476.00	Vertical	2.79	30
2475.94	Horizontal	2.54	30

8.5. Band-edge compliance

Reference standard:	FCC part 15 Radio part 15.247 and RSS-247
Test method:	FCC part 15.247 subclause d) and RSS-247
Test description: d) In any 100 kHz bandwidth outside the frequency band in which the intentional radiator is operating, the radio frequency power that is produced by the intentional radiator shall be at least 20 dB below that in the 100 kHz bandwidth within the band that contains the highest level of the desired power, based on either an RF conducted or a radiated measurement, provided the transmitter demonstrates compliance with the peak conducted power limits. If the transmitter complies with the conducted power limits based on the use of RMS averaging over a time interval, the attenuation required under this paragraph shall be 30 dB instead of 20 dB. EUT is connected to the measuring receiver via 50Ω attenuator(s). Only the highest levels are recorded.	

TESTED CONFIGURATION	PARAMETER	SEVERITY	RESULT TAB.	VERDICT
All Positions / Low channel	2.38GHz-2.5GHz	>20dBc	EMI7005	PASS
All Positions / Mid channel	2.38GHz-2.5GHz	>20dBc	EMI7007	PASS
All Positions / High channel	2.38GHz-2.5GHz	>20dBc	EMI7009	PASS

LABORATORY PARAMETERS:	REQUIRED PRIOR TO THE TEST	DURING THE TEST
Ambient Temperature	15 to 35 °C	See Graph(es)
Relative Humidity	20 to 75 %	See Graph(es)
Atmospheric pressure	N/A	See Graph(es)
Test method deviation: N/A		
Supplementary information: N/A		

TEST EQUIPMENT USED					
CATEGORY	BRAND	TYPE	IDENTIFIER	CAL. DATE	CAL. DUE
Antenna	ETS-Lindgren	3117	5456	24/07/2019	24/09/2022
Cable	SUCOFLEX	N-3m	14379	25/06/2019	25/08/2021
Cable	SUCOFLEX	N-5,5m	14381	25/06/2019	25/08/2021
Cable	Huber + Suhner	SF102K	16041	28/02/2019	28/04/2021
Receiver	Rohde & Schwarz	FSW43	14830	29/07/2020	29/09/2021
Shielded enclosure	RAY PROOF	C.V2	1423	04/10/2019	04/12/2022
Software	Nexio		0000		
Thermohygrometer	Testo	608-H1	7562	25/01/2019	25/03/2021
Thermohygrometer	Bioblock Scientific	Météostar	0963	25/01/2019	25/03/2021

BAT-EMC software version: V3.18.0.26

Blank cells = Permanent validity

TEST SETUP PHOTO(S) - POSITION 1



TEST SETUP PHOTO(S) - POSITION 2



TEST SETUP PHOTO(S) - POSITION 3



TEST SETUP PHOTO(S) – BAND EDGE

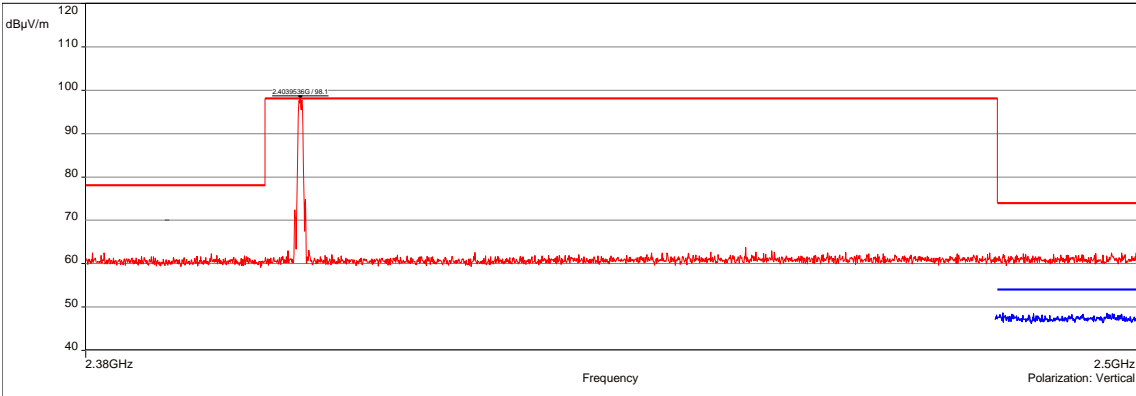
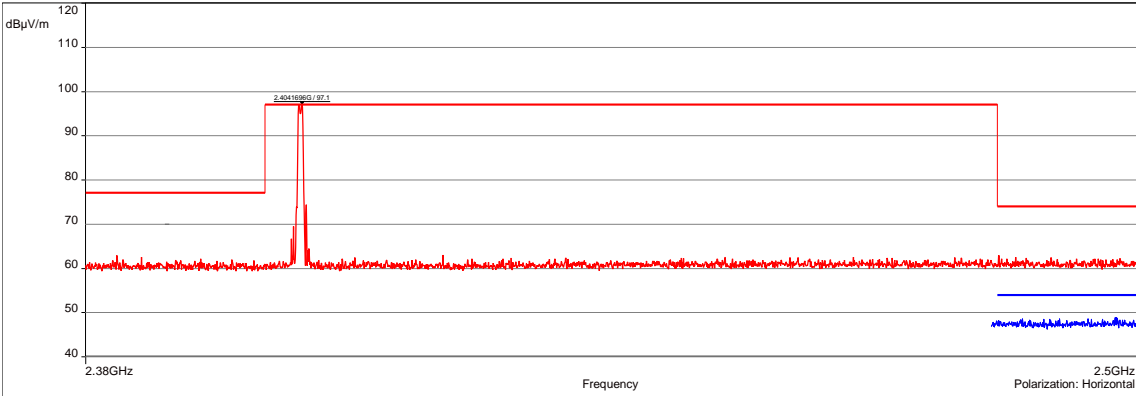

BAND EDGE - GRAPH					
ALL POSITIONS / LOW CHANNEL				EMI7005	
EUT mode:	Modulated			T (°C):	21.8
Test Date:	22/03/2021			H (%):	22.1
Test Operator:	ATO & OAT			P (hPa):	1006
<p style="text-align: right;"> — FCC/15.249 Band edge - Classe:DEUS2 Low - Moyenne/3.0m/ — FCC/15.249 Band edge - Classe:DEUS2 Low - Crête/3.0m/ — Meas.Peak (Vertical) — Meas.Avg (Vertical) </p> <p>Sub-range 1 Frequencies: 2.38 GHz - 2.5 GHz (Analyser mode) 15000 Points Settings: RBW: 100kHz, VBW: 300kHz, Auto, Attenuation: 10 dB, Sweep count 1, Preamp: Off, LN Preamp: Off, Preselector: Off Polarization: Vertical Distance: 3 m</p>  <p>Band edge / All Positions / Low channel / V - 03/22/2021 11:05 - 7005</p>					
<p style="text-align: right;"> — FCC/15.249 Band edge - Classe:DEUS2 Low H - Moyenne/3.0m/ — FCC/15.249 Band edge - Classe:DEUS2 Low H - Crête/3.0m/ — Meas.Peak (Horizontal) — Meas.Avg (Horizontal) </p> <p>Sub-range 1 Frequencies: 2.38 GHz - 2.5 GHz (Analyser mode) 15000 Points Settings: RBW: 100kHz, VBW: 300kHz, Auto, Attenuation: 10 dB, Sweep count 1, Preamp: Off, LN Preamp: Off, Preselector: Off Polarization: Horizontal Distance: 3 m</p>  <p>Band edge / All Positions / Low channel / H - 03/22/2021 11:19 - 7006</p>					
POSITION	FREQUENCIES	RBW	VBW	DETECTOR	
Vertical	2.38GHz-2.5GHz	100kHz	300kHz	Peak	
Horizontal	2.38GHz-2.5GHz	100kHz	300kHz	Peak	
Vertical	2.48GHz-2.5GHz	100kHz	20kHz	Peak	
Horizontal	2.48GHz-2.5GHz	100kHz	20kHz	Peak	
Configuration:	N/A				
Comments:	N/A				
EUT modification(s): N/A					

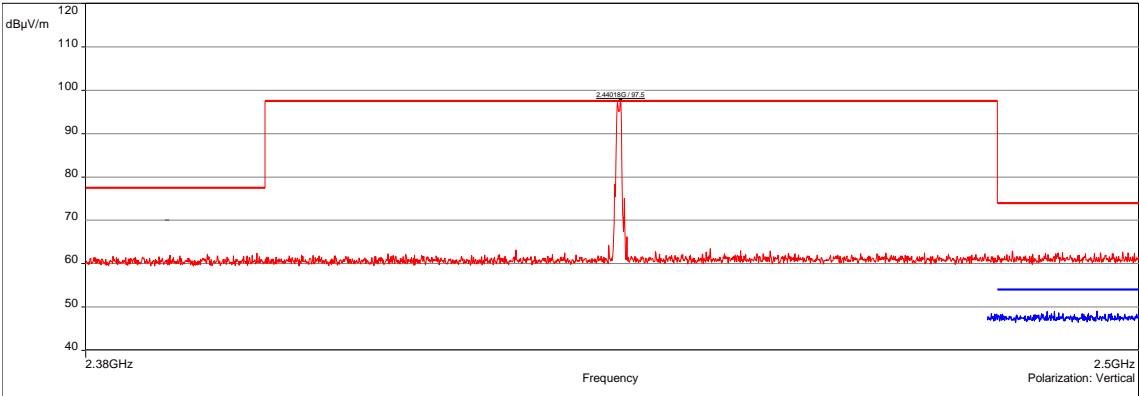
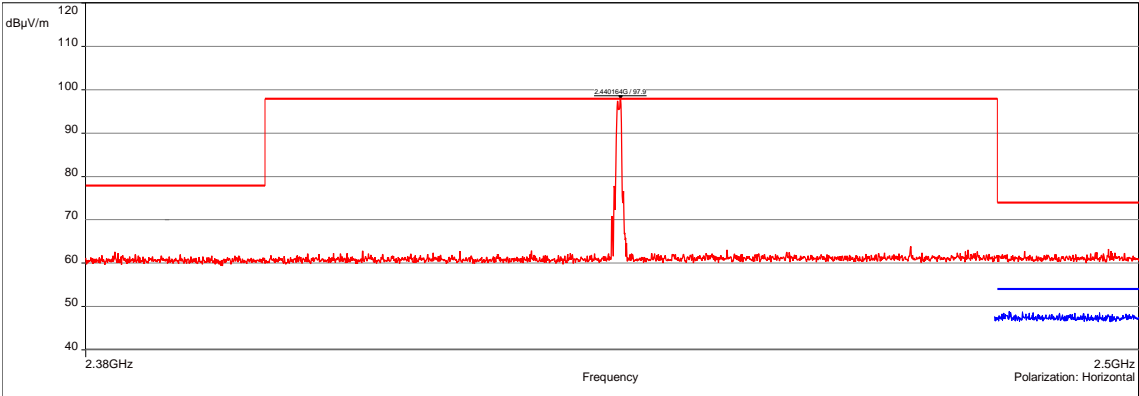
BAND EDGE - GRAPH					
ALL POSITIONS / MID CHANNEL				EMI7008	
EUT mode:	Modulated			T (°C):	21.8
Test Date:	22/03/2021			H (%):	22.1
Test Operator:	ATO & OAT			P (hPa):	1006
<p>Sub-range 1 Frequencies: 2.38 GHz - 2.5 GHz (Analyser mode) 15000 Points Settings: RBW: 100kHz, VBW: 300kHz, Auto, Attenuation: 10 dB, Sweep count 1, Preamp: Off, LN Preamp: Off, Preselector: Off Polarization: Vertical Distance: 3 m</p>  <p>Band edge / All Positions / Mid channel / V - 03/22/2021 11:28 - 7007</p>					
<p>Sub-range 1 Frequencies: 2.38 GHz - 2.5 GHz (Analyser mode) 15000 Points Settings: RBW: 100kHz, VBW: 300kHz, Auto, Attenuation: 10 dB, Sweep count 1, Preamp: Off, LN Preamp: Off, Preselector: Off Polarization: Horizontal Distance: 3 m</p>  <p>Band edge / All Positions / Mid channel / H - 03/22/2021 11:35 - 7008</p>					
POSITION	FREQUENCIES	RBW	VBW	DETECTOR	
Vertical	2.38GHz-2.5GHz	100kHz	300kHz	Peak	
Horizontal	2.38GHz-2.5GHz	100kHz	300kHz	Peak	
Vertical	2.48GHz-2.5GHz	100kHz	20kHz	Peak	
Horizontal	2.48GHz-2.5GHz	100kHz	20kHz	Peak	
Configuration:	N/A				
Comments:	N/A				
EUT modification(s): N/A					

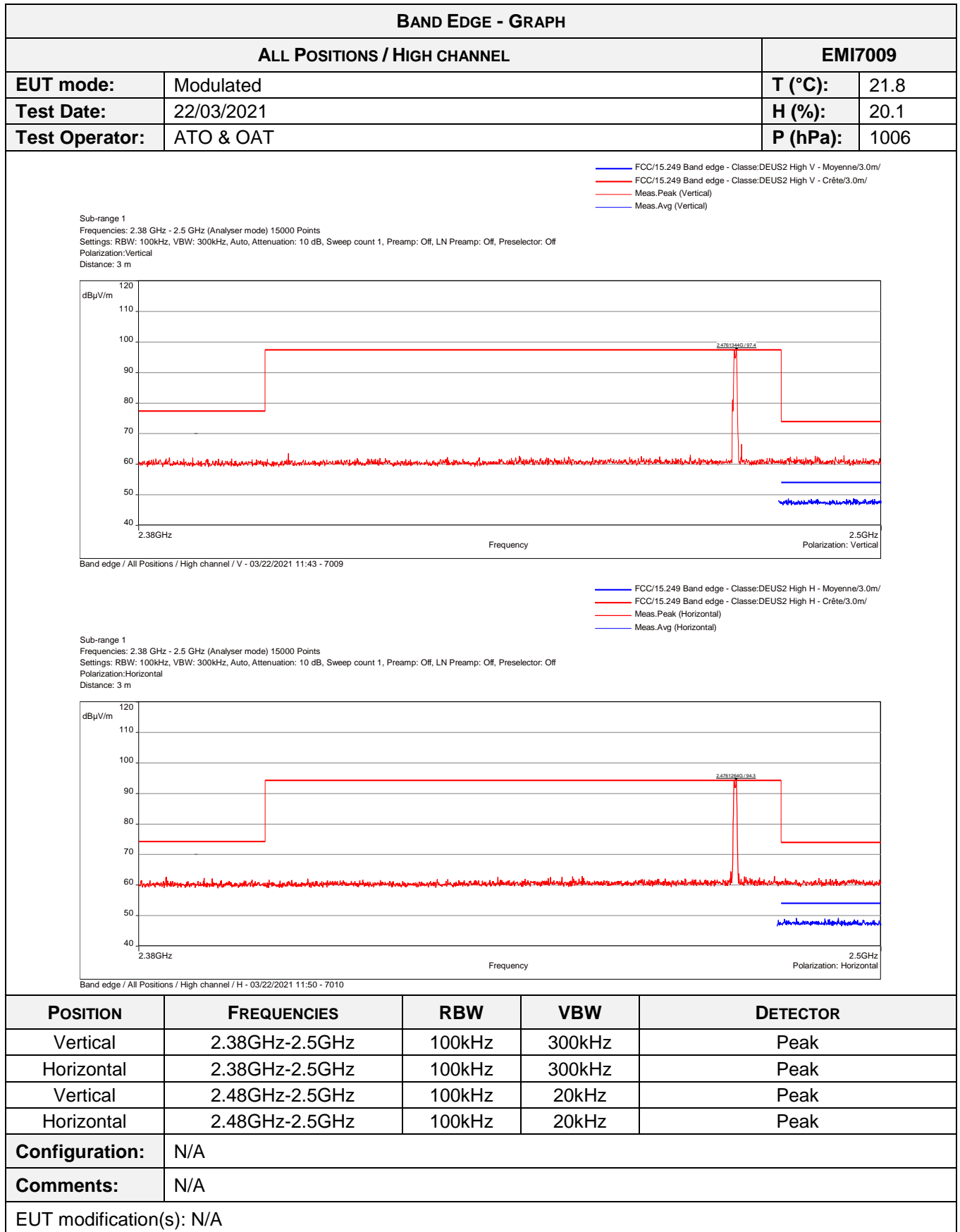

8.6. Power spectral density

Reference standard:	FCC part 15 Radio part 15.247 and RSS-247
Test method:	FCC part 15.247 and RSS-247
Test description: e)	
<p>For digitally modulated systems, the power spectral density conducted from the intentional radiator to the antenna shall not be greater than 8 dBm in any 3 kHz band during any time interval of continuous transmission. This power spectral density shall be determined in accordance with the provisions of paragraph (b) of this section. The same method of determining the conducted output power shall be used to determine the power spectral density.</p> <p>EUT is connected to the measuring receiver via 50Ω attenuator(s). Only the highest levels are recorded.</p>	

TESTED CONFIGURATION	PARAMETER	SEVERITY	RESULT TAB.	VERDICT
All Positions / Low channel	2.4035GHz- 2.4045GHz	8dBm/3kHz	EMI6996	PASS
All Positions / Mid channel	2.4395GHz- 2.4405GHz	8dBm/3kHz	EMI6997	PASS
All Positions / High channel	2.4755GHz- 2.4765GHz	8dBm/3kHz	EMI6998	PASS

LABORATORY PARAMETERS:	REQUIRED PRIOR TO THE TEST	DURING THE TEST
Ambient Temperature	15 to 35 °C	See Graph(s)
Relative Humidity	20 to 75 %	See Graph(s)
Atmospheric pressure	N/A	See Graph(s)
Test method deviation: N/A		
Supplementary information: N/A		

TEST EQUIPMENT USED					
CATEGORY	BRAND	TYPE	IDENTIFIER	CAL. DATE	CAL. DUE
Antenna	ETS-Lindgren	3117	5456	24/07/2019	24/09/2022
Attenuator	EMITECH	SUB.V2-H	14495	13/01/2021	13/03/2022
Attenuator	EMITECH	SUB.V2-V	14496	13/01/2021	13/03/2022
Cable	SUCOFLEX	N-3m	14379	25/06/2019	25/08/2021
Cable	MegaPhase	N-3m	14852	30/10/2018	30/06/2021
Cable	SUCOFLEX	N-5,5m	14381	25/06/2019	25/08/2021
Cable	Huber + Suhner	SF102K	16041	28/02/2019	28/04/2021
Receiver	Rohde & Schwarz	FSW43	14830	29/07/2020	29/09/2021
Shielded enclosure	RAY PROOF	C.V2	1423	04/10/2019	04/12/2022
Software	Nexio		0000		
Thermohygrometer	Testo	608-H1	7562	25/01/2019	25/03/2021
Thermohygrometer	Bioblock Scientific	Météostar	0963	25/01/2019	25/03/2021

BAT-EMC software version: V3.18.0.26

Blank cells = Permanent validity

TEST SETUP PHOTO(S) - POSITION 1



TEST SETUP PHOTO(S) - POSITION 2



TEST SETUP PHOTO(S) - POSITION 3



TEST SETUP PHOTO(S) – PSD

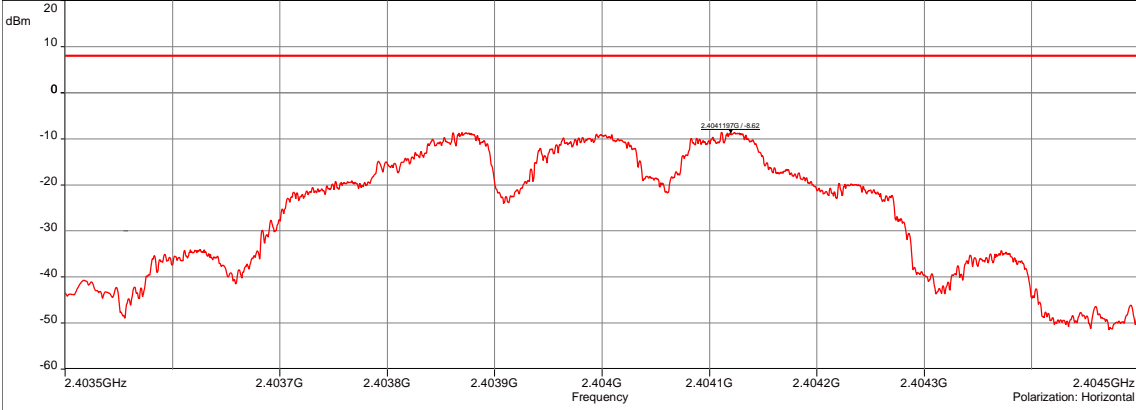
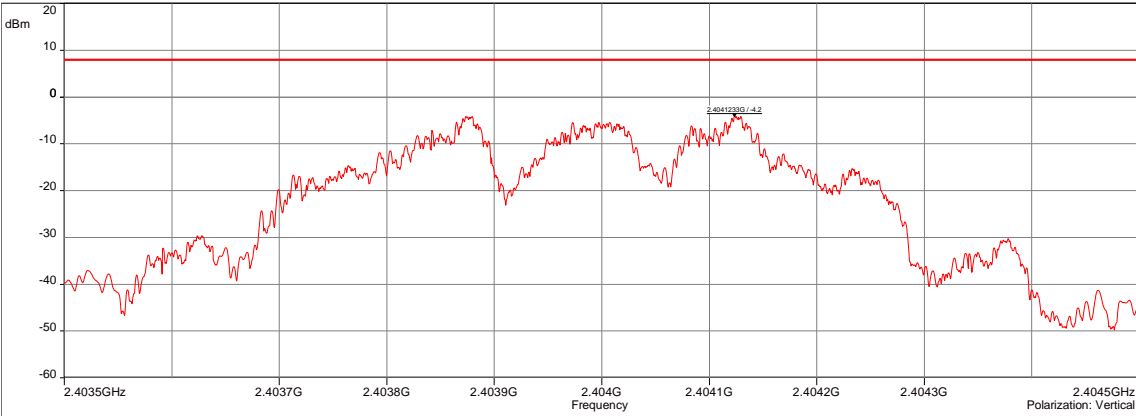

POWER SPECTRAL DENSITY - GRAPH					
ALL POSITIONS / LOW CHANNEL				EMI6996	
EUT mode:	Modulated			T (°C):	21.2
Test Date:	22/03/2021			H (%):	22.0
Test Operator:	ATO & OAT			P (hPa):	1006
<p>Sub-range 2 Frequencies: 2.4035 GHz - 2.4045 GHz (Analyser mode) 8000 Points Settings: RBW: 3kHz, VBW: 9kHz, Auto, Attenuation: 10 dB, Sweep count 1, Preamp: Off, LN Preamp: Off, Preselector: Off Polarization: Horizontal Distance: 3 m</p> <p style="text-align: right;"> — FCC/15.249: 2020 e) - Classe:PSD - Crête/3.0m/ — Meas.Peak (Horizontal) </p>  <p>PSD / All Positions / Low channel - 10/20/2021 15:27 - 6996</p>					
<p>Sub-range 1 Frequencies: 2.4035 GHz - 2.4045 GHz (Analyser mode) 8000 Points Settings: RBW: 3kHz, VBW: 9kHz, Auto, Attenuation: 10 dB, Sweep count 1, Preamp: Off, LN Preamp: Off, Preselector: Off Polarization: Vertical Distance: 3 m</p> <p style="text-align: right;"> — FCC/15.249: 2020 e) - Classe:PSD - Crête/3.0m/ — Meas.Peak (Vertical) </p>  <p>PSD / All Positions / Low channel - 10/20/2021 15:27 - 6996</p>					
POSITION	FREQUENCIES	RBW	VBW	DETECTOR	
Vertical	2.4035GHz-2.4045GHz	3kHz	9kHz	Peak	
Horizontal	2.4035GHz-2.4045GHz	3kHz	9kHz	Peak	
Configuration:	N/A				
Comments:	N/A				
EUT modification(s): N/A					

POWER SPECTRAL DENSITY - TABULATED RESULTS			
ALL POSITIONS / LOW CHANNEL			EMI6996
Frequency (MHz)	Polarization	Level (dBm)	Limit (dBm)
2404.12	Vertical	-4.2	8
2404.11	Horizontal	-8.62	8

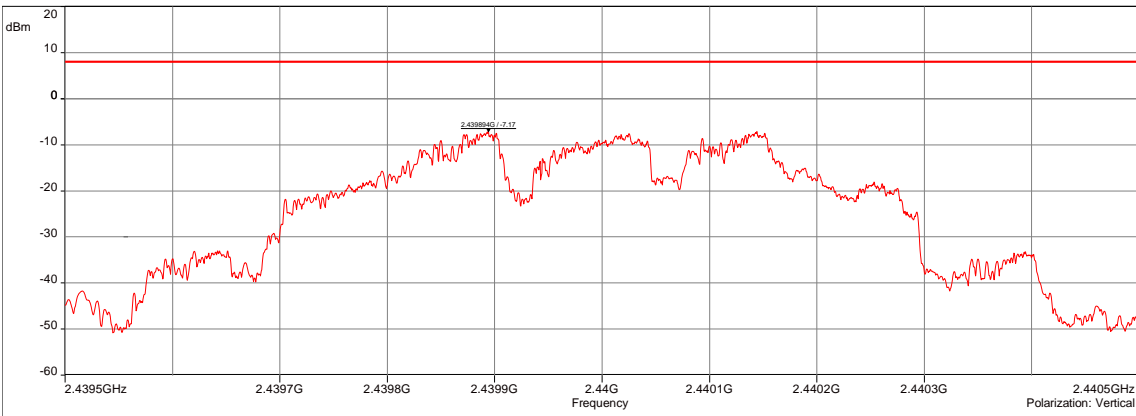
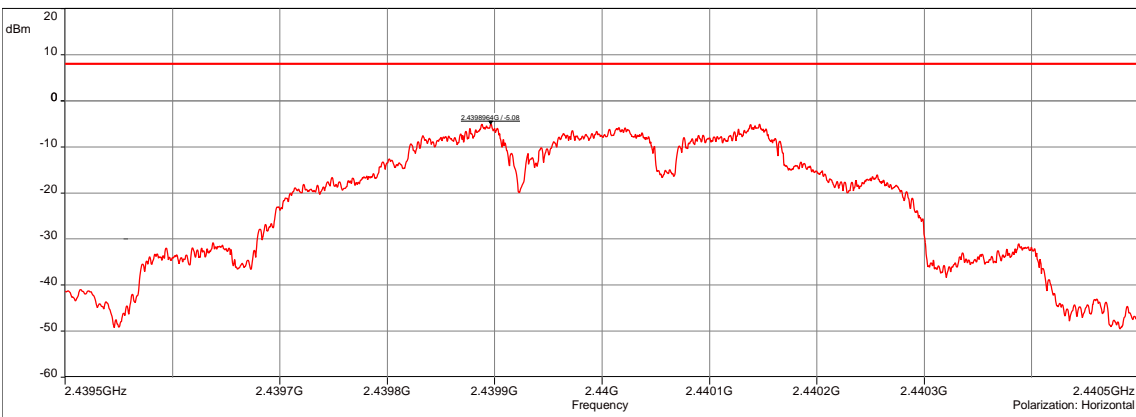
POWER SPECTRAL DENSITY - GRAPH					
PSD / ALL POSITIONS / MID CHANNEL				EMI6997	
EUT mode:	Modulated			T (°C):	21.2
Test Date:	23/03/2021			H (%):	22.0
Test Operator:	ATO & OAT			P (hPa):	1006
<p>Sub-range 1 Frequencies: 2.4395 GHz - 2.4405 GHz (Analyser mode) 8000 Points Settings: RBW: 3kHz, VBW: 9kHz, Auto, Attenuation: 10 dB, Sweep count 1, Preamp: Off, LN Preamp: Off, Preselector: Off Polarization: Vertical Distance: 3 m</p>  <p>PSD / All Positions / Mid channel - 03/22/2021 09:23 - 6997</p>					
<p>Sub-range 2 Frequencies: 2.4395 GHz - 2.4405 GHz (Analyser mode) 8000 Points Settings: RBW: 3kHz, VBW: 9kHz, Auto, Attenuation: 10 dB, Sweep count 1, Preamp: Off, LN Preamp: Off, Preselector: Off Polarization: Horizontal Distance: 3 m</p>  <p>PSD / All Positions / Mid channel - 03/22/2021 09:23 - 6997</p>					
POSITION	FREQUENCIES	RBW	VBW	DETECTOR	
Vertical	2.4395GHz-2.4405GHz	3kHz	9kHz	Peak	
Horizontal	2.4395GHz-2.4405GHz	3kHz	9kHz	Peak	
Configuration:	N/A				
Comments:	N/A				
EUT modification(s): N/A					

POWER SPECTRAL DENSITY - TABULATED RESULTS			
PSD / ALL POSITIONS / MID CHANNEL			EMI6997
Frequency (MHz)	Polarization	Level (dBm)	Limit (dBm)
2439.89	Vertical	-7.17	8
2439.89	Horizontal	-5.08	8

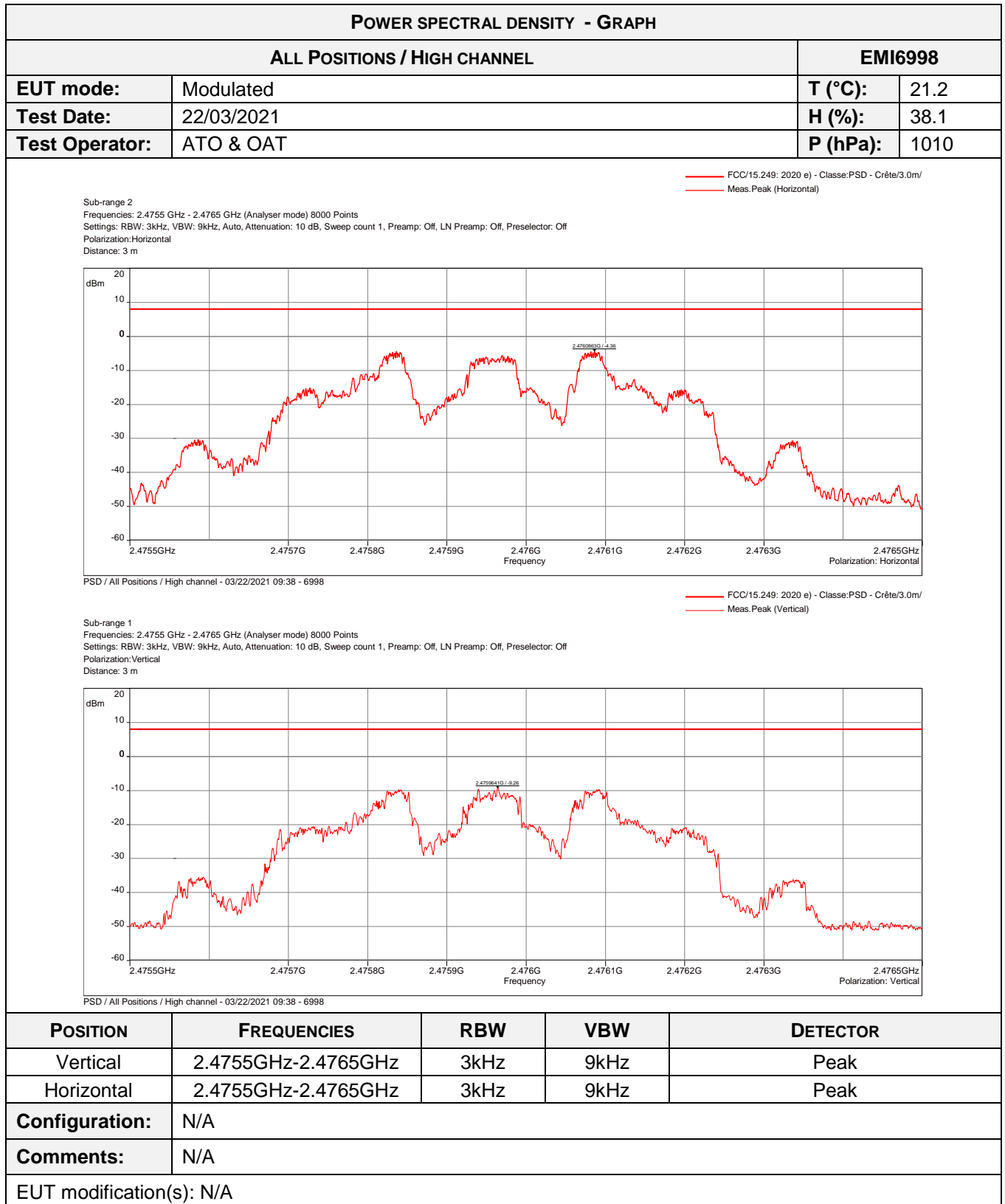

POWER SPECTRAL DENSITY - TABULATED RESULTS			
ALL POSITIONS / HIGH CHANNEL			EMI6998
Frequency (MHz)	Polarization	Level (dBm)	Limit (dBm)
2475.96	Vertical	-9.28	8
2476.08	Horizontal	-4.36	8

8.7. Transmitter radiated spurious emissions at frequencies <30MHz

Reference standard:	FCC part 15 Radio part 15.247 and RSS-247
Test method:	FCC part 15.109, 15.209, 15.205, 15.215 RSS-247, CNR Gen
<p>General test setup: Spurious domain emission limits are limits on emissions at frequencies other than those of the carrier and sidebands associated with normal test modulation.</p> <p>EUT is set on an insulating support at 80cm above the ground reference plane.</p> <p>Preliminary (peak) measurements were performed at an antenna to EUT separation distance of 3-meter in a anechoic chamber. The EUT was rotated 360° in order to maximize radiated levels. Test antenna was oriented in 3 axes (0°, 45° and 90°).</p> <p>Final measurements (quasi-peak) were then performed in a 10-meter Open Area Test Site that complies to CISPR 16 in the same measurement conditions.</p> <p>All frequencies were investigated, where applicable.</p>	

TESTED CONFIGURATION	PARAMETER	SEVERITY	RESULT TAB.	VERDICT
Tx mode / All positions / All channels / 0°	9kHz-30MHz	Tx	EMI6037	PASS
Tx mode / All positions / All channels / 45°	9kHz-30MHz	Tx	EMI6038	PASS
Tx mode / All positions / All channels / 90°	9kHz-30MHz	Tx	EMI6039	PASS
Charging + Tx mode / All positions / All channels / 0°	9kHz-30MHz	Tx	EMI6298	PASS
Charging + Tx mode / All positions / All channels / 45°	9kHz-30MHz	Tx	EMI6299	PASS
Charging + Tx mode / All positions / All channels / 45°	9kHz-30MHz	Tx	EMI6300	PASS

LABORATORY PARAMETERS:	REQUIRED PRIOR TO THE TEST	DURING THE TEST
Ambient Temperature	15 to 35 °C	See Graph(es)
Relative Humidity	20 to 75 %	See Graph(es)
Atmospheric pressure	N/A	See Graph(es)
Test method deviation: N/A		
<p>Supplementary information:</p> <p>From 9 kHz to 30MHz: limit indicated on the curves is calculated with 40 dB/decade extrapolation factor and 51.5 dB conversion factor.</p>		

TEST EQUIPMENT USED					
CATEGORY	BRAND	TYPE	IDENTIFIER	CAL. DATE	CAL. DUE
Antenna	Rohde & Schwarz	HFH2-Z2	5825	24/04/2020	24/06/2022
Cable	SUCOFLEX	N-6,5m	14380	25/07/2019	25/09/2021
Cable	MegaPhase	N-8m	15813	14/01/2021	14/03/2023
Cable	MegaPhase	TM18-N1N1-118	12841	14/08/2020	14/10/2022
Receiver	Agilent Technologies	E4440A	5824	22/10/2020	22/12/2022
Shielded enclosure	COMTEST	SAC 3m	14494	02/10/2019	02/12/2022
Software	Nexio		0000		
Thermohygrometer	Testo	608-H2	12269	07/05/2020	07/07/2022
Thermohygrometer	Bioblock Scientific	Météostar	0963	25/01/2019	25/03/2021

BAT-EMC software version: V3.18.0.26

Blank cells = Permanent validity

TEST SETUP PHOTO(S) -EUT POSITIONS

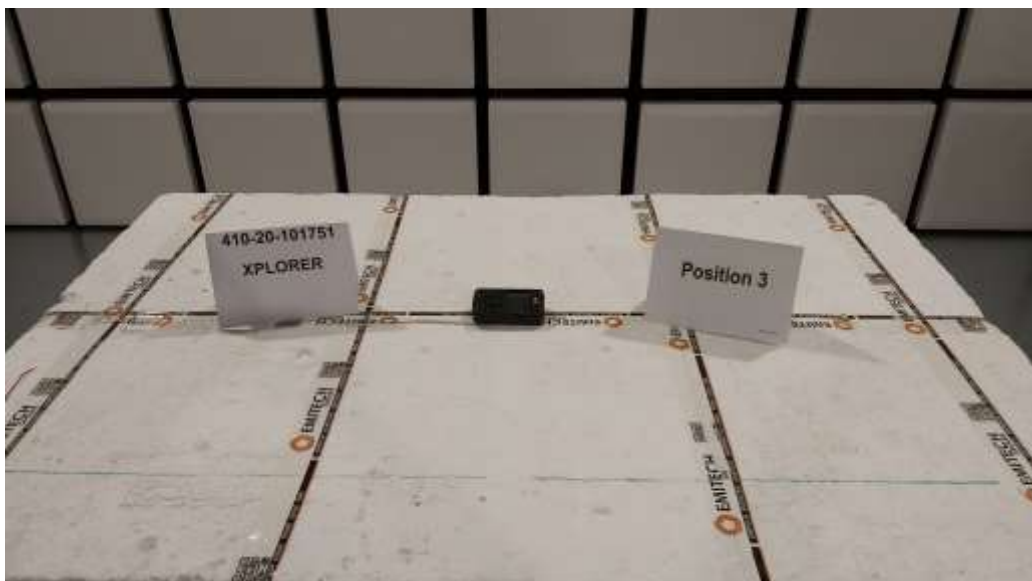

TEST SETUP PHOTO(S)

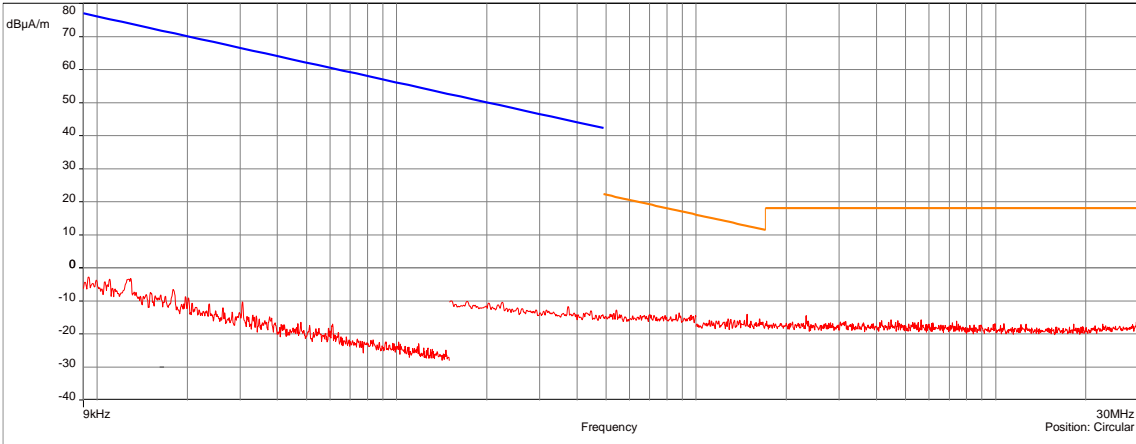

TRANSMITTER RADIATED SPURIOUS EMISSIONS AT FREQUENCIES <30MHZ - GRAPH					
TX MODE / ALL POSITIONS / ALL CHANNELS / 0°				EMI6037	
EUT mode:	Modulated			T (°C):	18.1
Test Date:	15/02/2021			H (%):	27.6
Test Operator:	ATO & OAT			P (hPa):	1006
					
POSITION	FREQUENCIES	RBW	VBW	DETECTOR	
Circular	9kHz-150kHz	300Hz	1kHz	Peak	
Circular	150kHz-1MHz	10kHz	30kHz	Peak	
Circular	1MHz-30MHz	10kHz	30kHz	Peak	
Configuration:	N/A				
Comments:	Limit indicated on these plots are calculated with 40 dB/decade extrapolation factor and 51.5dB conversion factor.				
EUT modification(s): N/A					

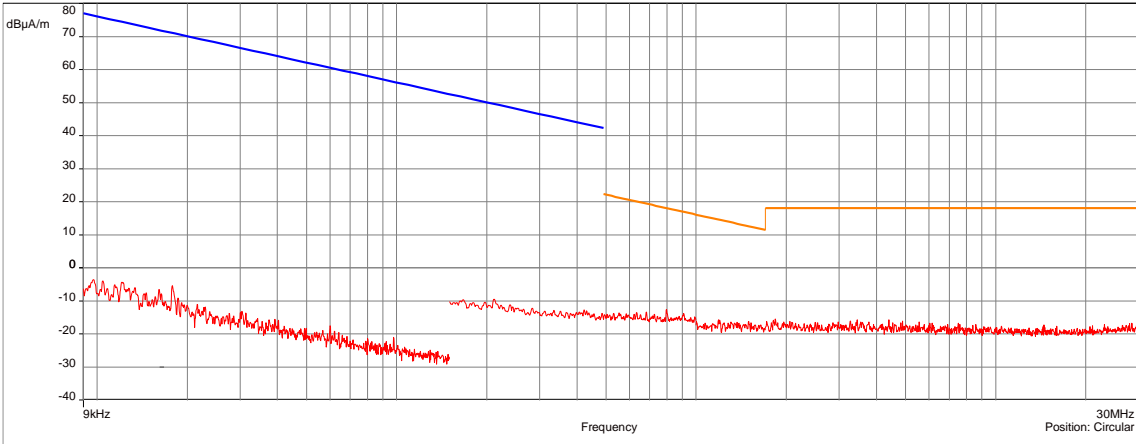
TRANSMITTER RADIATED SPURIOUS EMISSIONS AT FREQUENCIES <30MHZ - GRAPH					
TX MODE / ALL POSITIONS / ALL CHANNELS / 45°				EMI6038	
EUT mode:	Modulated			T (°C):	18.1
Test Date:	15/02/2021			H (%):	27.6
Test Operator:	ATO & OAT			P (hPa):	1006
					
POSITION	FREQUENCIES	RBW	VBW	DETECTOR	
Circular	9kHz-150kHz	300Hz	1kHz	Peak	
Circular	150kHz-1MHz	10kHz	30kHz	Peak	
Circular	1MHz-30MHz	10kHz	30kHz	Peak	
Configuration:	N/A				
Comments:	Limit indicated on these plots are calculated with 40 dB/decade extrapolation factor and 51.5dB conversion factor				
EUT modification(s): N/A					

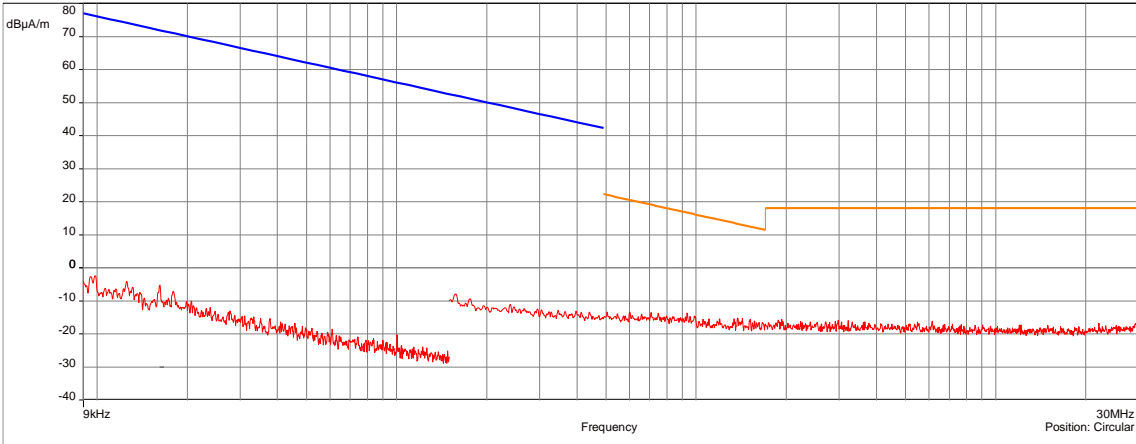
TRANSMITTER RADIATED SPURIOUS EMISSIONS AT FREQUENCIES <30MHz - GRAPH					
TX MODE / ALL POSITIONS / ALL CHANNELS / 90°				EMI6039	
EUT mode:	Modulated			T (°C):	18.1
Test Date:	15/02/2021			H (%):	27.6
Test Operator:	ATO & OAT			P (hPa):	1006
 <p>Legend: — FCC/FCC Part 15 §209 Tx - Moyenne/3.0m/ — FCC/FCC Part 15 §209 Tx - QCrête/3.0m/ — Meas.Peak</p>					
POSITION	FREQUENCIES	RBW	VBW	DETECTOR	
Circular	9kHz-150kHz	300Hz	1kHz	Peak	
Circular	150kHz-1MHz	10kHz	30kHz	Peak	
Circular	1MHz-30MHz	10kHz	30kHz	Peak	
Configuration:	N/A				
Comments:	Limit indicated on these plots are calculated with 40 dB/decade extrapolation factor and 51.5dB conversion factor.				
EUT modification(s): N/A					

TRANSMITTER RADIATED SPURIOUS EMISSIONS AT FREQUENCIES <30MHZ - GRAPH					
CHARGING + TX MODE / ALL POSITIONS / ALL CHANNELS / 0°				EMI6298	
EUT mode:	Modulated			T (°C):	21.6
Test Date:	16/02/2021			H (%):	37.3
Test Operator:	ATO & OAT			P (hPa):	998
POSITION	FREQUENCIES	RBW	VBW	DETECTOR	
Circular	9kHz-150kHz	300Hz	1kHz	Peak	
Circular	150kHz-1MHz	10kHz	30kHz	Peak	
Circular	1MHz-30MHz	10kHz	30kHz	Peak	
Configuration:	N/A				
Comments:	Limit indicated on these plots are calculated with 40 dB/decade extrapolation factor and 51.5dB conversion factor.				
EUT modification(s): N/A					

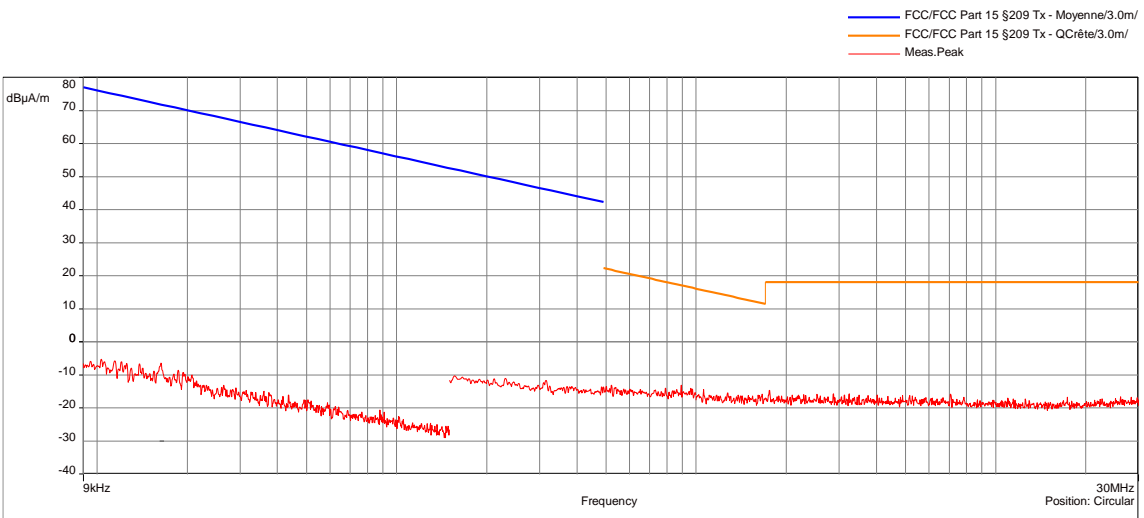
TRANSMITTER RADIATED SPURIOUS EMISSIONS AT FREQUENCIES <30MHZ - GRAPH					
CHARGING + TX MODE / ALL POSITIONS / ALL CHANNELS / 45°				EMI6299	
EUT mode:	Modulated			T (°C):	21.6
Test Date:	16/02/2021			H (%):	37.3
Test Operator:	ATO & OAT			P (hPa):	998
 <p style="text-align: right;"> — FCC/FCC Part 15 §209 Tx - Moyenne/3.0m/ — FCC/FCC Part 15 §209 Tx - QCrête/3.0m/ — Meas.Peak </p>					
POSITION	FREQUENCIES	RBW	VBW	DETECTOR	
Circular	9kHz-150kHz	300Hz	1kHz	Peak	
Circular	150kHz-1MHz	10kHz	30kHz	Peak	
Circular	1MHz-30MHz	10kHz	30kHz	Peak	
Configuration:	N/A				
Comments:	Limit indicated on these plots are calculated with 40 dB/decade extrapolation factor and 51.5dB conversion factor.				
EUT modification(s): N/A					

TRANSMITTER RADIATED SPURIOUS EMISSIONS AT FREQUENCIES <30MHZ - GRAPH					
CHARGING + TX MODE / ALL POSITIONS / ALL CHANNELS / 90°				EMI6300	
EUT mode:	Modulated			T (°C):	21.6
Test Date:	16/02/2021			H (%):	37.3
Test Operator:	ATO & OAT			P (hPa):	998
POSITION	FREQUENCIES	RBW	VBW	DETECTOR	
Circular	9kHz-150kHz	300Hz	1kHz	Peak	
Circular	150kHz-1MHz	10kHz	30kHz	Peak	
Circular	1MHz-30MHz	10kHz	30kHz	Peak	
Configuration:	N/A				
Comments:	Limit indicated on these plots are calculated with 40 dB/decade extrapolation factor and 51.5dB conversion factor.				
EUT modification(s): N/A					

8.8. Transmitter radiated spurious emissions at frequencies >30MHz

Reference standard:	FCC part 15 Radio part 15.209 & CNR-Gen
Test method:	FCC part 15.109, 15.209, 15.205, 15.215, CNR-Gen
<p>General test setup: EUT is set on an insulating support at 80cm above the ground reference plane.</p> <p>Preliminary (peak) measurements were performed at an antenna to EUT separation distance of 3-meter. The EUT was rotated 360° about its azimuth with the receive antenna located at various heights in horizontal and vertical polarities.</p> <p>Final measurements (quasi-peak or average) were then performed in a semi-anechoic chamber or Open Area Test Site that complies to CISPR 16. The EUT was rotated 360° about its azimuth and adjusting the receive antenna height from 1 to 4 m.</p> <p>All frequencies were investigated, where applicable.</p> <p>For portable equipments a research of maximum level is done on the 3 axes. Only the highest levels are recorded.</p>	

TESTED CONFIGURATION	PARAMETER	SEVERITY	RESULT TAB.	VERDICT
Tx mode / All Positions / All Channels / For freq <1GHz	30MHz-1GHz	15.209	EMI6136	PASS
Charging + Tx mode / All Positions / All Channels / For freq <1GHz	30MHz-1GHz	15.209	EMI6294	PASS
Tx mode / All Positions / Low channel / 1GHz to 18GHz	1GHz-18GHz	15.209	EMI7076	PASS
Tx mode / All Positions / Mid channel / 1GHz to 18GHz	1GHz-18GHz	15.209	EMI6966	PASS
Tx mode / All Positions / High channel / 1GHz to 18GHz	1GHz-18GHz	15.209	EMI6967	PASS
Charging + Tx mode / All Positions / Low channel / 1GHz to 18GHz	1GHz-18GHz	15.209	EMI7197	PASS
Charging + Tx mode / All Positions / Mid channel / 1GHz to 18GHz	1GHz-18GHz	15.209	EMI7198	PASS
Charging + Tx mode / All Positions / High channel / 1GHz to 18GHz	1GHz-18GHz	15.209	EMI7199	PASS
Tx mode / All Positions / Low channel / 18GHz to 26.5GHz	18GHz-26.5GHz	15.209	EMI7227	PASS
Tx mode / All Positions / Mid channel / 18GHz to 26.5GHz	18GHz-26.5GHz	15.209	EMI7236	PASS
Tx mode / All Positions / High channel / 18GHz to 26.5GHz	18GHz-26.5GHz	15.209	EMI7237	PASS
Charging + Tx mode / All Positions / Low channel / 18GHz to 26.5GHz	18GHz-26.5GHz	15.209	EMI7268	PASS
Charging + Tx mode / All Positions / Mid channel / 18GHz to 26.5GHz	18GHz-26.5GHz	15.209	EMI7269	PASS
Charging + Tx mode / All Positions / High channel / 18GHz to 26.5GHz	18GHz-26.5GHz	15.209	EMI7270	PASS

LABORATORY PARAMETERS:	REQUIRED PRIOR TO THE TEST	DURING THE TEST
Ambient Temperature	15 to 35 °C	<i>See Graph(s)</i>
Relative Humidity	20 to 75 %	<i>See Graph(s)</i>
Atmospheric pressure	N/A	<i>See Graph(s)</i>
Test method deviation: N/A		
Supplementary information: N/A		

TEST EQUIPMENT USED					
CATEGORY	BRAND	TYPE	IDENTIFIER	CAL. DATE	CAL. DUE
Antenna	ETS-Lindgren	3117	5456	24/07/2019	24/09/2022
Antenna	ETS lindgren	3160-09	14690	26/09/2017	26/05/2021
Antenna	Electro Metrics	BIA-30HF	0824	13/06/2018	13/08/2021
Antenna	Rohde & Schwarz	HL223	3126	13/06/2018	13/08/2021
Cable	MegaPhase	F135N1N28	16664	25/10/2019	25/12/2021
Cable	MegaPhase	F135N1N28	16666	25/10/2019	25/12/2021
Cable	JYE BAO	K30K30-5003-40G1	14887	25/06/2019	25/08/2021
Cable	Huber + Suhner	K-5m	14460	25/06/2019	25/08/2021
Cable	C&C	N-1.5m	10554	20/12/2019	20/02/2022
Cable	/	N-1m	3625	27/01/2021	27/03/2023
Cable	/	N-1m	3626	27/01/2021	27/03/2023
Cable	SUCOFLEX	N-3m	14379	25/06/2019	25/08/2021
Cable	MegaPhase	N-3m	14852	29/10/2018	29/12/2020
Cable	MegaPhase	N-3m	14852	30/10/2018	30/06/2021
Cable	SUCOFLEX	N-5,5m	14381	25/06/2019	25/08/2021
Cable	SUCOFLEX	N-6,5m	14380	25/07/2019	25/09/2021
Cable	MegaPhase	N-8m	15813	12/11/2018	12/01/2021
Cable	MegaPhase	N-8m	15813	14/01/2021	14/03/2023
Cable	Huber + Suhner	SF102K	16041	28/02/2019	28/04/2021
Cable	MegaPhase	TM18-N1N1-118	12841	14/08/2020	14/10/2022
Cable	MegaPhase	TM18-N1N1-118	12842	02/12/2020	02/02/2023
Filter	Micro-Tronics	HPM 15162	10273	12/01/2019	12/03/2022
Filter	Micro-Tronics	HPM18865	12843	09/06/2018	09/08/2021
Filter	Wainwright Instruments	WRCGV 2402/2480- 2380/2500- 40/10EE-200W	9771	08/01/2019	08/03/2022
Preamplifier	Techniwave	APS16-0087	14040	02/12/2020	02/02/2022
Preamplifier	Wright Technologie	ASL40-B3015	14851	12/08/2020	12/10/2021
Preamplifier	IMPULSE	CA118-546ACN	9169	13/01/2021	13/03/2022
Preamplifier	Mini-circuit	ZFL-1000LN	1321	25/06/2019	25/02/2021
Receiver	Agilent Technologies	E4440A	5824	22/10/2020	22/12/2022
Receiver	Rohde & Schwarz	ESI	9704	03/03/2020	03/05/2021
Receiver	Rohde & Schwarz	FPL1003	16027	14/08/2020	14/10/2021
Receiver	Rohde & Schwarz	FSW43	14830	29/07/2020	29/09/2021
Shielded enclosure	RAY PROOF	C.V2	1423	04/10/2019	04/12/2022
Shielded enclosure	COMTEST	SAC 3m	14494	02/10/2019	02/12/2022
Software	Nexio		0000		
Thermohygrometer	Testo	608-H1	7562	25/01/2019	25/03/2021
Thermohygrometer	Testo	608-H2	12269	07/05/2020	07/07/2022
Thermohygrometer	Bioblock Scientific	Météostar	0963	25/01/2019	25/03/2021

BAT-EMC software version: V3.18.0.26

Blank cells = Permanent validity

TRANSMITTER RADIATED SPURIOUS EMISSIONS AT FREQUENCIES >30MHZ- TABULATED RESULTS					
CHARGING + TX MODE / ALL POSITIONS / ALL CHANNELS / FOR FREQ <1GHZ				EMI6294	
Frequency MHz	Polarization	Level peak dBµV/m	Level Qpeak dBµV/m	Limit dBµV/m	Margin dB
30.43	Vertical	33.35	20.77	40	-19.23
30.74	Vertical	34.23	20.8	40	-19.2
30.96	Vertical	34.95	21.24	40	-18.76
31.08	Vertical	34.93	20.94	40	-19.06
31.30	Vertical	36.48	21.54	40	-18.46
31.66	Vertical	35.37	21.4	40	-18.6
31.81	Vertical	35.87	21.05	40	-18.95
31.98	Vertical	36.22	21.37	40	-18.63
32.27	Vertical	37.72	21.83	40	-18.17
32.40	Vertical	38.06	21.66	40	-18.34
32.74	Vertical	40.76	22.39	40	-17.61
32.76	Vertical	39.84	21.84	40	-18.16
33.04	Vertical	40.45	23.16	40	-16.84
33.44	Vertical	39.81	23.35	40	-16.65
33.46	Vertical	39.7	22.77	40	-17.23
33.80	Vertical	41.24	24.07	40	-15.93
34.10	Vertical	41.23	24.43	40	-15.57
34.19	Vertical	41.94	24.19	40	-15.81
34.55	Vertical	40.53	24.73	40	-15.27
34.78	Vertical	40.13	26.21	40	-13.79
34.91	Vertical	39.5	24.7	40	-15.3
35.19	Vertical	38.93	26.63	40	-13.37
35.48	Vertical	37.97	26.34	40	-13.66
35.80	Vertical	37.71	25.53	40	-14.47
35.93	Vertical	37.05	24.95	40	-15.05
36.23	Vertical	36.95	24.53	40	-15.47
36.40	Vertical	36.28	23.21	40	-16.79
36.65	Vertical	36.88	22.67	40	-17.33
36.84	Vertical	40.18	26.07	40	-13.93
37.33	Vertical	42.97	27.16	40	-12.84
37.35	Vertical	41.62	26.6	40	-13.4
37.65	Vertical	44.53	29.13	40	-10.87
38.05	Vertical	45.82	29.54	40	-10.46
38.29	Vertical	45.79	31.02	40	-8.98
38.39	Vertical	45.83	30.56	40	-9.44
38.76	Vertical	46.19	30.44	40	-9.56
39.03	Vertical	46.33	31.41	40	-8.59
39.29	Vertical	46.78	30.83	40	-9.17
39.46	Vertical	46.72	31.08	40	-8.92
39.80	Vertical	47.02	31.47	40	-8.53
40.24	Vertical	45.97	30.97	40	-9.03
40.35	Vertical	48.05	31.27	40	-8.73
40.82	Vertical	47.86	32.32	40	-7.68
40.97	Vertical	48.74	31.99	40	-8.01

TRANSMITTER RADIATED SPURIOUS EMISSIONS AT FREQUENCIES >30MHZ- TABULATED RESULTS					
CHARGING + TX MODE / ALL POSITIONS / ALL CHANNELS / FOR FREQ <1GHZ				EMI6294	
41.22	Vertical	49.77	32.91	40	-7.09
41.65	Vertical	49.2	33.54	40	-6.46
41.69	Vertical	49.03	33.43	40	-6.57
41.90	Vertical	49.13	33.75	40	-6.25
42.03	Vertical	49.04	33.9	40	-6.1
42.33	Vertical	48.59	33.77	40	-6.23
42.79	Vertical	47.07	33.11	40	-6.89
43.01	Vertical	46.52	32.75	40	-7.25
43.24	Vertical	47.61	33.49	40	-6.51
43.73	Vertical	46.98	33.06	40	-6.94
43.92	Vertical	48.07	33.75	40	-6.25
44.32	Vertical	48.64	34.22	40	-5.78
44.35	Vertical	48.73	34.26	40	-5.74
44.83	Vertical	46.9	33.16	40	-6.84
45.07	Vertical	47.28	33.02	40	-6.98
45.34	Vertical	45.19	32.42	40	-7.58
45.79	Vertical	45.13	31.69	40	-8.31
46.19	Vertical	44.45	31.41	40	-8.59
46.22	Vertical	44.13	31.08	40	-8.92
46.81	Vertical	43.62	31.03	40	-8.97
46.90	Vertical	43.02	30.42	40	-9.58
47.26	Vertical	42.44	30.03	40	-9.97
47.79	Vertical	41.92	29.53	40	-10.47
47.83	Vertical	42	29.74	40	-10.26
48.19	Vertical	41.6	29.3	40	-10.7
48.64	Vertical	40.79	28.44	40	-11.56
48.87	Vertical	40.55	28.29	40	-11.71
49.21	Vertical	39.84	27.76	40	-12.24
49.72	Vertical	38.1	26.1	40	-13.9
50.04	Vertical	38.4	25.29	40	-14.71
50.28	Vertical	39.01	26.16	40	-13.84
50.79	Vertical	38.16	24.93	40	-15.07
51.17	Vertical	38.25	24.9	40	-15.1
51.19	Vertical	37.61	24.87	40	-15.13
51.70	Vertical	37.47	24.02	40	-15.98
52.02	Vertical	37.5	24.03	40	-15.97
52.53	Vertical	36.66	23.2	40	-16.8
52.63	Vertical	36.75	23.44	40	-16.56
53.19	Vertical	35.53	22.63	40	-17.37
53.42	Vertical	35.75	22.58	40	-17.42
54.44	Vertical	34.65	21.12	40	-18.88
54.46	Vertical	33.28	20.61	40	-19.39
55.84	Vertical	34.32	20.95	40	-19.05
56.29	Vertical	35.7	21.57	40	-18.43
56.74	Vertical	34.47	21.3	40	-18.7
52.53	Horizontal	29.87	18.88	40	-21.12
52.55	Horizontal	28.85	18.88	40	-21.12
52.74	Horizontal	29.46	18.99	40	-21.01

TRANSMITTER RADIATED SPURIOUS EMISSIONS AT FREQUENCIES >30MHZ- TABULATED RESULTS					
CHARGING + TX MODE / ALL POSITIONS / ALL CHANNELS / FOR FREQ <1GHZ				EMI6294	
52.76	Horizontal	28.82	18.87	40	-21.13
53.02	Horizontal	29.29	19.03	40	-20.97
53.06	Horizontal	29.62	18.96	40	-21.04
53.10	Horizontal	29.57	18.96	40	-21.04
53.59	Horizontal	30.68	19.16	40	-20.84
53.61	Horizontal	30.91	19.1	40	-20.9
53.76	Horizontal	31.07	19.2	40	-20.8
53.78	Horizontal	30.97	19.2	40	-20.8
53.85	Horizontal	30.37	19.14	40	-20.86
53.87	Horizontal	30.98	19.19	40	-20.81
53.91	Horizontal	30.23	19.25	40	-20.75
54.06	Horizontal	31.72	19.46	40	-20.54
54.08	Horizontal	30.93	19.51	40	-20.49
54.14	Horizontal	31.4	19.45	40	-20.55
54.16	Horizontal	31.26	19.45	40	-20.55
54.23	Horizontal	32.21	19.45	40	-20.55
54.25	Horizontal	32.07	19.61	40	-20.39
54.31	Horizontal	32.9	19.71	40	-20.29
54.33	Horizontal	32.52	19.92	40	-20.08
54.40	Horizontal	33.19	20.12	40	-19.88
54.42	Horizontal	33.53	20.17	40	-19.83
54.46	Horizontal	33.3	20.42	40	-19.58
54.53	Horizontal	33.29	20.46	40	-19.54
54.55	Horizontal	33.8	20.31	40	-19.69
54.61	Horizontal	33.43	20.74	40	-19.26
54.63	Horizontal	34.39	20.6	40	-19.4
54.70	Horizontal	34.33	21.2	40	-18.8
54.74	Horizontal	34.62	21.28	40	-18.72
54.76	Horizontal	34.65	21.37	40	-18.63
54.82	Horizontal	34.8	21.75	40	-18.25
54.84	Horizontal	34.49	21.45	40	-18.55
54.91	Horizontal	34.88	21.91	40	-18.09
54.95	Horizontal	34.72	21.57	40	-18.43
54.97	Horizontal	36.27	21.66	40	-18.34
55.01	Horizontal	36.48	22.39	40	-17.61
55.06	Horizontal	36.55	22.31	40	-17.69
55.12	Horizontal	35.98	22.84	40	-17.16
55.16	Horizontal	35.95	22.88	40	-17.12
55.21	Horizontal	36.19	22.65	40	-17.35
55.23	Horizontal	36.44	22.73	40	-17.27
55.27	Horizontal	35.79	22.69	40	-17.31
55.33	Horizontal	36.47	22.27	40	-17.73
55.35	Horizontal	36.45	22.54	40	-17.46
55.42	Horizontal	36.56	23.27	40	-16.73
55.46	Horizontal	36.68	23.52	40	-16.48
55.48	Horizontal	36.92	23.31	40	-16.69
55.52	Horizontal	36.9	23.31	40	-16.69
55.59	Horizontal	36.5	23.2	40	-16.8

TRANSMITTER RADIATED SPURIOUS EMISSIONS AT FREQUENCIES >30MHZ- TABULATED RESULTS					
CHARGING + TX MODE / ALL POSITIONS / ALL CHANNELS / FOR FREQ <1GHZ				EMI6294	
55.63	Horizontal	36.04	22.65	40	-17.35
55.65	Horizontal	36.56	22.8	40	-17.2
55.76	Horizontal	36.13	22.27	40	-17.73
55.78	Horizontal	36.58	22.31	40	-17.69
55.84	Horizontal	36.35	22.8	40	-17.2
55.86	Horizontal	36.52	22.76	40	-17.24
55.93	Horizontal	36.37	22.54	40	-17.46
55.95	Horizontal	35.31	22.03	40	-17.97
55.99	Horizontal	35.91	21.82	40	-18.18
56.06	Horizontal	34.68	21.44	40	-18.56
56.10	Horizontal	34.92	21.22	40	-18.78
56.12	Horizontal	34.85	21.31	40	-18.69
56.16	Horizontal	34.94	21.39	40	-18.61
56.20	Horizontal	34.44	21.04	40	-18.96
56.27	Horizontal	34.23	20.66	40	-19.34
56.29	Horizontal	33.94	20.76	40	-19.24
56.33	Horizontal	33.6	20.28	40	-19.72
56.40	Horizontal	33.88	19.76	40	-20.24
56.42	Horizontal	32.55	19.71	40	-20.29
56.48	Horizontal	32.33	19.71	40	-20.29
56.52	Horizontal	32.39	19.5	40	-20.5
56.54	Horizontal	31.54	19.44	40	-20.56
56.69	Horizontal	29.97	18.88	40	-21.12
77.78	Horizontal	30	19.08	40	-20.92
77.82	Horizontal	31.21	19.17	40	-20.83
77.84	Horizontal	30.88	19.21	40	-20.79
77.90	Horizontal	31.18	19.49	40	-20.51
77.92	Horizontal	31.66	19.21	40	-20.79
78.03	Horizontal	31.21	19.53	40	-20.47
78.07	Horizontal	31.61	19.57	40	-20.43
78.09	Horizontal	32.71	19.66	40	-20.34
78.16	Horizontal	32.26	19.75	40	-20.25
78.20	Horizontal	31.84	19.96	40	-20.04
78.22	Horizontal	31.7	19.96	40	-20.04
78.26	Horizontal	31.81	20.09	40	-19.91
78.33	Horizontal	32.93	20.42	40	-19.58
78.35	Horizontal	32.3	20.42	40	-19.58
78.39	Horizontal	32.11	20.25	40	-19.75
78.43	Horizontal	32.7	20.33	40	-19.67
78.48	Horizontal	32.85	20.49	40	-19.51
78.54	Horizontal	33.18	21	40	-19
78.56	Horizontal	33.92	20.85	40	-19.15
78.63	Horizontal	32.97	20.8	40	-19.2
78.65	Horizontal	33.45	20.8	40	-19.2
78.69	Horizontal	33.4	20.76	40	-19.24
78.75	Horizontal	32.71	20.87	40	-19.13
78.77	Horizontal	32.85	20.99	40	-19.01
78.82	Horizontal	33.22	21.1	40	-18.9

TRANSMITTER RADIATED SPURIOUS EMISSIONS AT FREQUENCIES >30MHZ- TABULATED RESULTS					
CHARGING + TX MODE / ALL POSITIONS / ALL CHANNELS / FOR FREQ <1GHZ				EMI6294	
78.88	Horizontal	33.5	21.36	40	-18.64
78.90	Horizontal	34.47	21.43	40	-18.57
78.97	Horizontal	33.27	21.67	40	-18.33
78.99	Horizontal	33.24	21.53	40	-18.47
79.05	Horizontal	33.86	21.53	40	-18.47
79.07	Horizontal	33.98	21.45	40	-18.55
79.14	Horizontal	33.49	21.56	40	-18.44
79.16	Horizontal	33.42	21.59	40	-18.41
79.22	Horizontal	33.32	21.58	40	-18.42
79.26	Horizontal	33.84	21.55	40	-18.45
79.28	Horizontal	34.06	21.76	40	-18.24
79.35	Horizontal	33.69	21.86	40	-18.14
79.39	Horizontal	34.12	21.96	40	-18.04
79.41	Horizontal	34.33	22.06	40	-17.94
79.45	Horizontal	33.58	21.6	40	-18.4
79.52	Horizontal	34.41	22.05	40	-17.95
79.56	Horizontal	33.45	21.88	40	-18.12
79.60	Horizontal	33.66	21.94	40	-18.06
79.62	Horizontal	33.9	22.08	40	-17.92
79.67	Horizontal	34.35	21.97	40	-18.03
79.73	Horizontal	33.89	21.69	40	-18.31
79.77	Horizontal	33.92	21.96	40	-18.04
79.79	Horizontal	34.21	21.89	40	-18.11
79.84	Horizontal	33.91	21.96	40	-18.04
79.88	Horizontal	34.03	21.92	40	-18.08
79.92	Horizontal	34.19	22.02	40	-17.98
79.99	Horizontal	34.36	22.18	40	-17.82
80.03	Horizontal	34.4	22.21	40	-17.79
80.05	Horizontal	34.54	22.34	40	-17.66
80.11	Horizontal	34.71	22.24	40	-17.76
80.14	Horizontal	34.27	22.18	40	-17.82
80.20	Horizontal	34.7	22.4	40	-17.6
80.22	Horizontal	33.97	22.17	40	-17.83
80.28	Horizontal	34.28	22	40	-18
80.31	Horizontal	34.12	22.33	40	-17.67
80.35	Horizontal	34.2	22.1	40	-17.9
80.41	Horizontal	34.29	22.29	40	-17.71
80.43	Horizontal	34.3	22.19	40	-17.81
80.48	Horizontal	34.02	21.92	40	-18.08
80.54	Horizontal	34.1	22.05	40	-17.95
80.58	Horizontal	34	21.85	40	-18.15
80.60	Horizontal	34.32	21.78	40	-18.22
80.67	Horizontal	34.21	21.84	40	-18.16
80.71	Horizontal	34.15	22.01	40	-17.99
80.73	Horizontal	34.31	22.31	40	-17.69
80.77	Horizontal	33.98	22.08	40	-17.92
80.82	Horizontal	34.12	21.63	40	-18.37
80.88	Horizontal	33.94	21.8	40	-18.2

TRANSMITTER RADIATED SPURIOUS EMISSIONS AT FREQUENCIES >30MHZ- TABULATED RESULTS					
CHARGING + TX MODE / ALL POSITIONS / ALL CHANNELS / FOR FREQ <1GHZ				EMI6294	
80.92	Horizontal	33.98	21.9	40	-18.1
80.94	Horizontal	34.16	21.97	40	-18.03
80.99	Horizontal	33.99	21.73	40	-18.27
81.09	Horizontal	33.54	21.72	40	-18.28
81.13	Horizontal	34.15	21.82	40	-18.18
81.16	Horizontal	33.65	21.82	40	-18.18
81.22	Horizontal	33.75	21.54	40	-18.46
81.24	Horizontal	33.91	21.54	40	-18.46
81.30	Horizontal	33.68	21.35	40	-18.65
81.35	Horizontal	33.52	21.32	40	-18.68
81.37	Horizontal	33.46	21.42	40	-18.58
81.43	Horizontal	33.51	21.17	40	-18.83
81.47	Horizontal	32.91	21.13	40	-18.87
81.50	Horizontal	33.21	20.82	40	-19.18
81.56	Horizontal	33.2	20.9	40	-19.1
81.58	Horizontal	33.34	21.05	40	-18.95
81.62	Horizontal	33.02	20.85	40	-19.15
81.69	Horizontal	32.7	20.74	40	-19.26
81.71	Horizontal	32.55	20.77	40	-19.23
81.77	Horizontal	32.6	20.77	40	-19.23
81.79	Horizontal	32.61	20.88	40	-19.12
81.86	Horizontal	33.08	20.69	40	-19.31
81.90	Horizontal	32.47	20.69	40	-19.31
81.94	Horizontal	32.39	20.45	40	-19.55

Spurious which has more than 20 dB of margin compared to the applicable limit is not necessarily reported

TEST SETUP PHOTO(S) – TX MODE / POSITION 1



TEST SETUP PHOTO(S) – TX MODE – POSITION 2



TEST SETUP PHOTO(S) – TX MODE – POSITION 3

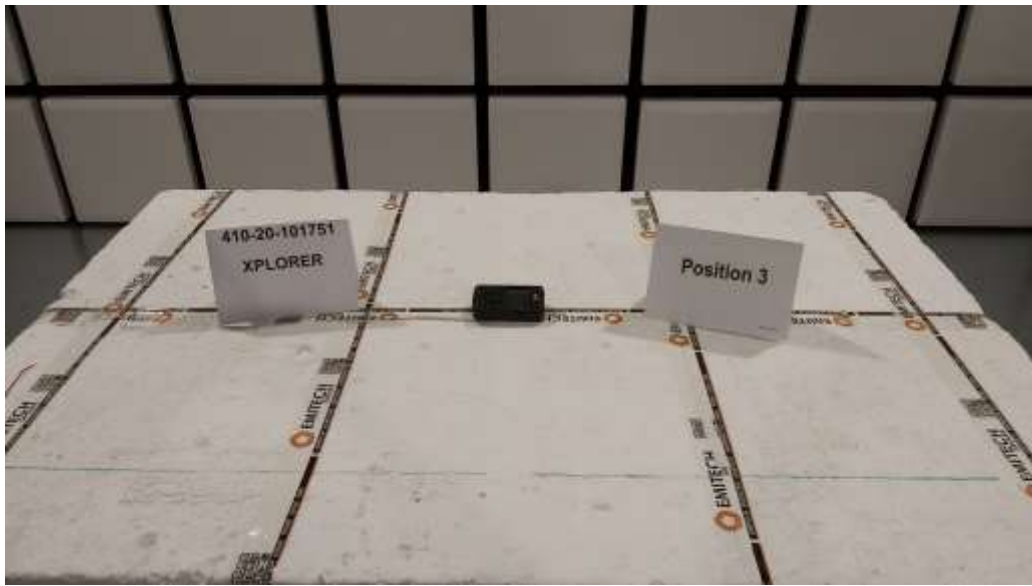

TEST SETUP PHOTO(S) – CHARGING + TX MODE – POSITION 1



TEST SETUP PHOTO(S) - CHARGING + TX MODE – POSITION 2

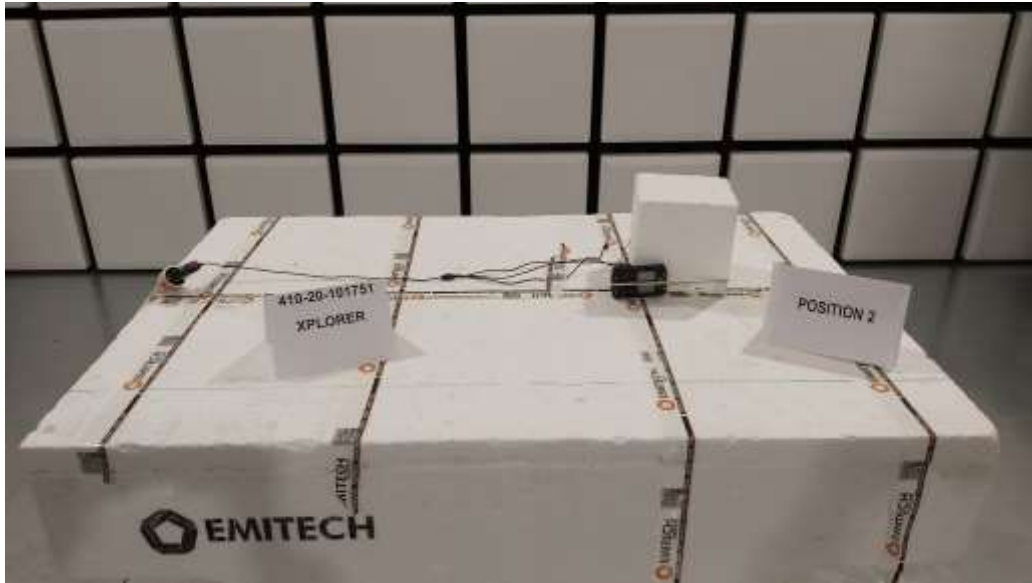

TEST SETUP PHOTO(S) - CHARGING + TX MODE – POSITION 3

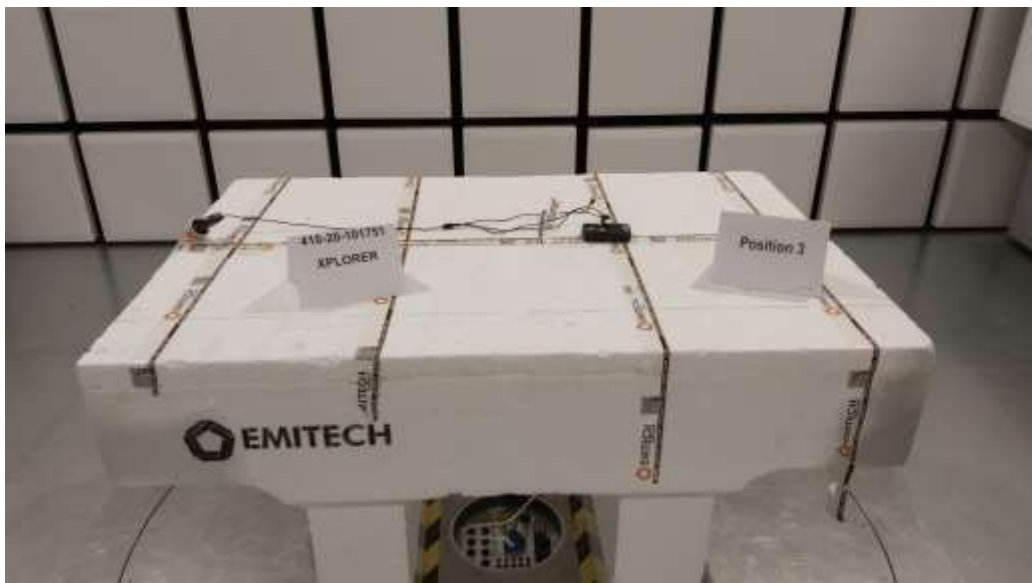

TEST SETUP PHOTO(S) – TX MODE – 30MHZ TO 200MHZ



TEST SETUP PHOTO(S) – TX MODE – 200MHZ TO 1GHZ



TEST SETUP PHOTO(S) – TX MODE – 1GHZ TO 18GHZ



TEST SETUP PHOTO(S) - TX MODE / 18GHZ TO 26.5GHZ

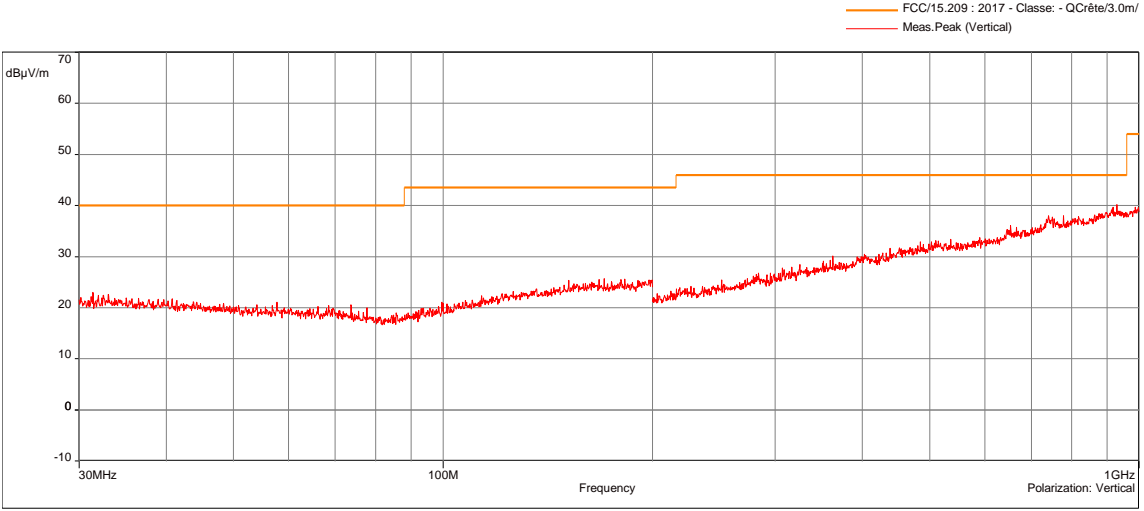
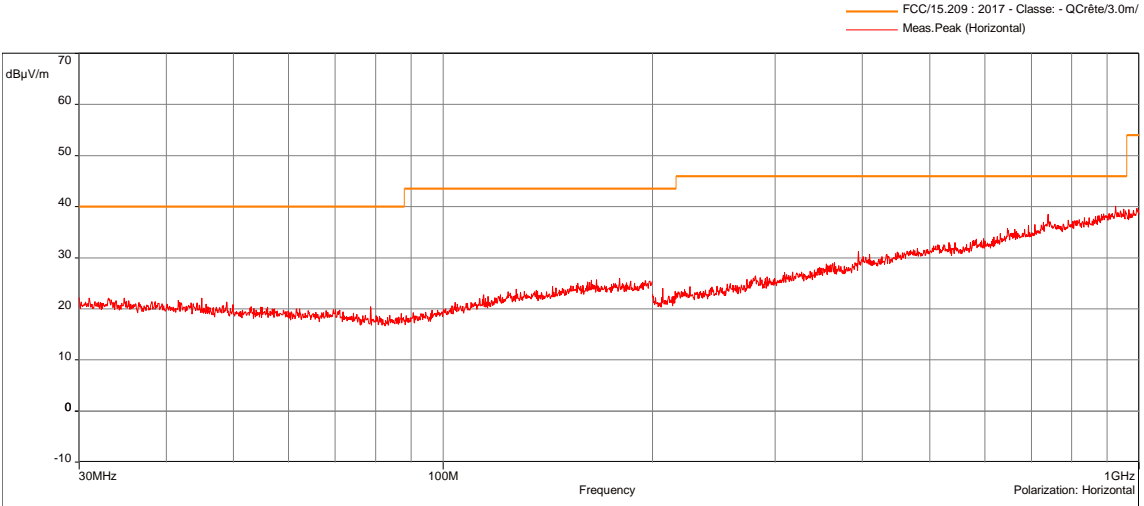

TRANSMITTER RADIATED SPURIOUS EMISSIONS AT FREQUENCIES >30MHZ - GRAPH					
TX MODE / ALL POSITIONS / ALL CHANNELS / FOR FREQ <1GHZ				EMI6136	
EUT mode:	Modulated			T (°C):	19.3
Test Date:	15/02/2021			H (%):	27.1
Test Operator:	ATO & OAT			P (hPa):	1006
 <p style="text-align: right; font-size: small;"> — FCC/15.209 : 2017 - Classe: - QCrête/3.0m/ — Meas. Peak (Vertical) </p> <p style="text-align: center; font-size: x-small;">Tx mode / All Positions / All Channels / For freq <1GHz - 02/15/2021 13:53 - 6136 -</p>					
 <p style="text-align: right; font-size: small;"> — FCC/15.209 : 2017 - Classe: - QCrête/3.0m/ — Meas. Peak (Horizontal) </p> <p style="text-align: center; font-size: x-small;">Tx mode / All Positions / All Channels / For freq <1GHz - 02/15/2021 13:53 - 6136 -</p>					
POSITION	FREQUENCIES	RBW	VBW	DETECTOR	
Vertical	30MHz-200MHz	100kHz	300kHz	Peak	
Horizontal	30MHz-200MHz	100kHz	300kHz	Peak	
Horizontal	200MHz-1GHz	100kHz	300kHz	Peak	
Vertical	200MHz-1GHz	100kHz	300kHz	Peak	
Configuration:	N/A				
Comments:	N/A				
EUT modification(s): N/A					

TRANSMITTER RADIATED SPURIOUS EMISSIONS AT FREQUENCIES >30MHz - GRAPH			
CHARGING + Tx MODE / ALL POSITIONS / ALL CHANNELS / FOR FREQ <1GHz			EMI6294
EUT mode:	Modulated		T (°C): 19.3
Test Date:	16/02/2021		H (%): 27.1
Test Operator:	ATO & OAT		P (hPa): 1006

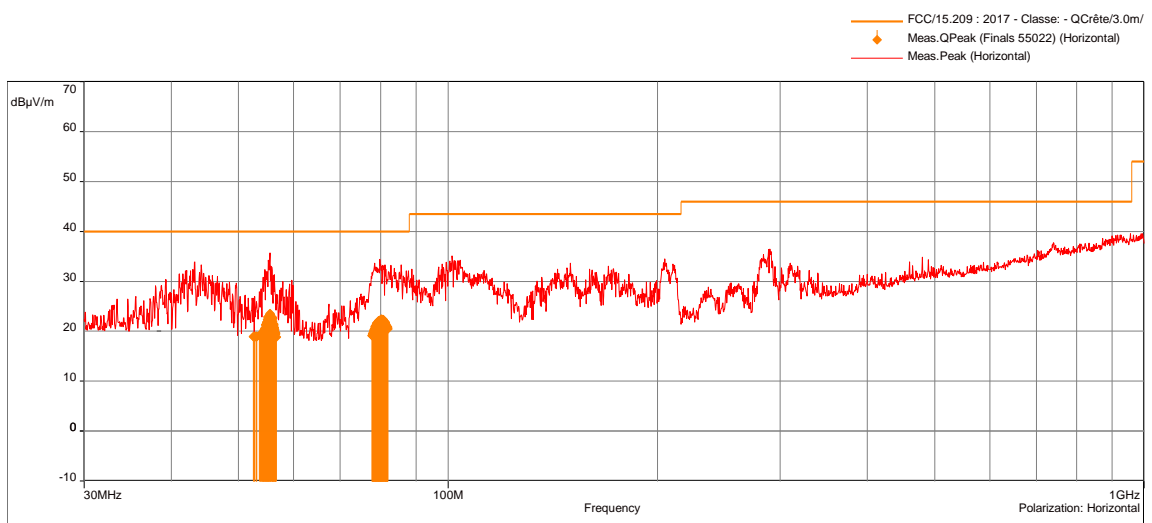
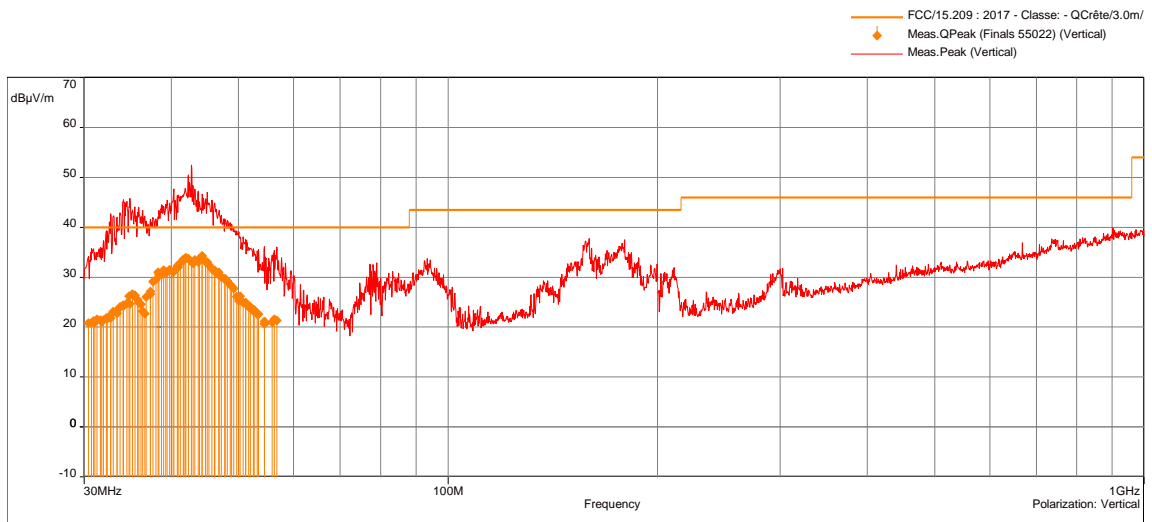

POSITION	FREQUENCIES	RBW	VBW	DETECTOR
Vertical	30MHz-200MHz	100kHz	300kHz	Peak
Horizontal	30MHz-200MHz	100kHz	300kHz	Peak
Horizontal	200MHz-1GHz	100kHz	300kHz	Peak
Vertical	200MHz-1GHz	100kHz	300kHz	Peak
Configuration:	N/A			
Comments:	N/A			
EUT modification(s): N/A				

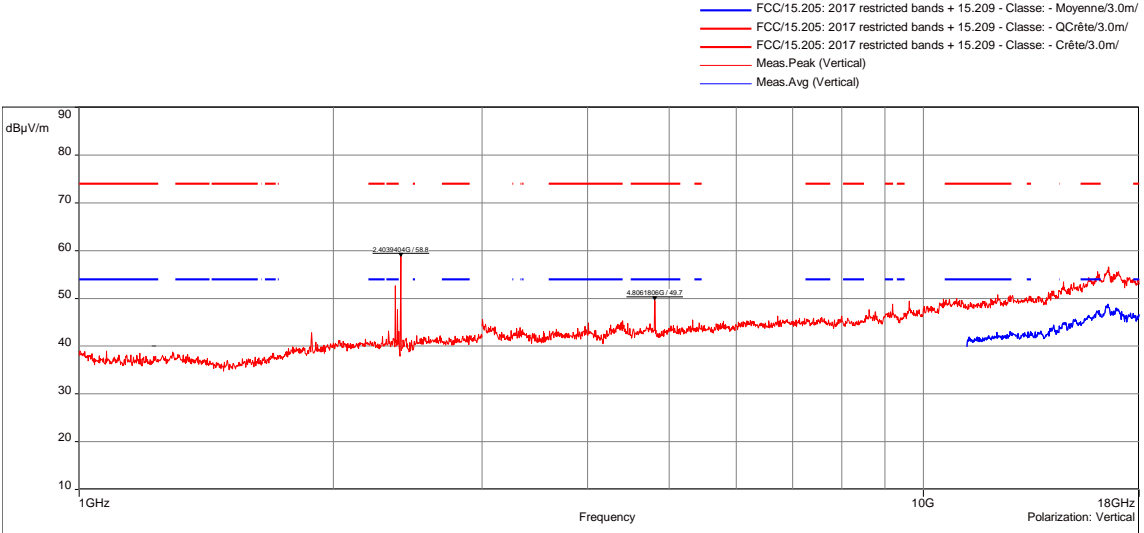
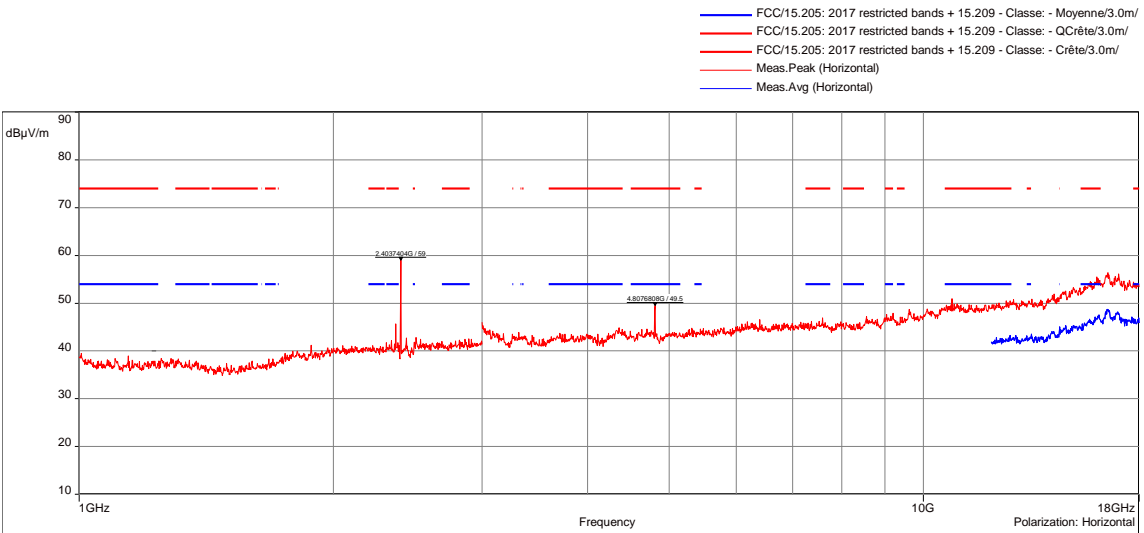
TRANSMITTER RADIATED SPURIOUS EMISSIONS AT FREQUENCIES >30MHz - GRAPH					
TX MODE / ALL POSITIONS / LOW CHANNEL / 1GHz TO 18GHz				EMI7076	
EUT mode:	Modulated			T (°C):	22.9
Test Date:	26/03/2021			H (%):	24.9
Test Operator:	ATO & OAT			P (hPa):	1015
 <p style="text-align: right;"> — FCC/15.205: 2017 restricted bands + 15.209 - Classe: - Moyenne/3.0m/ — FCC/15.205: 2017 restricted bands + 15.209 - Classe: - QCrête/3.0m/ — FCC/15.205: 2017 restricted bands + 15.209 - Classe: - Crête/3.0m/ — Meas.Peak (Vertical) — Meas.Avg (Vertical) </p> <p>Tx mode / All Positions / Low channel / 1GHz to 18GHz - 7076</p>					
 <p style="text-align: right;"> — FCC/15.205: 2017 restricted bands + 15.209 - Classe: - Moyenne/3.0m/ — FCC/15.205: 2017 restricted bands + 15.209 - Classe: - QCrête/3.0m/ — FCC/15.205: 2017 restricted bands + 15.209 - Classe: - Crête/3.0m/ — Meas.Peak (Horizontal) — Meas.Avg (Horizontal) </p> <p>Tx mode / All Positions / Low channel / 1GHz to 18GHz - 7076</p>					
POSITION	FREQUENCIES	RBW	VBW	DETECTOR	
Vertical	1GHz-3GHz	1MHz	3MHz	Peak	
Horizontal	1GHz-3GHz	1MHz	3MHz	Peak	
Vertical	3GHz-18GHz	1MHz	3MHz	Peak	
Horizontal	3GHz-18GHz	1MHz	3MHz	Peak	
Vertical	10GHz-18GHz	1MHz	50kHz	Peak	
Horizontal	10GHz-18GHz	1MHz	50kHz	Peak	
Configuration:	N/A				
Comments:	N/A				
EUT modification(s): N/A					

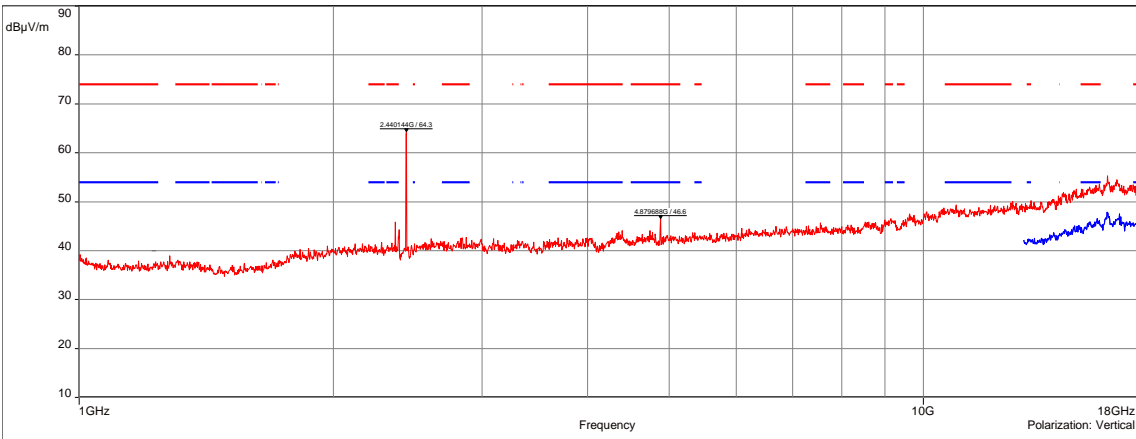
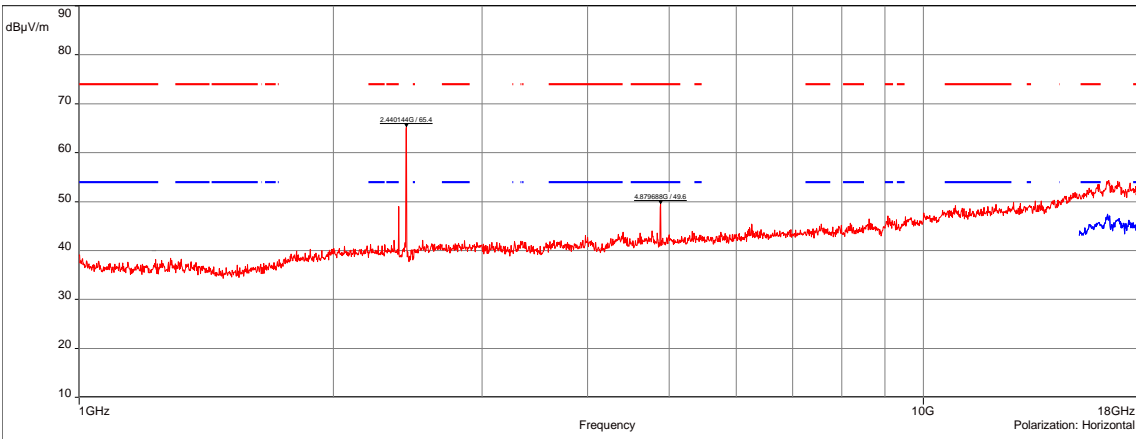
TRANSMITTER RADIATED SPURIOUS EMISSIONS AT FREQUENCIES >30MHz - GRAPH					
TX MODE / ALL POSITIONS / MID CHANNEL / 1GHz TO 18GHz				EMI6966	
EUT mode:	Modulated			T (°C):	23.2
Test Date:	26/03/2021			H (%):	38.9
Test Operator:	ATO & OAT			P (hPa):	1015
<div style="text-align: right;"> <p>— FCC/15.205: 2017 restricted bands + 15.209 - Classe: - Moyenne/3.0m/</p> <p>— FCC/15.205: 2017 restricted bands + 15.209 - Classe: - Crête/3.0m/</p> <p>— Meas.Peak (Vertical)</p> <p>— Meas.Avg (Vertical)</p> </div>  <p>Tx mode / All Positions / Mid channel / 1GHz to 18GHz - 6966</p>					
<div style="text-align: right;"> <p>— FCC/15.205: 2017 restricted bands + 15.209 - Classe: - Moyenne/3.0m/</p> <p>— FCC/15.205: 2017 restricted bands + 15.209 - Classe: - Crête/3.0m/</p> <p>— Meas.Peak (Horizontal)</p> <p>— Meas.Avg (Horizontal)</p> </div>  <p>Tx mode / All Positions / Mid channel / 1GHz to 18GHz - 6966</p>					
POSITION	FREQUENCIES	RBW	VBW	DETECTOR	
Vertical	1GHz-3GHz	1MHz	3MHz	Peak	
Horizontal	1GHz-3GHz	1MHz	3MHz	Peak	
Vertical	3GHz-18GHz	1MHz	3MHz	Peak	
Horizontal	3GHz-18GHz	1MHz	3MHz	Peak	
Vertical	10GHz-18GHz	1MHz	50kHz	Peak	
Horizontal	10GHz-18GHz	1MHz	50kHz	Peak	
Configuration:	N/A				
Comments:	2.4GHz is due to operating frequency				
EUT modification(s): N/A					

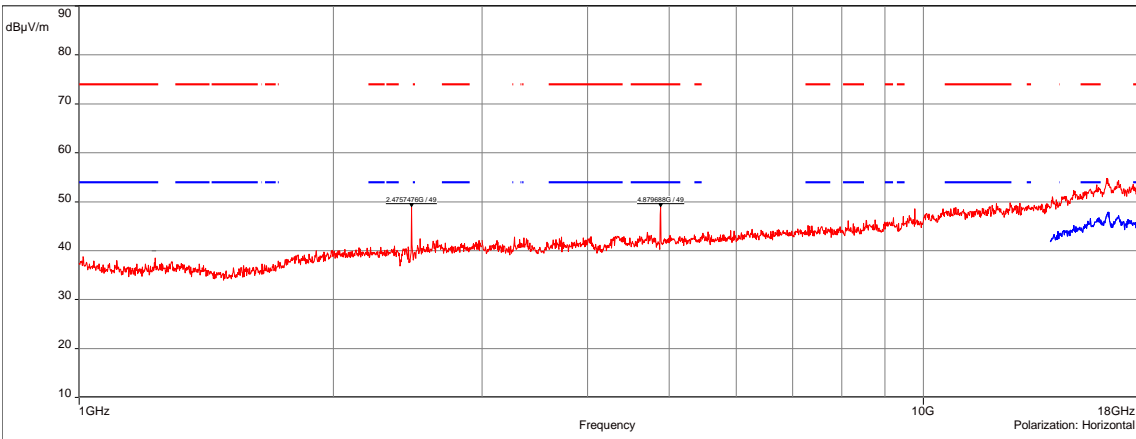
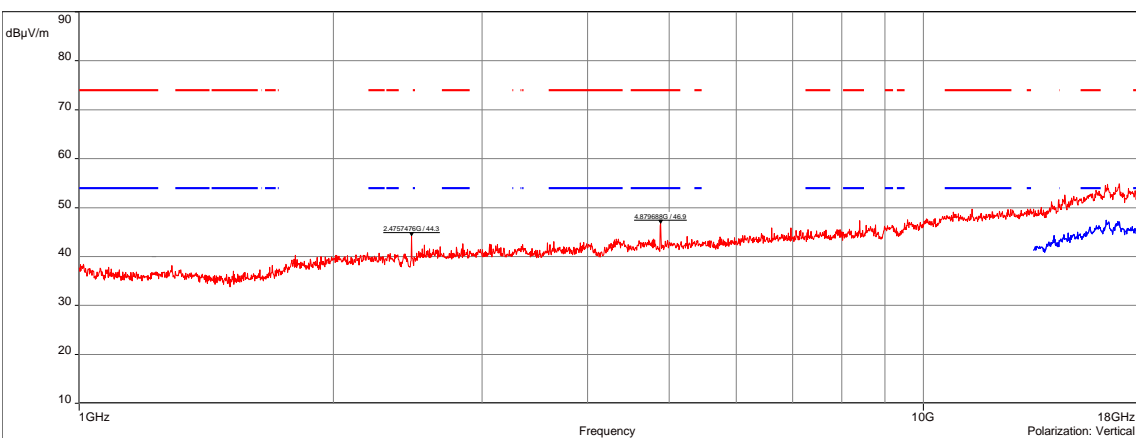
TRANSMITTER RADIATED SPURIOUS EMISSIONS AT FREQUENCIES >30MHz - GRAPH					
TX MODE / ALL POSITIONS / HIGH CHANNEL / 1GHz TO 18GHz				EMI6967	
EUT mode:	Modulated			T (°C):	23.2
Test Date:	06/04/2021			H (%):	38.9
Test Operator:	ATO & OAT			P (hPa):	1015
 <p style="text-align: center;">Tx mode / All Positions / High channel / 1GHz to 18GHz - 6967</p>					
 <p style="text-align: center;">Tx mode / All Positions / High channel / 1GHz to 18GHz - 6967</p>					
POSITION	FREQUENCIES	RBW	VBW	DETECTOR	
Vertical	1GHz-3GHz	1MHz	3MHz	Peak	
Horizontal	1GHz-3GHz	1MHz	3MHz	Peak	
Vertical	3GHz-18GHz	1MHz	3MHz	Peak	
Horizontal	3GHz-18GHz	1MHz	3MHz	Peak	
Vertical	10GHz-18GHz	1MHz	50kHz	Peak	
Horizontal	10GHz-18GHz	1MHz	50kHz	Peak	
Configuration:	N/A				
Comments:	2.4GHz is due to operating frequency				
EUT modification(s): N/A					

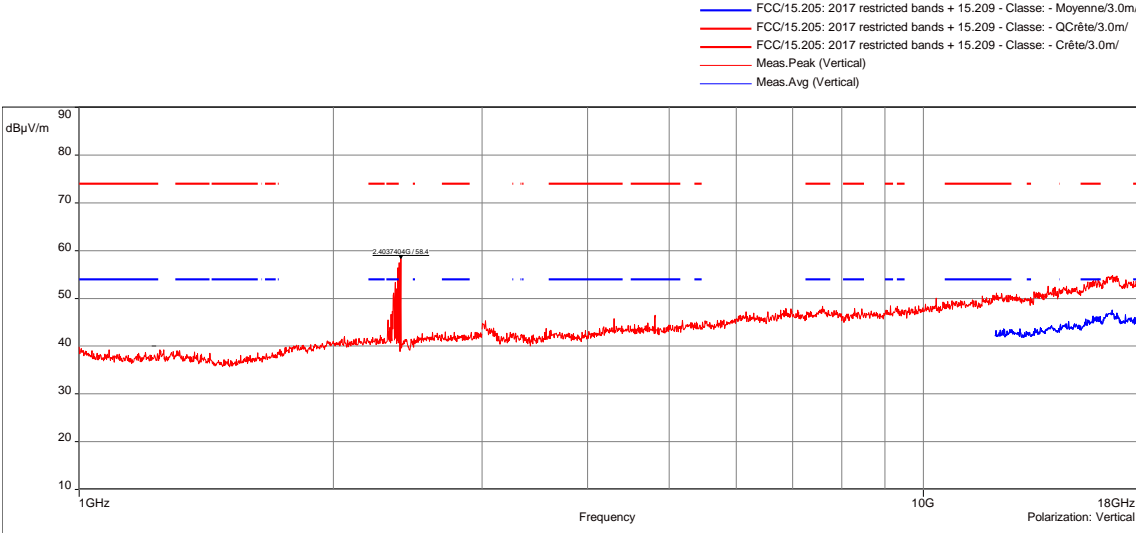
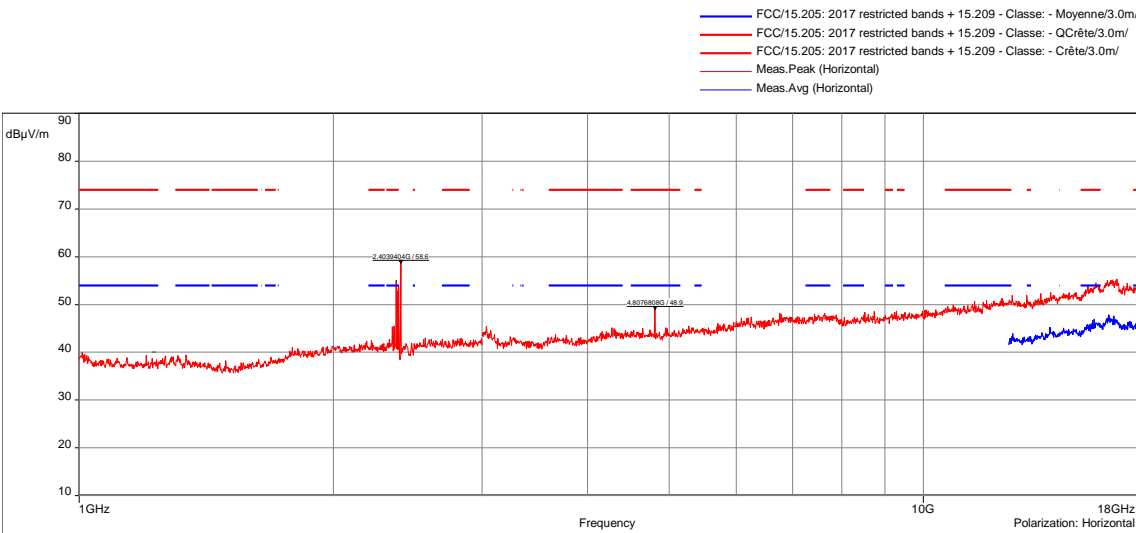
TRANSMITTER RADIATED SPURIOUS EMISSIONS AT FREQUENCIES >30MHz - GRAPH					
CHARGING + TX MODE / ALL POSITIONS / LOW CHANNEL / 1GHz TO 18GHz				EMI7197	
EUT mode:	Modulated			T (°C):	20.4
Test Date:	07/04/2021			H (%):	17.0
Test Operator:	ATO & OAT			P (hPa):	1017
 <p>Charging + Tx mode / All Positions / Low channel / 1GHz to 18GHz - 7197</p>					
 <p>Charging + Tx mode / All Positions / Low channel / 1GHz to 18GHz - 7197</p>					
POSITION	FREQUENCIES	RBW	VBW	DETECTOR	
Vertical	1GHz-3GHz	1MHz	3MHz	Peak	
Horizontal	1GHz-3GHz	1MHz	3MHz	Peak	
Vertical	3GHz-18GHz	1MHz	3MHz	Peak	
Horizontal	3GHz-18GHz	1MHz	3MHz	Peak	
Vertical	10GHz-18GHz	1MHz	50kHz	Peak	
Horizontal	10GHz-18GHz	1MHz	50kHz	Peak	
Configuration:	N/A				
Comments:	2.4GHz is due to operating frequency				
EUT modification(s): N/A					

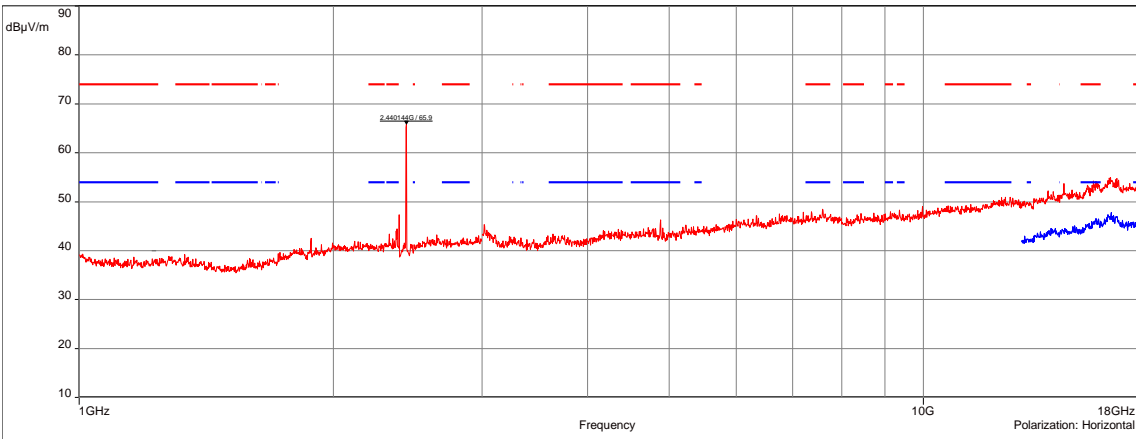
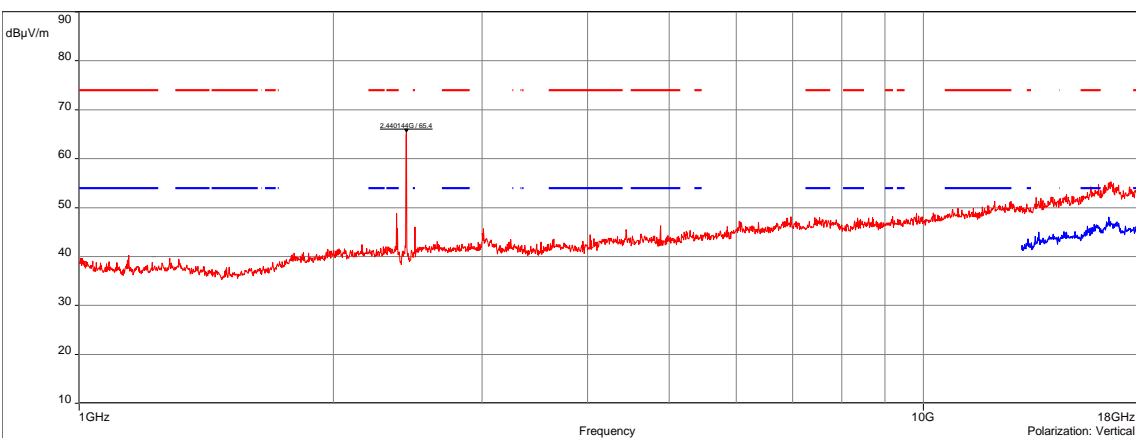
TRANSMITTER RADIATED SPURIOUS EMISSIONS AT FREQUENCIES >30MHz - GRAPH					
CHARGING + Tx MODE / ALL POSITIONS / MID CHANNEL / 1GHz TO 18GHz				EMI7198	
EUT mode:	Modulated			T (°C):	20.4
Test Date:	07/04/2021			H (%):	17.0
Test Operator:	ATO & OAT			P (hPa):	1017
<div style="text-align: right;"> <p>— FCC/15.205: 2017 restricted bands + 15.209 - Classe: - Moyenne/3.0m/</p> <p>— FCC/15.205: 2017 restricted bands + 15.209 - Classe: - Crête/3.0m/</p> <p>— Meas.Peak (Horizontal)</p> <p>— Meas.Avg (Horizontal)</p> </div>  <p>Charging + Tx mode / All Positions / Mid channel / 1GHz to 18GHz - 7198</p>					
<div style="text-align: right;"> <p>— FCC/15.205: 2017 restricted bands + 15.209 - Classe: - Moyenne/3.0m/</p> <p>— FCC/15.205: 2017 restricted bands + 15.209 - Classe: - Crête/3.0m/</p> <p>— Meas.Peak (Vertical)</p> <p>— Meas.Avg (Vertical)</p> </div>  <p>Charging + Tx mode / All Positions / Mid channel / 1GHz to 18GHz - 7198</p>					
POSITION	FREQUENCIES	RBW	VBW	DETECTOR	
Vertical	1GHz-3GHz	1MHz	3MHz	Peak	
Horizontal	1GHz-3GHz	1MHz	3MHz	Peak	
Vertical	3GHz-18GHz	1MHz	3MHz	Peak	
Horizontal	3GHz-18GHz	1MHz	3MHz	Peak	
Vertical	10GHz-18GHz	1MHz	50kHz	Peak	
Horizontal	10GHz-18GHz	1MHz	50kHz	Peak	
Configuration:	N/A				
Comments:	2.4GHz is due to operating frequency				
EUT modification(s): N/A					

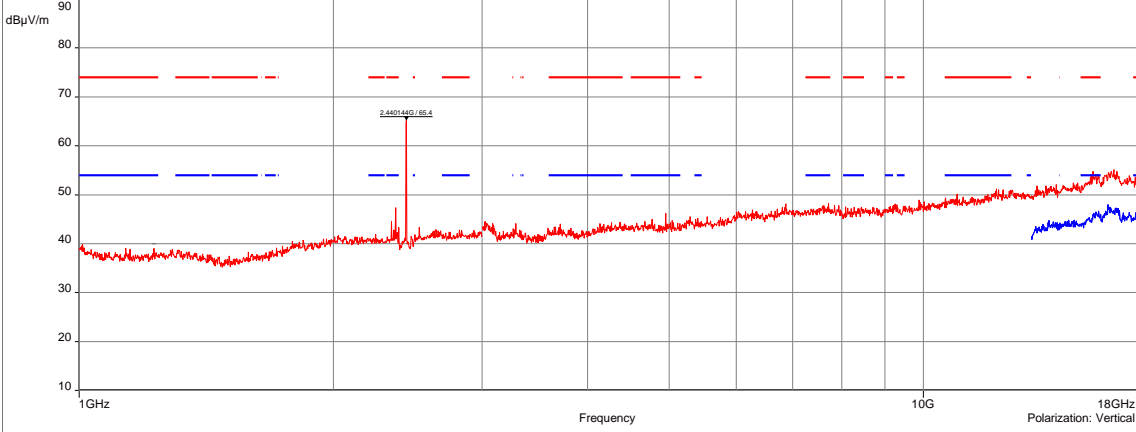
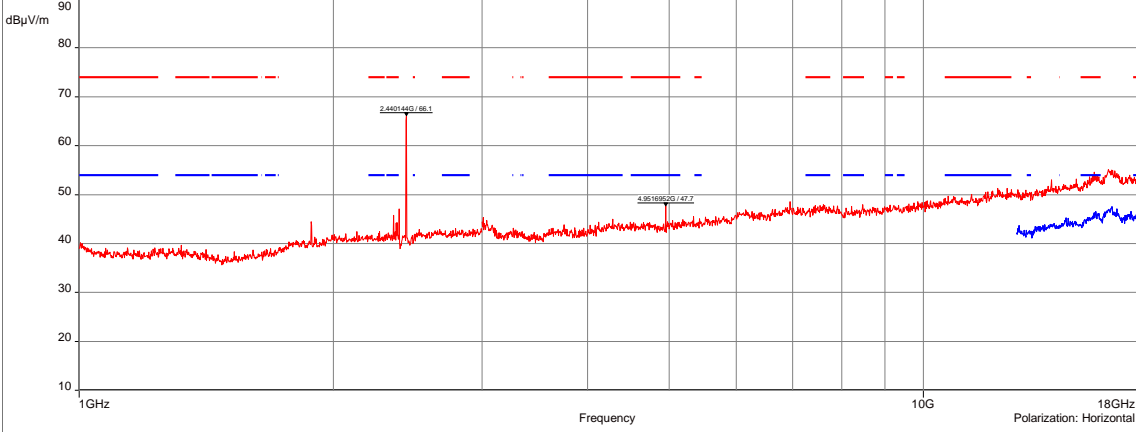
TRANSMITTER RADIATED SPURIOUS EMISSIONS AT FREQUENCIES >30MHz - GRAPH					
CHARGING + TX MODE / ALL POSITIONS / HIGH CHANNEL / 1GHz TO 18GHz				EMI7199	
EUT mode:	Modulated			T (°C):	20.4
Test Date:	07/04/2021			H (%):	17.0
Test Operator:	ATO & OAT			P (hPa):	1017
<div style="font-size: small;"> — FCC/15.205: 2017 restricted bands + 15.209 - Classe: - Moyenne/3.0m/ — FCC/15.205: 2017 restricted bands + 15.209 - Classe: - Crête/3.0m/ — Meas.Peak (Vertical) — Meas.Avg (Vertical) </div>					
					
Charging + Tx mode / All Positions / High channel / 1GHz to 18GHz - 7199					
<div style="font-size: small;"> — FCC/15.205: 2017 restricted bands + 15.209 - Classe: - Moyenne/3.0m/ — FCC/15.205: 2017 restricted bands + 15.209 - Classe: - Crête/3.0m/ — Meas.Peak (Horizontal) — Meas.Avg (Horizontal) </div>					
					
Charging + Tx mode / All Positions / High channel / 1GHz to 18GHz - 7199					
POSITION	FREQUENCIES	RBW	VBW	DETECTOR	
Vertical	1GHz-3GHz	1MHz	3MHz	Peak	
Horizontal	1GHz-3GHz	1MHz	3MHz	Peak	
Vertical	3GHz-18GHz	1MHz	3MHz	Peak	
Horizontal	3GHz-18GHz	1MHz	3MHz	Peak	
Configuration:	N/A				
Comments:	2.4GHz is due to operating frequency				
EUT modification(s): N/A					

TRANSMITTER RADIATED SPURIOUS EMISSIONS AT FREQUENCIES >30MHZ - GRAPH			
TX MODE / ALL POSITIONS / LOW CHANNEL / 18GHZ TO 26.5GHZ			EMI7227
EUT mode:	Modulated		T (°C): 21.6
Test Date:	08/04/2021		H (%): 25.4
Test Operator:	ATO & OAT		P (hPa): 1015

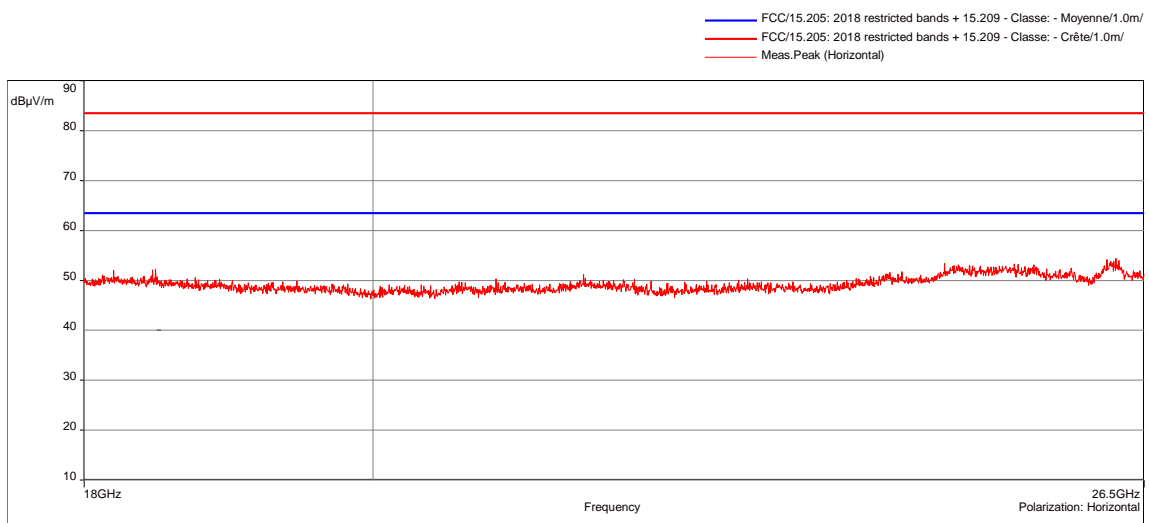
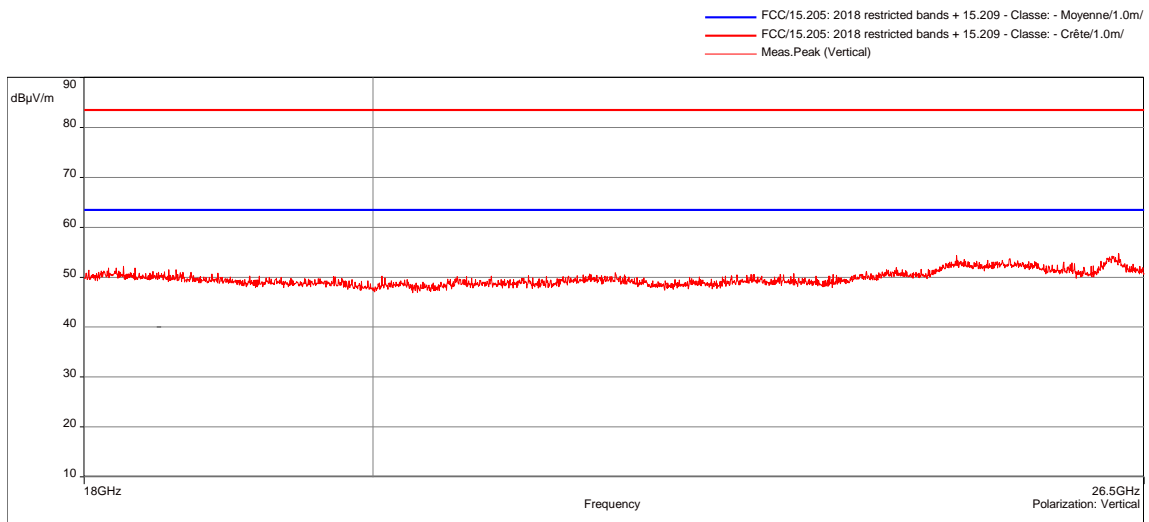

POSITION	FREQUENCIES	RBW	VBW	DETECTOR
Vertical	18GHz-26.5GHz	1MHz	3MHz	Peak
Horizontal	18GHz-26.5GHz	1MHz	3MHz	Peak

Configuration: N/A

Comments: N/A

EUT modification(s): N/A

TRANSMITTER RADIATED SPURIOUS EMISSIONS AT FREQUENCIES >30MHZ - GRAPH			
TX MODE / ALL POSITIONS / MID CHANNEL / 18GHZ TO 26.5GHZ			EMI7236
EUT mode:	D-M2		T (°C): 21.6
Test Date:	08/04/2021		H (%): 25.4
Test Operator:	ATO & OAT		P (hPa): 1015

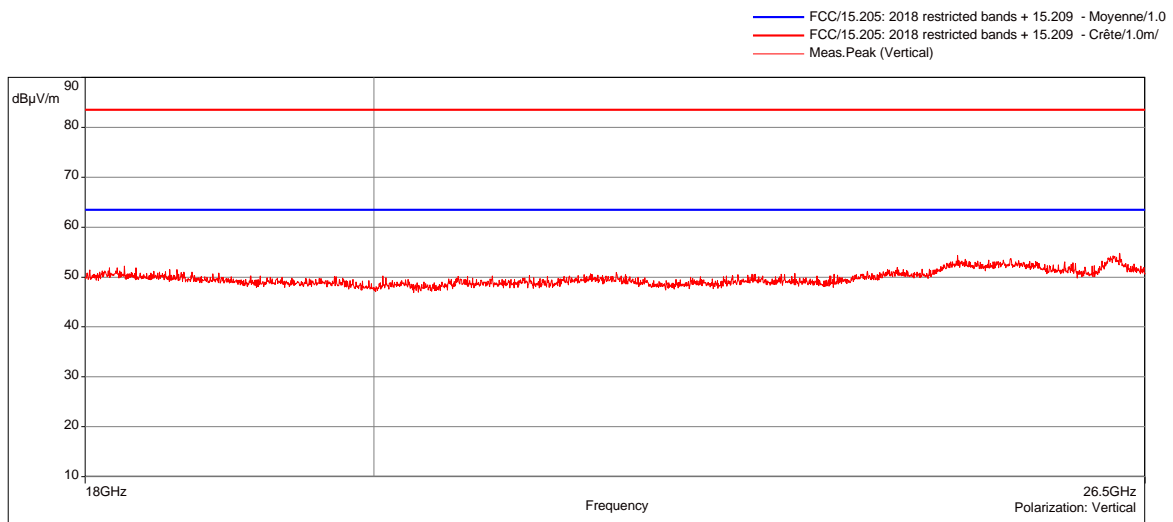

Tx mode / All Positions / Low channel / 18GHz to 26.5GHz - 7236

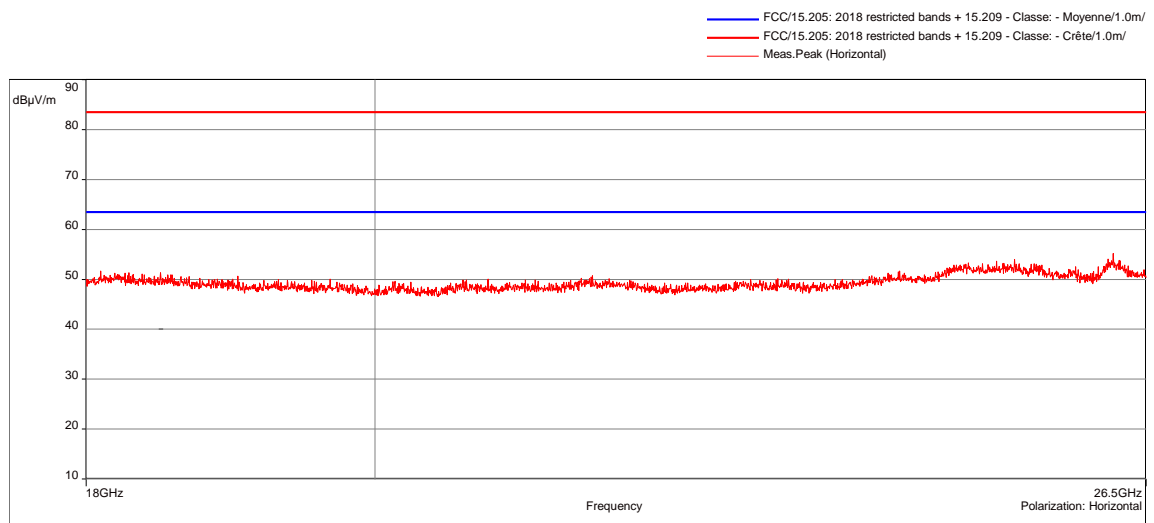

Tx mode / All Positions / Mid channel / 18GHz to 26.5GHz - 7236

POSITION	FREQUENCIES	RBW	VBW	DETECTOR
Vertical	18GHz-26.5GHz	1MHz	3MHz	Peak
Horizontal	18GHz-26.5GHz	1MHz	3MHz	Peak

Configuration: N/A

Comments: N/A

EUT modification(s): N/A

TRANSMITTER RADIATED SPURIOUS EMISSIONS AT FREQUENCIES >30MHZ - GRAPH			
TX MODE / ALL POSITIONS / HIGH CHANNEL / 18GHZ TO 26.5GHZ			EMI7237
EUT mode:	Modulated		T (°C): 21.6
Test Date:	08/04/2021		H (%): 25.4
Test Operator:	ATO & OAT		P (hPa): 1015

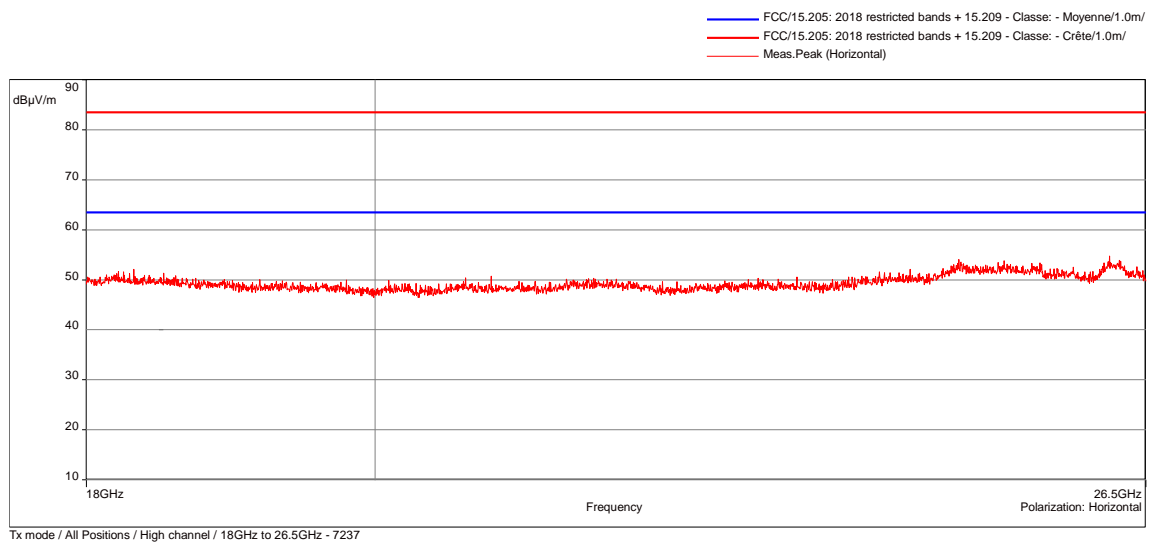
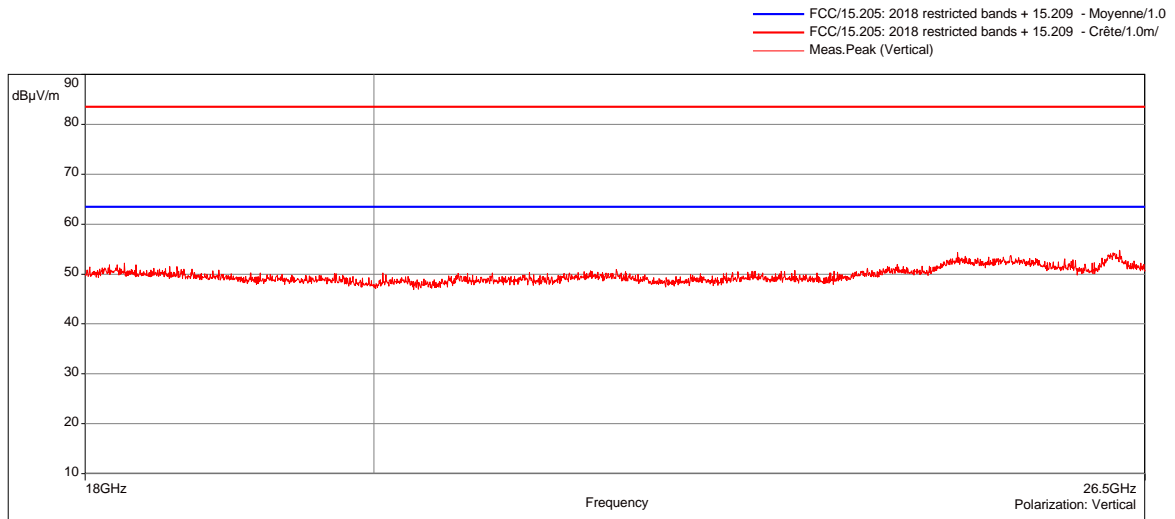

POSITION	FREQUENCIES	RBW	VBW	DETECTOR
Vertical	18GHz-26.5GHz	1MHz	3MHz	Peak
Horizontal	18GHz-26.5GHz	1MHz	3MHz	Peak

Configuration: N/A

Comments: N/A

EUT modification(s): N/A

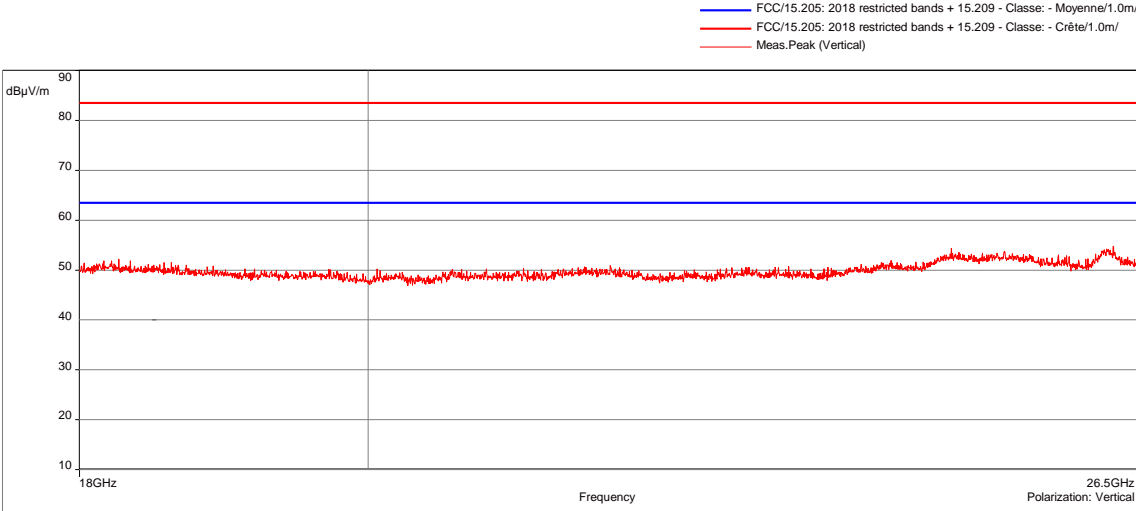
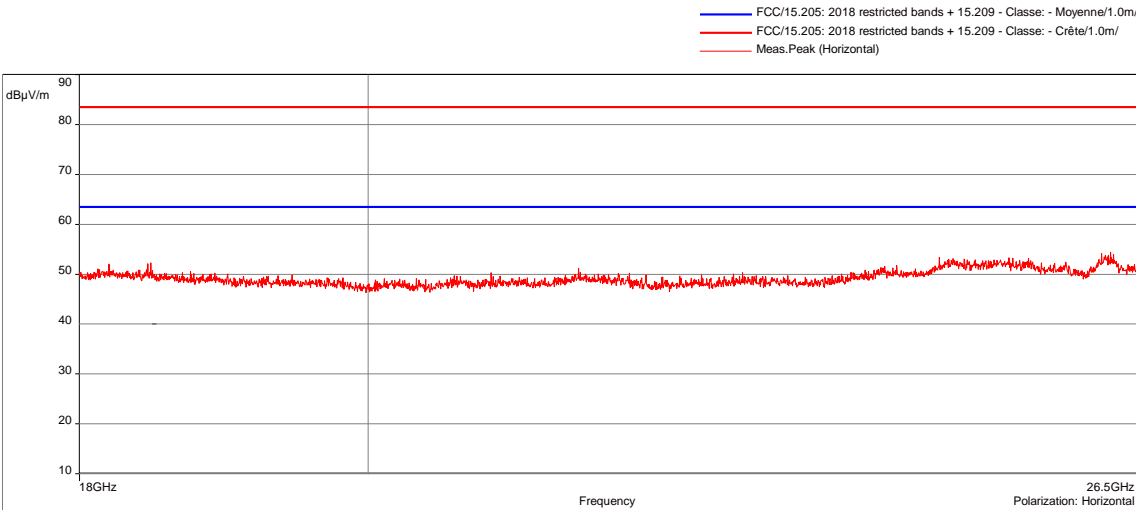
TRANSMITTER RADIATED SPURIOUS EMISSIONS AT FREQUENCIES >30MHZ - GRAPH					
CHARGING + Tx MODE / ALL POSITIONS / LOW CHANNEL / 18GHZ TO 26.5GHZ				EMI7268	
EUT mode:	Modulated			T (°C):	21.6
Test Date:	08/04/2021			H (%):	25.4
Test Operator:	ATO & OAT			P (hPa):	1015
 <p>Charging + Tx mode / All Positions / Low channel / 18GHz to 26.5GHz - 7268</p>					
 <p>Charging + Tx mode / All Positions / Low channel / 18GHz to 26.5GHz - 7268</p>					
POSITION	FREQUENCIES	RBW	VBW	DETECTOR	
Vertical	18GHz-26.5GHz	1MHz	3MHz	Peak	
Horizontal	18GHz-26.5GHz	1MHz	3MHz	Peak	
Configuration:	N/A				
Comments:	N/A				
EUT modification(s): N/A					

TRANSMITTER RADIATED SPURIOUS EMISSIONS AT FREQUENCIES >30MHZ - GRAPH			
CHARGING + Tx MODE / ALL POSITIONS / MID CHANNEL / 18GHZ TO 26.5GHZ			EMI7269
EUT mode:	Modulated		T (°C): 21.6
Test Date:	08/04/2021		H (%): 25.4
Test Operator:	ATO & OAT		P (hPa): 1015

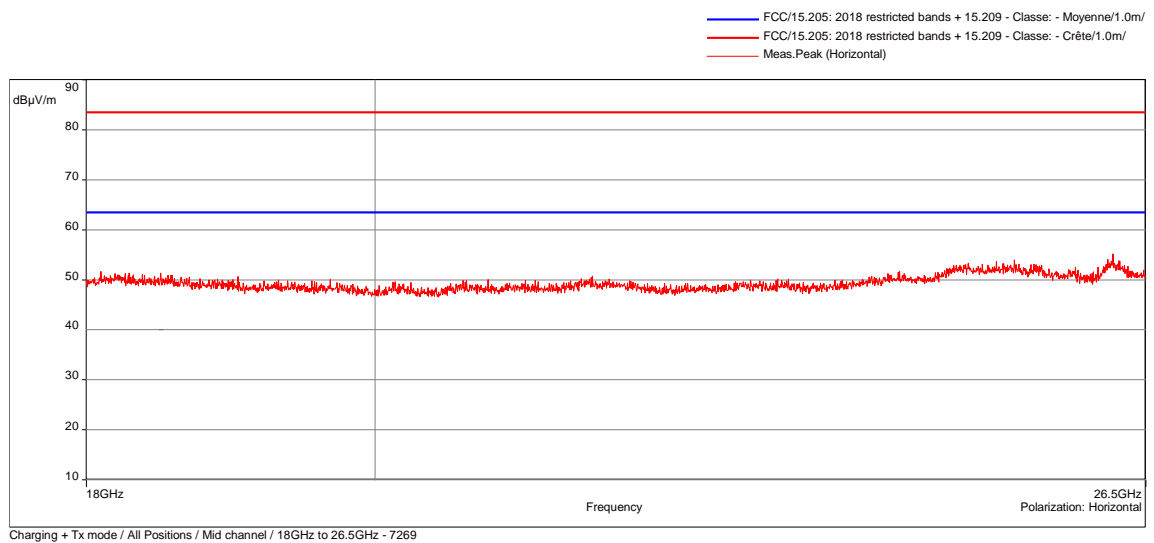
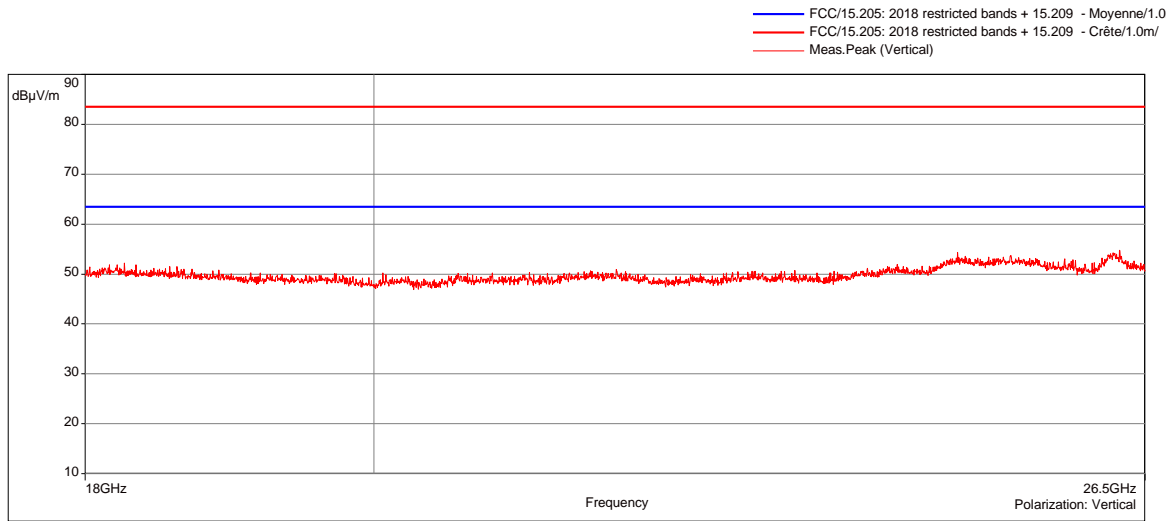

POSITION	FREQUENCIES	RBW	VBW	DETECTOR
Vertical	18GHz-26.5GHz	1MHz	3MHz	Peak
Horizontal	18GHz-26.5GHz	1MHz	3MHz	Peak
Configuration:				
Comments:	N/A			
EUT modification(s): N/A				

TRANSMITTER RADIATED SPURIOUS EMISSIONS AT FREQUENCIES >30MHz - GRAPH			
CHARGING + TX MODE / ALL POSITIONS / HIGH CHANNEL / 18GHz TO 26.5GHz			EMI7270
EUT mode:	Modulated		T (°C): 21.6
Test Date:	08/04/2021		H (%): 25.4
Test Operator:	ATO & OAT		P (hPa): 1015

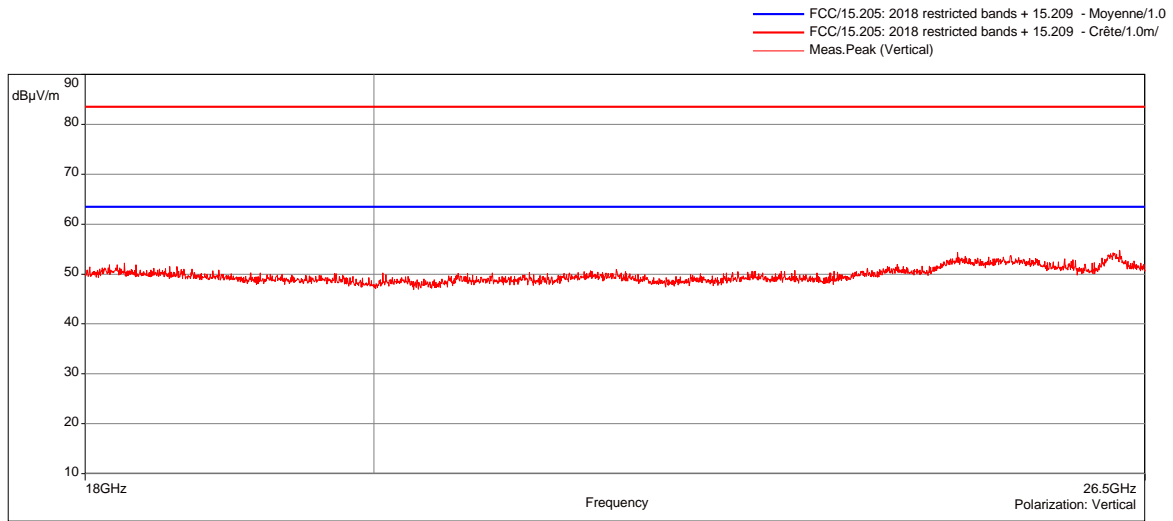

Tx mode / All Positions / Low channel / 18GHz to 26.5GHz - 7270

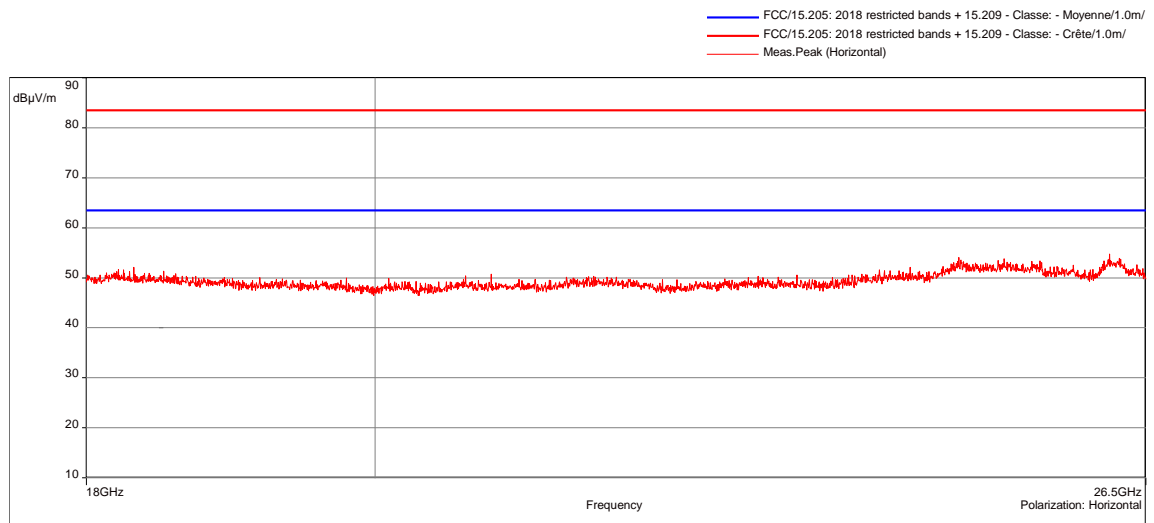

Charging + Tx mode / All Positions / High channel / 18GHz to 26.5GHz - 7270

POSITION	FREQUENCIES	RBW	VBW	DETECTOR
Vertical	18GHz-26.5GHz	1MHz	3MHz	Peak
Horizontal	18GHz-26.5GHz	1MHz	3MHz	Peak

Configuration: N/A

Comments: N/A

EUT modification(s): N/A

8.9. Radiated spurious emissions (receiver)

Reference standard:	FCC part 15 Radio part 15.209 & CNR-Gen
Test method:	FCC part 15.109, 15.209, 15.205, 15.215, CNR-Gen
<p>General test setup: EUT is set on an insulating support at 80cm above the ground reference plane. Measurement are done on a normalized test site by the substitution method.</p> <p>The test antenna is oriented in the two polarizations (vertical and horizontal), and the product is rotated at 360° in the horizontal plane (See photo(s) for initial position of the EUT(0°)). If applicable the test antenna was raised and lowered through the specified range of height until a maximum signal level is detected.</p> <p>For portable equipments a research of maximum level is done on the 3 axes. Only the highest levels are recorded.</p>	

TESTED CONFIGURATION	PARAMETER	SEVERITY	RESULT TAB.	VERDICT
Rx mode / All Positions / All channels/ For freq <1GHz	30MHz-1GHz	15.109	EMI6989	PASS
Charging + Rx mode / All Positions / All channels	30MHz-1GHz	15.109	EMI6988	PASS
Rx mode / All Positions / All channels / 1GHz to 18GHz	1GHz-18GHz	15.109	EMI7021	PASS
Charging + Rx mode / All Positions / All channels / 1GHz to 18GHz	1GHz-18GHz	15.109	EMI7027	PASS
Rx mode / All Positions / All channels / 18GHz to 26.5GHz	18GHz-26.5GHz	15.109	EMI7227	PASS
Charging + Rx mode / All Positions / All channels / 18GHz to 26.5GHz	18GHz-26.5GHz	15.109	EMI7236	PASS

LABORATORY PARAMETERS:	REQUIRED PRIOR TO THE TEST	DURING THE TEST
Ambient Temperature	15 to 35 °C	See Graph(s)
Relative Humidity	20 to 75 %	See Graph(s)
Atmospheric pressure	N/A	See Graph(s)
Test method deviation: N/A		
Supplementary information: N/A		

TEST EQUIPMENT USED					
CATEGORY	BRAND	TYPE	IDENTIFIER	CAL. DATE	CAL. DUE
Antenna	ETS-Lindgren	3117	5456	24/07/2019	24/09/2022
Antenna	ETS lindgren	3160-09	14690	26/09/2017	26/11/2021
Antenna	Electro Metrics	BIA-30HF	0824	13/06/2018	13/08/2021
Antenna	Rohde & Schwarz	HL223	3126	13/06/2018	13/08/2021
Cable	MegaPhase	F135N1N28	16664	25/10/2019	25/12/2021
Cable	MegaPhase	F135N1N28	16666	25/10/2019	25/12/2021
Cable	JYE BAO	K30K30-5003-40G1	14887	25/06/2019	25/08/2021
Cable	Huber + Suhner	K-5m	14460	25/06/2019	25/08/2021
Cable	/	N-1m	3625	27/01/2021	27/03/2023
Cable	SUCOFLEX	N-5,5m	14381	25/06/2019	25/08/2021
Cable	SUCOFLEX	N-6,5m	14380	25/07/2019	25/09/2021
Cable	MegaPhase	N-8m	15813	14/01/2021	14/03/2023
Cable	Huber + Suhner	SF102K	16041	28/02/2019	28/04/2021
Cable	Huber + Suhner	SF102K	16042	24/03/2021	24/05/2023
Cable	MegaPhase	TM18-N1N1-118	12841	14/08/2020	14/10/2022
Cable	MegaPhase	TM18-N1N1-118	12842	02/12/2020	02/02/2023
Preamplifier	Wright Technologie	ASL40-B3015	14851	12/08/2020	12/10/2021
Preamplifier	IMPULSE	CA118-546ACN	9169	13/01/2021	13/03/2022
Receiver	Agilent Technologies	E4440A	5824	22/10/2020	22/12/2022
Receiver	Rohde & Schwarz	ESI	9704	03/03/2020	03/05/2021
Receiver	Rohde & Schwarz	FSW43	14830	29/07/2020	29/09/2021
Shielded enclosure	RAY PROOF	C.V2	1423	04/10/2019	04/12/2022
Shielded enclosure	COMTEST	SAC 3m	14494	02/10/2019	02/12/2022
Software	Nexio		0000		
Thermohygrometer	Testo	608-H1	7562	25/01/2019	25/03/2021
Thermohygrometer	Testo	608-H2	12268	07/05/2020	07/07/2022
Thermohygrometer	Testo	608-H2	12269	07/05/2020	07/07/2022
Thermohygrometer	Bioblock Scientific	Météostar	0963	25/01/2019	25/03/2021
Thermohygrometer	Bioblock Scientific	Météostar	0963	26/01/2019	26/09/2021

BAT-EMC software version: V3.18.0.26

Blank cells = Permanent validity

RADIATED SPURIOUS EMISSIONS (RECEIVER)- TABULATED RESULTS					
CHARGING + RX MODE / ALL POSITIONS / ALL CHANNELS / FOR FREQ <1GHz				EMI6988	
Frequency MHz	Polarization	Level peak dBµV/m	Level Qpeak dBµV/m	Limit dBµV/m	Margin dB
32.55	Vertical	36.97	28.14	40	-11.86
32.69	Vertical	37.33	27.5	40	-12.5
32.82	Vertical	37.71	28.58	40	-11.42
32.92	Vertical	37.97	29.19	40	-10.81
33.11	Vertical	38.22	28.81	40	-11.19
33.42	Vertical	38.98	29.52	40	-10.48
33.55	Vertical	39.75	31.13	40	-8.87
33.94	Vertical	41.64	32.65	40	-7.35
34.03	Vertical	41.39	32.2	40	-7.8
34.15	Vertical	41.77	32.23	40	-7.77
34.40	Vertical	42.75	33.04	40	-6.96
34.59	Vertical	43	33.7	40	-6.3
34.76	Vertical	42.15	33.62	40	-6.38
34.96	Vertical	44.04	35.16	40	-4.84
35.07	Vertical	42.04	33.89	40	-6.11
35.39	Vertical	40.55	33.48	40	-6.52
35.47	Vertical	39.68	33.1	40	-6.9
35.61	Vertical	38.47	32.99	40	-7.01
35.80	Vertical	40.09	33.06	40	-6.94
35.93	Vertical	39.28	33.01	40	-6.99
36.17	Vertical	39.84	33.06	40	-6.94
36.24	Vertical	39.29	33.17	40	-6.83
36.41	Vertical	39.5	33.12	40	-6.88
36.68	Vertical	37.85	32.1	40	-7.9
36.90	Vertical	36.66	30.17	40	-9.83
37.23	Vertical	35.24	28.83	40	-11.17
37.53	Vertical	35.27	28.67	40	-11.33
37.80	Vertical	34.18	27.39	40	-12.61
38.11	Vertical	33.05	25.64	40	-14.36
38.45	Vertical	34.12	25.56	40	-14.44
38.67	Vertical	34.79	26.19	40	-13.81
38.91	Vertical	34.07	26.18	40	-13.82
39.04	Vertical	33.85	25.64	40	-14.36
39.28	Vertical	35.17	26.41	40	-13.59
39.57	Vertical	35.08	27.17	40	-12.83
39.71	Vertical	35.06	27	40	-13
40.07	Vertical	34.82	27.67	40	-12.33
40.35	Vertical	36.25	29.19	40	-10.81
40.73	Vertical	37.95	30.64	40	-9.36
41.00	Vertical	39.14	31.96	40	-8.04
41.20	Vertical	39.46	32.17	40	-7.83
41.39	Vertical	40.57	32.71	40	-7.29
41.53	Vertical	40.35	32.86	40	-7.14
41.63	Vertical	39.77	32.9	40	-7.1

RADIATED SPURIOUS EMISSIONS (RECEIVER)- TABULATED RESULTS					
CHARGING + RX MODE / ALL POSITIONS / ALL CHANNELS / FOR FREQ <1GHZ				EMI6988	
41.75	Vertical	40.02	32.93	40	-7.07
42.09	Vertical	39.21	32.65	40	-7.35
42.50	Vertical	38.14	31.98	40	-8.02
42.85	Vertical	37	31.43	40	-8.57
43.33	Vertical	39	33.33	40	-6.67
43.69	Vertical	38.27	32.97	40	-7.03
44.04	Vertical	39.3	34.43	40	-5.57
44.16	Vertical	39.96	35.05	40	-4.95
44.30	Vertical	40.88	35.76	40	-4.24
44.40	Vertical	41.08	36.25	40	-3.75
44.66	Vertical	41.79	36.86	40	-3.14
44.96	Vertical	43.4	37.58	40	-2.42
45.39	Vertical	41.36	36.77	40	-3.23
45.78	Vertical	39.75	35.25	40	-4.75
45.86	Vertical	39.18	34.77	40	-5.23
46.17	Vertical	38.8	34.38	40	-5.62
46.53	Vertical	38.89	34.43	40	-5.57
46.66	Vertical	38.66	33.92	40	-6.08
46.92	Vertical	38.08	33.21	40	-6.79
47.31	Vertical	36.55	31.63	40	-8.37
152.63	Horizontal	32.49	23.92	43.5	-19.58
152.84	Horizontal	32.1	24.05	43.5	-19.45
152.96	Horizontal	32.99	24.07	43.5	-19.43
153.33	Horizontal	32.14	24.31	43.5	-19.19
153.47	Horizontal	33.67	24.53	43.5	-18.97
153.69	Horizontal	33.14	24.75	43.5	-18.75
153.79	Horizontal	33.59	25.09	43.5	-18.41
153.91	Horizontal	34.25	25.1	43.5	-18.4
153.99	Horizontal	33.13	25.25	43.5	-18.25
154.06	Horizontal	33.33	25.35	43.5	-18.15
154.21	Horizontal	33.24	25.45	43.5	-18.05
154.30	Horizontal	34.48	25.6	43.5	-17.9
154.35	Horizontal	34.07	25.73	43.5	-17.77
154.50	Horizontal	34.58	26.17	43.5	-17.33
154.61	Horizontal	34.72	26.14	43.5	-17.36
154.69	Horizontal	34.7	26.43	43.5	-17.07
154.88	Horizontal	36.1	28.56	43.5	-14.94
154.98	Horizontal	36.82	31.14	43.5	-12.36
155.10	Horizontal	36.99	29.49	43.5	-14.01
155.20	Horizontal	35.86	27.3	43.5	-16.2
155.30	Horizontal	35.39	27.26	43.5	-16.24
155.46	Horizontal	35.43	27.47	43.5	-16.03
155.52	Horizontal	35.51	27.57	43.5	-15.93
155.59	Horizontal	35.8	27.71	43.5	-15.79
155.73	Horizontal	36.29	27.77	43.5	-15.73
155.93	Horizontal	35.99	28.07	43.5	-15.43
156.02	Horizontal	35.51	28.1	43.5	-15.4
156.10	Horizontal	36.3	28.19	43.5	-15.31

RADIATED SPURIOUS EMISSIONS (RECEIVER)- TABULATED RESULTS					
CHARGING + RX MODE / ALL POSITIONS / ALL CHANNELS / FOR FREQ <1GHZ				EMI6988	
156.22	Horizontal	35.67	28.19	43.5	-15.31
156.29	Horizontal	36.26	28.09	43.5	-15.41
156.41	Horizontal	36.31	28.25	43.5	-15.25
156.51	Horizontal	35.9	28.34	43.5	-15.16
156.59	Horizontal	35.49	28.17	43.5	-15.33
156.71	Horizontal	35.34	28.36	43.5	-15.14
156.83	Horizontal	35.44	28.1	43.5	-15.4
156.99	Horizontal	35.63	28	43.5	-15.5
157.16	Horizontal	35.65	27.89	43.5	-15.61
157.29	Horizontal	36.1	27.96	43.5	-15.54
157.41	Horizontal	35.19	28.18	43.5	-15.32
157.53	Horizontal	35.91	27.88	43.5	-15.62
157.68	Horizontal	34.81	27.74	43.5	-15.76
157.85	Horizontal	34.5	27.56	43.5	-15.94
157.90	Horizontal	35.3	27.67	43.5	-15.83
158.02	Horizontal	35.23	27.7	43.5	-15.8
158.09	Horizontal	35.24	27.59	43.5	-15.91
158.24	Horizontal	34.84	27.41	43.5	-16.09
158.40	Horizontal	34.62	27.55	43.5	-15.95
158.52	Horizontal	34.57	27.26	43.5	-16.24
158.65	Horizontal	34.4	27.22	43.5	-16.28
158.84	Horizontal	34.14	27.1	43.5	-16.4
158.91	Horizontal	34.31	27.1	43.5	-16.4
158.97	Horizontal	34.15	26.77	43.5	-16.73
159.06	Horizontal	33.6	26.69	43.5	-16.81
159.16	Horizontal	34.55	26.68	43.5	-16.82
159.31	Horizontal	33.38	26.64	43.5	-16.86
159.42	Horizontal	34.39	26.48	43.5	-17.02
159.50	Horizontal	33.6	26.48	43.5	-17.02
159.67	Horizontal	33.93	26.51	43.5	-16.99
159.82	Horizontal	34.2	26.35	43.5	-17.15
160.06	Horizontal	33.6	26.15	43.5	-17.35
160.15	Horizontal	32.76	26.03	43.5	-17.47
160.28	Horizontal	32.75	25.83	43.5	-17.67
160.40	Horizontal	34.18	25.71	43.5	-17.79
160.54	Horizontal	32.87	25.54	43.5	-17.96
160.91	Horizontal	32.95	25.07	43.5	-18.43
161.46	Horizontal	32.45	24.81	43.5	-18.69
161.71	Horizontal	31.94	24.68	43.5	-18.82

TEST SETUP PHOTO(S) – RX MODE / POSITION 1



TEST SETUP PHOTO(S) – RX MODE – POSITION 2

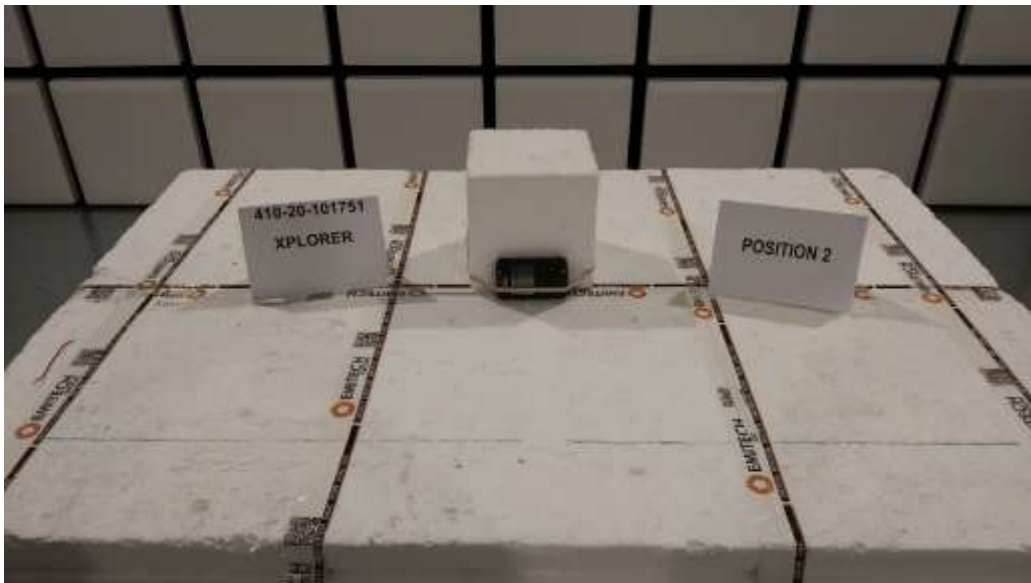

TEST SETUP PHOTO(S) – RX MODE – POSITION 3

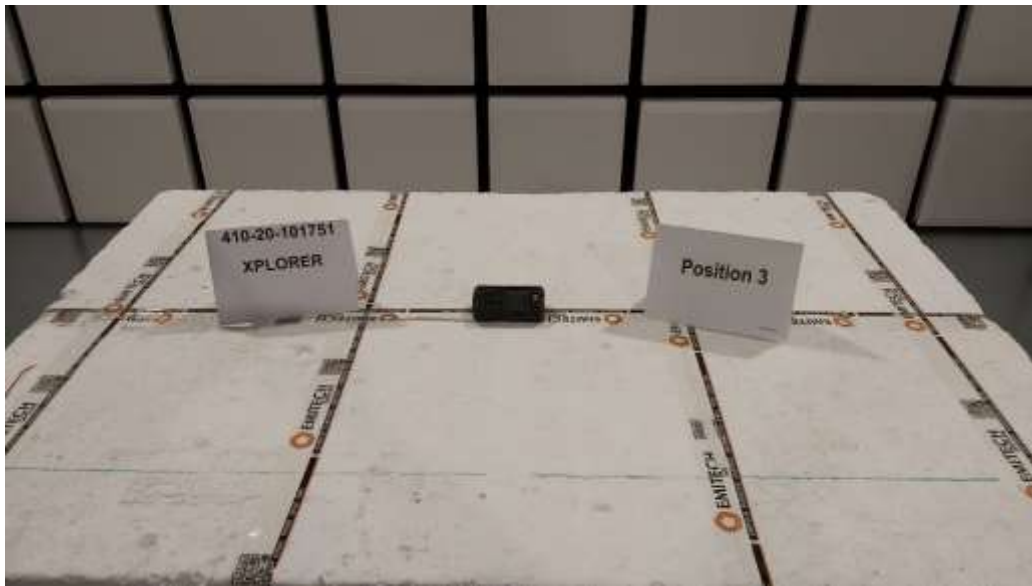

TEST SETUP PHOTO(S) – CHARGING + RX MODE – POSITION 1



TEST SETUP PHOTO(S) - CHARGING + RX MODE – POSITION 2

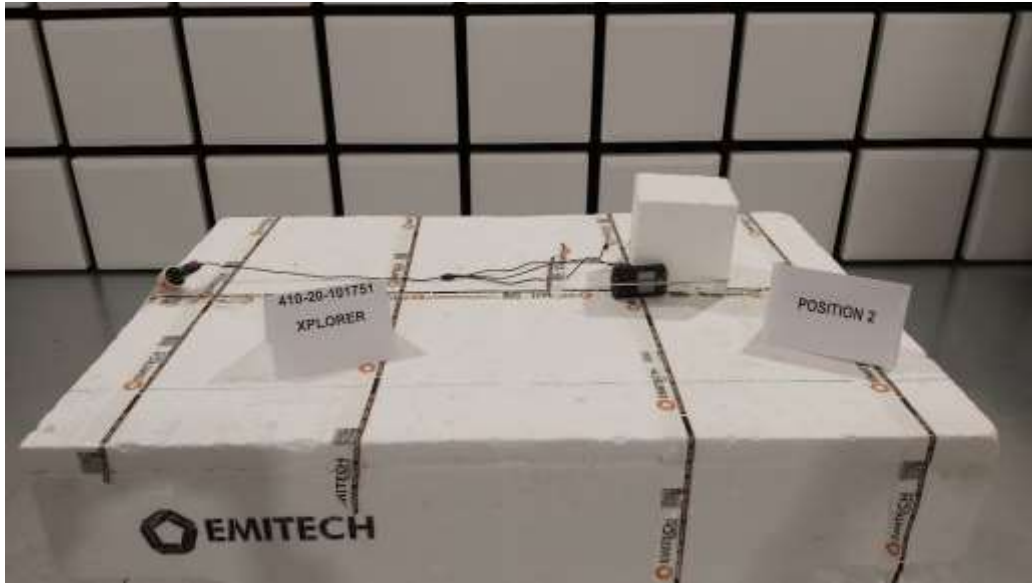

TEST SETUP PHOTO(S) - CHARGING + RX MODE – POSITION 3



TEST SETUP PHOTO(S) – RX MODE – 30MHZ TO 200MHZ



TEST SETUP PHOTO(S) – RX MODE – 200MHZ TO 1GHZ



TEST SETUP PHOTO(S) – RX MODE – 1GHZ TO 18GHZ



TEST SETUP PHOTO(S) - RX MODE / 18GHZ TO 26.5GHZ



TRANSMITTER RADIATED SPURIOUS EMISSIONS AT FREQUENCIES >30MHZ - GRAPH			
RX MODE / ALL POSITIONS / ALL CHANNELS / FOR FREQ <1GHZ			EMI6989
EUT mode:	Rx mode		T (°C): 21.2
Test Date:	19/03/2021		H (%): 23.2
Test Operator:	ATO & OAT		P (hPa): 1011

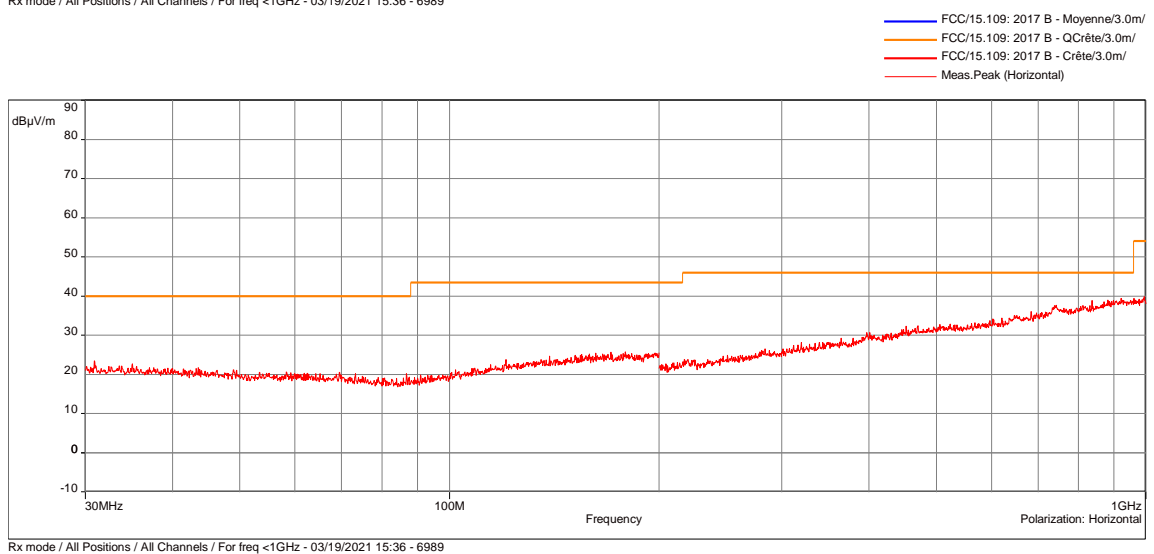
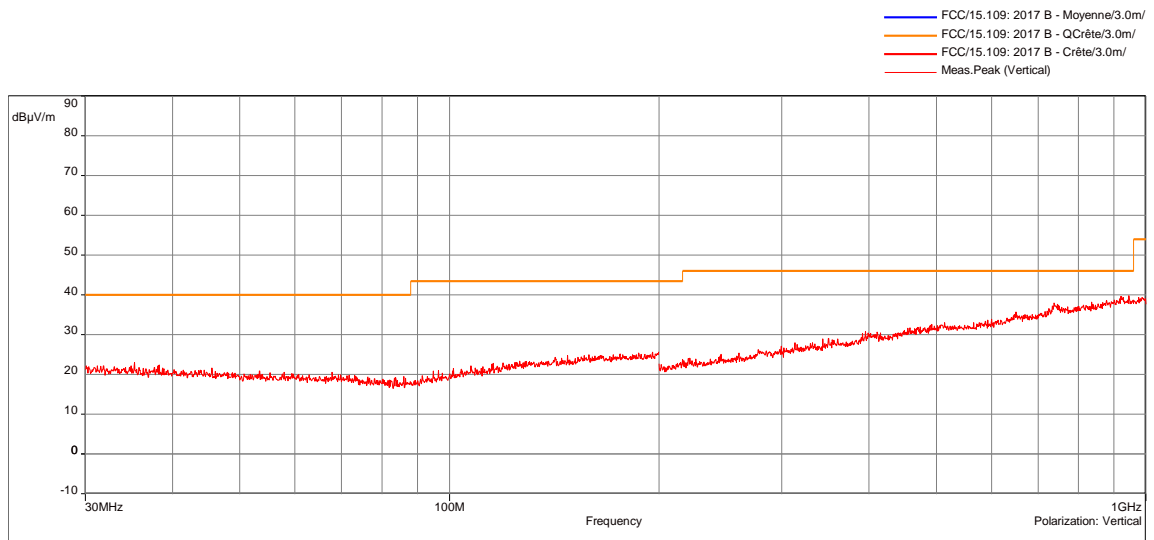

POSITION	FREQUENCIES	RBW	VBW	DETECTOR
Vertical	30MHz-200MHz	100kHz	300kHz	Peak
Horizontal	30MHz-200MHz	100kHz	300kHz	Peak
Vertical	200MHz-1GHz	100kHz	300kHz	Peak
Horizontal	200MHz-1GHz	100kHz	300kHz	Peak
Configuration:	N/A			
Comments:	N/A			
EUT modification(s): N/A				

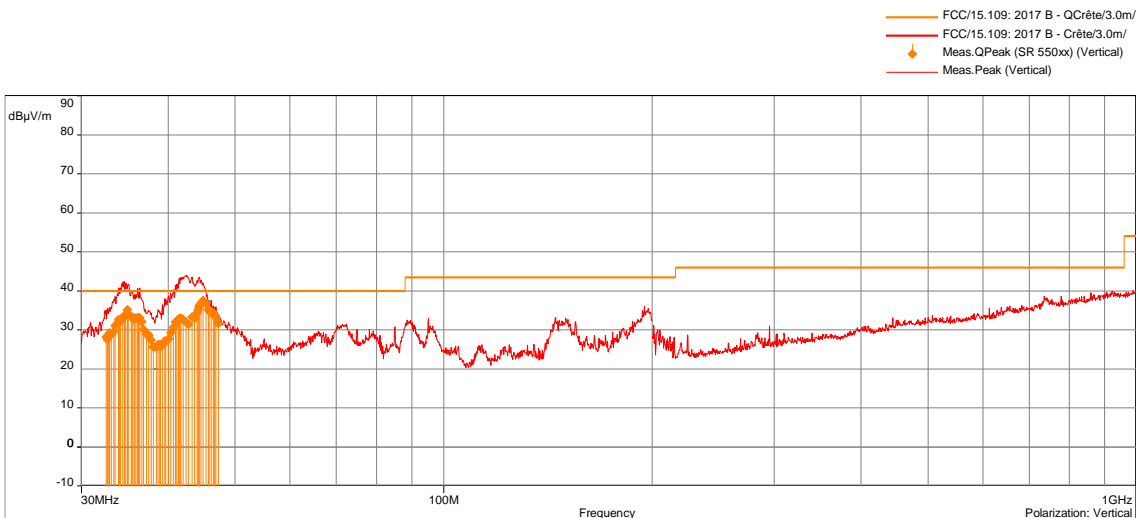
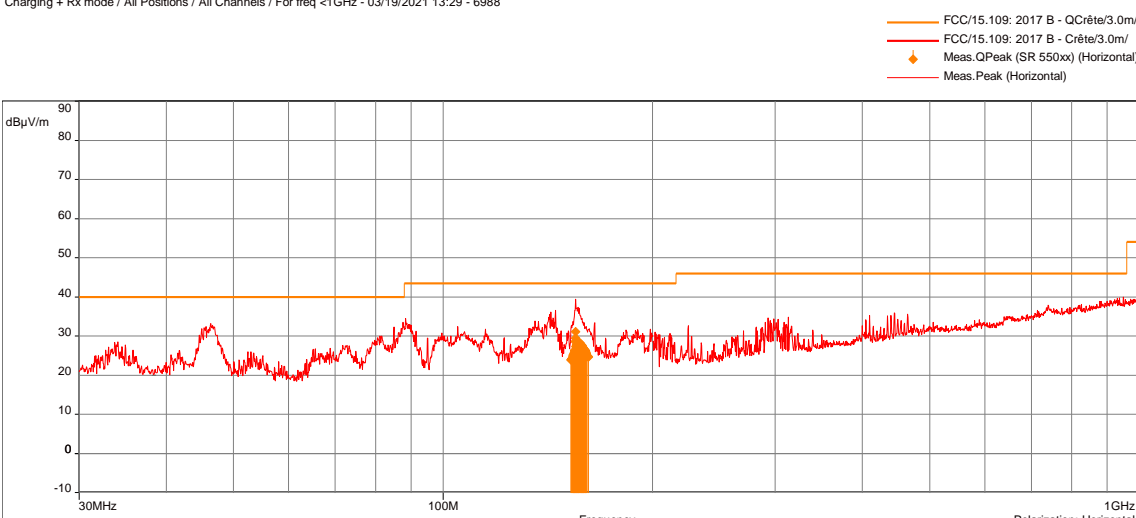
TRANSMITTER RADIATED SPURIOUS EMISSIONS AT FREQUENCIES >30MHz - GRAPH					
CHARGING + RX MODE / ALL POSITIONS / ALL CHANNELS / FOR FREQ <1GHz				EMI6988	
EUT mode:	Rx mode			T (°C):	21.5
Test Date:	19/03/2021			H (%):	20.5
Test Operator:	ATO & OAT			P (hPa):	1014
 <p>Charging + Rx mode / All Positions / All Channels / For freq <1GHz - 03/19/2021 13:29 - 6988</p>					
 <p>Charging + Rx mode / All Positions / All Channels / For freq <1GHz - 03/19/2021 13:29 - 6988</p>					
POSITION	FREQUENCIES	RBW	VBW	DETECTOR	
Vertical	30MHz-200MHz	100kHz	300kHz	Peak	
Horizontal	30MHz-200MHz	100kHz	300kHz	Peak	
Vertical	200MHz-1GHz	100kHz	300kHz	Peak	
Horizontal	200MHz-1GHz	100kHz	300kHz	Peak	
Configuration:	N/A				
Comments:	N/A				
EUT modification(s): N/A					

TRANSMITTER RADIATED SPURIOUS EMISSIONS AT FREQUENCIES >30MHz - GRAPH			
RX MODE / ALL POSITIONS / ALL CHANNELS / 1GHz TO 18GHz			EMI7021
EUT mode:	Rx mode		T (°C): 21.2
Test Date:	22/03/2021		H (%): 23.2
Test Operator:	ATO & OAT		P (hPa): 1011

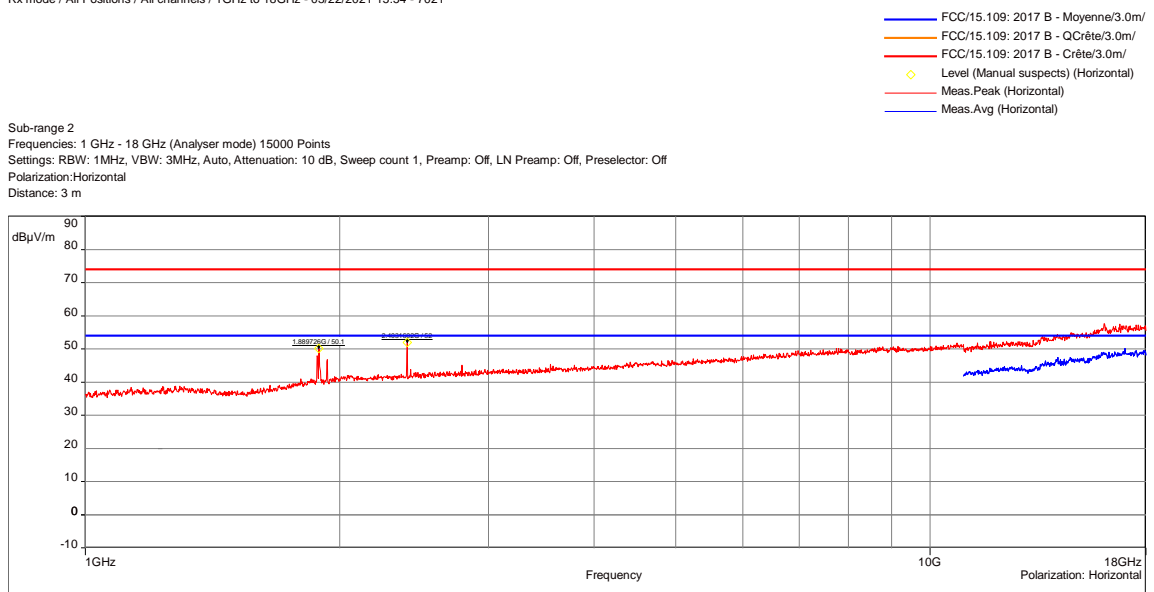
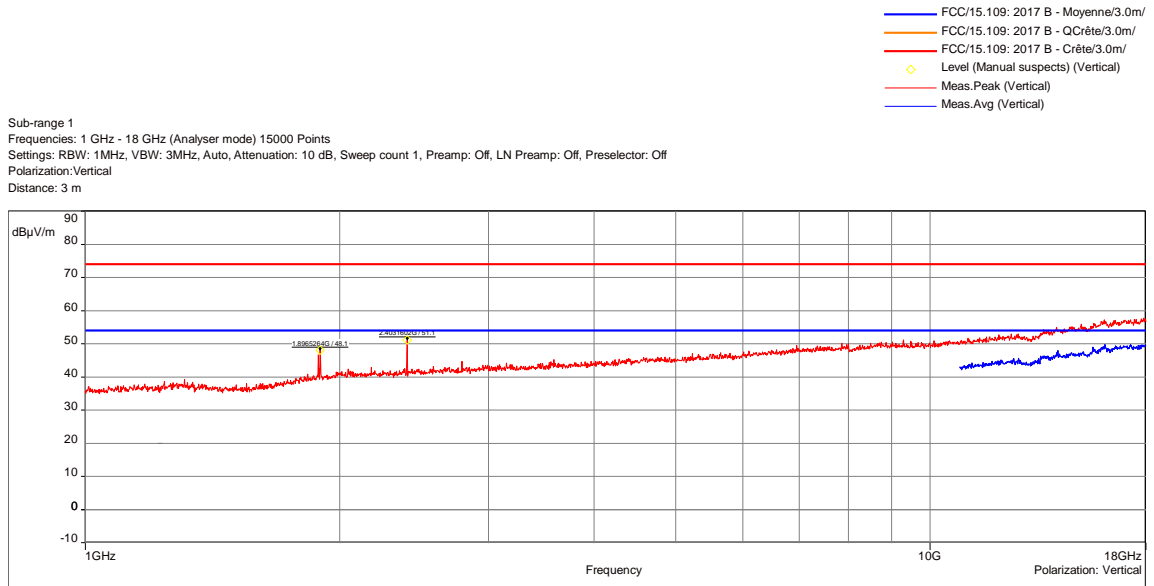

POSITION	FREQUENCIES	RBW	VBW	DETECTOR
Vertical	1GHz-18GHz	1MHz	3MHz	Peak
Horizontal	1GHz-18GHz	1MHz	3MHz	Peak
Configuration:	N/A			
Comments:	N/A			
EUT modification(s): N/A				

TRANSMITTER RADIATED SPURIOUS EMISSIONS AT FREQUENCIES >30MHZ - GRAPH			
CHARGING + RX MODE / ALL POSITIONS / ALL CHANNELS / 1GHZ TO 18GHZ			EMI7027
EUT mode:	Rx mode		T (°C): 20.0
Test Date:	23/03/2021		H (%): 23.5
Test Operator:	ATO & OAT		P (hPa): 1012

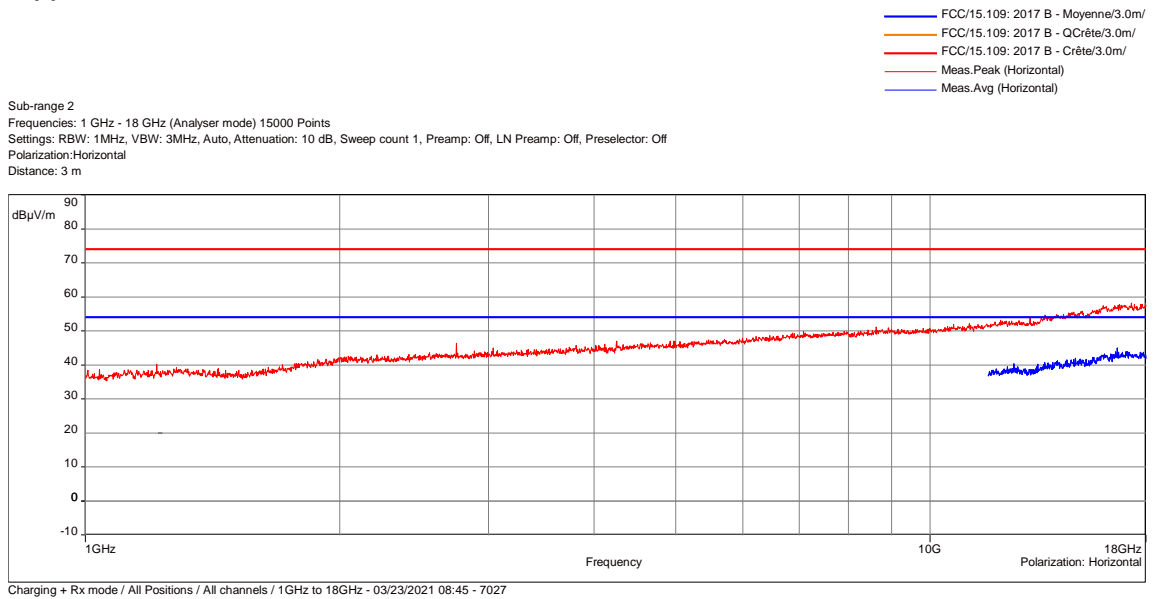
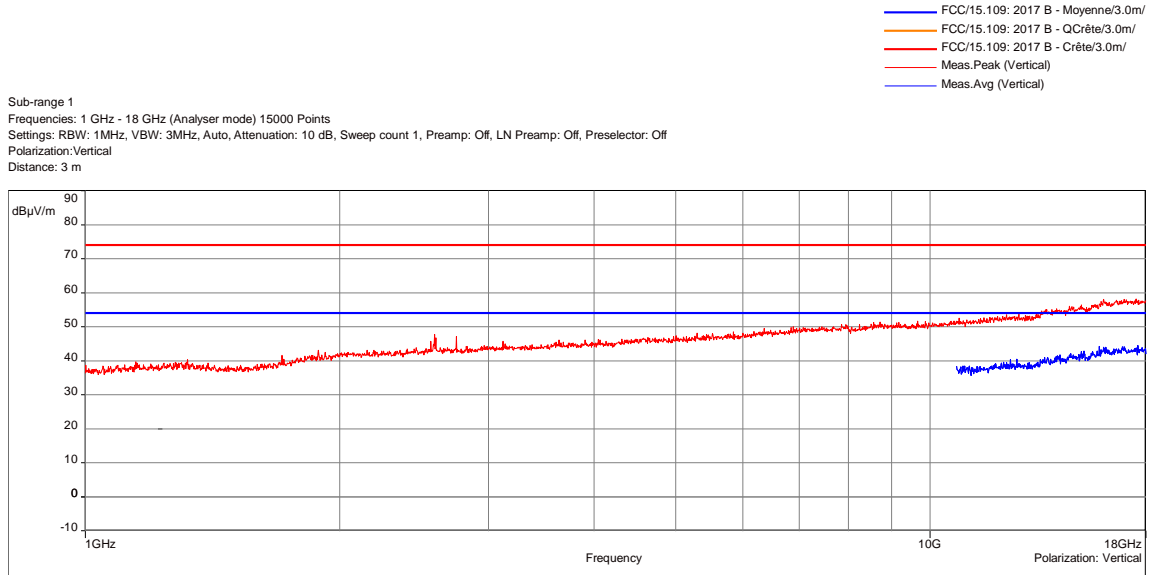

POSITION	FREQUENCIES	RBW	VBW	DETECTOR
Vertical	1GHz-18GHz	1MHz	3MHz	Peak
Horizontal	1GHz-18GHz	1MHz	3MHz	Peak
Configuration:	N/A			
Comments:	N/A			
EUT modification(s): N/A				

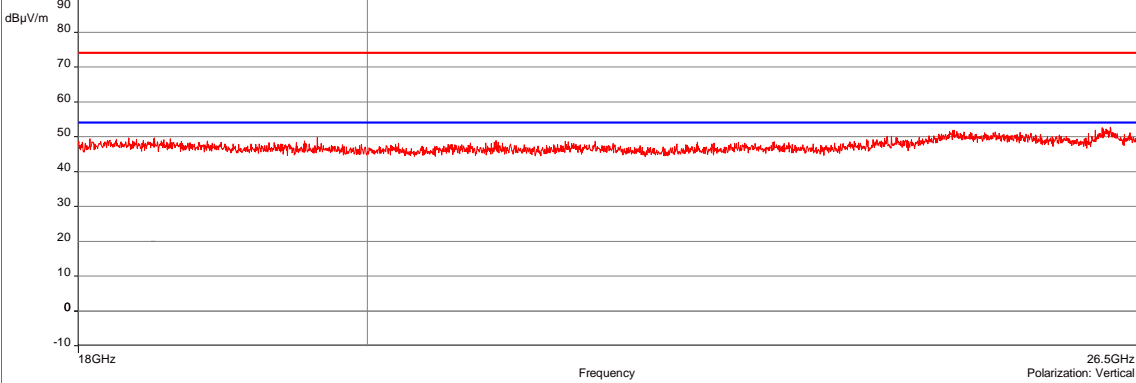
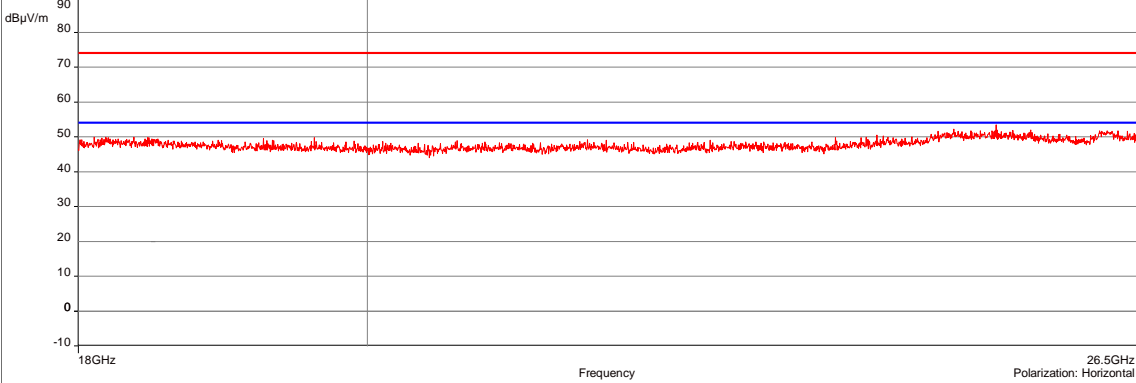
TRANSMITTER RADIATED SPURIOUS EMISSIONS AT FREQUENCIES >30MHZ - GRAPH				
RX MODE / ALL POSITIONS / ALL CHANNELS / 18GHZ TO 26.5GHZ				EMI7292
EUT mode:	Rx mode	T (°C):	21.8	
Test Date:	20/04/2021	H (%):	31.3	
Test Operator:	ATO & OAT	P (hPa):	1012	
<div style="text-align: right; font-size: small;"> — FCC/15.109: 2017 B - Moyenne/3.0m/ — FCC/15.109: 2017 B - QCrête/3.0m/ — FCC/15.109: 2017 B - Crête/3.0m/ — Meas.Peak (Vertical) </div> <p style="font-size: x-small;">Sub-range 1 Frequencies: 18 GHz - 26.5 GHz (Analyser mode) 15000 Points Settings: RBW: 1MHz, VBW: 3MHz, Auto, Attenuation: 10 dB, Sweep count 1, Preamp: Off, LN Preamp: Off, Preselector: Off Polarization: Vertical Distance: 3 m</p>  <p style="font-size: x-small; text-align: center;">Rx mode / All Positions / All channels / 18GHz to 26.5GHz - 04/20/2021 14:27 - 7292</p> <div style="text-align: right; font-size: small;"> — FCC/15.109: 2017 B - Moyenne/3.0m/ — FCC/15.109: 2017 B - QCrête/3.0m/ — FCC/15.109: 2017 B - Crête/3.0m/ — Meas.Peak (Horizontal) </div> <p style="font-size: x-small;">Sub-range 2 Frequencies: 18 GHz - 26.5 GHz (Analyser mode) 15000 Points Settings: RBW: 1MHz, VBW: 3MHz, Auto, Attenuation: 10 dB, Sweep count 1, Preamp: Off, LN Preamp: Off, Preselector: Off Polarization: Horizontal Distance: 3 m</p>  <p style="font-size: x-small; text-align: center;">Rx mode / All Positions / All channels / 18GHz to 26.5GHz - 04/20/2021 14:27 - 7292</p>				
POSITION	FREQUENCIES	RBW	VBW	DETECTOR
Vertical	18GHz-26.5GHz	1MHz	3MHz	Peak
Horizontal	18GHz-26.5GHz	1MHz	3MHz	Peak
Configuration:	N/A			
Comments:	N/A			
<i>EUT modification(s): N/A</i>				

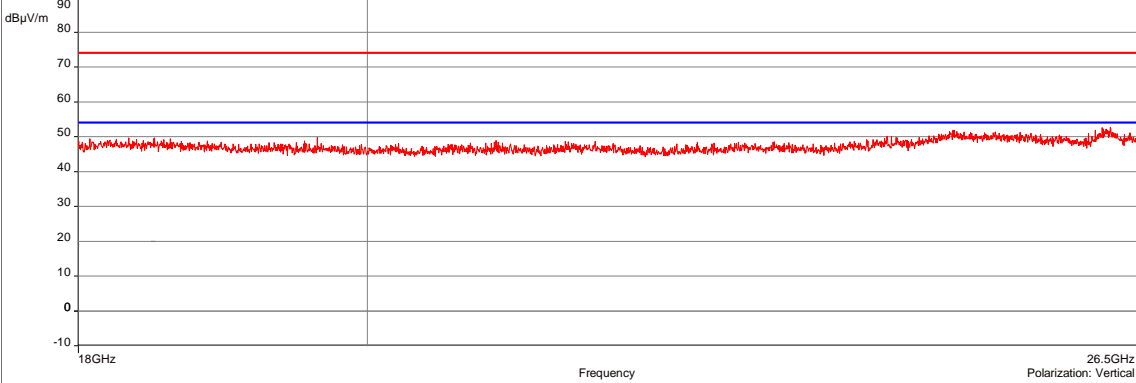
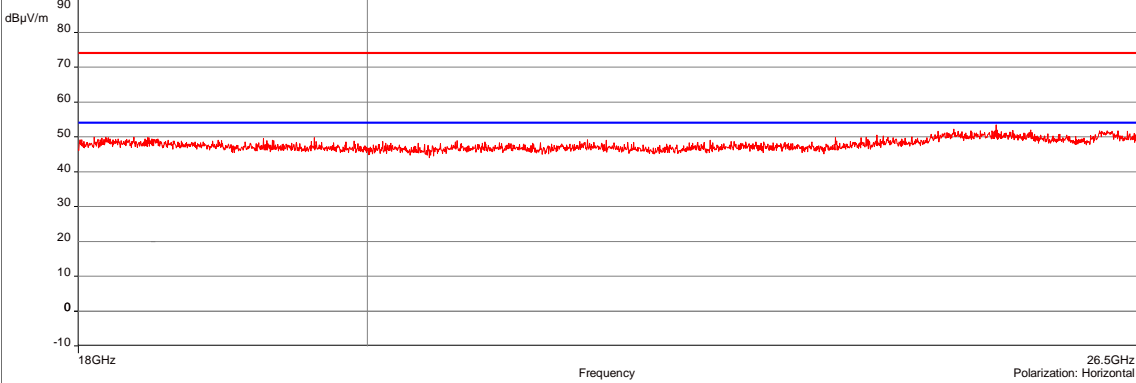
TRANSMITTER RADIATED SPURIOUS EMISSIONS AT FREQUENCIES >30MHZ - GRAPH				
RX MODE / ALL POSITIONS / ALL CHANNELS / 18GHZ TO 26.5GHZ				EMI7292
EUT mode:	Rx mode	T (°C):	21.8	
Test Date:	20/04/2021	H (%):	31.3	
Test Operator:	ATO & OAT	P (hPa):	1012	
<div style="text-align: right; margin-bottom: 5px;"> — FCC/15.109: 2017 B - Moyenne/3.0m/ — FCC/15.109: 2017 B - QCrête/3.0m/ — FCC/15.109: 2017 B - Crête/3.0m/ — Meas.Peak (Vertical) </div> <p>Sub-range 1 Frequencies: 18 GHz - 26.5 GHz (Analyser mode) 15000 Points Settings: RBW: 1MHz, VBW: 3MHz, Auto, Attenuation: 10 dB, Sweep count 1, Preamp: Off, LN Preamp: Off, Preselector: Off Polarization: Vertical Distance: 3 m</p>  <p style="font-size: small; margin-top: 5px;">Rx mode / All Positions / All channels / 18GHz to 26.5GHz - 04/20/2021 14:27 - 7292</p> <div style="text-align: right; margin-top: 5px;"> — FCC/15.109: 2017 B - Moyenne/3.0m/ — FCC/15.109: 2017 B - QCrête/3.0m/ — FCC/15.109: 2017 B - Crête/3.0m/ — Meas.Peak (Horizontal) </div> <p>Sub-range 2 Frequencies: 18 GHz - 26.5 GHz (Analyser mode) 15000 Points Settings: RBW: 1MHz, VBW: 3MHz, Auto, Attenuation: 10 dB, Sweep count 1, Preamp: Off, LN Preamp: Off, Preselector: Off Polarization: Horizontal Distance: 3 m</p>  <p style="font-size: small; margin-top: 5px;">Rx mode / All Positions / All channels / 18GHz to 26.5GHz - 04/20/2021 14:27 - 7292</p>				
POSITION	FREQUENCIES	RBW	VBW	DETECTOR
Vertical	18GHz-26.5GHz	1MHz	3MHz	Peak
Horizontal	18GHz-26.5GHz	1MHz	3MHz	Peak
Configuration:	N/A			
Comments:	N/A			
<i>EUT modification(s): N/A</i>				

8.10. Frequency error

Reference standard:	FCC part 15 Radio part 15.215 and RSS Gen
Test method:	FCC part 15 Radio part 15.215 and RSS Gen
<p>Test description: Frequency error is the difference between the measured unmodulated carrier frequency under extreme conditions and the nominal Centre Frequency as stated by the manufacturer. This measurement procedure only applies if the EUT can generate an unmodulated carrier.</p> <p>EUT is set inside the climatic enclosure. It is connected to the measuring receiver via 50Ω attenuator(s). RBW=200Hz</p>	

TEST CASE	EUT MODE	SEVERITY	RESULT TAB.	VERDICT
Low channel / 25°C/ 3.7Vdc	Continuous Tx	0.001 %	EMI7434	PASS
Low channel / 25°C/ 4.2Vdc	Continuous Tx	0.001 %	EMI7435	PASS
Low channel / 25°C/ 3.45Vdc	Continuous Tx	0.001 %	EMI7436	PASS
Mid channel / 25°C/ 3.7Vdc	Continuous Tx	0.001 %	EMI7437	PASS
Mid channel / 25°C/ 4.2Vdc	Continuous Tx	0.001 %	EMI7438	PASS
Mid channel / 25°C/ 3.45Vdc	Continuous Tx	0.001 %	EMI7439	PASS
High channel / 25°C/ 3.7Vdc	Continuous Tx	0.001 %	EMI7440	PASS
High channel / 25°C/ 4.2Vdc	Continuous Tx	0.001 %	EMI7441	PASS
High channel / 25°C/ 3.45Vdc	Continuous Tx	0.001 %	EMI7442	PASS
Low channel / -5°C/ 3.7Vdc	Continuous Tx	0.001 %	EMI7443	PASS
Low channel / -5°C/ 4.2Vdc	Continuous Tx	0.001 %	EMI7444	PASS
Low channel / -5°C/ 3.45Vdc	Continuous Tx	0.001 %	EMI7445	PASS
Mid channel / -5°C/ 3.7Vdc	Continuous Tx	0.001 %	EMI7446	PASS
Mid channel / -5°C/ 4.2Vdc	Continuous Tx	0.001 %	EMI7447	PASS
Mid channel / -5°C/ 3.45Vdc	Continuous Tx	0.001 %	EMI7448	PASS
High channel / -5°C/ 3.7Vdc	Continuous Tx	0.001 %	EMI7449	PASS
High channel / -5°C/ 4.2Vdc	Continuous Tx	0.001 %	EMI7450	PASS
High channel / -5°C/ 3.45Vdc	Continuous Tx	0.001 %	EMI7451	PASS
Low channel / 40°C/ 3.7Vdc	Continuous Tx	0.001 %	EMI7452	PASS
Low channel / 40°C/ 4.2Vdc	Continuous Tx	0.001 %	EMI7453	PASS
Low channel / 40°C/ 3.45Vdc	Continuous Tx	0.001 %	EMI7454	PASS
Mid channel / 40°C/ 3.7Vdc	Continuous Tx	0.001 %	EMI7455	PASS
Mid channel / 40°C/ 4.2Vdc	Continuous Tx	0.001 %	EMI7456	PASS
Mid channel / 40°C/ 3.45Vdc	Continuous Tx	0.001 %	EMI7457	PASS
High channel / 40°C/ 3.7Vdc	Continuous Tx	0.001 %	EMI7458	PASS
High channel / 40°C/ 4.2Vdc	Continuous Tx	0.001 %	EMI7459	PASS
High channel / 40°C/ 3.45Vdc	Continuous Tx	0.001 %	EMI7460	PASS

LABORATORY PARAMETERS:	REQUIRED PRIOR TO THE TEST	DURING THE TEST
Ambient Temperature	15 to 35 °C	22.1 °C
Relative Humidity	20 to 75 %	39.9 %
Atmospheric pressure	N/A	1014 hPa
Test method deviation: N/A		
Supplementary information: EUT power supply is replaced by a stabilized power supply.		

TEST EQUIPMENT USED					
CATEGORY	BRAND	TYPE	IDENTIFIER	CAL. DATE	CAL. DUE
Attenuator	Radiall	R412710124	17328	22/06/2020	22/08/2023
Attenuator	Radiall	R412710124	17329	22/06/2020	22/08/2023
Cable	N	3m	16421	04/05/2019	04/07/2021
Cable	Huber + Suhner	SF102K	16041	28/02/2019	28/04/2021
Cable	Radiall	SMA-0,5m	16557	30/07/2019	30/09/2021
Climatic enclosure	CLIMATS	EXCAL 7714-HA	14261	19/09/2019	19/11/2020
Multimeter	FLUKE	8808A	12446	29/09/2020	29/11/2021
Power supply	TTI	PL303QMD	8496		
Receiver	Rohde & Schwarz	FPL1003	16027	14/08/2020	14/10/2021
Thermo-Hygro-Baromètre	LUFFT	OPUS 20	14563	11/12/2019	11/02/2021
Thermohygrometer	Testo	608-H2	12268	07/05/2020	07/07/2022
Thermohygrometer	Bioblock Scientific	Météostar	0963	25/01/2019	25/03/2021
Wattmeter	Rohde & Schwarz	HMC 8015	17005	05/03/2020	05/05/2021

Blank cells = Permanent validity

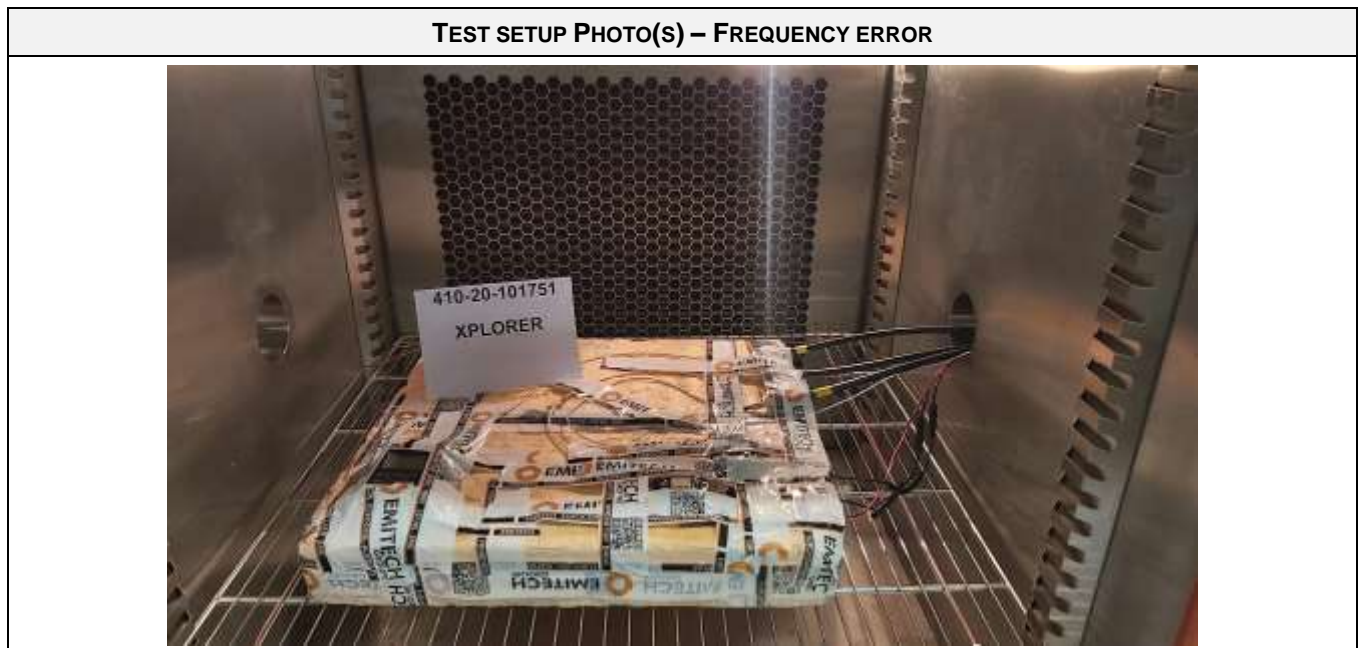

FREQUENCY ERROR - TABULATED RESULTS				
TEST CASE	FREQUENCY	FREQUENCY ERROR	LIMIT	RESULT TAB.
Low channel / 25°C/ 3.7Vdc	2.403960083 GHz	0 %	0.001 %	EMI7434
Low channel / 25°C/ 4.2Vdc	2.403960087 GHz	0.0000010 %	0.001 %	EMI7435
Low channel / 25°C/ 3.45Vdc	2.403960106GHz	0.0000002 %	0.001 %	EMI7436
Mid channel / 25°C/ 3.7Vdc	2.439959392 GHz	0 %	0.001 %	EMI7437
Mid channel / 25°C/ 4.2Vdc	2.439959401GHz	0.0000004%	0.001 %	EMI7438
Mid channel / 25°C/ 3.45Vdc	2.439959402 GHz	0.0000004%	0.001 %	EMI7439
High channel / 25°C/ 3.7Vdc	2.475958808 GHz	0 %	0.001 %	EMI7440
High channel / 25°C/ 4.2Vdc	2.475958799 GHz	0.0000004%	0.001 %	EMI7441
High channel / 25°C/ 3.45Vdc	2.475958815GHz	0.0000003%	0.001 %	EMI7442
Low channel / -5°C/ 3.7Vdc	2.40396401GHz	0.0001634 %	0.001 %	EMI7443
Low channel / -5°C/ 4.2Vdc	2.403964035GHz	0.0001644 %	0.001 %	EMI7444
Low channel / -5°C/ 3.45Vdc	2.40396402GHz	0.0001638 %	0.001 %	EMI7445
Mid channel / -5°C/ 3.7Vdc	2.439963576GHz	0.0001715%	0.001 %	EMI7446
Mid channel / -5°C/ 4.2Vdc	2.439963529GHz	0.0001696%	0.001 %	EMI7447
Mid channel / -5°C/ 3.45Vdc	2.439963515GHz	0.0001690%	0.001 %	EMI7448
High channel / -5°C/ 3.7Vdc	2.475962968GHz	0.0001680%	0.001 %	EMI7449
High channel / -5°C/ 4.2Vdc	2.475962976GHz	0.0001683%	0.001 %	EMI7450
High channel / -5°C/ 3.45Vdc	2.475962986GHz	0.0001687%	0.001 %	EMI7451
Low channel / 40°C/ 3.7Vdc	2.403952789GHz	0.0003034 %	0.001 %	EMI7452
Low channel / 40°C/ 4.2Vdc	2.403952756GHz	0.0003048 %	0.001 %	EMI7453
Low channel / 40°C/ 3.45Vdc	2.403952729GHz	0.0003059 %	0.001 %	EMI7454
Mid channel / 40°C/ 3.7Vdc	2.439952165 GHz	0.0002962%	0.001 %	EMI7455
Mid channel / 40°C/ 4.2Vdc	2.439952177GHz	0.0002957%	0.001 %	EMI7456
Mid channel / 40°C/ 3.45Vdc	2.439952150GHz	0.0002968%	0.001 %	EMI7457
High channel / 40°C/ 3.7Vdc	2.475951668 GHz	0.0002884%	0.001 %	EMI7458
High channel / 40°C/ 4.2Vdc	2.475951321GHz	0.0003024%	0.001 %	EMI7459
High channel / 40°C/ 3.45Vdc	2.475951503GHz	0.0002950%	0.001 %	EMI7460

End of test report