



Test report issued under the responsibility of:
EMITECH MONTPELLIER laboratory
MRA US-EU Designation Number: FR0006
Canadian CAB Identifier: FR0003

RADIO TEST REPORT

FCC 47 CFR PART 15.247
RSS-247_Issue 2, February 2017

Company : **XPLORER**
Address..... : 40 chemin du Moulin
31320 MERVILLA
FRANCE

Test item description : **Wireless metal detection sensor**
Trade Mark : FMF
Manufacturer..... : XPLORER
Model/Type reference..... : XPMF / FMF28
FCC ID..... : XFJMF
IC : 8392A-MF
Ratings..... : 3.45Vdc to 4.2Vdc

Testing Laboratory : **EMITECH MONTPELLIER laboratory**
Address..... : 145 rue de Massacan
34740 VENDARGUES
FRANCE

Report Reference No..... : **RR410-20-101751-12A**
Test procedure : FCC IC Certification
Diffusion..... : Mr LOUBET
Applicant's name : XPLORER
Date of issue..... : November 3, 2021
Total number of pages..... : 117
Revision : 0
Modified page(s)..... : Creation
Compiled by..... : Alexis TOUZET
Approved by (+ signature) : Olivier HEYER (Laboratory Manager)

Duplication of this test report is only permitted for an integral photographic facsimile. It includes the number of pages referenced here above. This document is the result of testing a specimen or a sample of the product submitted. It does not imply an assessment of the conformity of the whole manufactured products of the tested sample.

REPORT INDEX:

1. GENERAL INFORMATIONS	3
2. REFERENCE DOCUMENT(S).....	4
3. EQUIPMENT TECHNICAL DESCRIPTION.....	5
3.1. TEST CONDITIONS	5
3.2. EUT MARKING PLATE	5
3.3. EUT GENERAL VIEW.....	6
3.4. EUT MECHANICAL AND ELECTRICAL DESIGN.....	6
3.5. EUT INPUT/OUTPUT PORTS.....	7
3.6. SUPPORTING EQUIPMENT USED DURING TEST.....	7
3.7. EUT RADIO SPECIFICATIONS.....	9
4. OPINION(S) AND INTERPRETATION(S)	10
5. RESULT SUMMARY	11
6. MEASUREMENT UNCERTAINTY	14
7. RF EXPOSURE	15
8. TEST CONDITIONS AND RESULTS	15
8.1. CONDUCTED EMISSION (MEASUREMENT).....	15
8.2. 6dB BANDWIDTH.....	21
8.3. OCCUPIED BANDWIDTH.....	26
8.4. MAXIMUM EFFECTIVE ISOTROPIC RADIATED POWER	31
8.5. BAND-EDGE COMPLIANCE.....	37
8.6. POWER SPECTRAL DENSITY.....	43
8.7. TRANSMITTER RADIATED SPURIOUS EMISSIONS AT FREQUENCIES <30MHZ.....	52
8.8. TRANSMITTER RADIATED SPURIOUS EMISSIONS AT FREQUENCIES >30MHZ.....	75
8.9. RADIATED SPURIOUS EMISSIONS (RECEIVER).....	99
8.10. FREQUENCY ERROR.....	115

REVISION HISTORY:

Revision	Date	Modified pages	Modifications
0	November 3, 2021	/	Creation

1. GENERAL INFORMATIONS

This document submits the results of Radio tests performed on the equipment **Wireless metal detection sensor Disk FMF 28cm** (denominated hereafter E.U.T.: equipment under test) according to document(s) listed in §2 of this test report.

TESTING PROCEDURE AND TESTING LOCATION:					
Testing Location	EMITECH MONTPELLIER laboratory				
Address	145 rue de Massacan 34740 VENDARGUES FRANCE				
Test procedure	FCC IC Certification				
Tested by	Olivier AELBRECHT & Alexis TOUZET				
Test supervisor	Olivier AELBRECHT				
Date of receipt of test item	N/A				
Date (s) of performance of tests	From February the 15 th of 2021 to April the 30 th of 2021				
APPLICANT'S GENERAL INFORMATIONS:					
Company name	XPLOER				
Company address	40 chemin du Moulin 31320 MERVILLA FRANCE				
Person(s) present during the tests	No representative for company attended the tests.				
Responsible	Mr LOUBET				
GENERAL REMARKS:					
<p>The information in italics is declared by the manufacturer and is under his responsibility</p> <p>The test results presented in this report relate only to the object tested.</p> <p>The results contained in this report reflect the results for this particular model and serial number. It is the responsibility of the manufacturer to ensure that all production models meet the intent of the requirements detailed within this report.</p> <p>"(see Enclosure #)" refers to additional information appended to the report.</p> <p>"(see appended table)" refers to a table appended to the report.</p> <p>Throughout this report the decimal separator is point.</p>					
POSSIBLE TEST CASE VERDICTS:					
Test case does not apply to the test object.:	N/A				
Test case not performed.....	N/P				
Test object does meet the requirement.....	P (Pass)				
Test object does not meet the requirement.	F (Fail)				
DEFINITIONS AND ABBREVIATIONS:					
E.U.T.	Equipment under test	AE	Ancillary equipment	Pk	Peak detector
RBW	Resolution bandwidth	VBW	Video bandwidth	QP	Quasi-peak detector
OATS	Open area test site	FAR	Full anechoic room	Av	Average detector
VP	Vertical Polarization	HP	Horizontal Polarization	RMS	Root Mean Square
RF	Radio frequency	NTR	Nothing to report	N/C	Not communicated

2. REFERENCE DOCUMENT(S)

NORMATIVE REFERENCES:

The following referenced documents are necessary for the application of the present test report.

FCC 47 CFR PART 15: 2017

Code of federal regulations – Title 47 telecommunication
Part 15- Radio frequency devices

FCC part 15.247

Operation within the bands 902–928 MHz, 2400–2483.5 MHz, and 5725–5850MHz. (frequency hopping and digitally modulated)

RSS-247_Issue 2, February 2017

Digital Transmission Systems (DTSs), Frequency Hopping Systems (FHSs) and Licence Exempt Local Area Network (LE-LAN) Devices

RSS/CNR-Gen, Issue 5, April 2018, Amd1: 2019, Amd2: 2021

Exigences générales et information relatives à la certification du matériel de radiocommunication

ANSI C 63.10:2013

American National Standard of Procedures for Compliance Testing of Unlicensed Wireless Devices

ANSI C 63.4:2014

American National Standard for Methods of measurement of Radio-Noise from low-voltage Electrical and Electronic Equipment in the Range of 9 kHz to 40 GHz

Although the product standard uses obsolete technical standards, the latest versions of standards achievable by the laboratory will be used for testing.

INFORMATIVE REFERENCES:

The following referenced documents are not necessary for the application of the present test report but they assist the user with regard to a particular subject area.

3. EQUIPMENT TECHNICAL DESCRIPTION

3.1. Test Conditions

Test item description. : Wireless metal detection sensor
 Model/Type reference..... : XPMF / FMF28
 Trade Mark. : FMF
 FCC ID..... : XFJMF
 IC. : 8392A-MF
 Serial number (S/N)..... : 51303E
 Part number (P/N). : Not communicated
 Software version..... : 20210126
 Firmware version. : *Not communicated*
 Type of sample. : Pre-serial
 Function(s)..... : Wireless object detection sensor
 Manufacturer name. : XPLOER
 Address. : 8 rue du Développement - ZI de Vic
 31320 CASTANET-TOLOSAN
 FRANCE

General product information:

N/A

3.2. EUT Marking plate



3.3.EUT General view



3.4.EUT Mechanical and Electrical Design

Power supply.....	: 3.7Vdc
Power supply range.....	: 3.45Vdc to 4.2Vdc
Power type.....	: <i>Battery powered</i>
Power (W).....	: 5
Nominal current (A).....	: 1
Dimensions (L x W x H) (m).....	: 0.28x0.28x0.04
Weight (kg).....	: 0.417
Temperature range (°C).....	: -5°C to +40°C
Ground bounding strap.....	: No

Comments:

N/A

3.5. EUT Input/Output ports

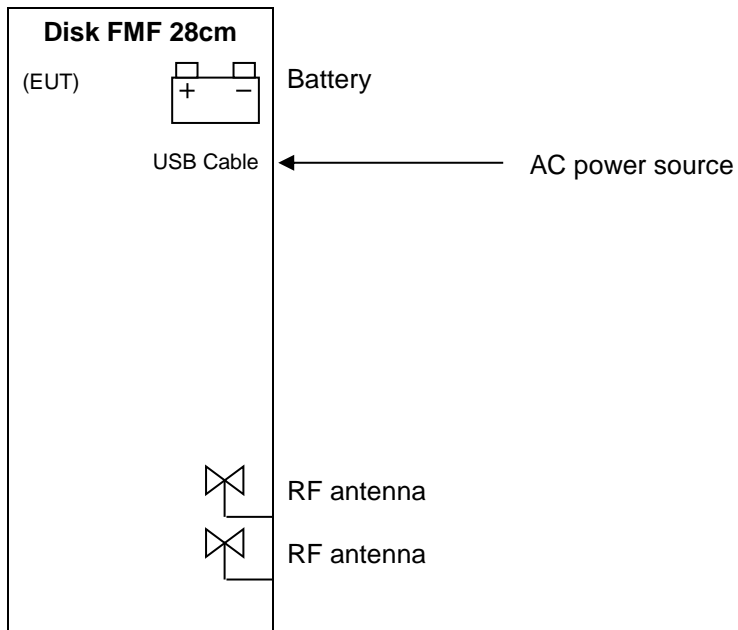

PORT	NAME	TYPE	LENGTH	CABLE TYPE	COMMENTS
0	Main frame	N/E	N/A	Plastic	
1	Battery	DC	N/A	N/A	
2	AC power source	AC/DC	1m	2P	
3	RF antenna	RF	N/A	N/A	2.4GHz
4	RF antenna	RF	N/A	N/A	Metal detector

AC/DC : AC/DC Converter port AC.....: Alternative current port DC.....: Discontinuous current port
 I/O: Input or Output port TP: Telecommunication port RF: Radio frequency port
 N/E: Non Electrical port

3.6. Supporting Equipment Used During Test

Sample subject to the tests was tested with following equipment.

PRODUCT TYPE	MANUFACTURER	MODEL	N°EMITECH / COMMENTS
Battery charger (AC/DC)	Sinohero Industrial Ltd.	SJ-0510-E	Used for conducted emission

BATTERY CHARGER (AC/DC) (AE)



3.7. EUT Radio Specifications

a) GENERAL INFORMATIONS	
According to manufacturer's declarations :	
EUT type.....	<i>Transmitter</i>
Technology	<i>SRD (Metal and object detection sensors) SRD 2.4GHz</i>
Environmental profile.....	<i>Data transmissions</i>
Temperature range.....	<i>-5°C to +40°C</i>
Antenna type	<i>Integral</i>
Antenna Gain.....	<i>Not communicated</i>
Comments:	
<i>N/A</i>	
b) TRANSMITTER PARAMETERS (Tx)	
Frequency bands.....	<i>1kHz to 148.5kHz 2400 MHz to 2483.5MHz</i>
RF Power.....	<i>Not communicated</i>
Number of channels / Separation.....	<i>Multiple</i>
Modulation type	<i>GFSK</i>
Duty cycle	<i>Not communicated</i>
Tested frequency.....	<i>4.1kHz low Channel 45.19kHz High Channel 2404MHz Low channel 2440MHz Mid channel 2476 High channel</i>
c) RECEIVER PARAMETERS (Rx)	
Frequency bands.....	<i>1kHz to 148.5kHz 2400 MHz to 2483.5MHz</i>
Category/Class	<i>N/A Category 2</i>
Bandwidth.....	<i>N/A 2404MHz to 2476MHz</i>

4. OPINION(S) AND INTERPRETATION(S)

TEST(S) PERFORMED	DEVIATION(S) TO TEST METHOD(S)
FCC part 15.247 subclause d) and RSS-247	N/A
FCC part 15.247 and RSS-247	N/A
FCC part 15.109, 15.209, 15.205, 15.215, CNR-Gen	N/A
FCC part 15.109, 15.209, 15.205, 15.215, CNR-Gen	The EUT is encapsulated in a casing. We were not able to measure its voltage supply during radiated tests
FCC part 15.109, 15.209, 15.205, 15.215 RSS-247, CNR Gen	N/A
FCC part 15 Radio part 15.215 and RSS Gen	N/A
ANSI C63.4: 2014	N/A

Comments: N/A

5. RESULT SUMMARY

TEST DESIGNATION	SEVERITY	VERDICT	BASIC STANDARDS / COMMENTS
SUBPART A - GENERAL			
Labeling requirements		PASS	15.19 / See certification documents
Information to user		PASS	15.21 / See certification documents
Home-built devices		N/A	15.23
Kits		N/A	15.25
Special Accessories		PASS	15.27 / See certification documents
Inspection by the Commission		N/A	15.29
Measurement standards		PASS	15.31
Test procedure for CPU boards and computer power supplies		N/A	15.32
Frequency range of radiated measurements		PASS	15.33
Measurement detector functions and bandwidths		PASS	15.35
Transition provisions for compliance with the rules		PASS	15.37 / See certification documents
SUBPART B – UNINTENTIONAL RADIATORS			
Equipment authorization			15.101
- Verification		N/A	
- Declaration of Conformity		N/A	
CPU boards and power supplies used in personal computers		N/A	15.102
Exempted device		N/A	15.103
Information to the user		PASS	15.105 / See certification documents
Conducted limits	Class B	PASS	15.107
Radiated emission limits	Class B	PASS	15.109
Antenna power conduction limits for receivers		N/A	15.111
Power line carrier systems		N/A	15.113
TV interface devices, including cable system terminal devices		N/A	15.115
TV broadcast receivers		N/A	15.117
Cable ready consumer electronics equipment		N/A	15.118
Program blocking technology requirements for TV receivers		N/A	15.120
Scanning receivers and frequency converters used with scanning receivers		N/A	15.121
Labeling of digital cable ready products		N/A	15.123

TEST DESIGNATION	SEVERITY	VERDICT	BASIC STANDARDS / COMMENTS
SUBPART C –INTENTIONAL RADIATORS			
Equipment authorization requirement		PASS	15.201 / Transmitter part is subject to Certification procedure
Certified operating frequency range		N/A	15.202
Antenna requirement		PASS	15.203 / Dedicated and glued antenna
External radio frequency power amplifiers and antenna modifications		N/A	15.204
Restricted bands of operation		PASS	15.204
Conducted limits	Class B	PASS	15.207
Radiated emission limits; general requirements	Class B	PASS	15.209
Tunnel radio systems		N/A	15.211
Modular transmitters		N/A	15.212
Cable locating equipment		N/A	15.213
Cordless telephones		N/A	15.214
Additional provisions to the general radiated emission limits		PASS	15.215
Operation within the band 902-928MHz, 2400-2483.5MHz and 5725-5850MHz			15.247
- Frequency hopping and digitally modulated		-	a)
- Frequency hopping system		N/A	a) (1)
- Digital modulation system		PASS	a) (2)
- Maximum peak conducted output power		-	b)
- For hopping system in the 2400-2483.5 MHz and 5725-5850 MHz bands		N/A	b) (1)
- For hopping system in the 902-928MHz band		N/A	b) (2)
- For system using digital modulation in the 902-928 MHz, 2400-2483.5 MHz and 5725-5850 MHz bands		PASS	b) (3)
- Operation with directional antenna gains > 6 dBi		N/A	c)
- Out-of-band emissions		PASS	d)
- Power spectral density conducted		PASS	e)
- Hybrid system		N/A	f)
- Frequency hopping additional requirements		N/A	g)
- Frequency hopping intelligence		N/A	h)
- RF exposure compliance		PASS	i)

Sample subject to the test complies with the requirements of the reference document(s) listed in §2 of this test report and, where applicable, with deviation(s) specified in this document.

To declare, or not, the compliance with the specifications, it was not explicitly taken account of uncertainty associated with the results.

Opinion(s) and interpretation(s): N/A

TEST(S) PERFORMED	MODIFICATION(S)
FCC part 15.247 subclause d) and RSS-247	N/A
FCC part 15.247 and RSS-247	N/A
FCC part 15.109, 15.209, 15.205, 15.215, CNR-Gen	N/A
FCC part 15.109, 15.209, 15.205, 15.215 RSS-247, CNR Gen	N/A
FCC part 15 Radio part 15.215 and RSS Gen	N/A
ANSI C63.4: 2014	N/A

6. MEASUREMENT UNCERTAINTY

PARAMETER	MAXIMAL EMITECH UNCERTAINTY	MINIMAL STANDARD UNCERTAINTY
Radio frequency	$\pm 1 \times 10^{-7}$	$\pm 1 \times 10^{-7}$
RF power, conducted		
RF power	$\pm 0.8\text{dB}$	$\pm 1 \text{ dB}$
RF power (EN 300328 / EN 301893)	$\pm 1.3\text{dB}$	$\pm 1.5 \text{ dB}$
Power spectral density	$\pm 2.3\text{dB}$	$\pm 3 \text{ dB}$
Occupied bandwidth		
RF power	$\pm 3.8 \%$	$\pm 5 \%$
RF power (EN 300328 / EN 301893)	$\pm 3.8 \%$	$\pm 5 \%$
Maximum frequency deviation		
300 Hz < audio frequency < 6 kHz	$\pm 1.2 \%$	$\pm 5 \%$
6 kHz < audio frequency < 25 kHz	$\pm 1.2 \%$	$\pm 3 \text{ dB}$
Adjacent channel power	$\pm 1.6 \text{ dB}$	$\pm 3 \text{ dB}$
Sensibility of receiver (conducted)	$\pm 2.0 \text{ dB}$	$\pm 3 \text{ dB}$
Blocking	$\pm 4.0 \text{ dB}$	$\pm 4 \text{ dB}$
Transient		
Amplitude	$\pm 8.5 \%$	$\pm 20 \%$
At the frequency	$\pm 166 \text{ Hz}$	$\pm 250 \text{ Hz}$
Conducted emission (spurious)		
$f \leq 1 \text{ GHz}$	$\pm 0.8 \text{ dB}$	
1 GHz - 12.75 GHz	$\pm 1.6 \text{ dB}$	$\pm 3 \text{ dB}$
Radiated emission (PAR / PIRE / RNE)		
$f \leq 62.5 \text{ MHz}$	$\pm 5.1 \text{ dB}$	$\pm 6 \text{ dB}$
62.5 MHz - 1 GHz	$\pm 5.1 \text{ dB}$	$\pm 6 \text{ dB}$
1 GHz - 18 GHz	$\pm 5.2 \text{ dB}$	$\pm 6 \text{ dB}$
18 GHz – 26 GHz	$\pm 5.1 \text{ dB}$	$\pm 6 \text{ dB}$
26 GHz – 40 GHz	$\pm 5.4 \text{ dB}$	$\pm 6 \text{ dB}$
180-1000 MHz / 1 – 12.75 GHz (EN 301 908-1)	$\pm 3.0 / 2.9 \text{ dB}$	$\pm 3 \text{ dB}$
RF power (EN 300328 / EN 301893)	$\pm 5.3 \text{ dB}$	$\pm 6 \text{ dB}$
PIRE and power spectral density with diode	$\pm 5.2 \text{ dB}$	$\pm 6 \text{ dB}$
Radiated emission (magnetic field)		
9kHz – 30MHz	$\pm 3 \text{ dB}$	$\pm 6 \text{ dB}$
RF level for a given BER	$\pm 0.8 \text{ dB}$	$\pm 1.5 \text{ dB}$
Supply voltages	$\pm 3 \%$	$\pm 3 \%$
Temperature	$\pm 1 \text{ }^\circ\text{C}$	$\pm 1^\circ\text{C}$
Humidity	$\pm 5 \%$	$\pm 5 \%$
Time / Duty cycle	$\pm 4.4 \%$	$\pm 5 \%$
Adaptivity	$\pm 2.9 \text{ dB}$	/
Conducted emission (FCC)		
(Artificial Mains Network) 150kHz – 30MHz	$\pm 3.4 \text{ dB}$	$\pm 3.4 \text{ dB}$
Radiated emission (electric field for FCC standard)		
9kHz – 30MHz	$\pm 2.7 \text{ dB}$	/
30MHz – 1GHz	$\pm 5.0 \text{ dB}$	/
1GHz – 18GHz	$\pm 5.6 \text{ dB}$	/
18GHz – 26GHz	$\pm 5.7 \text{ dB}$	/
26GHz – 40GHz	$\pm 5.7 \text{ dB}$	/

For the calculation of expanded uncertainty, the confidence interval is 95 % (k=2).

7. RF EXPOSURE

Maximum EIRP = 2.11dBm (128.825 mW) at 2404MHz

In accordance with KDB 447498 D01 General RF Exposure Guidance v06:

$PSD = EIRP / (4 * \pi * R^2) = 1.78 / (4 * \pi * (20 \text{ cm})^2) = 0.025 \text{ mW/cm}^2$

Limit = 1 mW/cm²

8. TEST CONDITIONS AND RESULTS

8.1. Conducted emission (measurement)

Reference standard:	FCC part 15.107, 15.207 and RSS-Gen
Test method:	ANSI C63.4: 2014
<p>General test setup: EUT is set on an insulating support at 80cm from the ground reference plane. All power was connected to the system through Artificial Mains Network (AMN). The AMN is placed at 80cm from the boundary of the EUT and bonded to a ground reference plane.</p> <p>All tested telecommunications lines (if applicable) were connected to an Asymmetric Artificial Network (AAN) and conducted voltage measurements on telecommunications lines were made at the output of the AAN.</p> <p>Where an AAN was not appropriate or available, measurements were made using a Capacitive Voltage Probe and/or a Current probe.</p> <p>Additional ground terminals (if any) are connected to earth terminal of the AMN.</p>	

TESTED CABLE	PARAMETER	SEVERITY	RESULT TAB.	VERDICT
120Vac/60Hz power supply / All channels	150kHz-30MHz	Class B	EMI5890	PASS
120Vac/60Hz power supply / Standby mode	150kHz-30MHz	Class B	EMI5899	PASS

LABORATORY PARAMETERS:	REQUIRED PRIOR TO THE TEST	DURING THE TEST
Ambient Temperature	15 to 35 °C	See Graph(s)
Relative Humidity	30 to 60 %	See Graph(s)
Atmospheric pressure	N/A	See Graph(s)
Test method deviation: N/A		
Supplementary information: N/A		

TEST EQUIPMENT USED					
CATEGORY	BRAND	TYPE	IDENTIFIER	CAL. DATE	CAL. DUE
AC power source	CHROMA	61603	12532	25/07/2019	25/09/2021
Cable	N	3m	16422	04/05/2019	04/07/2021
Cable	EMITECH	Current absorber sheath	9491	23/06/2020	23/08/2022
Cable	C&C	N-3m	14331	18/03/2021	18/05/2023
Ground plane	EMITECH	Test area	11569		
LISN	PMM	L2-16	1209	08/06/2020	08/08/2022
LISN	AFJ	LT32C\10	12007	11/01/2019	11/03/2021
Multimeter	FLUKE	8808A	12446	29/09/2020	29/11/2021
Receiver	Rohde & Schwarz	ESHS10	3371	27/04/2020	27/06/2021
Receiver	Rohde & Schwarz	FPL1003	16027	14/08/2020	14/10/2021
Software	Nexio		0000		
Surges Suppressor	Hewlett Packard	11947A	0238	20/12/2019	20/02/2023
Thermohygrometer	Testo	608-H1	7562	26/01/2019	26/09/2021
Thermohygrometer	Testo	608-H2	12268	07/05/2020	07/07/2022
Thermohygrometer	Bioblock Scientific	Météostar	0963	26/01/2019	26/09/2021
TV	DESIMET	TVC 2437B	0903		

BAT-EMC software version: V3.18.0.26

Blank cells = Permanent validity

TEST SETUP PHOTO(S) - 120VAC/60HZ POWER SUPPLY / LOW CHANNEL



CONDUCTED EMISSION (MEASUREMENT) - TABULATED RESULTS						
120VAC/60Hz POWER SUPPLY / TX MODE ALL CHANNELS						EMI5889
Terminal	Test Frequency (MHz)	Gain/Loss Factor (dB)	Level Pk (dB μ V)	Level Avg (dB μ V)	Limit Avg (dB μ V)	Margin Lvl Avg - Limit Avg (dB)
Neutral	0.466	10.4	36.95	26.48	46.59	-20.11
Neutral	0.483	10.4	37.84	28.9	46.29	-17.39
Neutral	0.511	10.4	42.53	33.8	46	-12.2
Neutral	0.515	10.4	41.85	32.98	46	-13.02
Neutral	1.699	10.47	34.51	21.9	46	-24.1
Neutral	1.708	10.47	33.5	22.21	46	-23.79
Neutral	1.714	10.47	33.82	22.35	46	-23.65
Neutral	1.725	10.47	32.25	22.48	46	-23.52
Neutral	1.822	10.48	32.53	21.55	46	-24.45
Neutral	1.828	10.48	32.61	22.3	46	-23.7
Neutral	1.840	10.48	34.67	23.45	46	-22.55
Neutral	1.851	10.48	35.2	23.93	46	-22.07
Neutral	1.865	10.48	36.06	23.81	46	-22.19
Neutral	1.887	10.48	35.24	24.02	46	-21.98
Neutral	1.901	10.48	34.74	24.8	46	-21.2
Neutral	1.941	10.48	35.44	27.52	46	-18.48
Neutral	1.959	10.48	37.46	27.68	46	-18.32
Phase	0.445	10.39	40.02	22.95	46.97	-24.02
Phase	0.459	10.4	39.36	22.64	46.72	-24.08
Phase	0.473	10.4	40.01	22.08	46.47	-24.39
Phase	0.497	10.4	44.24	26.56	46.05	-19.49
Phase	0.502	10.4	45.77	28.77	46	-17.23
Phase	0.507	10.4	46.11	29.44	46	-16.56
Phase	0.511	10.4	46.23	29.32	46	-16.68
Phase	0.523	10.4	44.22	27	46	-19
Phase	0.528	10.4	42.62	25.4	46	-20.6
Phase	4.339	10.54	39.07	21.7	46	-24.3
Phase	4.521	10.55	39.64	22	46	-24
Phase	4.700	10.55	39.81	22.5	46	-23.5
Phase	4.880	10.55	38.77	22.36	46	-23.64

CONDUCTED EMISSION (MEASUREMENT) - TABULATED RESULTS						
120VAC/60HZ POWER SUPPLY / STANDBY MODE						EMI5891
Terminal	Test Frequency (MHz)	Gain/Loss Factor (dB)	Level Pk (dB μ V)	Level Avg (dB μ V)	Limit Avg (dB μ V)	Margin Lvl Avg - Limit Avg (dB)
Neutral	0.492	10.4	46.41	32.46	46.14	-13.68
Neutral	0.496	10.4	43.96	34.34	46.06	-11.72
Neutral	0.507	10.4	46.27	36.55	46	-9.45
Neutral	0.515	10.4	45.05	35.57	46	-10.43
Neutral	0.528	10.4	41.95	31.79	46	-14.21
Neutral	1.178	10.45	38.88	27.57	46	-18.43
Neutral	1.221	10.45	38.92	27.07	46	-18.93
Neutral	1.311	10.45	39.09	28.31	46	-17.69
Neutral	1.342	10.46	39.79	27.4	46	-18.6
Neutral	1.690	10.47	39.45	28.6	46	-17.4
Neutral	1.713	10.47	39.68	29.38	46	-16.62
Neutral	1.759	10.47	38.53	30.47	46	-15.53
Neutral	1.809	10.48	42.05	31.92	46	-14.08
Neutral	1.820	10.48	42.53	32.03	46	-13.97
Neutral	1.840	10.48	42.64	31.99	46	-14.01
Neutral	1.859	10.48	42.14	31.64	46	-14.36
Neutral	1.869	10.48	41.17	31.44	46	-14.56
Neutral	1.908	10.48	39.69	31.07	46	-14.93
Neutral	1.927	10.48	40.9	30.57	46	-15.43
Neutral	1.943	10.48	40.96	29.79	46	-16.21
Phase	0.462	10.4	43.5	27.27	46.65	-19.38
Phase	0.465	10.4	44.02	27.27	46.6	-19.33
Phase	0.494	10.4	46.37	28.97	46.1	-17.13
Phase	0.500	10.4	48.53	32.19	46	-13.81
Phase	0.508	10.4	50.22	33.64	46	-12.36
Phase	0.528	10.4	46.17	29.44	46	-16.56
Phase	1.312	10.45	43.68	26.12	46	-19.88
Phase	1.711	10.47	44.32	26.54	46	-19.46
Phase	1.722	10.47	44.18	26.54	46	-19.46
Phase	1.741	10.47	43.14	26.62	46	-19.38
Phase	1.790	10.47	45.48	28.84	46	-17.16
Phase	1.814	10.48	46.86	29.46	46	-16.54
Phase	1.833	10.48	47.44	29.24	46	-16.76
Phase	1.842	10.48	46.68	28.98	46	-17.02
Phase	1.847	10.48	46.95	28.86	46	-17.14
Phase	1.868	10.48	45.34	27.89	46	-18.11
Phase	1.905	10.48	43.89	27.25	46	-18.75
Phase	1.924	10.48	44.91	26.93	46	-19.07

CONDUCTED EMISSION (MEASUREMENT) - GRAPH				
120VAC/60HZ POWER SUPPLY / ALL CHANNELS				EMI5900
EUT mode:	Tx mode	T (°C):	21.5	
Test Date:	16/10/2020	H (%):	37.3	
Test Operator:	OAT	P (hPa):	1009	
<div style="font-size: small;"> — FCC/15.207: 2018 B - Moyenne/ — FCC/15.207: 2018 B - QCrête/ ◆ Meas.Avg (550xx RS) (Phase 1) — Meas.Peak (Phase 1) </div>				
Alimentation AC / 110Vac-60Hz / High Channel - 10/16/2020 15:20 - 5900				
<div style="font-size: small;"> — FCC/15.207: 2018 B - Moyenne/ — FCC/15.207: 2018 B - QCrête/ ◆ Meas.Avg (550xx RS) (Neutral) — Meas.Peak (Neutral) </div>				
Alimentation AC / 110Vac-60Hz / High Channel - 10/16/2020 15:20 - 5900				
POSITION	FREQUENCIES	RBW	VBW	DETECTOR
Neutral	150kHz-1MHz	10kHz	30kHz	Peak; AVG
Neutral	1MHz-10MHz	10kHz	30kHz	Peak; AVG
Neutral	10MHz-30MHz	10kHz	30kHz	Peak
Phase 1	150kHz-1MHz	10kHz	30kHz	Peak; AVG
Phase 1	1MHz-10MHz	10kHz	30kHz	Peak; AVG
Phase 1	10MHz-30MHz	10kHz	30kHz	Peak
Measure with:	A.M.N.			
Comments:	N/A			
EUT modification(s): N/A				

CONDUCTED EMISSION (MEASUREMENT) - GRAPH			
120VAC/60HZ POWER SUPPLY / STANDBY MODE			EMI5899
EUT mode:	Standby mode		T (°C): 21.5
Test Date:	16/10/2020		H (%): 37.3
Test Operator:	ATO		P (hPa): 1009

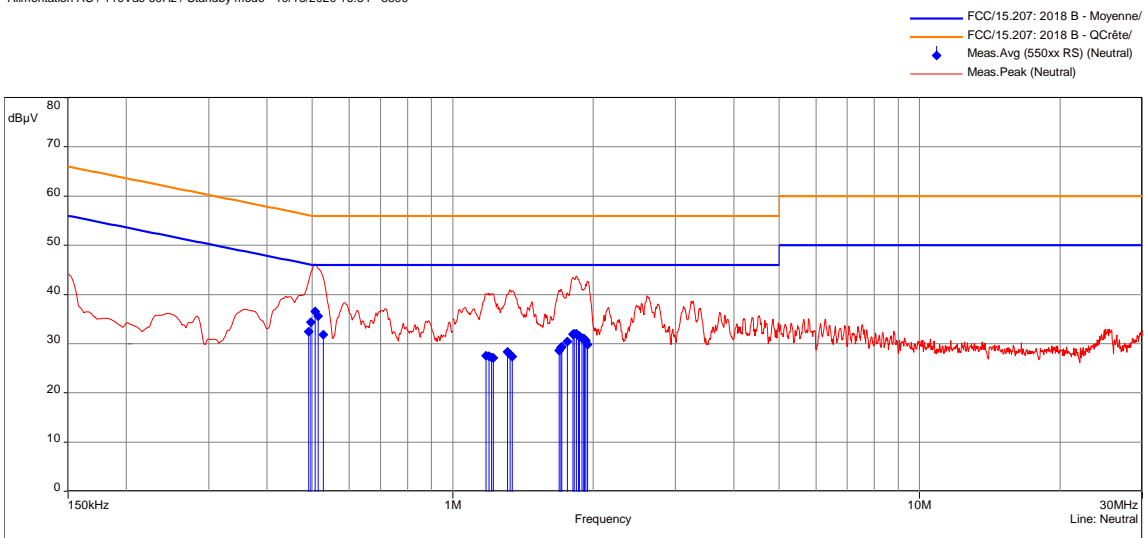
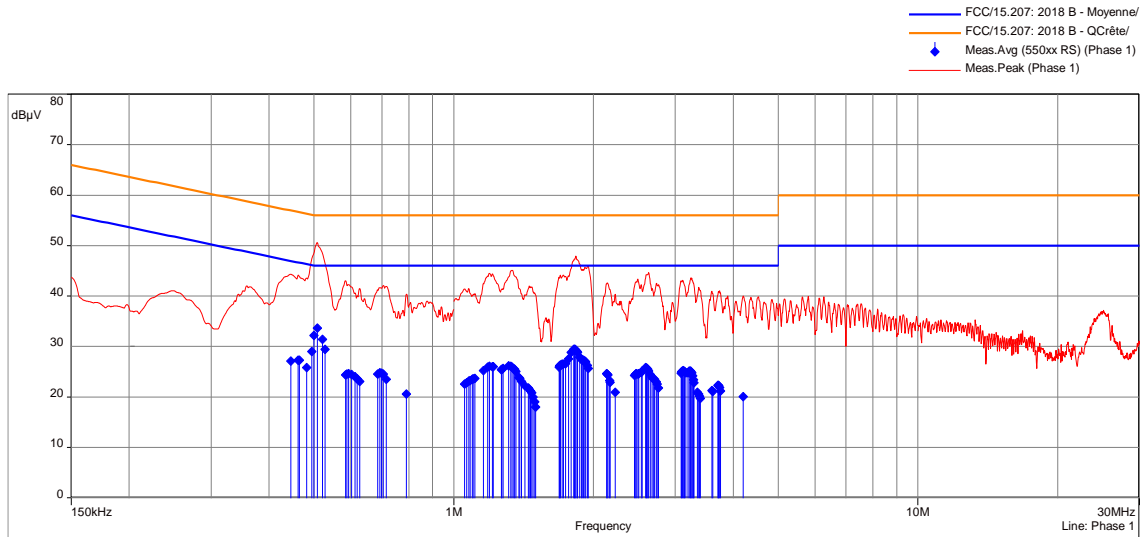

POSITION	FREQUENCIES	RBW	VBW	DETECTOR
Neutral	150kHz-1MHz	10kHz	30kHz	Peak; AVG
Neutral	1MHz-10MHz	10kHz	30kHz	Peak; AVG
Neutral	10MHz-30MHz	10kHz	30kHz	Peak
Phase 1	150kHz-1MHz	10kHz	30kHz	Peak; AVG
Phase 1	1MHz-10MHz	10kHz	30kHz	Peak
Phase 1	10MHz-30MHz	10kHz	30kHz	Peak

Measure with:	A.M.N.
Comments:	N/A
EUT modification(s): N/A	

8.2.6dB bandwidth

Reference standard:	FCC part 15 Radio part 15.247 and RSS-247
Test method:	FCC part 15.247 and RSS-247
Test description: a) (2): Systems using digital modulation techniques may operate in the 902-928 MHz, 2400-2483.5 MHz, and 5725-5850 MHz bands. The minimum 6 dB bandwidth shall be at least 500 kHz. EUT is connected to the measuring receiver via 50Ω attenuator(s). Tests are done in max-hold mode in order to capture all channels.	

TEST CASE AND CONDITIONS	SEVERITY	RESULT TAB.	VERDICT
Low Channel	>500kHz	EMI8055	PASS
Mid Channel	>500kHz	EMI8056	PASS
High Channel	>500kHz	EMI8057	PASS

LABORATORY PARAMETERS:	REQUIRED PRIOR TO THE TEST	DURING THE TEST
Ambient Temperature	15 to 35 °C	22.1 °C
Relative Humidity	20 to 75 %	47.3 %
Atmospheric pressure	N/A	999 hPa
Test method deviation: N/A		
Supplementary information:		

TEST EQUIPMENT USED					
CATEGORY	BRAND	TYPE	IDENTIFIER	CAL. DATE	CAL. DUE
Antenna	ETS-Lindgren	3117	5456	24/07/2019	24/09/2022
Cable	SUCOFLEX	N-3m	14379	25/06/2019	25/08/2021
Cable	SUCOFLEX	N-5,5m	14381	25/06/2019	25/08/2021
Cable	Huber + Suhner	SF102K	16041	28/02/2019	28/04/2021
Receiver	Rohde & Schwarz	FSW43	14830	29/07/2020	29/09/2021
Shielded enclosure	RAY PROOF	C.V2	1423	04/10/2019	04/12/2022
Software	Nexio		0000		
Thermohygrometer	Testo	608-H1	7562	25/01/2019	25/03/2021
Thermohygrometer	Bioblock Scientific	Météostar	0963	26/01/2019	26/09/2021

Blank cells = Permanent validity

TEST SETUP PHOTO(S) – 6dB BANDWIDTH



6dB BANDWIDTH - GRAPH	
LOW CHANNEL	
EMI8055	
EUT mode:	Modulated
Test Date:	21/04/2021
Test Operator:	ATO



17:24:52 21.04.2021

EUT modification(s): N/A

6dB BANDWIDTH - TABULATED RESULTS			
LOW CHANNEL			
Frequency	RBW	6 dB Bandwidth	Limit
2404 MHz	100kHz	570.9 kHz	>500kHz

6dB BANDWIDTH - GRAPH	
MID CHANNEL	
EMI8056	
EUT mode:	Modulated
Test Date:	21/04/2021
Test Operator:	ATO



17:26:42 21.04.2021

EUT modification(s): N/A

6dB BANDWIDTH - TABULATED RESULTS			
MID CHANNEL			
Frequency	RBW	6 dB Bandwith	Limit
2440 MHz	100kHz	581.4 kHz	>500kHz

6dB BANDWIDTH - GRAPH	
HIGH CHANNEL	
EMI8057	
EUT mode:	Modulated
Test Date:	21/04/2021
Test Operator:	ATO
	
EUT modification(s): N/A	

6dB BANDWIDTH - TABULATED RESULTS			
HIGH CHANNEL			
Frequency	RBW	6 dB Bandwith	Limit
2476 MHz	100kHz	535.95 kHz	>500kHz

8.3. Occupied bandwidth

Reference standard:	FCC part 15 Radio part 15.247 and RSS-247
Test method:	FCC part 15.247 and RSS-247
<p>Test description: The occupied bandwidth (OBW) is the Frequency Range in which 99 % of the total mean power of a given emission falls. The residual part of the total power being denoted as β, which, in cases of symmetrical spectra, splits up into $\beta/2$ on each side of the spectrum. Unless otherwise specified, $\beta/2$ is taken as 0,5 %.</p> <p>The maximum occupied bandwidth includes all associated side bands above the appropriate emissions level and the frequency error or drift under extreme test conditions.</p>	

TEST CASE AND CONDITIONS	SEVERITY	RESULT TAB.	VERDICT
Low Channel	>500kHz	EMI8058	PASS
Mid Channel	>500kHz	EMI8059	PASS
High Channel	>500kHz	EMI8060	PASS

LABORATORY PARAMETERS:	REQUIRED PRIOR TO THE TEST	DURING THE TEST
Ambient Temperature	15 to 35 °C	21.8 °C
Relative Humidity	20 to 75 %	42.1 %
Atmospheric pressure	N/A	1005 hPa
Test method deviation: N/A		
Supplementary information:		

TEST EQUIPMENT USED					
CATEGORY	BRAND	TYPE	IDENTIFIER	CAL. DATE	CAL. DUE
Antenna	ETS-Lindgren	3117	5456	24/07/2019	24/09/2022
Cable	SUCOFLEX	N-3m	14379	25/06/2019	25/08/2021
Cable	SUCOFLEX	N-5,5m	14381	25/06/2019	25/08/2021
Cable	Huber + Suhner	SF102K	16041	28/02/2019	28/04/2021
Receiver	Rohde & Schwarz	FSW43	14830	29/07/2020	29/09/2021
Shielded enclosure	RAY PROOF	C.V2	1423	04/10/2019	04/12/2022
Software	Nexio		0000		
Thermohygrometer	Testo	608-H1	7562	25/01/2019	25/03/2021
Thermohygrometer	Bioblock Scientific	Météostar	0963	26/01/2019	26/09/2021

Blank cells = Permanent validity

TEST SETUP PHOTO(S) – 6dB BANDWIDTH

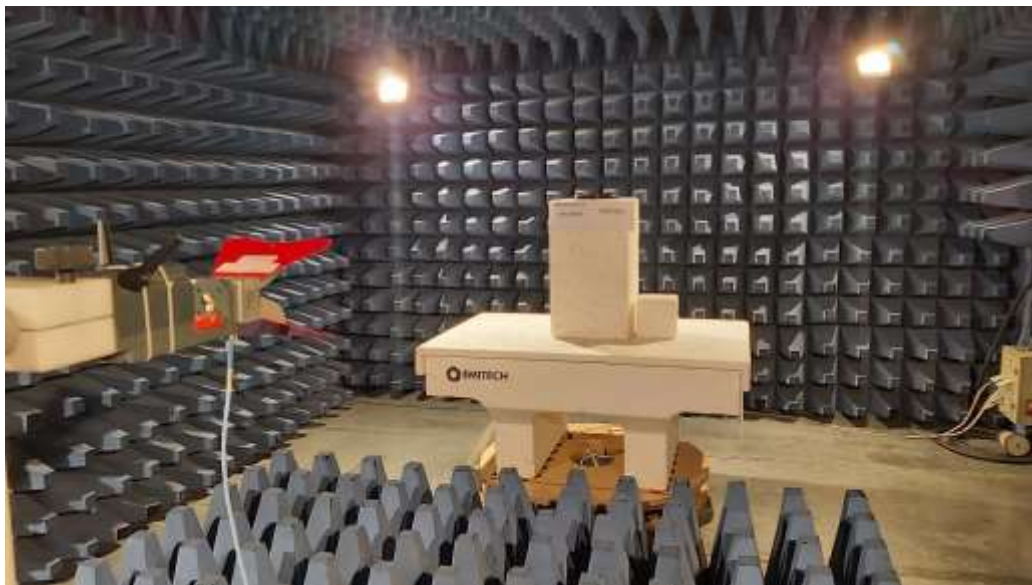

OCCUPIED BANDWIDTH - GRAPH	
LOW CHANNEL	
EMI8058	
EUT mode:	#1
Test Date:	30/04/2021
Test Operator:	ATO



EUT modification(s): N/A

OCCUPIED BANDWIDTH - TABULATED RESULTS			
LOW CHANNEL			
Frequency	RBW	OBW 99%	Limit
2404 MHz	100 kHz	651.91 kHz	> 500kHz

OCCUPIED BANDWIDTH - GRAPH	
MID CHANNEL	
EMI8059	
EUT mode:	#1
Test Date:	30/04/2021
Test Operator:	ATO



11:30:10 30.04.2021

EUT modification(s): N/A

OCCUPIED BANDWIDTH - TABULATED RESULTS			
MID CHANNEL			
Frequency	RBW	OBW 99%	Limit
2440 MHz	100 kHz	674.59 kHz	> 500kHz

OCCUPIED BANDWIDTH - GRAPH

HIGH CHANNEL **EMI8060**

EUT mode:	#1
Test Date:	30/04/2021
Test Operator:	ATO



11:32:15 30.04.2021

EUT modification(s): N/A

OCCUPIED BANDWIDTH - TABULATED RESULTS

HIGH CHANNEL

Frequency	RBW	OBW 99%	Limit
2476 MHz	100 kHz	1192.02 kHz	> 500kHz

8.4. Maximum effective isotropic radiated power

Reference standard:	FCC part 15 Radio part 15.247 and RSS-247
Test method:	FCC part 15.247 and RSS-247
<p>Test description: EUT is set on an insulating support at 150cm above the ground reference plane. Measurement are done on a normalized test site by the substitution method.</p> <p>The test antenna is oriented in the two polarizations (vertical and horizontal), and the product is rotated at 360° in the horizontal plane (See photo(s) for initial position of the EUT(0°)). If applicable the test antenna was raised and lowered through the specified range of height until a maximum signal level is detected.</p> <p>For portable equipments a research of maximum level is done on the 3 axes. Only the highest levels are recorded.</p>	

TESTED CONFIGURATION	PARAMETER	SEVERITY	RESULT TAB.	VERDICT
EIRP / All Positions / Low channel	2.402GHz- 2.406GHz	30dBm	EMI6692	PASS
EIRP / All Positions / Mid channel	2.438GHz- 2.442GHz	30dBm	EMI6693	PASS
EIRP / All Positions / High channel	2.474GHz- 2.478GHz	30dBm	EMI6694	PASS

LABORATORY PARAMETERS:	REQUIRED PRIOR TO THE TEST	DURING THE TEST
Ambient Temperature	15 to 35 °C	See Graph(es)
Relative Humidity	20 to 75 %	See Graph(es)
Atmospheric pressure	N/A	See Graph(es)
Test method deviation: N/A		
Supplementary information: N/A		

TEST EQUIPMENT USED					
CATEGORY	BRAND	TYPE	IDENTIFIER	CAL. DATE	CAL. DUE
Antenna	ETS-Lindgren	3117	5456	24/07/2019	24/09/2022
Attenuator	EMITECH	SUB.V2-H	14495	13/01/2021	13/03/2022
Attenuator	EMITECH	SUB.V2-V	14496	13/01/2021	13/03/2022
Cable	MegaPhase	N-3m	14852	30/10/2018	30/06/2021
Cable	SUCOFLEX	N-5,5m	14381	25/06/2019	25/08/2021
Cable	Huber + Suhner	SF102K	16041	28/02/2019	28/04/2021
Receiver	Rohde & Schwarz	FSW43	14830	29/07/2020	29/09/2021
Shielded enclosure	RAY PROOF	C.V2	1423	04/10/2019	04/12/2022
Software	Nexio		0000		
Thermohygrometer	Testo	608-H1	7562	25/01/2019	25/03/2021
Thermohygrometer	Bioblock Scientific	Météostar	0963	25/01/2019	25/03/2021

Blank cells = Permanent validity

TEST SETUP PHOTO(S) - POSITION 1



TEST SETUP PHOTO(S) - POSITION 2



TEST SETUP PHOTO(S) - POSITION 3



TEST SETUP PHOTO(S) - EIRP

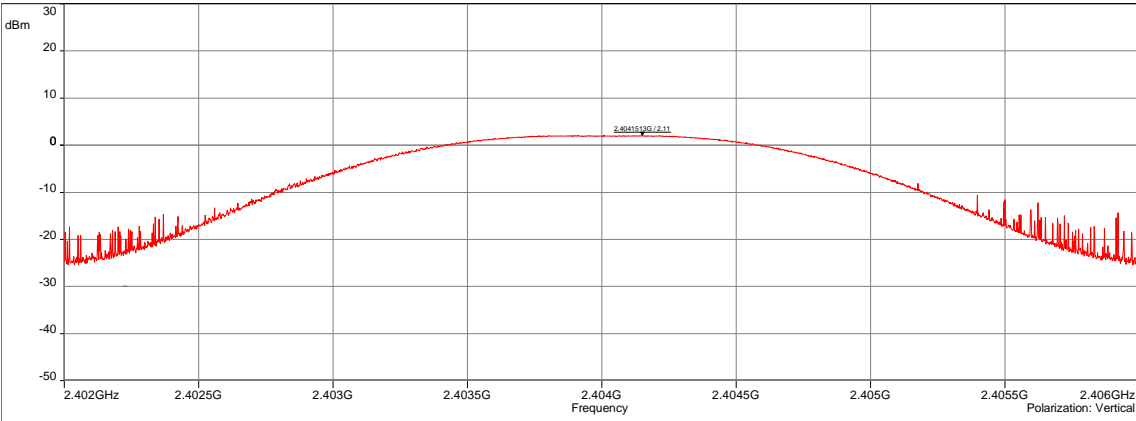
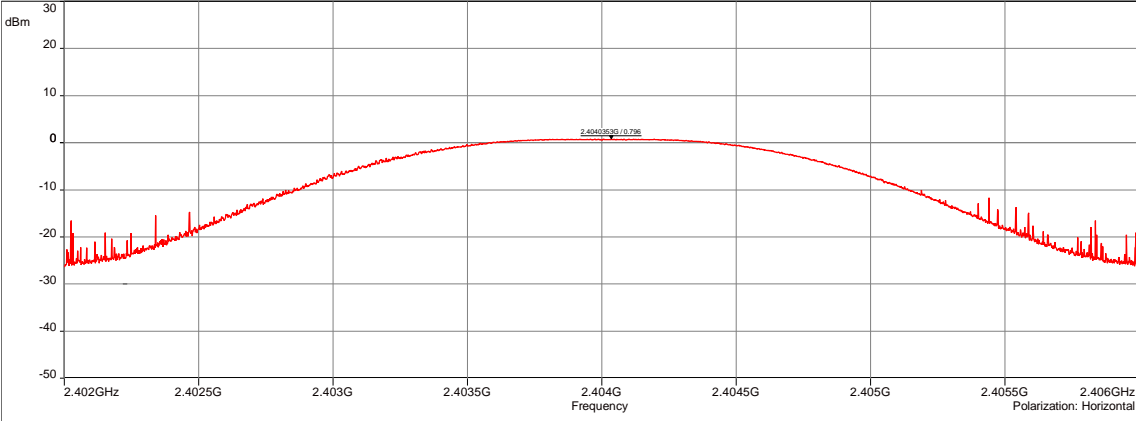

EFFECTIVE ISOTROPIC RADIATED POWER - GRAPH				
EIRP / ALL POSITIONS / LOW CHANNEL			EMI6692	
EUT mode:	Unmodulated		T (°C): 20.9	
Test Date:	03/03/2021		H (%): 34.6	
Test Operator:	ATO & OAT		P (hPa): 1023	
<p>Sub-range 1 Frequencies: 2.402 GHz - 2.406 GHz (Analyser mode) 8000 Points Settings: RBW: 1MHz, VBW: 3MHz, Auto, Attenuation: 10 dB, Sweep count 1, Preamp: Off, LN Preamp: Off, Preselector: Off Polarization: Vertical Distance: 3 m</p>  <p>EIRP / All Positions / Low channel - 03/03/2021 10:48 - 6692</p> <p>Sub-range 2 Frequencies: 2.402 GHz - 2.406 GHz (Analyser mode) 8000 Points Settings: RBW: 1MHz, VBW: 3MHz, Auto, Attenuation: 10 dB, Sweep count 1, Preamp: Off, LN Preamp: Off, Preselector: Off Polarization: Horizontal Distance: 3 m</p>  <p>EIRP / All Positions / Low channel - 03/03/2021 10:48 - 6692</p>				
POSITION	FREQUENCIES	RBW	VBW	DETECTOR
Vertical	2.402GHz-2.406GHz	1MHz	3MHz	Peak
Horizontal	2.402GHz-2.406GHz	1MHz	3MHz	Peak
Configuration:	N/A			
Comments:	N/A			
EUT modification(s): N/A				

EFFECTIVE ISOTROPIC RADIATED POWER - TABULATED RESULTS			
EIRP / ALL POSITIONS / LOW CHANNEL			EMI6692
Frequency (MHz)	Polarization	Level (dBm)	Limit (dBm)
2404.15	Vertical	2.11	30
2404.03	Horizontal	0.796	30

EFFECTIVE ISOTROPIC RADIATED POWER - GRAPH			
EIRP / ALL POSITIONS / MID CHANNEL			EMI6693
EUT mode:	Unmodulated		T (°C): 20.9
Test Date:	03/03/2021		H (%): 34.6
Test Operator:	ATO & OAT		P (hPa): 1023

Sub-range 1
 Frequencies: 2.438 GHz - 2.442 GHz (Analyser mode) 8000 Points
 Settings: RBW: 1MHz, VBW: 3MHz, Auto, Attenuation: 10 dB, Sweep count 1, Preamp: Off, LN Preamp: Off, Preselector: Off
 Polarization: Vertical
 Distance: 3 m

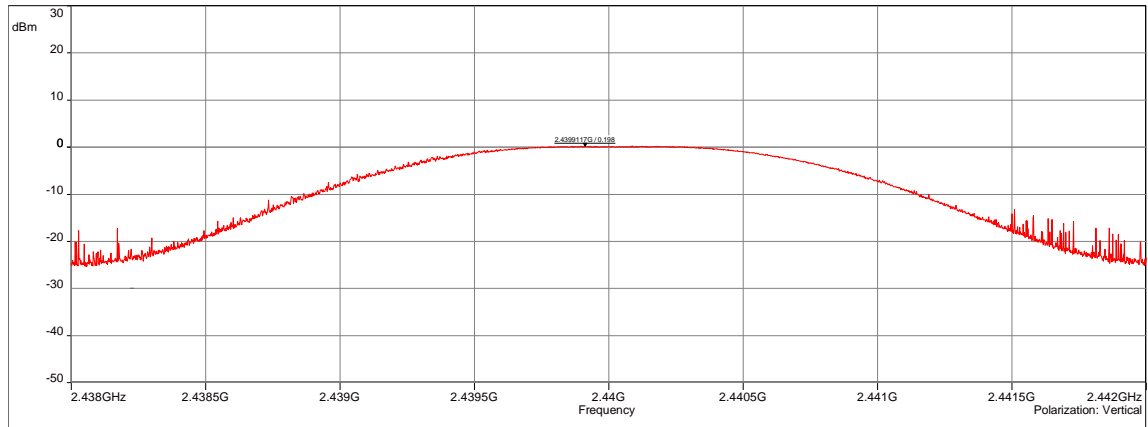

EIRP / All Positions / Mid channel - 03/03/2021 10:58 - 6693

Sub-range 2
 Frequencies: 2.438 GHz - 2.442 GHz (Analyser mode) 8000 Points
 Settings: RBW: 1MHz, VBW: 3MHz, Auto, Attenuation: 10 dB, Sweep count 1, Preamp: Off, LN Preamp: Off, Preselector: Off
 Polarization: Horizontal
 Distance: 3 m

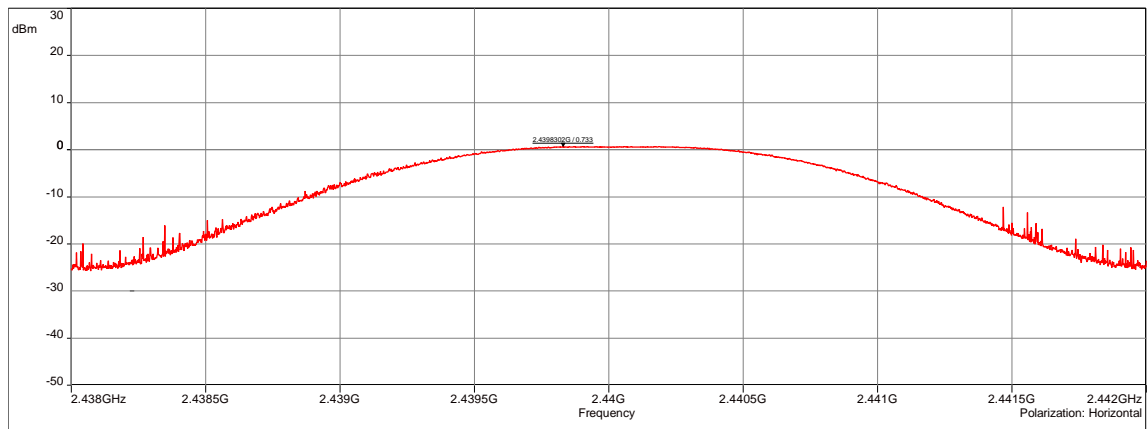

EIRP / All Positions / Mid channel - 03/03/2021 10:58 - 6693

POSITION	FREQUENCIES	RBW	VBW	DETECTOR
Vertical	2.438GHz-2.442GHz	1MHz	3MHz	Peak
Horizontal	2.438GHz-2.442GHz	1MHz	3MHz	Peak
Configuration:	N/A			
Comments:	N/A			
EUT modification(s): N/A				

EFFECTIVE ISOTROPIC RADIATED POWER - TABULATED RESULTS			
EIRP / ALL POSITIONS / MID CHANNEL			EMI6693
Frequency (MHz)	Polarization	Level (dBm)	Limit (dBm)
2439.91	Vertical	0.198	30
2439.83	Horizontal	0.733	30

EFFECTIVE ISOTROPIC RADIATED POWER - GRAPH				
EIRP / ALL POSITIONS / HIGH CHANNEL			EMI6690	
EUT mode:	Unmodulated		T (°C):	20.9
Test Date:	03/03/2021		H (%):	34.6
Test Operator:	ATO & OAT		P (hPa):	1023

Sub-range 1
 Frequencies: 2.474 GHz - 2.478 GHz (Analyser mode) 8000 Points
 Settings: RBW: 1MHz, VBW: 3MHz, Auto, Attenuation: 10 dB, Sweep count 1, Preamp: Off, LN Preamp: Off, Preselector: Off
 Polarization: Vertical
 Distance: 3 m

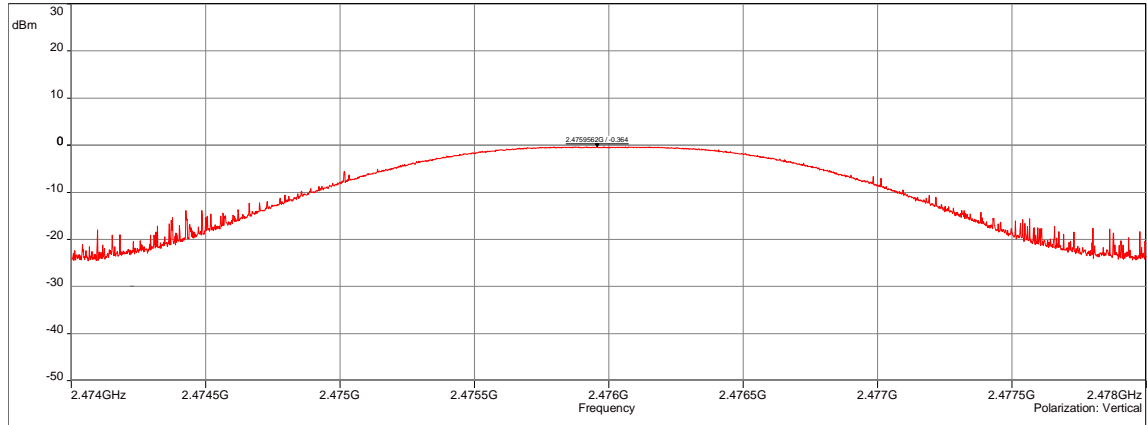

Sub-range 2
 Frequencies: 2.474 GHz - 2.478 GHz (Analyser mode) 8000 Points
 Settings: RBW: 1MHz, VBW: 3MHz, Auto, Attenuation: 10 dB, Sweep count 1, Preamp: Off, LN Preamp: Off, Preselector: Off
 Polarization: Horizontal
 Distance: 3 m

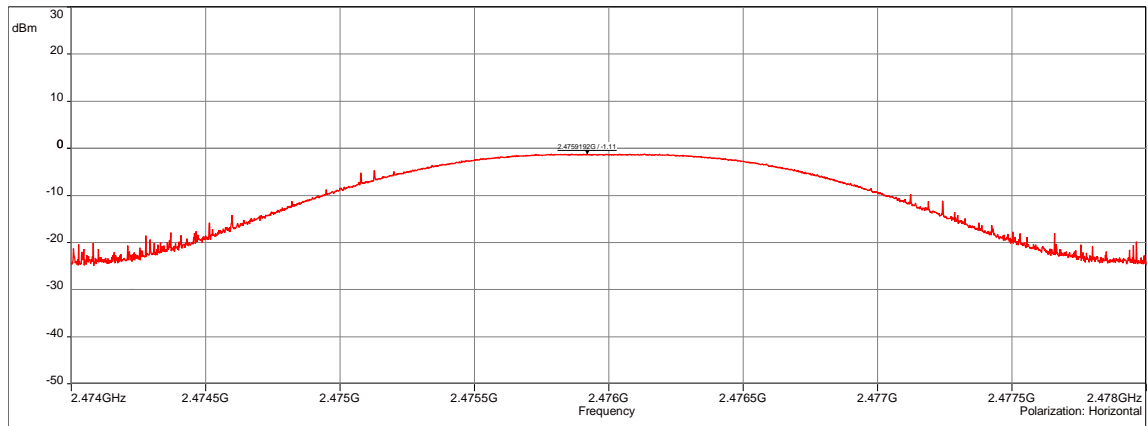

POSITION	FREQUENCIES	RBW	VBW	DETECTOR
Vertical	2.474GHz-2.478GHz	1MHz	3MHz	Peak
Horizontal	2.474GHz-2.478GHz	1MHz	3MHz	Peak

Configuration: N/A

Comments: N/A

EUT modification(s): N/A

EFFECTIVE ISOTROPIC RADIATED POWER - TABULATED RESULTS			
EIRP / ALL POSITIONS / HIGH CHANNEL			EMI6690
Frequency (MHz)	Polarization	Level (dBm)	Limit (dBm)
2475.95	Vertical	-0.364	30
2475.91	Horizontal	-1.11	30

8.5. Band-edge compliance

Reference standard:	FCC part 15 Radio part 15.247 and RSS-247
Test method:	FCC part 15.247 subclause d) and RSS-247
Test description: d) In any 100 kHz bandwidth outside the frequency band in which the intentional radiator is operating, the radio frequency power that is produced by the intentional radiator shall be at least 20 dB below that in the 100 kHz bandwidth within the band that contains the highest level of the desired power, based on either an RF conducted or a radiated measurement, provided the transmitter demonstrates compliance with the peak conducted power limits. If the transmitter complies with the conducted power limits based on the use of RMS averaging over a time interval, the attenuation required under this paragraph shall be 30 dB instead of 20 dB. EUT is connected to the measuring receiver via 50Ω attenuator(s). Only the highest levels are recorded.	

TESTED CONFIGURATION	PARAMETER	SEVERITY	RESULT TAB.	VERDICT
All Positions / Low channel	2.38GHz-2.5GHz	>20dBc	EMI6723	PASS
All Positions / Mid channel	2.38GHz-2.5GHz	>20dBc	EMI6725	PASS
All Positions / High channel	2.38GHz-2.5GHz	>20dBc	EMI6727	PASS

LABORATORY PARAMETERS:	REQUIRED PRIOR TO THE TEST	DURING THE TEST
Ambient Temperature	15 to 35 °C	See Graph(es)
Relative Humidity	20 to 75 %	See Graph(es)
Atmospheric pressure	N/A	See Graph(es)
Test method deviation: N/A		
Supplementary information: N/A		

TEST EQUIPMENT USED					
CATEGORY	BRAND	TYPE	IDENTIFIER	CAL. DATE	CAL. DUE
Antenna	ETS-Lindgren	3117	5456	24/07/2019	24/09/2022
Cable	SUCOFLEX	N-3m	14379	25/06/2019	25/08/2021
Cable	SUCOFLEX	N-5,5m	14381	25/06/2019	25/08/2021
Cable	Huber + Suhner	SF102K	16041	28/02/2019	28/04/2021
Receiver	Rohde & Schwarz	FSW43	14830	29/07/2020	29/09/2021
Shielded enclosure	RAY PROOF	C.V2	1423	04/10/2019	04/12/2022
Software	Nexio		0000		
Thermohygrometer	Testo	608-H1	7562	25/01/2019	25/03/2021
Thermohygrometer	Bioblock Scientific	Météostar	0963	25/01/2019	25/03/2021

BAT-EMC software version: V3.18.0.26

Blank cells = Permanent validity

TEST SETUP PHOTO(S) - BAND EDGE / POSITION 1



TEST SETUP PHOTO(S) - BAND EDGE / POSITION 2



TEST SETUP PHOTO(S) - BAND EDGE / POSITION 3



TEST SETUP PHOTO(S) - BAND EDGE

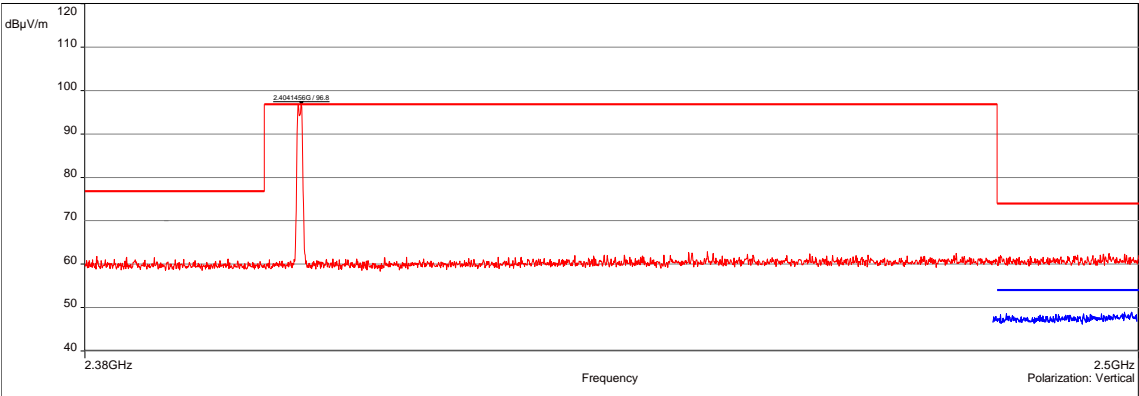
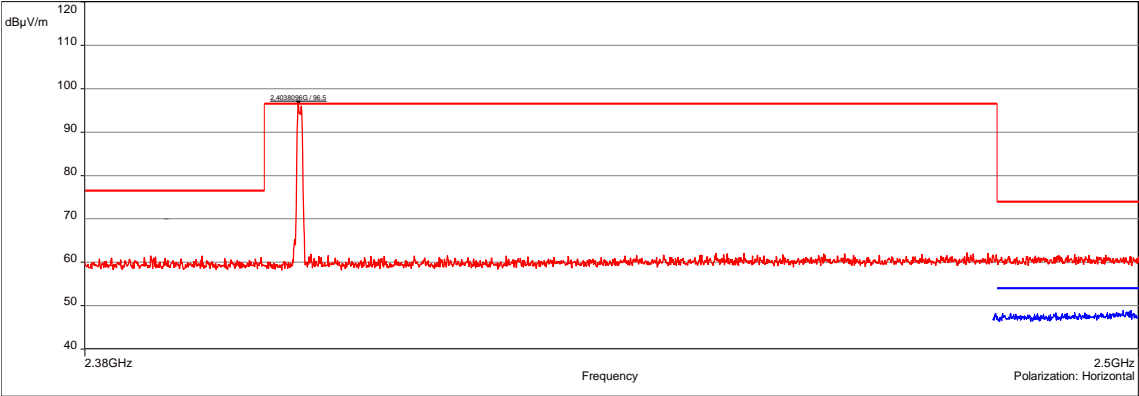

BAND EDGE - GRAPH					
ALL POSITIONS / LOW CHANNEL				EMI6723	
EUT mode:	Modulated			T (°C):	20.0
Test Date:	03/03/2021			H (%):	39.5
Test Operator:	ATO & OAT			P (hPa):	1015
<p>Sub-range 1 Frequencies: 2.38 GHz - 2.5 GHz (Analyser mode) 15000 Points Settings: RBW: 100kHz, VBW: 300kHz, Auto, Attenuation: 10 dB, Sweep count 1, Preamp: Off, LN Preamp: Off, Preselector: Off Polarization: Vertical Distance: 3 m</p>  <p>Band edge / All Positions / Low channel / V - 03/04/2021 09:18 - 6723</p>					
<p>Sub-range 1 Frequencies: 2.38 GHz - 2.5 GHz (Analyser mode) 15000 Points Settings: RBW: 100kHz, VBW: 300kHz, Auto, Attenuation: 10 dB, Sweep count 1, Preamp: Off, LN Preamp: Off, Preselector: Off Polarization: Horizontal Distance: 3 m</p>  <p>Band edge / All Positions / Low channel / H - 03/04/2021 09:22 - 6724</p>					
POSITION	FREQUENCIES	RBW	VBW	DETECTOR	
Vertical	2.38GHz-2.5GHz	100kHz	300kHz	Peak	
Horizontal	2.38GHz-2.5GHz	100kHz	300kHz	Peak	
Vertical	2.48GHz-2.5GHz	100kHz	20kHz	Peak	
Horizontal	2.48GHz-2.5GHz	100kHz	20kHz	Peak	
Configuration:	N/A				
Comments:	N/A				
EUT modification(s): N/A					

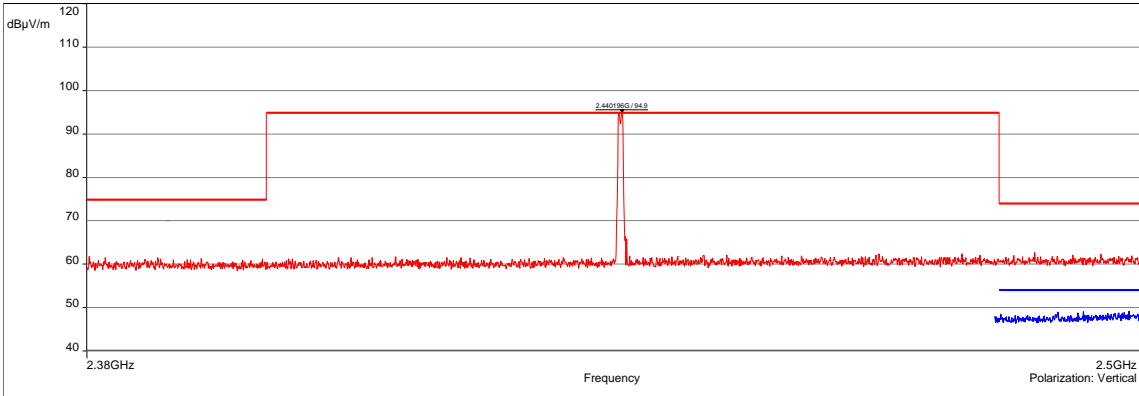
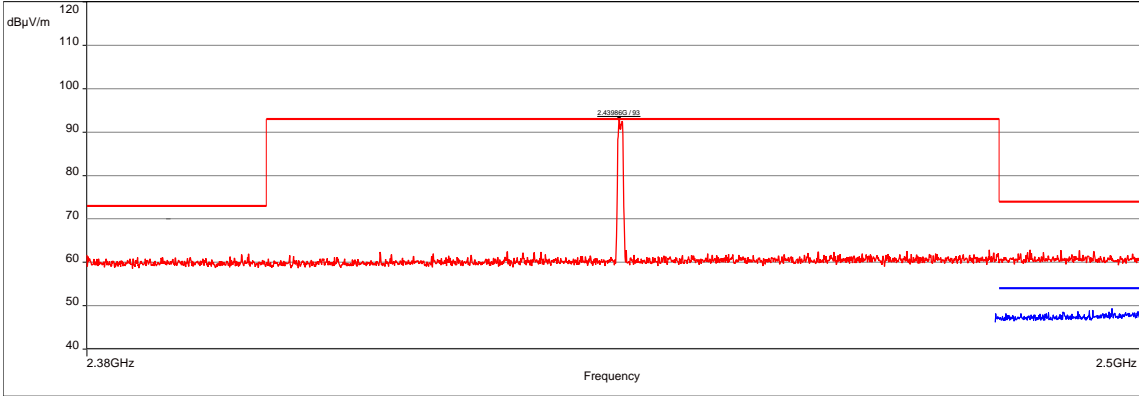
BAND EDGE - GRAPH					
ALL POSITIONS / MID CHANNEL				EMI6725	
EUT mode:	Modulated			T (°C):	20.0
Test Date:	04/03/2021			H (%):	39.5
Test Operator:	ATO & OAT			P (hPa):	1015
<p>Sub-range 1 Frequencies: 2.38 GHz - 2.5 GHz (Analyser mode) 15000 Points Settings: RBW: 100kHz, VBW: 300kHz, Auto, Attenuation: 10 dB, Sweep count 1, Preamp: Off, LN Preamp: Off, Preselector: Off Polarization: Vertical Distance: 3 m</p>  <p>Band edge / All Positions / Mid channel / V - 03/04/2021 09:32 - 6725</p>					
<p>Sub-range 1 Frequencies: 2.38 GHz - 2.5 GHz (Analyser mode) 15000 Points Settings: RBW: 100kHz, VBW: 300kHz, Auto, Attenuation: 10 dB, Sweep count 1, Preamp: Off, LN Preamp: Off, Preselector: Off Polarization: Horizontal Distance: 3 m</p>  <p>Band edge / All Positions / Mid channel / H - 03/04/2021 09:38 - 6726</p>					
POSITION	FREQUENCIES	RBW	VBW	DETECTOR	
Vertical	2.38GHz-2.5GHz	100kHz	300kHz	Peak	
Horizontal	2.38GHz-2.5GHz	100kHz	300kHz	Peak	
Vertical	2.48GHz-2.5GHz	100kHz	20kHz	Peak	
Horizontal	2.48GHz-2.5GHz	100kHz	20kHz	Peak	
Configuration:	N/A				
Comments:	N/A				
EUT modification(s): N/A					

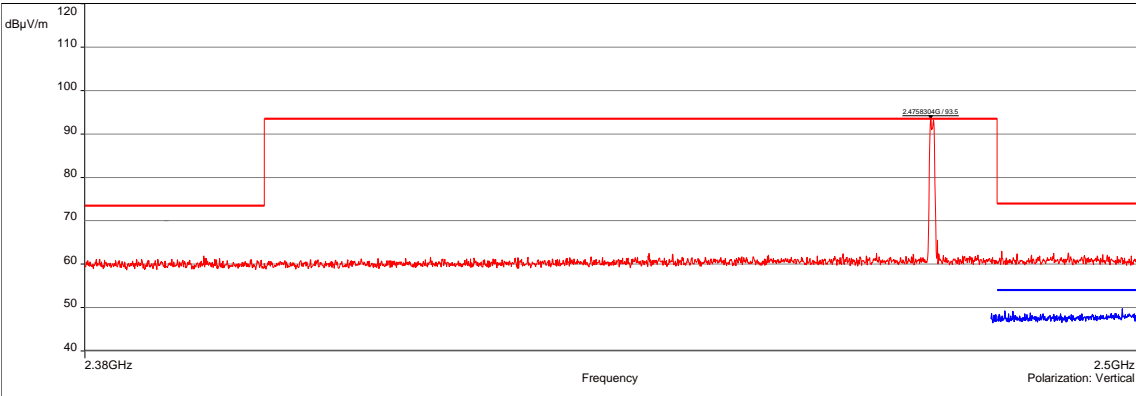
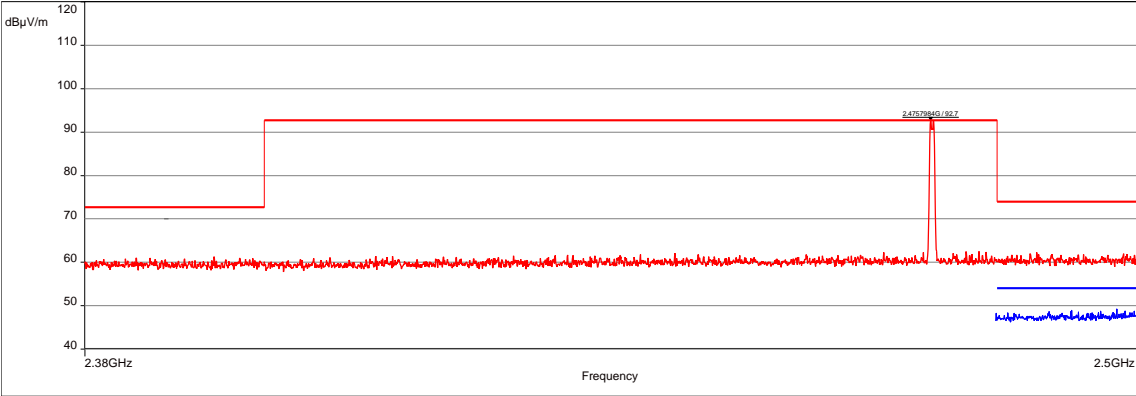
BAND EDGE - GRAPH					
ALL POSITIONS / HIGH CHANNEL				EMI6727	
EUT mode:	Modulated			T (°C):	20.0
Test Date:	04/03/2021			H (%):	39.5
Test Operator:	ATO & OAT			P (hPa):	1015
<p style="text-align: right;"> — FCC/15.249 Band edge - Classe:FMF28 High V - Moyenne/3.0m/ — FCC/15.249 Band edge - Classe:FMF28 High V - Crête/3.0m/ — Meas.Peak (Vertical) — Meas.Avg (Vertical) </p> <p>Sub-range 1 Frequencies: 2.38 GHz - 2.5 GHz (Analyser mode) 15000 Points Settings: RBW: 100kHz, VBW: 300kHz, Auto, Attenuation: 10 dB, Sweep count 1, Preamp: Off, LN Preamp: Off, Preselector: Off Polarization:Vertical Distance: 3 m</p>  <p style="text-align: center;">Band edge / All Positions / High channel / V - 03/04/2021 09:49 - 6727</p>					
<p style="text-align: right;"> — FCC/15.249 Band edge - Classe:FMF28 High H - Moyenne/3.0m/ — FCC/15.249 Band edge - Classe:FMF28 High H - Crête/3.0m/ — Meas.Peak (Horizontal) — Meas.Avg (Horizontal) </p> <p>Sub-range 1 Frequencies: 2.38 GHz - 2.5 GHz (Analyser mode) 15000 Points Settings: RBW: 100kHz, VBW: 300kHz, Auto, Attenuation: 10 dB, Sweep count 1, Preamp: Off, LN Preamp: Off, Preselector: Off Polarization:Horizontal Distance: 3 m</p>  <p style="text-align: center;">Band edge / All Positions / High channel / H - 03/04/2021 09:54 - 6728</p>					
POSITION	FREQUENCIES	RBW	VBW	DETECTOR	
Vertical	2.38GHz-2.5GHz	100kHz	300kHz	Peak	
Horizontal	2.38GHz-2.5GHz	100kHz	300kHz	Peak	
Vertical	2.48GHz-2.5GHz	100kHz	20kHz	Peak	
Horizontal	2.48GHz-2.5GHz	100kHz	20kHz	Peak	
Configuration:	N/A				
Comments:	N/A				
EUT modification(s): N/A					

8.6. Power spectral density

Reference standard:	FCC part 15 Radio part 15.247 and RSS-247
Test method:	FCC part 15.247 and RSS-247
Test description: e)	
<p>For digitally modulated systems, the power spectral density conducted from the intentional radiator to the antenna shall not be greater than 8 dBm in any 3 kHz band during any time interval of continuous transmission. This power spectral density shall be determined in accordance with the provisions of paragraph (b) of this section. The same method of determining the conducted output power shall be used to determine the power spectral density.</p> <p>EUT is connected to the measuring receiver via 50Ω attenuator(s). Only the highest levels are recorded.</p>	

TESTED CONFIGURATION	PARAMETER	SEVERITY	RESULT TAB.	VERDICT
All Positions / Low channel	2.4035GHz- 2.4045GHz	8dBm/3kHz	EMI6707	PASS
All Positions / Mid channel	2.4395GHz- 2.4405GHz	8dBm/3kHz	EMI6708	PASS
All Positions / High channel	2.4755GHz- 2.4765GHz	8dBm/3kHz	EMI6709	PASS

LABORATORY PARAMETERS:	REQUIRED PRIOR TO THE TEST	DURING THE TEST
Ambient Temperature	15 to 35 °C	See Graph(s)
Relative Humidity	20 to 75 %	See Graph(s)
Atmospheric pressure	N/A	See Graph(s)
Test method deviation: N/A		
Supplementary information: N/A		

TEST EQUIPMENT USED					
CATEGORY	BRAND	TYPE	IDENTIFIER	CAL. DATE	CAL. DUE
Antenna	ETS-Lindgren	3117	5456	24/07/2019	24/09/2022
Attenuator	EMITECH	SUB.V2-H	14495	13/01/2021	13/03/2022
Attenuator	EMITECH	SUB.V2-V	14496	13/01/2021	13/03/2022
Cable	SUCOFLEX	N-3m	14379	25/06/2019	25/08/2021
Cable	MegaPhase	N-3m	14852	30/10/2018	30/06/2021
Cable	SUCOFLEX	N-5,5m	14381	25/06/2019	25/08/2021
Cable	Huber + Suhner	SF102K	16041	28/02/2019	28/04/2021
Receiver	Rohde & Schwarz	FSW43	14830	29/07/2020	29/09/2021
Shielded enclosure	RAY PROOF	C.V2	1423	04/10/2019	04/12/2022
Software	Nexio		0000		
Thermohygrometer	Testo	608-H1	7562	25/01/2019	25/03/2021
Thermohygrometer	Bioblock Scientific	Météostar	0963	25/01/2019	25/03/2021

BAT-EMC software version: V3.18.0.26

Blank cells = Permanent validity

TEST SETUP PHOTO(S) - PSD / POSITION 1



TEST SETUP PHOTO(S) - PSD / POSITION 2



TEST SETUP PHOTO(S) - PSD / POSITION 3



TEST SETUP PHOTO(S) - PSD

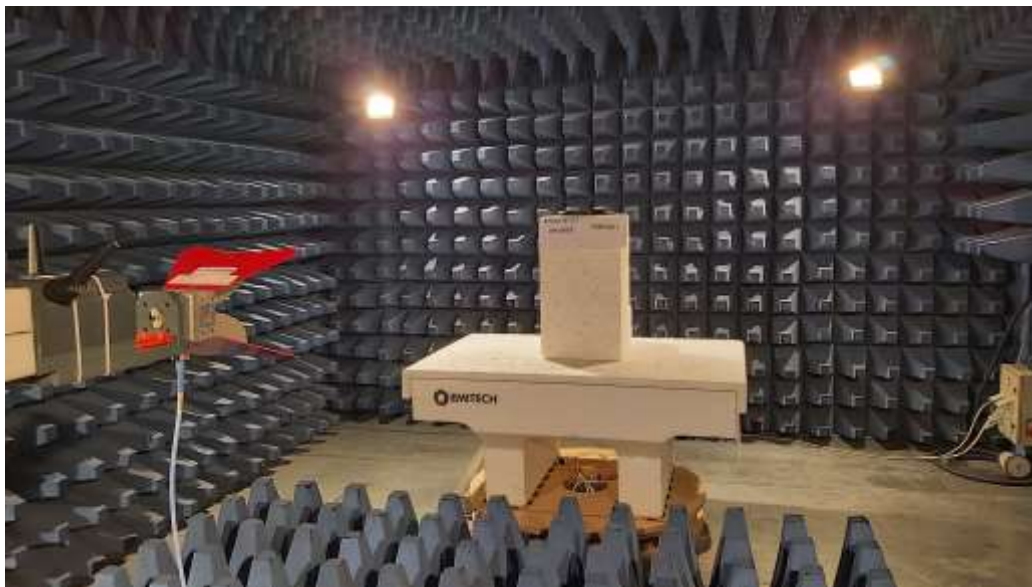

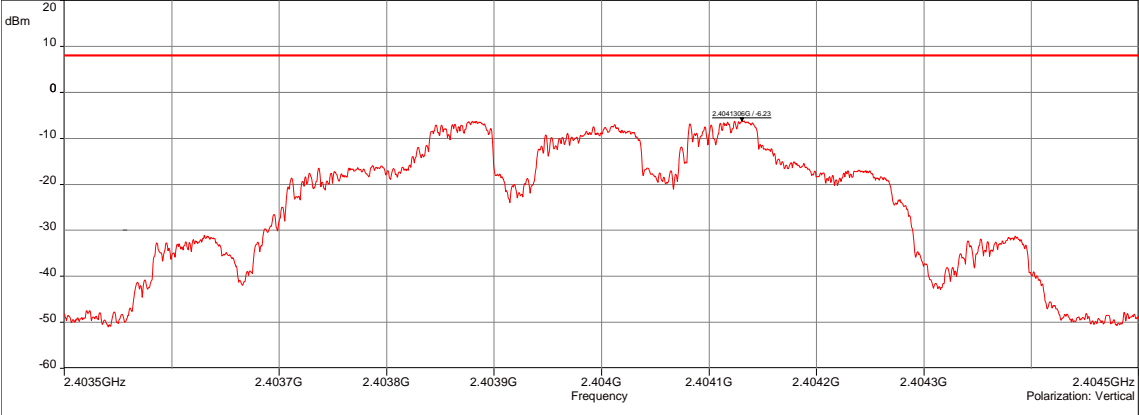
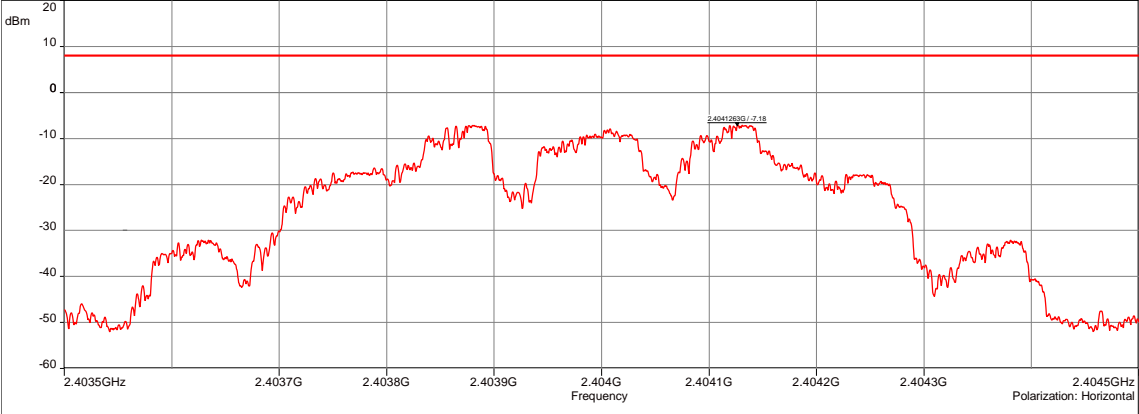
POWER SPECTRAL DENSITY - GRAPH					
ALL POSITIONS / LOW CHANNEL				EMI6707	
EUT mode:	Modulated			T (°C):	20.7
Test Date:	03/03/2021			H (%):	362
Test Operator:	ATO & OAT			P (hPa):	1023
<p>Sub-range 1 Frequencies: 2.4035 GHz - 2.4045 GHz (Analyser mode) 8000 Points Settings: RBW: 3kHz, VBW: 9kHz, Auto, Attenuation: 10 dB, Sweep count 1, Preamp: Off, LN Preamp: Off, Preselector: Off Polarization: Vertical Distance: 3 m</p>  <p>PSD / All Positions / Low channel - 03/03/2021 14:38 - 6707</p>					
<p>Sub-range 2 Frequencies: 2.4035 GHz - 2.4045 GHz (Analyser mode) 8000 Points Settings: RBW: 3kHz, VBW: 9kHz, Auto, Attenuation: 10 dB, Sweep count 1, Preamp: Off, LN Preamp: Off, Preselector: Off Polarization: Horizontal Distance: 3 m</p>  <p>PSD / All Positions / Low channel - 03/03/2021 14:38 - 6707</p>					
POSITION	FREQUENCIES	RBW	VBW	DETECTOR	
Vertical	2.4035GHz-2.4045GHz	3kHz	9kHz	Peak	
Horizontal	2.4035GHz-2.4045GHz	3kHz	9kHz	Peak	
Configuration:	N/A				
Comments:	N/A				
EUT modification(s): N/A					

POWER SPECTRAL DENSITY - TABULATED RESULTS			
ALL POSITIONS / LOW CHANNEL			EMI6707
Frequency (MHz)	Polarization	Level (dBm)	Limit (dBm)
2404.13	Vertical	-6.23	8
2404.12	Horizontal	-7.18	8

POWER SPECTRAL DENSITY - GRAPH				
PSD / ALL POSITIONS / MID CHANNEL			EMI6708	
EUT mode:	Modulated		T (°C):	20.7
Test Date:	03/03/2021		H (%):	362
Test Operator:	ATO & OAT		P (hPa):	1023

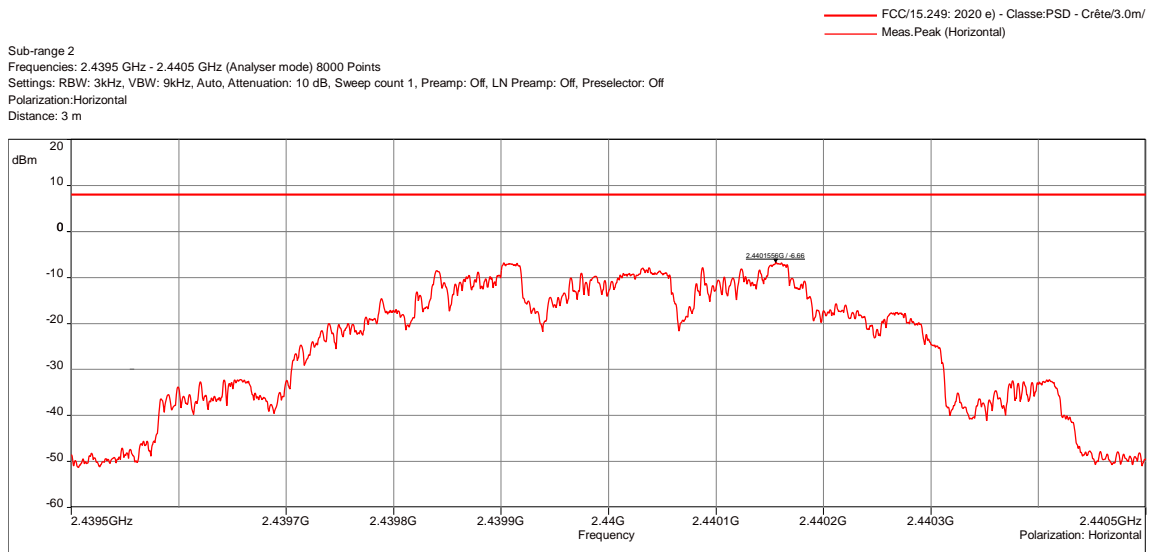
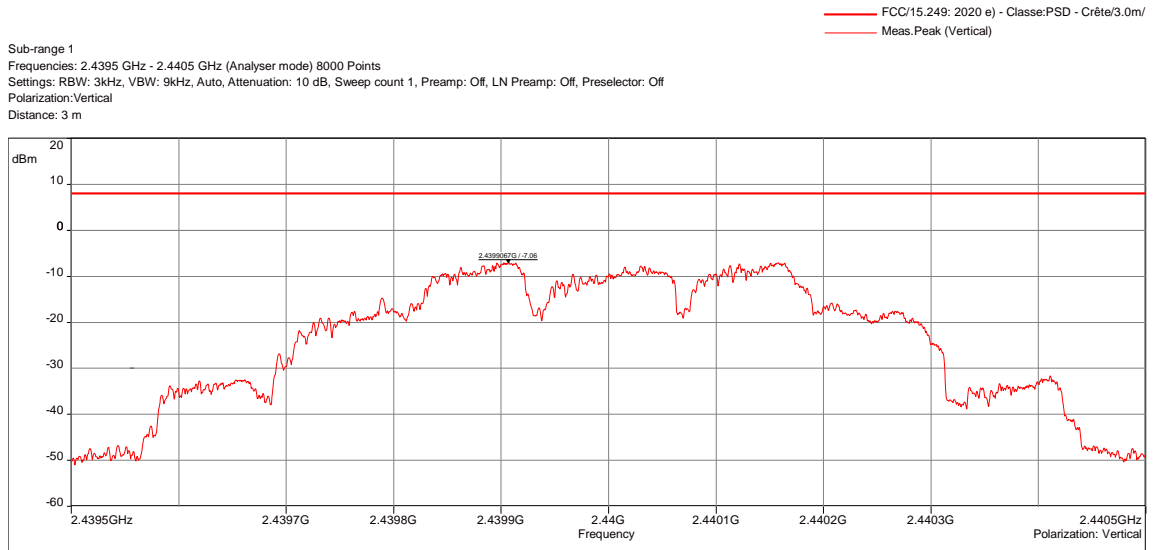

POSITION	FREQUENCIES	RBW	VBW	DETECTOR
Vertical	2.4395GHz-2.4405GHz	3kHz	9kHz	Peak
Horizontal	2.4395GHz-2.4405GHz	3kHz	9kHz	Peak
Configuration:	N/A			
Comments:	N/A			
EUT modification(s): N/A				

POWER SPECTRAL DENSITY - TABULATED RESULTS			
PSD / ALL POSITIONS / MID CHANNEL			EMI6708
Frequency (MHz)	Polarization	Level (dBm)	Limit (dBm)
2439.90	Vertical	-7.06	8
2440.15	Horizontal	-6.66	8

POWER SPECTRAL DENSITY - GRAPH				
ALL POSITIONS / HIGH CHANNEL			EMI6709	
EUT mode:	Modulated		T (°C):	20.7
Test Date:	03/03/2021		H (%):	362
Test Operator:	ATO & OAT		P (hPa):	1023

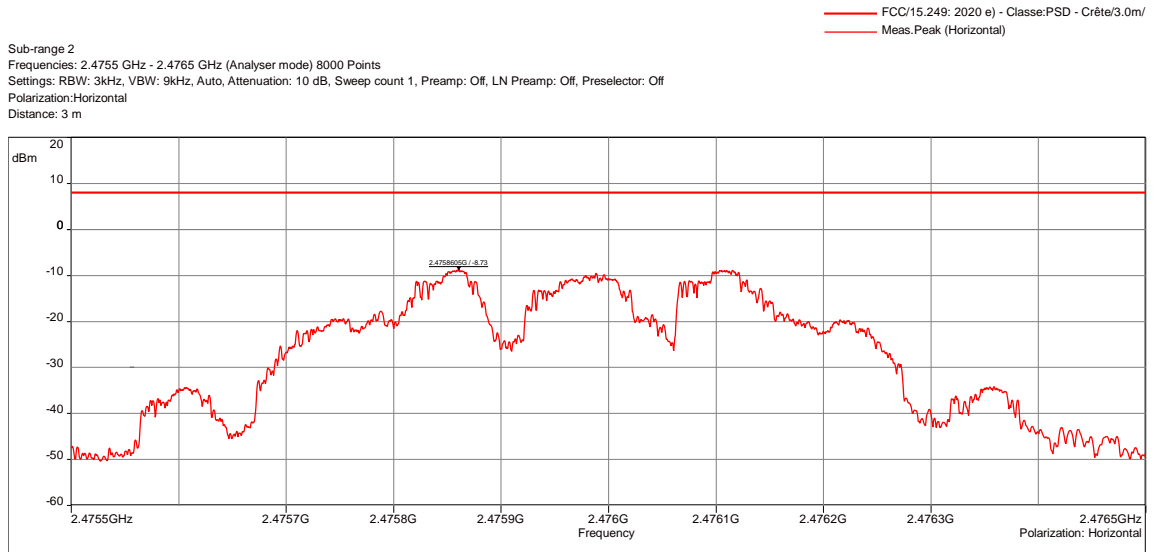
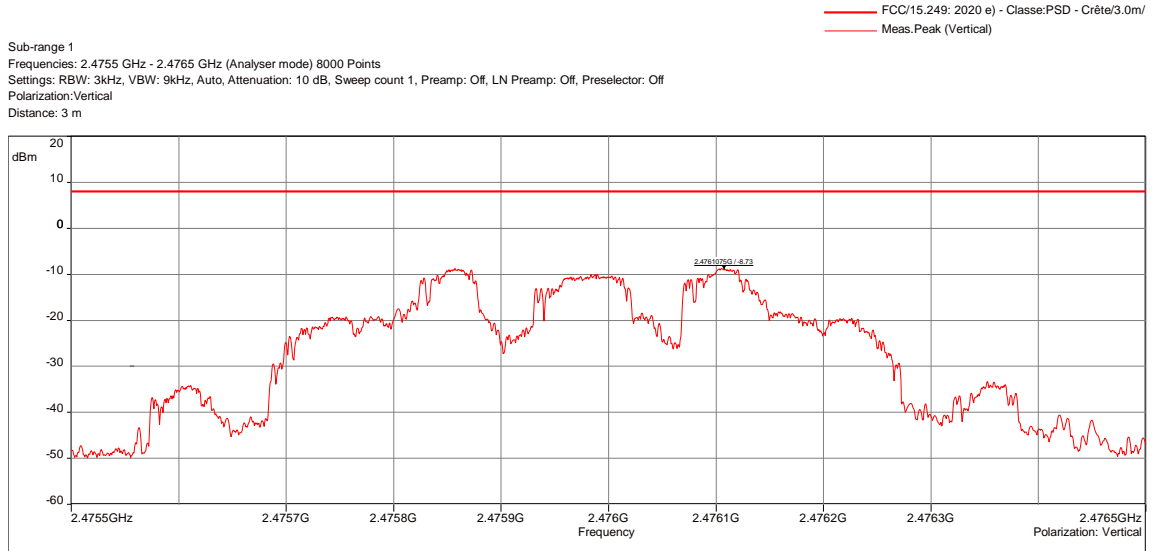

POSITION	FREQUENCIES	RBW	VBW	DETECTOR
Vertical	2.4755GHz-2.4765GHz	3kHz	9kHz	Peak
Horizontal	2.4755GHz-2.4765GHz	3kHz	9kHz	Peak
Configuration:	N/A			
Comments:	N/A			
EUT modification(s): N/A				

POWER SPECTRAL DENSITY - TABULATED RESULTS			
ALL POSITIONS / HIGH CHANNEL			EMI6709
Frequency (MHz)	Polarization	Level (dBm)	Limit (dBm)
2476.10	Vertical	-8.73	8
2475.86	Horizontal	-8.73	8

8.7. Transmitter radiated spurious emissions at frequencies <30MHz

Reference standard:	FCC part 15 Radio part 15.247 and RSS-247
Test method:	FCC part 15.109, 15.209, 15.205, 15.215 RSS-247, CNR Gen
<p>General test setup: Spurious domain emission limits are limits on emissions at frequencies other than those of the carrier and sidebands associated with normal test modulation.</p> <p>EUT is set on an insulating support at 80cm above the ground reference plane.</p> <p>Preliminary (peak) measurements were performed at an antenna to EUT separation distance of 3-meter in a anechoic chamber. The EUT was rotated 360° in order to maximize radiated levels. Test antenna was oriented in 3 axes (0°, 45° and 90°).</p> <p>Final measurements (quasi-peak) were then performed in a 10-meter Open Area Test Site that complies to CISPR 16 in the same measurement conditions.</p> <p>All frequencies were investigated, where applicable.</p>	

TESTED CONFIGURATION	PARAMETER	SEVERITY	RESULT TAB.	VERDICT
Tx Mode / Low channel / 0° - Position 1	9kHz-30MHz	15.209	EMI5131	PASS
Tx Mode / Low channel / 45° - Position 1	9kHz-30MHz	15.209	EMI5132	PASS
Tx Mode / Low channel / 90° - Position 1	9kHz-30MHz	15.209	EMI5133	PASS
Tx Mode / Low channel / 0° - Position 2	9kHz-30MHz	15.209	EMI5134	PASS
Tx Mode / Low channel / 45° - Position 2	9kHz-30MHz	15.209	EMI5135	PASS
Tx Mode / Low channel / 90° - Position 2	9kHz-30MHz	15.209	EMI5136	PASS
Tx Mode / Low channel / 0° - Position 3	9kHz-30MHz	15.209	EMI5137	PASS
Tx Mode / Low channel / 45° - Position 3	9kHz-30MHz	15.209	EMI5138	PASS
Tx Mode / Low channel / 90° - Position 3	9kHz-30MHz	15.209	EMI5139	PASS
Tx Mode / High channel / 0° - Position 1	9kHz-30MHz	15.209	EMI5141	PASS
Tx Mode / High channel / 45° - Position 1	9kHz-30MHz	15.209	EMI5142	PASS
Tx Mode / High channel / 90° - Position 1	9kHz-30MHz	15.209	EMI5143	PASS
Tx Mode / High channel / 0° - Position 2	9kHz-30MHz	15.209	EMI5144	PASS
Tx Mode / High channel / 45° - Position 2	9kHz-30MHz	15.209	EMI5145	PASS
Tx Mode / High channel / 90° - Position 2	9kHz-30MHz	15.209	EMI5146	PASS
Tx Mode / High channel / 0° - Position 3	9kHz-30MHz	15.209	EMI5147	PASS
Tx Mode / High channel / 45° - Position 3	9kHz-30MHz	15.209	EMI5148	PASS
Tx Mode / High channel / 90° - Position 3	9kHz-30MHz	15.209	EMI5149	PASS

LABORATORY PARAMETERS:	REQUIRED PRIOR TO THE TEST	DURING THE TEST
Ambient Temperature	15 to 35 °C	See Graph(es)
Relative Humidity	20 to 75 %	See Graph(es)
Atmospheric pressure	N/A	See Graph(es)
Test method deviation: N/A		
<p>Supplementary information:</p> <p>From 9 kHz to 30MHz: limit indicated on the curves is calculated with 40 dB/decade extrapolation factor and 51.5 dB conversion factor.</p> <p>From 30MHz to 1GHz Quasi peak limit provided is the limit given in §15.209.</p> <p>Above 1GHz average limit in restricted bands §15.205 is 54dBµV/m. Otherwise, the limit is 20dB under carrier emission level at 3m without averaging.</p>		

TEST EQUIPMENT USED					
CATEGORY	BRAND	TYPE	IDENTIFIER	CAL. DATE	CAL. DUE
Antenna	Rohde & Schwarz	HFH2-Z2	5825	24/04/2020	24/06/2022
Cable	MegaPhase	N-3m	14852	29/10/2018	29/12/2020
Cable	SUCOFLEX	N-6,5m	14380	25/07/2019	25/09/2021
Cable	MegaPhase	N-8m	15813	12/11/2018	12/01/2021
Receiver	Rohde & Schwarz	FPL1003	16027	14/08/2020	14/10/2021
Shielded enclosure	COMTEST	SAC 3m	14494	02/10/2019	02/12/2022
Software	Nexio		0000		
Thermohygrometer	Testo	608-H1	7561	25/01/2019	25/03/2021
Thermohygrometer	Bioblock Scientific	Météostar	0963	25/01/2019	25/03/2021

BAT-EMC software version: V3.18.0.26

Blank cells = Permanent validity

TRANSMITTER RADIATED SPURIOUS EMISSIONS AT FREQUENCIES <30MHz - TABULATED RESULTS				
TX MODE / LOW CHANNEL - ALL POSITIONS (OATS)				
Frequency (kHz)	Preliminary measurement (Pk) (dBμA/m)	Final measurement (Avg) (dBμA/m)	Limit Avg (dBμA/m)	Margin (Avg-Limit)
12.322	55.64	26.09	53.60	-27.51
20.533	35.33	15.57	48.74	-33.17
36.973	34.79	7.20	43.82	-36.62
45.201	36.12	4.35	40.70	-36.35
61.623	23.62	-3.13	38.29	-41.42
69.852	26.04	-2.45	34.93	-37.38
78.063	24.93	-8.03	49.33	-57.36
86.291	20.50	-8.82	36.47	-45.29
102.730	17.23	-8.70	34.96	-43.66

Supplementary information:
Spurious which has more than 45 dB of margin compared to the applicable limit is not necessarily reported.

TRANSMITTER RADIATED SPURIOUS EMISSIONS AT FREQUENCIES <30MHz - TABULATED RESULTS				
TX MODE / HIGH CHANNEL - ALL POSITIONS (OATS)				
Frequency (kHz)	Preliminary measurement (Pk) (dBμA/m)	Final measurement (Avg) (dBμA/m)	Limit Avg (dBμA/m)	Marging (Avg-Limit)
45.201	51.71	25.19	42.08	-16.89
45.201	-32.23	27.71	42.08	-14.37
135.592	-32.31	7.20	32.54	-25.34
225.961	-32.32	0.80	28.11	-27.31
316.347	-32.39	-3.10	25.19	-28.29
406.733	-32.38	-4.40	23.00	-27.40

Supplementary information:
Spurious which has more than 30 dB of margin compared to the applicable limit is not necessarily reported.
The frequency 45.201 kHz is the utile signal.

TEST SETUP PHOTO(S) - Tx MODE - POSITION 1



TEST SETUP PHOTO(S) - Tx MODE - POSITION 2



TEST SETUP PHOTO(S) - TX MODE - POSITION 3



TEST SETUP PHOTO(S) – TX MODE



TEST SETUP PHOTO(S) - (OATS) - FOR FINAL MEASUREMENT

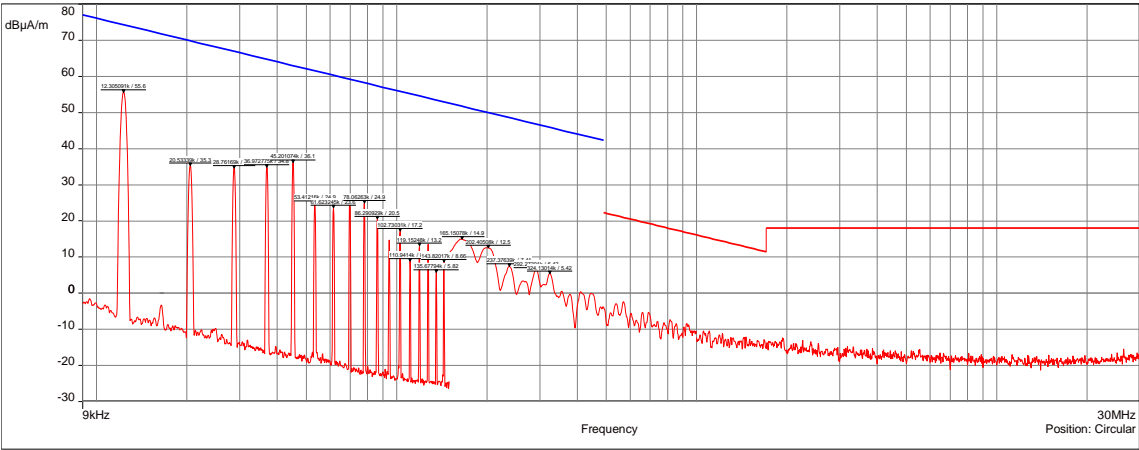

TRANSMITTER RADIATED SPURIOUS EMISSIONS AT FREQUENCIES <30MHz - GRAPH					
Tx MODE / Low CHANNEL / 0° - POSITION 1				EMI5131	
EUT mode:	Tx mode			T (°C):	22.3
Test Date:	02/09/2020			H (%):	45.4
Test Operator:	OAT			P (hPa):	1011
<div style="text-align: right;"> — FCC/FCC Part 15 §209 Tx - Moyenne/3.0m/ — FCC/FCC Part 15 §209 Tx - QCrête/3.0m/ — Meas.Peak </div> 					
POSITION	FREQUENCIES	RBW	VBW	DETECTOR	
Circular	9kHz-150kHz	300Hz	1kHz	Peak	
Circular	150kHz-1MHz	10kHz	30kHz	Peak	
Circular	1MHz-30MHz	10kHz	30kHz	Peak	
Configuration:	N/A				
Comments:	Limit indicated on these plots are calculated with 40 dB/decade extrapolation factor and 51.5dB conversion factor.				
EUT modification(s): N/A					

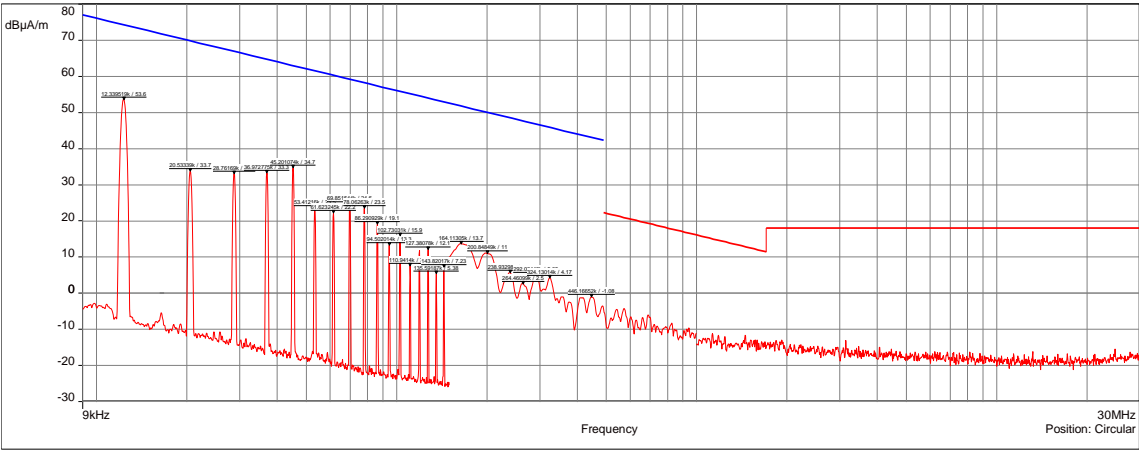
TRANSMITTER RADIATED SPURIOUS EMISSIONS AT FREQUENCIES <30MHz - GRAPH					
Tx MODE / LOW CHANNEL / 45° - POSITION 1				EMI5132	
EUT mode:	Tx mode			T (°C):	22.3
Test Date:	04/09/2020			H (%):	45.4
Test Operator:	OAT			P (hPa):	1011
<div style="text-align: right;"> — FCC/FCC Part 15 §209 Tx - Moyenne/3.0m/ — FCC/FCC Part 15 §209 Tx - QCrête/3.0m/ — Meas.Peak </div> 					
POSITION	FREQUENCIES	RBW	VBW	DETECTOR	
Circular	9kHz-150kHz	300Hz	1kHz	Peak	
Circular	150kHz-1MHz	10kHz	30kHz	Peak	
Circular	1MHz-30MHz	10kHz	30kHz	Peak	
Configuration:	N/A				
Comments:	Limit indicated on these plots are calculated with 40 dB/decade extrapolation factor and 51.5dB conversion factor.				
EUT modification(s): N/A					

TRANSMITTER RADIATED SPURIOUS EMISSIONS AT FREQUENCIES <30MHZ - GRAPH					
Tx MODE / Low FREQ / 90° - POSITION 1				EMI5133	
EUT mode:	Tx mode			T (°C):	22.3
Test Date:	02/09/2020			H (%):	45.4
Test Operator:	OAT			P (hPa):	1011
POSITION	FREQUENCIES	RBW	VBW	DETECTOR	
Circular	9kHz-150kHz	300Hz	1kHz	Peak	
Circular	150kHz-1MHz	10kHz	30kHz	Peak	
Circular	1MHz-30MHz	10kHz	30kHz	Peak	
Configuration:	N/A				
Comments:	Limit indicated on these plots are calculated with 40 dB/decade extrapolation factor and 51.5dB conversion factor.				
EUT modification(s): N/A					

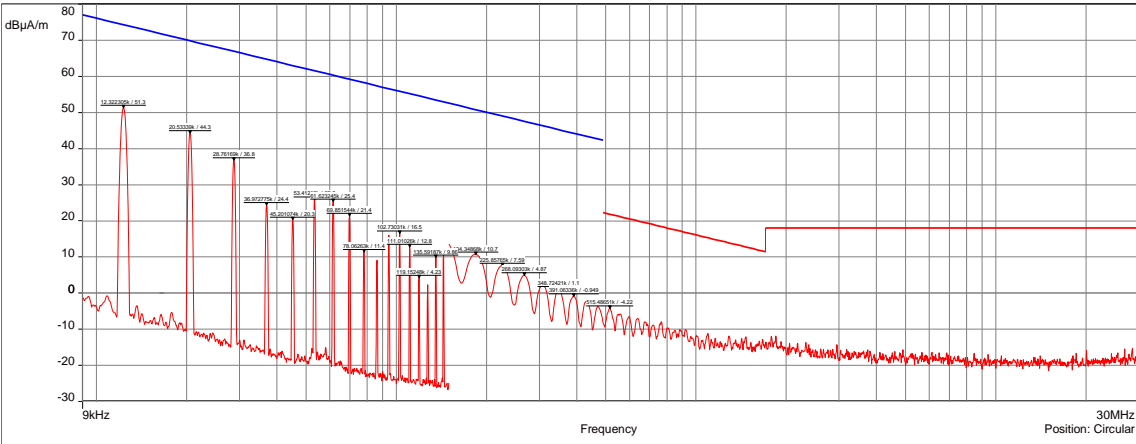
TRANSMITTER RADIATED SPURIOUS EMISSIONS AT FREQUENCIES <30MHz - GRAPH					
Tx MODE / Low CHANNEL / 0° - POSITION 2				EMI5134	
EUT mode:	Tx mode			T (°C):	22.3
Test Date:	02/09/2020			H (%):	45.4
Test Operator:	OAT			P (hPa):	1011
					
POSITION	FREQUENCIES	RBW	VBW	DETECTOR	
Circular	9kHz-150kHz	300Hz	1kHz	Peak	
Circular	150kHz-1MHz	10kHz	30kHz	Peak	
Circular	1MHz-30MHz	10kHz	30kHz	Peak	
Configuration:	N/A				
Comments:	Limit indicated on these plots are calculated with 40 dB/decade extrapolation factor and 51.5dB conversion factor.				
EUT modification(s): N/A					

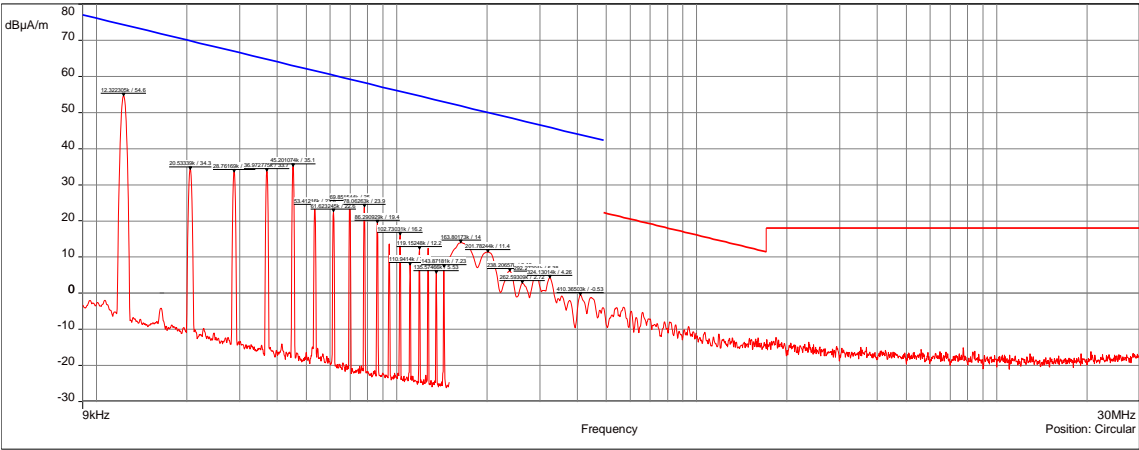
TRANSMITTER RADIATED SPURIOUS EMISSIONS AT FREQUENCIES <30MHz - GRAPH					
Tx MODE / LOW CHANNEL / 45° - POSITION 2				EMI5135	
EUT mode:	Tx mode			T (°C):	22.3
Test Date:	02/09/2020			H (%):	45.4
Test Operator:	OAT			P (hPa):	1011
<div style="text-align: right;"> — FCC/FCC Part 15 §209 Tx - Moyenne/3.0m/ — FCC/FCC Part 15 §209 Tx - QCrête/3.0m/ — Meas.Peak </div> 					
POSITION	FREQUENCIES	RBW	VBW	DETECTOR	
Circular	9kHz-150kHz	300Hz	1kHz	Peak	
Circular	150kHz-1MHz	10kHz	30kHz	Peak	
Circular	1MHz-30MHz	10kHz	30kHz	Peak	
Configuration:	N/A				
Comments:	Limit indicated on these plots are calculated with 40 dB/decade extrapolation factor and 51.5dB conversion factor.				
EUT modification(s): N/A					

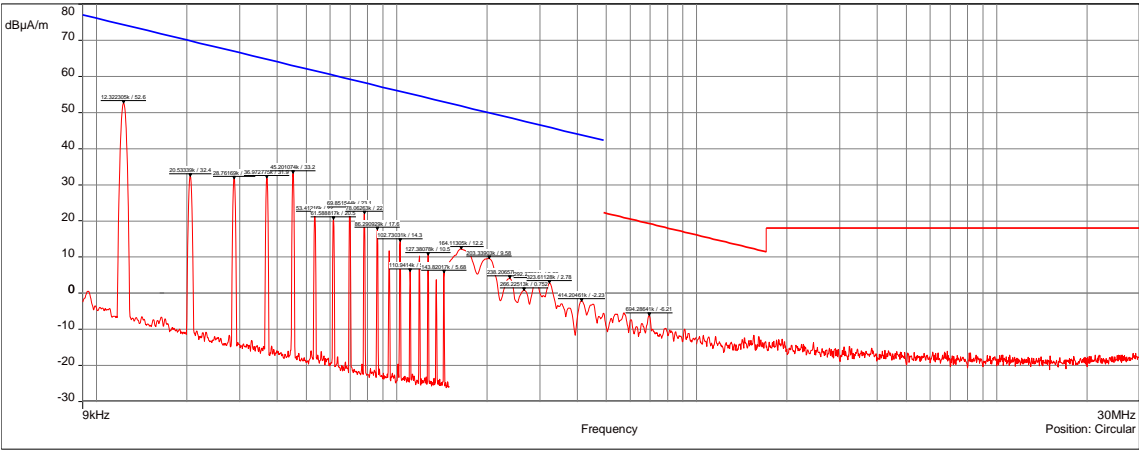
TRANSMITTER RADIATED SPURIOUS EMISSIONS AT FREQUENCIES <30MHZ - GRAPH					
Tx MODE / LOW CHANNEL / 90° - POSITION 2				EMI5136	
EUT mode:	Tx mode			T (°C):	22.3
Test Date:	02/09/2020			H (%):	45.4
Test Operator:	OAT			P (hPa):	1011
<div style="text-align: right;"> — FCC/FCC Part 15 §209 Tx - Moyenne/3.0m/ — FCC/FCC Part 15 §209 Tx - QCrête/3.0m/ — Meas.Peak </div> 					
POSITION	FREQUENCIES	RBW	VBW	DETECTOR	
Circular	9kHz-150kHz	300Hz	1kHz	Peak	
Circular	150kHz-1MHz	10kHz	30kHz	Peak	
Circular	1MHz-30MHz	10kHz	30kHz	Peak	
Configuration:	N/A				
Comments:	Limit indicated on these plots are calculated with 40 dB/decade extrapolation factor and 51.5dB conversion factor.				
EUT modification(s): N/A					

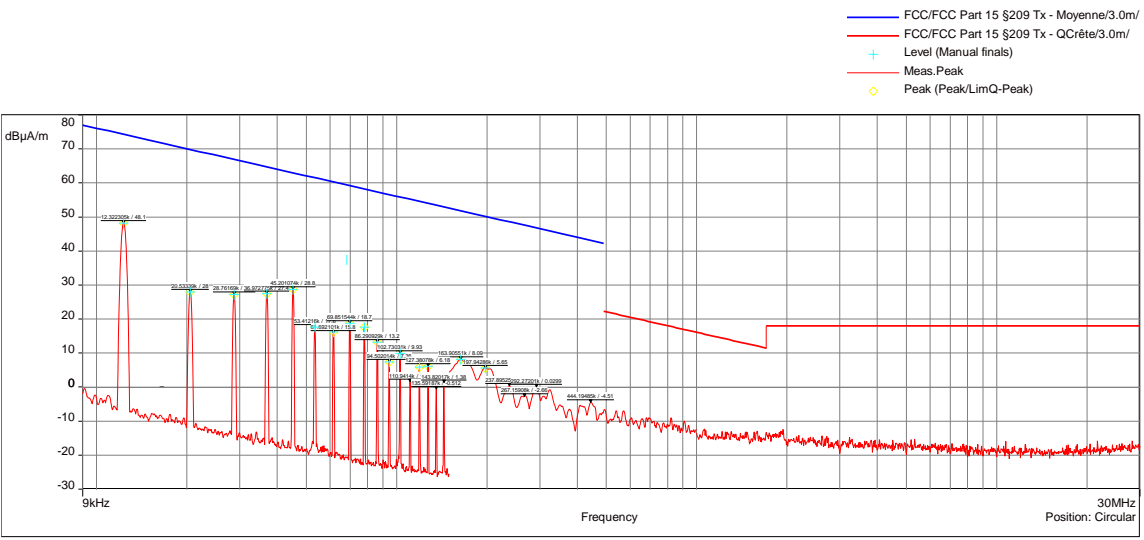
TRANSMITTER RADIATED SPURIOUS EMISSIONS AT FREQUENCIES <30MHZ - GRAPH					
Tx MODE / LOW FREQ / 0° - POSITION 3				EMI5137	
EUT mode:	Tx mode			T (°C):	22.3
Test Date:	02/09/2020			H (%):	45.4
Test Operator:	OAT			P (hPa):	1011
 <p>Legend: — FCC/FCC Part 15 §209 Tx - Moyenne/3.0m/ — FCC/FCC Part 15 §209 Tx - QCrête/3.0m/ + Level (Manual finals) — Meas.Peak ◇ Peak (Peak/LimQ-Peak)</p>					
POSITION	FREQUENCIES	RBW	VBW	DETECTOR	
Circular	9kHz-150kHz	300Hz	1kHz	Peak	
Circular	150kHz-1MHz	10kHz	30kHz	Peak	
Circular	1MHz-30MHz	10kHz	30kHz	Peak	
Configuration:	N/A				
Comments:	Limit indicated on these plots are calculated with 40 dB/decade extrapolation factor and 51.5dB conversion factor.				
EUT modification(s): N/A					

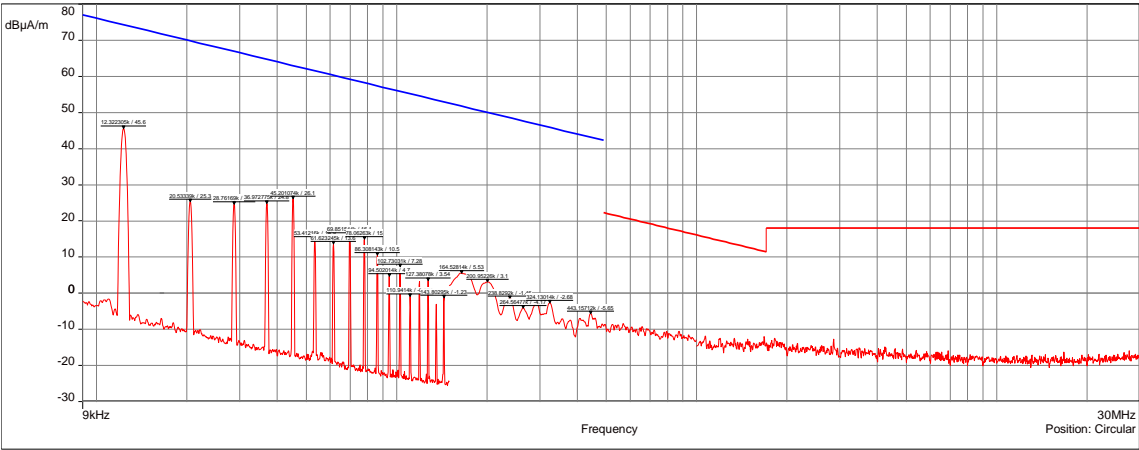
TRANSMITTER RADIATED SPURIOUS EMISSIONS AT FREQUENCIES <30MHZ - GRAPH					
Tx MODE / LOW FREQ / 45° - POSITION 3				EMI5138	
EUT mode:	Tx mode			T (°C):	22.3
Test Date:	02/09/2020			H (%):	45.4
Test Operator:	OAT			P (hPa):	1011
<div style="text-align: right;"> — FCC/FCC Part 15 §209 Tx - Moyenne/3.0m/ — FCC/FCC Part 15 §209 Tx - QCrête/3.0m/ — Meas.Peak </div> 					
POSITION	FREQUENCIES	RBW	VBW	DETECTOR	
Circular	9kHz-150kHz	300Hz	1kHz	Peak	
Circular	150kHz-1MHz	10kHz	30kHz	Peak	
Circular	1MHz-30MHz	10kHz	30kHz	Peak	
Configuration:	N/A				
Comments:	Limit indicated on these plots are calculated with 40 dB/decade extrapolation factor and 51.5dB conversion factor.				
EUT modification(s): N/A					

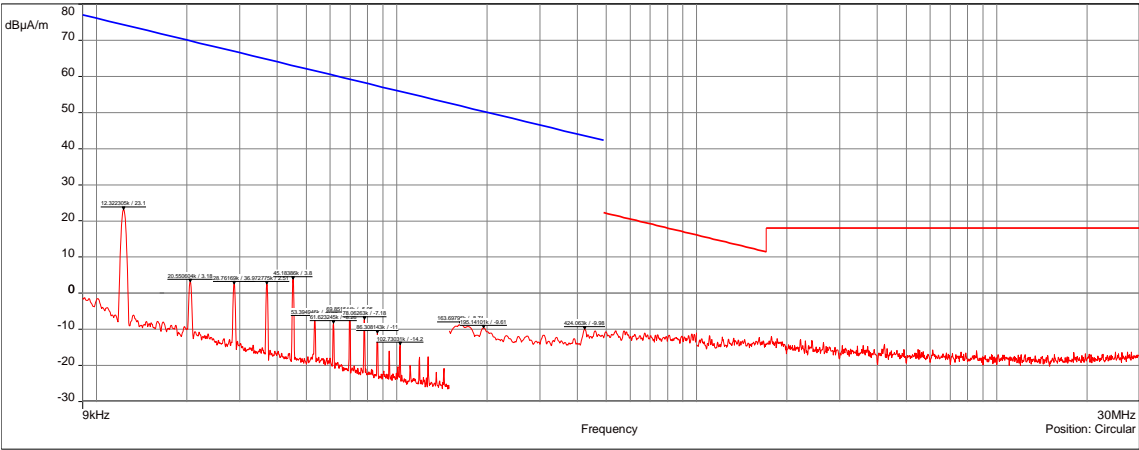
TRANSMITTER RADIATED SPURIOUS EMISSIONS AT FREQUENCIES <30MHz - GRAPH					
Tx MODE / LOW CHANNEL / 90° - POSITION 3				EMI5139	
EUT mode:	Tx mode			T (°C):	22.3
Test Date:	02/09/2020			H (%):	45.4
Test Operator:	OAT			P (hPa):	1011
<div style="text-align: right;"> — FCC/FCC Part 15 §209 Tx - Moyenne/3.0m/ — FCC/FCC Part 15 §209 Tx - QCrête/3.0m/ — Meas.Peak </div> 					
POSITION	FREQUENCIES	RBW	VBW	DETECTOR	
Circular	9kHz-150kHz	300Hz	1kHz	Peak	
Circular	150kHz-1MHz	10kHz	30kHz	Peak	
Circular	1MHz-30MHz	10kHz	30kHz	Peak	
Configuration:	N/A				
Comments:	Limit indicated on these plots are calculated with 40 dB/decade extrapolation factor and 51.5dB conversion factor.				
EUT modification(s): N/A					

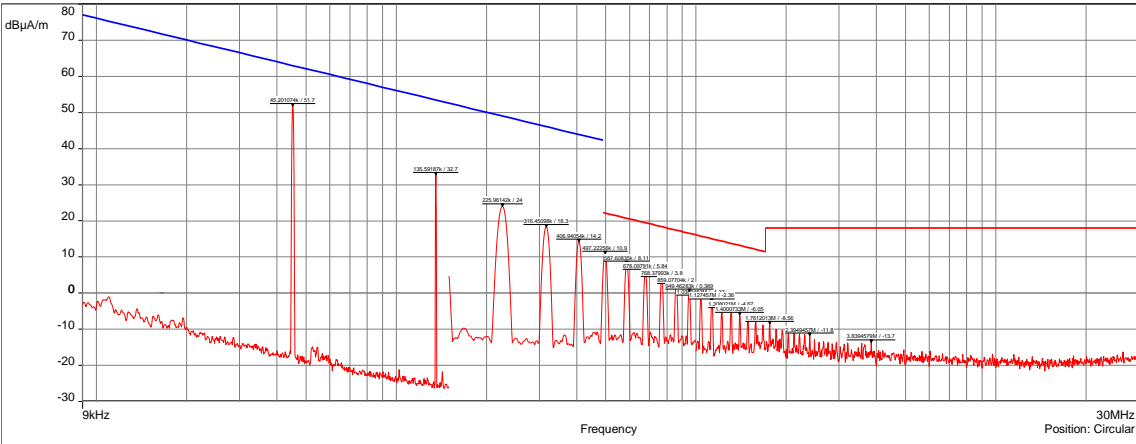
TRANSMITTER RADIATED SPURIOUS EMISSIONS AT FREQUENCIES <30MHz - GRAPH																																																																										
Tx MODE / HIGH FREQ / 0° - POSITION 1				EMI5062																																																																						
EUT mode:	Tx mode			T (°C):	22.3																																																																					
Test Date:	03/09/2020			H (%):	45.4																																																																					
Test Operator:	OAT			P (hPa):	1011																																																																					
<div style="text-align: right;"> — FCC/FCC Part 15 §209 Tx - Moyenne/3.0m/ — FCC/FCC Part 15 §209 Tx - QCrête/3.0m/ — Meas.Peak </div>  <table border="1"> <caption>Peak Data from Graph</caption> <thead> <tr> <th>Frequency (kHz)</th> <th>Value (dBµA/m)</th> </tr> </thead> <tbody> <tr><td>42.00000</td><td>51.2</td></tr> <tr><td>110.50000</td><td>32.7</td></tr> <tr><td>225.91429</td><td>24.1</td></tr> <tr><td>316.40000</td><td>18.1</td></tr> <tr><td>400.90000</td><td>14.2</td></tr> <tr><td>497.20000</td><td>13.0</td></tr> <tr><td>590.00000</td><td>8.11</td></tr> <tr><td>680.00000</td><td>5.84</td></tr> <tr><td>770.00000</td><td>3.88</td></tr> <tr><td>860.00000</td><td>2.98</td></tr> <tr><td>950.00000</td><td>2.26</td></tr> <tr><td>1040.00000</td><td>1.72</td></tr> <tr><td>1130.00000</td><td>1.35</td></tr> <tr><td>1220.00000</td><td>1.04</td></tr> <tr><td>1310.00000</td><td>0.79</td></tr> <tr><td>1400.00000</td><td>0.59</td></tr> <tr><td>1490.00000</td><td>0.44</td></tr> <tr><td>1580.00000</td><td>0.33</td></tr> <tr><td>1670.00000</td><td>0.25</td></tr> <tr><td>1760.00000</td><td>0.19</td></tr> <tr><td>1850.00000</td><td>0.14</td></tr> <tr><td>1940.00000</td><td>0.11</td></tr> <tr><td>2030.00000</td><td>0.08</td></tr> <tr><td>2120.00000</td><td>0.06</td></tr> <tr><td>2210.00000</td><td>0.04</td></tr> <tr><td>2300.00000</td><td>0.03</td></tr> <tr><td>2390.00000</td><td>0.02</td></tr> <tr><td>2480.00000</td><td>0.01</td></tr> <tr><td>2570.00000</td><td>0.01</td></tr> <tr><td>2660.00000</td><td>0.01</td></tr> <tr><td>2750.00000</td><td>0.01</td></tr> <tr><td>2840.00000</td><td>0.01</td></tr> <tr><td>2930.00000</td><td>0.01</td></tr> <tr><td>3020.00000</td><td>0.01</td></tr> </tbody> </table>					Frequency (kHz)	Value (dBµA/m)	42.00000	51.2	110.50000	32.7	225.91429	24.1	316.40000	18.1	400.90000	14.2	497.20000	13.0	590.00000	8.11	680.00000	5.84	770.00000	3.88	860.00000	2.98	950.00000	2.26	1040.00000	1.72	1130.00000	1.35	1220.00000	1.04	1310.00000	0.79	1400.00000	0.59	1490.00000	0.44	1580.00000	0.33	1670.00000	0.25	1760.00000	0.19	1850.00000	0.14	1940.00000	0.11	2030.00000	0.08	2120.00000	0.06	2210.00000	0.04	2300.00000	0.03	2390.00000	0.02	2480.00000	0.01	2570.00000	0.01	2660.00000	0.01	2750.00000	0.01	2840.00000	0.01	2930.00000	0.01	3020.00000	0.01
Frequency (kHz)	Value (dBµA/m)																																																																									
42.00000	51.2																																																																									
110.50000	32.7																																																																									
225.91429	24.1																																																																									
316.40000	18.1																																																																									
400.90000	14.2																																																																									
497.20000	13.0																																																																									
590.00000	8.11																																																																									
680.00000	5.84																																																																									
770.00000	3.88																																																																									
860.00000	2.98																																																																									
950.00000	2.26																																																																									
1040.00000	1.72																																																																									
1130.00000	1.35																																																																									
1220.00000	1.04																																																																									
1310.00000	0.79																																																																									
1400.00000	0.59																																																																									
1490.00000	0.44																																																																									
1580.00000	0.33																																																																									
1670.00000	0.25																																																																									
1760.00000	0.19																																																																									
1850.00000	0.14																																																																									
1940.00000	0.11																																																																									
2030.00000	0.08																																																																									
2120.00000	0.06																																																																									
2210.00000	0.04																																																																									
2300.00000	0.03																																																																									
2390.00000	0.02																																																																									
2480.00000	0.01																																																																									
2570.00000	0.01																																																																									
2660.00000	0.01																																																																									
2750.00000	0.01																																																																									
2840.00000	0.01																																																																									
2930.00000	0.01																																																																									
3020.00000	0.01																																																																									
POSITION	FREQUENCIES	RBW	VBW	DETECTOR																																																																						
Circular	9kHz-150kHz	300Hz	1kHz	Peak																																																																						
Circular	150kHz-1MHz	10kHz	30kHz	Peak																																																																						
Circular	1MHz-30MHz	10kHz	30kHz	Peak																																																																						
Configuration:	N/A																																																																									
Comments:	Limit indicated on these plots are calculated with 40 dB/decade extrapolation factor and 51.5dB conversion factor.																																																																									
EUT modification(s): N/A																																																																										

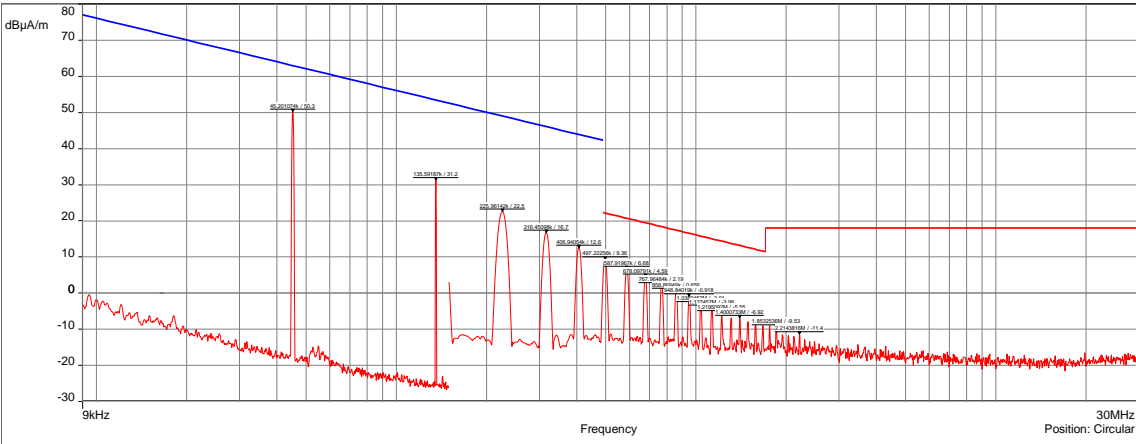
TRANSMITTER RADIATED SPURIOUS EMISSIONS AT FREQUENCIES <30MHZ - GRAPH					
Tx MODE / HIGH FREQ / 45° - POSITION 1				EMI5063	
EUT mode:	Tx mode			T (°C):	22.3
Test Date:	03/09/2020			H (%):	45.4
Test Operator:	OAT			P (hPa):	1011
<div style="text-align: right;"> — FCC/FCC Part 15 §209 Tx - Moyenne/3.0m/ — FCC/FCC Part 15 §209 Tx - QCrête/3.0m/ — Meas.Peak </div> 					
POSITION	FREQUENCIES	RBW	VBW	DETECTOR	
Circular	9kHz-150kHz	300Hz	1kHz	Peak	
Circular	150kHz-1MHz	10kHz	30kHz	Peak	
Circular	1MHz-30MHz	10kHz	30kHz	Peak	
Configuration:	N/A				
Comments:	Limit indicated on these plots are calculated with 40 dB/decade extrapolation factor and 51.5dB conversion factor.				
EUT modification(s): N/A					

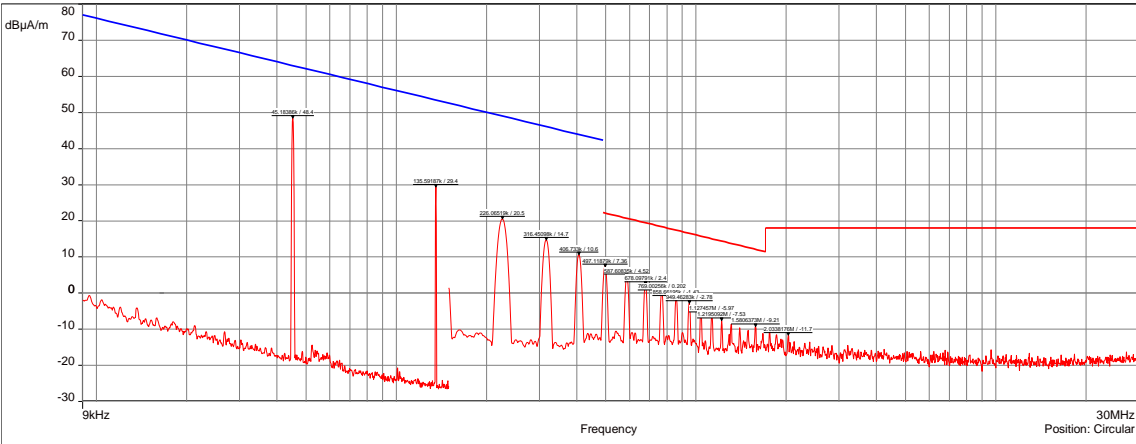
TRANSMITTER RADIATED SPURIOUS EMISSIONS AT FREQUENCIES <30MHZ - GRAPH					
Tx MODE / HIGH FREQ / 90° - POSITION 1				EMI5064	
EUT mode:	Tx mode			T (°C):	22.3
Test Date:	03/09/2020			H (%):	45.4
Test Operator:	OAT			P (hPa):	1011
<div style="text-align: right;"> — FCC/FCC Part 15 §209 Tx - Moyenne/3.0m/ — FCC/FCC Part 15 §209 Tx - QCrête/3.0m/ — Meas.Peak </div> 					
POSITION	FREQUENCIES	RBW	VBW	DETECTOR	
Circular	9kHz-150kHz	300Hz	1kHz	Peak	
Circular	150kHz-1MHz	10kHz	30kHz	Peak	
Circular	1MHz-30MHz	10kHz	30kHz	Peak	
Configuration:	N/A				
Comments:	Limit indicated on these plots are calculated with 40 dB/decade extrapolation factor and 51.5dB conversion factor.				
EUT modification(s): N/A					

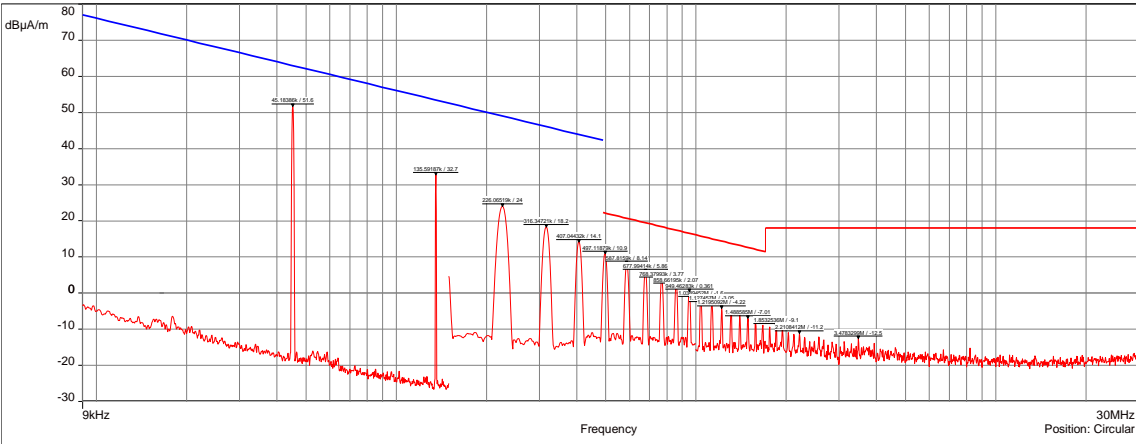
TRANSMITTER RADIATED SPURIOUS EMISSIONS AT FREQUENCIES <30MHZ - GRAPH					
Tx MODE / HIGH FREQ / 0° - POSITION 2				EMI5065	
EUT mode:	Tx mode			T (°C):	22.3
Test Date:	03/09/2020			H (%):	45.4
Test Operator:	OAT			P (hPa):	1011
<div style="text-align: right;"> — FCC/FCC Part 15 §209 Tx - Moyenne/3.0m/ — FCC/FCC Part 15 §209 Tx - QCrête/3.0m/ — Meas.Peak </div> 					
POSITION	FREQUENCIES	RBW	VBW	DETECTOR	
Circular	9kHz-150kHz	300Hz	1kHz	Peak	
Circular	150kHz-1MHz	10kHz	30kHz	Peak	
Circular	1MHz-30MHz	10kHz	30kHz	Peak	
Configuration:	N/A				
Comments:	Limit indicated on these plots are calculated with 40 dB/decade extrapolation factor and 51.5dB conversion factor.				
EUT modification(s): N/A					

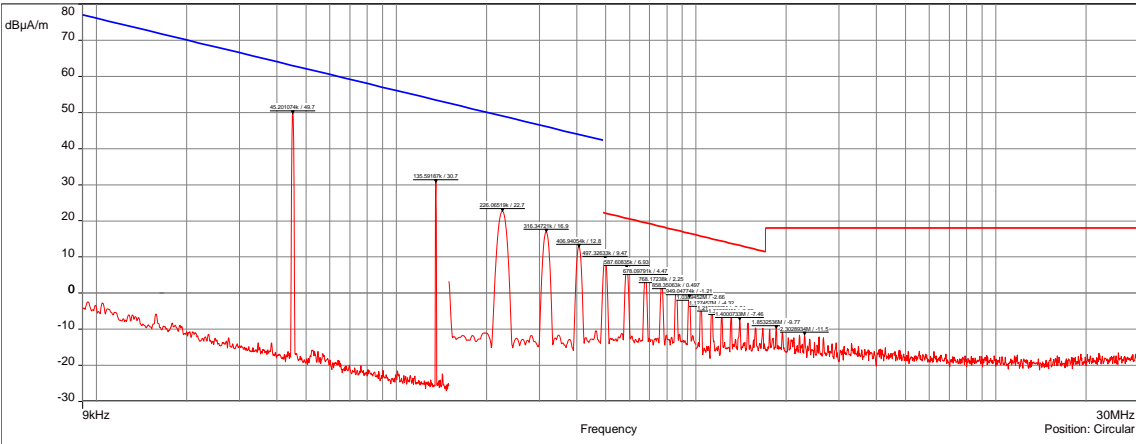
TRANSMITTER RADIATED SPURIOUS EMISSIONS AT FREQUENCIES <30MHz - GRAPH					
Tx MODE / HIGH FREQ / 45° - POSITION 2				EMI5066	
EUT mode:	Tx mode			T (°C):	22.3
Test Date:	03/09/2020			H (%):	45.4
Test Operator:	OAT			P (hPa):	1011
<div style="text-align: right;"> — FCC/FCC Part 15 §209 Tx - Moyenne/3.0m/ — FCC/FCC Part 15 §209 Tx - QCrête/3.0m/ — Meas.Peak </div> 					
POSITION	FREQUENCIES	RBW	VBW	DETECTOR	
Circular	9kHz-150kHz	300Hz	1kHz	Peak	
Circular	150kHz-1MHz	10kHz	30kHz	Peak	
Circular	1MHz-30MHz	10kHz	30kHz	Peak	
Configuration:	N/A				
Comments:	Limit indicated on these plots are calculated with 40 dB/decade extrapolation factor and 51.5dB conversion factor.				
EUT modification(s): N/A					

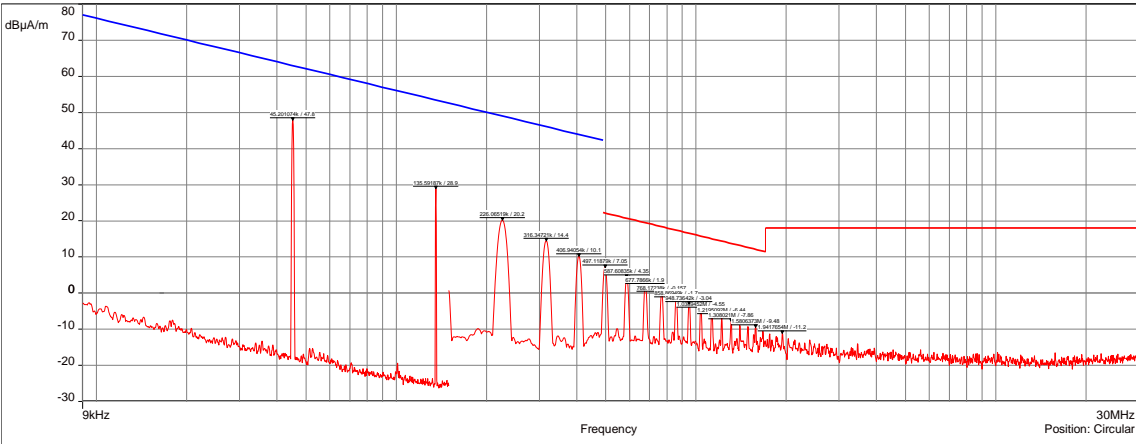
TRANSMITTER RADIATED SPURIOUS EMISSIONS AT FREQUENCIES <30MHZ - GRAPH					
Tx MODE / HIGH FREQ / 90° - POSITION 2				EMI5067	
EUT mode:	Tx mode			T (°C):	22.3
Test Date:	03/09/2020			H (%):	45.4
Test Operator:	OAT			P (hPa):	1011
					
POSITION	FREQUENCIES	RBW	VBW	DETECTOR	
Circular	9kHz-150kHz	300Hz	1kHz	Peak	
Circular	150kHz-1MHz	10kHz	30kHz	Peak	
Circular	1MHz-30MHz	10kHz	30kHz	Peak	
Configuration:	N/A				
Comments:	Limit indicated on these plots are calculated with 40 dB/decade extrapolation factor and 51.5dB conversion factor.				
EUT modification(s): N/A					

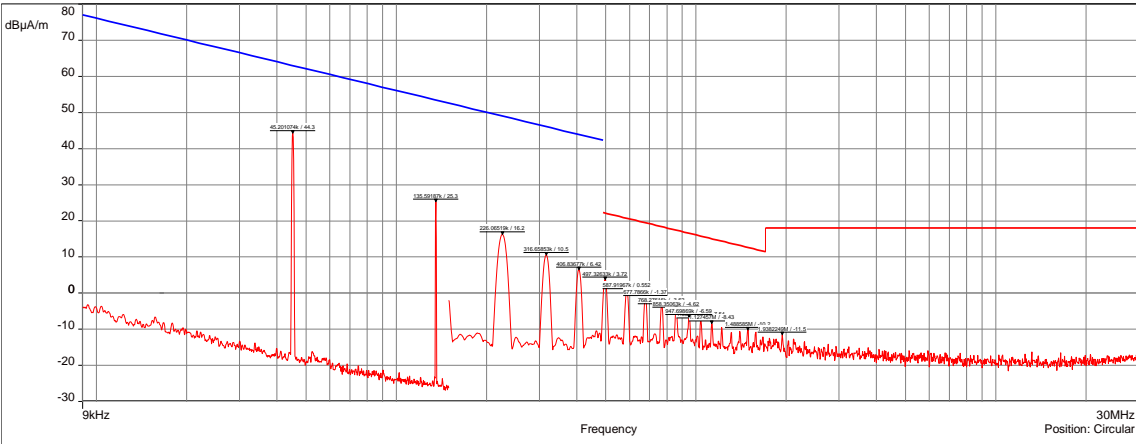
TRANSMITTER RADIATED SPURIOUS EMISSIONS AT FREQUENCIES <30MHZ - GRAPH					
Tx MODE / HIGH FREQ / 0° - POSITION 3				EMI5068	
EUT mode:	Tx mode			T (°C):	22.3
Test Date:	03/09/2020			H (%):	45.4
Test Operator:	OAT			P (hPa):	1011
<div style="text-align: right;"> — FCC/FCC Part 15 §209 Tx - Moyenne/3.0m/ — FCC/FCC Part 15 §209 Tx - QCrête/3.0m/ — Meas.Peak </div> 					
POSITION	FREQUENCIES	RBW	VBW	DETECTOR	
Circular	9kHz-150kHz	300Hz	1kHz	Peak	
Circular	150kHz-1MHz	10kHz	30kHz	Peak	
Circular	1MHz-30MHz	10kHz	30kHz	Peak	
Configuration:	N/A				
Comments:	Limit indicated on these plots are calculated with 40 dB/decade extrapolation factor and 51.5dB conversion factor.				
EUT modification(s): N/A					

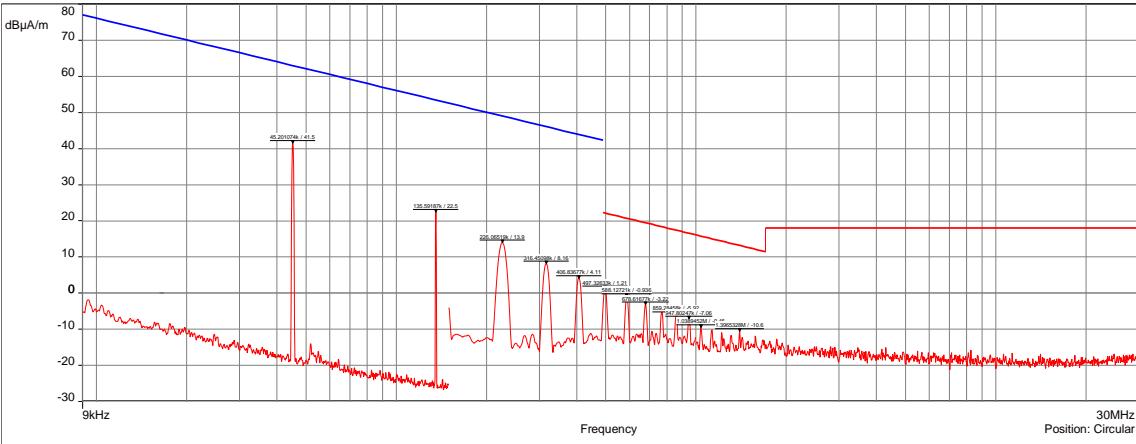
TRANSMITTER RADIATED SPURIOUS EMISSIONS AT FREQUENCIES <30MHZ - GRAPH					
Tx MODE / HIGH FREQ / 45° - POSITION 3				EMI5069	
EUT mode:	Tx mode			T (°C):	22.3
Test Date:	03/09/2020			H (%):	45.4
Test Operator:	OAT			P (hPa):	1011
<div style="text-align: right;"> — FCC/FCC Part 15 §209 Tx - Moyenne/3.0m/ — FCC/FCC Part 15 §209 Tx - QCrête/3.0m/ — Meas.Peak </div> 					
POSITION	FREQUENCIES	RBW	VBW	DETECTOR	
Circular	9kHz-150kHz	300Hz	1kHz	Peak	
Circular	150kHz-1MHz	10kHz	30kHz	Peak	
Circular	1MHz-30MHz	10kHz	30kHz	Peak	
Configuration:	N/A				
Comments:	Limit indicated on these plots are calculated with 40 dB/decade extrapolation factor and 51.5dB conversion factor.				
EUT modification(s): N/A					

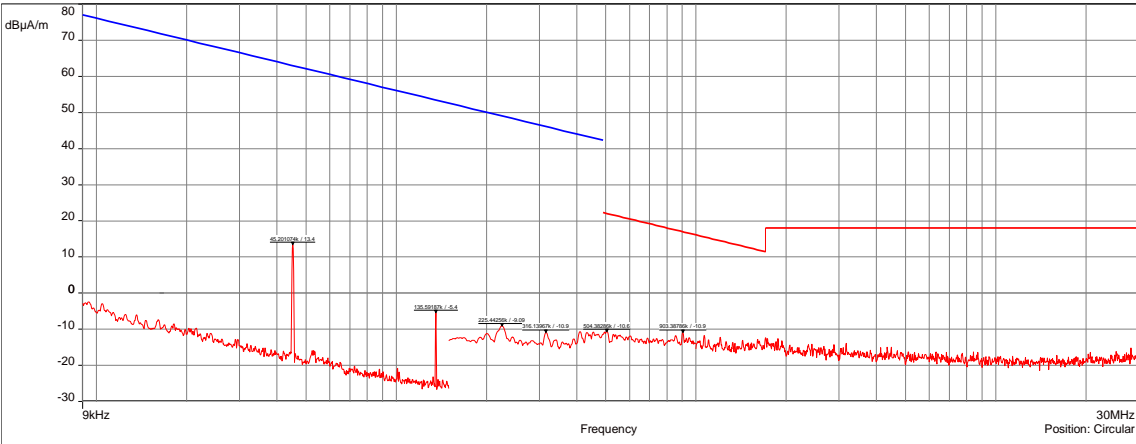
TRANSMITTER RADIATED SPURIOUS EMISSIONS AT FREQUENCIES <30MHZ - GRAPH					
Tx MODE / HIGH FREQ / 90° - POSITION 3				EMI5070	
EUT mode:	Tx mode			T (°C):	22.3
Test Date:	03/09/2020			H (%):	45.4
Test Operator:	OAT			P (hPa):	1011
					
POSITION	FREQUENCIES	RBW	VBW	DETECTOR	
Circular	9kHz-150kHz	300Hz	1kHz	Peak	
Circular	150kHz-1MHz	10kHz	30kHz	Peak	
Circular	1MHz-30MHz	10kHz	30kHz	Peak	
Configuration:	N/A				
Comments:	Limit indicated on these plots are calculated with 40 dB/decade extrapolation factor and 51.5dB conversion factor.				
EUT modification(s): N/A					

8.8. Transmitter radiated spurious emissions at frequencies >30MHz

Reference standard:	FCC part 15 Radio part 15.209 & CNR-Gen
Test method:	FCC part 15.109, 15.209, 15.205, 15.215, CNR-Gen
<p>General test setup: EUT is set on an insulating support at 80cm above the ground reference plane.</p> <p>Preliminary (peak) measurements were performed at an antenna to EUT separation distance of 3-meter. The EUT was rotated 360° about its azimuth with the receive antenna located at various heights in horizontal and vertical polarities.</p> <p>Final measurements (quasi-peak or average) were then performed in a semi-anechoic chamber or Open Area Test Site that complies to CISPR 16. The EUT was rotated 360° about its azimuth and adjusting the receive antenna height from 1 to 4 m.</p> <p>All frequencies were investigated, where applicable.</p> <p>For portable equipments a research of maximum level is done on the 3 axes. Only the highest levels are recorded.</p>	

TESTED CONFIGURATION	PARAMETER	SEVERITY	RESULT TAB.	VERDICT
Tx mode / All Freq - All Positions	30MHz-1GHz	15.209	EMI5120	PASS
Charging + Tx mode / All Positions / All Freq	30MHz-1GHz	15.209	EMI6984	PASS
Tx mode / All Positions / Low channel / 1GHz to 18GHz	1GHz-18GHz	15.209	EMI6749	PASS
Tx mode / All Positions / Mid channel / 1GHz to 18GHz	1GHz-18GHz	15.209	EMI6750	PASS
Tx mode / All Positions / High channel / 1GHz to 18GHz	1GHz-18GHz	15.209	EMI6751	PASS
Charging + Tx mode / All Positions / Low channel / 1GHz to 18GHz	1GHz-18GHz	15.209	EMI7039	PASS
Charging + Tx mode / All Positions / Mid channel / 1GHz to 18GHz	1GHz-18GHz	15.209	EMI7040	PASS
Charging + Tx mode / All Positions / High channel / 1GHz to 18GHz	1GHz-18GHz	15.209	EMI7041	PASS
Tx mode / All Positions / Low channel / 18GHz to 26.5GHz	18GHz-26.5GHz	15.209	EMI6772	PASS
Tx mode / All Positions / Mid channel / 18GHz to 26.5GHz	18GHz-26.5GHz	15.209	EMI6775	PASS
Tx mode / All Positions / High channel / 18GHz to 26.5GHz	18GHz-26.5GHz	15.209	EMI6776	PASS
Charging + Tx mode / All Positions / Low channel / 18GHz to 26.5GHz	18GHz-26.5GHz	15.209	EMI7274	PASS
Charging + Tx mode / All Positions / Mid channel / 18GHz to 26.5GHz	18GHz-26.5GHz	15.209	EMI7275	PASS
Charging + Tx mode / All Positions / High channel / 18GHz to 26.5GHz	18GHz-26.5GHz	15.209	EMI7276	PASS

LABORATORY PARAMETERS:	REQUIRED PRIOR TO THE TEST	DURING THE TEST
Ambient Temperature	15 to 35 °C	See Graph(s)
Relative Humidity	20 to 75 %	See Graph(s)
Atmospheric pressure	N/A	See Graph(s)
Test method deviation: N/A		
Supplementary information: N/A		

TEST EQUIPMENT USED					
CATEGORY	BRAND	TYPE	IDENTIFIER	CAL. DATE	CAL. DUE
Antenna	ETS-Lindgren	3117	5456	24/07/2019	24/09/2022
Antenna	ETS lindgren	3160-09	14690	26/09/2017	26/05/2021
Antenna	Electro Metrics	BIA-30HF	0824	13/06/2018	13/08/2021
Antenna	Rohde & Schwarz	HL223	3126	13/06/2018	13/08/2021
Cable	MegaPhase	F135N1N28	16664	25/10/2019	25/12/2021
Cable	MegaPhase	F135N1N28	16666	25/10/2019	25/12/2021
Cable	JYE BAO	K30K30-5003-40G1	14887	25/06/2019	25/08/2021
Cable	Huber + Suhner	K-5m	14460	25/06/2019	25/08/2021
Cable	C&C	N-1.5m	10554	20/12/2019	20/02/2022
Cable	/	N-1m	3625	27/01/2021	27/03/2023
Cable	/	N-1m	3626	27/01/2021	27/03/2023
Cable	SUCOFLEX	N-3m	14379	25/06/2019	25/08/2021
Cable	MegaPhase	N-3m	14852	29/10/2018	29/12/2020
Cable	MegaPhase	N-3m	14852	30/10/2018	30/06/2021
Cable	SUCOFLEX	N-5,5m	14381	25/06/2019	25/08/2021
Cable	SUCOFLEX	N-6,5m	14380	25/07/2019	25/09/2021
Cable	MegaPhase	N-8m	15813	12/11/2018	12/01/2021
Cable	MegaPhase	N-8m	15813	14/01/2021	14/03/2023
Cable	Huber + Suhner	SF102K	16041	28/02/2019	28/04/2021
Cable	MegaPhase	TM18-N1N1-118	12841	14/08/2020	14/10/2022
Cable	MegaPhase	TM18-N1N1-118	12842	02/12/2020	02/02/2023
Filter	Micro-Tronics	HPM 15162	10273	12/01/2019	12/03/2022
Filter	Micro-Tronics	HPM18865	12843	09/06/2018	09/08/2021
Filter	Wainwright Instruments	WRCGV 2402/2480- 2380/2500- 40/10EE-200W	9771	08/01/2019	08/03/2022
Preamplifier	Techniwave	APS16-0087	14040	02/12/2020	02/02/2022
Preamplifier	Wright Technologie	ASL40-B3015	14851	12/08/2020	12/10/2021
Preamplifier	IMPULSE	CA118-546ACN	9169	13/01/2021	13/03/2022
Preamplifier	Mini-circuit	ZFL-1000LN	1321	25/06/2019	25/02/2021
Receiver	Agilent Technologies	E4440A	5824	22/10/2020	22/12/2022
Receiver	Rohde & Schwarz	ESI	9704	03/03/2020	03/05/2021
Receiver	Rohde & Schwarz	FPL1003	16027	14/08/2020	14/10/2021
Receiver	Rohde & Schwarz	FSW43	14830	29/07/2020	29/09/2021
Shielded enclosure	RAY PROOF	C.V2	1423	04/10/2019	04/12/2022
Shielded enclosure	COMTEST	SAC 3m	14494	02/10/2019	02/12/2022
Software	Nexio		0000		
Thermohygrometer	Testo	608-H1	7562	25/01/2019	25/03/2021
Thermohygrometer	Testo	608-H2	12269	07/05/2020	07/07/2022
Thermohygrometer	Bioblock Scientific	Météostar	0963	25/01/2019	25/03/2021

BAT-EMC software version: V3.18.0.26

Blank cells = Permanent validity

TRANSMITTER RADIATED SPURIOUS EMISSIONS AT FREQUENCIES >30MHZ- TABULATED RESULTS					
CHARGING + TX MODE / ALL POSITIONS / ALL CHANNELS				EMI6984	
Frequency MHz	Polarization	Level peak dB μ V/m	Level Qpeak dB μ V/m	Limit dB μ V/m	Margin dB
37.617	Verticale	35.28	27.33	40	-12.670
37.770	Verticale	34.23	26.91	40	-13.090
37.991	Verticale	33.16	25.49	40	-14.510
38.280	Verticale	32.49	25.14	40	-14.860
38.484	Verticale	33.33	25.87	40	-14.130
38.722	Verticale	34.46	26.39	40	-13.610
39.011	Verticale	34.68	26.23	40	-13.770
39.096	Verticale	36.14	26.40	40	-13.600
39.334	Verticale	35.76	27.08	40	-12.920
39.589	Verticale	36.35	28.12	40	-11.880
39.793	Verticale	36.63	28.64	40	-11.360
40.065	Verticale	37.06	29.26	40	-10.740
40.371	Verticale	38.46	30.48	40	-9.520
40.660	Verticale	39.52	31.75	40	-8.250
40.830	Verticale	40.73	32.30	40	-7.700
40.915	Verticale	40.42	32.73	40	-7.270
41.068	Verticale	40.83	33.20	40	-6.800
41.221	Verticale	41.64	33.96	40	-6.040
41.459	Verticale	43.26	35.26	40	-4.740
41.714	Verticale	44.34	36.65	40	-3.350
41.901	Verticale	44.79	37.19	40	-2.810
42.139	Verticale	44.84	37.38	40	-2.620
42.326	Verticale	44.75	37.12	40	-2.880
42.513	Verticale	43.88	36.73	40	-3.270
42.683	Verticale	42.41	35.83	40	-4.170
42.938	Verticale	40.93	34.99	40	-5.010
43.227	Verticale	42.29	36.34	40	-3.660
43.499	Verticale	41.48	35.00	40	-5.000
43.737	Verticale	40.49	34.23	40	-5.770
43.941	Verticale	40.46	34.79	40	-5.210
44.111	Verticale	41.22	35.14	40	-4.860
44.315	Verticale	41.89	35.87	40	-4.130
44.723	Verticale	41.96	35.46	40	-4.540
45.047	Verticale	41.90	34.95	40	-5.050
45.336	Verticale	41.06	33.95	40	-6.050
45.506	Verticale	39.44	32.73	40	-7.270
45.693	Verticale	39.20	31.85	40	-8.150
45.829	Verticale	38.11	30.75	40	-9.250
46.067	Verticale	36.40	29.51	40	-10.490
46.271	Verticale	36.03	28.89	40	-11.110
68.815	Verticale	31.85	27.45	40	-12.550
68.883	Verticale	31.56	27.47	40	-12.530
68.968	Verticale	31.88	27.47	40	-12.530
69.036	Verticale	32.18	27.50	40	-12.500
69.087	Verticale	31.73	27.50	40	-12.500

TRANSMITTER RADIATED SPURIOUS EMISSIONS AT FREQUENCIES >30MHZ- TABULATED RESULTS					
CHARGING + TX MODE / ALL POSITIONS / ALL CHANNELS				EMI6984	
69.155	Verticale	31.58	27.52	40	-12.480
69.240	Verticale	31.62	27.56	40	-12.440
69.308	Verticale	32.06	27.52	40	-12.480
69.410	Verticale	31.66	27.53	40	-12.470
69.512	Verticale	32.13	27.49	40	-12.510
69.580	Verticale	31.49	27.47	40	-12.530
69.631	Verticale	32.02	27.43	40	-12.570
69.733	Verticale	31.41	27.37	40	-12.630
69.852	Verticale	31.22	27.25	40	-12.750
69.988	Verticale	31.70	27.21	40	-12.790
70.039	Verticale	31.48	27.16	40	-12.840
70.107	Verticale	31.22	27.15	40	-12.850
70.192	Verticale	31.59	27.13	40	-12.870
70.260	Verticale	31.17	27.14	40	-12.860
70.362	Verticale	31.19	27.13	40	-12.870
70.413	Verticale	31.67	27.16	40	-12.840
70.447	Verticale	31.57	27.16	40	-12.840
70.498	Verticale	31.49	27.17	40	-12.830
70.600	Verticale	31.30	27.11	40	-12.890
70.668	Verticale	31.14	27.08	40	-12.920
70.770	Verticale	31.56	27.00	40	-13.000
70.872	Verticale	31.03	26.89	40	-13.110
70.991	Verticale	31.43	26.74	40	-13.260
71.059	Verticale	30.93	26.62	40	-13.380
183.338	Verticale	38.55	32.77	43.5	-10.730
183.559	Verticale	38.66	32.64	43.5	-10.860
183.712	Verticale	38.95	32.58	43.5	-10.920
183.831	Verticale	38.25	32.57	43.5	-10.930
184.001	Verticale	38.89	32.49	43.5	-11.010
184.171	Verticale	39.03	32.34	43.5	-11.160
184.307	Verticale	38.03	32.19	43.5	-11.310
184.426	Verticale	38.09	32.17	43.5	-11.330
184.613	Verticale	38.03	31.95	43.5	-11.550
184.749	Verticale	38.25	31.89	43.5	-11.610
184.919	Verticale	38.37	31.67	43.5	-11.830
185.124	Verticale	37.57	31.44	43.5	-12.060
185.294	Verticale	37.23	31.22	43.5	-12.280
185.396	Verticale	37.31	31.13	43.5	-12.370
185.566	Verticale	36.95	30.92	43.5	-12.580
185.685	Verticale	37.78	30.75	43.5	-12.750
185.889	Verticale	37.39	30.45	43.5	-13.050
186.144	Verticale	36.58	30.23	43.5	-13.270
186.263	Verticale	36.86	30.07	43.5	-13.430
186.467	Verticale	36.24	29.75	43.5	-13.750
186.705	Verticale	36.02	29.48	43.5	-14.020
186.841	Verticale	36.13	29.34	43.5	-14.160
187.130	Verticale	35.99	29.02	43.5	-14.480
187.283	Verticale	35.79	28.87	43.5	-14.630
187.453	Verticale	35.45	28.66	43.5	-14.840

TRANSMITTER RADIATED SPURIOUS EMISSIONS AT FREQUENCIES >30MHZ- TABULATED RESULTS					
CHARGING + TX MODE / ALL POSITIONS / ALL CHANNELS				EMI6984	
187.572	Verticale	35.56	28.47	43.5	-15.030
187.810	Verticale	34.68	28.31	43.5	-15.190
188.065	Verticale	34.59	28.15	43.5	-15.350
188.354	Verticale	34.70	28.02	43.5	-15.480
188.558	Verticale	35.33	27.92	43.5	-15.580
188.745	Verticale	34.67	27.44	43.5	-16.060
188.932	Verticale	34.52	27.62	43.5	-15.880
153.041	Horizontale	32.97	23.92	43.5	-19.580
153.313	Horizontale	33.48	24.11	43.5	-19.390
153.432	Horizontale	33.94	24.18	43.5	-19.320
153.891	Horizontale	34.50	24.73	43.5	-18.770
154.214	Horizontale	35.17	25.41	43.5	-18.090
154.554	Horizontale	36.38	26.22	43.5	-17.280
154.724	Horizontale	36.82	26.75	43.5	-16.750
154.996	Horizontale	36.99	27.55	43.5	-15.950
155.235	Horizontale	37.60	28.12	43.5	-15.380
155.524	Horizontale	38.35	28.92	43.5	-14.580
155.762	Horizontale	38.77	29.44	43.5	-14.060
156.119	Horizontale	38.84	30.23	43.5	-13.270
156.340	Horizontale	39.65	30.75	43.5	-12.750
157.071	Horizontale	39.38	31.59	43.5	-11.910
157.343	Horizontale	38.99	31.76	43.5	-11.740
157.819	Horizontale	38.74	31.91	43.5	-11.590
158.108	Horizontale	38.66	31.88	43.5	-11.620
158.346	Horizontale	38.60	31.94	43.5	-11.560
158.584	Horizontale	37.67	31.95	43.5	-11.550
158.856	Horizontale	38.05	31.88	43.5	-11.620
159.366	Horizontale	37.92	31.82	43.5	-11.680
159.825	Horizontale	37.26	31.72	43.5	-11.780
160.148	Horizontale	36.76	31.48	43.5	-12.020
160.403	Horizontale	36.64	31.45	43.5	-12.050
160.692	Horizontale	36.62	31.19	43.5	-12.310
160.862	Horizontale	36.78	31.02	43.5	-12.480
161.219	Horizontale	36.27	30.68	43.5	-12.820
161.627	Horizontale	36.20	30.35	43.5	-13.150

Spurious which has more than 20 dB of margin compared to the applicable limit is not necessarily reported

TEST SETUP PHOTO(S) – TX MODE / POSITION 1



TEST SETUP PHOTO(S) – TX MODE – POSITION 2



TEST SETUP PHOTO(S) – TX MODE – POSITION 3



TEST SETUP PHOTO(S) – CHARGING + TX MODE – POSITION 1



TEST SETUP PHOTO(S) - CHARGING + TX MODE – POSITION 2



TEST SETUP PHOTO(S) - CHARGING + TX MODE – POSITION 3



TEST SETUP PHOTO(S) – TX MODE – 30MHZ TO 200MHZ



TEST SETUP PHOTO(S) – TX MODE – 200MHZ TO 1GHZ



TEST SETUP PHOTO(S) – TX MODE – 1GHZ TO 18GHZ



TEST SETUP PHOTO(S) - TX MODE / 18GHZ TO 26.5GHZ

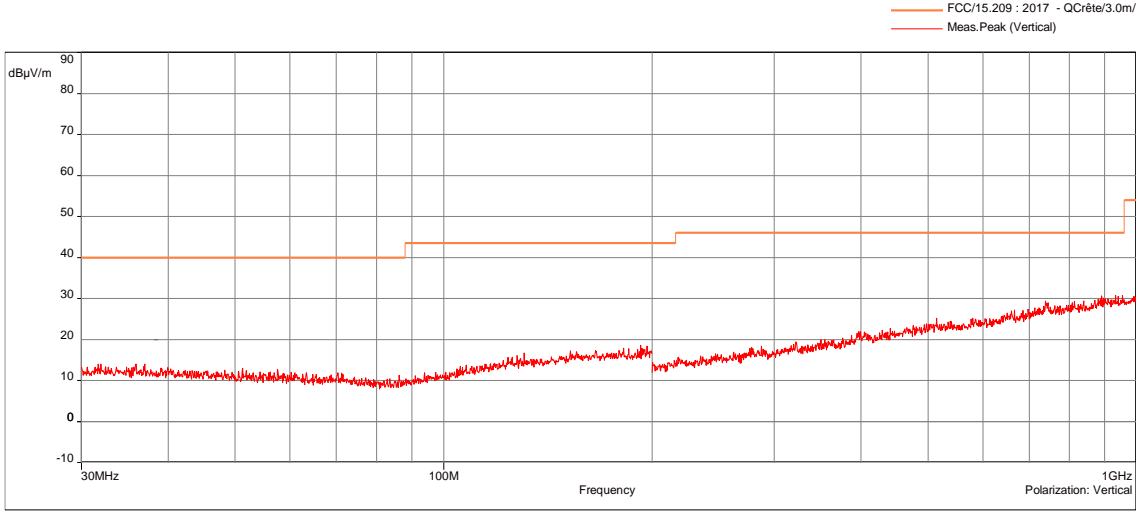
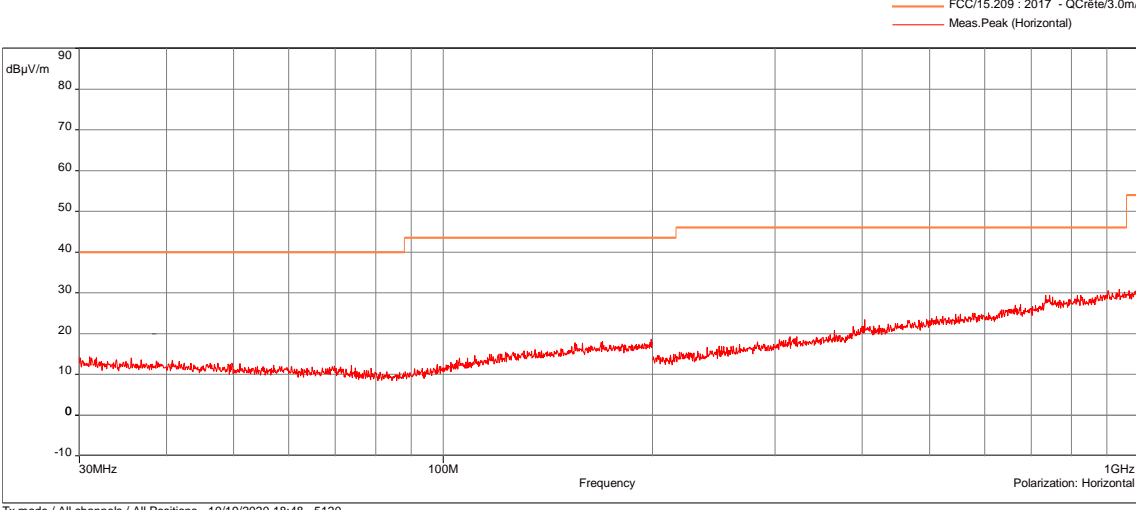

TRANSMITTER RADIATED SPURIOUS EMISSIONS AT FREQUENCIES >30MHz - GRAPH				
TX MODE / ALL CHANNELS / ALL POSITIONS			EMI5120	
EUT mode:	Modulated		T (°C):	23.5
Test Date:	03/09/2020		H (%):	52.6
Test Operator:	OAT		P (hPa):	1015
 <p style="text-align: right;"> — FCC/15.209 : 2017 - QCrête/3.0m/ — Meas.Peak (Vertical) </p> <p>Tx mode / All channels / All Positions - 10/19/2020 18:48 - 5120</p>				
 <p style="text-align: right;"> — FCC/15.209 : 2017 - QCrête/3.0m/ — Meas.Peak (Horizontal) </p> <p>Tx mode / All channels / All Positions - 10/19/2020 18:48 - 5120</p>				
POSITION	FREQUENCIES	RBW	VBW	DETECTOR
Vertical	30MHz-200MHz	100kHz	300kHz	Peak
Horizontal	30MHz-200MHz	100kHz	300kHz	Peak
Vertical	200MHz-1GHz	100kHz	300kHz	Peak
Horizontal	200MHz-1GHz	100kHz	300kHz	Peak
Configuration:	N/A			
Comments:	N/A			
EUT modification(s): N/A				

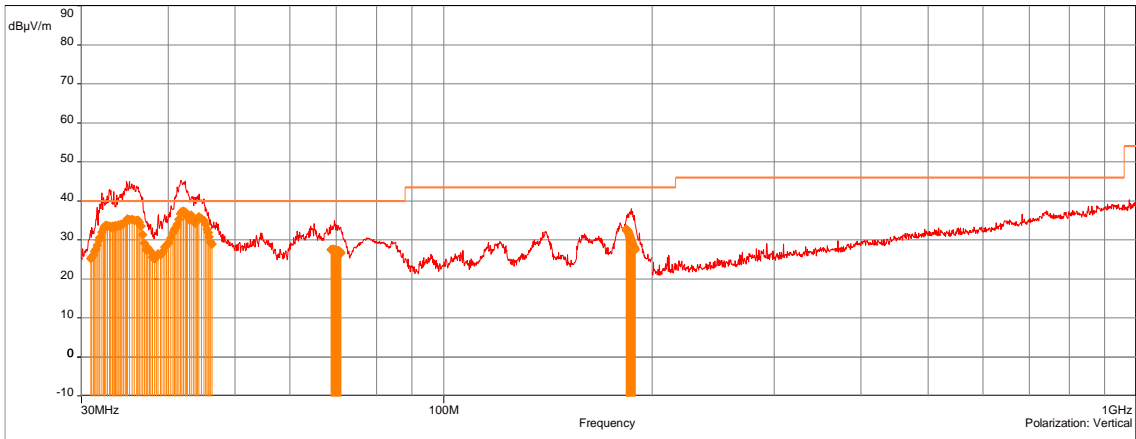
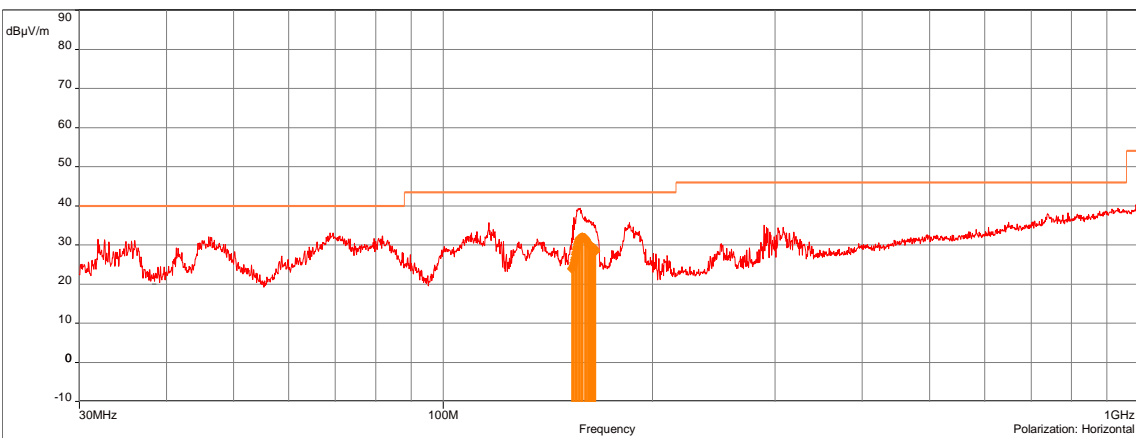
TRANSMITTER RADIATED SPURIOUS EMISSIONS AT FREQUENCIES >30MHz - GRAPH					
CHARGING + Tx MODE / ALL POSITIONS / ALL CHANNELS				EMI6984	
EUT mode:	Modulated			T (°C):	20.5
Test Date:	18/03/2021			H (%):	21.1
Test Operator:	OAT			P (hPa):	1011
<div style="text-align: right;"> <p>— FCC/15.209 : 2017 - QCrête/3.0m/ ◆ Meas.QPeak (Finals 55022) (Vertical) ◆ Meas.QPeak (SR 550xx) (Vertical) — Meas.Peak (Vertical)</p> </div>  <p>Charging + Tx mode / All Positions / All channels - 07/21/2021 13:03 - 6984</p>					
<div style="text-align: right;"> <p>— FCC/15.209 : 2017 - QCrête/3.0m/ ◆ Meas.QPeak (Finals 55022) (Horizontal) ◆ Meas.QPeak (SR 550xx) (Horizontal) — Meas.Peak (Horizontal)</p> </div>  <p>Charging + Tx mode / All Positions / All channels - 07/21/2021 13:03 - 6984</p>					
POSITION	FREQUENCIES	RBW	VBW	DETECTOR	
Vertical	30MHz-200MHz	100kHz	300kHz	Peak	
Horizontal	30MHz-200MHz	100kHz	300kHz	Peak	
Vertical	200MHz-1GHz	100kHz	300kHz	Peak	
Horizontal	200MHz-1GHz	100kHz	300kHz	Peak	
Configuration:	N/A				
Comments:	N/A				
EUT modification(s): N/A					

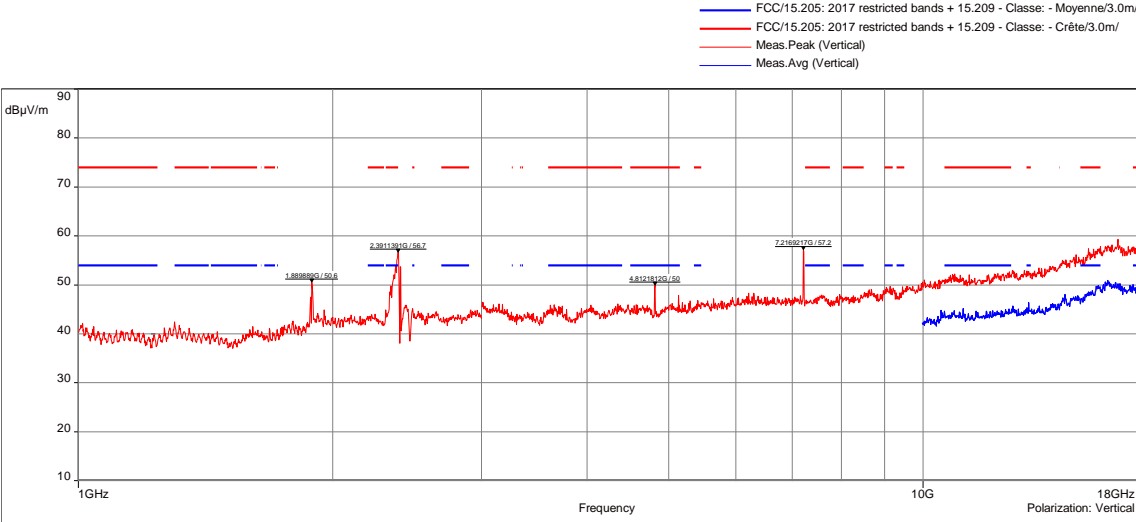
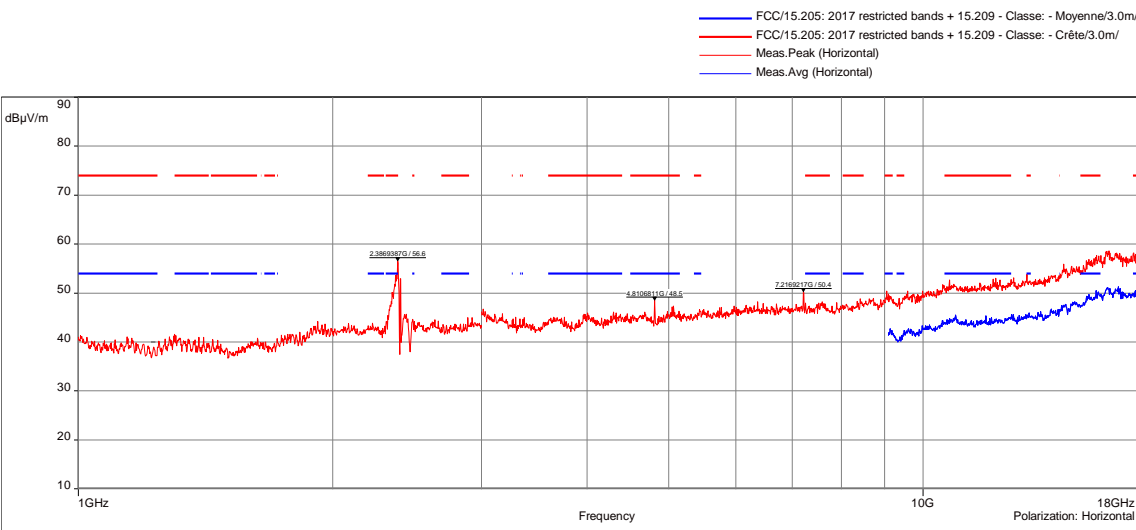
TRANSMITTER RADIATED SPURIOUS EMISSIONS AT FREQUENCIES >30MHZ - GRAPH					
TX MODE / ALL POSITIONS / LOW CHANNEL / 1GHZ TO 18GHZ				EMI6749	
EUT mode:	Modulated			T (°C):	22.1
Test Date:	04/03/2021			H (%):	39.6
Test Operator:	ATO & OAT			P (hPa):	1015
 <p>Legend: - FCC/15.205: 2017 restricted bands + 15.209 - Classe: - Moyenne/3.0m/ - FCC/15.205: 2017 restricted bands + 15.209 - Classe: - Crête/3.0m/ - Meas.Peak (Vertical) - Meas.Avg (Vertical)</p> <p>Frequency: 1GHz to 18GHz Polarization: Vertical</p> <p>Tx mode / All Positions / Low channel / 1GHz to 18GHz - 6749</p>					
 <p>Legend: - FCC/15.205: 2017 restricted bands + 15.209 - Classe: - Moyenne/3.0m/ - FCC/15.205: 2017 restricted bands + 15.209 - Classe: - Crête/3.0m/ - Meas.Peak (Horizontal) - Meas.Avg (Horizontal)</p> <p>Frequency: 1GHz to 18GHz Polarization: Horizontal</p> <p>Tx mode / All Positions / Low channel / 1GHz to 18GHz - 6749</p>					
POSITION	FREQUENCIES	RBW	VBW	DETECTOR	
Vertical	1GHz-3GHz	1MHz	3MHz	Peak	
Horizontal	1GHz-3GHz	1MHz	3MHz	Peak	
Vertical	3GHz-18GHz	1MHz	3MHz	Peak	
Horizontal	3GHz-18GHz	1MHz	3MHz	Peak	
Vertical	10GHz-18GHz	1MHz	50kHz	AVG	
Horizontal	9GHz-18GHz	1MHz	50kHz	AVG	
Configuration:	N/A				
Comments:	N/A				
EUT modification(s): N/A					

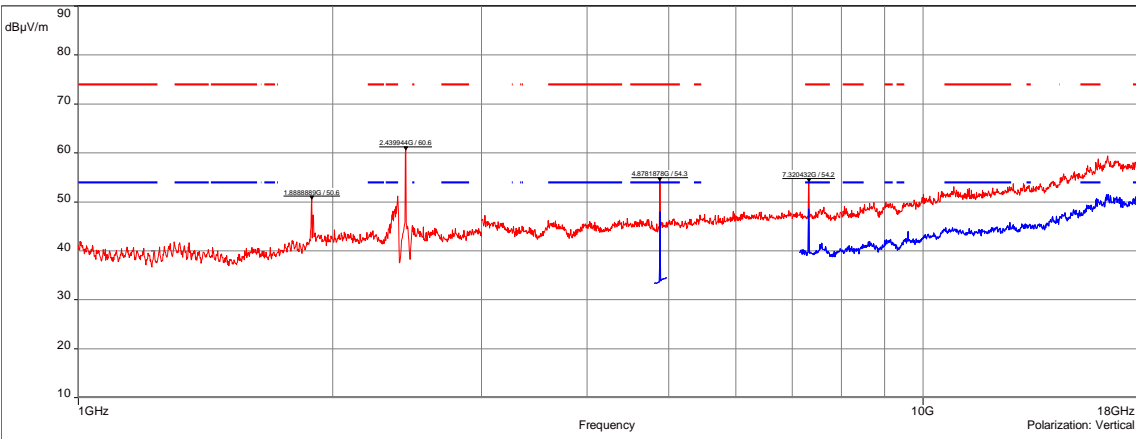
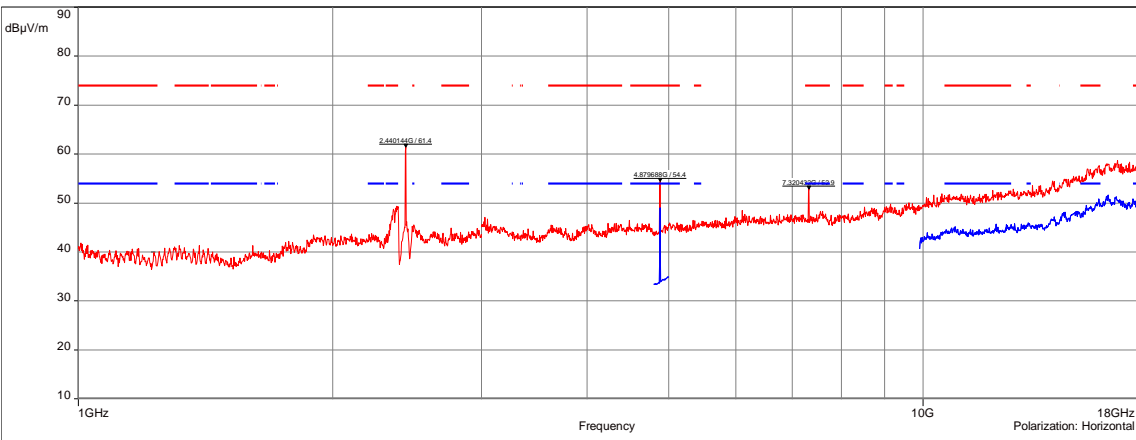
TRANSMITTER RADIATED SPURIOUS EMISSIONS AT FREQUENCIES >30MHz - GRAPH					
TX MODE / ALL POSITIONS / MID CHANNEL / 1GHz TO 18GHz				EMI6750	
EUT mode:	Modulated			T (°C):	22.1
Test Date:	04/03/2021			H (%):	39.6
Test Operator:	ATO & OAT			P (hPa):	1015
<div style="text-align: right;"> <p>— FCC/15.205: 2017 restricted bands + 15.209 - Classe: - Moyenne/3.0m/</p> <p>— FCC/15.205: 2017 restricted bands + 15.209 - Classe: - Crête/3.0m/</p> <p>— Meas.Peak (Vertical)</p> <p>— Meas.Avg (Vertical)</p> </div>  <p>Tx mode / All Positions / Mid channel / 1GHz to 18GHz - 6750</p> <div style="text-align: right;"> <p>— FCC/15.205: 2017 restricted bands + 15.209 - Classe: - Moyenne/3.0m/</p> <p>— FCC/15.205: 2017 restricted bands + 15.209 - Classe: - Crête/3.0m/</p> <p>— Meas.Peak (Horizontal)</p> <p>— Meas.Avg (Horizontal)</p> </div>  <p>Tx mode / All Positions / Mid channel / 1GHz to 18GHz - 6750</p>					
POSITION	FREQUENCIES	RBW	VBW	DETECTOR	
Vertical	1GHz-3GHz	1MHz	3MHz	Peak	
Horizontal	1GHz-3GHz	1MHz	3MHz	Peak	
Vertical	3GHz-18GHz	1MHz	3MHz	Peak	
Horizontal	3GHz-18GHz	1MHz	3MHz	Peak	
Vertical	4.8GHz-4.95GHz	1MHz	50kHz	AVG	
Horizontal	4.8GHz-4.95GHz	1MHz	50kHz	AVG	
Vertical	7GHz-18GHz	1MHz	50kHz	AVG	
Horizontal	10GHz-18GHz	1MHz	50kHz	AVG	
Configuration:	N/A				
Comments:	N/A				
EUT modification(s): N/A					

TRANSMITTER RADIATED SPURIOUS EMISSIONS AT FREQUENCIES >30MHZ - GRAPH			
TX MODE / ALL POSITIONS / HIGH CHANNEL / 1GHZ TO 18GHZ			EMI6751
EUT mode:	Modulated		T (°C): 22.1
Test Date:	04/03/2021		H (%): 39.6
Test Operator:	ATO & OAT		P (hPa): 1015

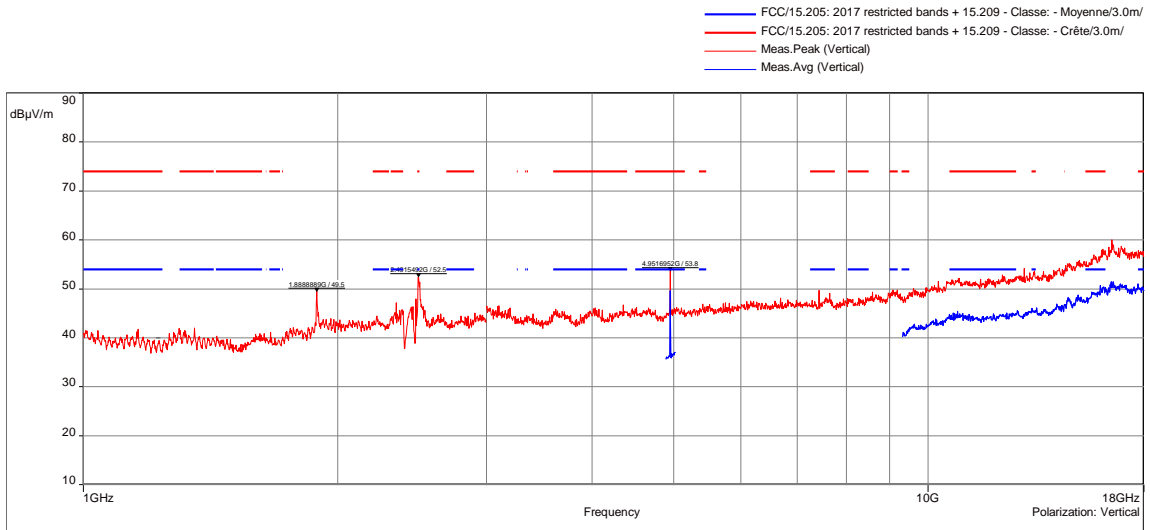

Tx mode / All Positions / High channel / 1GHz to 18GHz - 6751

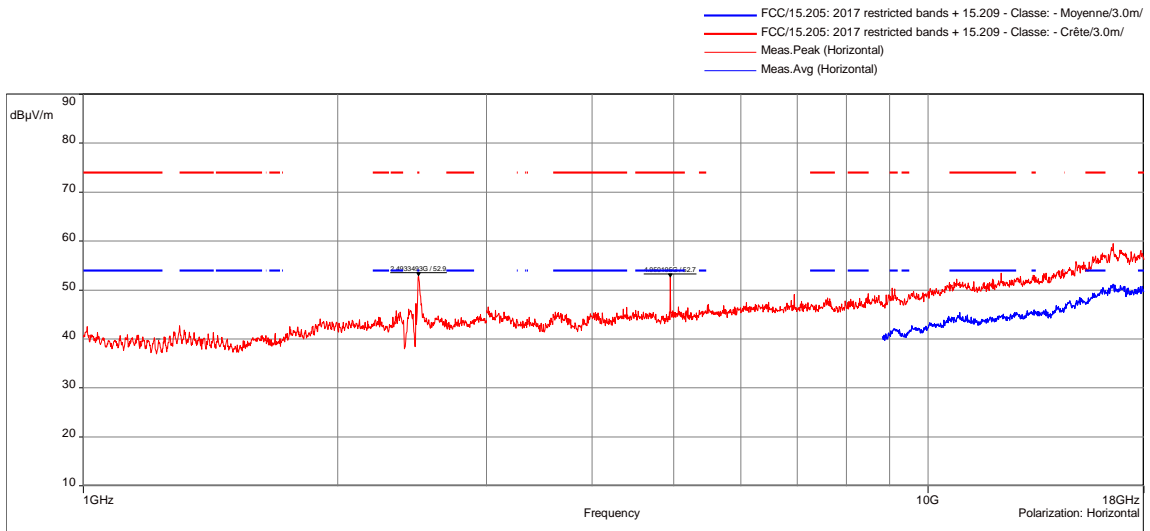

Tx mode / All Positions / High channel / 1GHz to 18GHz - 6751

POSITION	FREQUENCIES	RBW	VBW	DETECTOR
Vertical	1GHz-3GHz	1MHz	3MHz	Peak
Horizontal	1GHz-3GHz	1MHz	3MHz	Peak
Vertical	3GHz-18GHz	1MHz	3MHz	Peak
Horizontal	3GHz-18GHz	1MHz	3MHz	Peak
Vertical	4.8GHz-5.1GHz	1MHz	50kHz	AVG
Vertical	9GHz-18GHz	1MHz	50kHz	AVG
Horizontal	9GHz-18GHz	1MHz	50kHz	AVG

Configuration:	N/A
Comments:	N/A

EUT modification(s): N/A

TRANSMITTER RADIATED SPURIOUS EMISSIONS AT FREQUENCIES >30MHz - GRAPH					
CHARGING + TX MODE / ALL POSITIONS / LOW CHANNEL / 1GHz TO 18GHz				EMI7039	
EUT mode:	Modulated			T (°C):	23.4
Test Date:	23/03/2021			H (%):	22.4
Test Operator:	ATO & OAT			P (hPa):	1012
<p>Charging + Tx mode / All Positions / Low channel / 1GHz to 18GHz - 7039</p>					
<p>Charging + Tx mode / All Positions / Low channel / 1GHz to 18GHz - 7039</p>					
POSITION	FREQUENCIES	RBW	VBW	DETECTOR	
Vertical	1GHz-3GHz	1MHz	3MHz	Peak	
Horizontal	1GHz-3GHz	1MHz	3MHz	Peak	
Vertical	3GHz-18GHz	1MHz	3MHz	Peak	
Horizontal	3GHz-18GHz	1MHz	3MHz	Peak	
Vertical	10GHz-18GHz	1MHz	50kHz	Peak	
Horizontal	10GHz-18GHz	1MHz	50kHz	Peak	
Configuration:	N/A				
Comments:	N/A				
EUT modification(s): N/A					

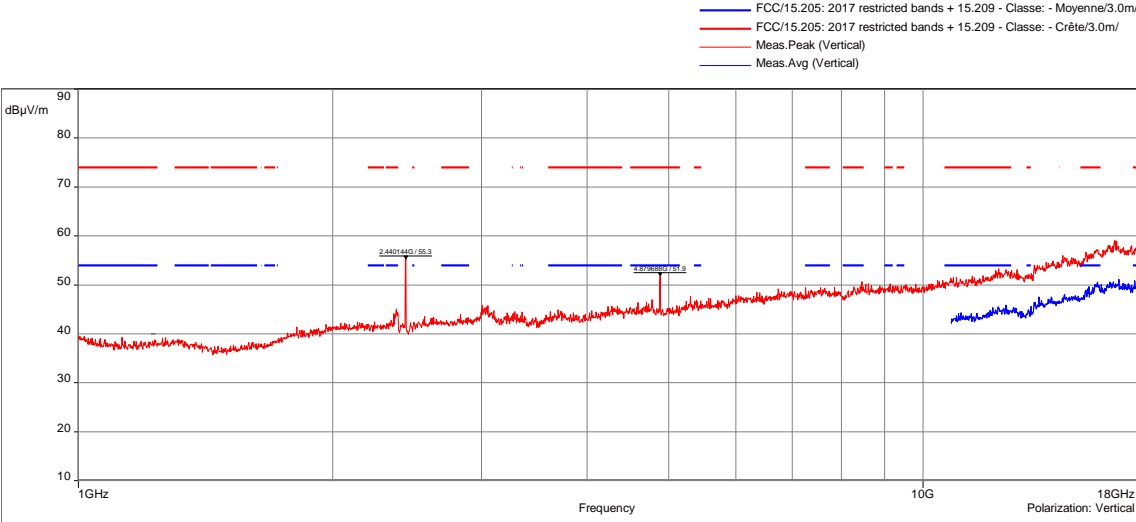
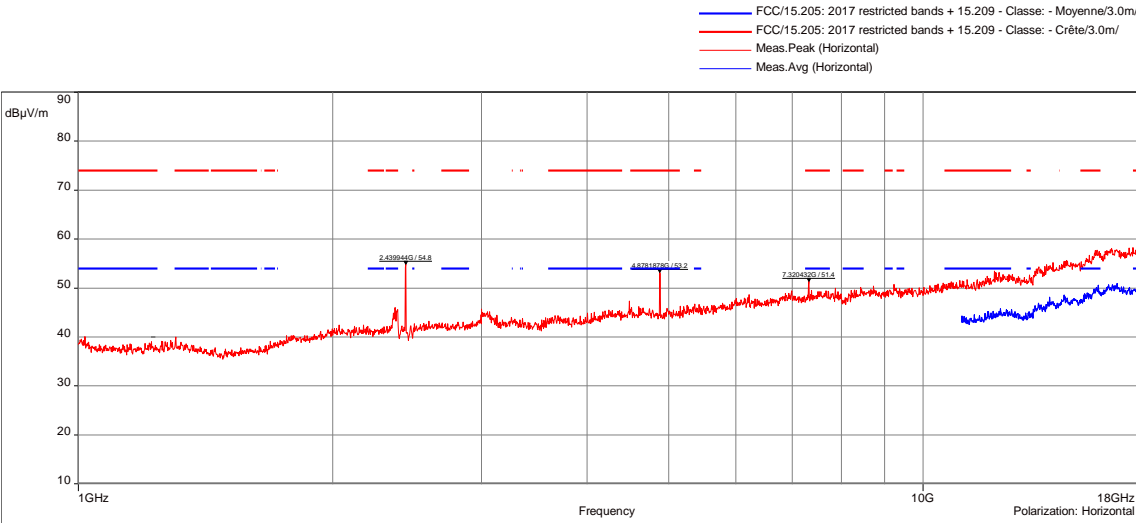
TRANSMITTER RADIATED SPURIOUS EMISSIONS AT FREQUENCIES >30MHZ - GRAPH					
CHARGING + Tx MODE / ALL POSITIONS / MID CHANNEL / 1GHZ TO 18GHZ				EMI7040	
EUT mode:	Modulated			T (°C):	23.4
Test Date:	23/03/2021			H (%):	22.4
Test Operator:	ATO & OAT			P (hPa):	1012
 <p>Charging + Tx mode / All Positions / Mid channel / 1GHz to 18GHz - 7040</p>					
 <p>Charging + Tx mode / All Positions / Mid channel / 1GHz to 18GHz - 7040</p>					
POSITION	FREQUENCIES	RBW	VBW	DETECTOR	
Vertical	1GHz-3GHz	1MHz	3MHz	Peak	
Horizontal	1GHz-3GHz	1MHz	3MHz	Peak	
Vertical	3GHz-18GHz	1MHz	3MHz	Peak	
Horizontal	3GHz-18GHz	1MHz	3MHz	Peak	
Vertical	10GHz-18GHz	1MHz	50MHz	AVG	
Horizontal	10GHz-18GHz	1MHz	50MHz	AVG	
Configuration:	N/A				
Comments:	N/A				
EUT modification(s): N/A					

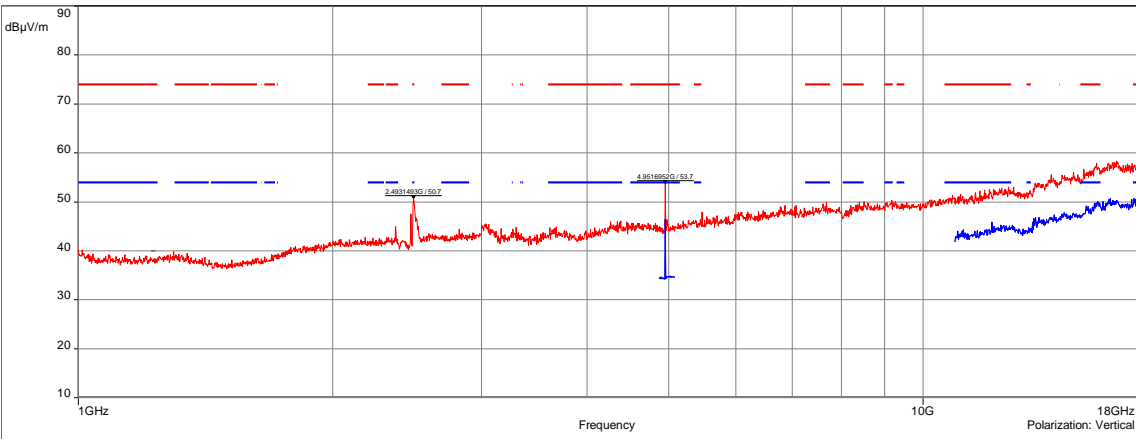
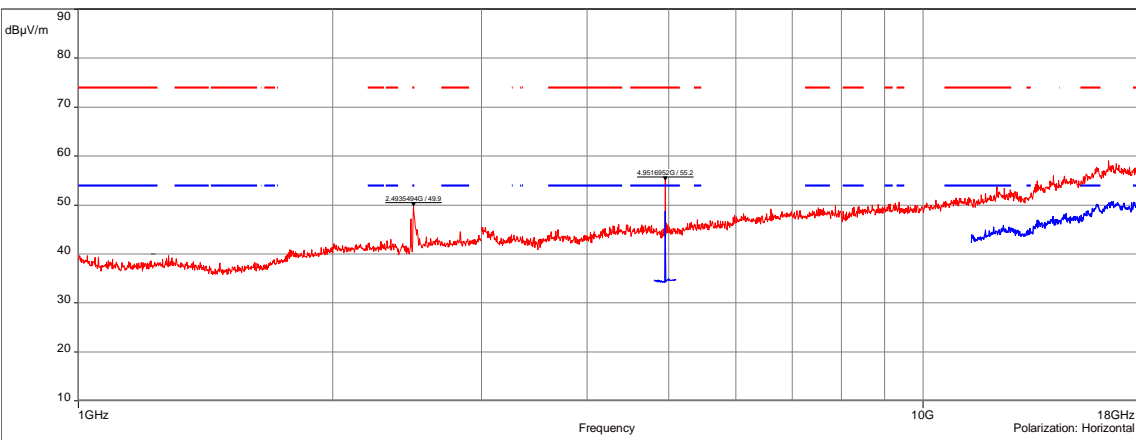
TRANSMITTER RADIATED SPURIOUS EMISSIONS AT FREQUENCIES >30MHZ - GRAPH					
CHARGING + TX MODE / ALL POSITIONS / HIGH CHANNEL / 1GHZ TO 18GHZ				EMI7041	
EUT mode:	Modulated			T (°C):	23.4
Test Date:	23/03/2021			H (%):	22.4
Test Operator:	ATO & OAT			P (hPa):	1012
<div style="text-align: right;"> <p>— FCC/15.205: 2017 restricted bands + 15.209 - Classe: - Moyenne/3.0m/</p> <p>— FCC/15.205: 2017 restricted bands + 15.209 - Classe: - Crête/3.0m/</p> <p>— Meas.Peak (Vertical)</p> <p>— Meas.Avg (Vertical)</p> </div>  <p>Charging + Tx mode / All Positions / High channel / 1GHz to 18GHz - 7041</p>					
<div style="text-align: right;"> <p>— FCC/15.205: 2017 restricted bands + 15.209 - Classe: - Moyenne/3.0m/</p> <p>— FCC/15.205: 2017 restricted bands + 15.209 - Classe: - Crête/3.0m/</p> <p>— Meas.Peak (Horizontal)</p> <p>— Meas.Avg (Horizontal)</p> </div>  <p>Charging + Tx mode / All Positions / High channel / 1GHz to 18GHz - 7041</p>					
POSITION	FREQUENCIES	RBW	VBW	DETECTOR	
Vertical	1GHz-3GHz	1MHz	3MHz	Peak	
Horizontal	1GHz-3GHz	1MHz	3MHz	Peak	
Vertical	3GHz-18GHz	1MHz	3MHz	Peak	
Horizontal	3GHz-18GHz	1MHz	3MHz	Peak	
Vertical	4.8GHz-5.2GHz	1MHz	50kHz	AVG	
Vertical	10GHz-18GHz	1MHz	50kHz	AVG	
Horizontal	4.8GHz-5.2GHz	1MHz	50kHz	AVG	
Horizontal	10GHz-18GHz	1MHz	50kHz	AVG	
Configuration:	N/A				
Comments:	N/A				
EUT modification(s): N/A					

TRANSMITTER RADIATED SPURIOUS EMISSIONS AT FREQUENCIES >30MHz - GRAPH			
TX MODE / ALL POSITIONS / LOW CHANNEL / 18GHz TO 26.5GHz			EMI6772
EUT mode:	Modulated		T (°C): 23.8
Test Date:	05/03/2021		H (%): 35.7
Test Operator:	ATO & OAT		P (hPa): 1009

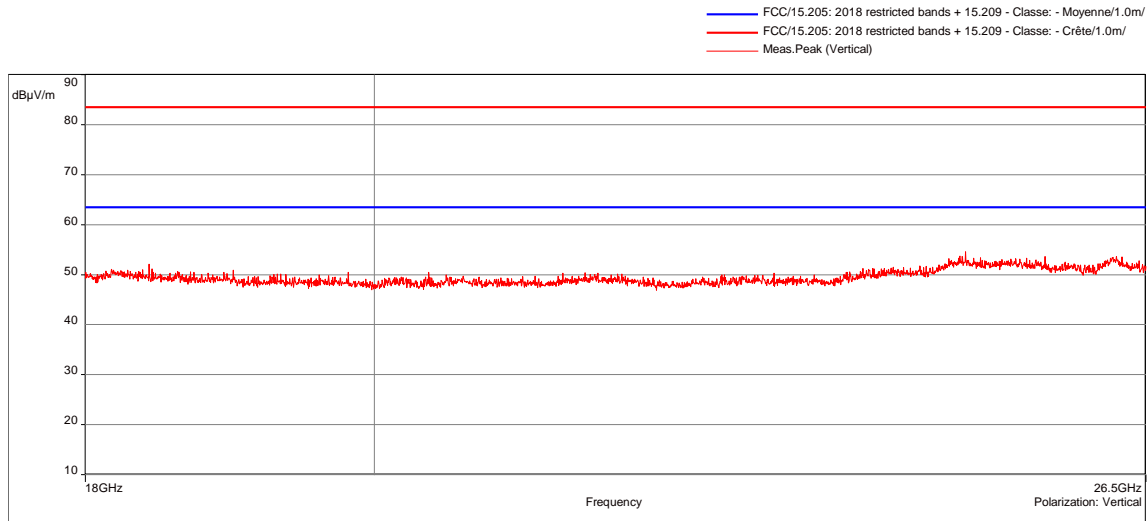

Tx mode / All Positions / Low channel / 18GHz to 26.5GHz - 6772

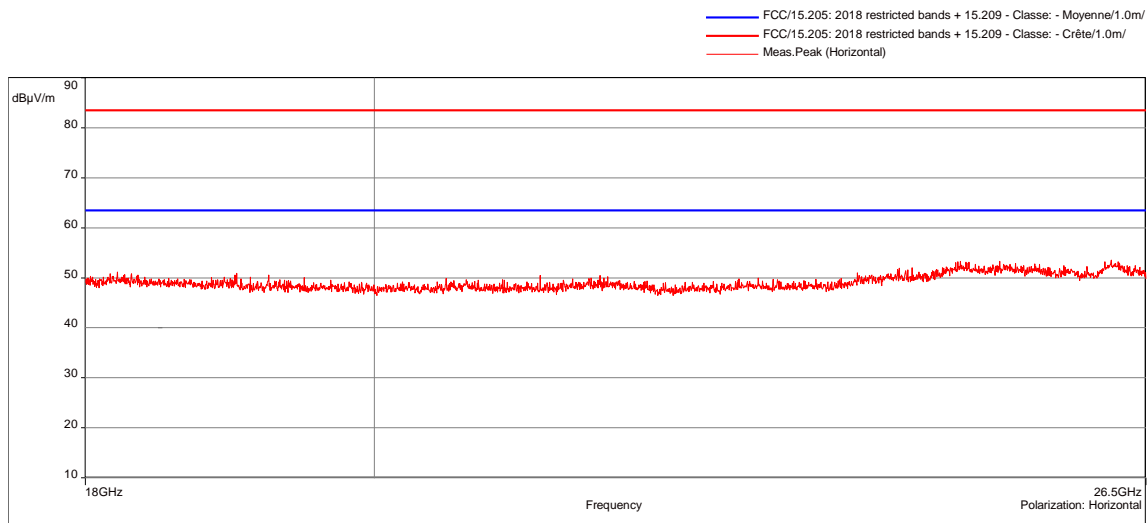

Tx mode / All Positions / Low channel / 18GHz to 26.5GHz - 6772

POSITION	FREQUENCIES	RBW	VBW	DETECTOR
Vertical	18GHz-26.5GHz	1MHz	3MHz	Peak
Horizontal	18GHz-26.5GHz	1MHz	3MHz	Peak

Configuration: N/A

Comments: N/A

EUT modification(s): N/A

No spurious emissions were detected.

TRANSMITTER RADIATED SPURIOUS EMISSIONS AT FREQUENCIES >30MHZ - GRAPH			
TX MODE / ALL POSITIONS / MID CHANNEL / 18GHZ TO 26.5GHZ			EMI6775
EUT mode:	Modulated		T (°C): 23.8
Test Date:	05/03/2021		H (%): 35.7
Test Operator:	ATO & OAT		P (hPa): 1009

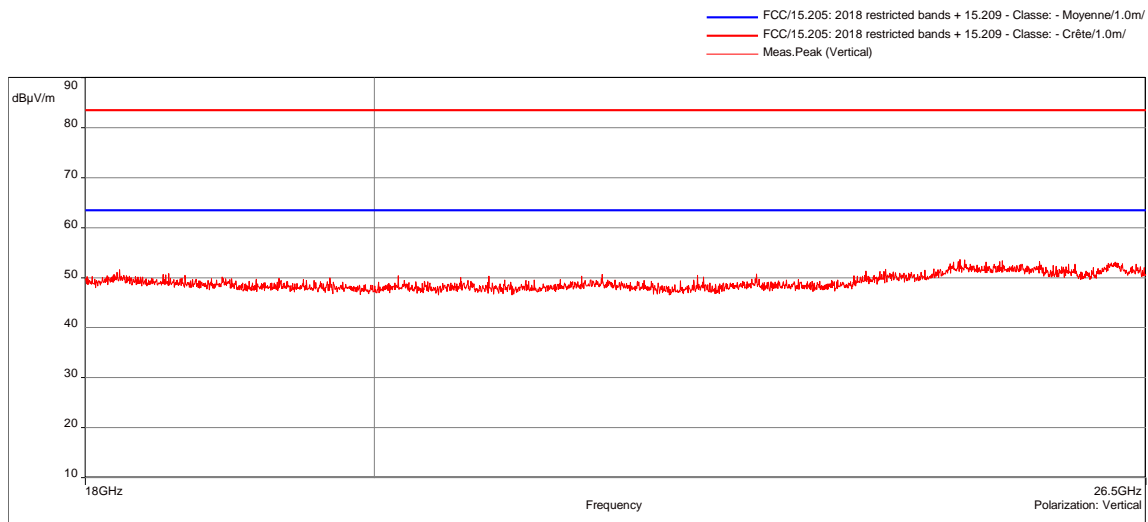

Tx mode / All Positions / Mid channel / 18GHz to 26.5GHz - 6775

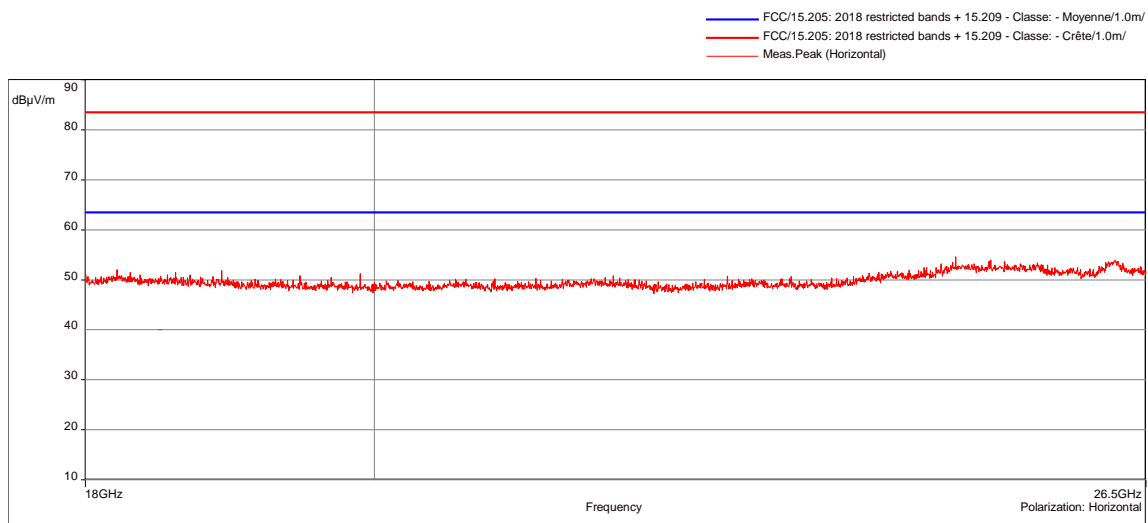

Tx mode / All Positions / Mid channel / 18GHz to 26.5GHz - 6775

POSITION	FREQUENCIES	RBW	VBW	DETECTOR
Vertical	18GHz-26.5GHz	1MHz	3MHz	Peak
Horizontal	18GHz-26.5GHz	1MHz	3MHz	Peak

Configuration: N/A

Comments: N/A

EUT modification(s): N/A

No spurious emissions were detected.

TRANSMITTER RADIATED SPURIOUS EMISSIONS AT FREQUENCIES >30MHz - GRAPH			
TX MODE / ALL POSITIONS / HIGH CHANNEL / 18GHz TO 26.5GHz			EMI6776
EUT mode:	Modulated		T (°C): 23.8
Test Date:	05/03/2021		H (%): 35.7
Test Operator:	ATO & OAT		P (hPa): 1009

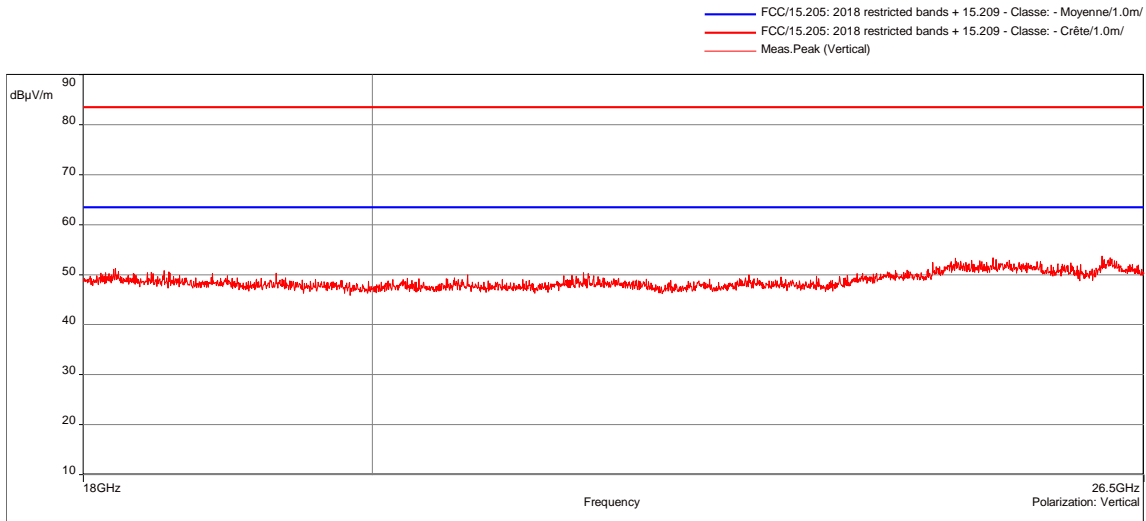

Tx mode / All Positions / High channel / 18GHz to 26.5GHz - 6776

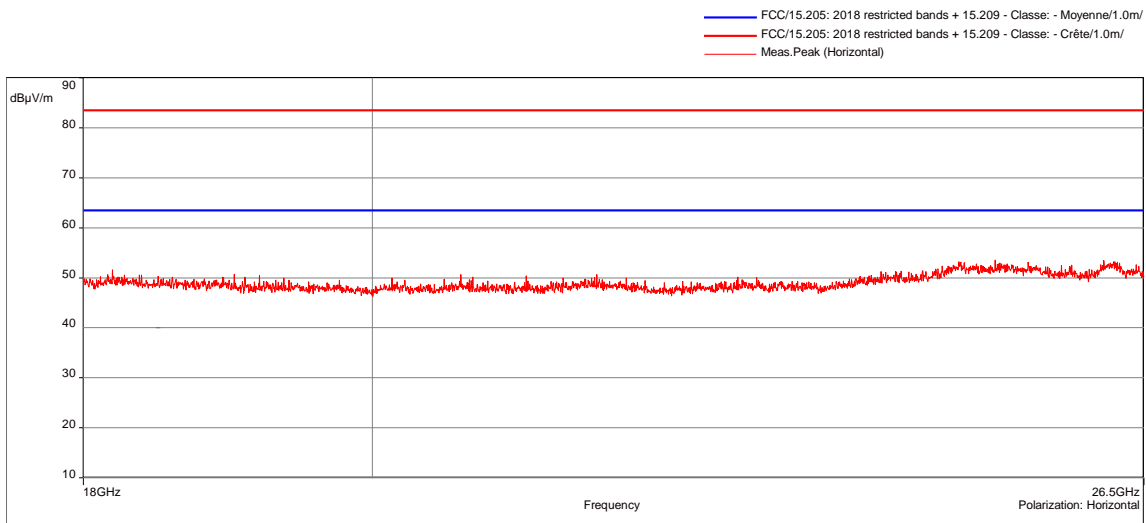

Tx mode / All Positions / High channel / 18GHz to 26.5GHz - 6776

POSITION	FREQUENCIES	RBW	VBW	DETECTOR
Vertical	18GHz-26.5GHz	1MHz	3MHz	Peak
Horizontal	18GHz-26.5GHz	1MHz	3MHz	Peak

Configuration: N/A

Comments: N/A

EUT modification(s): N/A

No spurious emissions were detected.

TRANSMITTER RADIATED SPURIOUS EMISSIONS AT FREQUENCIES >30MHz - GRAPH			
CHARGING + Tx MODE / ALL POSITIONS / LOW CHANNEL / 18GHz TO 26.5GHz			EMI7274
EUT mode:	Modulated		T (°C): 23.8
Test Date:	05/03/2021		H (%): 35.7
Test Operator:	ATO & OAT		P (hPa): 1009

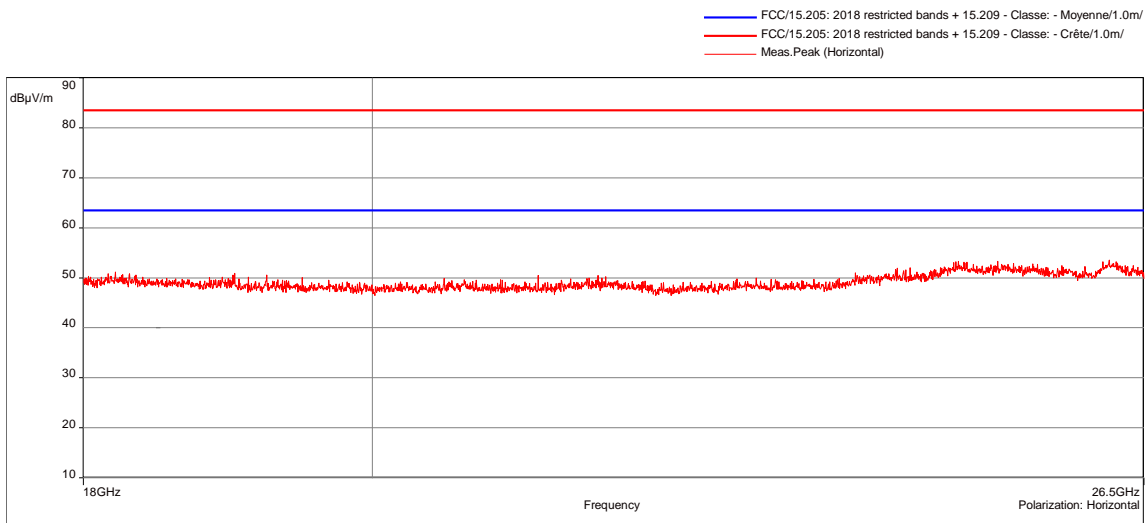
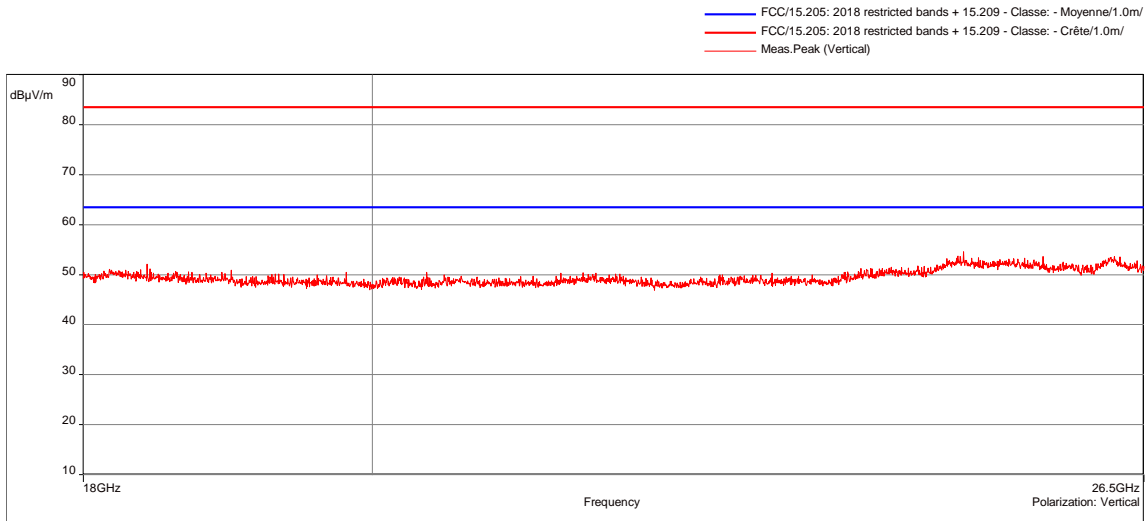

POSITION	FREQUENCIES	RBW	VBW	DETECTOR
Vertical	18GHz-26.5GHz	1MHz	3MHz	Peak
Horizontal	18GHz-26.5GHz	1MHz	3MHz	Peak

Configuration: N/A

Comments: N/A

EUT modification(s): N/A

No spurious emissions were detected.

TRANSMITTER RADIATED SPURIOUS EMISSIONS AT FREQUENCIES >30MHZ - GRAPH			
CHARGING + Tx MODE / ALL POSITIONS / MID CHANNEL / 18GHZ TO 26.5GHZ			EMI7275
EUT mode:	Modulated		T (°C): 23.8
Test Date:	05/03/2021		H (%): 35.7
Test Operator:	ATO & OAT		P (hPa): 1009

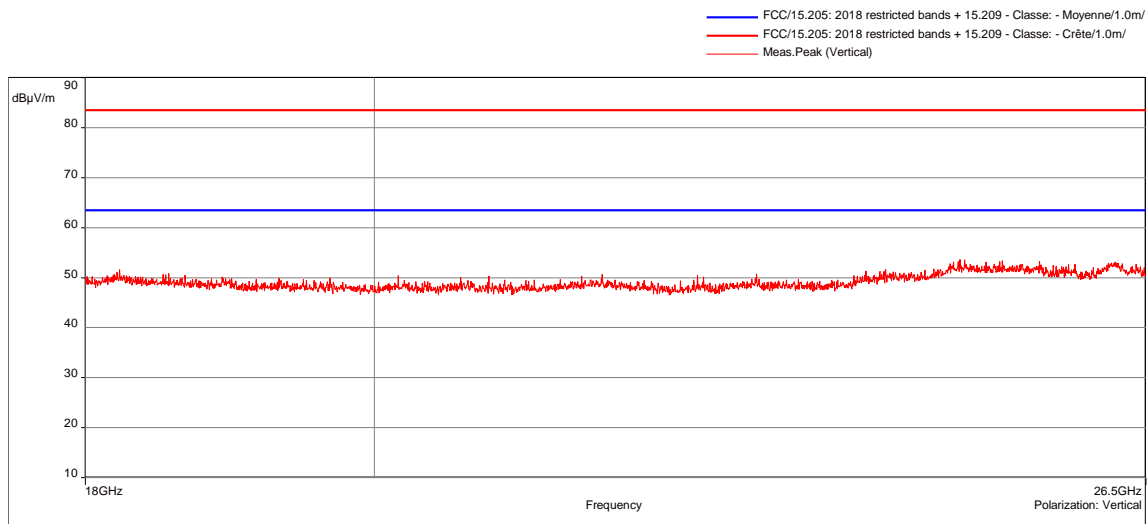

Charging + Tx mode / All Positions / Mid channel / 18GHz to 26.5GHz - 7275

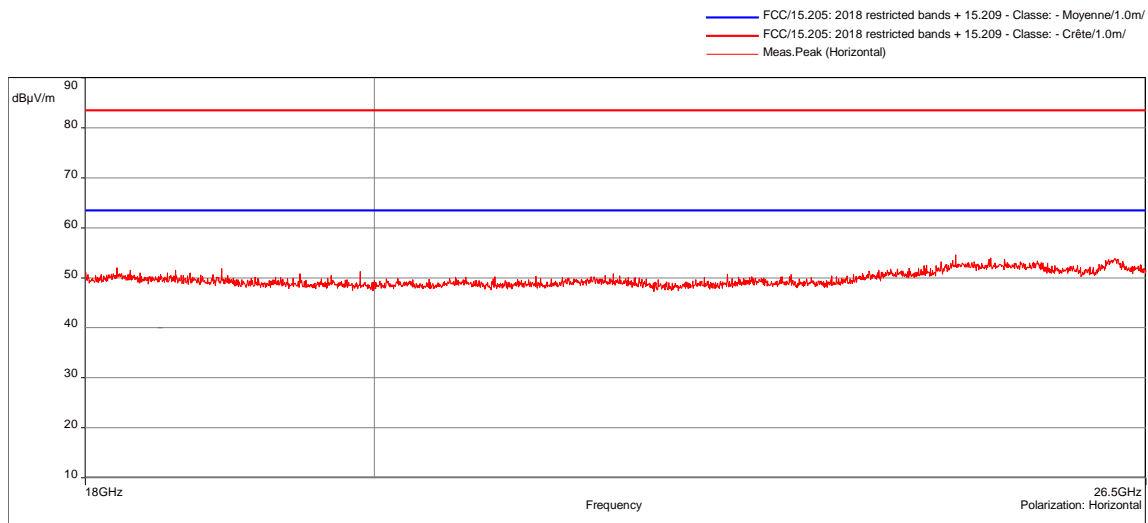

Charging + Tx mode / All Positions / Mid channel / 18GHz to 26.5GHz - 7275

POSITION	FREQUENCIES	RBW	VBW	DETECTOR
Vertical	18GHz-26.5GHz	1MHz	3MHz	Peak
Horizontal	18GHz-26.5GHz	1MHz	3MHz	Peak

Configuration: N/A

Comments: N/A

EUT modification(s): N/A

No spurious emissions were detected.

TRANSMITTER RADIATED SPURIOUS EMISSIONS AT FREQUENCIES >30MHZ - GRAPH			
CHARGING + TX MODE / ALL POSITIONS / HIGH CHANNEL / 18GHZ TO 26.5GHZ			EMI7276
EUT mode:	Modulated		T (°C): 23.8
Test Date:	05/03/2021		H (%): 35.7
Test Operator:	ATO & OAT		P (hPa): 1009

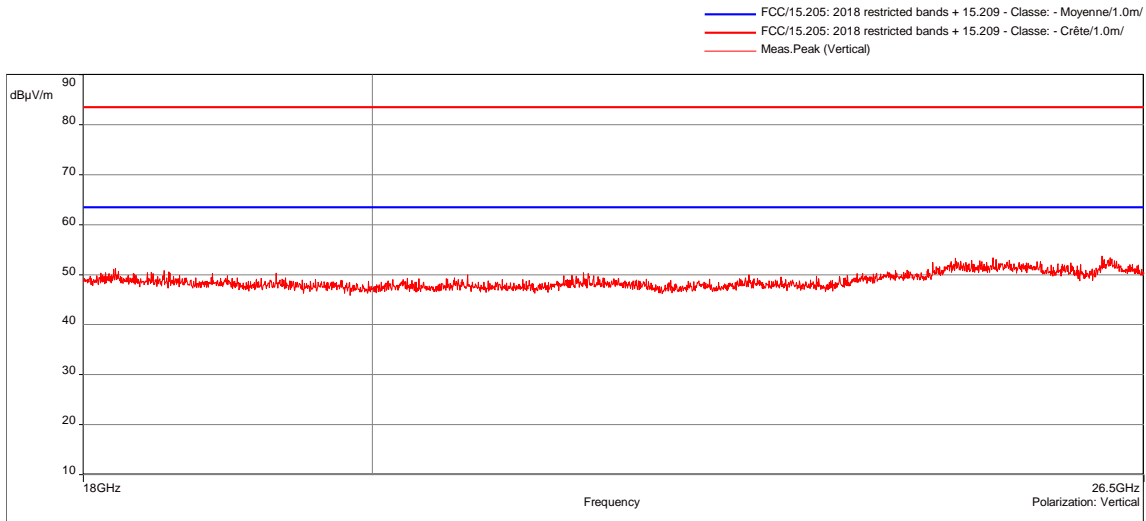

Charging + Tx mode / All Positions / High channel / 18GHz to 26.5GHz - 7276

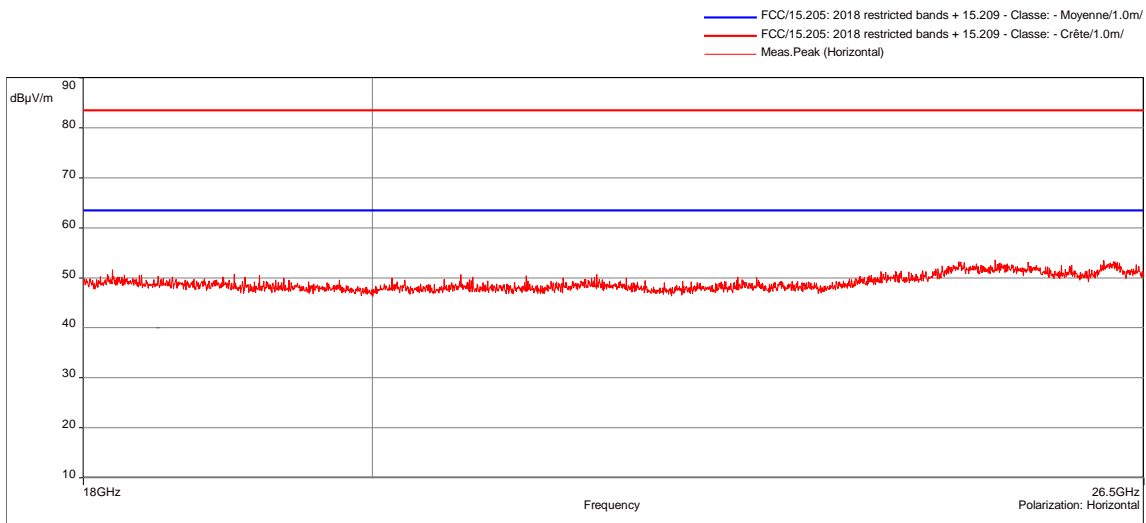

Charging + Tx mode / All Positions / High channel / 18GHz to 26.5GHz - 7276

POSITION	FREQUENCIES	RBW	VBW	DETECTOR
Vertical	18GHz-26.5GHz	1MHz	3MHz	Peak
Horizontal	18GHz-26.5GHz	1MHz	3MHz	Peak

Configuration: N/A

Comments: N/A

EUT modification(s): N/A

No spurious emissions were detected.

8.9. Radiated spurious emissions (receiver)

Reference standard:	FCC part 15 Radio part 15.209 & CNR-Gen
Test method:	FCC part 15.109, 15.209, 15.205, 15.215, CNR-Gen
<p>General test setup: EUT is set on an insulating support at 80cm above the ground reference plane. Measurement are done on a normalized test site by the substitution method.</p> <p>The test antenna is oriented in the two polarizations (vertical and horizontal), and the product is rotated at 360° in the horizontal plane (See photo(s) for initial position of the EUT(0°)). If applicable the test antenna was raised and lowered through the specified range of height until a maximum signal level is detected.</p> <p>For portable equipments a research of maximum level is done on the 3 axes. Only the highest levels are recorded.</p>	

TESTED CONFIGURATION	PARAMETER	SEVERITY	RESULT TAB.	VERDICT
Rx mode / All Positions / All channels/ For freq <1GHz	30MHz-1GHz	15.209	EMI6981	PASS
Charging + Rx mode / All Positions / All channels	30MHz-1GHz	15.209	EMI6978	PASS
Rx mode / All Positions / All channels / 1GHz to 18GHz	1GHz-18GHz	15.209	EMI7022	PASS
Charging + Rx mode / All Positions / All channels / 1GHz to 18GHz	1GHz-18GHz	15.209	EMI7029	PASS
Rx mode / All Positions / All channels / 18GHz to 26.5GHz	18GHz-26.5GHz	15.209	EMI7302	PASS
Charging + Rx mode / All Positions / All channels / 18GHz to 26.5GHz	18GHz-26.5GHz	15.209	EMI7307	PASS

LABORATORY PARAMETERS:	REQUIRED PRIOR TO THE TEST	DURING THE TEST
Ambient Temperature	15 to 35 °C	See Graph(s)
Relative Humidity	20 to 75 %	See Graph(s)
Atmospheric pressure	N/A	See Graph(s)
Test method deviation: N/A		
Supplementary information: N/A		

TEST EQUIPMENT USED					
CATEGORY	BRAND	TYPE	IDENTIFIER	CAL. DATE	CAL. DUE
Antenna	ETS-Lindgren	3117	5456	24/07/2019	24/09/2022
Antenna	ETS lindgren	3160-09	14690	26/09/2017	26/11/2021
Antenna	Electro Metrics	BIA-30HF	0824	13/06/2018	13/08/2021
Antenna	Rohde & Schwarz	HL223	3126	13/06/2018	13/08/2021
Cable	MegaPhase	F135N1N28	16664	25/10/2019	25/12/2021
Cable	MegaPhase	F135N1N28	16666	25/10/2019	25/12/2021
Cable	JYE BAO	K30K30-5003-40G1	14887	25/06/2019	25/08/2021
Cable	Huber + Suhner	K-5m	14460	25/06/2019	25/08/2021
Cable	/	N-1m	3625	27/01/2021	27/03/2023
Cable	SUCOFLEX	N-5,5m	14381	25/06/2019	25/08/2021
Cable	SUCOFLEX	N-6,5m	14380	25/07/2019	25/09/2021
Cable	MegaPhase	N-8m	15813	14/01/2021	14/03/2023
Cable	Huber + Suhner	SF102K	16041	28/02/2019	28/04/2021
Cable	Huber + Suhner	SF102K	16042	24/03/2021	24/05/2023
Cable	MegaPhase	TM18-N1N1-118	12841	14/08/2020	14/10/2022
Cable	MegaPhase	TM18-N1N1-118	12842	02/12/2020	02/02/2023
Preamplifier	Wright Technologie	ASL40-B3015	14851	12/08/2020	12/10/2021
Preamplifier	IMPULSE	CA118-546ACN	9169	13/01/2021	13/03/2022
Receiver	Agilent Technologies	E4440A	5824	22/10/2020	22/12/2022
Receiver	Rohde & Schwarz	ESI	9704	03/03/2020	03/05/2021
Receiver	Rohde & Schwarz	FSW43	14830	29/07/2020	29/09/2021
Shielded enclosure	RAY PROOF	C.V2	1423	04/10/2019	04/12/2022
Shielded enclosure	COMTEST	SAC 3m	14494	02/10/2019	02/12/2022
Software	Nexio		0000		
Thermohygrometer	Testo	608-H1	7562	25/01/2019	25/03/2021
Thermohygrometer	Testo	608-H2	12268	07/05/2020	07/07/2022
Thermohygrometer	Testo	608-H2	12269	07/05/2020	07/07/2022
Thermohygrometer	Bioblock Scientific	Météostar	0963	25/01/2019	25/03/2021
Thermohygrometer	Bioblock Scientific	Météostar	0963	26/01/2019	26/09/2021

BAT-EMC software version: V3.18.0.26

Blank cells = Permanent validity

RADIATED SPURIOUS EMISSIONS (RECEIVER)- TABULATED RESULTS					
CHARGING + TX MODE / ALL POSITIONS / ALL CHANNELS				EMI6978	
Frequency MHz	Polarization	Level peak dB μ V/m	Level Qpeak dB μ V/m	Limit dB μ V/m	Margin dB
30.068	Vertical	36.86	29.7	40	-10.3
30.119	Vertical	37.26	29.63	40	-10.37
30.238	Vertical	37.28	29.6	40	-10.4
30.255	Vertical	37.26	29.71	40	-10.29
30.391	Vertical	37.99	30.84	40	-9.16
30.544	Vertical	39.21	30.69	40	-9.31
30.629	Vertical	39.17	30.98	40	-9.02
30.748	Vertical	39.71	32.61	40	-7.39
30.867	Vertical	39.94	32.18	40	-7.82
30.901	Vertical	39.93	31.85	40	-8.15
30.969	Vertical	39.66	31.42	40	-8.58
31.139	Vertical	39.45	32.2	40	-7.8
31.377	Vertical	38.41	31.48	40	-8.52
31.564	Vertical	37.91	32.26	40	-7.74
31.632	Vertical	37.88	32.39	40	-7.61
31.853	Vertical	38.3	32.25	40	-7.75
32.057	Vertical	38.51	32.69	40	-7.31
32.448	Vertical	38.69	32.68	40	-7.32
32.499	Vertical	38.37	32.79	40	-7.21
32.686	Vertical	39.7	33.77	40	-6.23
32.805	Vertical	39.44	33.42	40	-6.58
32.941	Vertical	40.01	33.58	40	-6.42
33.060	Vertical	40.47	33.98	40	-6.02
33.128	Vertical	40.49	33.84	40	-6.16
33.264	Vertical	39.55	33.54	40	-6.46
33.519	Vertical	40.26	33.99	40	-6.01
33.536	Vertical	40.24	33.89	40	-6.11
33.587	Vertical	39.98	33.88	40	-6.12
33.723	Vertical	40.91	34.88	40	-5.12
33.825	Vertical	40.91	35.06	40	-4.94
33.944	Vertical	40.11	34.77	40	-5.23
34.301	Vertical	41.15	35.86	40	-4.14
34.318	Vertical	41.62	35.86	40	-4.14
34.471	Vertical	42.51	36.59	40	-3.41
34.658	Vertical	42.2	36.55	40	-3.45
34.760	Vertical	42.64	37.43	40	-2.57
34.879	Vertical	42.63	37.6	40	-2.4
34.964	Vertical	42.64	37.25	40	-2.75
35.152	Vertical	42.16	37.53	40	-2.47
35.254	Vertical	42.43	37.98	40	-2.02
35.577	Vertical	42.01	37.83	40	-2.17
35.594	Vertical	42.11	37.71	40	-2.29
35.849	Vertical	41.39	37.17	40	-2.83
35.917	Vertical	41.45	37.25	40	-2.75
36.223	Vertical	40.51	36.28	40	-3.72

RADIATED SPURIOUS EMISSIONS (RECEIVER)- TABULATED RESULTS					
CHARGING + TX MODE / ALL POSITIONS / ALL CHANNELS				EMI6978	
36.495	Vertical	39.36	34.58	40	-5.42
36.733	Vertical	37.37	32.14	40	-7.86
37.039	Vertical	34.56	28.77	40	-11.23
37.226	Vertical	33.72	28.51	40	-11.49
37.311	Vertical	34	28.2	40	-11.8
37.498	Vertical	33.22	27.54	40	-12.46
37.634	Vertical	33.49	27.48	40	-12.52
37.787	Vertical	32.53	26.66	40	-13.34
37.872	Vertical	32.51	26.42	40	-13.58
37.974	Vertical	32.08	25.62	40	-14.38
38.025	Vertical	31.06	25.25	40	-14.75
38.331	Vertical	31.4	25.72	40	-14.28
38.535	Vertical	31.7	25.83	40	-14.17
38.739	Vertical	32.7	25.98	40	-14.02
38.994	Vertical	32.68	25.96	40	-14.04
39.181	Vertical	33.81	26.07	40	-13.93
39.385	Vertical	34.07	27.26	40	-12.74
39.623	Vertical	34.59	28.14	40	-11.86
39.844	Vertical	34.7	29.5	40	-10.5
39.963	Vertical	36.21	30.94	40	-9.06
40.150	Vertical	37.53	31.91	40	-8.09
40.405	Vertical	39.59	35.22	40	-4.78
40.592	Vertical	41.14	36.21	40	-3.79
40.864	Vertical	42.21	37.44	40	-2.56
40.881	Vertical	42.23	37.6	40	-2.4
40.966	Vertical	42.47	38.35	40	-1.65
41.187	Vertical	43.08	38.48	40	-1.52
41.272	Vertical	43.02	38.41	40	-1.59
41.493	Vertical	43.24	38.72	40	-1.28
41.595	Vertical	43.01	38.37	40	-1.63
41.612	Vertical	42.76	38.34	40	-1.66
41.765	Vertical	42.41	37.68	40	-2.32
41.884	Vertical	41.89	36.97	40	-3.03
41.935	Vertical	41.57	36.87	40	-3.13
42.088	Vertical	40.93	36.64	40	-3.36
42.275	Vertical	40.19	35.33	40	-4.67
42.411	Vertical	39.19	34.49	40	-5.51
42.479	Vertical	38.85	34.34	40	-5.66
42.615	Vertical	38.28	33.71	40	-6.29
42.751	Vertical	37.24	32.92	40	-7.08
42.819	Vertical	37.44	32.58	40	-7.42
42.989	Vertical	36.78	31.77	40	-8.23
43.159	Vertical	36.93	32.21	40	-7.79
43.397	Vertical	35.29	30.31	40	-9.69
43.754	Vertical	33.99	29.08	40	-10.92
43.839	Vertical	33.91	29.01	40	-10.99
43.992	Vertical	33.89	28.91	40	-11.09
44.179	Vertical	33.62	28.64	40	-11.36
44.298	Vertical	33.43	28.83	40	-11.17

RADIATED SPURIOUS EMISSIONS (RECEIVER)- TABULATED RESULTS					
CHARGING + TX MODE / ALL POSITIONS / ALL CHANNELS				EMI6978	
44.502	Vertical	32.36	27.25	40	-12.75
44.519	Vertical	32.67	27.05	40	-12.95
44.604	Vertical	33.02	26.73	40	-13.27
44.689	Vertical	32.01	26.82	40	-13.18
44.842	Vertical	31.63	25.79	40	-14.21
44.859	Vertical	32.19	25.93	40	-14.07
45.251	Vertical	31.03	24.88	40	-15.12
45.268	Vertical	30.87	24.82	40	-15.18
45.863	Vertical	29.62	23.91	40	-16.09
45.948	Vertical	29.8	23.79	40	-16.21
46.271	Vertical	29.78	23.84	40	-16.16
46.730	Vertical	29.49	23.39	40	-16.61
46.883	Vertical	29.53	23.71	40	-16.29
47.206	Vertical	30.59	23.71	40	-16.29

TEST SETUP PHOTO(S) – RX MODE / POSITION 1



TEST SETUP PHOTO(S) – RX MODE – POSITION 2



TEST SETUP PHOTO(S) – RX MODE – POSITION 3



TEST SETUP PHOTO(S) – CHARGING + RX MODE – POSITION 1



TEST SETUP PHOTO(S) - CHARGING + RX MODE – POSITION 2



TEST SETUP PHOTO(S) - CHARGING + RX MODE – POSITION 3



TEST SETUP PHOTO(S) – RX MODE – 30MHZ TO 200MHZ



TEST SETUP PHOTO(S) – RX MODE – 200MHZ TO 1GHZ



TEST SETUP PHOTO(S) – RX MODE – 1GHZ TO 18GHZ



TEST SETUP PHOTO(S) - RX MODE / 18GHZ TO 26.5GHZ



RADIATED SPURIOUS EMISSIONS (RECEIVER) - GRAPH					
RX MODE / ALL POSITIONS / ALL CHANNELS / FOR FREQ <1GHZ				EMI6981	
EUT mode:	Rx mode			T (°C):	21.2
Test Date:	18/03/2021			H (%):	23.2
Test Operator:	ATO & OAT			P (hPa):	1011
<p>The graph shows radiated spurious emissions for vertical polarization. The y-axis is dBμV/m from -10 to 90. The x-axis is Frequency from 30MHz to 1GHz. A blue line represents the FCC/15.109: 2017 B - Moyenne/3.0m/ limit, which is a step function starting at 40 dBμV/m and increasing to 55 dBμV/m. An orange line represents the FCC/15.109: 2017 B - QCrête/3.0m/ limit, which is a step function starting at 20 dBμV/m and increasing to 40 dBμV/m. A red line represents the Meas.Peak (Vertical) measurement, which stays below the orange limit line. A legend in the top right corner identifies the lines.</p>					
<p>The graph shows radiated spurious emissions for horizontal polarization. The axes and limits are the same as the vertical graph. The red line represents the Meas.Peak (Horizontal) measurement, which stays below the orange limit line. A legend in the top right corner identifies the lines.</p>					
POSITION	FREQUENCIES	RBW	VBW	DETECTOR	
Vertical	30MHz-200MHz	100kHz	300kHz	Peak	
Horizontal	30MHz-200MHz	100kHz	300kHz	Peak	
Vertical	200MHz-1GHz	100kHz	300kHz	Peak	
Horizontal	200MHz-1GHz	100kHz	300kHz	Peak	
Configuration:	N/A				
Comments:	N/A				
EUT modification(s): N/A					

No spurious emissions were detected.

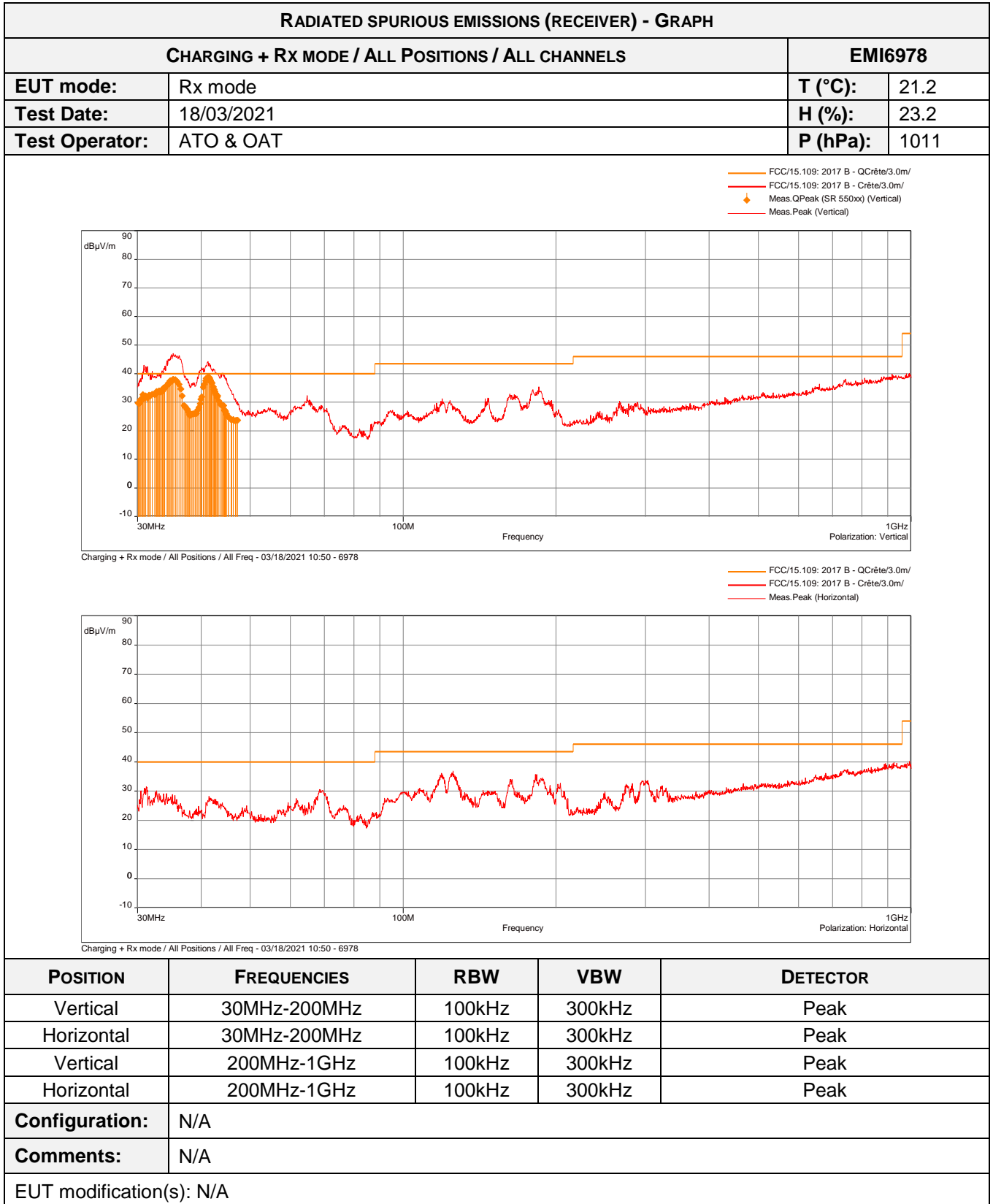

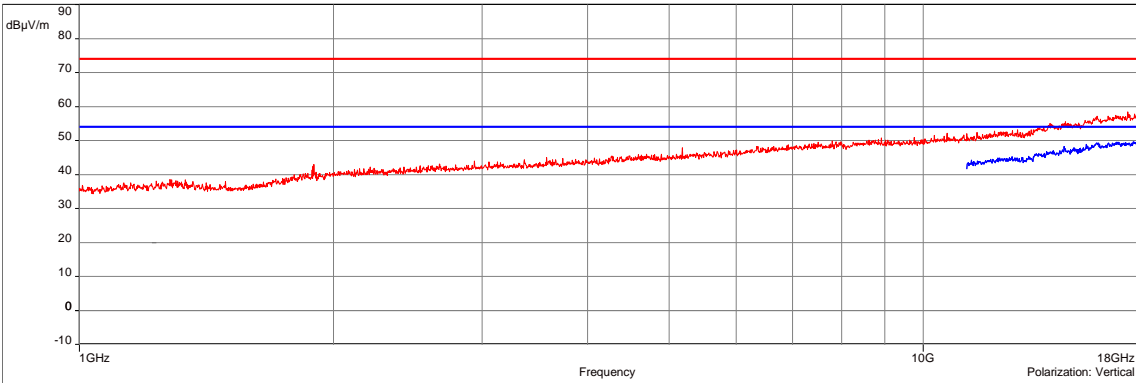
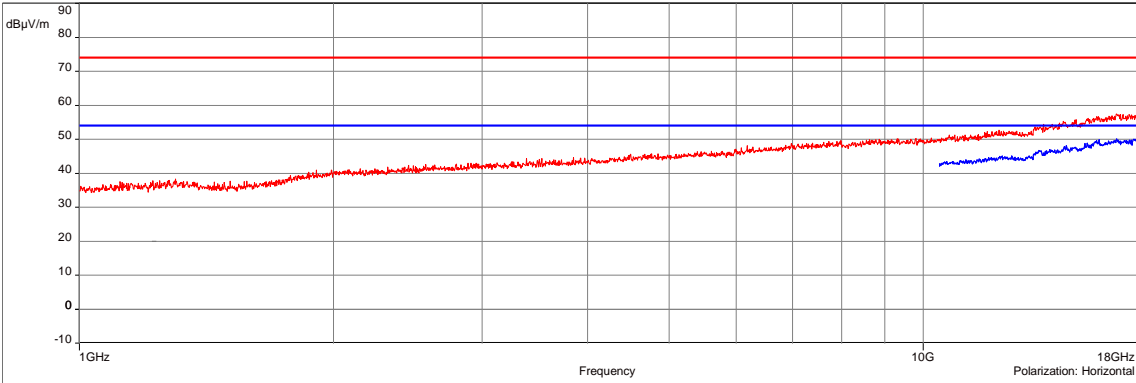
RADIATED SPURIOUS EMISSIONS (RECEIVER) - GRAPH					
RX MODE / ALL POSITIONS / ALL CHANNELS / 1GHZ TO 18GHZ				EMI7022	
EUT mode:	Rx mode			T (°C):	24.2
Test Date:	22/03/2021			H (%):	20.0
Test Operator:	ATO & OAT			P (hPa):	1006
<div style="display: flex; justify-content: space-between;"> <div style="width: 60%;"> <p>Sub-range 1 Frequencies: 1 GHz - 18 GHz (Analyser mode) 15000 Points Settings: RBW: 1MHz, VBW: 3MHz, Auto, Attenuation: 10 dB, Sweep count 1, Preamp: Off, LN Preamp: Off, Preselector: Off Polarization: Vertical Distance: 3 m</p> </div> <div style="width: 35%; font-size: small;"> <ul style="list-style-type: none"> — FCC/15.109: 2017 B - Moyenne/3.0m/ — FCC/15.109: 2017 B - QCrête/3.0m/ — FCC/15.109: 2017 B - Crête/3.0m/ — Meas.Peak (Vertical) — Meas.Avg (Vertical) </div> </div>  <p style="font-size: x-small; margin-top: 5px;">Rx mode / All Positions / All channels / 1GHz to 18GHz - 07/21/2021 13:37 - 7022</p>					
<div style="display: flex; justify-content: space-between;"> <div style="width: 60%;"> <p>Sub-range 2 Frequencies: 1 GHz - 18 GHz (Analyser mode) 15000 Points Settings: RBW: 1MHz, VBW: 3MHz, Auto, Attenuation: 10 dB, Sweep count 1, Preamp: Off, LN Preamp: Off, Preselector: Off Polarization: Horizontal Distance: 3 m</p> </div> <div style="width: 35%; font-size: small;"> <ul style="list-style-type: none"> — FCC/15.109: 2017 B - Moyenne/3.0m/ — FCC/15.109: 2017 B - QCrête/3.0m/ — FCC/15.109: 2017 B - Crête/3.0m/ — Meas.Peak (Horizontal) — Meas.Avg (Horizontal) </div> </div>  <p style="font-size: x-small; margin-top: 5px;">Rx mode / All Positions / All channels / 1GHz to 18GHz - 07/21/2021 13:37 - 7022</p>					
POSITION	FREQUENCIES	RBW	VBW	DETECTOR	
Vertical	1GHz-18GHz	1MHz	3MHz	Peak	
Horizontal	1GHz-18GHz	1MHz	3MHz	Peak	
Vertical	10GHz-18GHz	1MHz	3MHz	AVG	
Horizontal	10GHz-18GHz	1MHz	3MHz	AVG	
Configuration:	N/A				
Comments:	N/A				
EUT modification(s): N/A					

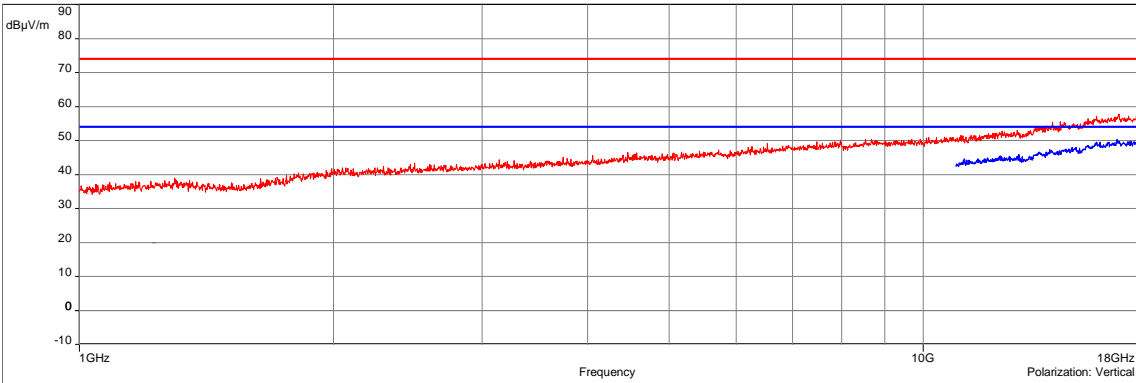
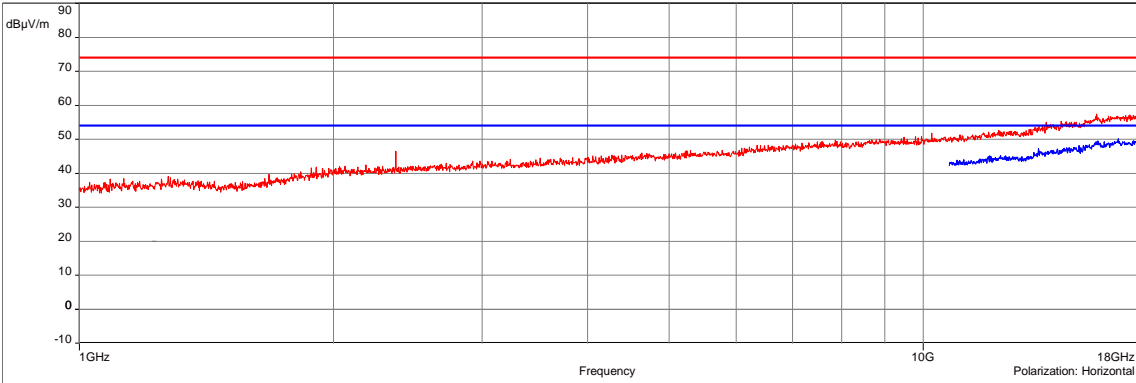
RADIATED SPURIOUS EMISSIONS (RECEIVER) - GRAPH					
CHARGING + RX MODE / ALL POSITIONS / ALL CHANNELS / 1GHZ TO 18GHZ				EMI7029	
EUT mode:	Rx mode			T (°C):	20.0
Test Date:	23/03/2021			H (%):	23.5
Test Operator:	ATO & OAT			P (hPa):	1012
<p>Sub-range 1 Frequencies: 1 GHz - 18 GHz (Analyser mode) 15000 Points Settings: RBW: 1MHz, VBW: 3MHz, Auto, Attenuation: 10 dB, Sweep count 1, Preamp: Off, LN Preamp: Off, Preselector: Off Polarization:Vertical Distance: 3 m</p>  <p>Charging + Rx mode / All Positions / All channels / 1GHz to 18GHz - 03/23/2021 09:21 - 7029</p>					
<p>Sub-range 2 Frequencies: 1 GHz - 18 GHz (Analyser mode) 15000 Points Settings: RBW: 1MHz, VBW: 3MHz, Auto, Attenuation: 10 dB, Sweep count 1, Preamp: Off, LN Preamp: Off, Preselector: Off Polarization:Horizontal Distance: 3 m</p>  <p>Charging + Rx mode / All Positions / All channels / 1GHz to 18GHz - 03/23/2021 09:21 - 7029</p>					
POSITION	FREQUENCIES	RBW	VBW	DETECTOR	
Vertical	1GHz-18GHz	1MHz	3MHz	Peak	
Horizontal	1GHz-18GHz	1MHz	3MHz	Peak	
Vertical	10GHz-18GHz	1MHz	50kHz	AVG	
Horizontal	10GHz-18GHz	1MHz	50kHz	AVG	
Configuration:	N/A				
Comments:	N/A				
EUT modification(s): N/A					

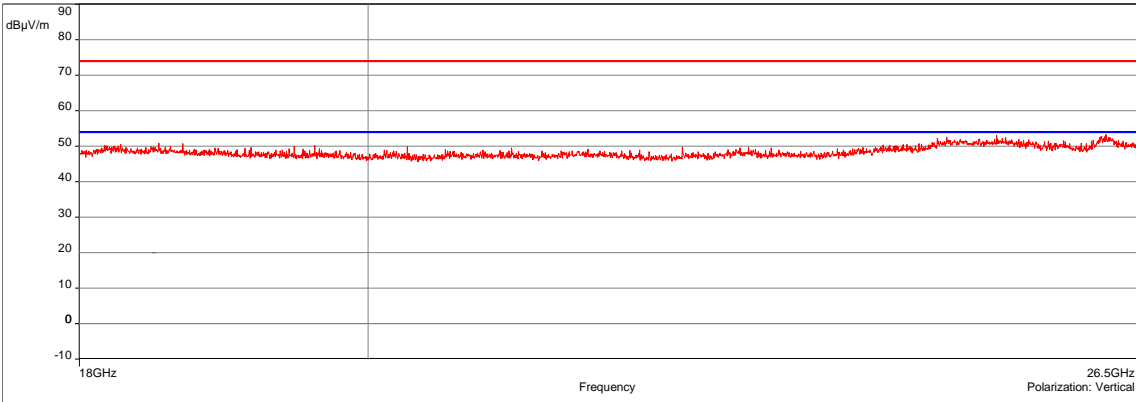
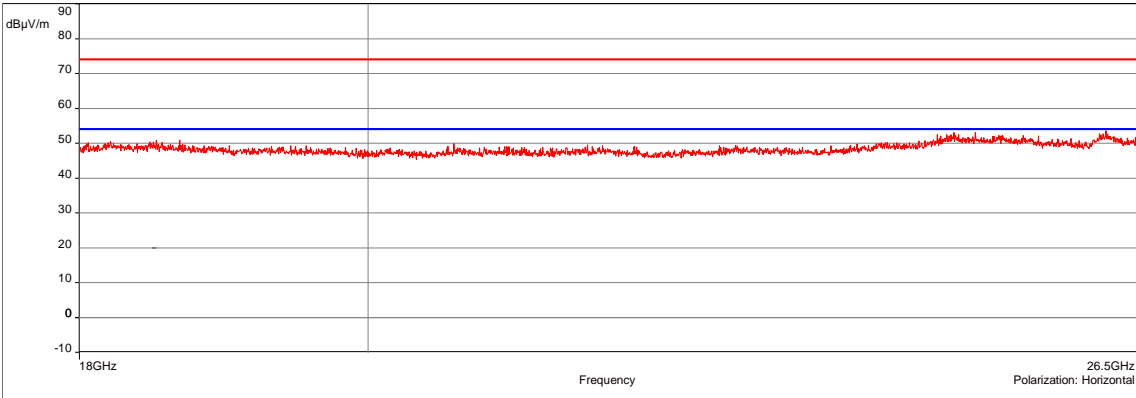
RADIATED SPURIOUS EMISSIONS (RECEIVER) - GRAPH					
RX MODE / ALL POSITIONS / ALL CHANNELS / 18GHZ TO 26.5GHZ				EMI7302	
EUT mode:	Rx mode			T (°C):	21.8
Test Date:	20/04/2021			H (%):	31.3
Test Operator:	ATO & OAT			P (hPa):	1012
<p>Sub-range 1</p> <p>Frequencies: 18 GHz - 26.5 GHz (Analyser mode) 15000 Points Settings: RBW: 1MHz, VBW: 3MHz, Auto, Attenuation: 10 dB, Sweep count 1, Preamp: Off, LN Preamp: Off, Preselector: Off Polarization: Vertical Distance: 3 m</p>  <p>Rx mode / All Positions / All channels / 18GHz to 26.5GHz - 04/20/2021 14:53 - 7302</p> <p>Sub-range 2</p> <p>Frequencies: 18 GHz - 26.5 GHz (Analyser mode) 15000 Points Settings: RBW: 1MHz, VBW: 3MHz, Auto, Attenuation: 10 dB, Sweep count 1, Preamp: Off, LN Preamp: Off, Preselector: Off Polarization: Horizontal Distance: 3 m</p>  <p>Rx mode / All Positions / All channels / 18GHz to 26.5GHz - 04/20/2021 14:53 - 7302</p>					
POSITION	FREQUENCIES	RBW	VBW	DETECTOR	
Vertical	18GHz-26.5GHz	1MHz	3MHz	Peak	
Horizontal	18GHz-26.5GHz	1MHz	3MHz	Peak	
Configuration:	N/A				
Comments:	N/A				
EUT modification(s): N/A					

RADIATED SPURIOUS EMISSIONS (RECEIVER) - GRAPH			
CHARGING + RX MODE / ALL POSITIONS / ALL CHANNELS / 18GHZ TO 26.5GHZ			EMI7307
EUT mode:	Rx mode	T (°C):	21.8
Test Date:	20/04/2021	H (%):	31.3
Test Operator:	ATO & OAT	P (hPa):	1012

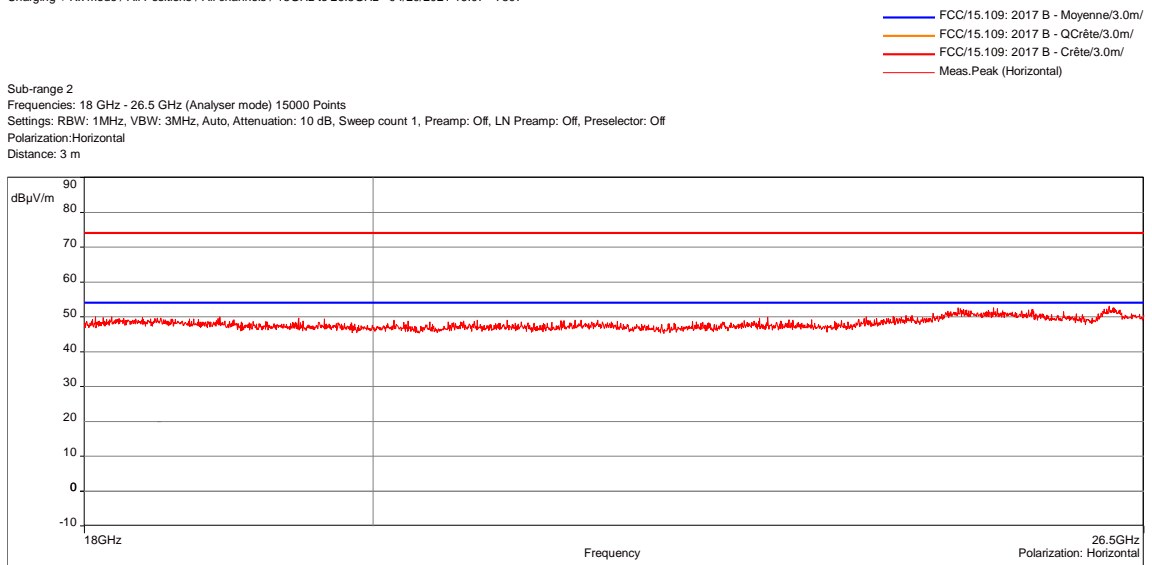
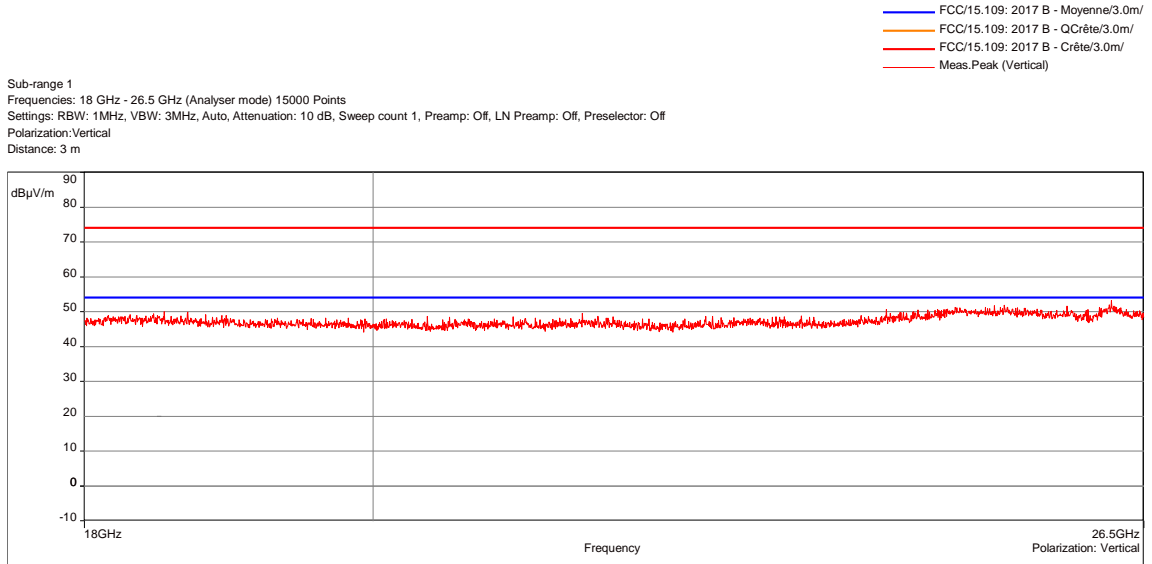

POSITION	FREQUENCIES	RBW	VBW	DETECTOR
Vertical	18GHz-26.5GHz	1MHz	3MHz	Peak
Horizontal	18GHz-26.5GHz	1MHz	3MHz	Peak
Configuration:	N/A			
Comments:	N/A			
EUT modification(s): N/A				

8.10. Frequency error

Reference standard:	FCC part 15 Radio part 15.215 and RSS Gen
Test method:	FCC part 15 Radio part 15.215 and RSS Gen
<p>Test description: Frequency error is the difference between the measured unmodulated carrier frequency under extreme conditions and the nominal Centre Frequency as stated by the manufacturer. This measurement procedure only applies if the EUT can generate an unmodulated carrier.</p> <p>EUT is set inside the climatic enclosure. It is connected to the measuring receiver via 50Ω attenuator(s). RBW=200Hz</p>	

TEST CASE	EUT MODE	SEVERITY	RESULT TAB.	VERDICT
Low channel / 25°C/ 3.7Vdc	Continuous Tx	0.001 %	EMI6793	PASS
Low channel / 25°C/ 4.2Vdc	Continuous Tx	0.001 %	EMI6794	PASS
Low channel / 25°C/ 3.45Vdc	Continuous Tx	0.001 %	EMI6795	PASS
Mid channel / 25°C/ 3.7Vdc	Continuous Tx	0.001 %	EMI6796	PASS
Mid channel / 25°C/ 4.2Vdc	Continuous Tx	0.001 %	EMI6797	PASS
Mid channel / 25°C/ 3.45Vdc	Continuous Tx	0.001 %	EMI6798	PASS
High channel / 25°C/ 3.7Vdc	Continuous Tx	0.001 %	EMI6799	PASS
High channel / 25°C/ 4.2Vdc	Continuous Tx	0.001 %	EMI6800	PASS
High channel / 25°C/ 3.45Vdc	Continuous Tx	0.001 %	EMI6801	PASS
Low channel / -5°C/ 3.7Vdc	Continuous Tx	0.001 %	EMI6887	PASS
Low channel / -5°C/ 4.2Vdc	Continuous Tx	0.001 %	EMI6888	PASS
Low channel / -5°C/ 3.45Vdc	Continuous Tx	0.001 %	EMI6889	PASS
Mid channel / -5°C/ 3.7Vdc	Continuous Tx	0.001 %	EMI6890	PASS
Mid channel / -5°C/ 4.2Vdc	Continuous Tx	0.001 %	EMI6891	PASS
Mid channel / -5°C/ 3.45Vdc	Continuous Tx	0.001 %	EMI6892	PASS
High channel / -5°C/ 3.7Vdc	Continuous Tx	0.001 %	EMI6893	PASS
High channel / -5°C/ 4.2Vdc	Continuous Tx	0.001 %	EMI6894	PASS
High channel / -5°C/ 3.45Vdc	Continuous Tx	0.001 %	EMI6895	PASS
Low channel / 40°C/ 3.7Vdc	Continuous Tx	0.001 %	EMI6932	PASS
Low channel / 40°C/ 4.2Vdc	Continuous Tx	0.001 %	EMI6933	PASS
Low channel / 40°C/ 3.45Vdc	Continuous Tx	0.001 %	EMI6934	PASS
Mid channel / 40°C/ 3.7Vdc	Continuous Tx	0.001 %	EMI6935	PASS
Mid channel / 40°C/ 4.2Vdc	Continuous Tx	0.001 %	EMI6936	PASS
Mid channel / 40°C/ 3.45Vdc	Continuous Tx	0.001 %	EMI6937	PASS
High channel / 40°C/ 3.7Vdc	Continuous Tx	0.001 %	EMI6938	PASS
High channel / 40°C/ 4.2Vdc	Continuous Tx	0.001 %	EMI6939	PASS
High channel / 40°C/ 3.45Vdc	Continuous Tx	0.001 %	EMI6940	PASS

LABORATORY PARAMETERS:	REQUIRED PRIOR TO THE TEST	DURING THE TEST
Ambient Temperature	15 to 35 °C	22.1 °C
Relative Humidity	20 to 75 %	47.3 %
Atmospheric pressure	N/A	999 hPa
Test method deviation: N/A		
Supplementary information: EUT power supply is replaced by a stabilized power supply.		

TEST EQUIPMENT USED					
CATEGORY	BRAND	TYPE	IDENTIFIER	CAL. DATE	CAL. DUE
Attenuator	Radiall	R412710124	17328	22/06/2020	22/08/2023
Attenuator	Radiall	R412710124	17329	22/06/2020	22/08/2023
Cable	N	3m	16417	04/05/2019	04/07/2021
Cable	Huber + Suhner	SF102K	16041	28/02/2019	28/04/2021
Cable	Radiall	SMA-0,5m	14890	17/06/2020	17/08/2022
Climatic enclosure	CLIMATS	EXCAL 7714-HA	14261	19/09/2019	19/11/2020
Multimeter	FLUKE	8808A	12446	29/09/2020	29/11/2021
Power supply	TTI	PL303QMD	8496		
Receiver	Rohde & Schwarz	FPL1003	16027	14/08/2020	14/10/2021
Thermo-Hygro-Baromètre	LUFFT	OPUS 20	14563	11/12/2019	11/02/2021
Thermohygrometer	Testo	608-H2	12268	07/05/2020	07/07/2022
Thermohygrometer	Bioblock Scientific	Météostar	0963	25/01/2019	25/03/2021
Wattmeter	Rohde & Schwarz	HMC 8015	17005	05/03/2020	05/05/2021

Blank cells = Permanent validity



FREQUENCY ERROR - TABULATED RESULTS				
TEST CASE	FREQUENCY	FREQUENCY ERROR	LIMIT	RESULT TAB.
Low channel / 25°C/ 3.7Vdc	2.403950470 GHz	0 %	0.001 %	EMI6793
Low channel / 25°C/ 4.2Vdc	2.403950490 GHz	0.0000057 %	0.001 %	EMI6794
Low channel / 25°C/ 3.45Vdc	2.403950484 GHz	0.0000094 %	0.001 %	EMI6795
Mid channel / 25°C/ 3.7Vdc	2.439949987 GHz	0 %	0.001 %	EMI6796
Mid channel / 25°C/ 4.2Vdc	2.439949920 GHz	0.0000011 %	0.001 %	EMI6797
Mid channel / 25°C/ 3.45Vdc	2.439949880 GHz	0.0000022 %	0.001 %	EMI6798
High channel / 25°C/ 3.7Vdc	2.475949258 GHz	0 %	0.001 %	EMI6799
High channel / 25°C/ 4.2Vdc	2.475949224 GHz	0.0000012 %	0.001 %	EMI6800
High channel / 25°C/ 3.45Vdc	2.475949147 GHz	0.0000008 %	0.001 %	EMI6801
Low channel / -5°C/ 3.7Vdc	2.403950281 GHz	0.0001475 %	0.001 %	EMI6887
Low channel / -5°C/ 4.2Vdc	2.403950279 GHz	0.0001481 %	0.001 %	EMI6888
Low channel / -5°C/ 3.45Vdc	2.403950332 GHz	0.0001493 %	0.001 %	EMI6889
Mid channel / -5°C/ 3.7Vdc	2.439949563 GHz	0.0001626 %	0.001 %	EMI6890
Mid channel / -5°C/ 4.2Vdc	2.439949577 GHz	0.0001625 %	0.001 %	EMI6891
Mid channel / -5°C/ 3.45Vdc	2.439949627 GHz	0.0001637 %	0.001 %	EMI6892
High channel / -5°C/ 3.7Vdc	2.475948863 GHz	0.0001689 %	0.001 %	EMI6893
High channel / -5°C/ 4.2Vdc	2.475948864 GHz	0.0001687 %	0.001 %	EMI6894
High channel / -5°C/ 3.45Vdc	2.475948916 GHz	0.00017 %	0.001 %	EMI6895
Low channel / 40°C/ 3.7Vdc	2.403945679 GHz	0.0003317 %	0.001 %	EMI6932
Low channel / 40°C/ 4.2Vdc	2.403945671 GHz	0.0003316 %	0.001 %	EMI6933
Low channel / 40°C/ 3.45Vdc	2.403945647 GHz	0.000337 %	0.001 %	EMI6934
Mid channel / 40°C/ 3.7Vdc	2.439944857 GHz	0.0003178 %	0.001 %	EMI6935
Mid channel / 40°C/ 4.2Vdc	2.439944876 GHz	0.0003178 %	0.001 %	EMI6936
Mid channel / 40°C/ 3.45Vdc	2.439944855 GHz	0.0003196 %	0.001 %	EMI6937
High channel / 40°C/ 3.7Vdc	2.475944101 GHz	0.0003122 %	0.001 %	EMI6938
High channel / 40°C/ 4.2Vdc	2.475944096 GHz	0.0003121 %	0.001 %	EMI6939
High channel / 40°C/ 3.45Vdc	2.475944085 GHz	0.0003150 %	0.001 %	EMI6940

End of test report