



Test report issued under the responsibility of:
EMITECH MONTPELLIER laboratory
MRA US-EU Designation Number: FR0006
Canadian CAB Identifier: FR0003

RADIO TEST REPORT

FCC Part 15 :2018
RSS-Gen - Issue 5, April 2018

Company: **XPLORER**
Address.....: 40 chemin du Moulin
31320 MERVILLA
FRANCE

Test item description: **Wireless metal detection sensor**
Trade Mark: FMF
Manufacturer: XPLORER
Model/Type reference.....: XPMF / FMF22
FCC ID.....: XFJMF
IC: 8392A-MF
Ratings.....: 3.45Vdc to 4.2Vdc

Testing Laboratory: **EMITECH MONTPELLIER laboratory**
Address.....: 145 rue de Massacan
34740 VENDARGUES
FRANCE

Report Reference No.....: **RR410-20-101751-18A**
Test procedure: FCC IC Certification
Diffusion.....: Mr LOUBET
Applicant's name: XPLORER
Date of issue.....: October 21, 2021
Total number of pages.....: 68
Revision.....: 0
Modified page(s).....: Creation
Compiled by.....: Olivier AELBRECHT
Approved by (+ signature).....: Olivier HEYER (Laboratory Manager)

*Duplication of this test report is only permitted for an integral photographic facsimile. It includes the number of pages referenced here above.
This document is the result of testing a specimen or a sample of the product submitted. It does not imply an assessment of the conformity of
the whole manufactured products of the tested sample.*

REPORT INDEX:	
1. GENERAL INFORMATIONS	3
2. REFERENCE DOCUMENT(S).....	4
3. EQUIPMENT TECHNICAL DESCRIPTION	5
3.1. TEST CONDITIONS	5
3.2. EUT MARKING PLATE	5
3.3. EUT GENERAL VIEW	6
3.4. EUT MECHANICAL AND ELECTRICAL DESIGN.....	6
3.5. EUT INPUT/OUTPUT PORTS.....	7
3.6. SUPPORTING EQUIPMENT USED DURING TEST.....	8
3.7. EUT RADIO SPECIFICATIONS.....	9
4. OPINION(S) AND INTERPRETATION(S).....	10
5. RESULT SUMMARY	11
6. MEASUREMENT UNCERTAINTY	13
7. TEST CONDITIONS AND RESULTS	14
7.1. CONDUCTED EMISSION (MEASUREMENT)	14
7.2. TRANSMITTER RADIATED SPURIOUS EMISSIONS AT FREQUENCIES <30MHZ.....	24
7.3. TRANSMITTER RADIATED SPURIOUS EMISSIONS AT FREQUENCIES >30MHZ.....	47
7.4. H-FIELD (RADIATED).....	53
7.5. MODULATION BANDWIDTH.....	60
7.6. FREQUENCY ERROR.....	65

REVISION HISTORY:			
Revision	Date	Modified pages	Modifications
0	October 21, 2021	/	Creation

1. GENERAL INFORMATIONS

This document submits the results of Radio tests performed on the equipment **Wireless metal detection sensor XPMF / FMF22** (denominated hereafter E.U.T.: equipment under test) according to document(s) listed in §2 of this test report.

TESTING PROCEDURE AND TESTING LOCATION:					
Testing Location : EMITECH MONTPELLIER laboratory					
Address..... : 145 rue de Massacan 34740 VENDARGUES FRANCE					
Test procedure. : FCC IC Certification					
Tested by : Olivier AELBRECHT					
Test supervisor : None					
Date of receipt of test item..... : N/A					
Date (s) of performance of tests : From September the 2 nd of 2020 to October the 19 th of 2020					
APPLICANT'S GENERAL INFORMATIONS:					
Company name : XPLOERER					
Company address. : 40 chemin du Moulin 31320 MERVILLA FRANCE					
Person(s) present during the tests. : No representative for company attended the tests.					
Responsible..... : Mr LOUBET					
GENERAL REMARKS:					
<p>The information in italics is declared by the manufacturer and is under his responsibility</p> <p>The test results presented in this report relate only to the object tested.</p> <p>The results contained in this report reflect the results for this particular model and serial number. It is the responsibility of the manufacturer to ensure that all production models meet the intent of the requirements detailed within this report.</p> <p>"(see Enclosure #)" refers to additional information appended to the report.</p> <p>"(see appended table)" refers to a table appended to the report.</p> <p>Throughout this report the decimal separator is point.</p>					
POSSIBLE TEST CASE VERDICTS:					
Test case does not apply to the test object.. : N/A					
Test case not performed..... : N/P					
Test object does meet the requirement..... : P (Pass)					
Test object does not meet the requirement.. : F (Fail)					
DEFINITIONS AND ABBREVIATIONS:					
E.U.T.	Equipment under test	AE	Ancillary equipment	Pk	Peak detector
RBW	Resolution bandwidth	VBW	Video bandwidth	QP	Quasi-peak detector
OATS	Open area test site	FAR	Full anechoic room	Av	Average detector
VP	Vertical Polarization	HP	Horizontal Polarization	RMS	Root Mean Square
RF	Radio frequency	NTR	Nothing to report	N/C	Not communicated

2. REFERENCE DOCUMENT(S)

NORMATIVE REFERENCES:

The following referenced documents are necessary for the application of the present test report.

FCC Part 15 :2018

Code of Federal Regulations Title 47 – Telecommunications Chapter 1 – Federal Communications Commission Part 15 – Radio frequency devices Subpart C – Intentional Radiators

RSS-Gen - Issue 5, April 2018

General requirements and Information for the Certification of radio Apparatus

ANSI C63.10 : 2013

American National Standard of Procedures for Compliance Testing of Unlicensed Wireless Devices.

ANSI C 63.4:2014

American National Standard for Methods of measurement of Radio-Noise from low-voltage Electrical and Electronic Equipment in the Range of 9 kHz to 40 GHz

Although the product standard uses obsolete technical standards, the latest versions of standards achievable by the laboratory will be used for testing.

INFORMATIVE REFERENCES:

The following referenced documents are not necessary for the application of the present test report but they assist the user with regard to a particular subject area.

3. EQUIPMENT TECHNICAL DESCRIPTION

3.1. Test Conditions

Test item description. : Wireless metal detection sensor
 Model/Type reference..... : XPMF / FMF22
 Trade Mark. : FMF
 FCC ID..... : XFJMF
 IC. : 8392A-MF
 Serial number (S/N)..... : 509096
 Part number (P/N). : Not communicated
 Software version..... : *Not communicated*
 Firmware version. : *Not communicated*
 Type of sample. : Prototype
 Function(s)..... : Wireless metal detection sensor
 Manufacturer name. : XPLOER
 Address..... : 40 chemin du Moulin
 31320 MERVILLA
 FRANCE

General product information:

N/A

3.2. EUT Marking plate



3.3. EUT General view



3.4. EUT Mechanical and Electrical Design

Power supply..... : 3.7Vdc
 Power supply range..... : 3.45Vdc to 4.2Vdc
 Power type..... : Battery powered
 Power (W)..... : not communicated
 Nominal current (A). : 1
 Dimensions (L x W x H) (m). : 0.225x0.225x0.04
 Weight (kg). : 0.323
 Temperature range (°C). : -5°C to +40°C
 Ground bounding strap..... : No

Comments:

N/A

3.5. EUT Input/Output ports

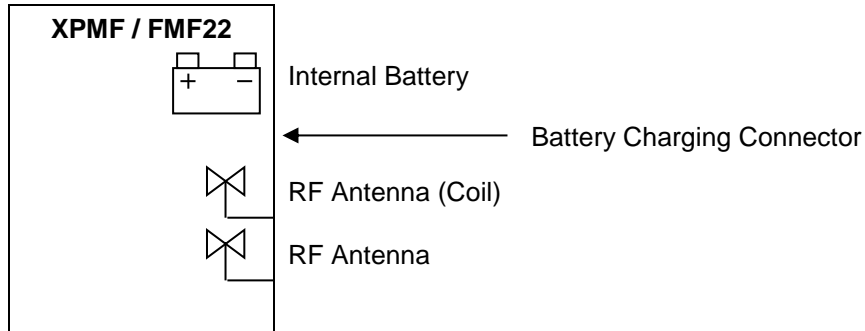

PORT	NAME	TYPE	LENGHT	CABLE TYPE	COMMENTS
0	Main frame	N/E	N/A	Plastic	
1	Internal Battery	DC	N/A	N/A	
2	Battery Charging Connector	DC	1m	2P	
3	RF Antenna (Coil)	RF	N/A	N/A	Used for detection (4.1 kHz to 45.19 kHz)
4	RF Antenna	RF	N/A	N/A	Used to communicate with remote (2.4GHz)

AC/DC : AC/DC Converter port
 I/O.....: Input or Output port
 N/E: Non Electrical port

AC.....: Alternative current port
 TP: Telecommunication port

DC: Discontinuous current port
 RF.....: Radio frequency port

3.6. Supporting Equipment Used During Test

Sample subject to the tests was tested with following equipment.

PRODUCT TYPE	MANUFACTURER	MODEL	N°EMITECH / COMMENTS
Remote Device	XPLORER	DEUS 2	Used to set the EUT in test mode
Battery charger (AC/DC)	Sinohero Industrial Ltd.	SJ-0510-E	Used for conducted emission

REMOTE DEVICE (EA)



ATTERY CHARGER (AC/DC) (EA)



3.7. EUT Radio Specifications

a) GENERAL INFORMATIONS	
According to manufacturer's declarations :	
EUT type.....	: <i>Transmitter</i>
Technology	: <i>SRD (Metal and object detection sensors)</i>
Environmental profile.....	: <i>Data transmissions</i>
Temperature range.....	: <i>-5°C to +40°C</i>
Antenna type	: <i>Integral</i>
Antenna Gain.....	: <i>not communicated</i>
Comments:	
b) TRANSMITTER PARAMITERS (Tx)	
Frequency bands.....	: <i>4.1 kHz to 45.19 kHz</i>
RF Power.....	: <i>not communicated</i>
Number of channels / Separation.....	: <i>Multiple</i>
Modulation type	: <i>Not modulated</i>
Duty cycle	: <i>N/A</i>
Tested frequency.....	: <i>4.1kHz low Channel</i> <i>45.19kHz High Channel</i>
c) RECEIVER PARAMETERS (Rx)	
Frequency bands.....	: <i>4.1 kHz to 45.19 kHz</i>
Category/Class	: <i>not communicated</i>
Bandwidth.....	: <i>Multiple</i>

4. OPINION(S) AND INTERPRETATION(S)

TEST(S) PERFORMED	DEVIATION(S) TO TEST METHOD(S)
FCC part 15.109, 15.209, 15.205, 15.215, CNR-Gen	The EUT is encapsulated in a casing. We were not able to measure its voltage supply during radiated tests
FCC part 15 Radio part 15.215 and RSS Gen	N/A
ANSI C63.4: 2014	N/A

Comments: N/A

5. RESULT SUMMARY

TEST DESIGNATION	SEVERITY	VERDICT	COMMENTS
GENERAL			
Labeling requirements		PASS	15.19 / See certification documents
Information to user		PASS	15.21 / See certification documents
Home-built devices		N/A	15.23
Kits		N/A	15.25
Special Accessories		PASS	15.27 / See certification documents
Inspection by the Commission		N/A	
Measurement standards		PASS	15.31
Test procedure for CPU boards and computer power supplies		N/A	15.32
Frequency range of radiated measurements		N/A	15.33
Measurement detector functions and bandwidths		N/A	15.36
Transition provisions for compliance with the rules		PASS	15.37 / See certification documents
UNINTENTIONAL RADIATORS			
Equipment authorization			15.101
- Verification		N/A	
- Declaration of Conformity		N/A	
CPU boards and power supplies used in personal computers		N/A	15.102
Exempted device		N/A	15.103
Information to the user		N/P	15.105 / See certification documents
Conducted limits	Class B	PASS	15.107
Radiated emission limits	Class B	PASS	15.109
Antenna power conduction limits for receivers		N/A	15.111
Power line carrier systems		N/A	15.113
TV interface devices, including cable system terminal devices		N/A	15.115
TV broadcast receivers		N/A	15.117
Cable ready consumer electronics equipment		N/A	15.118
Program blocking technology requirements for TV receivers		N/A	15.120
Scanning receivers and frequency converters used with scanning receivers		N/A	15.121
Labeling of digital cable ready products		N/A	15.123

TEST DESIGNATION	SEVERITY	VERDICT	COMMENTS
INTENTIONAL RADIATORS			
Equipment authorization requirement		PASS	15.201 / Transmitter part is subject to Certification procedure
Certified operating frequency range		N/A	15.202
Antenna requirement		PASS	15.203 / Dedicated integral antenna
External radio frequency power amplifiers and antenna modifications		N/A	15.204
Restricted bands of operation		PASS	15.205
Conducted limits	Class B	PASS	15.207
Radiated emission limits; general requirements	Class B	PASS	15.209
Tunnel radio systems		N/A	15.211
Modular transmitters		N/A	15.212
Cable locating equipment		N/A	15.213
Cordless telephones		N/A	15.214
Additional provisions to the general radiated emission limits		PASS	15.215

Sample subject to the test complies for tests done with the requirements of the reference document(s) listed in §2 of this test report and, where applicable, with deviation(s) specified in this document.

To declare, or not, the compliance with the specifications, it was not explicitly taken into account of uncertainty associated with the results.

TEST(S) PERFORMED	MODIFICATION(S)
FCC part 15.109, 15.209, 15.205, 15.215, CNR-Gen	N/A
FCC part 15 Radio part 15.215 and RSS Gen	N/A
ANSI C63.4: 2014	N/A

6. MEASUREMENT UNCERTAINTY

PARAMETER	MAXIMAL EMITECH UNCERTAINTY	MINIMAL STANDARD UNCERTAINTY
Radio frequency	$\pm 1 \times 10^{-7}$	$\pm 1 \times 10^{-7}$
RF power, conducted		
RF power	$\pm 0.8\text{dB}$	$\pm 1 \text{ dB}$
RF power (EN 300328 / EN 301893)	$\pm 1.3\text{dB}$	$\pm 1.5 \text{ dB}$
Power spectral density	$\pm 2.3\text{dB}$	$\pm 3 \text{ dB}$
Occupied bandwidth		
RF power	$\pm 3.8 \%$	$\pm 5 \%$
RF power (EN 300328 / EN 301893)	$\pm 3.8 \%$	$\pm 5 \%$
Maximum frequency deviation		
300 Hz < audio frequency < 6 kHz	$\pm 1.2 \%$	$\pm 5 \%$
6 kHz < audio frequency < 25 kHz	$\pm 1.2 \%$	$\pm 3 \text{ dB}$
Adjacent channel power	$\pm 1.6 \text{ dB}$	$\pm 3 \text{ dB}$
Sensibility of receiver (conducted)	$\pm 2.0 \text{ dB}$	$\pm 3 \text{ dB}$
Blocking	$\pm 4.0 \text{ dB}$	$\pm 4 \text{ dB}$
Transitoire		
Amplitude	$\pm 8.5 \%$	$\pm 20 \%$
At the frequency	$\pm 166 \text{ Hz}$	$\pm 250 \text{ Hz}$
Conducted emission (spurious)		
$f \leq 1 \text{ GHz}$	$\pm 0.8 \text{ dB}$	
1 GHz - 12.75 GHz	$\pm 1.6 \text{ dB}$	$\pm 3 \text{ dB}$
Radiated emission (PAR / PIRE / RNE)		
$f \leq 62.5 \text{ MHz}$	$\pm 5.1 \text{ dB}$	$\pm 6 \text{ dB}$
62.5 MHz - 1 GHz	$\pm 5.1 \text{ dB}$	$\pm 6 \text{ dB}$
1 GHz - 18 GHz	$\pm 5.2 \text{ dB}$	$\pm 6 \text{ dB}$
18 GHz – 26 GHz	$\pm 5.1 \text{ dB}$	$\pm 6 \text{ dB}$
26 GHz – 40 GHz	$\pm 5.4 \text{ dB}$	$\pm 6 \text{ dB}$
180-1000 MHz / 1 – 12.75 GHz (EN 301 908-1)	$\pm 3.0 / 2.9 \text{ dB}$	$\pm 3 \text{ dB}$
RF power (EN 300328 / EN 301893)	$\pm 5.3 \text{ dB}$	$\pm 6 \text{ dB}$
PIRE and power spectral density with diode	$\pm 5.2 \text{ dB}$	$\pm 6 \text{ dB}$
Radiated emission (magnetic field)		
9kHz – 30MHz	$\pm 3 \text{ dB}$	$\pm 6 \text{ dB}$
RF level for a given BER	$\pm 0.8 \text{ dB}$	$\pm 1.5 \text{ dB}$
Supply voltages	$\pm 3 \%$	$\pm 3 \%$
Temperature	$\pm 1 \text{ }^\circ\text{C}$	$\pm 1^\circ\text{C}$
Humidity	$\pm 5 \%$	$\pm 5 \%$
Time / Duty cycle	$\pm 4.4 \%$	$\pm 5 \%$
Adaptivity	$\pm 2.9 \text{ dB}$	/
Radiated emission (electric field for FCC standard)		
9kHz – 30MHz	$\pm 2.7 \text{ dB}$	/
30MHz – 1GHz	$\pm 5.0 \text{ dB}$	/
1GHz – 18GHz	$\pm 5.6 \text{ dB}$	/
18GHz – 26GHz	$\pm 5.7 \text{ dB}$	/
26GHz – 40GHz	$\pm 5.7 \text{ dB}$	/

For the calcul of expanded uncertainty, the confidence interval is 95 % (k=2).

7. TEST CONDITIONS AND RESULTS

7.1. Conducted emission (measurement)

Reference standard:	FCC part 15.107, 15.207 and RSS-Gen
Test method:	ANSI C63.4: 2014
<p>General test setup: EUT is set on an insulating support at 80cm above the ground reference plane and at 40cm to the vertical ground reference plane. All power was connected to the system through Artificial Mains Network (AMN). The AMN is placed at 80cm from the boundary of the EUT and bonded to a ground reference plane.</p> <p>All tested telecommunications lines (if applicable) were connected to an Asymmetric Artificial Network (AAN) and conducted voltage measurements on telecommunications lines were made at the output of the AAN.</p> <p>Where an AAN was not appropriate or available, measurements were made using a Capacitive Voltage Probe and/or a Current probe.</p> <p>Additional ground terminals (if any) are connected to earth terminal of the AMN.</p>	

TESTED CABLE	PARAMETER	SEVERITY	RESULT TAB.	VERDICT
120Vac/60Hz power supply / Tx mode Low Channel	150kHz-30MHz	Class B	EMI5890	PASS
120Vac/60Hz power supply / Tx mode High Channel	150kHz-30MHz	Class B	EMI5889	PASS
120Vac/60Hz power supply / Standby mode	150kHz-30MHz	Class B	EMI5899	PASS

LABORATORY PARAMETERS:	REQUIRED PRIOR TO THE TEST	DURING THE TEST
Ambient Temperature	15 to 35 °C	See Graph(es)
Relative Humidity	30 to 60 %	See Graph(es)
Atmospheric pressure	N/A	See Graph(es)
Test method deviation: N/A		
Supplementary information: N/A		

TEST EQUIPMENT USED					
CATEGORY	BRAND	TYPE	IDENTIFIER	CAL. DATE	CAL. DUE
AC power source	CHROMA	61603	12532	25/07/2019	25/09/2021
Cable	N	3m	16422	04/05/2019	04/07/2021
Cable	EMITECH	Current absorber sheath	9491	23/06/2020	23/08/2022
Ground plane	EMITECH	Test area	11569		
LISN	AFJ	LT32C\10	12007	11/01/2019	11/03/2021
Multimeter	FLUKE	8808A	12446	29/09/2020	29/11/2021
Receiver	Rohde & Schwarz	ESHS10	3371	27/04/2020	27/06/2021
Receiver	Rohde & Schwarz	FPL1003	16027	14/08/2020	14/10/2021
Software	Nexio		0000		
Thermohygrometer	Testo	608-H2	12268	07/05/2020	07/07/2022
TV	DESIMET	TVC 2437B	0903		

BAT-EMC software version: V3.18.0.26

Blank cells = Permanent validity

TEST SETUP PHOTO(S)



CONDUCTED EMISSION (MEASUREMENT) - TABULATED RESULTS						
120VAC/60Hz POWER SUPPLY / TX MODE LOW CHANNEL						EMI5890
Terminal	Test Frequency (MHz)	Gain/Loss Factor (dB)	Level Pk (dB μ V)	Level Avg (dB μ V)	Limit Avg (dB μ V)	Margin Lvl Avg - Limit Avg (dB)
Neutral	0.490	10.4	39.05	29.03	46.16	-17.13
Neutral	0.507	10.4	42.68	33.15	46	-12.85
Neutral	0.530	10.4	38.37	27.73	46	-18.27
Neutral	1.521	10.46	36.36	23.68	46	-22.32
Neutral	1.536	10.47	35.52	22.57	46	-23.43
Neutral	1.635	10.47	35.61	22.54	46	-23.46
Neutral	1.971	10.48	37.44	25.92	46	-20.08
Neutral	1.977	10.48	37.54	25.45	46	-20.55
Phase	0.447	10.39	39.41	22.41	46.93	-24.52
Phase	0.468	10.4	39.01	22.01	46.56	-24.55
Phase	0.478	10.4	38.99	21.54	46.37	-24.83
Phase	0.495	10.4	42.23	24.71	46.08	-21.37
Phase	0.514	10.4	45.67	29.03	46	-16.97
Phase	0.529	10.4	41.65	24.71	46	-21.29
Phase	0.878	10.43	38.44	21.16	46	-24.84
Phase	0.986	10.44	37.58	21.17	46	-24.83
Phase	0.994	10.44	37.64	21.58	46	-24.42
Phase	1.000	10.44	38.33	21.73	46	-24.27
Phase	1.025	10.44	38.75	20.86	46	-25.14
Phase	1.456	10.46	38.05	21.68	46	-24.32
Phase	1.473	10.46	38.98	22.29	46	-23.71
Phase	1.502	10.46	40.48	21.83	46	-24.17
Phase	1.506	10.46	40.46	21.61	46	-24.39
Phase	1.873	10.48	40.12	21.63	46	-24.37
Phase	1.916	10.48	39.35	22.65	46	-23.35
Phase	1.954	10.48	40.9	22.32	46	-23.68
Phase	1.966	10.48	41.3	21.57	46	-24.43

Supplementary information:
 Margin between peak measurements and quasi-peak limit is > 6dB, so no quasi-peak measurements were performed.
 Spurious which has more than 25 dB of margin compared to the applicable limit is not necessarily reported.

CONDUCTED EMISSION (MEASUREMENT) - TABULATED RESULTS						
120VAC/60HZ POWER SUPPLY / TX MODE HIGH CHANNEL						EMI5889
Terminal	Test Frequency (MHz)	Gain/Loss Factor (dB)	Level Pk (dB μ V)	Level Avg (dB μ V)	Limit Avg (dB μ V)	Margin Lvl Avg - Limit Avg (dB)
Neutral	0.431	10.39	41.13	27.72	47.23	-19.51
Neutral	0.459	10.4	40.6	28.7	46.72	-18.02
Neutral	0.475	10.4	41.14	30.01	46.43	-16.42
Neutral	0.506	10.4	48.05	36.02	46	-9.98
Neutral	0.522	10.4	40.49	31.09	46	-14.91
Neutral	0.593	10.41	40.06	24.62	46	-21.38
Neutral	1.203	10.45	41.44	26.74	46	-19.26
Neutral	1.315	10.45	41.37	27.54	46	-18.46
Neutral	1.330	10.46	41.96	27.05	46	-18.95
Neutral	1.347	10.46	42.22	26.44	46	-19.56
Neutral	1.478	10.46	40.87	23.91	46	-22.09
Neutral	1.704	10.47	41.87	28.61	46	-17.39
Neutral	1.816	10.48	44.89	31.11	46	-14.89
Neutral	1.833	10.48	45.63	31.06	46	-14.94
Neutral	1.851	10.48	44.13	30.81	46	-15.19
Neutral	1.886	10.48	42.73	30.33	46	-15.67
Neutral	1.955	10.48	44.02	28.44	46	-17.56
Neutral	2.597	10.5	39.57	25.93	46	-20.07
Neutral	2.616	10.5	41.03	25.75	46	-20.25
Neutral	2.631	10.5	41.03	25.46	46	-20.54
Neutral	2.748	10.51	39.97	24.75	46	-21.25
Neutral	2.785	10.51	41.05	24.35	46	-21.65
Phase	0.351	10.38	42.31	25.52	48.94	-23.42
Phase	0.432	10.39	45.8	26.25	47.2	-20.95
Phase	0.450	10.39	45.34	27.26	46.88	-19.62
Phase	0.461	10.4	44.87	27.42	46.68	-19.26
Phase	0.480	10.4	44.28	26.75	46.34	-19.59
Phase	0.502	10.4	50.98	32.98	46	-13.02
Phase	0.517	10.4	50.52	32.41	46	-13.59
Phase	0.571	10.41	43.15	22.57	46	-23.43
Phase	0.588	10.41	44.33	24.33	46	-21.67
Phase	0.610	10.41	42.46	23.79	46	-22.21
Phase	0.628	10.41	41.84	22.72	46	-23.28
Phase	0.646	10.41	39.31	21.55	46	-24.45
Phase	0.692	10.42	43.28	24.68	46	-21.32
Phase	0.710	10.42	45.01	23.86	46	-22.14
Phase	1.040	10.44	42.29	21.98	46	-24.02
Phase	1.055	10.44	42.74	22.19	46	-23.81
Phase	1.071	10.44	42.88	22.68	46	-23.32
Phase	1.096	10.44	41.66	23.08	46	-22.92
Phase	1.203	10.45	45.3	25.66	46	-20.34
Phase	1.263	10.45	42.28	24.85	46	-21.15
Phase	1.275	10.45	42.16	25.05	46	-20.95
Phase	1.281	10.45	42.56	25.2	46	-20.8

CONDUCTED EMISSION (MEASUREMENT) - TABULATED RESULTS						
120VAC/60HZ POWER SUPPLY / TX MODE HIGH CHANNEL						EMI5889
Terminal	Test Frequency (MHz)	Gain/Loss Factor (dB)	Level Pk (dBµV)	Level Avg (dBµV)	Limit Avg (dBµV)	Margin Lvl Avg - Limit Avg (dB)
Phase	1.317	10.45	45.69	25.68	46	-20.32
Phase	1.328	10.45	46.49	25.53	46	-20.47
Phase	1.335	10.46	45.98	25.45	46	-20.55
Phase	1.346	10.46	46.83	25.02	46	-20.98
Phase	1.364	10.46	45.54	24.31	46	-21.69
Phase	1.381	10.46	43.95	23.48	46	-22.52
Phase	1.399	10.46	42.53	22.55	46	-23.45
Phase	1.417	10.46	42.19	22.14	46	-23.86
Phase	1.435	10.46	42.51	21.9	46	-24.1
Phase	1.452	10.46	43.94	21.75	46	-24.25
Phase	1.469	10.46	43.69	21.54	46	-24.46
Phase	1.487	10.46	43.69	21.05	46	-24.95
Phase	1.505	10.46	43.49	20.46	46	-25.54
Phase	1.560	10.47	40.02	19.71	46	-26.29
Phase	1.689	10.47	45.72	25.54	46	-20.46
Phase	1.823	10.48	48.23	28.56	46	-17.44
Phase	1.841	10.48	49.37	28.13	46	-17.87
Phase	1.877	10.48	46.56	26.76	46	-19.24
Phase	1.895	10.48	46.38	26.48	46	-19.52
Phase	1.913	10.48	47.17	26.35	46	-19.65
Phase	1.948	10.48	46.92	25.07	46	-20.93
Phase	1.965	10.48	47.48	23.88	46	-22.12
Phase	2.150	10.49	44.11	23.24	46	-22.76
Phase	2.283	10.49	41.87	21.64	46	-24.36
Phase	2.388	10.5	39.74	20.55	46	-25.45
Phase	2.457	10.5	42.73	23.05	46	-22.95
Phase	2.494	10.5	42.97	22.86	46	-23.14
Phase	2.508	10.5	43.66	22.81	46	-23.19
Phase	2.526	10.5	42.25	22.94	46	-23.06
Phase	2.548	10.5	41.95	23.31	46	-22.69
Phase	2.562	10.5	41.93	23.77	46	-22.23
Phase	2.585	10.5	44.29	24.15	46	-21.85
Phase	2.603	10.5	45.36	24.04	46	-21.96
Phase	2.614	10.5	44.59	23.78	46	-22.22
Phase	2.629	10.5	45.32	23.48	46	-22.52
Phase	2.647	10.5	44.08	23.02	46	-22.98
Phase	2.658	10.5	45.07	22.83	46	-23.17
Phase	2.711	10.51	42.08	23.22	46	-22.78
Phase	2.750	10.51	45.32	22.8	46	-23.2
Phase	2.782	10.51	44.82	22.44	46	-23.56
Phase	2.831	10.51	42.07	21.79	46	-24.21
Phase	2.895	10.51	43.83	22.46	46	-23.54
Phase	2.911	10.51	42.71	22.12	46	-23.88
Phase	2.952	10.51	42.61	21.81	46	-24.19
Phase	3.122	10.52	44.34	22.45	46	-23.55
Phase	3.243	10.52	44.02	23.02	46	-22.98

CONDUCTED EMISSION (MEASUREMENT) - TABULATED RESULTS						
120VAC/60HZ POWER SUPPLY / TX MODE HIGH CHANNEL						EMI5889
Terminal	Test Frequency (MHz)	Gain/Loss Factor (dB)	Level Pk (dB μ V)	Level Avg (dB μ V)	Limit Avg (dB μ V)	Margin Lvl Avg - Limit Avg (dB)
Phase	3.264	10.52	45.55	22.96	46	-23.04
Phase	3.284	10.52	43.74	22.61	46	-23.39
Phase	3.304	10.52	43.23	22.07	46	-23.93
Phase	3.345	10.52	42.69	22.84	46	-23.16
Phase	3.384	10.52	43.58	22.43	46	-23.57
Phase	3.404	10.52	44.1	22.49	46	-23.51
Phase	3.706	10.53	41.45	21.98	46	-24.02
Phase	3.887	10.53	42.37	22.27	46	-23.73
Phase	4.069	10.54	40.55	22.06	46	-23.94
Phase	4.248	10.54	41.18	21.81	46	-24.19
Phase	4.342	10.54	41.2	21.63	46	-24.37
Phase	4.519	10.55	42.27	22.87	46	-23.13
Phase	4.700	10.55	41.48	23.18	46	-22.82
Phase	4.881	10.55	41.08	23.04	46	-22.96
Phase	4.971	10.55	41.03	23.09	46	-22.91
Phase	26.532	10.57	43.91	29.82	50	-20.18
Supplementary information: Margin between peak measurements and quasi-peak limit is > 6dB, so no quasi-peak measurements were performed. Spurious which has more than 25 dB of margin compared to the applicable limit is not necessarily reported.						
Supplementary information: Margin between peak measurements and quasi-peak limit is > 6dB, so no quasi-peak measurements were performed.						

CONDUCTED EMISSION (MEASUREMENT) - TABULATED RESULTS						
120VAC/60HZ POWER SUPPLY / STANDBY MODE						EMI5899
Terminal	Test Frequency (MHz)	Gain/Loss Factor (dB)	Level Pk (dB μ V)	Level Avg (dB μ V)	Limit Avg (dB μ V)	Margin Lvl Avg - Limit Avg (dB)
Neutral	0.492	10.4	46.41	32.46	46.14	-13.68
Neutral	0.496	10.4	43.96	34.34	46.06	-11.72
Neutral	0.507	10.4	46.27	36.55	46	-9.45
Neutral	0.515	10.4	45.05	35.57	46	-10.43
Neutral	0.528	10.4	41.95	31.79	46	-14.21
Neutral	1.178	10.45	38.88	27.57	46	-18.43
Neutral	1.221	10.45	38.92	27.07	46	-18.93
Neutral	1.311	10.45	39.09	28.31	46	-17.69
Neutral	1.342	10.46	39.79	27.4	46	-18.6
Neutral	1.690	10.47	39.45	28.6	46	-17.4
Neutral	1.713	10.47	39.68	29.38	46	-16.62
Neutral	1.759	10.47	38.53	30.47	46	-15.53
Neutral	1.809	10.48	42.05	31.92	46	-14.08
Neutral	1.820	10.48	42.53	32.03	46	-13.97
Neutral	1.840	10.48	42.64	31.99	46	-14.01
Neutral	1.859	10.48	42.14	31.64	46	-14.36
Neutral	1.869	10.48	41.17	31.44	46	-14.56
Neutral	1.908	10.48	39.69	31.07	46	-14.93
Neutral	1.927	10.48	40.9	30.57	46	-15.43
Neutral	1.943	10.48	40.96	29.79	46	-16.21
Phase	0.462	10.4	43.5	27.27	46.65	-19.38
Phase	0.465	10.4	44.02	27.27	46.6	-19.33
Phase	0.494	10.4	46.37	28.97	46.1	-17.13
Phase	0.500	10.4	48.53	32.19	46	-13.81
Phase	0.508	10.4	50.22	33.64	46	-12.36
Phase	0.528	10.4	46.17	29.44	46	-16.56
Phase	1.312	10.45	43.68	26.12	46	-19.88
Phase	1.711	10.47	44.32	26.54	46	-19.46
Phase	1.722	10.47	44.18	26.54	46	-19.46
Phase	1.741	10.47	43.14	26.62	46	-19.38
Phase	1.790	10.47	45.48	28.84	46	-17.16
Phase	1.814	10.48	46.86	29.46	46	-16.54
Phase	1.833	10.48	47.44	29.24	46	-16.76
Phase	1.842	10.48	46.68	28.98	46	-17.02
Phase	1.847	10.48	46.95	28.86	46	-17.14
Phase	1.868	10.48	45.34	27.89	46	-18.11
Phase	1.905	10.48	43.89	27.25	46	-18.75
Phase	1.924	10.48	44.91	26.93	46	-19.07

Supplementary information:
 Margin between peak measurements and quasi-peak limit is > 6dB, so no quasi-peak measurements were performed.
 Spurious which has more than 20 dB of margin compared to the applicable limit is not necessarily reported.

CONDUCTED EMISSION (MEASUREMENT) - GRAPH			
120VAC/60HZ POWER SUPPLY / TX MODE LOW CHANNEL			EMI5890
EUT mode:	Tx mode		T (°C): 21.5
Test Date:	19/10/2020		H (%): 37.3
Test Operator:	OAT		P (hPa): 1009

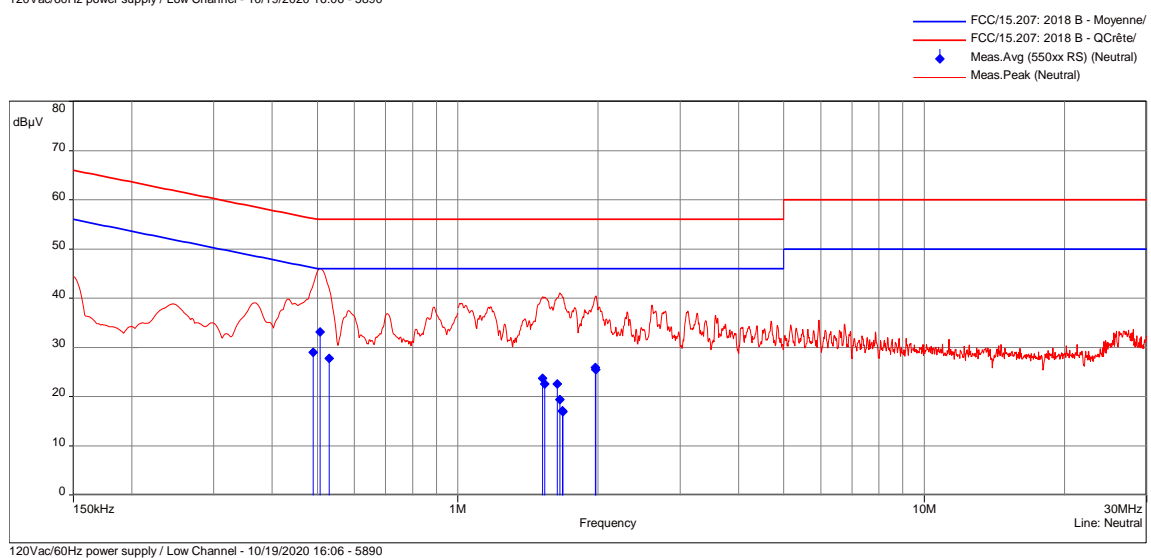
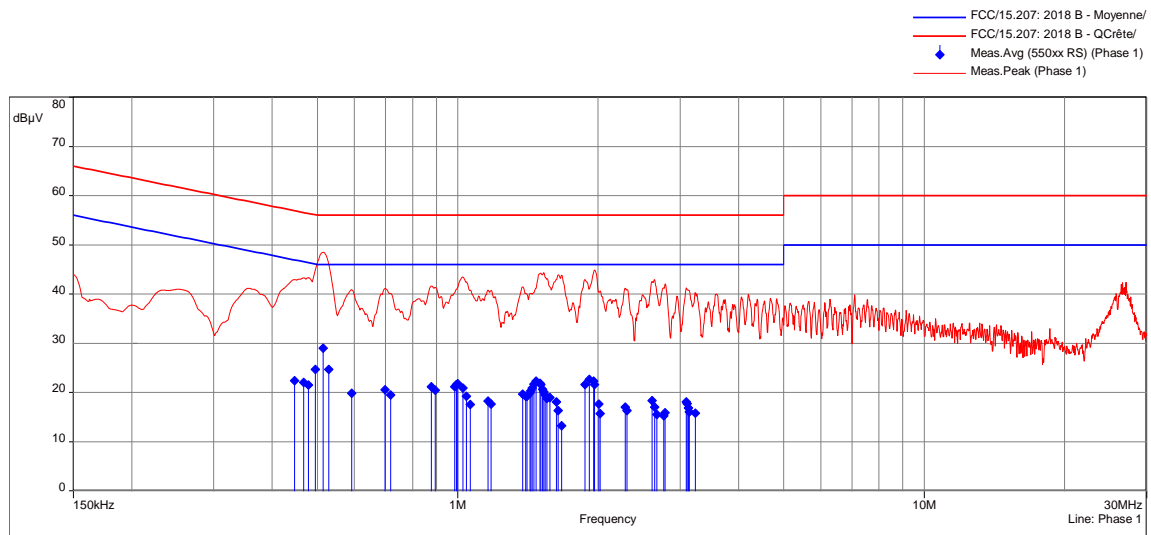

POSITION	FREQUENCIES	RBW	VBW	DETECTOR
Neutral	150kHz-1MHz	10kHz	30kHz	Peak; Avg
Neutral	1MHz-10MHz	10kHz	30kHz	Peak; Avg
Neutral	10MHz-30MHz	10kHz	30kHz	Peak
Phase	150kHz-1MHz	10kHz	30kHz	Peak; Avg
Phase	1MHz-10MHz	10kHz	30kHz	Peak; Avg
Phase	10MHz-30MHz	10kHz	30kHz	Peak
Measure with:	A.M.N.			
Comments:	N/A			
EUT modification(s): N/A				

CONDUCTED EMISSION (MEASUREMENT) - GRAPH			
120VAC/60HZ POWER SUPPLY / TX MODE HIGH CHANNEL			EMI5889
EUT mode:	Tx mode	T (°C):	21.5
Test Date:	16/10/2020	H (%):	37.3
Test Operator:	OAT	P (hPa):	1009

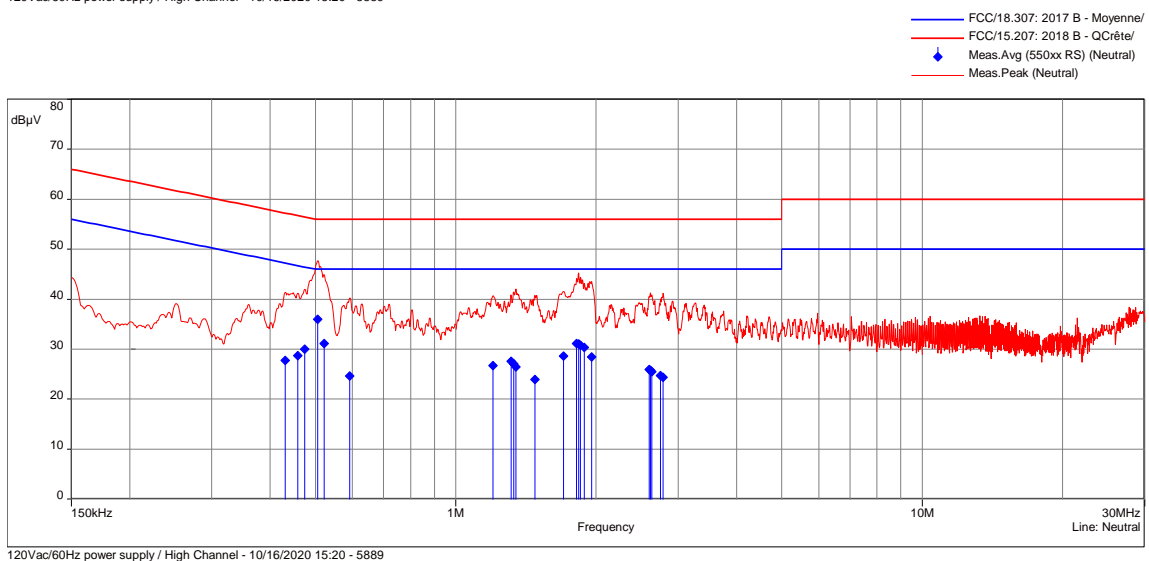
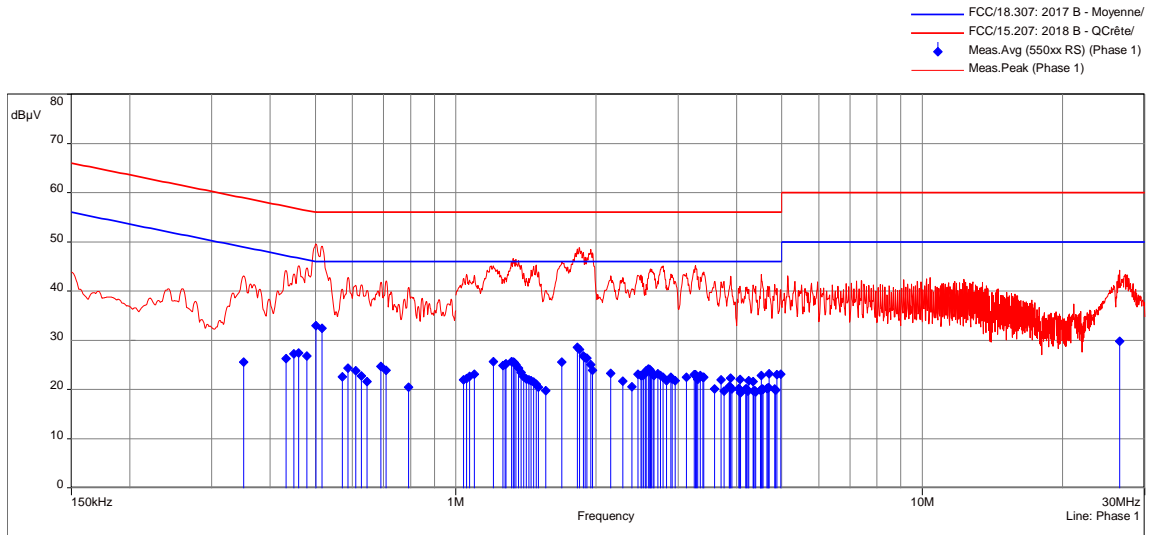

POSITION	FREQUENCIES	RBW	VBW	DETECTOR
Neutral	150kHz-1MHz	10kHz	30kHz	Peak; Avg
Neutral	1MHz-10MHz	10kHz	30kHz	Peak; Avg
Neutral	10MHz-30MHz	10kHz	30kHz	Peak
Phase	150kHz-1MHz	10kHz	30kHz	Peak; Avg
Phase	1MHz-10MHz	10kHz	30kHz	Peak; Avg
Phase	10MHz-30MHz	10kHz	30kHz	Peak; Avg

Measure with:	A.M.N.
Comments:	N/A
EUT modification(s): N/A	

CONDUCTED EMISSION (MEASUREMENT) - GRAPH			
120VAC/60HZ POWER SUPPLY / STANDBY MODE			EMI5899
EUT mode:	Standby mode	T (°C):	21.5
Test Date:	16/10/2020	H (%):	37.3
Test Operator:	OAT	P (hPa):	1009

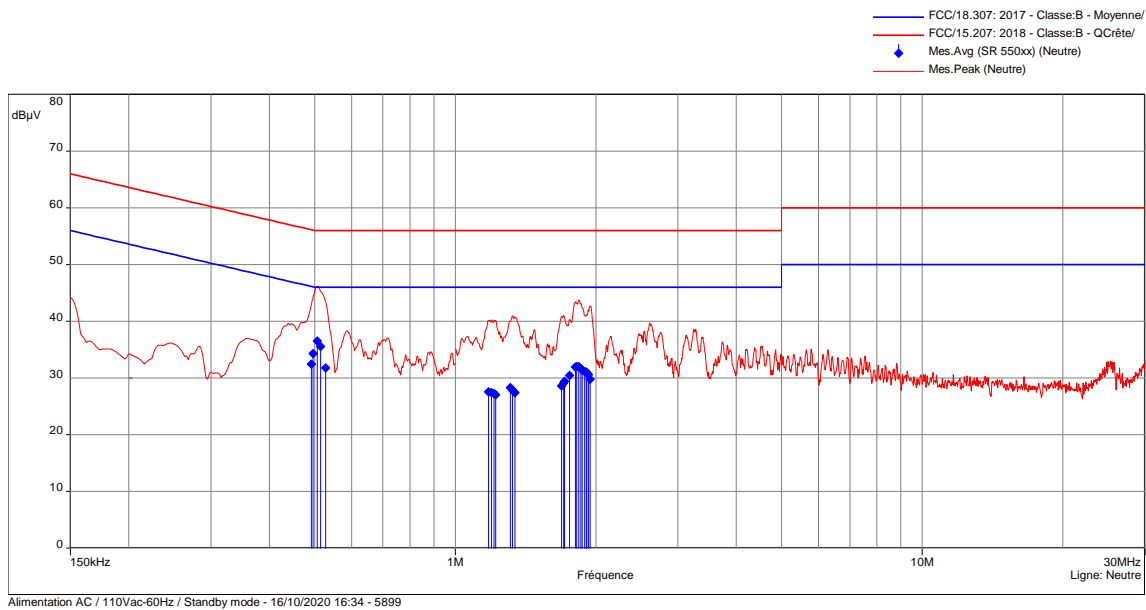
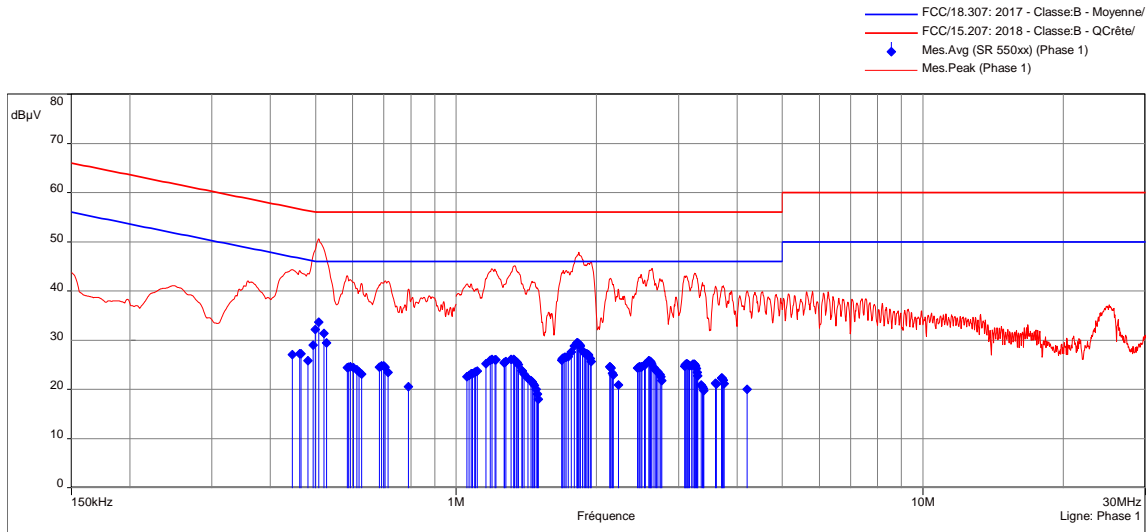

POSITION	FREQUENCIES	RBW	VBW	DETECTOR
Neutral	150kHz-1MHz	10kHz	30kHz	Peak; Avg
Neutral	1MHz-10MHz	10kHz	30kHz	Peak; Avg
Neutral	10MHz-30MHz	10kHz	30kHz	Peak
Phase 1	150kHz-1MHz	10kHz	30kHz	Peak; Avg
Phase 1	1MHz-10MHz	10kHz	30kHz	Peak; Avg
Phase 1	10MHz-30MHz	10kHz	30kHz	Peak

Measure with: A.M.N.

Comments: N/A

EUT modification(s): N/A

7.2. Transmitter radiated spurious emissions at frequencies <30MHz

Reference standard:	FCC part 15 Radio part 15.209 & CNR-Gen
Test method:	FCC part 15.109, 15.209, 15.205, 15.215, CNR-Gen
<p>Test description: : Spurious domain emission limits are limits on emissions at frequencies other than those of the carrier and sidebands associated with normal test modulation.</p> <p>EUT is set on an insulating support at 80cm above the ground reference plane.</p> <p>Preliminary (peak) measurements were performed at an antenna to EUT separation distance of 3-meter in a anechoic chamber. The EUT was rotated 360° in order to maximize radiated levels. Test antenna was oriented in 3 axes (0°, 45° and 90°).</p> <p>Final measurements (quasi-peak) were then performed in a 10-meter Open Area Test Site that complies to CISPR 16 in the same measurement conditions.</p> <p>All frequencies were investigated, where applicable.</p>	

TESTED CONFIGURATION	PARAMETER	SEVERITY	RESULT TAB.	VERDICT
Tx Mode / Low Channel / 0° - Position 1	9kHz-30MHz	15.209	EMI5053	PASS
Tx Mode / Low Channel / 45° - Position 1	9kHz-30MHz	15.209	EMI5054	PASS
Tx Mode / Low Channel / 90° - Position 1	9kHz-30MHz	15.209	EMI5055	PASS
Tx Mode / Low Channel / 0° - Position 2	9kHz-30MHz	15.209	EMI5056	PASS
Tx Mode / Low Channel / 45° - Position 2	9kHz-30MHz	15.209	EMI5057	PASS
Tx Mode / Low Channel / 90° - Position 2	9kHz-30MHz	15.209	EMI5058	PASS
Tx Mode / Low Channel / 0° - Position 3	9kHz-30MHz	15.209	EMI5059	PASS
Tx Mode / Low Channel / 45° - Position 3	9kHz-30MHz	15.209	EMI5060	PASS
Tx Mode / Low Channel / 90° - Position 3	9kHz-30MHz	15.209	EMI5061	PASS
Tx Mode / High Channel / 0° - Position 1	9kHz-30MHz	15.209	EMI5062	PASS
Tx Mode / High Channel / 45° - Position 1	9kHz-30MHz	15.209	EMI5063	PASS
Tx Mode / High Channel / 90° - Position 1	9kHz-30MHz	15.209	EMI5064	PASS
Tx Mode / High Channel / 0° - Position 2	9kHz-30MHz	15.209	EMI5065	PASS
Tx Mode / High Channel / 45° - Position 2	9kHz-30MHz	15.209	EMI5066	PASS
Tx Mode / High Channel / 90° - Position 2	9kHz-30MHz	15.209	EMI5067	PASS
Tx Mode / High Channel / 0° - Position 3	9kHz-30MHz	15.209	EMI5068	PASS
Tx Mode / High Channel / 45° - Position 3	9kHz-30MHz	15.209	EMI5069	PASS
Tx Mode / High Channel / 90° - Position 3	9kHz-30MHz	15.209	EMI5070	PASS

LABORATORY PARAMETERS:	REQUIRED PRIOR TO THE TEST	DURING THE TEST
Ambient Temperature	15 to 35 °C	See Graph(es)
Relative Humidity	20 to 75 %	See Graph(es)
Atmospheric pressure	N/A	See Graph(es)
Test method deviation: N/A		
Supplementary information: From 9 kHz to 30MHz: limit indicated on the curves is calculated with 40 dB/decade extrapolation factor and 51.5 dB conversion factor.		

TEST EQUIPMENT USED					
CATEGORY	BRAND	TYPE	IDENTIFIER	CAL. DATE	CAL. DUE
Antenna	Rohde & Schwarz	HFH2-Z2	5825	24/04/2020	24/06/2022
Cable	MegaPhase	N-3m	14852	29/10/2018	29/12/2020
Cable	SUCOFLEX	N-6,5m	14380	25/07/2019	25/09/2021
Cable	MegaPhase	N-8m	15813	12/11/2018	12/01/2021
Receiver	Rohde & Schwarz	FPL1003	16027	14/08/2020	14/10/2021
Shielded enclosure	COMTEST	SAC 3m	14494	02/10/2019	02/12/2022
Software	Nexio		0000		
Thermohygrometer	Testo	608-H1	7561	25/01/2019	25/03/2021
Thermohygrometer	Bioblock Scientific	Météostar	0963	25/01/2019	25/03/2021

BAT-EMC software version: V3.18.0.26

Blank cells = Permanent validity

TRANSMITTER RADIATED SPURIOUS EMISSIONS AT FREQUENCIES <30MHZ - TABULATED RESULTS				
TX MODE / LOW CHANNEL - ALL POSITIONS (OATS)				
Frequency (kHz)	Preliminary measurement (Pk) (dB μ A/m)	Final measurement (Avg) (dB μ A/m)	Limit Avg (dB μ A/m)	Margin (Avg-Limit)
12.322	52.62	23.50	53.60	-30.10
20.533	42.33	15.62	48.74	-33.12
28.762	40.61	13.83	45.94	-32.11
36.973	25.12	8.02	43.82	-35.80
53.412	32.11	5.92	40.70	-34.78
61.623	22.85	-0.99	39.34	-40.33
69.852	26.45	0.03	38.29	-38.25
102.730	21.64	-4.75	34.93	-39.68

Supplementary information:
Spurious which has more than 40 dB of margin compared to the applicable limit is not necessarily reported.

TRANSMITTER RADIATED SPURIOUS EMISSIONS AT FREQUENCIES <30MHZ - TABULATED RESULTS				
TX MODE / HIGH CHANNEL - ALL POSITIONS (OATS)				
Frequency (kHz)	Preliminary measurement (Pk) (dB μ A/m)	Final measurement (Avg) (dB μ A/m)	Limit Avg (dB μ A/m)	Marging (Avg-Limit)
45.201	51.71	25.19	42.08	-16.89
135.592	32.70	6.73	32.54	-25.81
225.961	24.00	-0.30	28.11	-28.41
316.347	18.29	-2.40	25.19	-27.59

Supplementary information:
Spurious which has more than 30 dB of margin compared to the applicable limit is not necessarily reported.
The frequency 45.201 kHz is the utile signal.

TEST SETUP PHOTO(S) -EUT POSITIONS



TEST SETUP PHOTO(S) -EUT POSITIONS



TEST SETUP PHOTO(S) – FOR PRELIMINARY MEASUREMENT



TEST SETUP PHOTO(S) - (OATS) - FOR FINAL MEASUREMENT

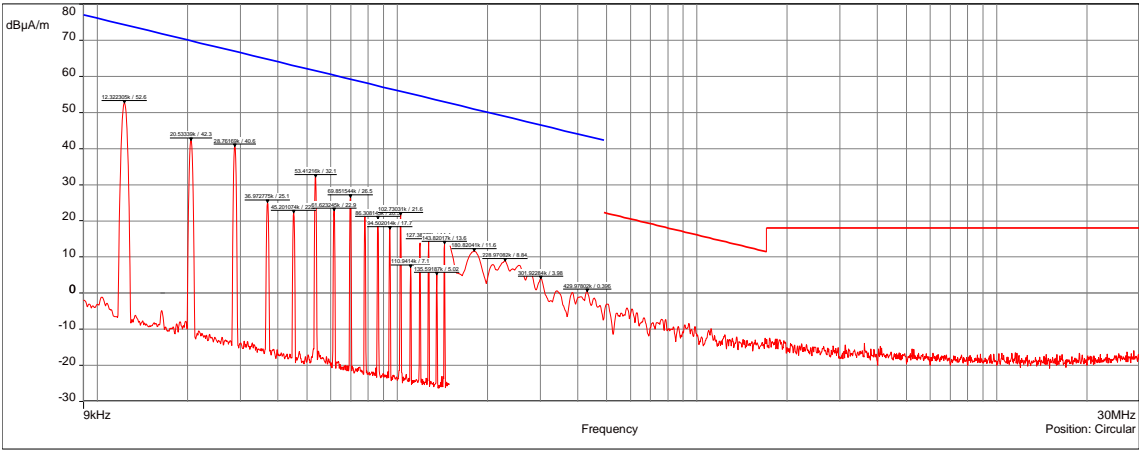

TRANSMITTER RADIATED SPURIOUS EMISSIONS AT FREQUENCIES <30MHz - GRAPH				
Tx MODE / Low CHANNEL / 0° - POSITION 1			EMI5053	
EUT mode:	Tx mode		T (°C):	22.3
Test Date:	02/09/2020		H (%):	45.4
Test Operator:	OAT		P (hPa):	1011
<div style="text-align: right;"> — FCC/FCC Part 15 §209 Tx - Moyenne/3.0m/ — FCC/FCC Part 15 §209 Tx - QCrête/3.0m/ — Meas.Peak </div> 				
POSITION	FREQUENCIES	RBW	VBW	DETECTOR
Circular	9kHz-150kHz	300Hz	1kHz	Peak
Circular	150kHz-1MHz	10kHz	30kHz	Peak
Circular	1MHz-30MHz	10kHz	30kHz	Peak
Configuration:	N/A			
Comments:	Limit indicated on these plots are calculated with 40 dB/decade extrapolation factor and 51.5dB conversion factor.			
EUT modification(s): N/A				

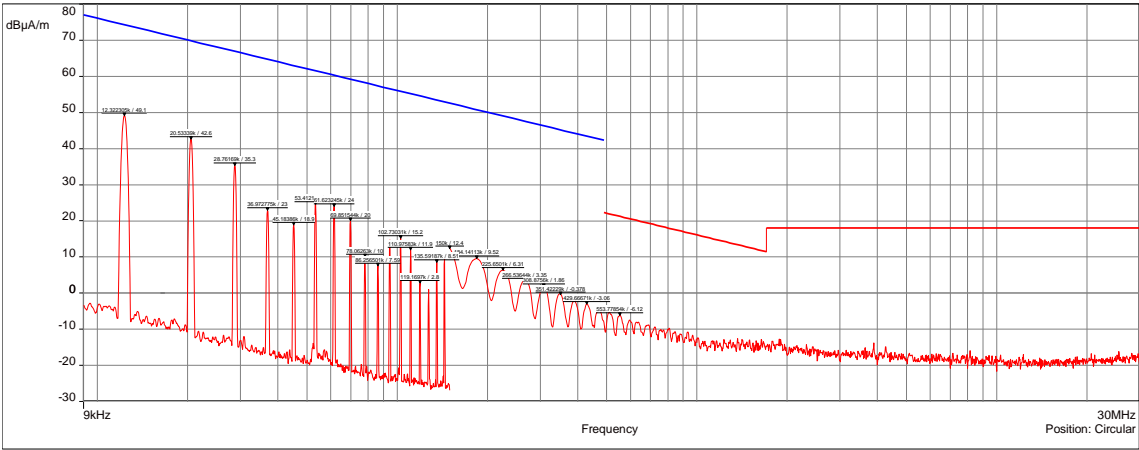
TRANSMITTER RADIATED SPURIOUS EMISSIONS AT FREQUENCIES <30MHz - GRAPH				
Tx Mode / Low Channel / 45° - Position 1			EMI5054	
EUT mode:	Tx mode		T (°C):	22.3
Test Date:	03/09/2020		H (%):	45.4
Test Operator:	OAT		P (hPa):	1011
<div style="text-align: right;"> — FCC/FCC Part 15 §209 Tx - Moyenne/3.0m/ — FCC/FCC Part 15 §209 Tx - QCrête/3.0m/ — Meas.Peak </div> 				
POSITION	FREQUENCIES	RBW	VBW	DETECTOR
Circular	9kHz-150kHz	300Hz	1kHz	Peak
Circular	150kHz-1MHz	10kHz	30kHz	Peak
Circular	1MHz-30MHz	10kHz	30kHz	Peak
Configuration:	N/A			
Comments:	Limit indicated on these plots are calculated with 40 dB/decade extrapolation factor and 51.5dB conversion factor.			
EUT modification(s): N/A				

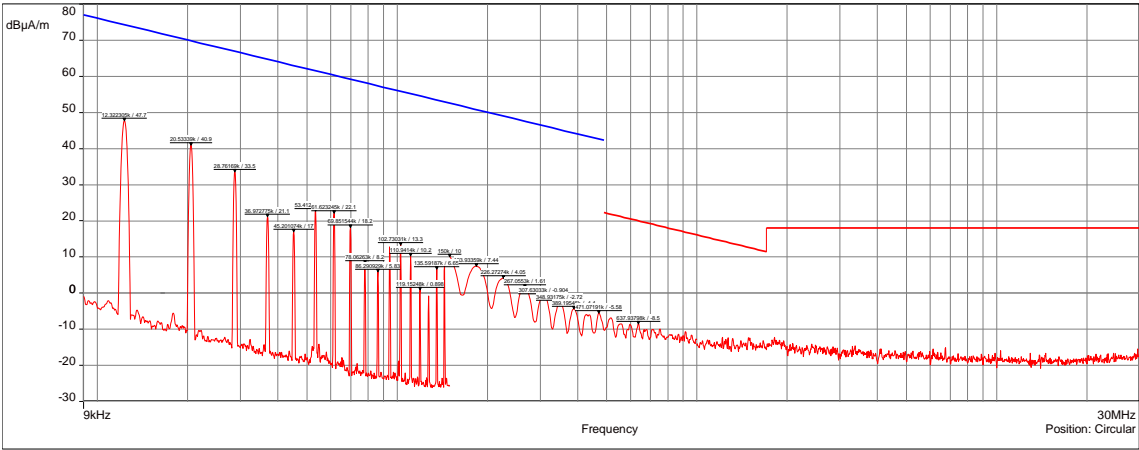
TRANSMITTER RADIATED SPURIOUS EMISSIONS AT FREQUENCIES <30MHz - GRAPH				
Tx Mode / Low Channel / 90° - Position 1			EMI5055	
EUT mode:	Tx mode		T (°C):	22.3
Test Date:	03/09/2020		H (%):	45.4
Test Operator:	OAT		P (hPa):	1011
<div style="text-align: right;"> — FCC/FCC Part 15 §209 Tx - Moyenne/3.0m/ — FCC/FCC Part 15 §209 Tx - QCrête/3.0m/ — Meas.Peak </div> 				
POSITION	FREQUENCIES	RBW	VBW	DETECTOR
Circular	9kHz-150kHz	300Hz	1kHz	Peak
Circular	150kHz-1MHz	10kHz	30kHz	Peak
Circular	1MHz-30MHz	10kHz	30kHz	Peak
Configuration:	N/A			
Comments:	Limit indicated on these plots are calculated with 40 dB/decade extrapolation factor and 51.5dB conversion factor.			
EUT modification(s): N/A				

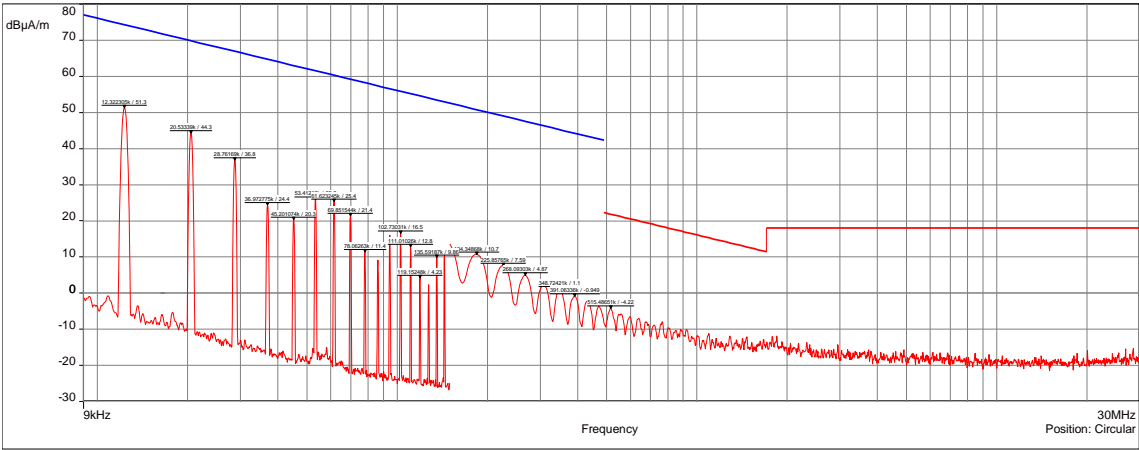
TRANSMITTER RADIATED SPURIOUS EMISSIONS AT FREQUENCIES <30MHz - GRAPH				
Tx MODE / Low CHANNEL / 0° - POSITION 2				EMI5056
EUT mode:	Tx mode			T (°C): 22.3
Test Date:	03/09/2020			H (%): 45.4
Test Operator:	OAT			P (hPa): 1011
 <p style="text-align: right;"> — FCC/FCC Part 15 §209 Tx - Moyenne/3.0m/ — FCC/FCC Part 15 §209 Tx - QCrête/3.0m/ — Meas.Peak </p>				
POSITION	FREQUENCIES	RBW	VBW	DETECTOR
Circular	9kHz-150kHz	300Hz	1kHz	Peak
Circular	150kHz-1MHz	10kHz	30kHz	Peak
Circular	1MHz-30MHz	10kHz	30kHz	Peak
Configuration:	N/A			
Comments:	Limit indicated on these plots are calculated with 40 dB/decade extrapolation factor and 51.5dB conversion factor.			
EUT modification(s): N/A				

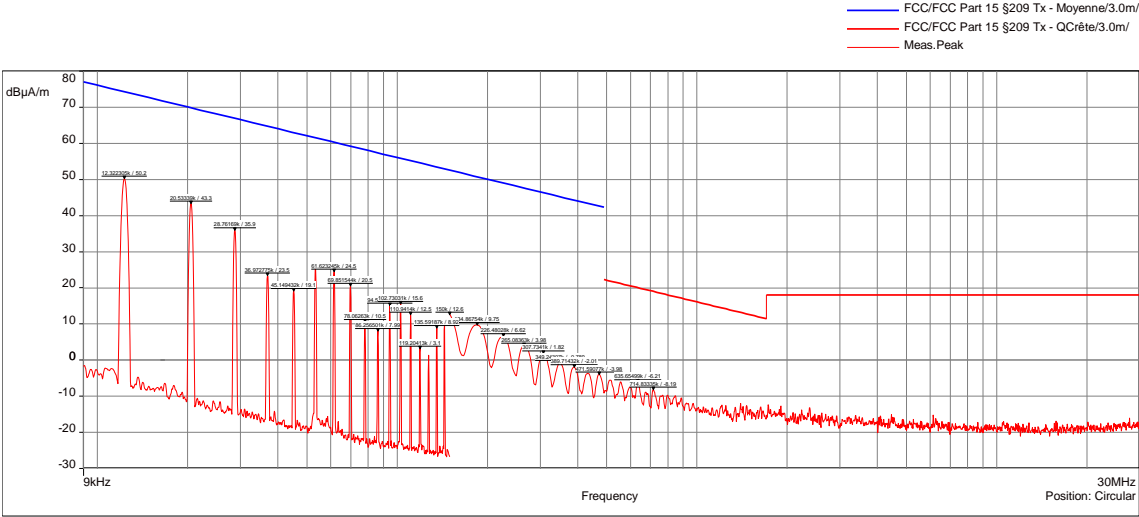
TRANSMITTER RADIATED SPURIOUS EMISSIONS AT FREQUENCIES <30MHz - GRAPH				
Tx Mode / Low Channel / 45° - Position 2				EMI5057
EUT mode:	Tx mode			T (°C): 22.3
Test Date:	03/09/2020			H (%): 45.4
Test Operator:	OAT			P (hPa): 1011
				
POSITION	FREQUENCIES	RBW	VBW	DETECTOR
Circular	9kHz-150kHz	300Hz	1kHz	Peak
Circular	150kHz-1MHz	10kHz	30kHz	Peak
Circular	1MHz-30MHz	10kHz	30kHz	Peak
Configuration:	N/A			
Comments:	Limit indicated on these plots are calculated with 40 dB/decade extrapolation factor and 51.5dB conversion factor.			
EUT modification(s): N/A				

TRANSMITTER RADIATED SPURIOUS EMISSIONS AT FREQUENCIES <30MHz - GRAPH				
Tx Mode / Low Channel / 90° - Position 2				EMI5058
EUT mode:	Tx mode			T (°C): 22.3
Test Date:	03/09/2020			H (%): 45.4
Test Operator:	OAT			P (hPa): 1011
POSITION	FREQUENCIES	RBW	VBW	DETECTOR
Circular	9kHz-150kHz	300Hz	1kHz	Peak
Circular	150kHz-1MHz	10kHz	30kHz	Peak
Circular	1MHz-30MHz	10kHz	30kHz	Peak
Configuration:	N/A			
Comments:	Limit indicated on these plots are calculated with 40 dB/decade extrapolation factor and 51.5dB conversion factor.			
EUT modification(s): N/A				

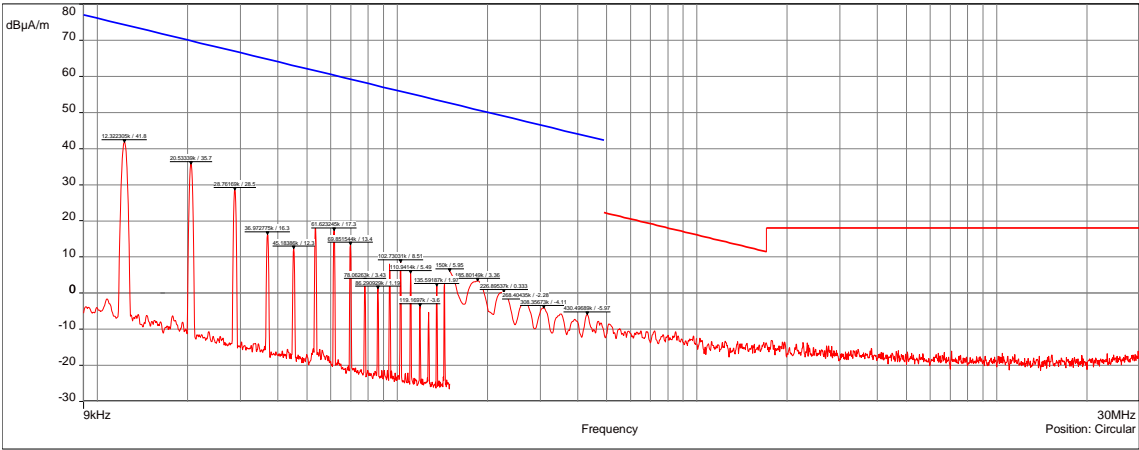
TRANSMITTER RADIATED SPURIOUS EMISSIONS AT FREQUENCIES <30MHz - GRAPH				
Tx MODE / Low CHANNEL / 0° - POSITION 3				EMI5059
EUT mode:	Tx mode			T (°C): 22.3
Test Date:	03/09/2020			H (%): 45.4
Test Operator:	OAT			P (hPa): 1011
— FCC/FCC Part 15 §209 Tx - Moyenne/3.0m/ — FCC/FCC Part 15 §209 Tx - QCrête/3.0m/ — Meas.Peak				
				
POSITION	FREQUENCIES	RBW	VBW	DETECTOR
Circular	9kHz-150kHz	300Hz	1kHz	Peak
Circular	150kHz-1MHz	10kHz	30kHz	Peak
Circular	1MHz-30MHz	10kHz	30kHz	Peak
Configuration:	N/A			
Comments:	Limit indicated on these plots are calculated with 40 dB/decade extrapolation factor and 51.5dB conversion factor.			
EUT modification(s): N/A				

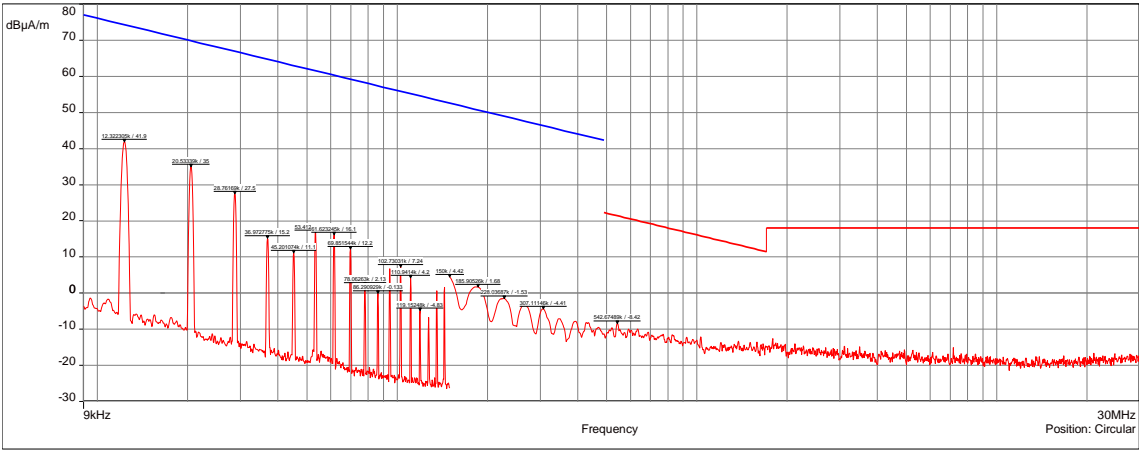
TRANSMITTER RADIATED SPURIOUS EMISSIONS AT FREQUENCIES <30MHz - GRAPH				
Tx Mode / Low Channel / 45° - Position 3				EMI5060
EUT mode:	Tx mode			T (°C): 22.3
Test Date:	03/09/2020			H (%): 45.4
Test Operator:	OAT			P (hPa): 1011
<div style="text-align: right;"> — FCC/FCC Part 15 §209 Tx - Moyenne/3.0m/ — FCC/FCC Part 15 §209 Tx - QCrête/3.0m/ — Meas.Peak </div> 				
POSITION	FREQUENCIES	RBW	VBW	DETECTOR
Circular	9kHz-150kHz	300Hz	1kHz	Peak
Circular	150kHz-1MHz	10kHz	30kHz	Peak
Circular	1MHz-30MHz	10kHz	30kHz	Peak
Configuration:	N/A			
Comments:	Limit indicated on these plots are calculated with 40 dB/decade extrapolation factor and 51.5dB conversion factor.			
EUT modification(s): N/A				

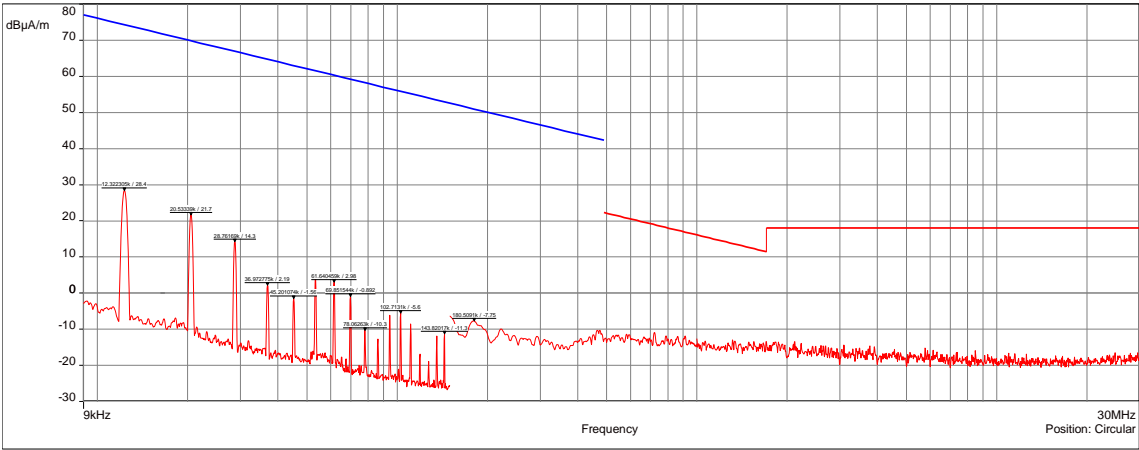
TRANSMITTER RADIATED SPURIOUS EMISSIONS AT FREQUENCIES <30MHz - GRAPH				
Tx Mode / Low Channel / 90° - Position 3				EMI5061
EUT mode:	Tx mode			T (°C): 22.3
Test Date:	03/09/2020			H (%): 45.4
Test Operator:	OAT			P (hPa): 1011
 <p style="text-align: right;"> — FCC/FCC Part 15 §209 Tx - Moyenne/3.0m/ — FCC/FCC Part 15 §209 Tx - QCrête/3.0m/ — Meas. Peak </p>				
POSITION	FREQUENCIES	RBW	VBW	DETECTOR
Circular	9kHz-150kHz	300Hz	1kHz	Peak
Circular	150kHz-1MHz	10kHz	30kHz	Peak
Circular	1MHz-30MHz	10kHz	30kHz	Peak
Configuration:	N/A			
Comments:	Limit indicated on these plots are calculated with 40 dB/decade extrapolation factor and 51.5dB conversion factor.			
EUT modification(s): N/A				

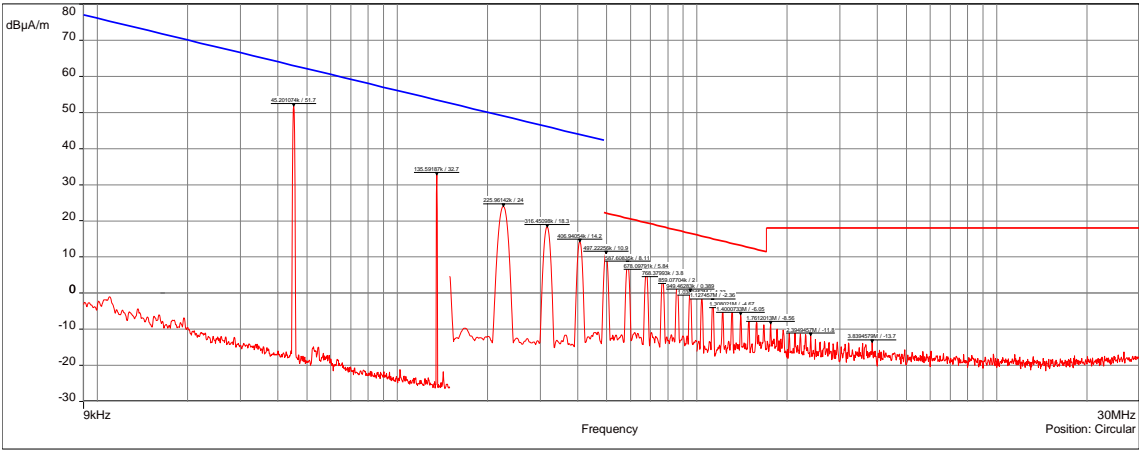
TRANSMITTER RADIATED SPURIOUS EMISSIONS AT FREQUENCIES <30MHZ - GRAPH				
Tx MODE / HIGH CHANNEL / 0° - POSITION 1			EMI5062	
EUT mode:	Tx mode		T (°C):	22.3
Test Date:	03/09/2020		H (%):	45.4
Test Operator:	OAT		P (hPa):	1011
<div style="text-align: right;"> — FCC/FCC Part 15 §209 Tx - Moyenne/3.0m/ — FCC/FCC Part 15 §209 Tx - QCrête/3.0m/ — Meas.Peak </div> 				
POSITION	FREQUENCIES	RBW	VBW	DETECTOR
Circular	9kHz-150kHz	300Hz	1kHz	Peak
Circular	150kHz-1MHz	10kHz	30kHz	Peak
Circular	1MHz-30MHz	10kHz	30kHz	Peak
Configuration:	N/A			
Comments:	Limit indicated on these plots are calculated with 40 dB/decade extrapolation factor and 51.5dB conversion factor.			
EUT modification(s): N/A				

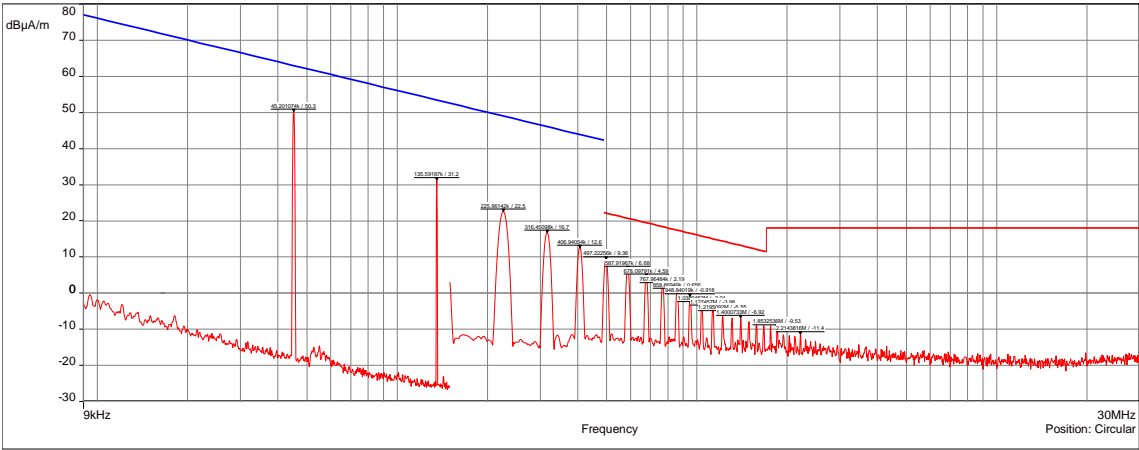
TRANSMITTER RADIATED SPURIOUS EMISSIONS AT FREQUENCIES <30MHz - GRAPH				
Tx MODE / HIGH CHANNEL / 45° - POSITION 1				EMI5063
EUT mode:	Tx mode			T (°C): 22.3
Test Date:	03/09/2020			H (%): 45.4
Test Operator:	OAT			P (hPa): 1011
<div style="text-align: right;"> — FCC/FCC Part 15 §209 Tx - Moyenne/3.0m/ — FCC/FCC Part 15 §209 Tx - QCrête/3.0m/ — Meas.Peak </div> 				
POSITION	FREQUENCIES	RBW	VBW	DETECTOR
Circular	9kHz-150kHz	300Hz	1kHz	Peak
Circular	150kHz-1MHz	10kHz	30kHz	Peak
Circular	1MHz-30MHz	10kHz	30kHz	Peak
Configuration:	N/A			
Comments:	Limit indicated on these plots are calculated with 40 dB/decade extrapolation factor and 51.5dB conversion factor.			
EUT modification(s): N/A				

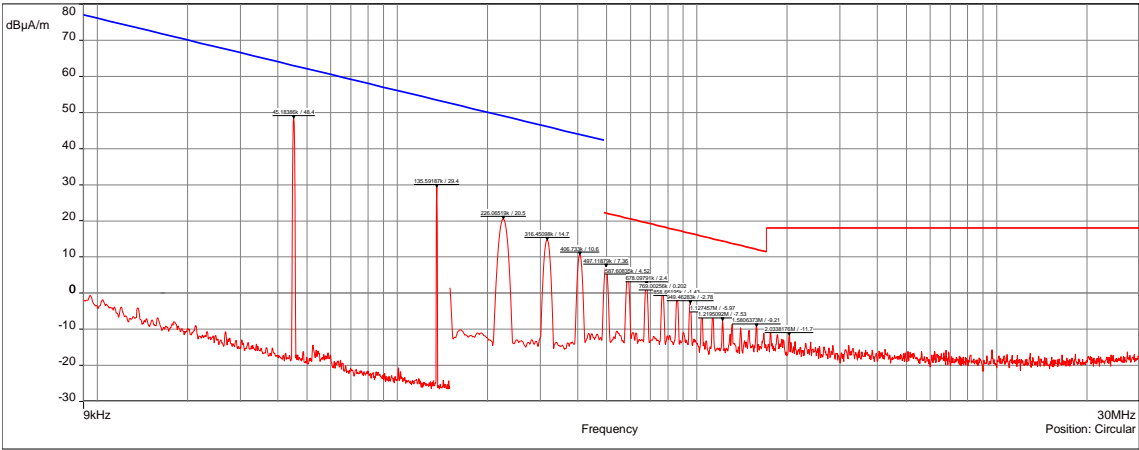
TRANSMITTER RADIATED SPURIOUS EMISSIONS AT FREQUENCIES <30MHz - GRAPH				
Tx MODE / HIGH CHANNEL / 90° - POSITION 1				EMI5064
EUT mode:	Tx mode			T (°C): 22.3
Test Date:	03/09/2020			H (%): 45.4
Test Operator:	OAT			P (hPa): 1011
<div style="text-align: right;"> — FCC/FCC Part 15 §209 Tx - Moyenne/3.0m/ — FCC/FCC Part 15 §209 Tx - QCrête/3.0m/ — Meas.Peak </div> 				
POSITION	FREQUENCIES	RBW	VBW	DETECTOR
Circular	9kHz-150kHz	300Hz	1kHz	Peak
Circular	150kHz-1MHz	10kHz	30kHz	Peak
Circular	1MHz-30MHz	10kHz	30kHz	Peak
Configuration:	N/A			
Comments:	Limit indicated on these plots are calculated with 40 dB/decade extrapolation factor and 51.5dB conversion factor.			
EUT modification(s): N/A				

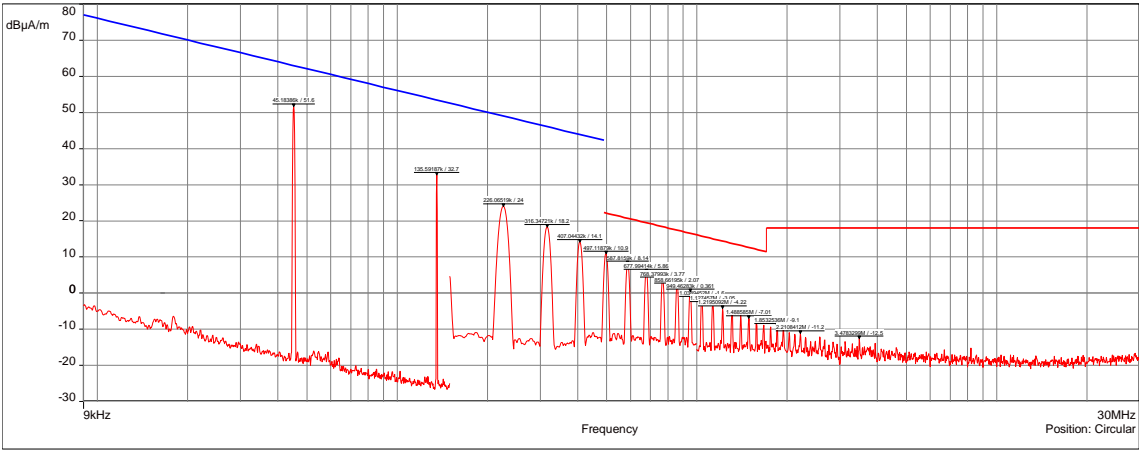
TRANSMITTER RADIATED SPURIOUS EMISSIONS AT FREQUENCIES <30MHZ - GRAPH				
Tx MODE / HIGH CHANNEL / 0° - POSITION 2				EMI5065
EUT mode:	Tx mode			T (°C): 22.3
Test Date:	03/09/2020			H (%): 45.4
Test Operator:	OAT			P (hPa): 1011
<div style="text-align: right;"> — FCC/FCC Part 15 §209 Tx - Moyenne/3.0m/ — FCC/FCC Part 15 §209 Tx - QCrête/3.0m/ — Meas.Peak </div> 				
POSITION	FREQUENCIES	RBW	VBW	DETECTOR
Circular	9kHz-150kHz	300Hz	1kHz	Peak
Circular	150kHz-1MHz	10kHz	30kHz	Peak
Circular	1MHz-30MHz	10kHz	30kHz	Peak
Configuration:	N/A			
Comments:	Limit indicated on these plots are calculated with 40 dB/decade extrapolation factor and 51.5dB conversion factor.			
EUT modification(s): N/A				

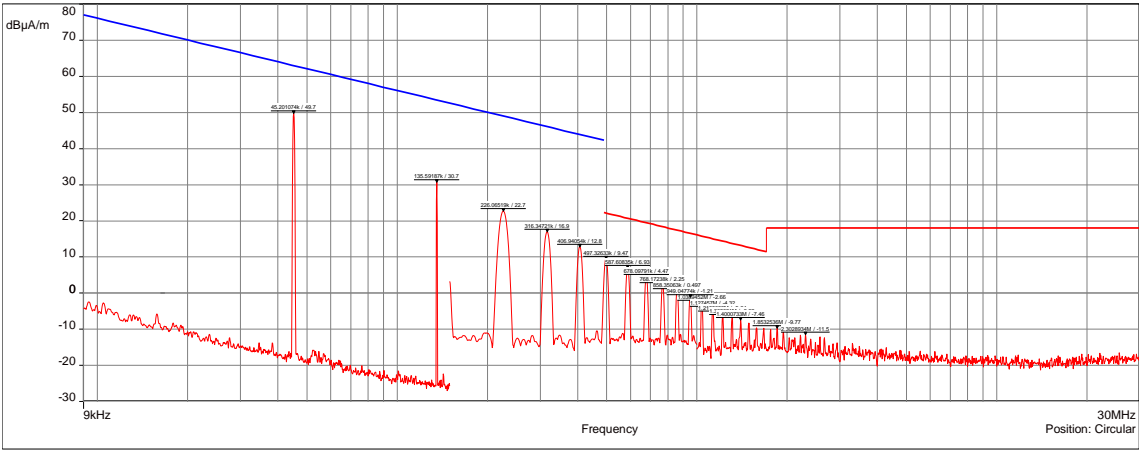
TRANSMITTER RADIATED SPURIOUS EMISSIONS AT FREQUENCIES <30MHz - GRAPH				
Tx MODE / HIGH CHANNEL / 45° - POSITION 2				EMI5066
EUT mode:	Tx mode			T (°C): 22.3
Test Date:	03/09/2020			H (%): 45.4
Test Operator:	OAT			P (hPa): 1011
<div style="text-align: right;"> — FCC/FCC Part 15 §209 Tx - Moyenne/3.0m/ — FCC/FCC Part 15 §209 Tx - QCrête/3.0m/ — Meas.Peak </div> 				
POSITION	FREQUENCIES	RBW	VBW	DETECTOR
Circular	9kHz-150kHz	300Hz	1kHz	Peak
Circular	150kHz-1MHz	10kHz	30kHz	Peak
Circular	1MHz-30MHz	10kHz	30kHz	Peak
Configuration:	N/A			
Comments:	Limit indicated on these plots are calculated with 40 dB/decade extrapolation factor and 51.5dB conversion factor.			
EUT modification(s): N/A				

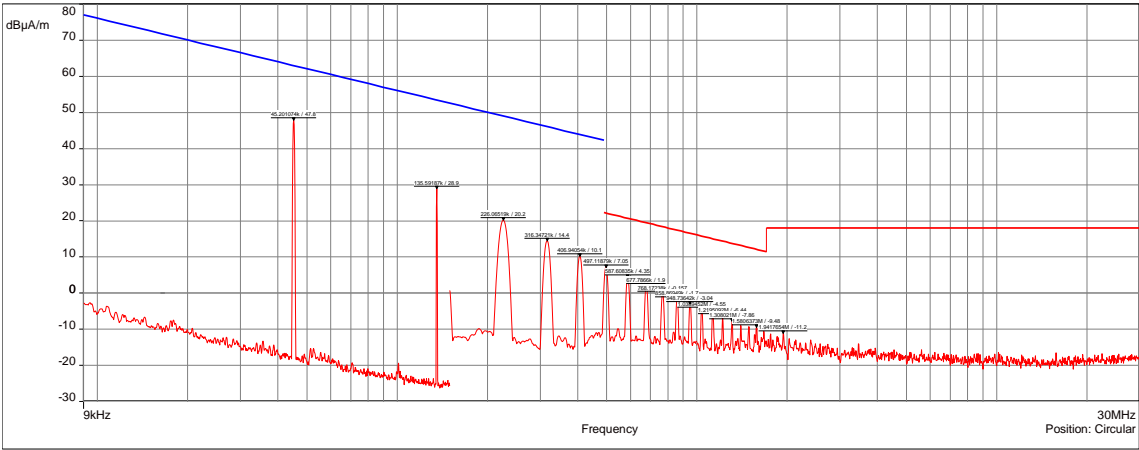
TRANSMITTER RADIATED SPURIOUS EMISSIONS AT FREQUENCIES <30MHZ - GRAPH				
Tx MODE / HIGH CHANNEL / 90° - POSITION 2				EMI5067
EUT mode:	Tx mode			T (°C): 22.3
Test Date:	03/09/2020			H (%): 45.4
Test Operator:	OAT			P (hPa): 1011
<div style="text-align: right;"> — FCC/FCC Part 15 §209 Tx - Moyenne/3.0m/ — FCC/FCC Part 15 §209 Tx - QCrête/3.0m/ — Meas.Peak </div> 				
POSITION	FREQUENCIES	RBW	VBW	DETECTOR
Circular	9kHz-150kHz	300Hz	1kHz	Peak
Circular	150kHz-1MHz	10kHz	30kHz	Peak
Circular	1MHz-30MHz	10kHz	30kHz	Peak
Configuration:	N/A			
Comments:	Limit indicated on these plots are calculated with 40 dB/decade extrapolation factor and 51.5dB conversion factor.			
EUT modification(s): N/A				

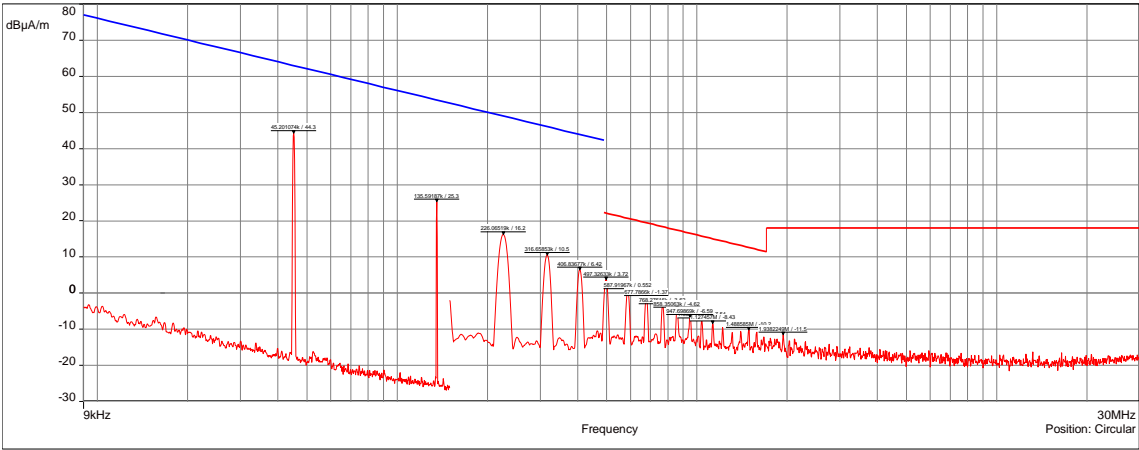
TRANSMITTER RADIATED SPURIOUS EMISSIONS AT FREQUENCIES <30MHz - GRAPH				
Tx MODE / HIGH CHANNEL / 0° - POSITION 3				EMI5068
EUT mode:	Tx mode			T (°C): 22.3
Test Date:	03/09/2020			H (%): 45.4
Test Operator:	OAT			P (hPa): 1011
				
POSITION	FREQUENCIES	RBW	VBW	DETECTOR
Circular	9kHz-150kHz	300Hz	1kHz	Peak
Circular	150kHz-1MHz	10kHz	30kHz	Peak
Circular	1MHz-30MHz	10kHz	30kHz	Peak
Configuration:	N/A			
Comments:	Limit indicated on these plots are calculated with 40 dB/decade extrapolation factor and 51.5dB conversion factor.			
EUT modification(s): N/A				

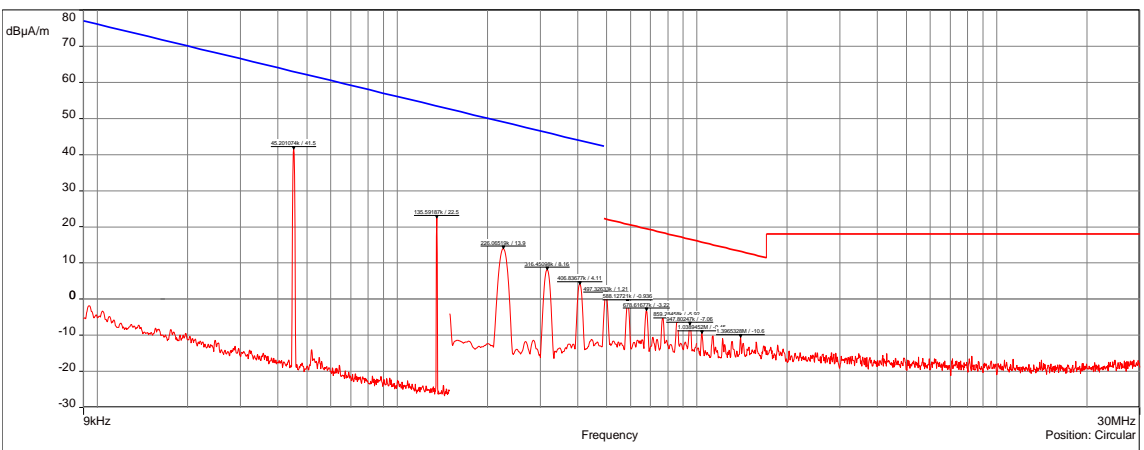
TRANSMITTER RADIATED SPURIOUS EMISSIONS AT FREQUENCIES <30MHz - GRAPH				
Tx MODE / HIGH CHANNEL / 45° - POSITION 3			EMI5069	
EUT mode:	Tx mode		T (°C):	22.3
Test Date:	03/09/2020		H (%):	45.4
Test Operator:	OAT		P (hPa):	1011
<div style="text-align: right;"> — FCC/FCC Part 15 §209 Tx - Moyenne/3.0m/ — FCC/FCC Part 15 §209 Tx - QCrête/3.0m/ — Meas.Peak </div> 				
POSITION	FREQUENCIES	RBW	VBW	DETECTOR
Circular	9kHz-150kHz	300Hz	1kHz	Peak
Circular	150kHz-1MHz	10kHz	30kHz	Peak
Circular	1MHz-30MHz	10kHz	30kHz	Peak
Configuration:	N/A			
Comments:	Limit indicated on these plots are calculated with 40 dB/decade extrapolation factor and 51.5dB conversion factor.			
EUT modification(s): N/A				

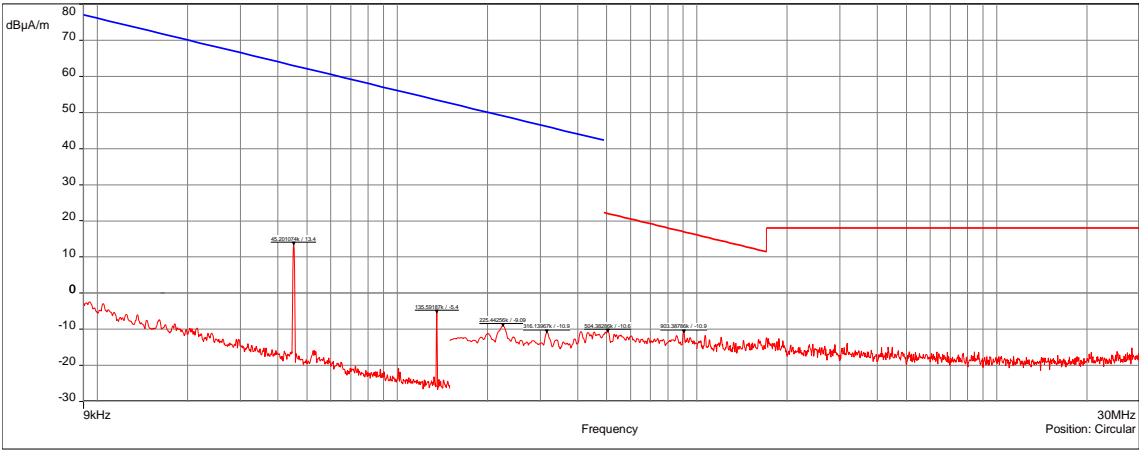
TRANSMITTER RADIATED SPURIOUS EMISSIONS AT FREQUENCIES <30MHz - GRAPH					
Tx MODE / HIGH CHANNEL / 90° - POSITION 3				EMI5070	
EUT mode:	Tx mode			T (°C):	22.3
Test Date:	03/09/2020			H (%):	45.4
Test Operator:	OAT			P (hPa):	1011
<div style="text-align: right;"> — FCC/FCC Part 15 §209 Tx - Moyenne/3.0m/ — FCC/FCC Part 15 §209 Tx - QCrête/3.0m/ — Meas.Peak </div> 					
POSITION	FREQUENCIES	RBW	VBW	DETECTOR	
Circular	9kHz-150kHz	300Hz	1kHz	Peak	
Circular	150kHz-1MHz	10kHz	30kHz	Peak	
Circular	1MHz-30MHz	10kHz	30kHz	Peak	
Configuration:	N/A				
Comments:	Limit indicated on these plots are calculated with 40 dB/decade extrapolation factor and 51.5dB conversion factor.				
EUT modification(s): N/A					

7.3. Transmitter radiated spurious emissions at frequencies >30MHz

Reference standard:	FCC part 15 Radio part 15.209 & CNR-Gen
Test method:	FCC part 15.109, 15.209, 15.205, 15.215, CNR-Gen
<p>General test setup: EUT is set on an insulating support at 80cm above the ground reference plane.</p> <p>Preliminary (peak) measurements were performed at an antenna to EUT separation distance of 3-meter. The EUT was rotated 360° about its azimuth with the receive antenna located at various heights in horizontal and vertical polarities.</p> <p>Final measurements (quasi-peak or average) were then performed in a semi-anechoic chamber or Open Area Test Site that complies to CISPR 16. The EUT was rotated 360° about its azimuth and adjusting the receive antenna height from 1 to 4 m.</p> <p>All frequencies were investigated, where applicable.</p> <p>For portable equipments a research of maximum level is done on the 3 axes. Only the highest levels are recorded.</p>	

TESTED CONFIGURATION	PARAMETER	SEVERITY	RESULT TAB.	VERDICT
Tx mode / All Freq - All Positions	30MHz-1GHz	15.209	EMI5042	PASS

LABORATORY PARAMETERS:	REQUIRED PRIOR TO THE TEST	DURING THE TEST
Ambient Temperature	15 to 35 °C	See Graph(es)
Relative Humidity	20 to 75 %	See Graph(es)
Atmospheric pressure	N/A	See Graph(es)
Test method deviation: N/A		
Supplementary information: N/A		

TEST EQUIPMENT USED					
CATEGORY	BRAND	TYPE	IDENTIFIER	CAL. DATE	CAL. DUE
Antenna	Electro Metrics	BIA-30HF	0824	13/06/2018	13/08/2021
Antenna	Rohde & Schwarz	HL223	3126	13/06/2018	13/08/2021
Cable	MegaPhase	F135N1N28	16664	25/10/2019	25/12/2021
Cable	MegaPhase	F135N1N28	16666	25/10/2019	25/12/2021
Cable	C&C	N-1.5m	10554	20/12/2019	20/02/2022
Cable	MegaPhase	N-3m	14852	29/10/2018	29/12/2020
Cable	SUCOFLEX	N-6,5m	14380	25/07/2019	25/09/2021
Cable	MegaPhase	N-8m	15813	12/11/2018	12/01/2021
Preamplifier	Mini-circuit	ZFL-1000LN	1321	25/06/2019	25/02/2021
Receiver	Rohde & Schwarz	FPL1003	16027	14/08/2020	14/10/2021
Software	Nexio		0000		
Thermohygrometer	Testo	608-H2	12269	07/05/2020	07/07/2022
Thermohygrometer	Bioblock Scientific	Météostar	0963	25/01/2019	25/03/2021

BAT-EMC software version: V3.18.0.26

Blank cells = Permanent validity

TRANSMITTER RADIATED SPURIOUS EMISSIONS AT FREQUENCIES >30MHZ - TABULATED RESULTS				
TX MODE / ALL FREQ - ALL POSITIONS				
Frequency (kHz)	Preliminary measurement (Pk) (dB μ V/m)	Final measurement (QP) (dB μ V/m)	Limit QP (dB μ V/m)	Margin (QP-Limit)
N/A	N/A	N/A	N/A	N/A
Supplementary information: No spurious emissions were detected.				

TEST SETUP PHOTO(S) -EUT POSITIONS



TEST SETUP PHOTO(S) -EUT POSITIONS



TEST SETUP PHOTO(S) – FOR FREQ < 200MHZ



TEST SETUP PHOTO(S) – FOR FREQ > 200MHZ



TRANSMITTER RADIATED SPURIOUS EMISSIONS AT FREQUENCIES >30MHZ - GRAPH			
TX MODE / ALL FREQ - ALL POSITIONS			EMI5042
EUT mode:	D-M2	T (°C):	23.5
Test Date:	03/09/2020	H (%):	52.6
Test Operator:	OAT	P (hPa):	1015

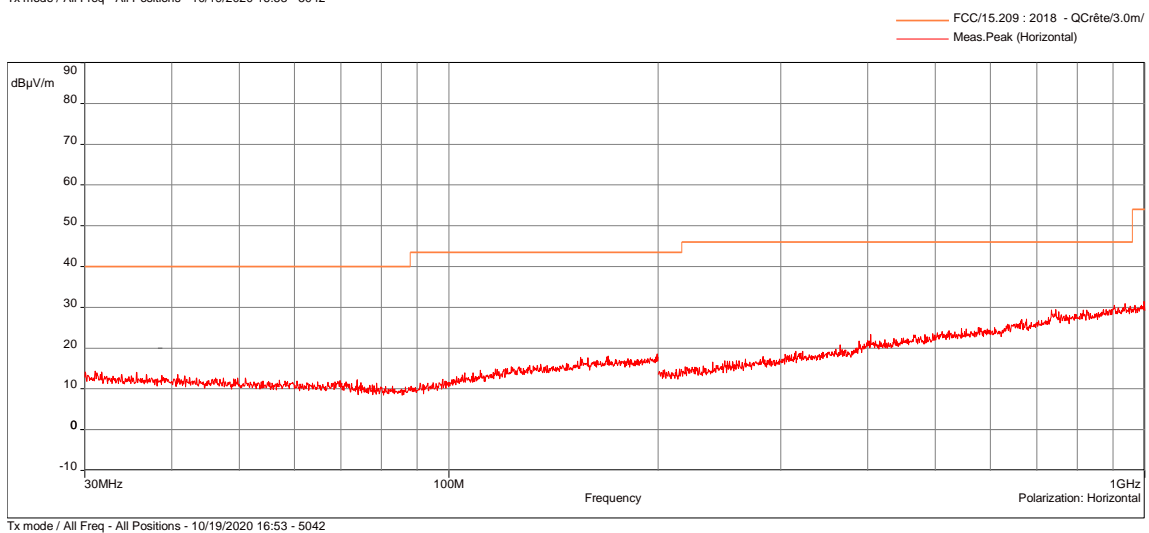
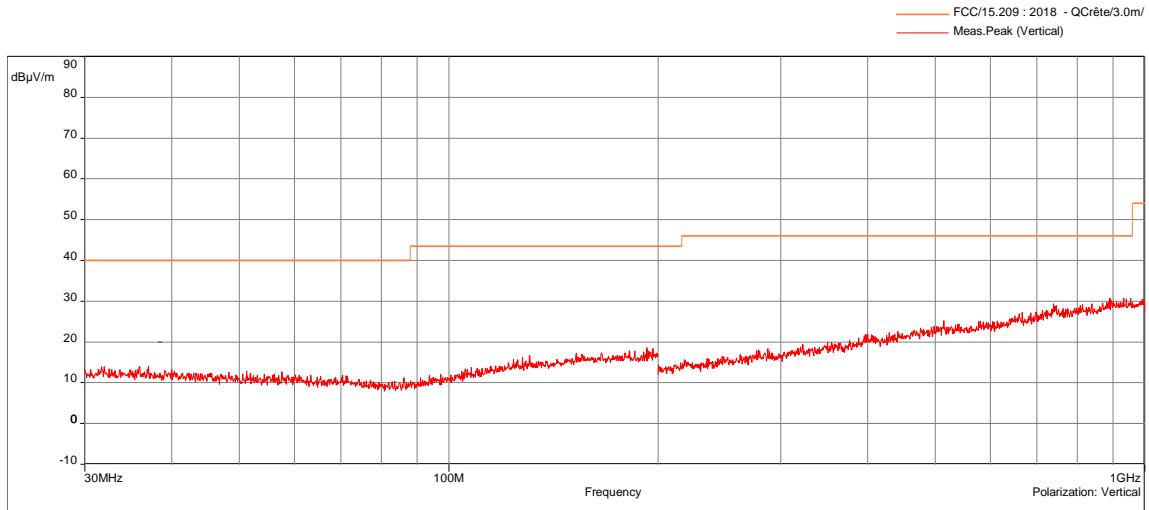

POSITION	FREQUENCIES	RBW	VBW	DETECTOR
Vertical	30MHz-200MHz	100kHz	300kHz	Peak
Horizontal	30MHz-200MHz	100kHz	300kHz	Peak
Vertical	200MHz-1GHz	100kHz	300kHz	Peak
Horizontal	200MHz-1GHz	100kHz	300kHz	Peak
Configuration:	N/A			
Comments:	N/A			
EUT modification(s): N/A				

7.4. H-field (radiated)

Reference standard:	FCC part 15 Radio part 15.209 & CNR-Gen
Test method:	FCC part 15.109, 15.209, 15.205, 15.215, CNR-Gen
<p>Test description: The H-field is measured with a shielded loop antenna connected to a measurement receiver at standard distance of 10 m.</p> <p>For EUT with integral or dedicated antenna, measurements are done on a normalized test site (OATS) that complies to CISPR 16.. EUT is set on an insulating support at 80cm above the ground reference plane.</p> <p>The EUT was rotated 360° in order to maximize radiated levels. Test antenna was oriented in 3 axes (0°, 45° and 90°).</p> <p>Then EUT is set inside the climatic enclosure. Measurements are repeated in extreme test conditions with the carrier level correlated with the maximum carrier level measured in normal conditions. EUT is powered by a stabilized power supply.</p>	

TEST CASE	EUT MODE	SEVERITY	RESULT TAB.	VERDICT
Low channel (OATS) / Position 1	Tx mode	N/A for information	EMI5743	N/A
Low channel (OATS) / Position 2	Tx mode		EMI5744	N/A
Low channel (OATS) / Position 3	Tx mode		EMI5745	N/A
High channel (OATS) / Position 1	Tx mode	15.209	EMI5746	PASS
High channel (OATS) / Position 2	Tx mode	15.209	EMI5747	PASS
High channel (OATS) / Position 3	Tx mode	15.209	EMI5748	PASS
Low channel / 25°C / 3.7Vdc	Tx mode	N/A for information	EMI5749	N/A
Low channel / 25°C / 4.5Vdc	Tx mode		EMI5750	N/A
Low channel / 25°C / 3.45Vdc	Tx mode		EMI5751	N/A
High channel / 25°C / 3.7Vdc	Tx mode	15.209	EMI5752	PASS
High channel / 25°C / 4.5Vdc	Tx mode	15.209	EMI5753	PASS
High channel / 25°C / 3.45Vdc	Tx mode	15.209	EMI5754	PASS
Low channel / 40°C / 3.7Vdc	Tx mode	N/A for information	EMI5755	N/A
Low channel / 40°C / 4.5Vdc	Tx mode		EMI5756	N/A
Low channel / 40°C / 3.45Vdc	Tx mode		EMI5757	N/A
High channel / 40°C / 3.7Vdc	Tx mode	15.209	EMI5758	PASS
High channel / 40°C / 4.5Vdc	Tx mode	15.209	EMI5759	PASS
High channel / 40°C / 3.45Vdc	Tx mode	15.209	EMI5760	PASS
Low channel / -5°C / 3.7Vdc	Tx mode	N/A for information	EMI5761	N/A
Low channel / -5°C / 4.5Vdc	Tx mode		EMI5762	N/A
Low channel / -5°C / 3.45Vdc	Tx mode		EMI5763	N/A
High channel / -5°C / 3.7Vdc	Tx mode	15.209	EMI5764	PASS
High channel / -5°C / 4.5Vdc	Tx mode	15.209	EMI5765	PASS
High channel / -5°C / 3.45Vdc	Tx mode	15.209	EMI5766	PASS

LABORATORY PARAMETERS:	REQUIRED PRIOR TO THE TEST	DURING THE TEST
Ambient Temperature	15 to 35 °C	25.3 °C
Relative Humidity	20 to 75 %	54.1 %
Atmospheric pressure	N/A	1016 hPa
<p>Test method deviation: The EUT is encapsulated in a casing. We were not able to measure its voltage supply during radiated tests</p>		
<p>Supplementary information: N/A</p>		

TEST EQUIPMENT USED					
CATEGORY	BRAND	TYPE	IDENTIFIER	CAL. DATE	CAL. DUE
Antenna	Emco	6507	4211	04/09/2020	04/11/2022
Antenna	Rohde & Schwarz	HFH2-Z2	5825	24/04/2020	24/06/2022
Attenuator	Radiall	R412710124	17329	22/06/2020	22/08/2023
Cable	N	3m	16421	04/05/2019	04/07/2021
Cable	Huber + Suhner	N-20m	8385	07/11/2017	07/01/2021
Cable	Huber + Suhner	SF102K	16041	28/02/2019	28/04/2021
Climatic enclosure	CLIMATS	EXCAL 7714-HA	14261	19/09/2019	19/11/2020
Open area test site	EMITECH	Salinelles	3482	10/10/2017	10/12/2020
Power supply	TTI	TSX-1820P	4365		
Receiver	Rohde & Schwarz	FSW43	14830	16/01/2019	16/03/2021
Spectrum analyzer	Agilent Technologies	E4440A	5824	24/04/2018	24/12/2020
Thermo-Hygro-Baromètre	LUFFT	OPUS 20	14563	05/02/2020	05/04/2021
Thermohygrometer	Testo	608-H2	12268	07/05/2020	07/07/2022
Wattmeter	Rohde & Schwarz	HMC 8015	17005	05/03/2020	05/05/2021

Blank cells = Permanent validity

TEST SETUP PHOTO(S) -EUT POSITION 1



TEST SETUP PHOTO(S) -EUT POSITION 2



TEST SETUP PHOTO(S) -EUT POSITION 3



TEST SETUP PHOTO(S) - (OATS) - FOR FREQ 4.1KHZ



TEST SETUP PHOTO(S) - (OATS) - FOR FREQ 45.19KHZ



TEST SETUP PHOTO(S) – EXTREME CONDITION



TEST SETUP PHOTO(S) – EXTREME CONDITION



H-FIELD (RADIATED) - TABULATED RESULTS				
TEST CONDITION	FREQUENCY	LEVEL	LIMIT (dB μ A/m)	RESULT TAB.
Low channel (OATS) / Position 1	4.1kHz	36.45 dB μ A/m (Azimuth: 0°) (Antenna Pos: 0°)	N/A for information	EMI5743
Low channel (OATS) / Position 2	4.1kHz	25.81 dB μ A/m (Azimuth: 0°) (Antenna Pos: 0°)		EMI5744
Low channel (OATS) / Position 3	4.1kHz	24.8 dB μ A/m (Azimuth: 30°) (Antenna Pos: 90°)		EMI5745
High channel (OATS) / Position 1	45.19kHz	25.19 dB μ A/m (Azimuth: 0°) (Antenna Pos: 0°)	42.09	EMI5746
High channel (OATS) / Position 2	45.19kHz	25.06 dB μ A/m (Azimuth: 0°) (Antenna Pos: 0°)		EMI5747
High channel (OATS) / Position 3	45.19kHz	12.52 dB μ A/m (Azimuth: 0°) (Antenna Pos: 90°)		EMI5748
Low channel / 25°C / 3.7Vdc	4.1 kHz	36.45 dB μ A/m	N/A for information	EMI5749
Low channel / 25°C / 4.5Vdc	4.1 kHz	36.45 dB μ A/m		EMI5750
Low channel / 25°C / 3.45Vdc	4.1 kHz	36.45 dB μ A/m		EMI5751
High channel / 25°C / 3.7Vdc	45.19kHz	25.19 dB μ A/m	42.09	EMI5752
High channel / 25°C / 4.5Vdc	45.19kHz	25.19 dB μ A/m		EMI5753
High channel / 25°C / 3.45Vdc	45.19kHz	25.19 dB μ A/m		EMI5754
Low channel / 40°C / 3.7Vdc	4.1 kHz	36.91 dB μ A/m	N/A for information	EMI5755
Low channel / 40°C / 4.5Vdc	4.1 kHz	36.91 dB μ A/m		EMI5756
Low channel / 40°C / 3.45Vdc	4.1 kHz	36.91 dB μ A/m		EMI5757
High channel / 40°C / 3.7Vdc	45.19kHz	25.14 dB μ A/m	42.09	EMI5758
High channel / 40°C / 4.5Vdc	45.19kHz	25.14 dB μ A/m		EMI5759
High channel / 40°C / 3.45Vdc	45.19kHz	25.14 dB μ A/m		EMI5760
Low channel / -5°C / 3.7Vdc	4.1 kHz	36.31 dB μ A/m	N/A for information	EMI5761
Low channel / -5°C / 4.5Vdc	4.1 kHz	36.31 dB μ A/m		EMI5762
Low channel / -5°C / 3.45Vdc	4.1 kHz	36.31 dB μ A/m		EMI5763
High channel / -5°C / 3.7Vdc	45.19kHz	24.5 dB μ A/m	42.09	EMI5764
High channel / -5°C / 4.5Vdc	45.19kHz	24.5 dB μ A/m		EMI5765
High channel / -5°C / 3.45Vdc	45.19kHz	24.5 dB μ A/m		EMI5766
EUT MODIFICATIONS	OPERATOR	TEST DATE	RESULT TAB.	
N/A	OAT	25/09/2020	-	

7.5. Modulation bandwidth

Reference standard:	FCC part 15 Radio part 15.215 and RSS Gen
Test method:	FCC part 15 Radio part 15.215 and RSS Gen
<p>Test description: The modulation bandwidth contains all associated side bands above a defined level.</p> <p>For EUT without dedicated or integral antenna, EUT is connected to the measuring receiver via 50Ω attenuator(s). Radiated carrier limit applies to the maximum measured conducted power value adjusted by the antenna gain.</p> <p>For EUT with integral or dedicated antenna, measurements are done on a normalized test site. EUT is set on an insulating support at 80cm above the ground reference plane.</p> <p>Then EUT is set inside the climatic enclosure. Measurements are repeated in extreme test conditions with the carrier levels correlated with the maximum carrier level measured in normal conditions.</p>	

TEST CASE AND CONDITIONS	MODULATION BANDWIDTH	RESULT TAB.	VERDICT
OBW / Low Channel	638.756 Hz	EMI5338	PASS
OBW / High Channel	637.759 Hz	EMI5339	PASS
20dB Bandwidth / Low Channel	752.92 Hz	EMI5356	N/A
20dB Bandwidth / High Channel	752.56 Hz	EMI5357	PASS

LABORATORY PARAMETERS:	REQUIRED PRIOR TO THE TEST	DURING THE TEST
Ambient Temperature	15 to 35 °C	22.1 °C
Relative Humidity	20 to 75 %	47.3 %
Atmospheric pressure	N/A	999 hPa
Test method deviation: N/A		
Supplementary information:		

TEST EQUIPMENT USED					
CATEGORY	BRAND	TYPE	IDENTIFIER	CAL. DATE	CAL. DUE
Attenuator	Radiall	R412710124	17329	22/06/2020	22/08/2023
Cable	N	3m	16421	04/05/2019	04/07/2021
Cable	Huber + Suhner	SF102K	16041	28/02/2019	28/04/2021
Climatic enclosure	CLIMATS	EXCAL 7714-HA	14261	19/09/2019	19/11/2020
Power supply	TTI	TSX-1820P	4365		
Receiver	Rohde & Schwarz	FSW43	14830	16/01/2019	16/03/2021
Thermo-Hygro-Baromètre	LUFFT	OPUS 20	14563	05/02/2020	05/04/2021
Thermohygrometer	Testo	608-H2	12268	07/05/2020	07/07/2022
Wattmeter	Rohde & Schwarz	HMC 8015	17005	05/03/2020	05/05/2021

Blank cells = Permanent validity

MODULATION BANDWIDTH - GRAPH	
OBW / Low CHANNEL	
EMI5338	
EUT mode:	D-M2
Test Date:	25/09/2020
Test Operator:	OAT

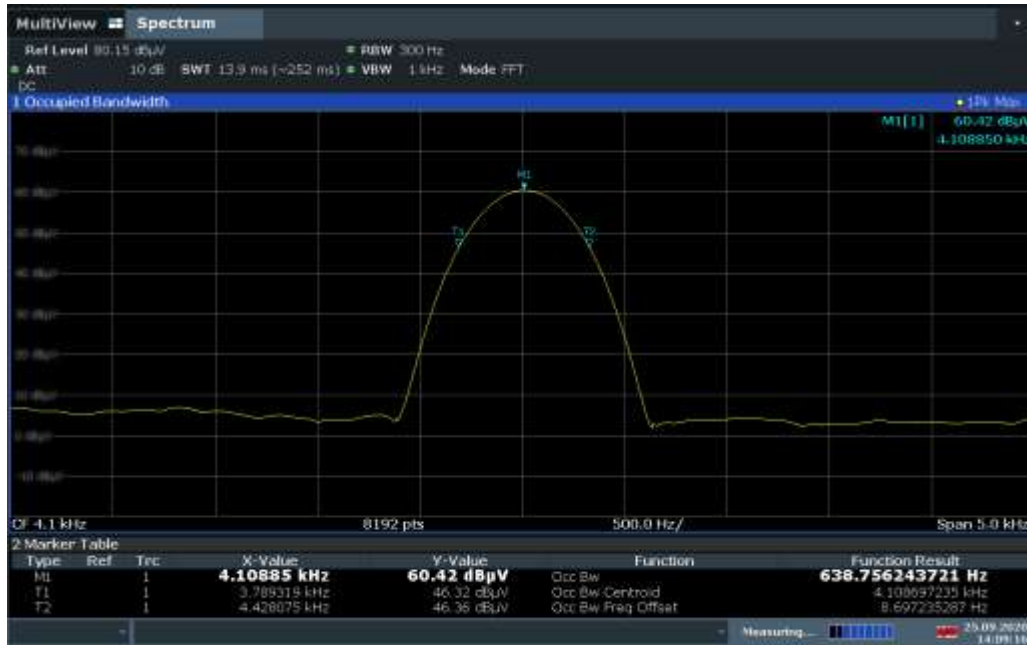

EUT modification(s): N/A

MODULATION BANDWIDTH - TABULATED RESULTS		
OBW / Low CHANNEL		EMI5338
f_{Low}	f_{High}	OBW
3.789 kHz	4.428 kHz	638.756 Hz

MODULATION BANDWIDTH - GRAPH	
OBW / HIGH CHANNEL	
EMI5339	
EUT mode:	D-M2
Test Date:	25/09/2020
Test Operator:	OAT

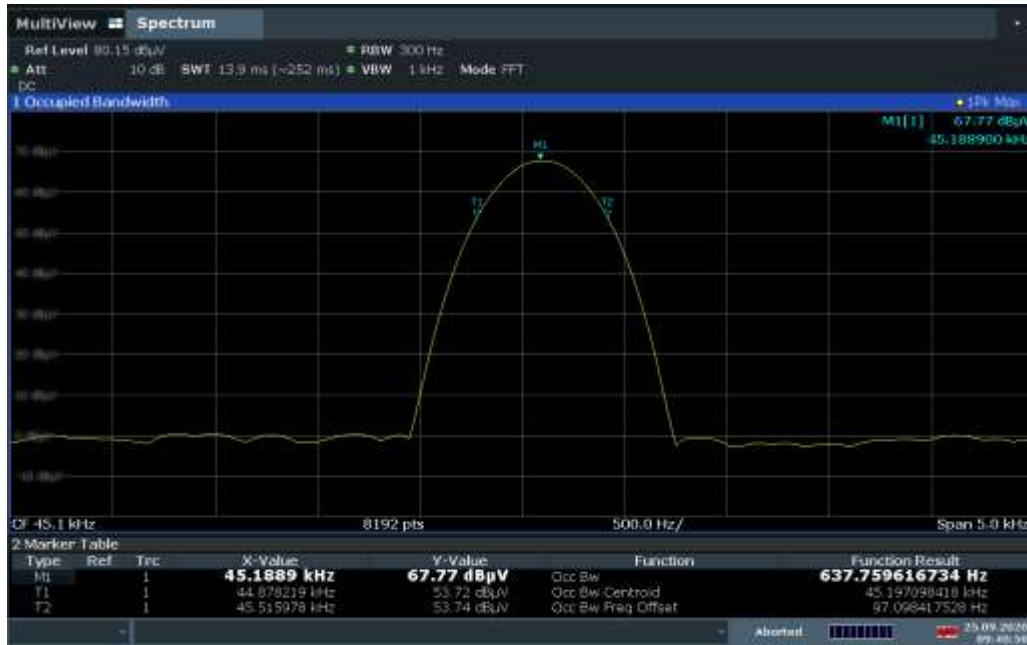

09:40:59 25.09.2020

EUT modification(s): N/A

MODULATION BANDWIDTH - TABULATED RESULTS		
OBW / HIGH CHANNEL / 25°C / 3.7VDC		
EMI5339		
f_{Low}	f_{High}	OBW
44.878 kHz	45.516 kHz	637.759 Hz

MODULATION BANDWIDTH - GRAPH	
20dB BANDWIDTH / LOW CHANNEL	
EMI5356	
EUT mode:	D-M2
Test Date:	25/09/2020
Test Operator:	OAT

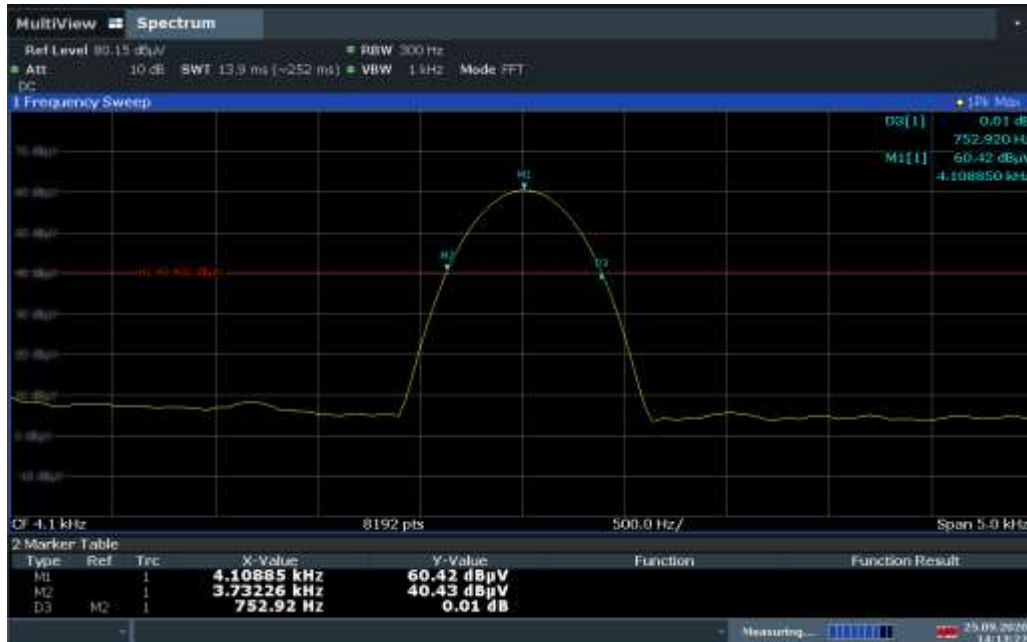

14:13:28 25.09.2020

EUT modification(s): N/A

MODULATION BANDWIDTH - TABULATED RESULTS		
20dB BANDWIDTH / LOW CHANNEL		EMI5356
f_{Low}	f_{High}	20dB Bandwidth
3.732 kHz	4.485 kHz	752.92 Hz

MODULATION BANDWIDTH - GRAPH	
20dB BANDWIDTH / HIGH CHANNEL	
EMI5357	
EUT mode:	D-M2
Test Date:	25/09/2020
Test Operator:	OAT

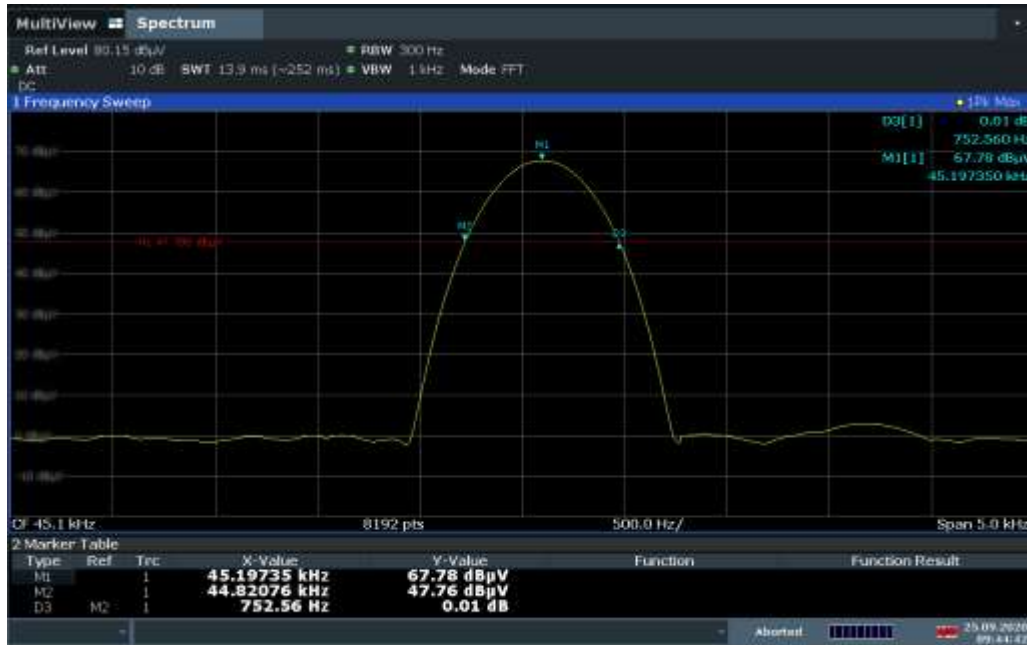

09:44:43 25.09.2020

EUT modification(s): N/A

MODULATION BANDWIDTH - TABULATED RESULTS		
20dB BANDWIDTH / HIGH		EMI5357
f_{Low}	f_{High}	20dB Bandwidth
44.821 kHz	45.573 kHz	752.56 Hz

7.6. Frequency error

Reference standard:	FCC part 15 Radio part 15.215 and RSS Gen
Test method:	FCC part 15 Radio part 15.215 and RSS Gen
<p>Test description: Frequency error is the difference between the measured unmodulated carrier frequency under extreme conditions and the nominal Centre Frequency as stated by the manufacturer.).</p> <p>EUT is set inside the climatic enclosure. It is connected to the measuring receiver via 50Ω attenuator(s). RBW=100Hz</p>	

TEST CASE	EUT MODE	SEVERITY	RESULT TAB.	VERDICT
Low channel / 25°C/ 3.7Vdc	Continuous Tx	0.001 %	EMI5813	PASS
Low channel / 25°C/ 4.2Vdc	Continuous Tx	0.001 %	EMI5814	PASS
Low channel / 25°C/ 3.45Vdc	Continuous Tx	0.001 %	EMI5815	PASS
High channel / 25°C/ 3.7Vdc	Continuous Tx	0.001 %	EMI5816	PASS
High channel / 25°C/ 4.2Vdc	Continuous Tx	0.001 %	EMI5817	PASS
High channel / 25°C/ 3.45Vdc	Continuous Tx	0.001 %	EMI5818	PASS
Low channel / 40°C/ 3.7Vdc	Continuous Tx	0.001 %	EMI5819	PASS
Low channel / 40°C/ 4.2Vdc	Continuous Tx	0.001 %	EMI5820	PASS
Low channel / 40°C/ 3.45Vdc	Continuous Tx	0.001 %	EMI5821	PASS
High channel / 40°C/ 3.7Vdc	Continuous Tx	0.001 %	EMI5822	PASS
High channel / 40°C/ 4.2Vdc	Continuous Tx	0.001 %	EMI5823	PASS
High channel / 40°C/ 3.45Vdc	Continuous Tx	0.001 %	EMI5824	PASS
Low channel / -5°C/ 3.7Vdc	Continuous Tx	0.001 %	EMI5825	PASS
Low channel / -5°C/ 4.2Vdc	Continuous Tx	0.001 %	EMI5826	PASS
Low channel / -5°C/ 3.45Vdc	Continuous Tx	0.001 %	EMI5827	PASS
High channel / -5°C/ 3.7Vdc	Continuous Tx	0.001 %	EMI5828	PASS
High channel / -5°C/ 4.2Vdc	Continuous Tx	0.001 %	EMI5829	PASS
High channel / -5°C/ 3.45Vdc	Continuous Tx	0.001 %	EMI5830	PASS

LABORATORY PARAMETERS:	REQUIRED PRIOR TO THE TEST	DURING THE TEST
Ambient Temperature	15 to 35 °C	22.1 °C
Relative Humidity	20 to 75 %	47.3 %
Atmospheric pressure	N/A	999 hPa
Test method deviation: N/A		
Supplementary information: EUT power supply is replaced by a stabilized power supply.		

TEST EQUIPMENT USED					
CATEGORY	BRAND	TYPE	IDENTIFIER	CAL. DATE	CAL. DUE
Attenuator	Radiall	R412710124	17329	22/06/2020	22/08/2023
Cable	N	3m	16421	04/05/2019	04/07/2021
Cable	Huber + Suhner	SF102K	16041	28/02/2019	28/04/2021
Climatic enclosure	CLIMATS	EXCAL 7714-HA	14261	19/09/2019	19/11/2020
Power supply	TTI	TSX-1820P	4365		
Receiver	Rohde & Schwarz	FSW43	14830	16/01/2019	16/03/2021
Thermo-Hygro-Baromètre	LUFFT	OPUS 20	14563	05/02/2020	05/04/2021
Thermohygrometer	Testo	608-H2	12268	07/05/2020	07/07/2022
Wattmeter	Rohde & Schwarz	HMC 8015	17005	05/03/2020	05/05/2021

Blank cells = Permanent validity



TEST SETUP PHOTO(S)



FREQUENCY ERROR - TABULATED RESULTS				
TEST CASE	FREQUENCY	FREQUENCY ERROR	LIMIT	RESULT TAB.
Low channel / 25°C/ 3.7Vdc	4.10885 kHz	N/A	0.001 %	EMI5813
Low channel / 25°C/ 4.2Vdc	4.10885 kHz	0	0.001 %	EMI5814
Low channel / 25°C/ 3.45Vdc	4.10885 kHz	0	0.001 %	EMI5815
High channel / 25°C/ 3.7Vdc	45.1889 kHz	N/A	0.001 %	EMI5816
High channel / 25°C/ 4.2Vdc	45.1889 kHz	0	0.001 %	EMI5817
High channel / 25°C/ 3.45Vdc	45.1889 kHz	0	0.001 %	EMI5818
Low channel / 40°C/ 3.7Vdc	4.10885 kHz	0	0.001 %	EMI5819
Low channel / 40°C/ 4.2Vdc	4.10885 kHz	0	0.001 %	EMI5820
Low channel / 40°C/ 3.45Vdc	4.10885 kHz	0	0.001 %	EMI5821
High channel / 40°C/ 3.7Vdc	45.1889 kHz	0	0.001 %	EMI5822
High channel / 40°C/ 4.2Vdc	45.1889 kHz	0	0.001 %	EMI5823
High channel / 40°C/ 3.45Vdc	45.1889 kHz	0	0.001 %	EMI5824
Low channel / -5°C/ 3.7Vdc	4.10885 kHz	0	0.001 %	EMI5825
Low channel / -5°C/ 4.2Vdc	4.10885 kHz	0	0.001 %	EMI5826
Low channel / -5°C/ 3.45Vdc	4.10885 kHz	0	0.001 %	EMI5827
High channel / -5°C/ 3.7Vdc	45.1889 kHz	0	0.001 %	EMI5828
High channel / -5°C/ 4.2Vdc	45.1889 kHz	0	0.001 %	EMI5829
High channel / -5°C/ 3.45Vdc	45.1889 kHz	0	0.001 %	EMI5830

EUT MODIFICATIONS	OPERATOR	TEST DATE	RESULT TAB.
N/A	OAT	25/09/2020	-

●●● End of test report ●●●