



TEST REPORT

**According to FCC, CFR 47 Part 15 and 18
And Industry Canada
According to RSS 210 and ICES 001**

**DEUS
Search coil
XP225**

N°560101-CC-1-a

The reproduction of this document is authorised only if integral. Any partial reproduction must be authorised by GYL Technologies. This document results of test applied on one sample. It doesn't prejudge of conformity of all products to the tested sample.

GYL technologies
Parc d'activités de Lanserre
21 rue de la Fuye
49610 JUIGNE SUR LOIRE
FRANCE
Tel. : +33 (0) 2.41.57.57.40
Fax : +33 (0) 2.41.45.25.77



Summary

1. REFERENCE AND RECORD OF REVISIONS OF THE TEST REPORT:	3
1 INTERPRETATION AND REMARKS:	3
1.1 RESULTS:	3
2 GENERAL INFORMATION:	4
2.1 APPLICANT:	4
2.2 MANUFACTURER:	4
2.3 TEST DATE:	4
2.4 TEST SITE:	4
3 INTRODUCTION:	5
4 MEASUREMENT EQUIPMENT LIST:	5
5 CONFIGURATION OF TESTED SYSTEM:	6
6 EXERCISING TEST CONDITIONS:	8
7 CONFORMANCE STATEMENT:	8
7.1 STANDARDS REFERENCED FOR THIS REPORT:	8
7.2 JUSTIFICATION:	8
8 TEST ACCORDING TO CFR 47 PART 15	9
8.1 REFERENCE DOCUMENTATION:	9
8.2 POWER LINE CONDUCTED EMISSIONS MEASUREMENTS (15.107&207):	9
8.2.1 RESULTS (Class B):	9
8.2.2 INTERPRETATION AND REMARKS:	13
8.3 RADIATED EMISSIONS MEASUREMENTS (15.109&209):	14
8.3.1 RESULTS (Class B):	14
8.3.2 INTERPRETATION AND REMARKS:	15
8.4 INTENTIONAL RADIATOR OPERATION WITHIN THE BAND 2400 – 2483.5MHz §15.249:	16
8.4.1 MAXIMUM PEAK OUTPUT POWER §15.249(a) (c):	16
8.4.2 BANDWIDTH MEASUREMENT:	17
8.4.3 Spurious and part 18 emissions measurements §15.249(d):	19
8.4.3.1 RADIATED SPURIOUS (§15.205, §15.209,§15.249) AND §18, ICES001 EMISSION BELOW 1000MHZ:	19
8.4.3.2 RADIATED SPURIOUS EMISSION ABOVE 1000MHZ §15.205, §15.209,§15.249:	23
8.4.3.3 RECEIVER SPURIOUS RADIATION:	26

OTHER ASSOCIATED FILES:

- 560101 Exhibit 1 ID label XFJ225
- 560101 Exhibit 3 External Photos XFJ225
- 560101 Exhibit 4 Block Diagrams XFJ225
- 560101 Exhibit 5 Schematics XFJ225
- 560101 Exhibit 7 Test Setup Photos XFJ225
- 560101 Exhibit 8 User's Manual XFJ225
- 560101 Exhibit 9 Internal Photos XFJ225
- 560101 Exhibit 12 operational description XFJ225

1. Reference and record of revisions of the test report:

Test report number :	Revision :	Number of pages	Modification reasons :
560101-CC-1-a	a	28	creation
Redactor : O.ROY		Date of writing : 15 March 2010	
Technical control: O. ROY 		Quality Control: M. CABALLERO 	

1 Interpretation and remarks:

1.1 RESULTS:

This equipment complies with the rules of the FCC section 15.249 and related sections and RSS-210 Issue 7 Appendix 2.9 concerning its radio functions.

This equipment complies with the rules of the FCC section 15.205, 15.207, 15.209 and related sections concerning its intentional radiator functions.

This equipment complies with the rules of the FCC section 15.107, 15.109 class B and related sections concerning its non intentional radiator functions (charging).

This equipment complies with the FCC part 18 and ICES001 concerning its metal detection function

	<p>FCC and IC CERTIFICATION TEST REPORT EQUIPMENT FCC ID:XFJ225 IC:8392A-XP225 The 28 pages of this report are not sharable</p>	<p style="text-align: right;">4</p> <p>Identification : 560101-CC-1-a FCC registration n°90469 IC registration n°IC4452A-1</p>
--	---	--

2 GENERAL INFORMATION:

2.1 APPLICANT:

Xplorer
40, chemin du moulin
31320 MERVILLA
France

2.2 MANUFACTURER:

Xplorer
40, chemin du moulin
31320 MERVILLA
France

2.3 TEST DATE:

December 22, 2008 – January 7, 12, 22, 29 and May 28, 2009

2.4 TEST SITE:

GYL Technologies
Parc d'activités de Lanserre
49610 Juigné sur Loire – France
FCC registration Number: 90469
IC registration Number: IC 4452A-1



3 INTRODUCTION:

The following test report for equipments with RF part is written in accordance with Part 15 of the Federal Communications Commissions and RSS 210 of Industry Canada. The Equipment Under Test (EUT) was a metal detector composed of the following elements:

- Search coil (object of this report) XP225
- Remote control (see FCC ID: XFJIHM)
- Head phone (see FCC ID: XFJBKF)

The test results reported in this document relate only to the items that were tested.

All measurements contained in this Application were conducted in accordance with ANSI C63.4 Methods of Measurement of Radio Noise Emissions of 2003. The instrumentation utilized for the measurements conforms to the ANSI C63.4 standard for EMI and Field Strength Instrumentation. Some accessories are used to increase sensitivity and prevent overloading of the measuring instrument. These are explained in this report. Calibration checks are performed regularly on the instruments, and all accessories including the high pass filter, preamplifier and cables.

All conducted and radiated emissions measurements were performed manually at GYL TECHNOLOGIES. The radiated emissions measurements required by the rules were performed on the three to ten meters, open field, test site maintained by GYL Technologies Parc d'activités de Lanserre, 49610 Juigné sur Loire , France. Complete description and site attenuation measurement data have been placed on file with the Federal Communications Commission.

4 MEASUREMENT EQUIPMENT LIST:

PART TYPE	MANUFACTURER	MODEL	GYL NUMBER	CALIBRATION DATE	CALIBRATION DUE DATE
RECEIVERS					
Receiver	Rohde & Schwarz	ESI 7	M02020	May-08	May-09
Spectrum analyzer	Rohde & Schwarz	FSEM 30	M02021	May-08	May-09
Filter 150 kHz	Rohde & Schwarz	EZ25	M02040	May-08	May-09
ARTIFICIAL MAINS NETWORKS					
LISN (50µH / 5/50Ω)	Rohde & Schwarz	ESH3-Z5	M02027	Jan-08	Jan-09
ANTENNAS					
Bilog (30-2000MHz)	CHASE	CBL-6112	M02031	June-08	June-09
Bilog (30-2000MHz)	CHASE	CBL-6112	M02032	June-08	June-09
Horn antenna	EMCO	3115	M02045	March-08	March-09
Horn antenna	EMCO	3160-09	M04002		
Active loop antenna	Rohde & Schwarz	HFH2-Z2	M01128	April-08	April-09
AMPLIFIERS					
Amplifier 0.5-18GHz	LUCIX Corporation	S005180L3201	M08007	April-08	April-09
Amplifier 18.5-26.5GHz	LUCIX Corporation	S180L3201	M08008	March-08	March-09

All equipments where within their calibration period when used.

5 CONFIGURATION OF TESTED SYSTEM:

For the measurements, according to FCC part 15 (Sub part B) §15.107, 15.207 and 15.109, 15.209 test plan, the equipments under test were tested with their ancillary equipments.

E.U.T.: Equipment Under Test.

E.U.T.1 : Search Coil.

E.U.T.2 : AC adapter

A1: Power cord of Laptop with AC adapter

D1: USB cable

Aux1: Laptop with its AC adapter

Aux 2: Headphone

Aux 3: Remote control

Configuration 1

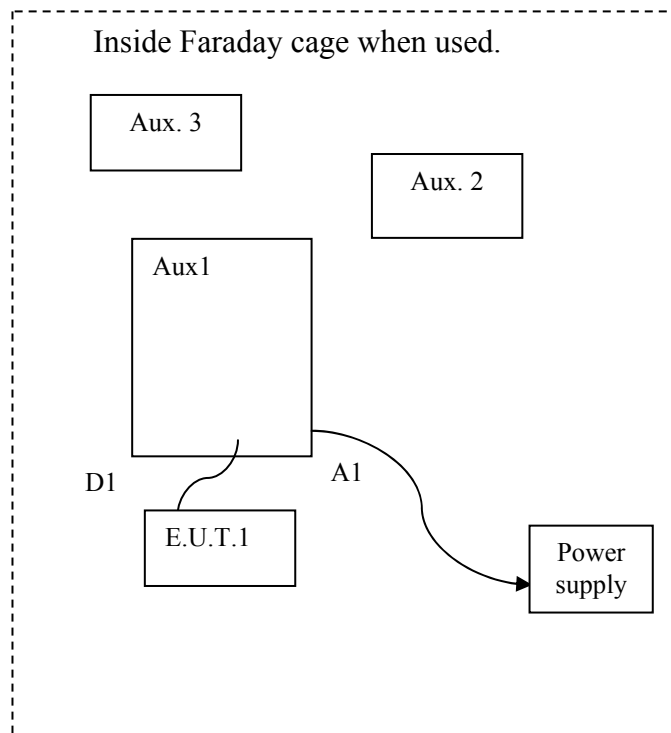

Configuration 2

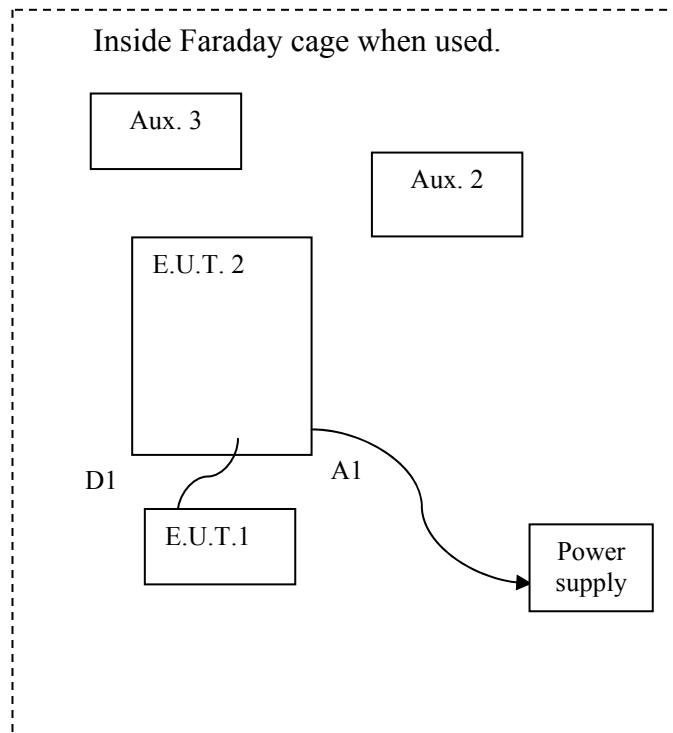

Configuration 3





6 EXERCISING TEST CONDITIONS:

- Operating conditions in configuration 1 and 2 :

Search coil connected to the Ac adapter for charging
Remote control N°1 and Headphone activated
Sensor head activated with Aux2

Used for AC conducted emissions. Configuration 1 for complementary radiated emission from 30MHz to 1GHz.

- Operating conditions in configuration 3:

Used for radio emissions

Measurements have been carried out, successively, in low, middle and high channel with modulation.
Type of modulation: GFSK without hopping.
All tests have been carried out at maximum power.
Operating frequencies: 2404 – 2476MHz

7 CONFORMANCE STATEMENT:

7.1 STANDARDS REFERENCED FOR THIS REPORT:

PART 2: 2004	Frequency allocations and Radio Treaty Matters General Rules and Regulations
PART 15: 2008	Radio frequency devices
ANSI C63.4-2003	Standard format measurements/technical report personal computer and peripherals
PART 18:2007	ISM devices
RSS-Gen Issue 2	Radio frequency devices General Rules and Regulations
RSS-210 Issue 7	Radio frequency devices
ICES-001 Issue 4	ISM devices
CISPR 11:2004	ISM devices

7.2 JUSTIFICATION:

The equipments tested are information technology equipment with radio part. They can be used in residential commercial or light industry areas.

The following sub clauses of the standard mentioned above are:

- Part 15.249 for intentional radiator in band 2400-2483.5MHz.
- Part 15.207 and 15.209 (subpart C) for respectively conducted and radiated emission for intentional radiator.
- RSS-210 Issue 7 Appendix 2.9 for intentional radiator in band 2400-2483.5MHz
- Part 15.205 for restricted bands of operation.
- Part 15.107 and 15.109 (subpart B) for respectively conducted and radiated emission for unintentional radiator (Charger) Class B.
- ICES-001 and Part 18 for metal detection function.



8 TEST ACCORDING TO CFR 47 Part 15

8.1 REFERENCE DOCUMENTATION:

FCC part 15 (Sub part B) §15.107, 15.109, 15.205, 15.207, 15.209 and 15.249 of 2008.

8.2 POWER LINE CONDUCTED EMISSIONS MEASUREMENTS (15.107&207):

The power line conducted emission measurements were performed in a semi anechoic chamber.

The EUT were placed on a non conductive 80 centimeters high wooden table.

The EUT which can be powered were supplied through a 50Ω/50μH Line Impedance Stabilization Network (EUT's LISN).

The EUT's LISN was supplied with A.C. filters placed on the outside wall of the shielded enclosure.

The filters and the EUT's LISN housing are bonded to the ground plane of the shielded enclosure.

The spectrum analyzer was connected to the A.C. line through an isolation transformer.

The 50Ω output of the EUT's LISN was connected to the spectrum analyzer input through a Rohde & Schwartz 150 kHz high-pass filter.

The filter is used to prevent overload of the spectrum analyzer from noise below 150 kHz.

Conducted emission levels were measured on each current-carrying line with the receiver operating in the CISPR quasi-peak mode (or average mode if applicable).

8.2.1 RESULTS (Class B):

The initial conducted emissions measurements consists of a prescan (tester in receiver mode), in order to determine the maximum quasi peak and average values.

- If the conducted emissions have limits showing a margin lower than 5dB, data collection measurement is performed on the six (6) highest frequencies to determine the compliance of the EUT.
- If the conducted emissions have limits showing a margin greater than 5dB, data collection measurement is not performed and the curves are given as evidence of compliance.

The following table lists worst-case conducted emission data. Specifically: emission frequency, measurement level (including cable loss and transducer factors) in quasi-peak and average mode and margin.

The conducted tests were performed with the EUT running program loaded, and the emissions were carried out between 150 kHz to 30 MHz on the NEUTRAL SIDE and LIVE SIDE, herein referred to as Neutral, and Live respectively.

ESI 7 EMI TEST RECEIVER IN RECEIVER MODE	
Peak measurement time	5 ms
step size	4kHz
Preamplifier	OFF
Preselector	ON
Resolution bandwidth	9 kHz
Final Quasi Peak measurement time	1 s minimum
Final average measurement time	1 s minimum

All readings are quasi-peak unless stated otherwise.



Power supply of laptop (230V 50Hz) configuration 1

Tests performed by Aziz ABBASSI at GYL Technologies laboratories on December 22, 2008.

• **Neutral:**

Frequency (MHz)	Quasi-peak (dB(μV))	QP Limit (dB(μV))	QP margin (dB)	Frequency (MHz)	Average (dB(μV))	Average Limit (dB(μV))	Average margin (dB)
0.170	42.8	65.0	22.2	0.214	35.4	53.0	17.6
0.222	43.2	62.7	19.5	0.990	26.4	46.0	19.6
4.162	23.7	56.0	32.3	1.098	29.0	46.0	17.0
4.622	29.3	56.0	26.7	1.206	30.5	46.0	15.5
14.622	36.1	60.0	23.9	12.290	36.1	50.0	13.9
14.790	33.5	60.0	26.5	14.242	30.3	50.0	19.7

Legend: Green curve represents the peak values

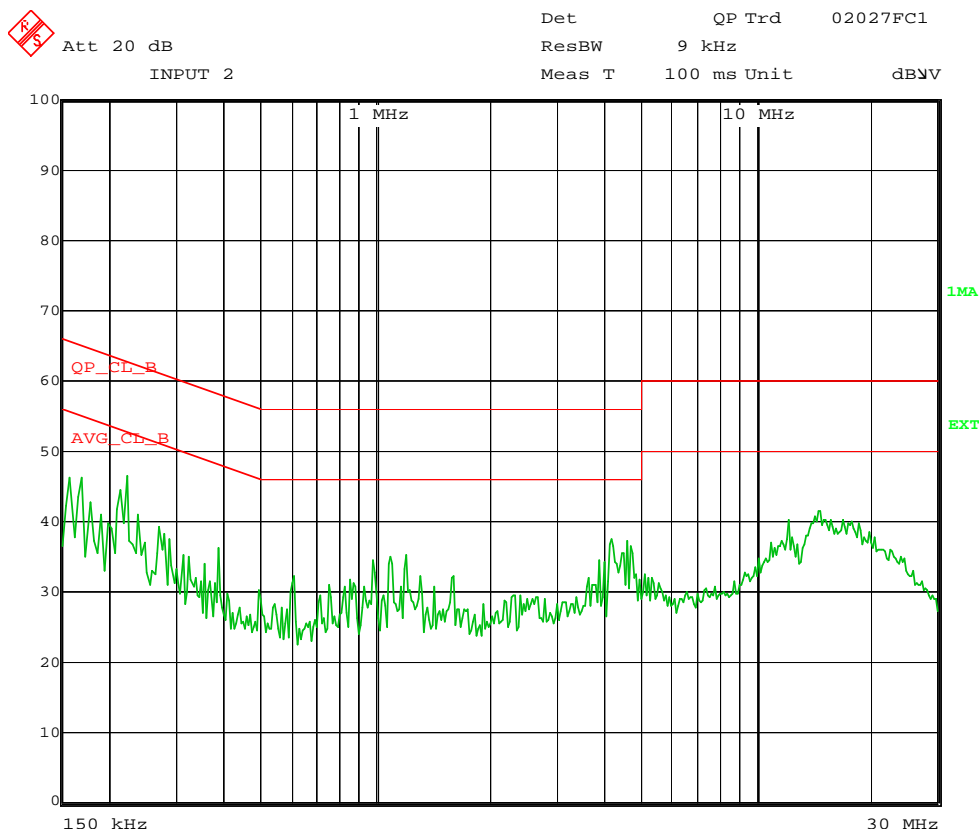

Date: 22.DEC.2008 10:53:42



• **LIVE:**

Frequency (MHz)	Quasi-peak (dB(μV))	QP Limit (dB(μV))	QP margin (dB)	Frequency (MHz)	Average (dB(μV))	Average Limit (dB(μV))	Average margin (dB)
0.154	40.0	65.8	25.8	0.214	34.1	53.0	19.0
0.170	40.7	65.0	24.3	0.994	25.9	46.0	20.1
0.178	41.5	64.6	23.1	1.102	28.3	46.0	17.7
0.190	41.6	64.0	22.4	1.206	30.8	46.0	15.2
0.202	40.4	63.5	23.1	1.314	26.6	46.0	19.4
0.214	46.1	63.0	16.9	12.290	35.9	50.0	14.1

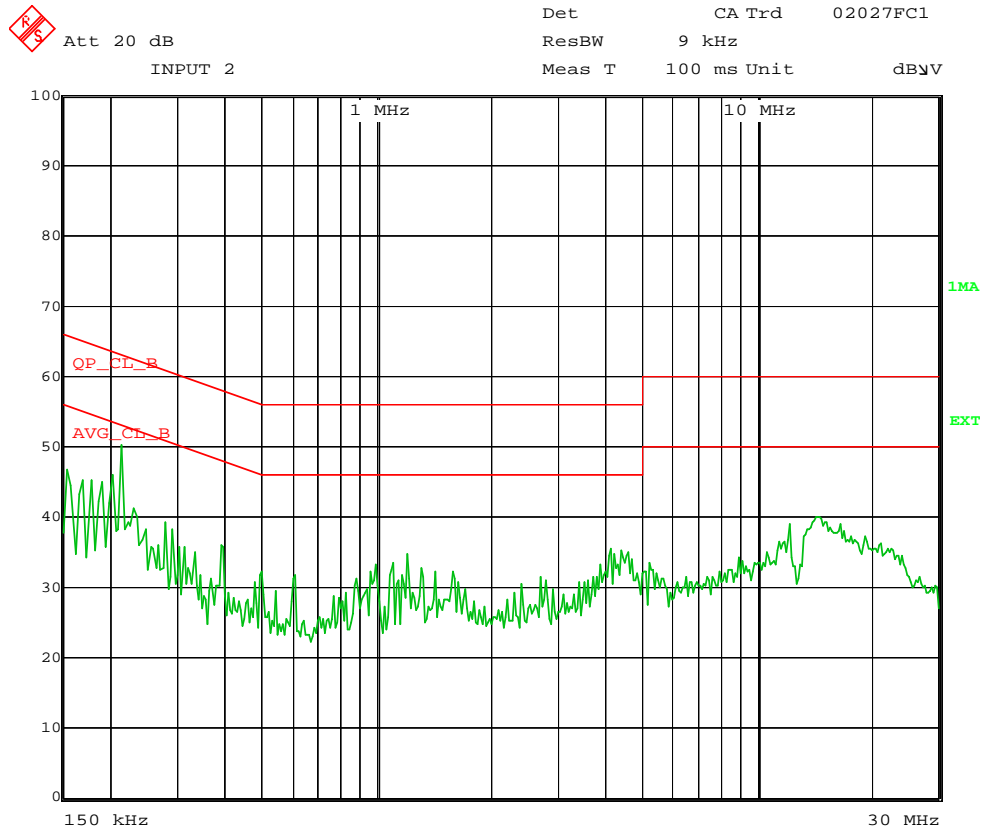

Date: 22.DEC.2008 11:02:38



Power supply of AC Adapter (120 V 60Hz) configuration 2

Tests performed by Aziz ABBASSI at GYL Technologies laboratories on May 28, 2009.

- **Neutral:**

Frequency (MHz)	Quasi-peak (dB(μV))	QP Limit (dB(μV))	QP margin (dB)	Frequency (MHz)	Average (dB(μV))	Average Limit (dB(μV))	Average margin (dB)
0.262	28.8	61.4	32.6	0.338	21.7	49.3	27.6
0.326	32.3	59.6	27.3	26.446	20.9	50.0	29.1
0.414	24.3	57.6	33.3	27.694	21.4	50.0	28.6
25.982	27.4	60.0	32.6	28.214	22.4	50.0	27.6
28.546	21.9	60.0	38.1	28.322	21.5	50.0	28.5
29.218	22.4	60.0	37.6	28.678	22.0	50.0	28.0

Legend: Green curve represents the peak values

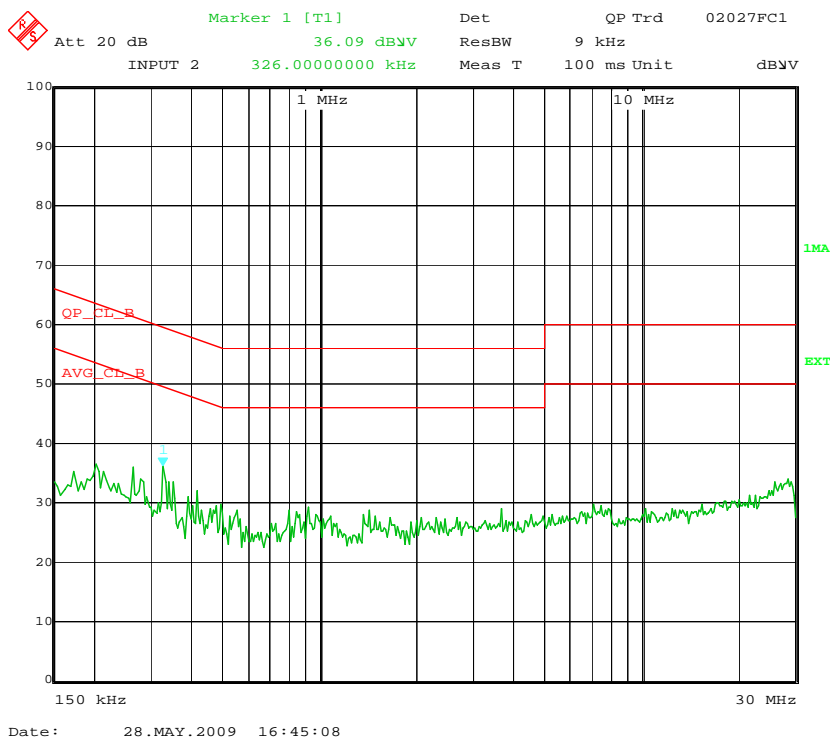



• **LIVE:**

Frequency (MHz)	Quasi-peak (dB(μV))	QP Limit (dB(μV))	QP margin (dB)	Frequency (MHz)	Average (dB(μV))	Average Limit (dB(μV))	Average margin (dB)
0.330	36.8	59.5	22.6	0.330	26.7	49.5	22.8
0.342	36.9	59.2	22.3	27.070	24.6	50.0	25.4
27.802	35.1	60.0	24.9	27.750	25.3	50.0	24.7
27.946	35.0	60.0	25.0	28.266	25.6	50.0	24.4
28.002	33.7	60.0	26.3	28.518	25.3	50.0	24.7
28.946	34.0	60.0	26.0	28.946	24.7	50.0	25.3

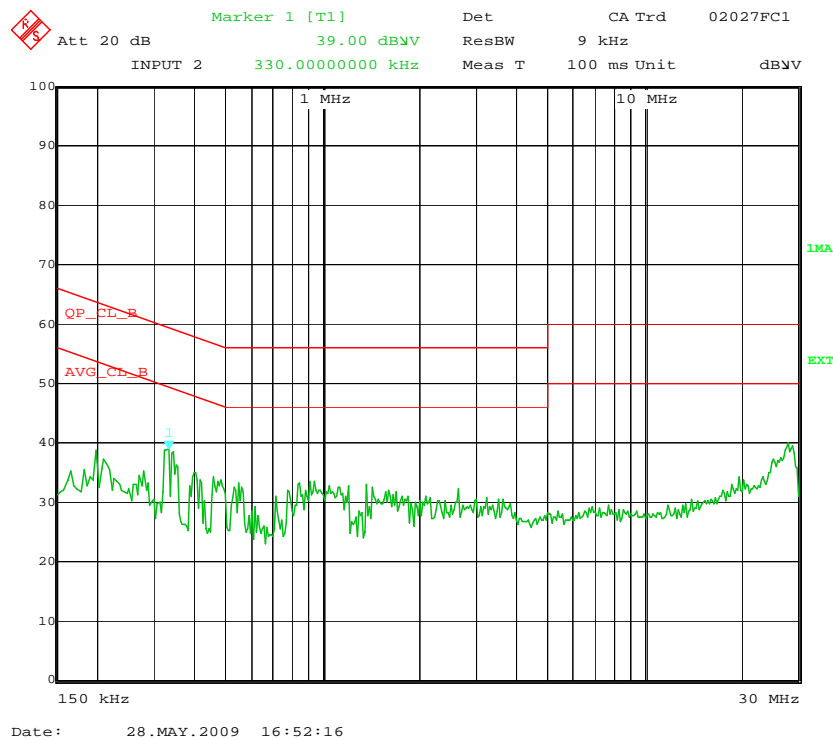

8.2.2 INTERPRETATION AND REMARKS:

The equipments comply with the §15.107 Class B and §15.207 requirements.



8.3 RADIATED EMISSIONS MEASUREMENTS (15.109&209):

Measurements below 1GHz

Before final radiated emissions measurements which are on the open-field three/ten meters range, the EUT was pre-scanned in the semi anechoic at one meter distance. This was done in order to determine its emissions spectrum signature. The physical arrangement of the test system and associated cabling was varied in order to determine the effect on the EUT's emissions in amplitude, direction and frequency. This process was repeated during final radiated emissions measurements on the open-field range, at each frequency, in order to insure that maximum emission amplitudes were attained. Final radiated emissions measurements were carried out on the three/ten-meters, open-field test site. The EUT was placed on an insulating support (wooden table) of 0.8m high above a conductive turntable (the turntable was grounded)

At each frequency, the EUT was rotated 360 degrees, and the antenna was raised and lowered from one to four meters in order to determine the maximum emission levels.

Measurements were obtained using both horizontal and vertical antenna polarizations.

The spectrum analyzer's 6 dB bandwidth was set to 120 kHz, and the analyzer was operated in the CISPR quasi-peak detection mode. No video filter less than 10 times the resolution bandwidth was used. The range of the frequency spectrum to be investigated is specified in FCC Part 15. The highest emission amplitudes relative to the appropriate limit were measured and recorded in this report.

Summary of settings

ESI 7 EMI TEST RECEIVER IN RECEIVER MODE	
Peak measurement time	5 ms
step size	40 kHz
Preamplifier	ON
Preselector	ON
Resolution bandwidth	120 kHz
Final Quasi Peak measurement time	1 s minimum
Final average measurement time	1 s minimum

All readings are quasi-peak unless stated otherwise.

8.3.1 RESULTS (Class B):

With configuration 1

The following data table lists the most significant emission frequencies, measured level, correction factor (includes cable and antenna corrections), corrected reading and the limit.

The highest peaks are measured in quasi-peak detection mode at 3 meters distance.

Frequency in MHz	Peak Value in dBµV/m	Quasi-Peak Value in dBµV/m	Quasi-Peak Limit in dBµV/m	Margin in dB	Pol	Height in cm	Angles in °	Correction Factors in dB	Comments
33,940	38,2	35,7	40,0	4,3	V	105	100	16,8	
79,745	41,0	38,6	40,0	1,4	V	147	358	10,2	
83,133	40,7	38,5	40,0	1,5	V	157	358	10,6	
264,960	37,5	34,0	46,0	12,0	H	103	24	17,2	
397,644	41,6	35,7	46,0	10,3	H	102	61	19,9	
496,783	39,5	35,3	46,0	10,8	V	188	2	22,0	

Electrical field (dB(μ V/m))

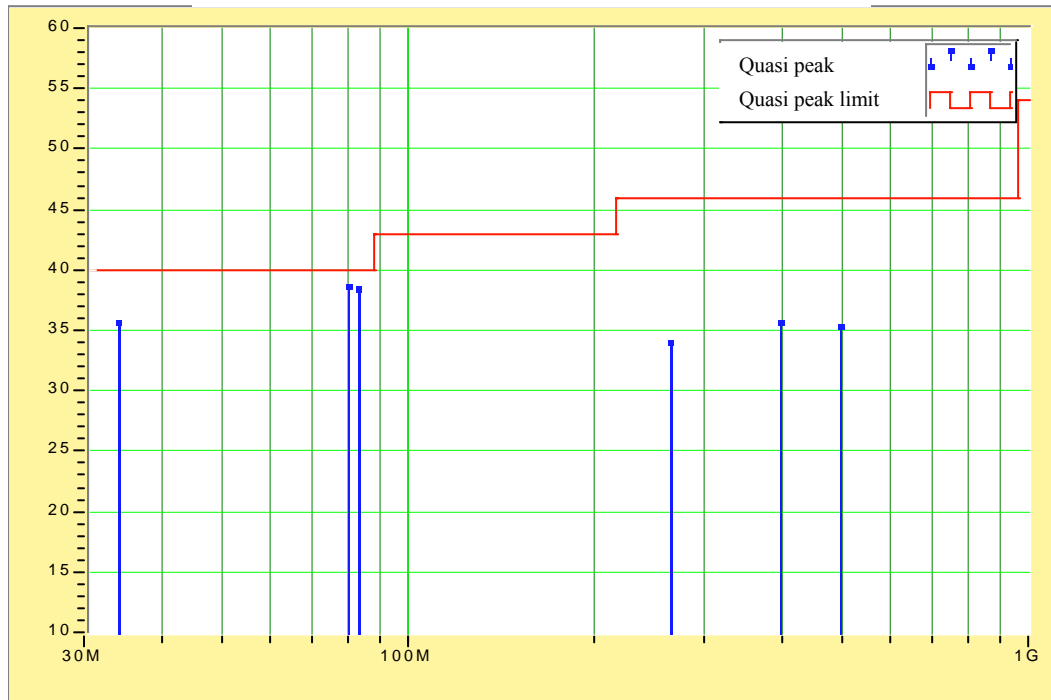

8.3.2 INTERPRETATION AND REMARKS:

The equipments comply with the §15.109 requirements, class B.



8.4 INTENTIONAL RADIATOR OPERATION WITHIN THE BAND 2400 – 2483.5MHz §15.249:

8.4.1 MAXIMUM PEAK OUTPUT POWER §15.249(a) (c)

The spectrum analyzer settings were the following:

- Resolution bandwidth: greater than the 20dB bandwidth
- Video bandwidth greater than the resolution bandwidth
- Sweep time: 250ms
- Detector mode: peak
- Span: ≥ three times the 20dB bandwidth
- Trace: max hold

Distance of measurement: 3m

The limit level applied shall be less than 94dB (µV/m) at 3 meters according to §15.249(a)(c) of the standard.

According to DA 00-705, transmitter’s peak power has been calculated using the following equation:

$$P = \frac{(E*d)^2}{30G}$$

Where:

d=3m

G=1 (isotropic antenna)

- **Magnetic search coil**

Channel	Frequency (MHz)	(dBµ(V/m))	Power	
			(mW)	(µW)
Low	2404	87	0.150	150
Middle	2440	87	0.150	150
High	2476	88	0.189	189



8.4.2 BANDWIDTH MEASUREMENT

Worst case 2.184MHz
Lowest channel

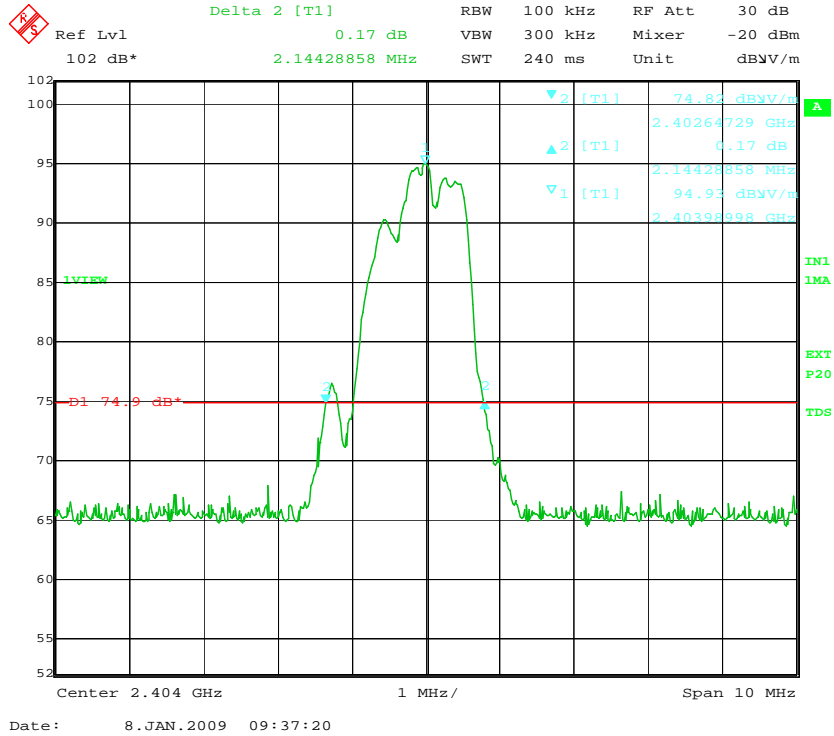

Middle Channel

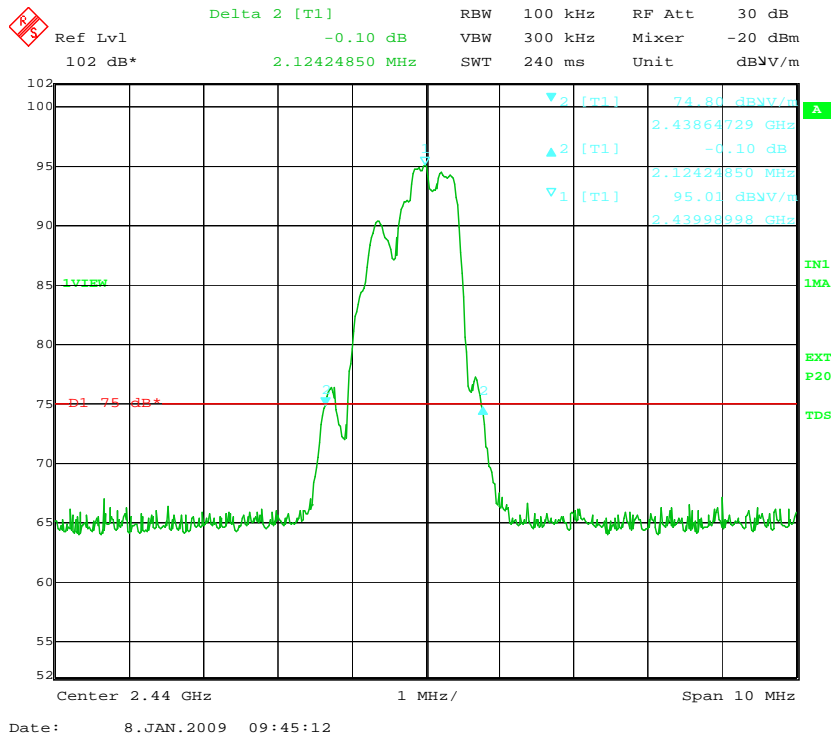



Highest Channel

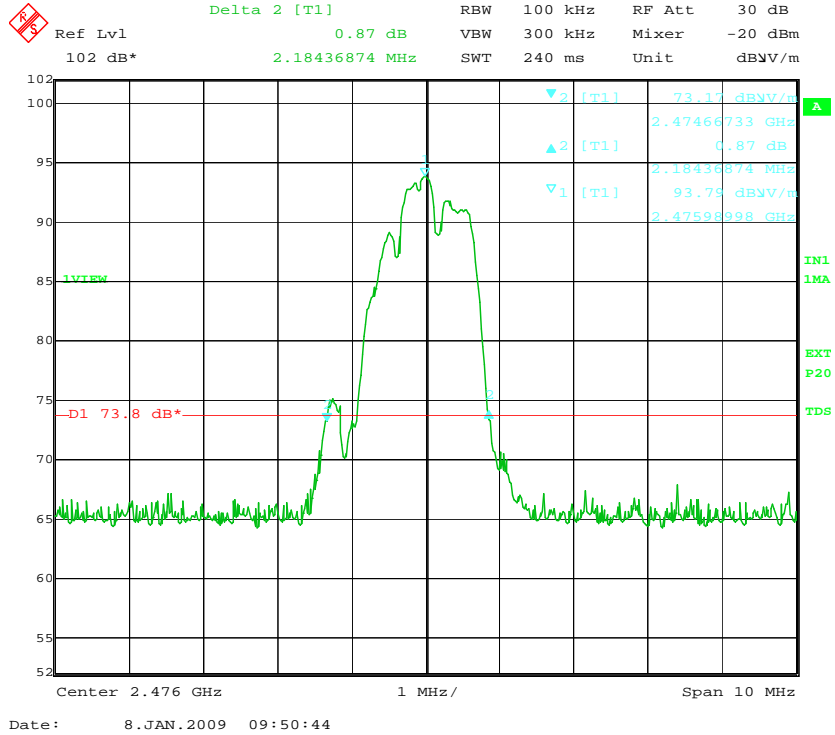



8.4.3 SPURIOUS AND PART 18 EMISSIONS MEASUREMENTS §15.249(d)

Emissions radiated outside of the specified frequency bands, except for harmonics, shall be attenuated by at least 50 dB below the level of the fundamental or to the general radiated emission limits in Section 15.209, whichever is the lesser attenuation.

8.4.3.1 RADIATED SPURIOUS (§15.205, §15.209,§15.249) AND §18, ICES001 EMISSION BELOW 1000MHZ

Before final radiated emissions measurements which are performed on the open-field three/ten meters range; the EUT was pre-scanned in the semi anechoic at three meters distance. It was performed in order to determine its emissions spectrum signature. The physical arrangement of the test system was varied in order to determine the effect on the EUT's emissions in amplitude, direction and frequency. This process was repeated during final radiated emissions measurements on the open-field range, at each frequency, in order to insure that maximum emission amplitudes were attained.

Final radiated emissions measurements were carried out on the three/ten-meters, open-field test site. The EUT was placed on an insulating support (wooden table) of 0.8m high above a conductive turntable (the turntable was grounded).

At each frequency, the EUT was rotated 360 degrees, and the antenna was raised and lowered from one to four meters in order to determine the maximum emission levels.

Measurements were performed using both horizontal and vertical antenna polarizations.

Below 30MHz, the spectrum analyzer 6dB bandwidth was set to 100 or 200Hz for peak measurements and 200Hz for quasi-peak in the range 9kHz to 150kHz.

Between 150kHz up to 30MHz, the bandwidth was set to 10kHz for peak measurements and 9kHz for quasi-peak measurements.

Between 30MHz to 1GHz, the spectrum analyzer's 6 dB bandwidth was set to 100 kHz for peak measurement and 120kHz for quasi-peak measurements

The analyzer was operated in the CISPR quasi-peak detection mode when needed.

No video filter less than 10 times the resolution bandwidth was used.

The range of the frequency spectrum to be investigated is specified in FCC Part 15.

The highest emission amplitudes relative to the appropriate limit were measured and recorded in this report.

Summary of settings for measurements below 1GHz

ESI 7 EMI TEST RECEIVER IN RECEIVER MODE	
Peak measurement time	5 ms
step size	< bandwidth
Preamplifier	ON
Preselector	ON
Resolution band width	200Hz, 9kHz or 120 kHz*
Final quasi peak measurement time	1 s minimum
Final average measurement time	1 s minimum

* depending of the frequency range to be scanned



• **Magnetic search coil**

These measurements have been carried out at a distance of 3 and 10 meters; Computation is performed to obtain the 300 m field strength.

Part 18 measurements

With the search coil configured at 18 kHz

Frequency kHz	Peak dBµV/m at 3 m	Peak dBµV/m at 10 m	Peak computed dBµV/m at 300 m	Peak limit part 18 dBµV/m at 300 m	Margin (dB)
18.310	98.4	72.0	-2.6	23.5	26

With the search coil configured at 12 kHz

Frequency kHz	Peak dBµV/m at 3 m	Peak dBµV/m at 10 m	Peak computed dBµV/m at 300 m	Peak limit part 18 dBµV/m at 300 m	Margin (dB)
12.200	47.5	NF*	<-10	23.5	>30

*NF is near 40dBµV/m and does not permit to know the decreasing law, we use the decreasing law obtained with the 18 kHz emission.

Spurious measurements

No spurious was found, the measured level was the noise floor as well as in the restricted band (§ 15.205) § 15.209.

***Prescan measurement at 3 m for 12 kHz emission with 15.209 limit.

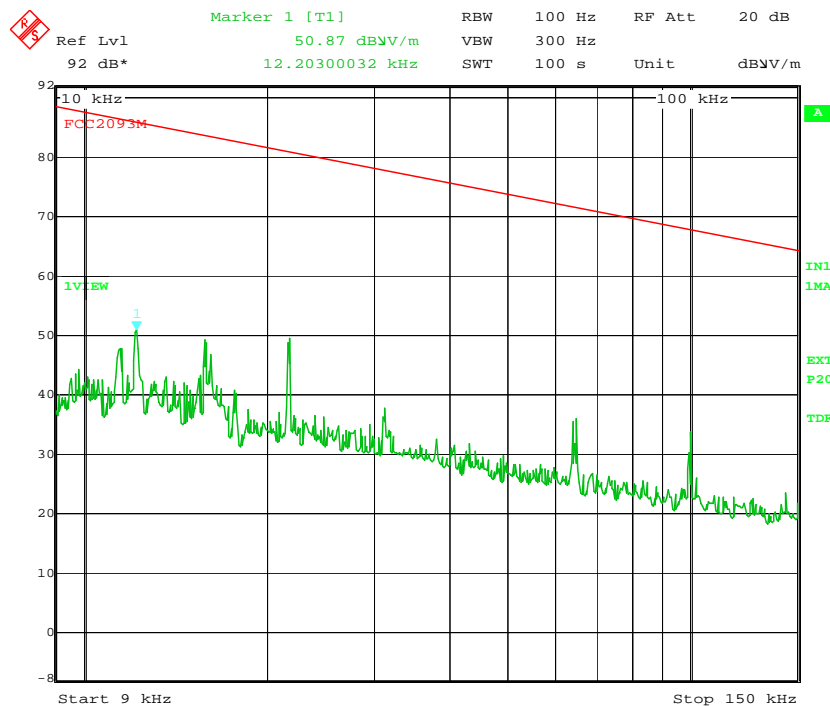



Prescan measurement at 3 m for 18 kHz emission with 15.209 limit.

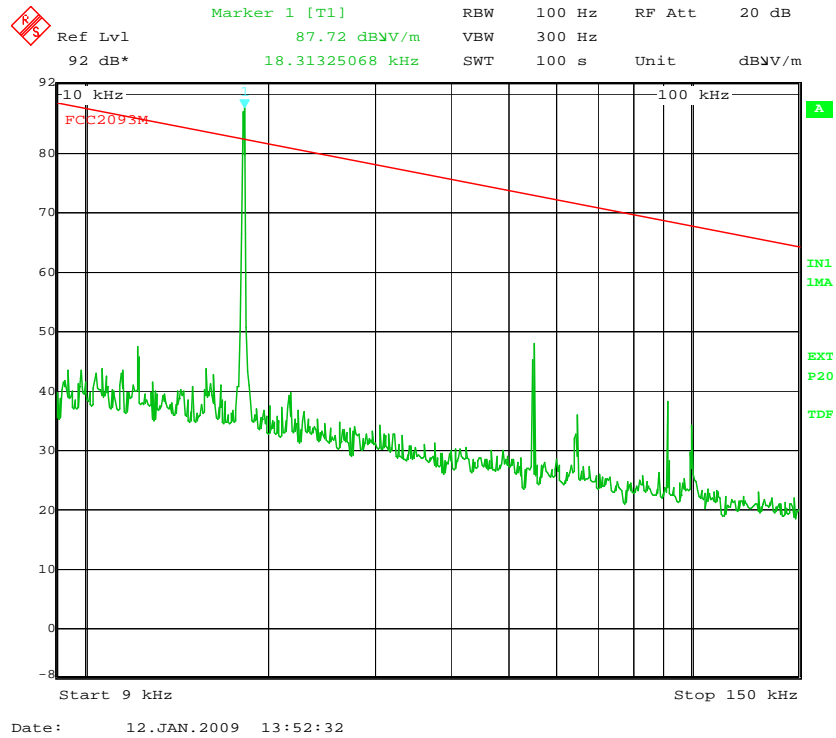



Measurement over 150kHz at 3 m during prescan (idem for both emission frequencies)

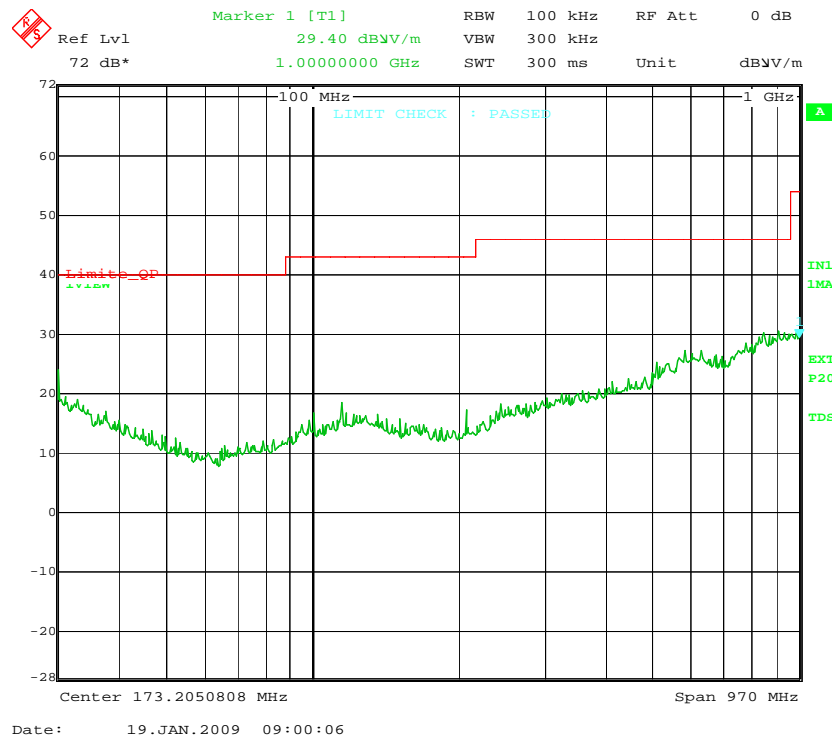
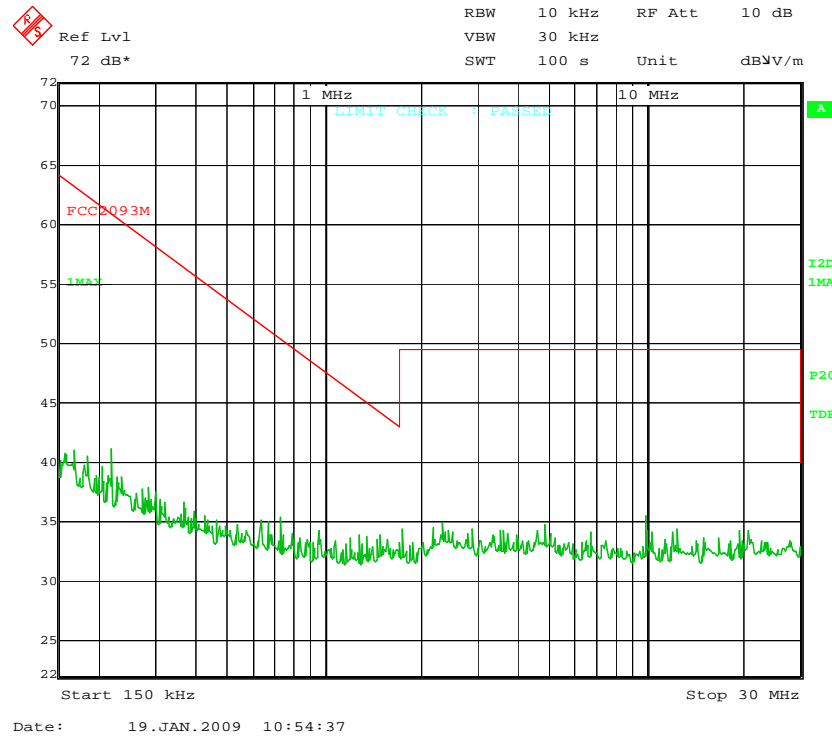

Concerning ICES 001, measurement are performed according to CISPR 11

The magnetic search coil complies to the CISPR11, Class B Group 2. As shown in table 4 of the standard there is no limit applicable below 150kHz.

Between 150kHz to 30MHz and over 30MHz no disturbance was observed. See measurements on this page.

8.4.3.2 RADIATED SPURIOUS EMISSION ABOVE 1000MHZ §15.205, §15.209,§15.249

A pre-scan measurement is done very close to the product (less than 10cm) with 100kHz RBW and a max peak detector.

Then measurements are performed at 3m with 1MHz RBW and a video averaging (10Hz) for spurious measurement.

Harmonics are peak measured with 1MHz RBW

Spurious emissions are also made with a permanent emission on lowest, middle and highest channel.

Average limit in restricted bands §15.205 at 3 m is 54dB(µV/m) (with a peak limit at 74 dB(µV/m)). Otherwise, the limit is the same as the 50dB below the emission level is below the 15.209 limit.

Radiated emissions above 1GHz

No spurious found outside harmonics in transmitting mode.

- **Magnetic search coil**

Maximum spurious for low channel 2404MHz

Frequency (MHz)	H.	Peak(1) (dB(µV/m)) at 3m	Peak limit At 3m (dB(µV/m))	Average(2) (dB(µV/m)) at 3m	Average limit At 3m (dB(µV/m))	Min. Margin (dB)
4 808	2	58,4	74.0	43.1	54.0	10.9
7 212	3	47,0	74.0	34.4		27
9 616	4	50,6	74.0	36.4		23
12 020	5	NF		NF		
14 424	6	NF		NF		
16 828	7	NF		NF		
19 232	8	NF		NF		
21 636	9	NF		NF		
24 040	10	NF		NF		



Maximum spurious for middle channel 2440MHz

Frequency (MHz)	H.	Peak(1) (dB(μ V/m)) at 1m	Peak(1) (dB(μ V/m)) at 3m	Peak limit At 3m (dB(μ V/m))	Average(2) (dB(μ V/m)) at 1m	Average(2) (dB(μ V/m)) at 3m	Average limit At 3m (dB(μ V/m))	Min. Margin (dB)
4 880	2	60,5	50,5	74.0	55.5	45.5	54.0	8.5
7 320	3	56,7	46,7	74.0	44.4	34.4	54.0	19.6
9 760	4	NF	NF		NF	NF		
12 200	5	NF	NF		NF	NF		
14 640	6	NF	NF		NF	NF		
17 080	7	NF	NF		NF	NF		
19 520	8	NF	NF		NF	NF		
21 960	9	NF	NF		NF	NF		
24 400	10	NF	NF		NF	NF		

Maximum spurious for high channel 2476MHz

Frequency (MHz)	H.	Peak(1) (dB(μ V/m)) at 1m	Peak(1) (dB(μ V/m)) at 3m	Peak limit At 3m (dB(μ V/m))	Average(2) (dB(μ V/m)) at 1m	Average(2) (dB(μ V/m)) at 3m	Average limit At 3m (dB(μ V/m))	Min. Margin (dB)
4 952	2	62,4	52,4	74.0	58.8	48.8	54.0	5.2
7 428	3	56,8	46,8	74.0	44.8	34.8	54.0	19.2
9 904	4	NF	NF		NF	NF		
12 380	5	NF	NF		NF	NF		
14 856	6	NF	NF		NF	NF		
17 332	7	NF	NF		NF	NF		
19 808	8	NF	NF		NF	NF		
22 284	9	NF	NF		NF	NF		
24 760	10	NF	NF		NF	NF		

(1) Peak measurement with 1MHz RBW and VBW.

(2) Average measurement with 1MHz RBW and 10Hz VBW

NF means Noise Floor



Noise Floor

Ref Lvl 97 dB* RBW 100 kHz RF Att 0 dB
VBW 100 kHz
SWT 250 ms Unit dBμV/m

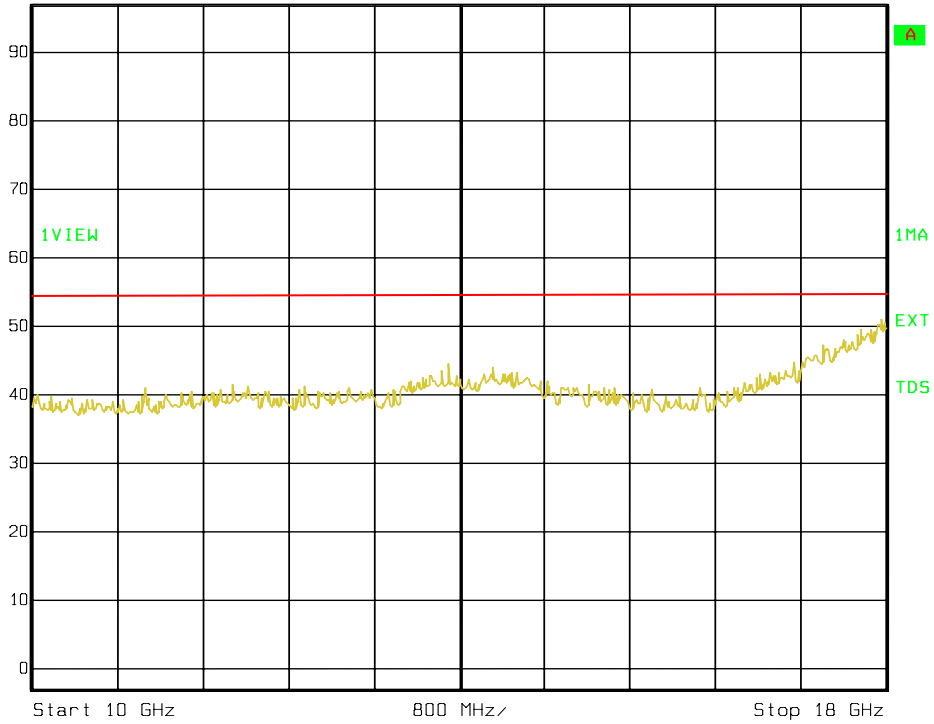

Date: 21.JAN.2009 14:35:20

Delta 1 [T1] RBW 100 kHz RF Att 0 dB
Ref Lvl 90 dB* 0.00 dB VBW 100 kHz
0.00000000 Hz SWT 1.75 s Unit dBμV/m

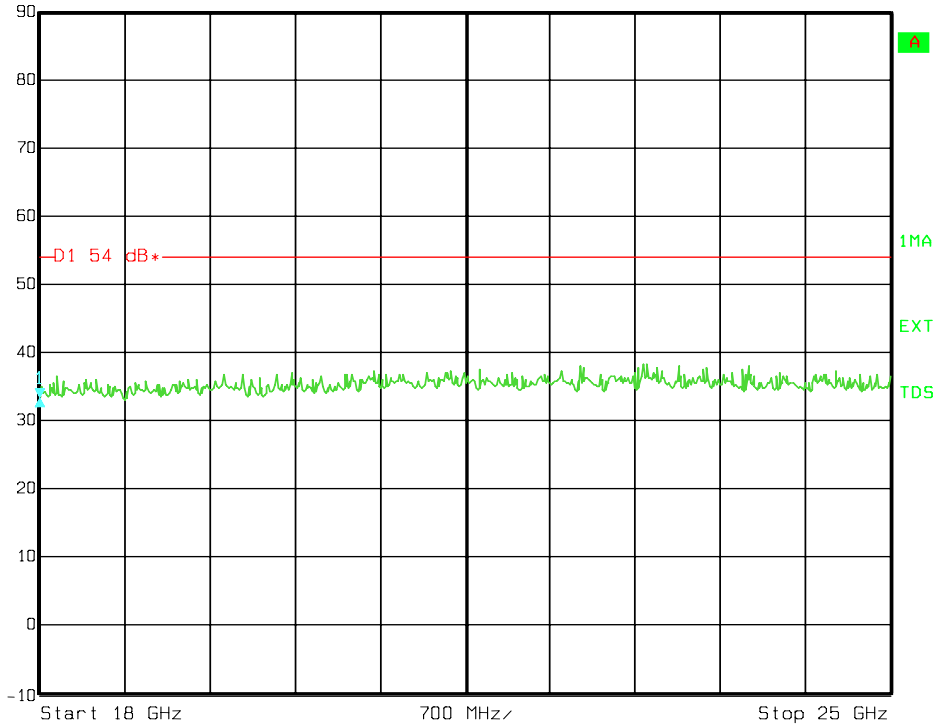

Date: 12.JAN.2009 10:46:14



8.4.3.3 RECEIVER SPURIOUS RADIATION

No spurious emission has been found in receiver mode above the noise floor

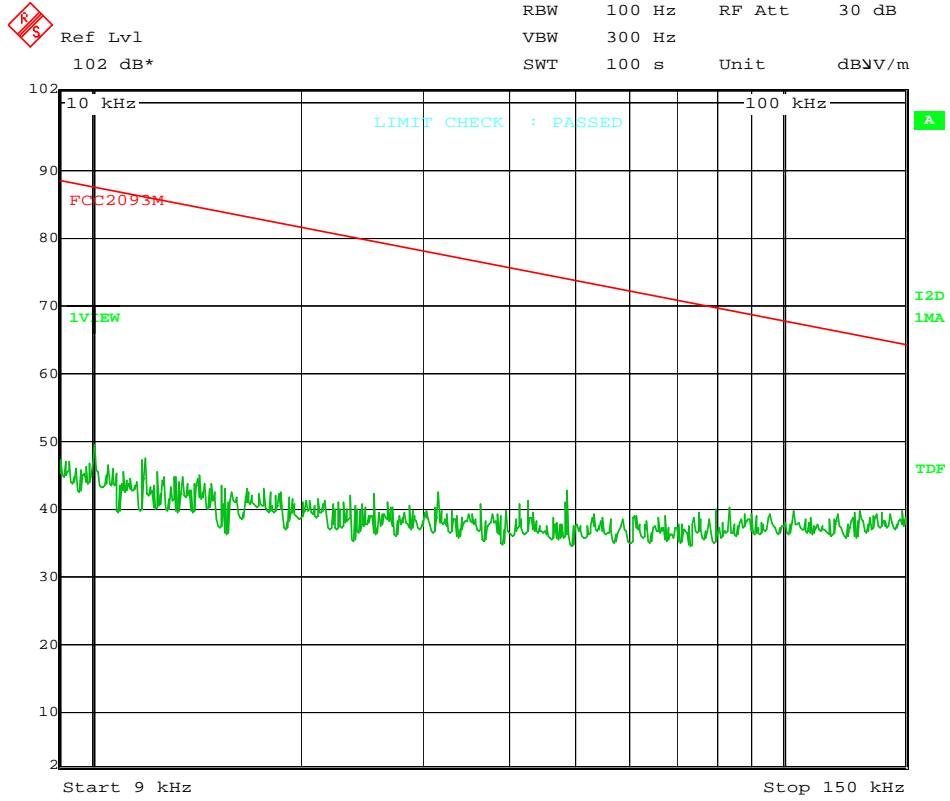

Date: 19.JAN.2009 11:00:21

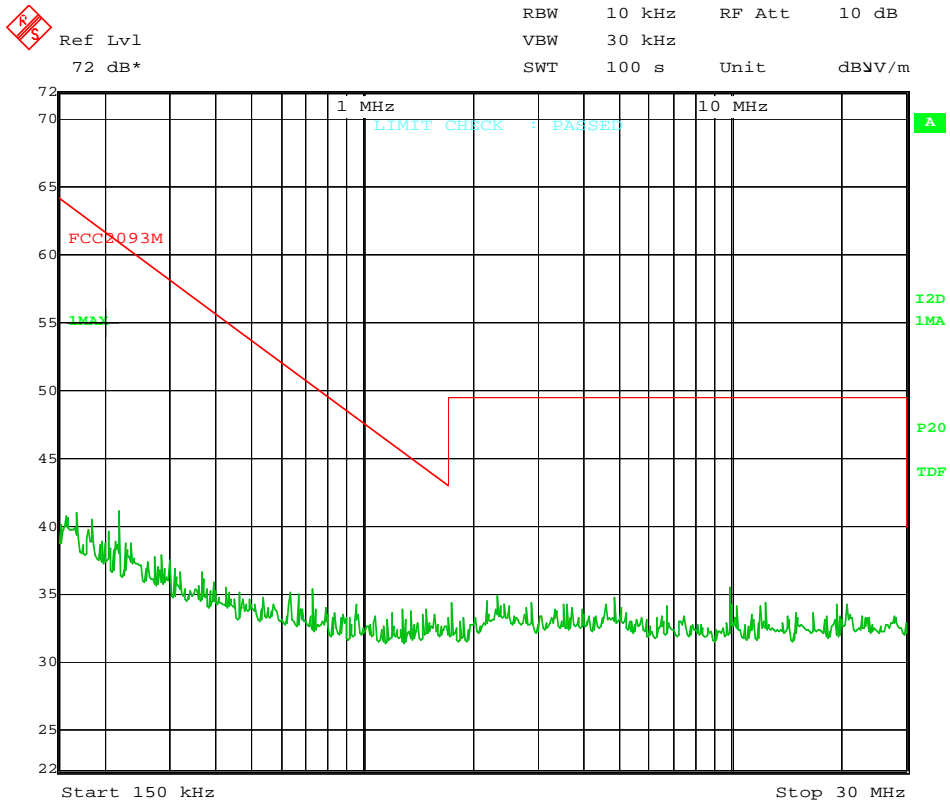

Date: 19.JAN.2009 10:54:37



FCC and IC CERTIFICATION TEST REPORT
EQUIPMENT FCC ID:XFJ225
IC:8392A-XP225
The 28 pages of this report are not sharable

27
Identification : 560101-CC-1-a
FCC registration n°90469
IC registration n°IC4452A-1

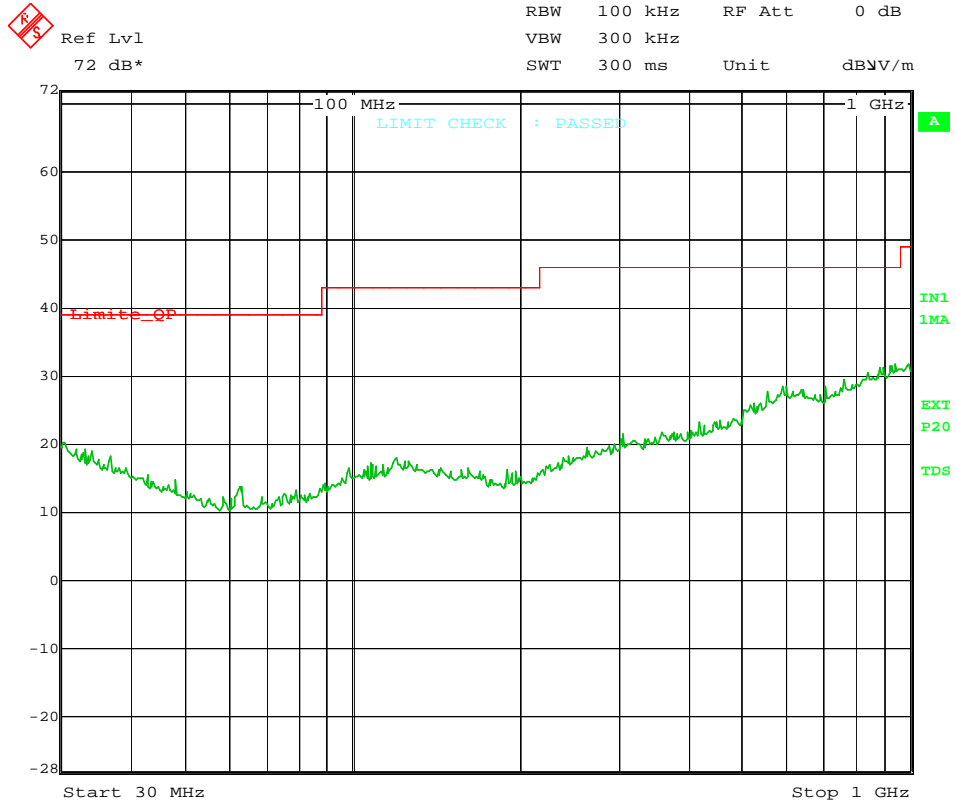

Date: 12.JAN.2009 14:14:47

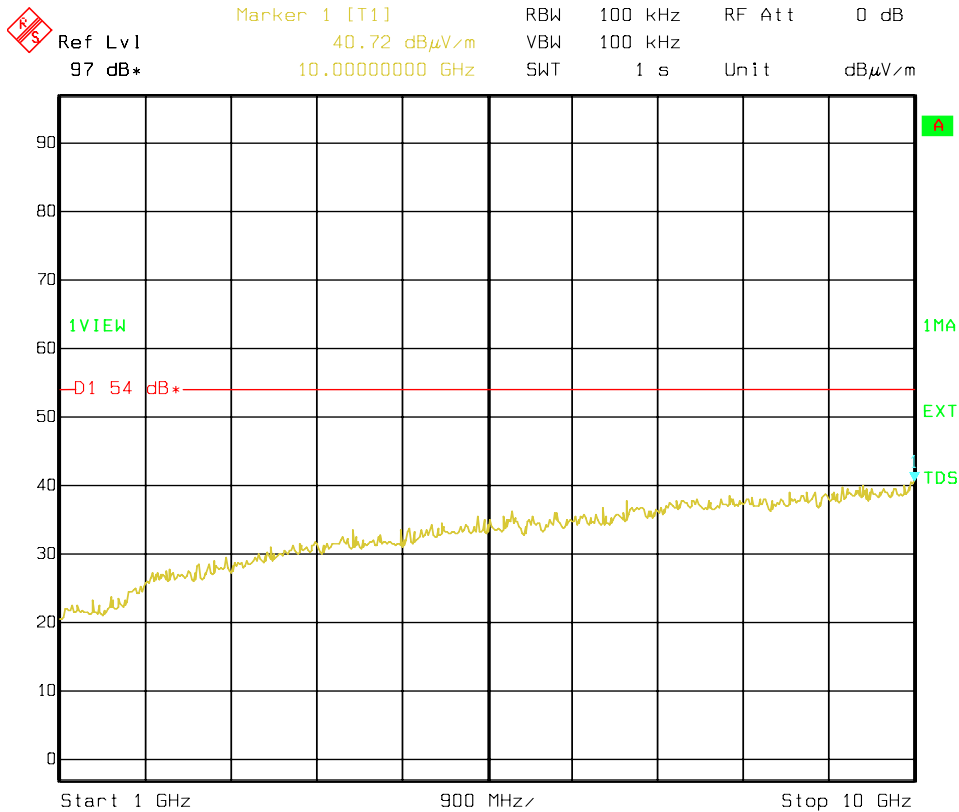

Date: 29.JAN.2009 9:10:51



FCC and IC CERTIFICATION TEST REPORT
EQUIPMENT FCC ID:XFJ225
IC:8392A-XP225
The 28 pages of this report are not sharable

28
Identification : 560101-CC-1-a
FCC registration n°90469
IC registration n°IC4452A-1



Ref Lvl
97 dB*

RBW 100 kHz RF Att 0 dB
VBW 100 kHz
SWT 250 ms Unit dB μ V/m

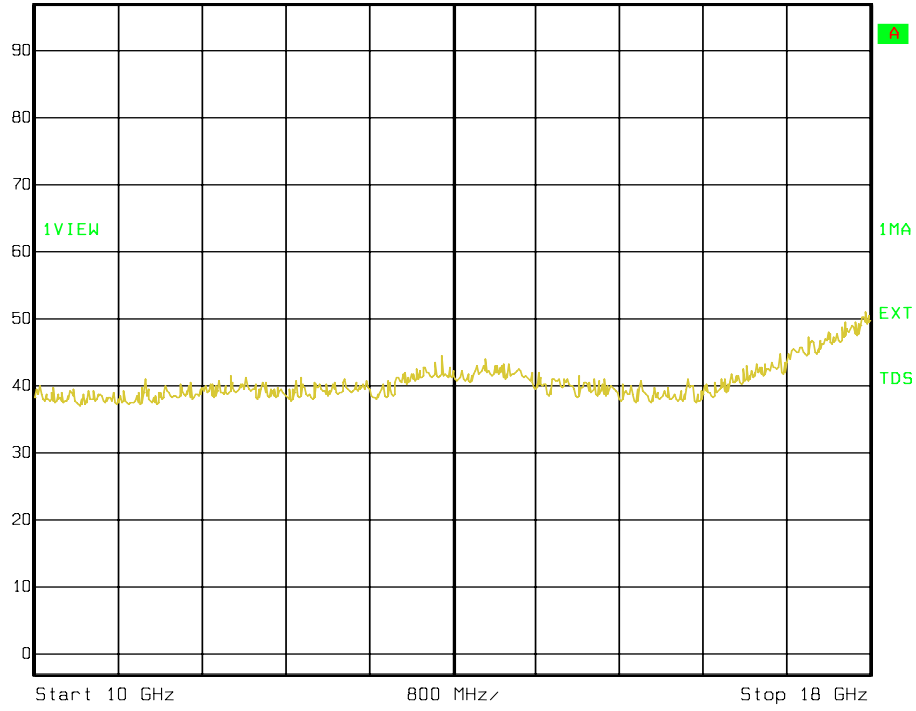

Date: 21.JAN.2009 14:35:20



Ref Lvl
90 dB*

Delta 1 [T1]
0.00 dB
0.00000000 Hz

RBW 100 kHz RF Att 0 dB
VBW 100 kHz
SWT 1.75 s Unit dB μ V/m

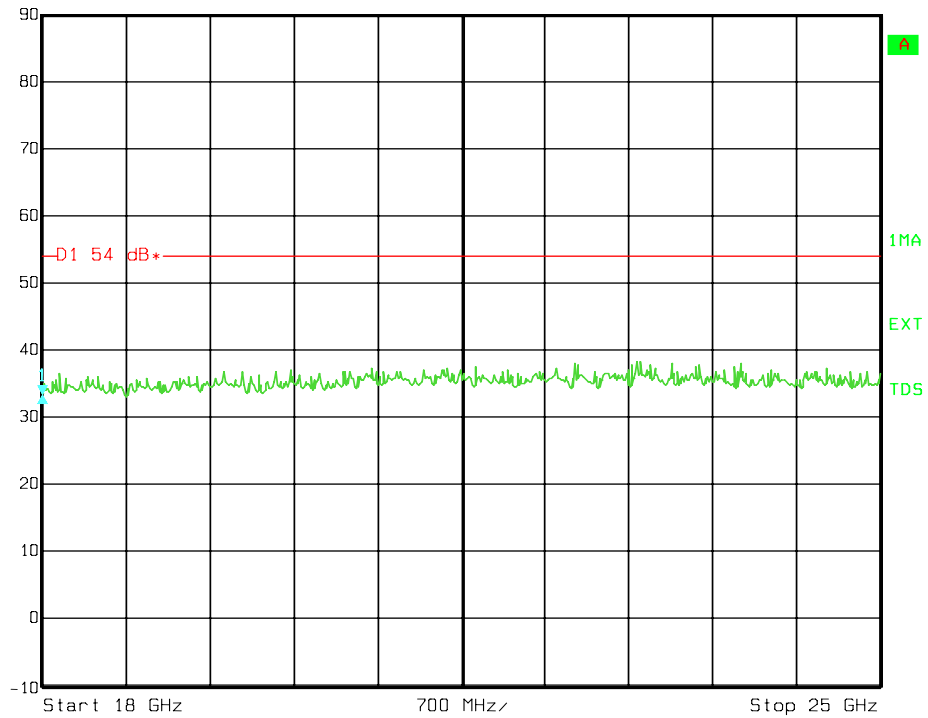

Date: 12.JAN.2009 10:46:14