

ENGINEERING TEST REPORT

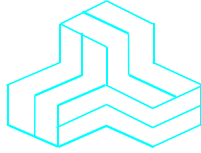

Multiprotocol Gateway
Model(s): GWY20
FCC ID: XFF-GWY20

Applicant:

MMB Research Inc.
243 College St, Suite 500
Toronto, ON M5T 1R5
Canada

In Accordance With

Federal Communications Commission (FCC)
Part 15, Subpart C, Section 15.247
Digital Modulation Systems (DTS) Operating in 2400 – 2483.5 MHz Band

UltraTech's File No.: 18MMBN004_FCC15C247B

This Test report is Issued under the Authority of
Tri M. Luu
Vice President of Engineering
UltraTech Group of Labs

Date: November 29, 2018

Report Prepared by: Dan Huynh

Tested by: Hung Trinh

Issued Date: November 29, 2018

Test Dates:
September 23, 24, 2018
October 18, 19, 22, 2018
November 14, 2018

- *The results in this Test Report apply only to the sample(s) tested, and the sample tested is randomly selected.*
- *This report must not be used by the client to claim product endorsement by any agency of the US Government.*
- *This test report shall not be reproduced, except in full, without a written approval from UltraTech*

UltraTech

3000 Bristol Circle, Oakville, Ontario, Canada L6H 6G4
Tel.: (905) 829-1570 Fax.: (905) 829-8050
Website: www.ultratech-labs.com, Email: vic@ultratech-labs.com, Email: tri@ultratech-labs.com



APEC TEL CA0001



1309



CA 0001/2049



AT-1945



SL2-IN-E-1119R



Korea KCC-RRR

CA2049

TABLE OF CONTENTS

EXHIBIT 1. INTRODUCTION..... 1

1.1. SCOPE 1

1.2. RELATED SUBMITTAL(S)/GRANT(S) 1

1.3. NORMATIVE REFERENCES 1

EXHIBIT 2. PERFORMANCE ASSESSMENT 2

2.1. CLIENT INFORMATION 2

2.2. EQUIPMENT UNDER TEST (EUT) INFORMATION 2

2.3. EUT'S TECHNICAL SPECIFICATIONS..... 3

2.4. ASSOCIATED ANTENNA DESCRIPTIONS 3

2.5. LIST OF EUT'S PORTS..... 3

2.6. ANCILLARY EQUIPMENT 3

EXHIBIT 3. EUT OPERATING CONDITIONS AND CONFIGURATIONS DURING TESTS 5

3.1. CLIMATE TEST CONDITIONS 5

3.2. OPERATIONAL TEST CONDITIONS & ARRANGEMENT FOR TESTS..... 5

EXHIBIT 4. SUMMARY OF TEST RESULTS..... 6

4.1. LOCATION OF TESTS 6

4.2. APPLICABILITY & SUMMARY OF EMC EMISSION TEST RESULTS 6

4.3. MODIFICATIONS INCORPORATED IN THE EUT FOR COMPLIANCE PURPOSES 6

EXHIBIT 5. TEST DATA..... 7

5.1. POWER LINE CONDUCTED EMISSIONS [§15.207(a)]..... 7

5.2. OCCUPIED BANDWIDTH [§ 15.247(a)(2)]..... 12

5.3. PEAK CONDUCTED OUTPUT POWER - DTS [§ 15.247(b)(3)] 16

5.4. TRANSMITTER SPURIOUS RADIATED EMISSIONS AT 3 METERS [§§ 15.247(d), 15.209 & 15.205] 22

5.5. POWER SPECTRAL DENSITY [§ 15.247(e)] 36

5.6. RF EXPOSURE REQUIRMENTS [§§ 15.247(i), 1.1310 & 2.1091]..... 40

EXHIBIT 6. TEST EQUIPMENT LIST 42

EXHIBIT 7. MEASUREMENT UNCERTAINTY 43

7.1. LINE CONDUCTED EMISSION MEASUREMENT UNCERTAINTY 43

7.2. RADIATED EMISSION MEASUREMENT UNCERTAINTY 43

EXHIBIT 1. INTRODUCTION

1.1. SCOPE

Reference:	FCC Part 15, Subpart C, Section 15.247
Title:	Code of Federal Regulations (CFR), Title 47 – Telecommunication, Part 15 – Radio Frequency Devices
Purpose of Test:	Equipment Certification for Digital Modulation Systems (DTS) Operating Under §15.247
Test Procedures:	<ul style="list-style-type: none"> ▪ ANSI C63.4 ▪ ANSI C63.10 ▪ FCC KDB Publication No. 558074 D01 15.247 Meas Guidance v05
Environmental Classification:	<input checked="" type="checkbox"/> Commercial, industrial or business environment <input checked="" type="checkbox"/> Residential environment

1.2. RELATED SUBMITTAL(S)/GRANT(S)

None.

1.3. NORMATIVE REFERENCES

Publication	Year	Title
47 CFR Parts 0-19	2018	Code of Federal Regulations (CFR), Title 47 – Telecommunication
ANSI C63.4	2014	American National Standard for Methods of Measurement of Radio-Noise Emissions from Low-Voltage Electrical and Electronic Equipment in the Range of 9 KHz to 40 GHz
ANSI C63.10	2013	American National Standard of Procedures for Compliance Testing of Unlicensed Wireless Devices
FCC, KDB Publication No. 558074 D01 15.247 Meas Guidance v05	2018	GUIDANCE FOR COMPLIANCE MEASUREMENTS ON DIGITAL TRANSMISSION SYSTEM, FREQUENCY HOPPING SPREAD SPECTRUM SYSTEM, AND HYBRID SYSTEM DEVICES OPERATING UNDER SECTION 15.247 OF THE FCC RULES

EXHIBIT 2. PERFORMANCE ASSESSMENT

2.1. CLIENT INFORMATION

Applicant	
Name:	MMB Research Inc.
Address:	243 College St, Suite 500 Toronto, ON M5T 1R5 Canada
Contact Person:	Hussein Nagji Phone #: 416-636-3145 x237 Fax #: n/a Email Address: hussein.nagji@mmbnetworks.com

Manufacturer	
Name:	MMB Research Inc.
Address:	243 College St, Suite 500 Toronto, ON M5T 1R5 Canada
Contact Person:	Hussein Nagji Phone #: 416-636-3145 x237 Fax #: n/a Email Address: hussein.nagji@mmbnetworks.com

2.2. EQUIPMENT UNDER TEST (EUT) INFORMATION

The following information (with the exception of the Date of Receipt) has been supplied by the applicant.

Brand Name:	MMB Research Inc.
Product Name:	Multiprotocol Gateway
Model(s):	GWY20
Serial Number:	Test Sample
Type of Equipment:	Digital Transmission System (DTS)
Input Power Supply Type:	5V, 2.4A via AC/DC adapter
Primary User Functions of EUT:	Home automation/ IoT gateway

2.3. EUT’S TECHNICAL SPECIFICATIONS

Transmitter	
Equipment Type:	Mobile Base station (fixed use)
Intended Operating Environment:	Residential environment Commercial, industrial or business environment
Power Supply Requirement:	5V, 2.4A
RF Output Power Rating:	20.33 dBm
Operating Frequency Range:	2402 - 2480 MHz (for 1 Mbps) 2404 - 2478 MHz (for 2 Mbps)
RF Output Impedance:	50 Ω
Duty Cycle:	Declared by manufacturer: 1.88% for 2402/2426/2480 MHz Continuous for other channels
Modulation Type:	GFSK
Antenna Connector Type(s):	Integral

2.4. ASSOCIATED ANTENNA DESCRIPTIONS

Antenna Type	Manufacturer	Model	Maximum Gain (dBi)
Inverted F PCB trace antenna	MMB Networks	Inverted F PCB trace antenna	5.2

2.5. LIST OF EUT’S PORTS

Port Number	EUT’s Port Description	Number of Identical Ports	Connector Type	Cable Type (Shielded/Non-shielded)
1	Ethernet	1	RJ-45	Non-shielded
2	USB	1	USB	Shielded
3	DC Power Jack	1	DC Barrel Power Jack	Non-shielded

2.6. ANCILLARY EQUIPMENT

The EUT was tested while connected to the following representative configuration of ancillary equipment necessary to exercise the ports during tests:

Ancillary Equipment # 1	
Description:	Laptop
Brand name:	Lenovo
Model Name or Number:	ThinkPad Edge 0578
Serial Number:	IS057882 ULRBXKBG
Connected to EUT’s Port:	Connected to Router

Ancillary Equipment # 2	
Description:	Router
Brand name:	D-Link
Model Name or Number:	DIR-615
Serial Number:	F3HR181012581
Connected to EUT's Port:	Ethernet

Ancillary Equipment # 3	
Description:	AC/DC Adapter
Brand name:	I.T.E Power Supply
Model Name or Number:	RH-050240US
Serial Number:	--
Connected to EUT's Port:	DC Jack

EXHIBIT 3. EUT OPERATING CONDITIONS AND CONFIGURATIONS DURING TESTS

3.1. CLIMATE TEST CONDITIONS

The climate conditions of the test environment are as follows:

Temperature:	21 to 23 °C
Humidity:	45 to 58%
Pressure:	102 kPa
Power Input Source:	5V via AC/DC adapter

3.2. OPERATIONAL TEST CONDITIONS & ARRANGEMENT FOR TESTS

Operating Modes:	The transmitter was operated in a continuous transmission mode with the carrier modulated as specified in the Test Data.
Special Test Software:	Test software provided by the Applicant to operate the EUT at each channel frequency continuously and in the range of typical modes of operation.
Special Hardware Used:	N/A
Transmitter Test Antenna:	The EUT is tested with the antenna fitted in a manner typical of normal intended use as integral antenna equipment as described with the test results.

Transmitter Test Signals	
Frequency Band(s):	1 Mbps: 2402 - 2480 MHz 2 Mbps: 2404 - 2478 MHz
Frequency(ies) Tested:	1 Mbps: 2402 MHz, 2440 MHz, 2478 MHz, 2480 MHz 2 Mbps: 2404 MHz, 2440 MHz, 2476 MHz, 2478 MHz
RF Power Output: (measured maximum output power at antenna terminals)	20.33 dBm Peak
Normal Test Modulation:	GFSK
Modulating Signal Source:	Internal

EXHIBIT 4. SUMMARY OF TEST RESULTS

4.1. LOCATION OF TESTS

All of the measurements described in this report were performed at Ultratech Group of Labs located in the city of Oakville, Province of Ontario, Canada.

- AC Power Line Conducted Emissions were performed in UltraTech's shielded room, 24'(L) by 16'(W) by 8'(H).
- Radiated Emissions were performed at the Ultratech's 3-10 TDK Semi-Anechoic Chamber situated in the Town of Oakville, province of Ontario. This test site been calibrated in accordance with ANSI C63.4, and found to be in compliance with the requirements of Sec. 2.948 of the FCC Rules. The descriptions and site measurement data of the Oakville 3-10 TDK Semi-Anechoic Chamber has been filed with ANAB File No.: AT-1945.

4.2. APPLICABILITY & SUMMARY OF EMC EMISSION TEST RESULTS

FCC Section(s)	Test Requirements	Compliance (Yes/No)
15.203	Antenna requirements	Yes*
15.207(a)	AC Power Line Conducted Emissions	Yes
15.247(a)(2)	6 dB Bandwidth	Yes
15.247(b)(3)	Peak Conducted Output Power	Yes
15.247(d)	Band-Edge and RF Conducted Spurious Emissions at the Transmitter Antenna Terminal	Yes
15.247(d), 15.209 & 15.205	Transmitter Spurious Radiated Emissions	Yes
15.247(e)	Power Spectral Density	Yes
15.247(i), 1.1307, 1.1310, 2.1091	RF Exposure	Yes

* The EUT complies with the requirement; it employs a unique (non-standard) antenna connector or integral antenna.

4.3. MODIFICATIONS INCORPORATED IN THE EUT FOR COMPLIANCE PURPOSES

None.

EXHIBIT 5. TEST DATA

5.1. POWER LINE CONDUCTED EMISSIONS [§15.207(a)]

5.1.1. Limit(s)

The equipment shall meet the limits of the following table:

Frequency of emission (MHz)	Conducted Limits (dBµV)	
	Quasi-peak	Average
0.15–0.5	66 to 56*	56 to 46*
0.5–5	56	46
5–30	60	50

*Decreases linearly with the logarithm of the frequency

5.1.2. Method of Measurements

ANSI C63.4

5.1.3. Test Arrangement

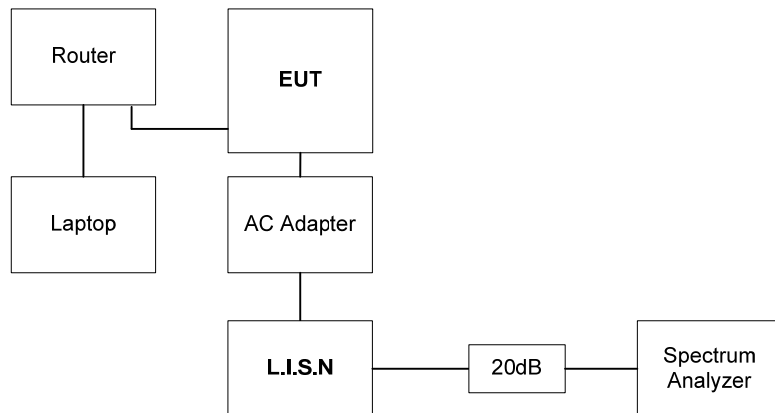

5.1.4. Test Data

Plot 5.1.4.1. Power Line Conducted Emissions (BLE in Tx Mode)
 Line Voltage: 120 VAC; Line Tested: Hot

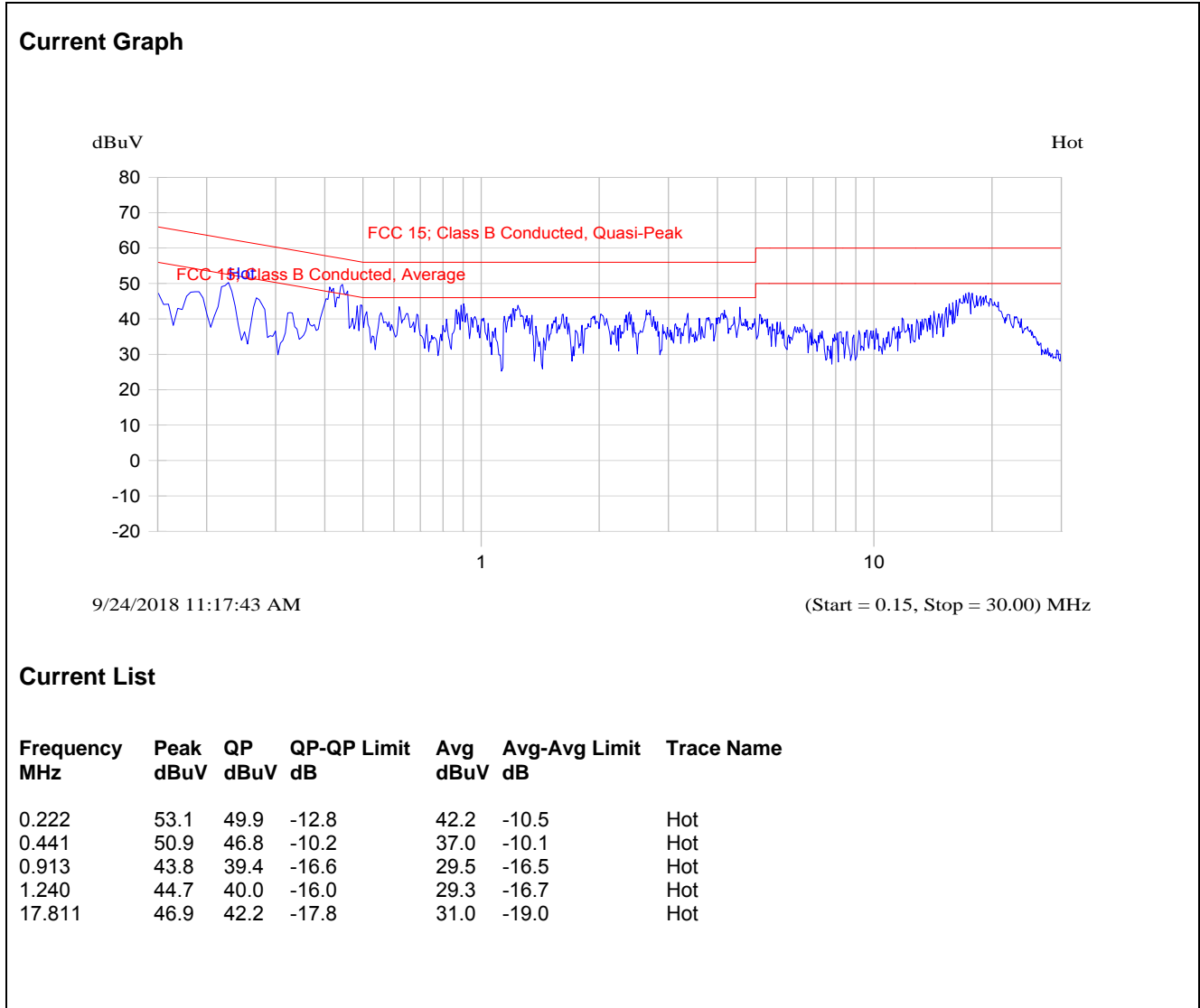

Plot 5.1.4.2. Power Line Conducted Emissions (Tx Mode)
 Line Voltage: 120 VAC Line Tested: Neutral

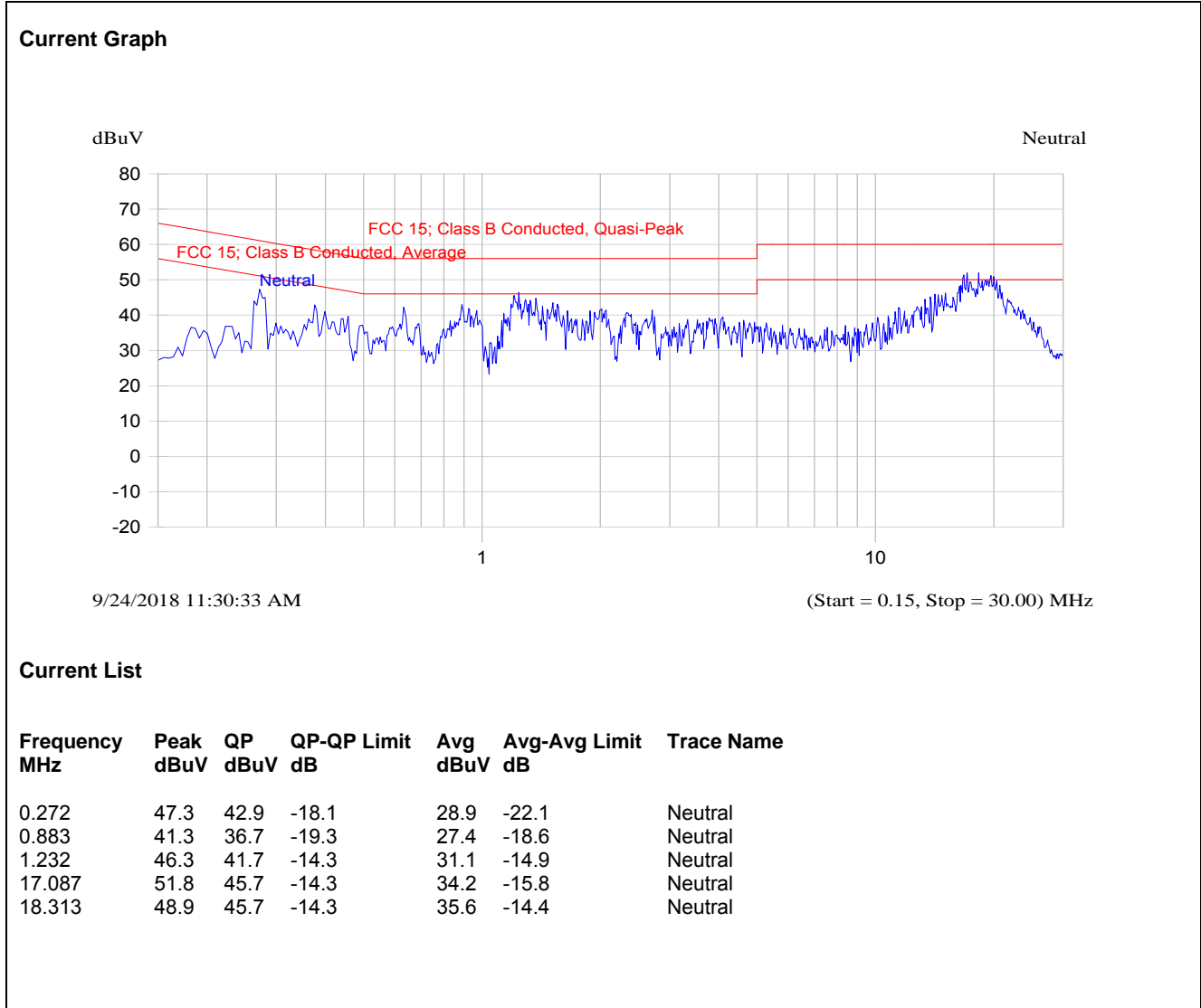

Plot 5.1.4.3. Power Line Conducted Emissions (Rx Mode)
 Line Voltage: 120 VAC; Line Tested: Hot

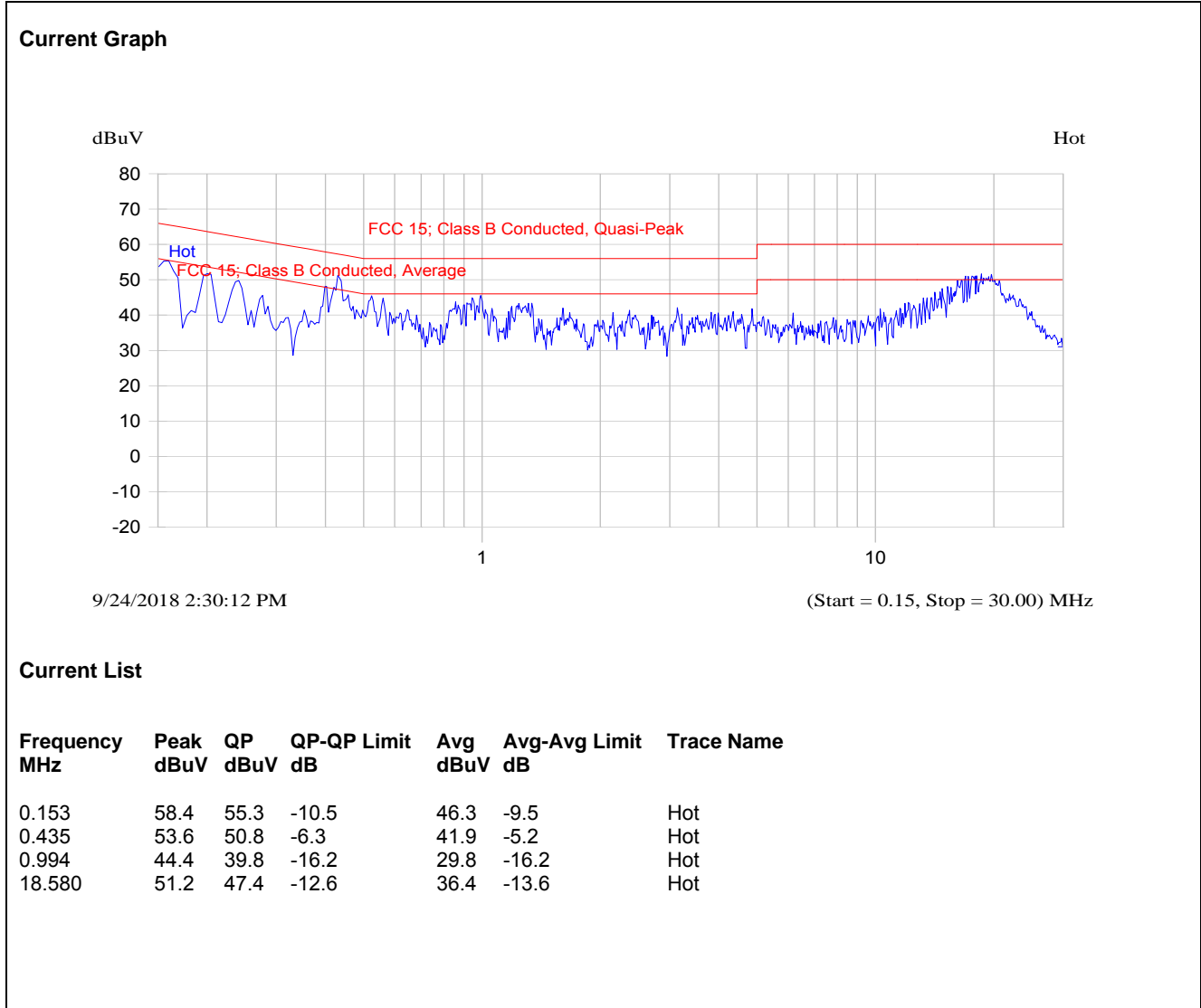

Plot 5.1.4.4. Power Line Conducted Emissions (Rx Mode)
 Line Voltage: 120 VAC; Line Tested: Neutral

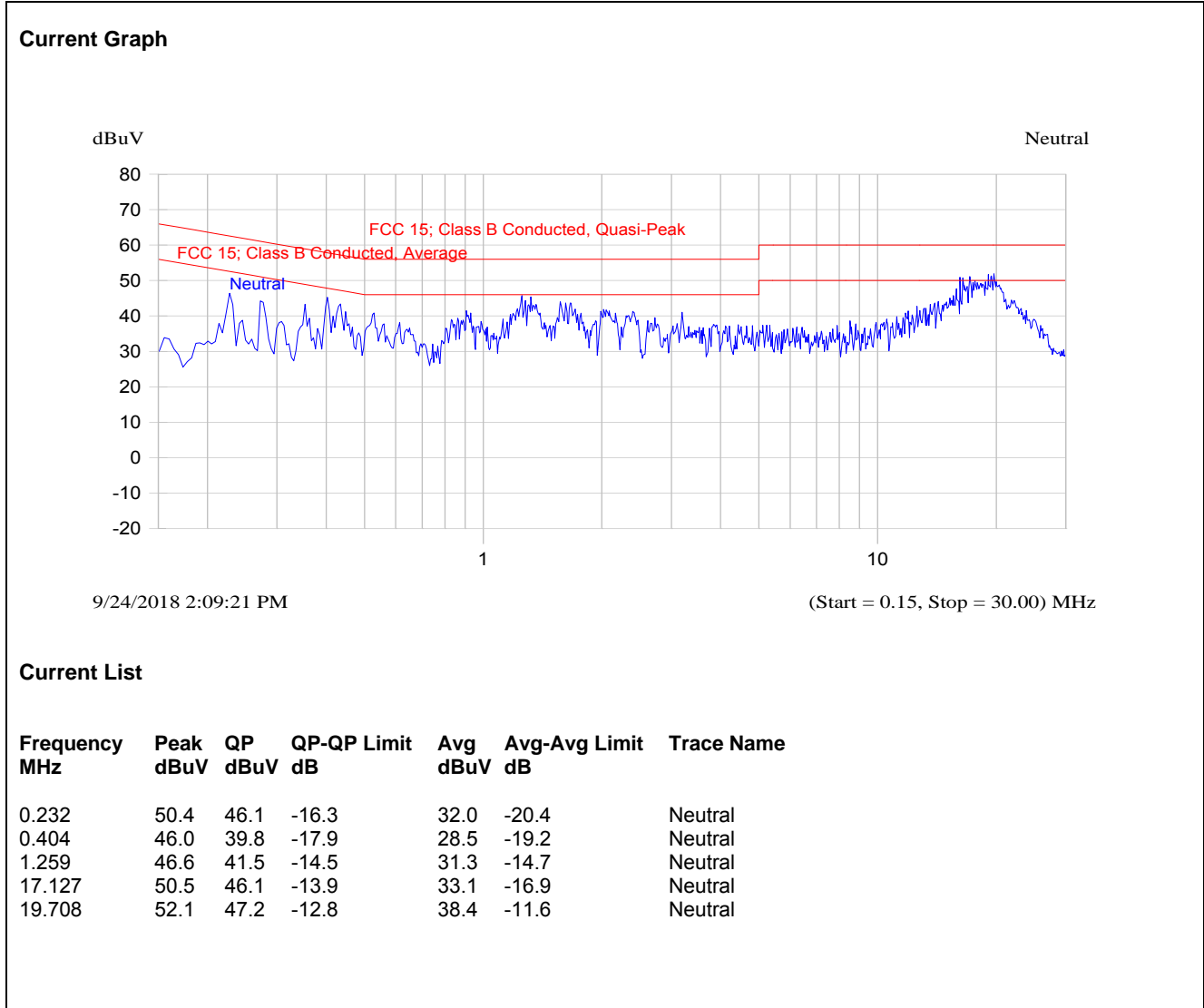

5.2. OCCUPIED BANDWIDTH [§ 15.247(a)(2)]

5.2.1. Limit(s)

The minimum 6 dB bandwidth shall be at least 500 kHz.

5.2.2. Method of Measurements

FCC KDB 558074 D01 15.247 Meas Guidance v05, Section 8.2 DTS Bandwidth / Subclause 11.8 of ANSI C63.10

5.2.3. Test Arrangement

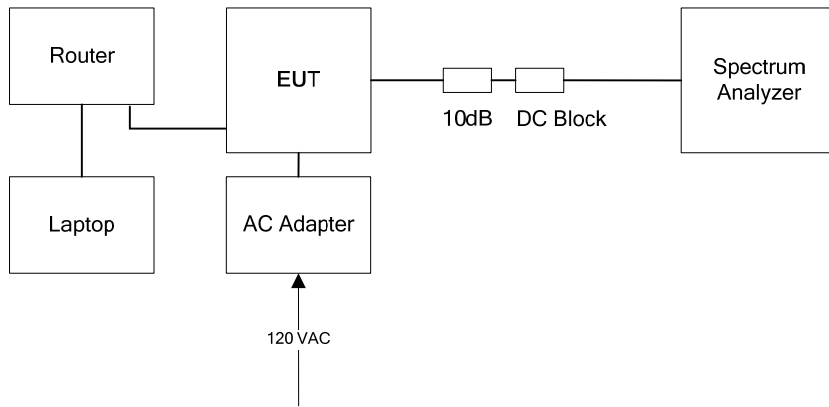

5.2.4. Test Data

Modulation	Data Rate (Mbps)	Power Setting	Channel	Frequency (MHz)	6dB BW (kHz)	Min. Limit (kHz)
GFSK	1	200	37	2402	762.82	500
		200	17	2440	762.82	500
		200	39	2480	708.33	500
	2	200	00	2404	1408.65	500
		200	17	2440	1408.65	500
		200	36	2478	1375.00	500

Plot 5.2.4.1. 6 dB Bandwidth, GFSK Modulation, Power Setting at 200, Channel 37, 2402 MHz, 1 Mbps

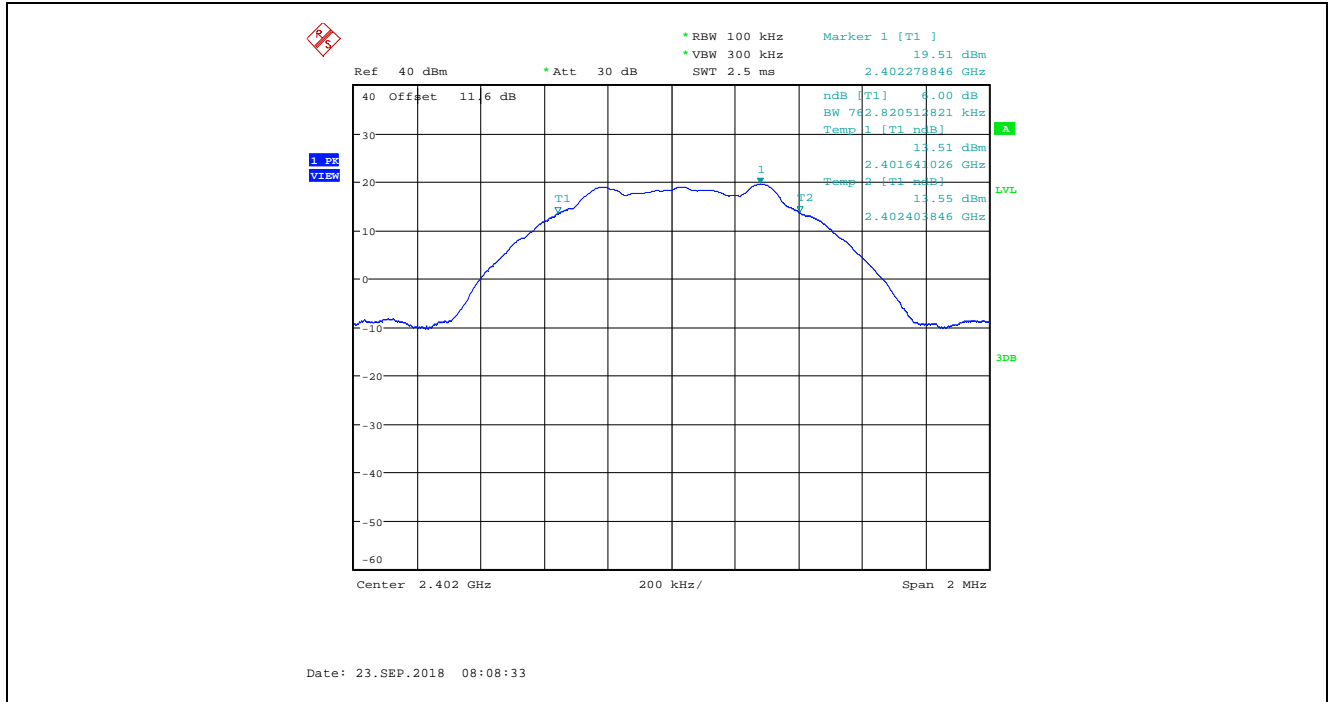

Plot 5.2.4.2. 6 dB Bandwidth, GFSK Modulation, Power Setting at 200, Channel 17, 2440 MHz, 1 Mbps

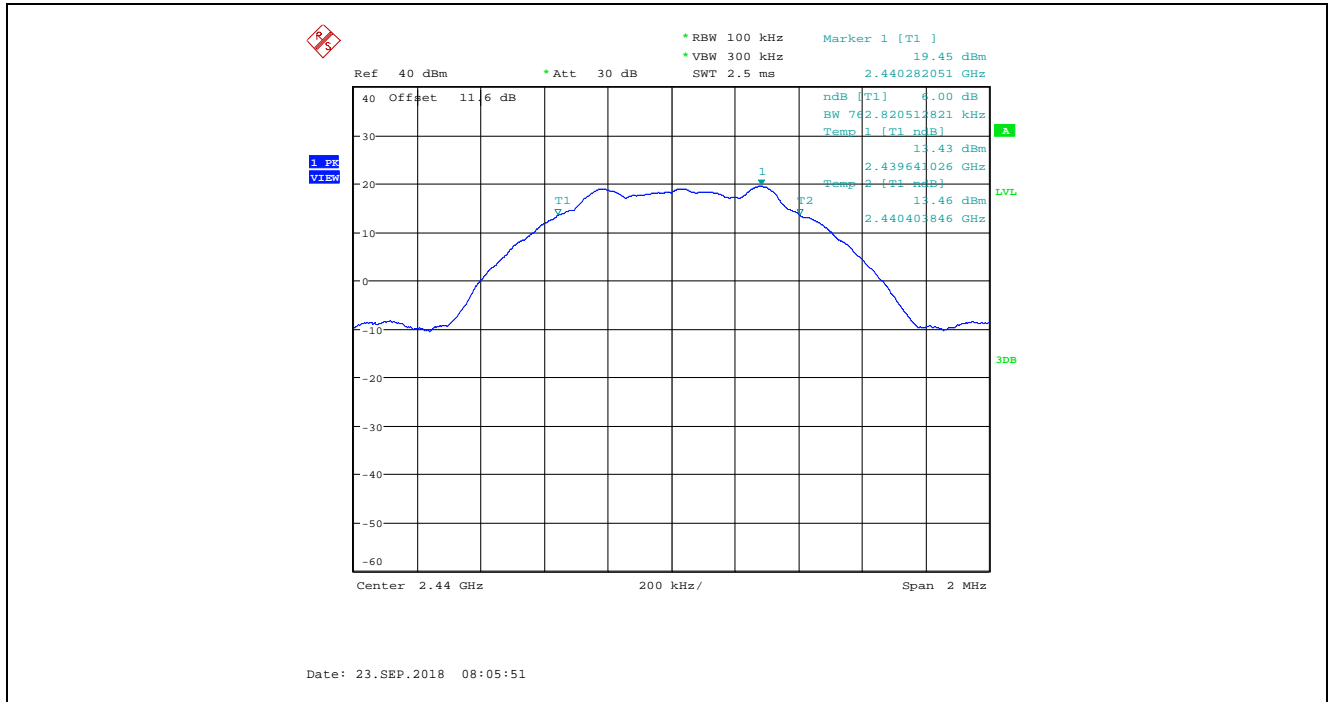

Plot 5.2.4.3. 6 dB Bandwidth, GFSK Modulation, Power Setting at 200, Channel 39, 2480 MHz, 1 Mbps

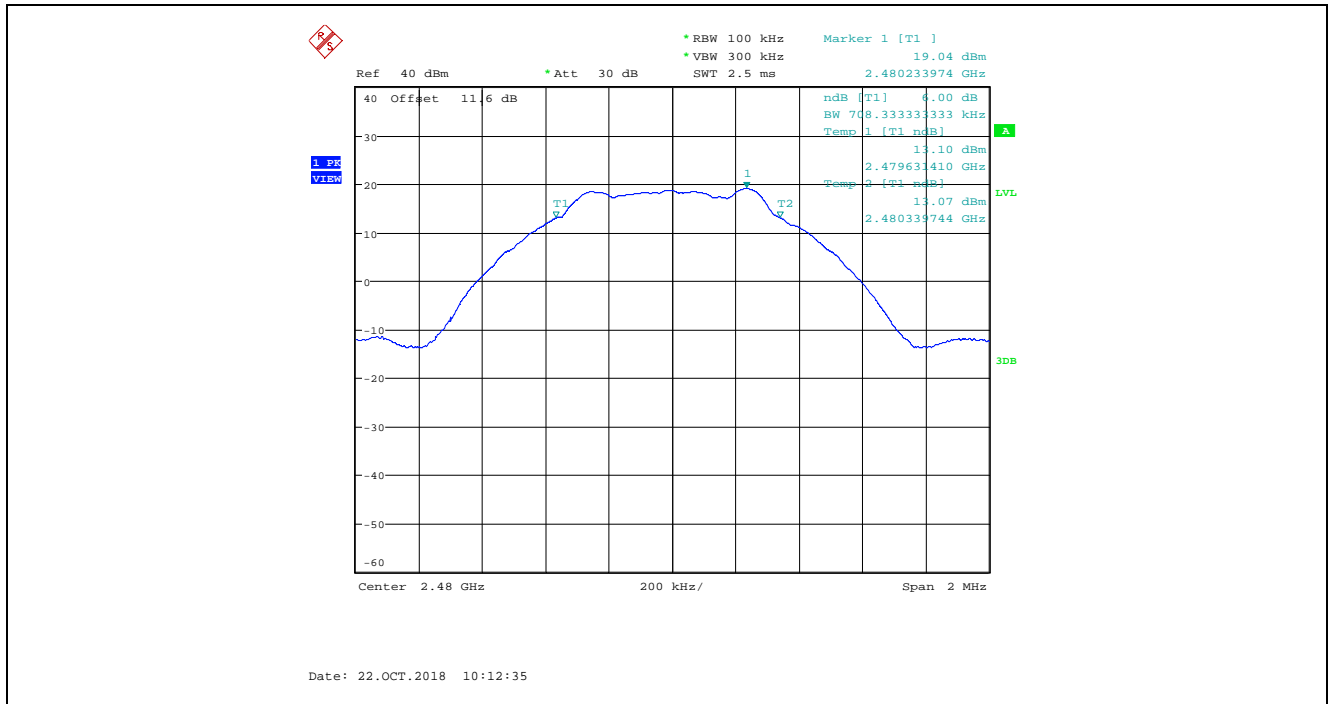

Plot 5.2.4.4. 6 dB Bandwidth, GFSK Modulation, Power Setting at 200, Channel 00, 2404 MHz, 2 Mbps

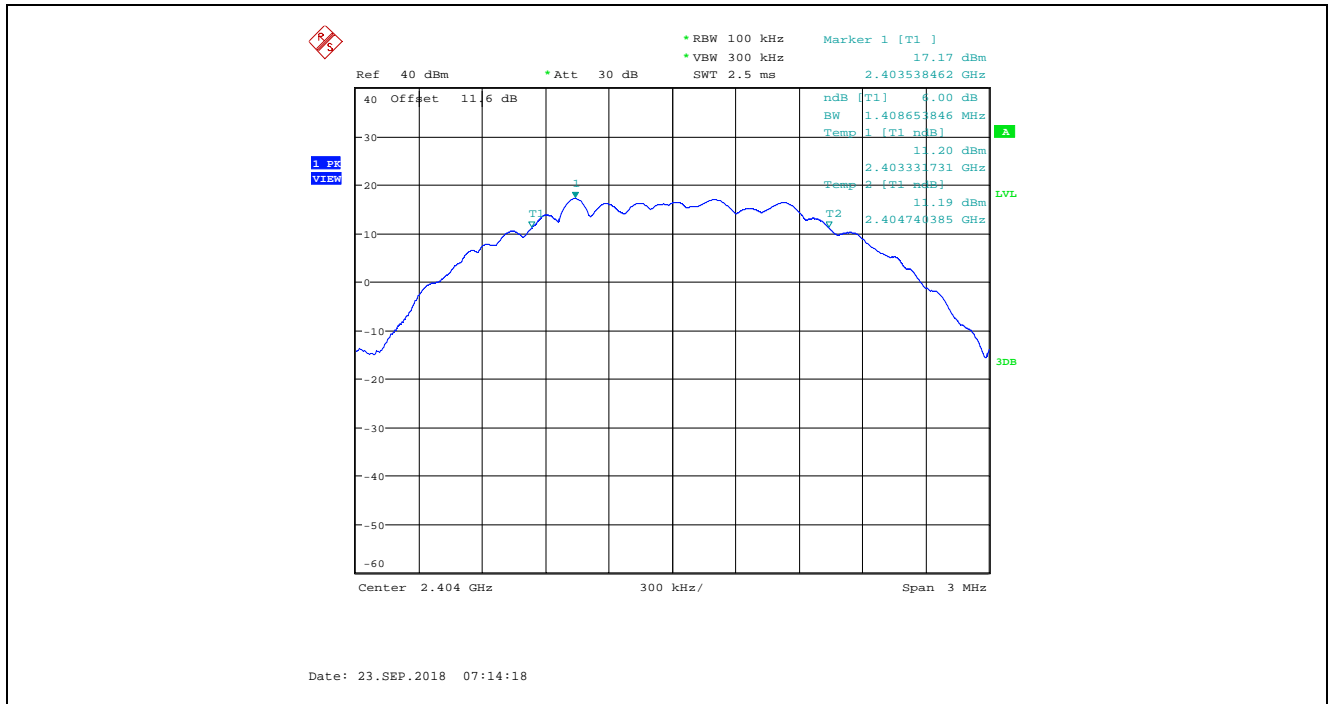

Plot 5.2.4.5. 6 dB Bandwidth, GFSK Modulation, Power Setting at 200, Channel 17, 2440 MHz, 2 Mbps

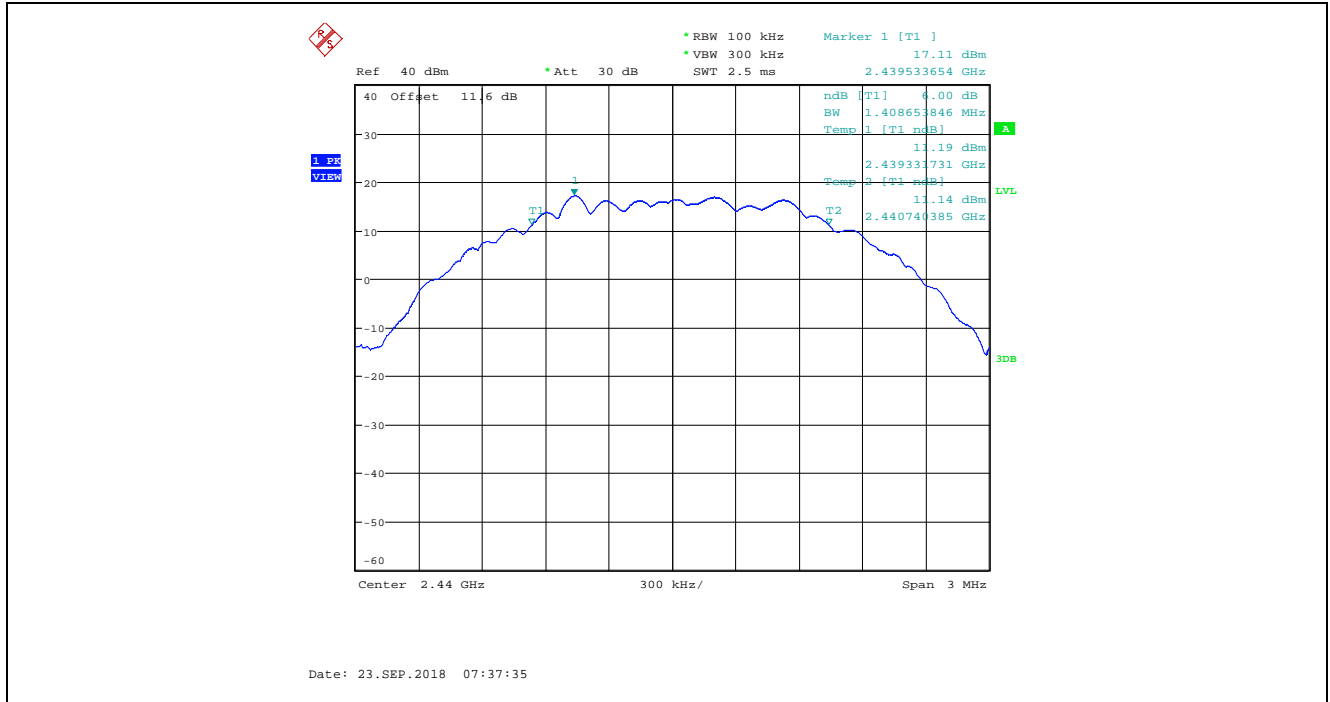

Plot 5.2.4.6. 6 dB Bandwidth, GFSK Modulation, Power Setting at 200, Channel 36, 2478 MHz, 2 Mbps

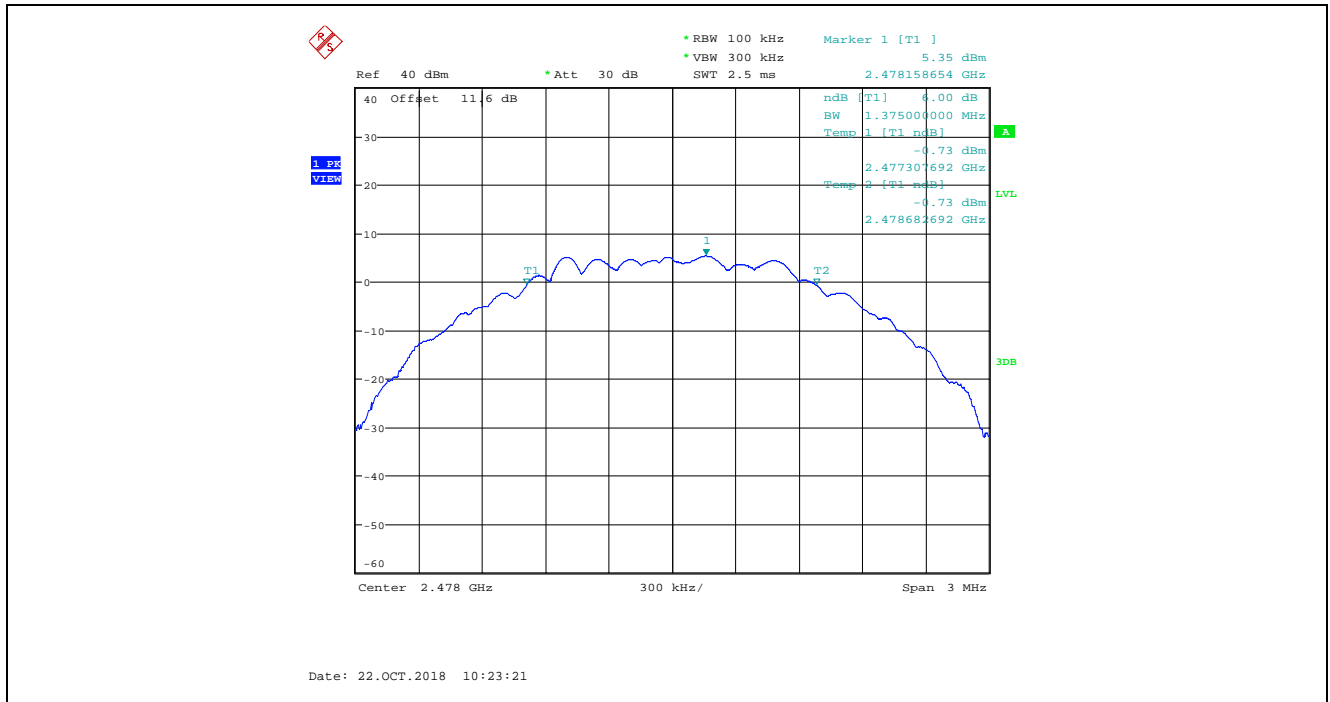

5.3. PEAK CONDUCTED OUTPUT POWER - DTS [§ 15.247(b)(3)]

5.3.1. Limit(s)

§ 15.247(b)(3): For systems using digital modulation in the 902-928 MHz, 2400-2483.5 MHz, and 5725-5850 MHz bands: 1 Watt. As an alternative to a peak power measurement, compliance with the one Watt limit can be based on a measurement of the maximum conducted output power. Maximum Conducted Output Power is defined as the total transmit power delivered to all antennas and antenna elements averaged across all symbols in the signaling alphabet when the transmitter is operating at its maximum power control level. Power must be summed across all antennas and antenna elements. The average must not include any time intervals during which the transmitter is off or is transmitting at a reduced power level. If multiple modes of operation are possible (e.g., alternative modulation methods), the *maximum conducted output power* is the highest total transmit power occurring in any mode.

§ 15.247(b)(4): The conducted output power limit specified in paragraph (b) of this section is based on the use of antennas with directional gains that do not exceed 6 dBi. Except as shown in paragraph (c) of this section, if transmitting antennas of directional gain greater than 6 dBi are used, the conducted output power from the intentional radiator shall be reduced below the stated values in paragraphs (b)(1), (b)(2), and (b)(3) of this section, as appropriate, by the amount in dB that the directional gain of the antenna exceeds 6 dBi.

5.3.2. Method of Measurements & Test Arrangement

FCC KDB 558074 D01 15.247 Meas Guidance v05, Section 8.3.1.1 RBW ≥ DTS bandwidth / Subclause 11.9.1.1 of ANSI C63.10

5.3.3. Test Arrangement

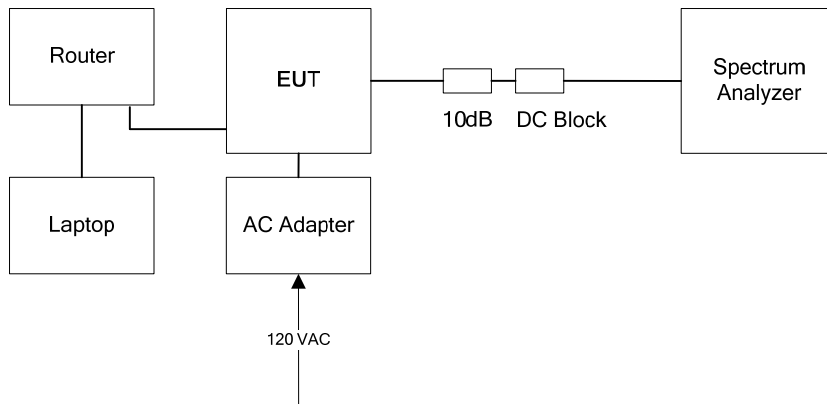

5.3.4. Test Data

Peak Conducted Power and Power Settings for EUT with 5.2 dBi Inverted F PCB Trace Antenna							
Modulation	Data Rate (Mbps)	Power Setting	Channel	Frequency (MHz)	Peak Power (dBm)	Assembly Gain (dB)	EIRP (dBm)
GFSK	1	200	37	2402	20.33	5.2	25.53
		200	17	2440	20.22	5.2	25.42
		200	36	2478	15.68	5.2	20.88
		200	39	2480	20.06	5.2	25.26
	2	200	0	2404	20.31	5.2	25.51
		200	17	2440	20.23	5.2	25.43
		200	35	2476	12.75	5.2	17.95
		200	36	2478	8.72	5.2	13.92

Plot 5.3.4.1. Maximum Peak Conducted Output Power, GFSK Modulation, 1 Mbps, Power Setting 200, Ch 37, 2402 MHz

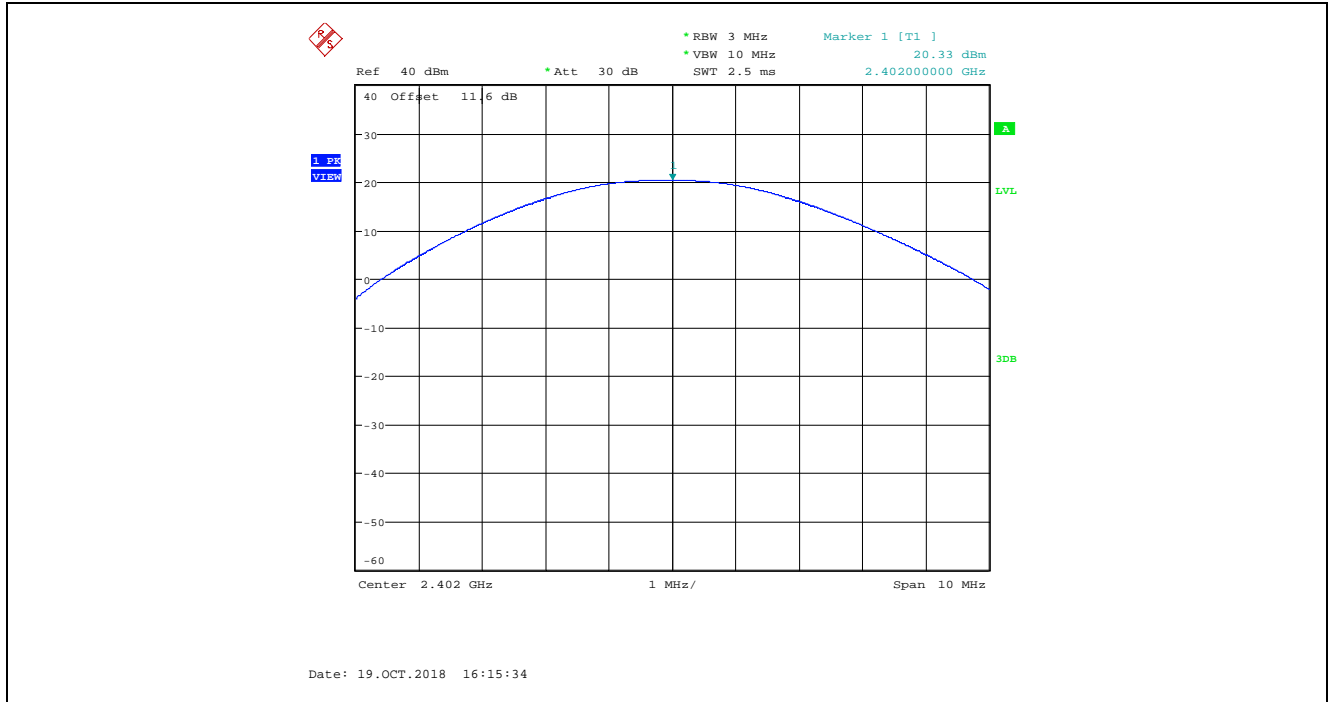

Plot 5.3.4.2. Maximum Peak Conducted Output Power, GFSK Modulation, 1 Mbps, Power Setting 200, Ch 17, 2440 MHz

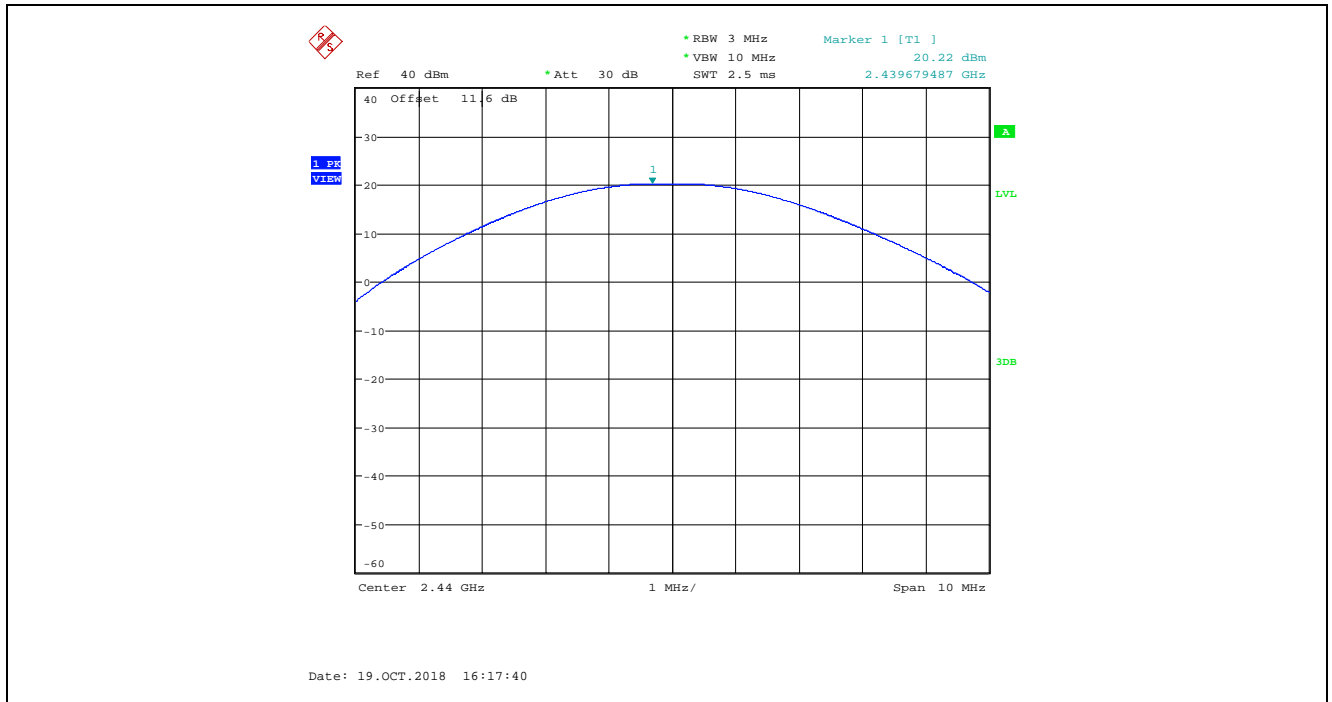

Plot 5.3.4.3. Maximum Peak Conducted Output Power, GFSK Modulation, 1 Mbps, Power Setting 200, Ch 36, 2478 MHz

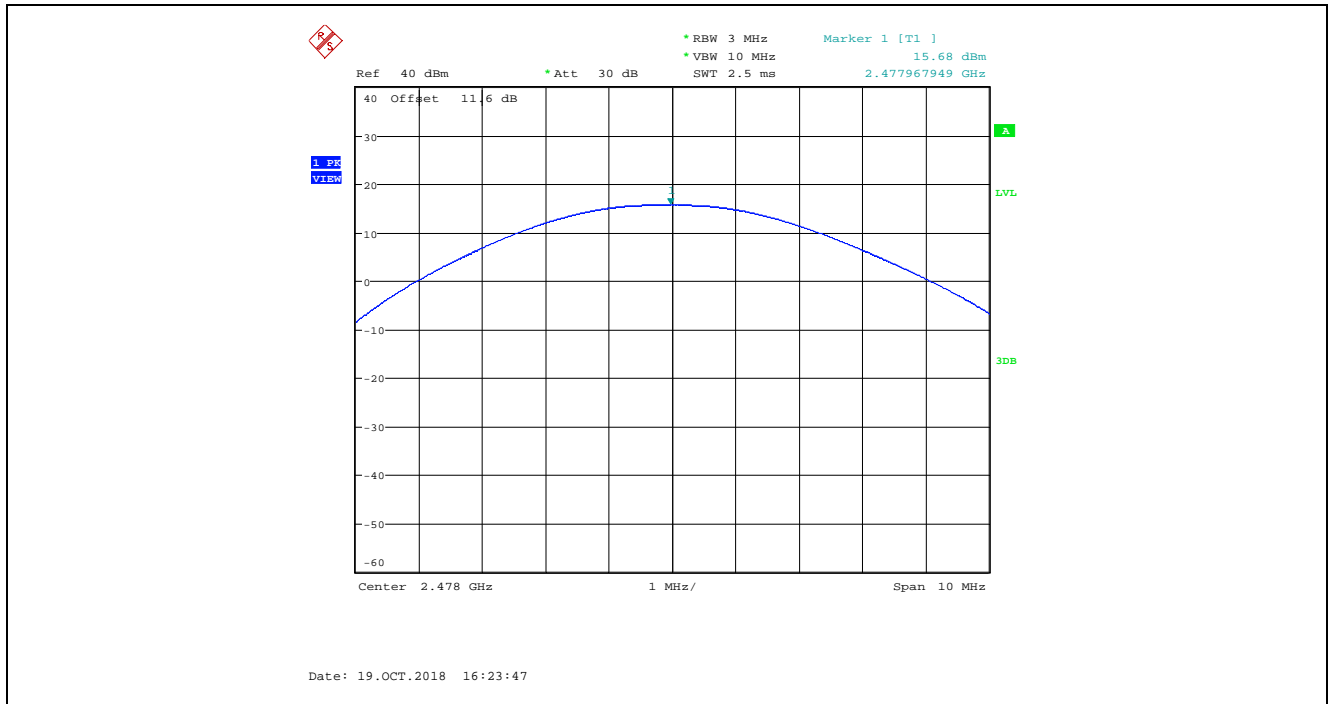

Plot 5.3.4.4. Maximum Peak Conducted Output Power, GFSK Modulation, 1 Mbps, Power Setting 200, Ch 39, 2480 MHz

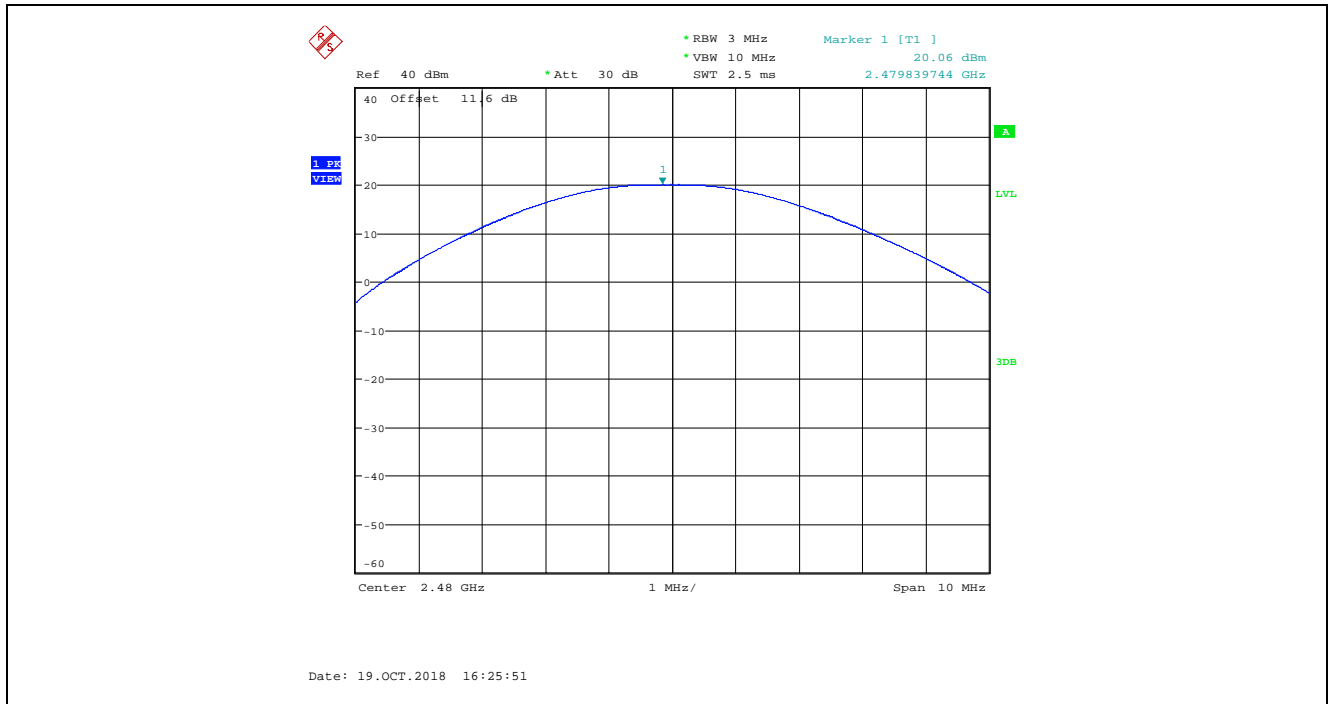

Plot 5.3.4.5. Maximum Peak Conducted Output Power, GFSK Modulation, 2 Mbps, Power Setting 200, Ch 00, 2404 MHz

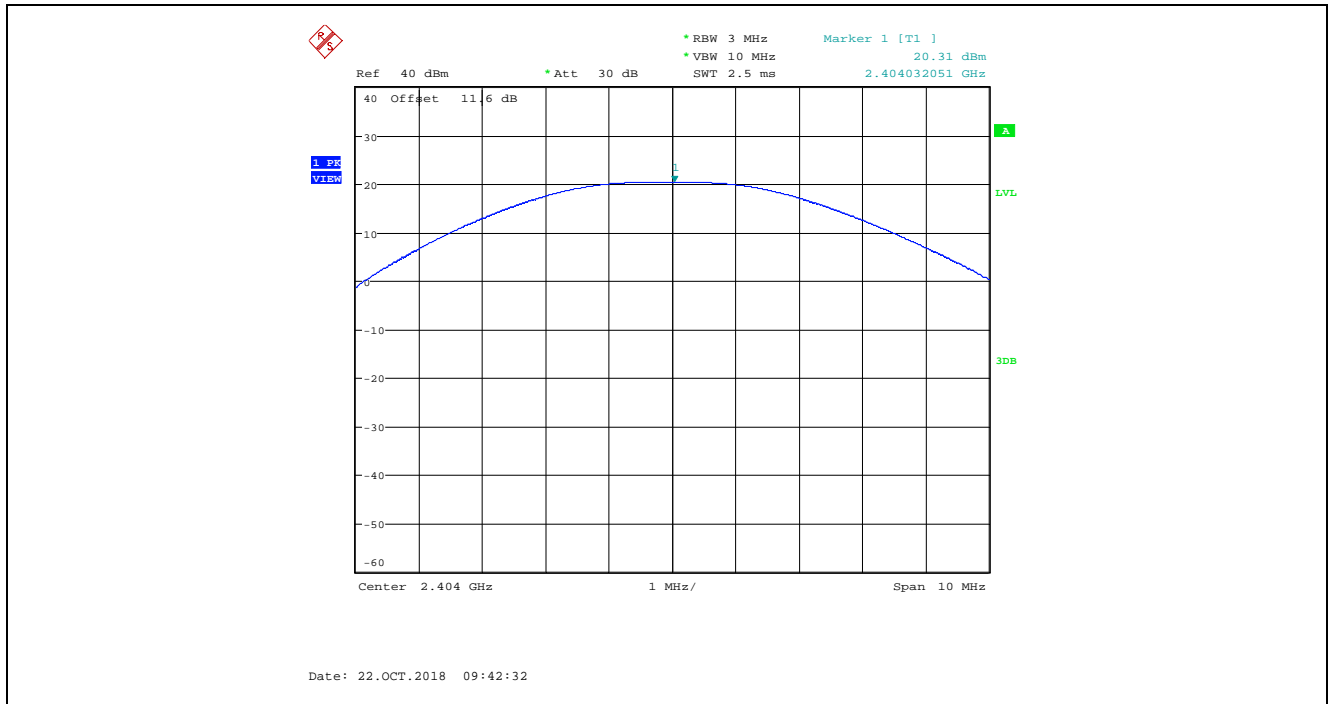

Plot 5.3.4.6. Maximum Peak Conducted Output Power, GFSK Modulation, 2 Mbps, Power Setting 200, Ch 17, 2440 MHz

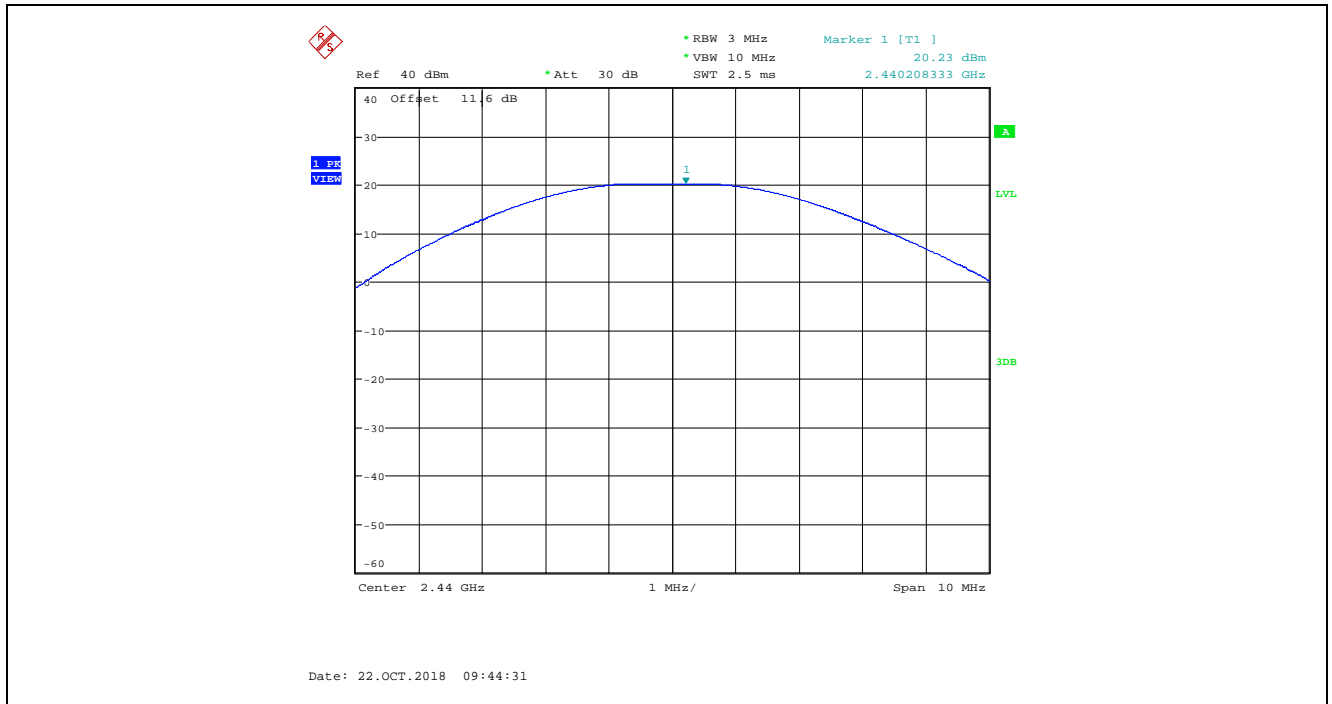

Plot 5.3.4.7. Maximum Peak Conducted Output Power, GFSK Modulation, 2 Mbps, Power Setting 200, Ch 35, 2476 MHz

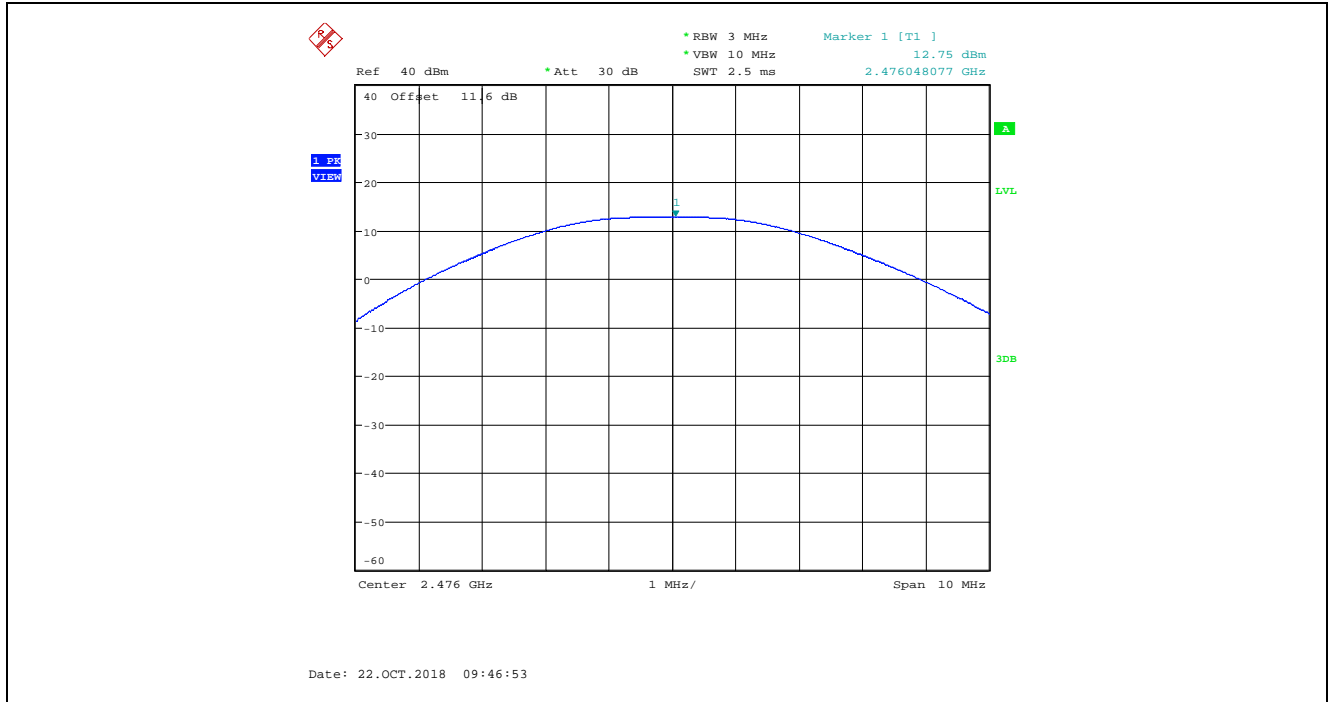

Plot 5.3.4.8. Maximum Peak Conducted Output Power, GFSK Modulation, 2 Mbps, Power Setting 200, Ch 36, 2478 MHz

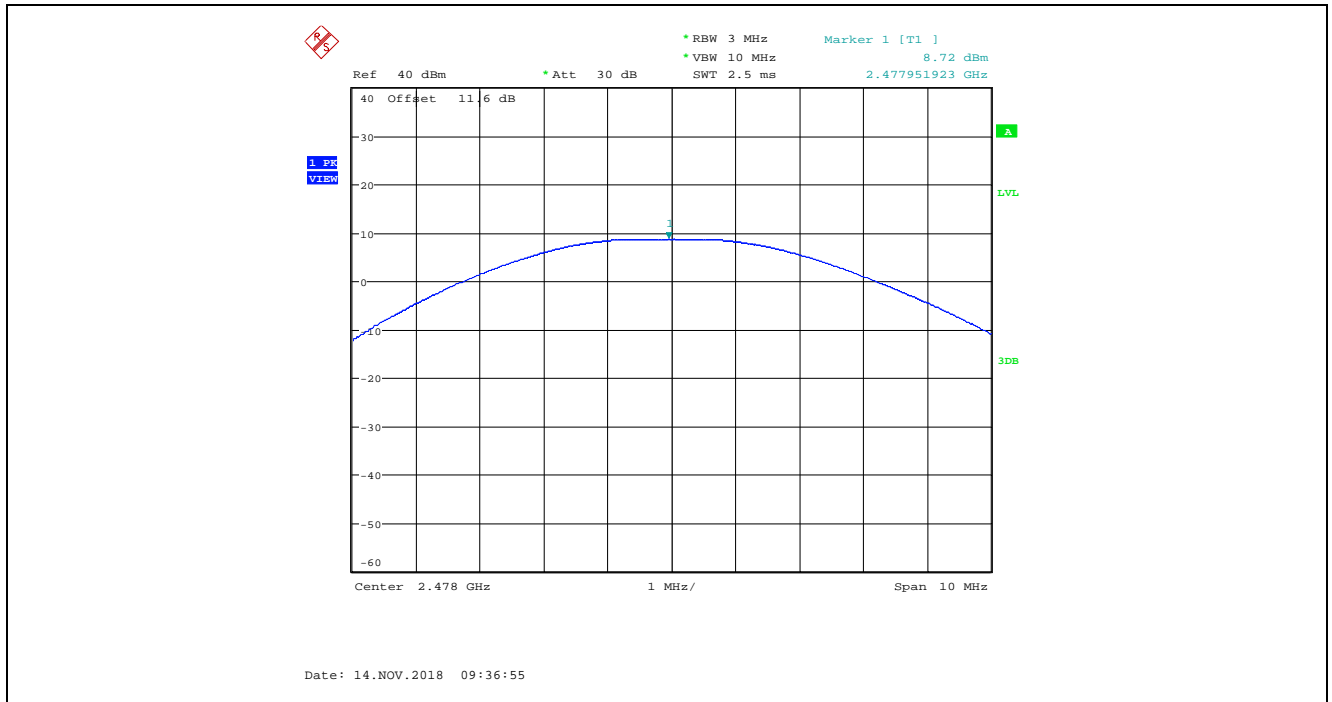

5.4. TRANSMITTER SPURIOUS RADIATED EMISSIONS AT 3 METERS [§§ 15.247(d), 15.209 & 15.205]

5.4.1. Limit(s)

§ 15.247 (d): In any 100 kHz bandwidth outside the frequency band in which the spread spectrum or digitally modulated intentional radiator is operating, the radio frequency power that is produced by the intentional radiator shall be at least 20 dB below that in the 100 kHz bandwidth within the band that contains the highest level of the desired power, based on either an RF conducted or a radiated measurement, provided the transmitter demonstrates compliance with the peak conducted power limits. If the transmitter complies with the conducted power limits based on the use of RMS averaging over a time interval, as permitted under paragraph (b)(3) of this section, the attenuation required under this paragraph shall be 30 dB instead of 20 dB. Attenuation below the general limits specified in Section 15.209(a) is not required. In addition, radiated emissions which fall in the restricted bands, as defined in Section 15.205(a), must also comply with the radiated emission limits specified in Section 15.209(a) (see Section 15.205(c)).

Section 15.205(a) - Restricted Bands of Operation

MHz	MHz	MHz	GHz
0.090–0.110	16.42–16.423	399.9–410	4.5–5.15
¹ 0.495–0.505	16.69475–16.69525	608–614	5.35–5.46
2.1735–2.1905	16.80425–16.80475	960–1240	7.25–7.75
4.125–4.128	25.5–25.67	1300–1427	8.025–8.5
4.17725–4.17775	37.5–38.25	1435–1626.5	9.0–9.2
4.20725–4.20775	73–74.6	1645.5–1646.5	9.3–9.5
6.215–6.218	74.8–75.2	1660–1710	10.6–12.7
6.26775–6.26825	108–121.94	1718.8–1722.2	13.25–13.4
6.31175–6.31225	123–138	2200–2300	14.47–14.5
8.291–8.294	149.9–150.05	2310–2390	15.35–16.2
8.362–8.366	156.52475–156.52525	2483.5–2500	17.7–21.4
8.37625–8.38675	156.7–156.9	2655–2900	22.01–23.12
8.41425–8.41475	162.0125–167.17	3260–3267	23.6–24.0
12.29–12.293	167.72–173.2	3332–3339	31.2–31.8
12.51975–12.52025	240–285	3345.8–3358	36.43–36.5
12.57675–12.57725	322–335.4	3600–4400	(²)
13.36–13.41.			

¹Until February 1, 1999, this restricted band shall be 0.490–0.510 MHz.

²Above 38.6

Section 15.209(a) - Field Strength Limits within Restricted Frequency Bands

Frequency (MHz)	Field Strength (microvolts/meter)	Measurement Distance (meters)
0.009 - 0.490	2,400 / F (kHz)	300
0.490 - 1.705	24,000 / F (kHz)	30
1.705 - 30.0	30	30
30 - 88	100	3
88 - 216	150	3
216 - 960	200	3
Above 960	500	3

5.4.2. Method of Measurements

FCC KDB 558074 D01 15.247 Meas Guidance v05 Sections 8.5, 8.6 and 8.7 / Subclauses 11.11, 11.12 and 11.13.of ANSI C63.10.

5.4.3. Test Arrangement

Radiated Emissions

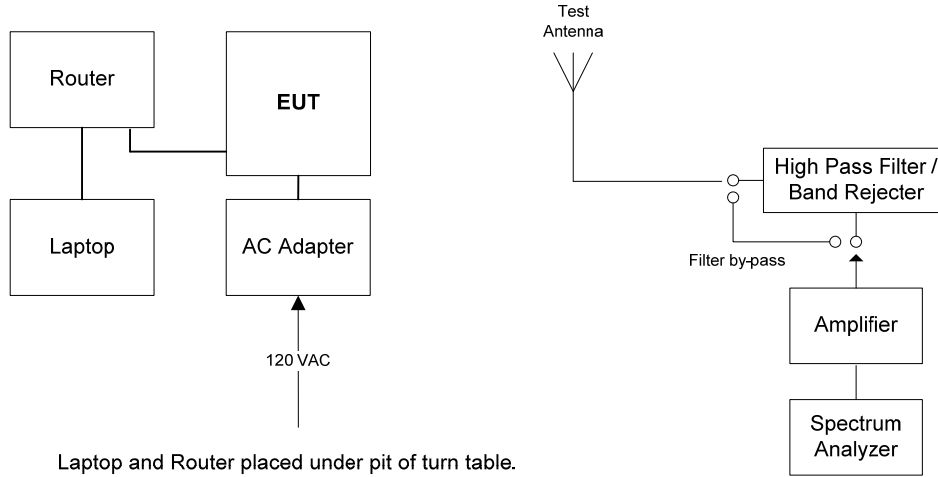

Band-Edge Radiated Emissions

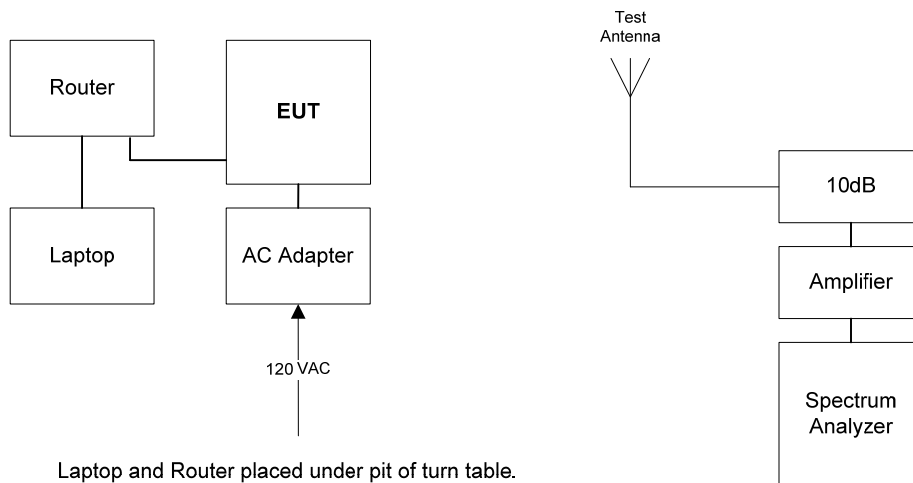

5.4.4. Test Data

5.4.4.1. Transmitter Spurious Radiated Emissions

Remark(s):

- All spurious emissions that are in excess of 20 dB below the specified limit shall be recorded.
- EUT shall be tested in three orthogonal positions.
- The simultaneous transmission was investigated and no new emissions were found.
- Exploratory tests performed to determined worst-case test configurations, the following test results at high power setting represent the worst-case.

Fundamental Frequency:		2402 MHz					
Frequency Test Range:		30 MHz – 25 GHz					
Frequency (MHz)	RF Peak Level (dBµV/m)	RF Avg Level (dBµV/m)	Antenna Plane (H/V)	Limit 15.209 (dBµV/m)	Limit 15.247 (dBµV/m)	Margin (dB)	Pass/Fail
2402	118.32	118.32	V	--	--	--	--
2402	121.14	121.14	H	--	--	--	--
4804	57.72	46.40	V	54.0	101.1	-7.6	Pass*
4804	57.58	45.44	H	54.0	101.1	-8.6	Pass*

*Field strength of emissions appearing within restricted frequency bands shall not exceed the limits in § 15.209.

Fundamental Frequency:		2440 MHz					
Frequency Test Range:		30 MHz – 25 GHz					
Frequency (MHz)	RF Peak Level (dBµV/m)	RF Avg Level (dBµV/m)	Antenna Plane (H/V)	Limit 15.209 (dBµV/m)	Limit 15.247 (dBµV/m)	Margin (dB)	Pass/Fail
2440	118.29	118.29	V	--	--	--	--
2440	121.22	121.22	H	--	--	--	--
4880	58.24	47.54	V	54.0	101.2	-6.5	Pass*
4880	59.86	49.49	H	54.0	101.2	-4.5	Pass*
7320	58.96	45.18	V	54.0	101.2	-8.8	Pass*
7320	59.22	45.81	H	54.0	101.2	-8.2	Pass*

*Field strength of emissions appearing within restricted frequency bands shall not exceed the limits in § 15.209.

Fundamental Frequency:		2480 MHz					
Frequency Test Range:		30 MHz – 25 GHz					
Frequency (MHz)	RF Peak Level (dBµV/m)	RF Avg Level (dBµV/m)	Antenna Plane (H/V)	Limit 15.209 (dBµV/m)	Limit 15.247 (dBµV/m)	Margin (dB)	Pass/Fail
2480	118.31	118.31	V	--	--	--	--
2480	121.18	121.18	H	--	--	--	--
4960	59.20	48.81	V	54.0	101.2	-5.2	Pass*
4960	59.35	49.90	H	54.0	101.2	-4.1	Pass*
7440	58.44	44.87	V	54.0	101.2	-9.1	Pass*
7440	59.36	45.10	H	54.0	101.2	-8.9	Pass*

*Field strength of emissions appearing within restricted frequency bands shall not exceed the limits in § 15.209.

ULTRATECH GROUP OF LABS

3000 Bristol Circle, Oakville, Ontario, Canada L6H 6G4
 Tel. #: 905-829-1570, Fax. #: 905-829-8050, Email: vic@ultratech-labs.com, Website: <http://www.ultratech-labs.com>

File #: 18MMBN004_FCC15C247B

November 29, 2018

All test results contained in this engineering test report are traceable to National Institute of Standards and Technology (NIST)

5.4.4.2. Band-Edge Radiated Emissions

Plot 5.4.4.2.1. Band-Edge Radiated Emissions, Lower Band-edge
Rx Antenna in Vertical Polarization, GFSK Modulation, 1 Mbps, Power Setting 200, Ch 37, 2402 MHz

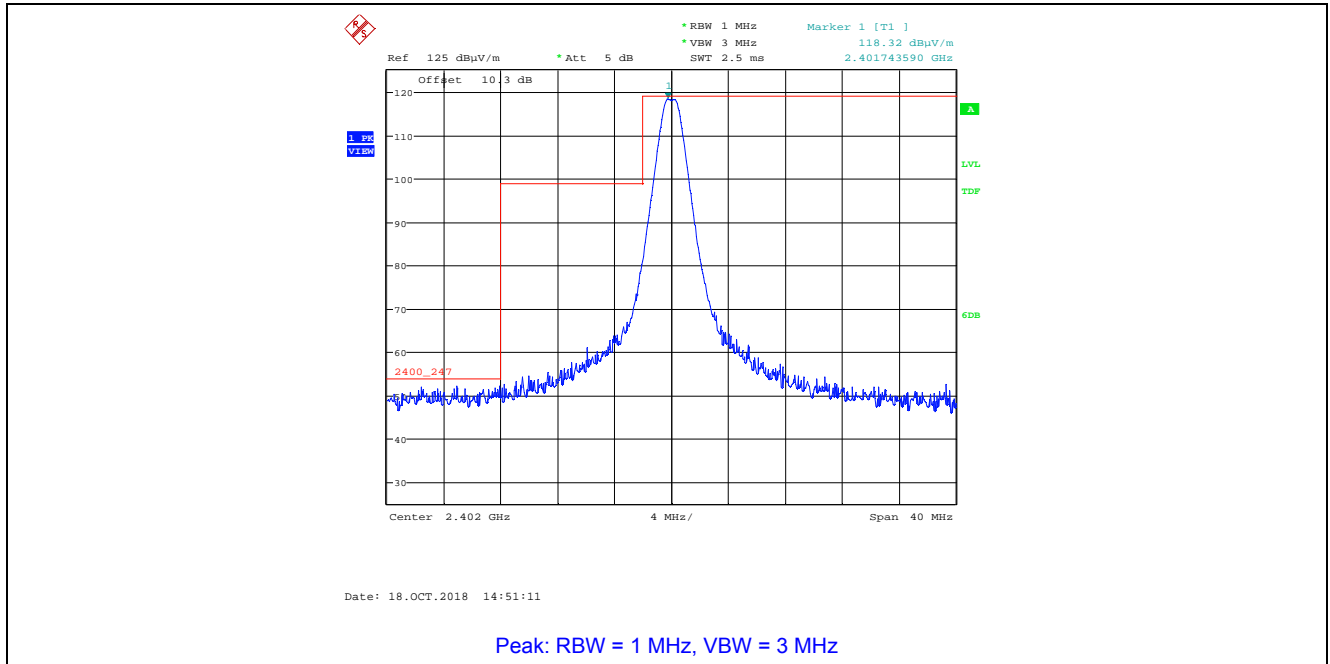

Plot 5.4.4.2.2. Band-Edge Radiated Emissions, Lower Band-edge
Rx Antenna in Vertical Polarization, GFSK Modulation, 1 Mbps, Power Setting 200, Ch 37, 2402 MHz

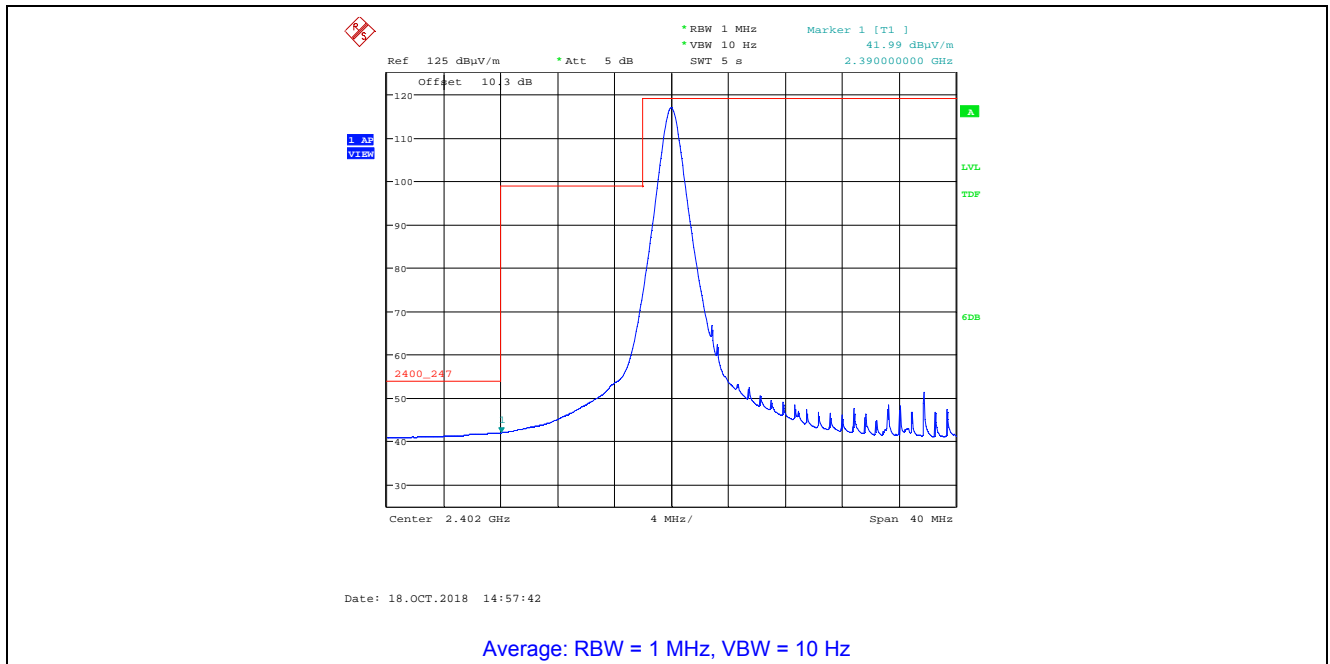

Plot 5.4.4.2.3. Band-Edge Radiated Emissions, Lower Band-edge
Rx Antenna in Horizontal Polarization, GFSK Modulation, 1 Mbps, Power Setting 200, Ch 37, 2402 MHz

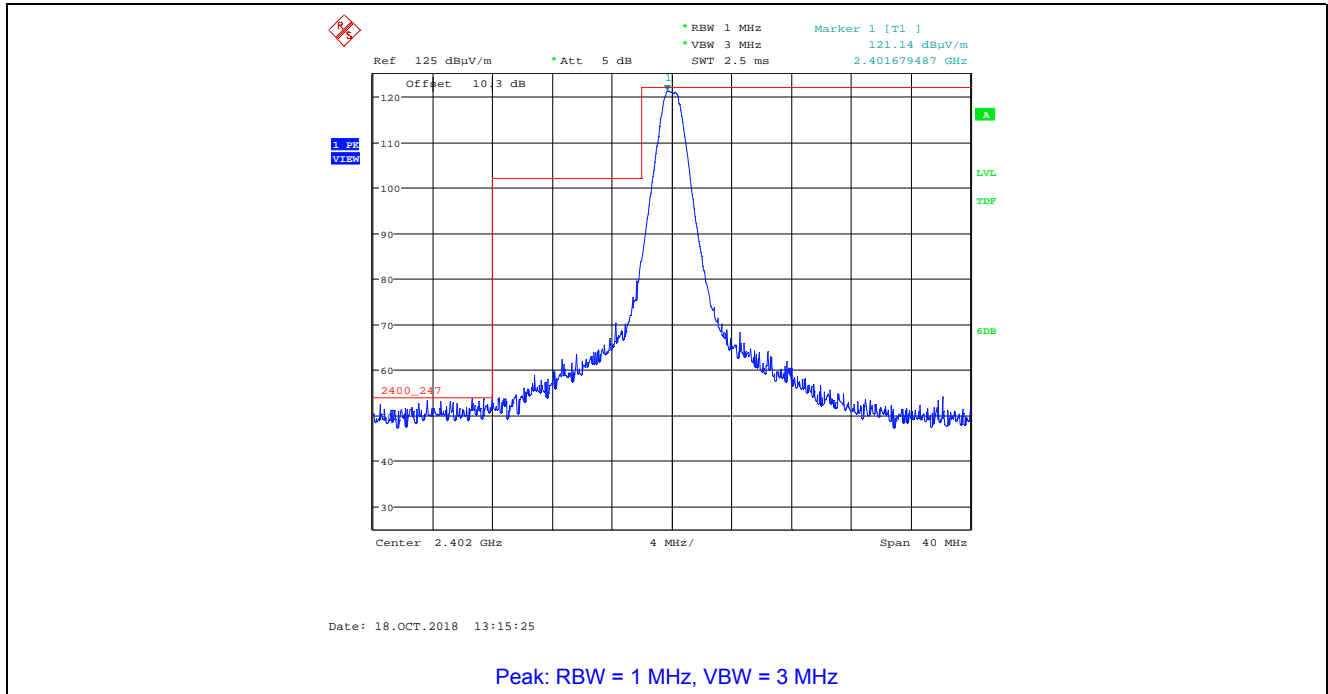

Plot 5.4.4.2.4. Band-Edge Radiated Emissions, Lower Band-edge
Rx Antenna in Horizontal Polarization, GFSK Modulation, 1 Mbps, Power Setting 200, Ch 37, 2402 MHz

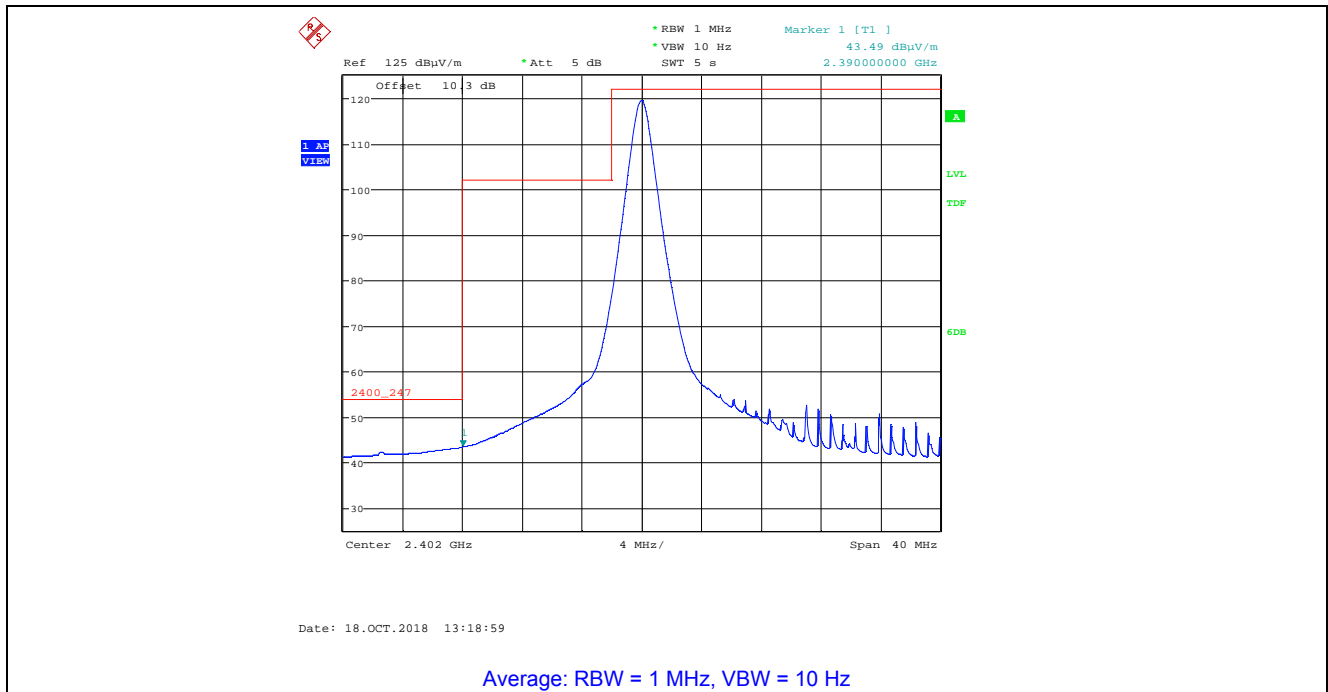

Plot 5.4.4.2.5. Band-Edge Radiated Emissions, Higher Band-edge
 Rx Antenna in Vertical Polarization, GFSK Modulation, 1 Mbps, Power Setting 200, Ch 36, 2478 MHz

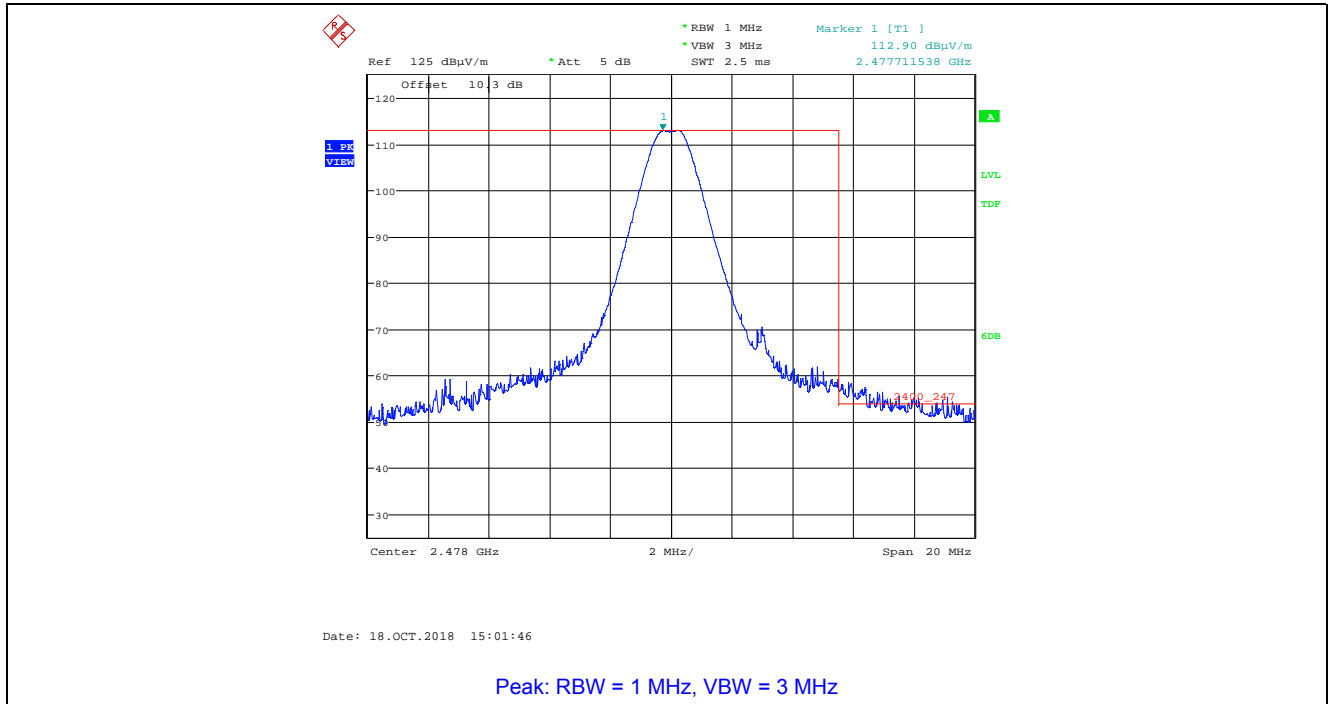

Plot 5.4.4.2.6. Band-Edge Radiated Emissions, Higher Band-edge
 Rx Antenna in Vertical Polarization, GFSK Modulation, 1 Mbps, Power Setting 200, Ch 36, 2478 MHz

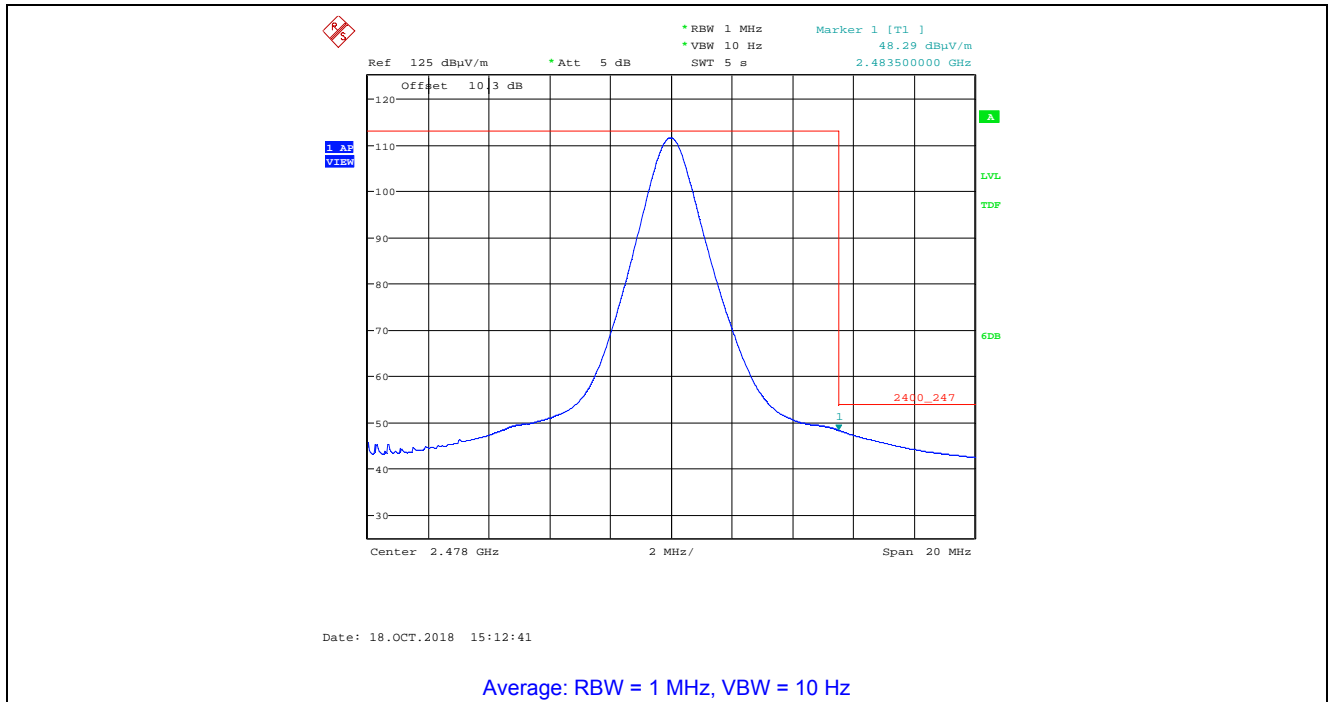

Plot 5.4.4.2.7. Band-Edge Radiated Emissions, Higher Band-edge
Rx Antenna in Horizontal Polarization, GFSK Modulation, 1 Mbps, Power Setting 200, Ch 36, 2478 MHz

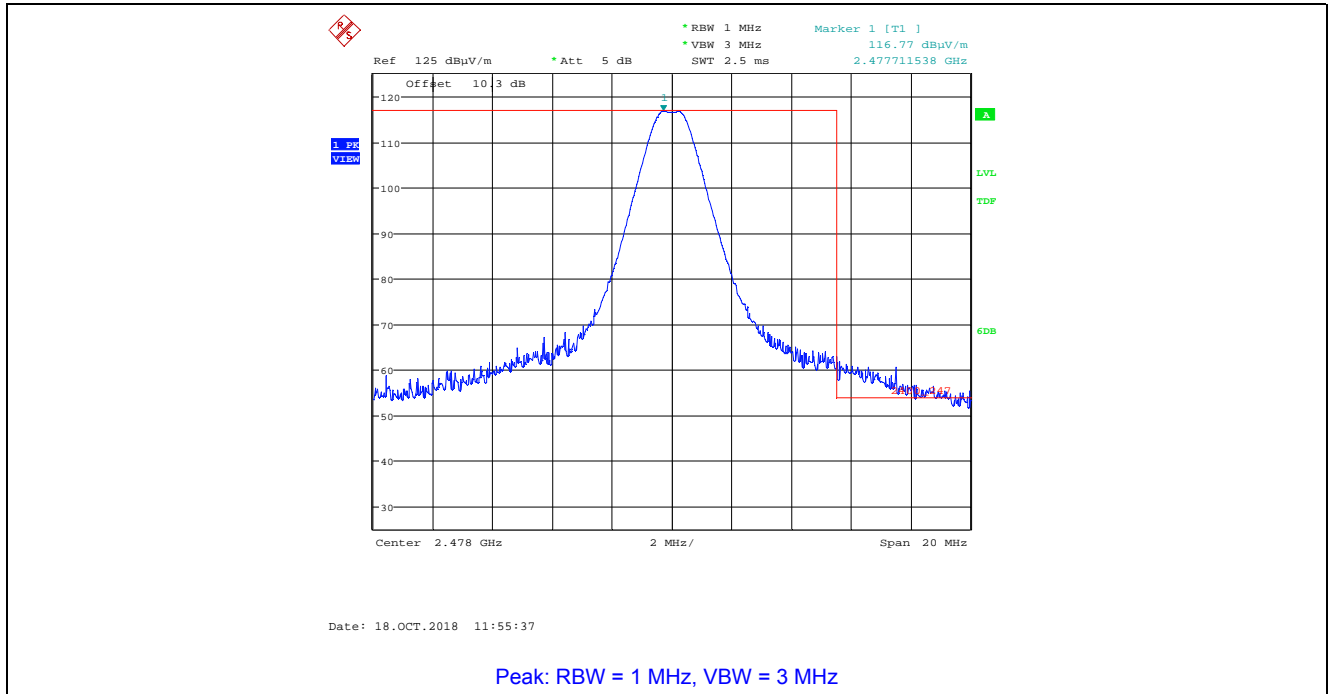

Plot 5.4.4.2.8. Band-Edge Radiated Emissions, Higher Band-edge
Rx Antenna in Horizontal Polarization, GFSK Modulation, 1 Mbps, Power Setting 200, Ch 36, 2478 MHz

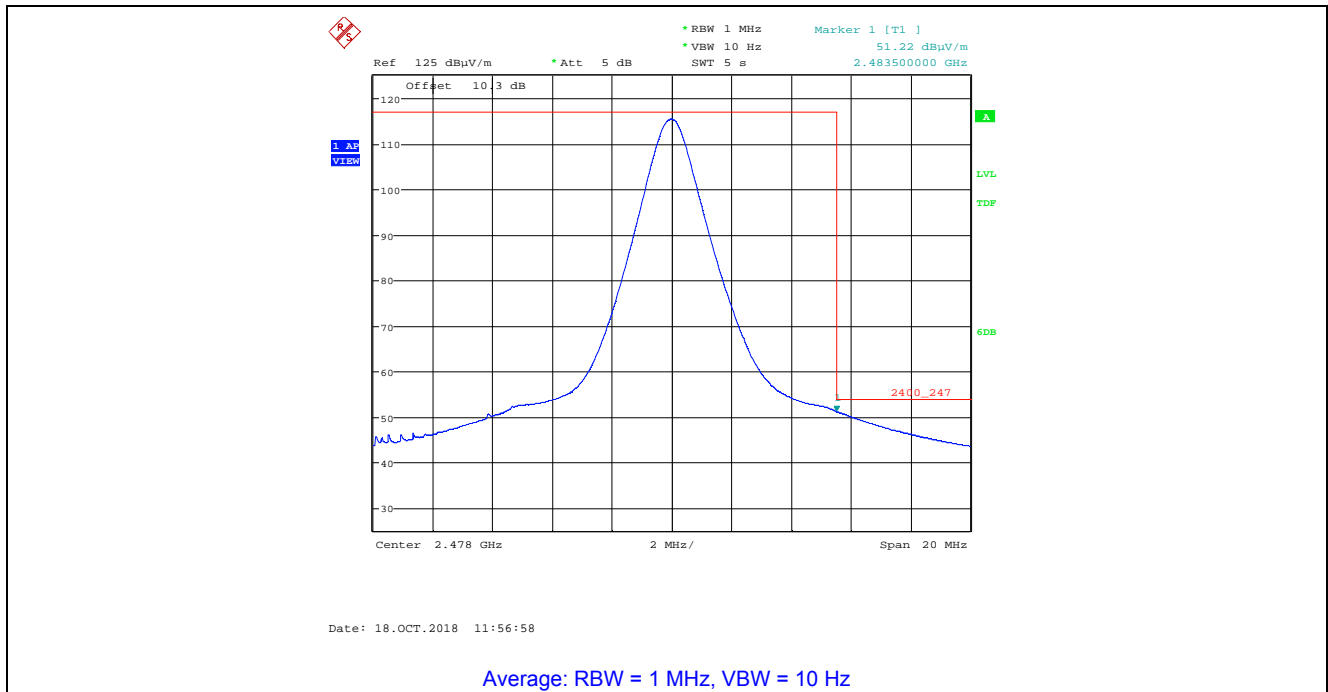

Plot 5.4.4.2.9. Band-Edge Radiated Emissions, Higher Band-edge
 Rx Antenna in Vertical Polarization, GFSK Modulation, 1 Mbps, Power Setting 200, Ch 39, 2480 MHz
 Maximum 20 dB Duty Cycle Correction Factor Applied to 68.66 dB μ V/m Peak, Average is 48.66 dB μ V/m

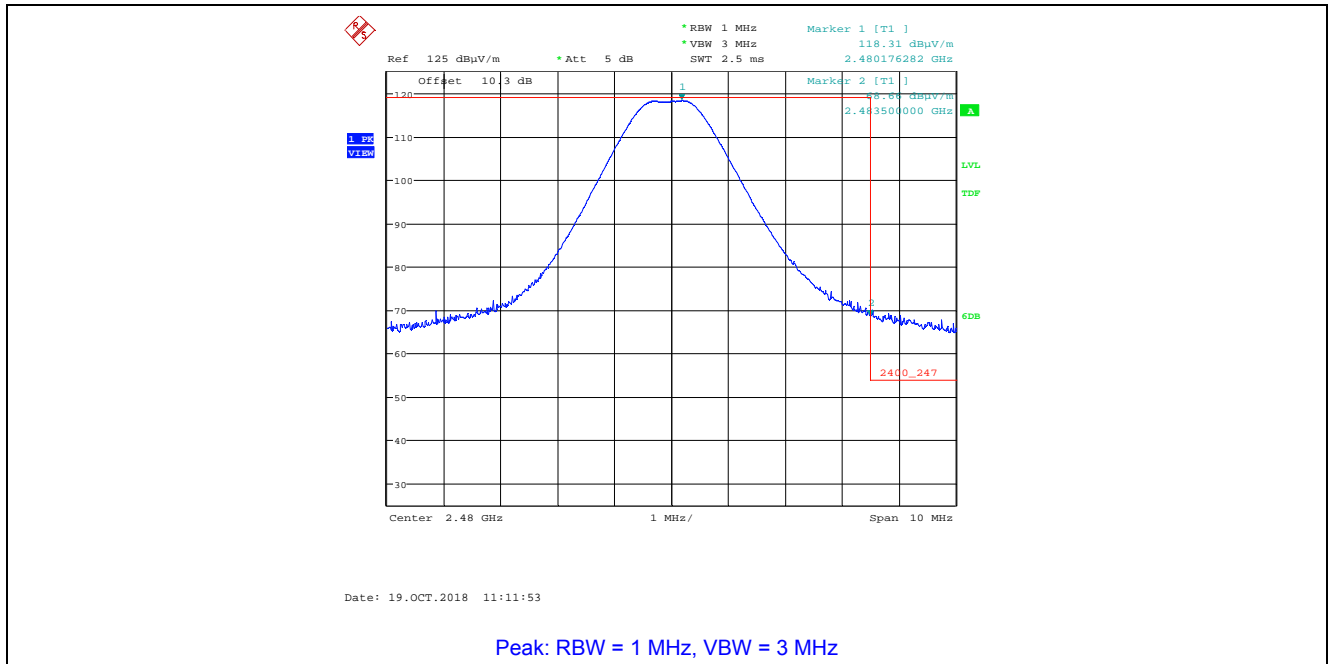

Plot 5.4.4.2.10. Band-Edge Radiated Emissions, Higher Band-edge
 Rx Antenna in Horizontal Polarization, GFSK Modulation, 1 Mbps, Power Setting 200, Ch 39, 2480 MHz
 Applied Maximum 20 dB Duty Cycle Correction Factor Applied to 72.09 dB μ V/m Peak, Average is 52.09 dB μ V/m

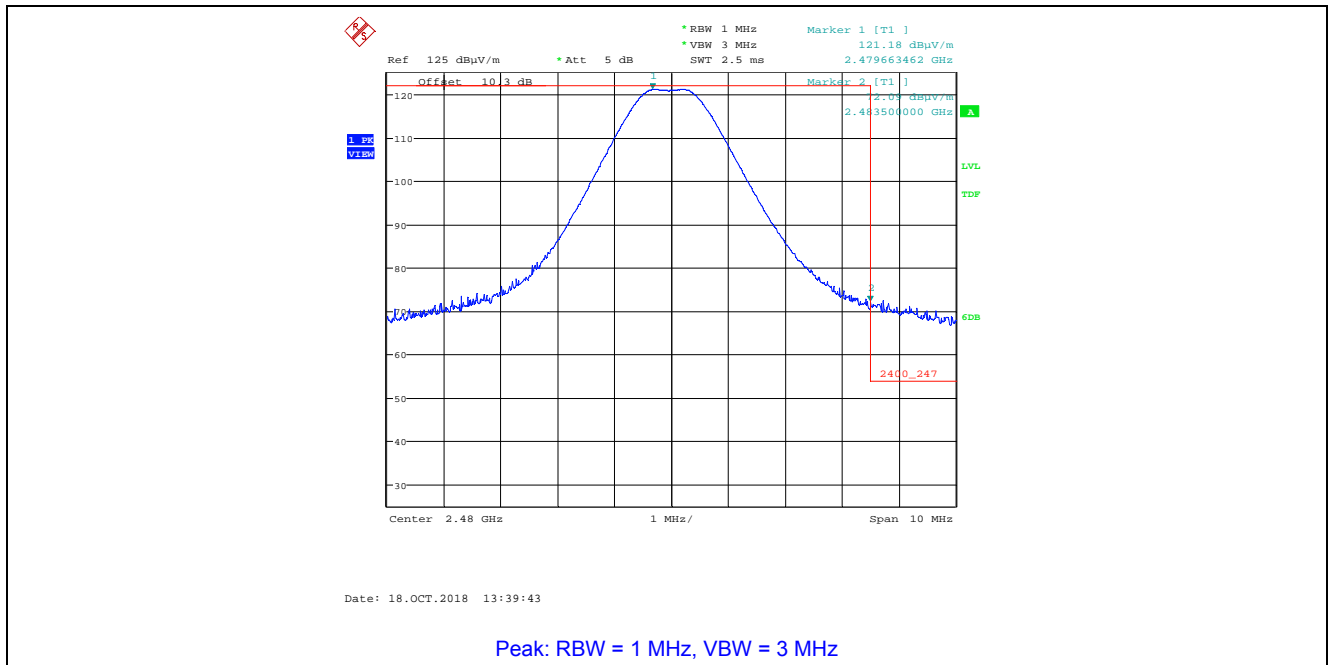

Plot 5.4.4.2.11. Band-Edge Radiated Emissions, Lower Band-edge
Rx Antenna in Vertical Polarization, GFSK Modulation, 2 Mbps, Power Setting 200, Ch 00, 2404 MHz

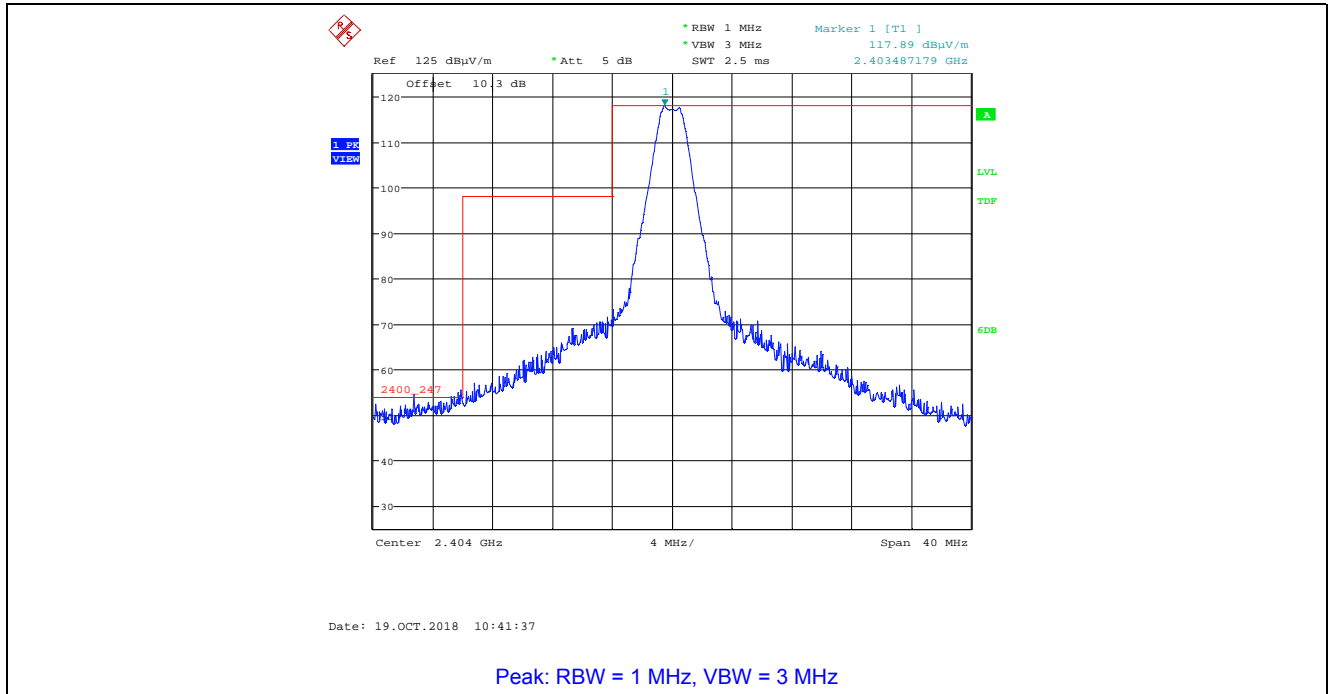

Plot 5.4.4.2.12. Band-Edge Radiated Emissions, Lower Band-edge
Rx Antenna in Vertical Polarization, GFSK Modulation, 2 Mbps, Power Setting 200, Ch 00, 2404 MHz

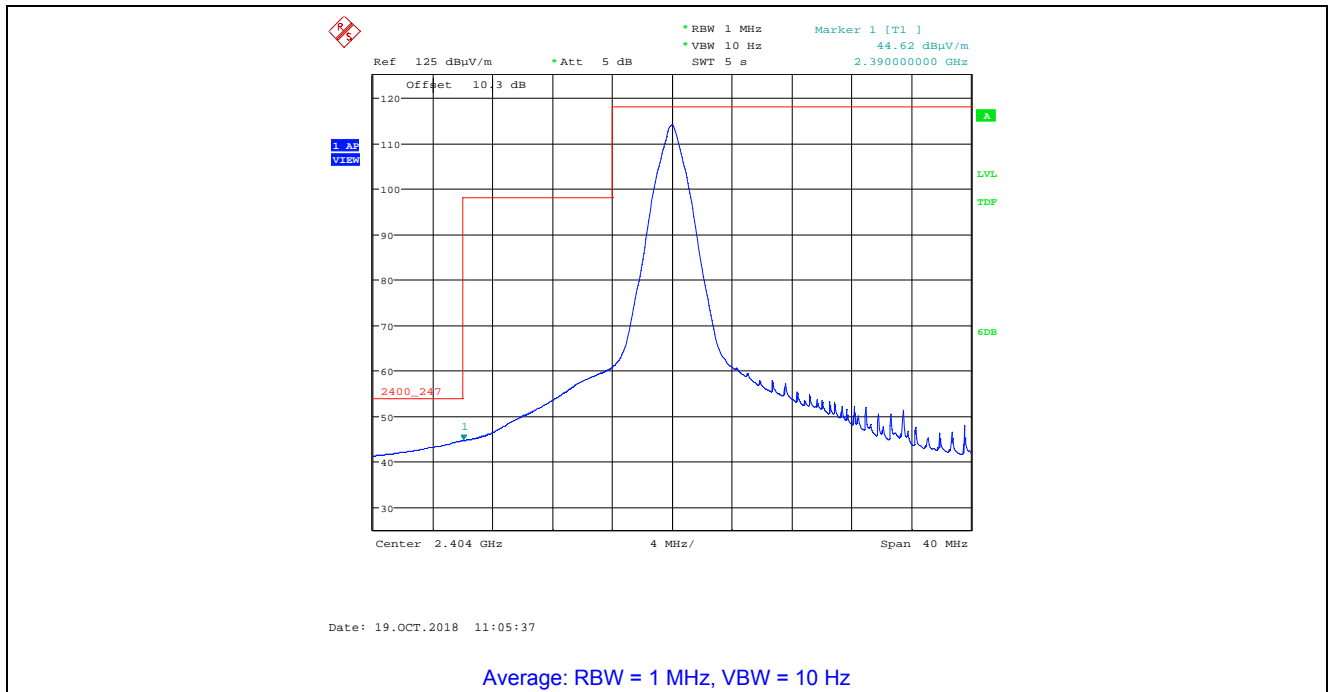

Plot 5.4.4.2.13. Band-Edge Radiated Emissions, Lower Band-edge
 Rx Antenna in Horizontal Polarization, GFSK Modulation, 2 Mbps, Power Setting 200, Ch 00, 2404 MHz

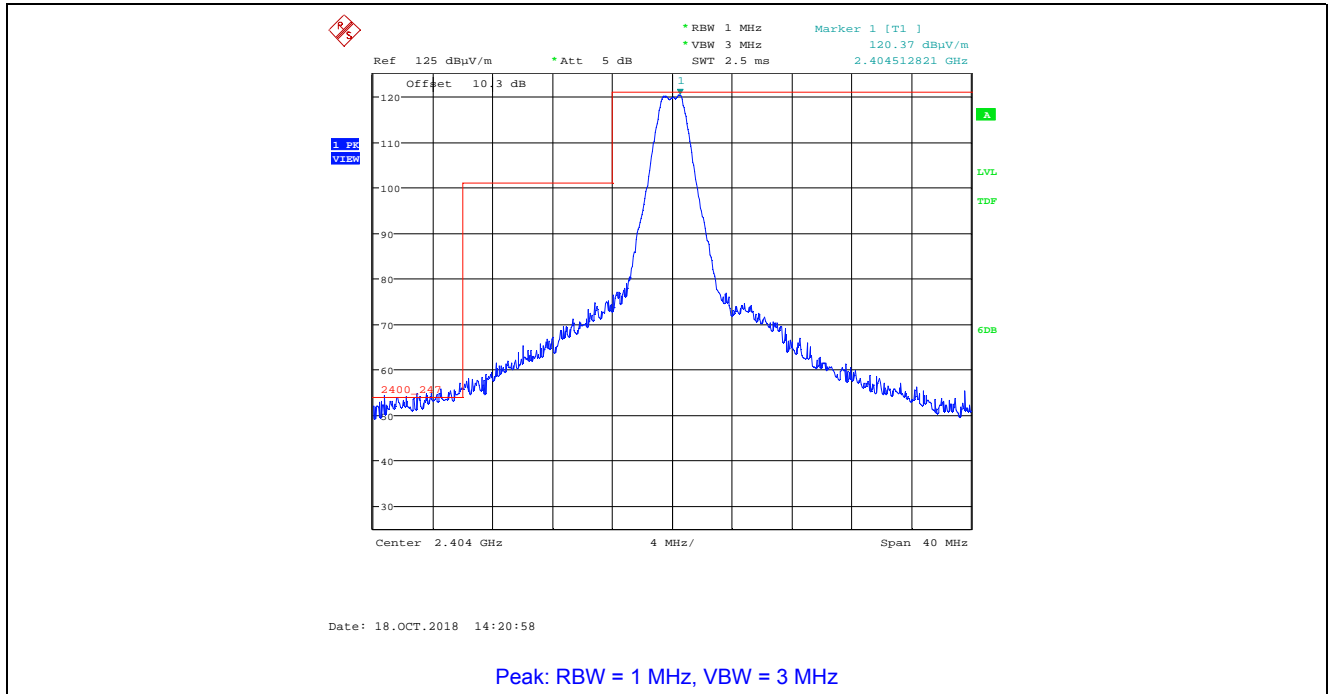

Plot 5.4.4.2.14. Band-Edge Radiated Emissions, Lower Band-edge
 Rx Antenna in Horizontal Polarization, GFSK Modulation, 2 Mbps, Power Setting 200, Ch 00, 2404 MHz

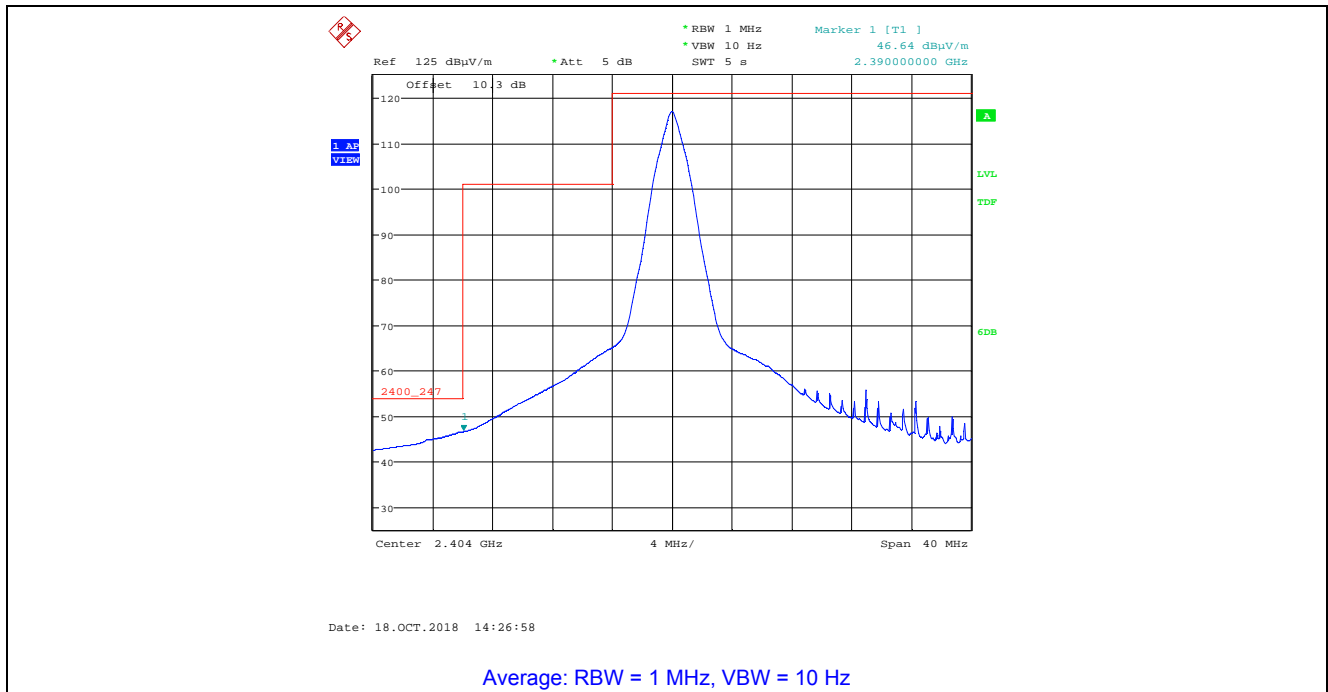

Plot 5.4.4.2.15. Band-Edge Radiated Emissions, Higher Band-edge
 Rx Antenna in Vertical Polarization, GFSK Modulation, 2 Mbps, Power Setting 200, Ch 35, 2476 MHz

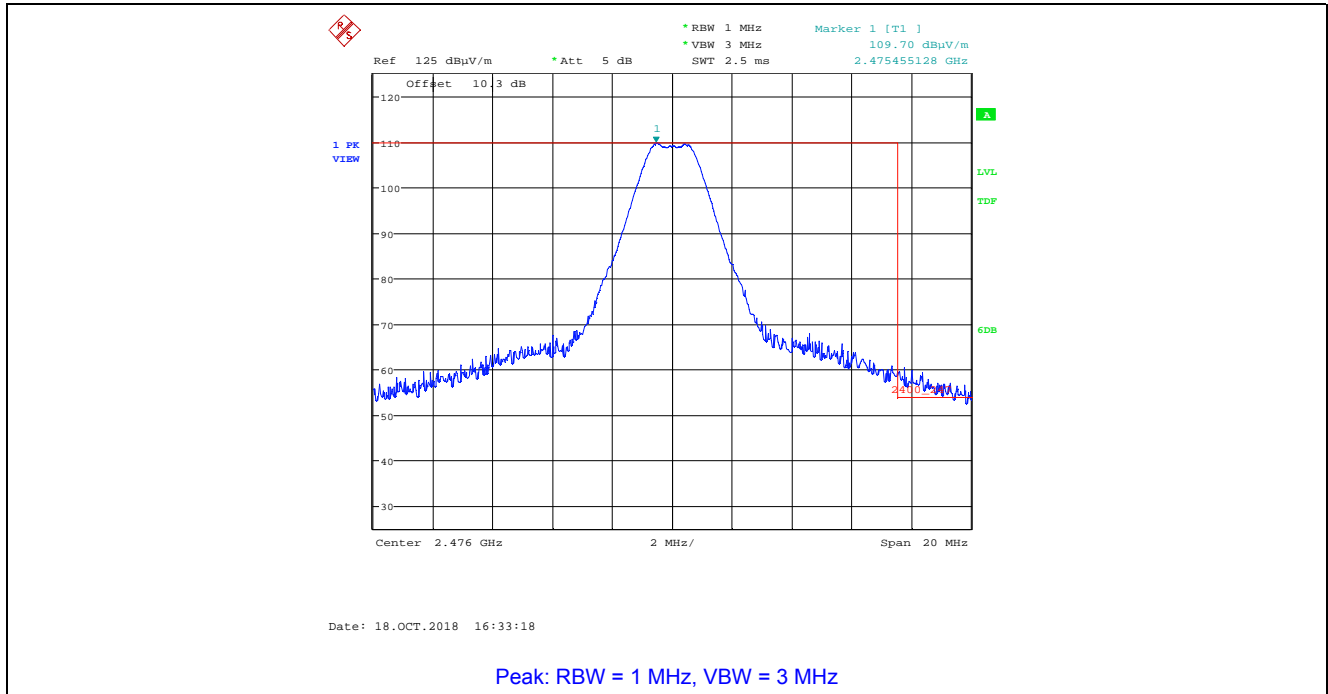

Plot 5.4.4.2.16. Band-Edge Radiated Emissions, Higher Band-edge
 Rx Antenna in Vertical Polarization, GFSK Modulation, 2 Mbps, Power Setting 200, Ch 35, 2476 MHz

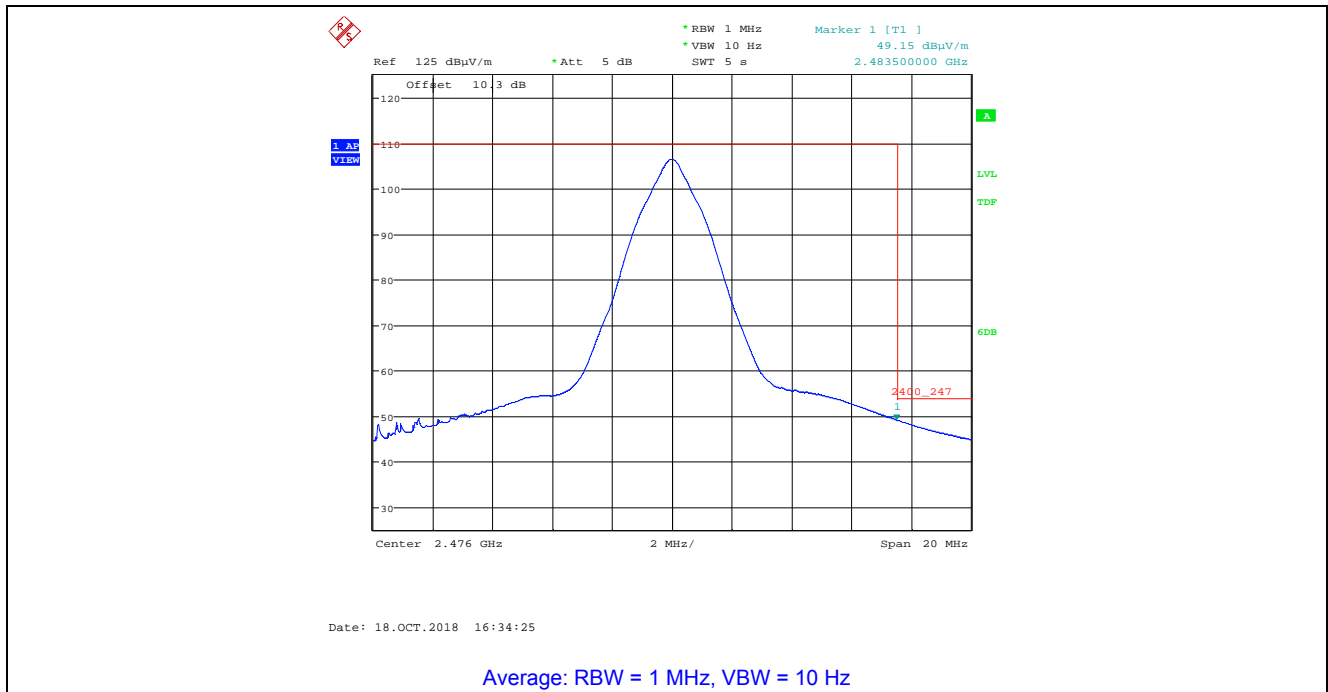

Plot 5.4.4.2.17. Band-Edge Radiated Emissions, Higher Band-edge
Rx Antenna in Horizontal Polarization, GFSK Modulation, 2 Mbps, Power Setting 200, Ch 35, 2476 MHz

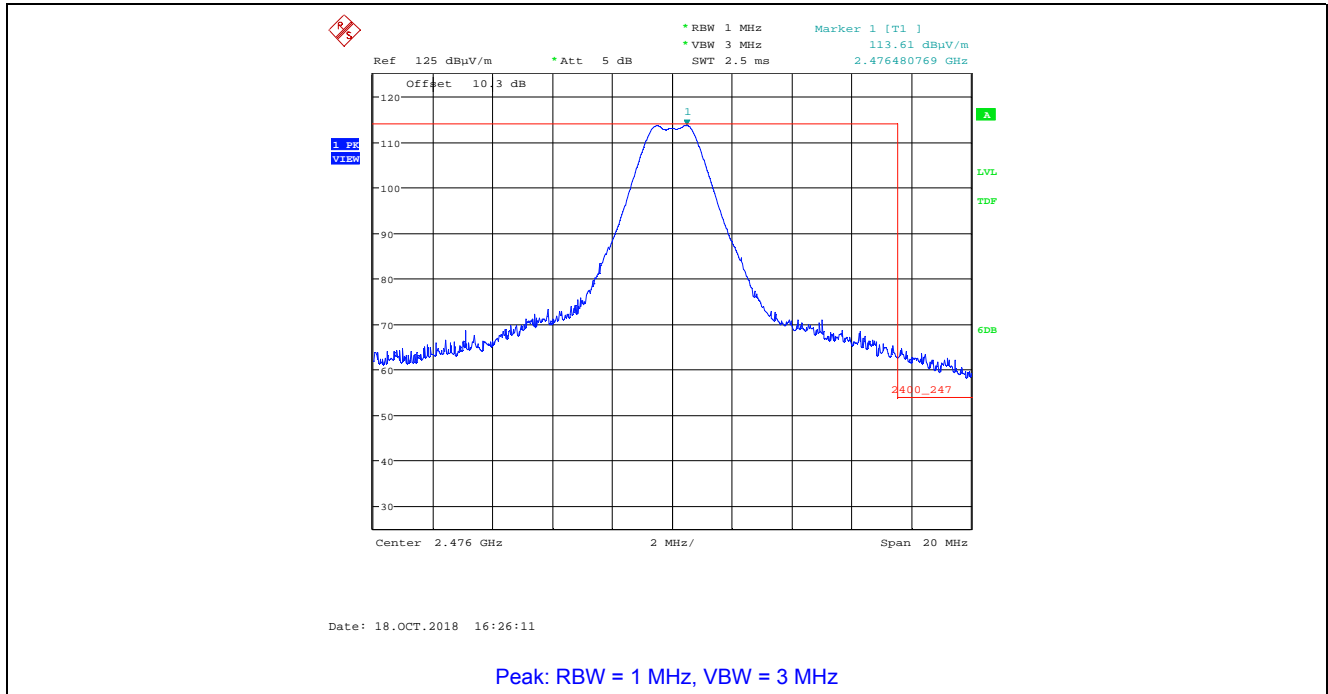

Plot 5.4.4.2.18. Band-Edge Radiated Emissions, Higher Band-edge
Rx Antenna in Horizontal Polarization, GFSK Modulation, 2 Mbps, Power Setting 200, Ch 35, 2476 MHz

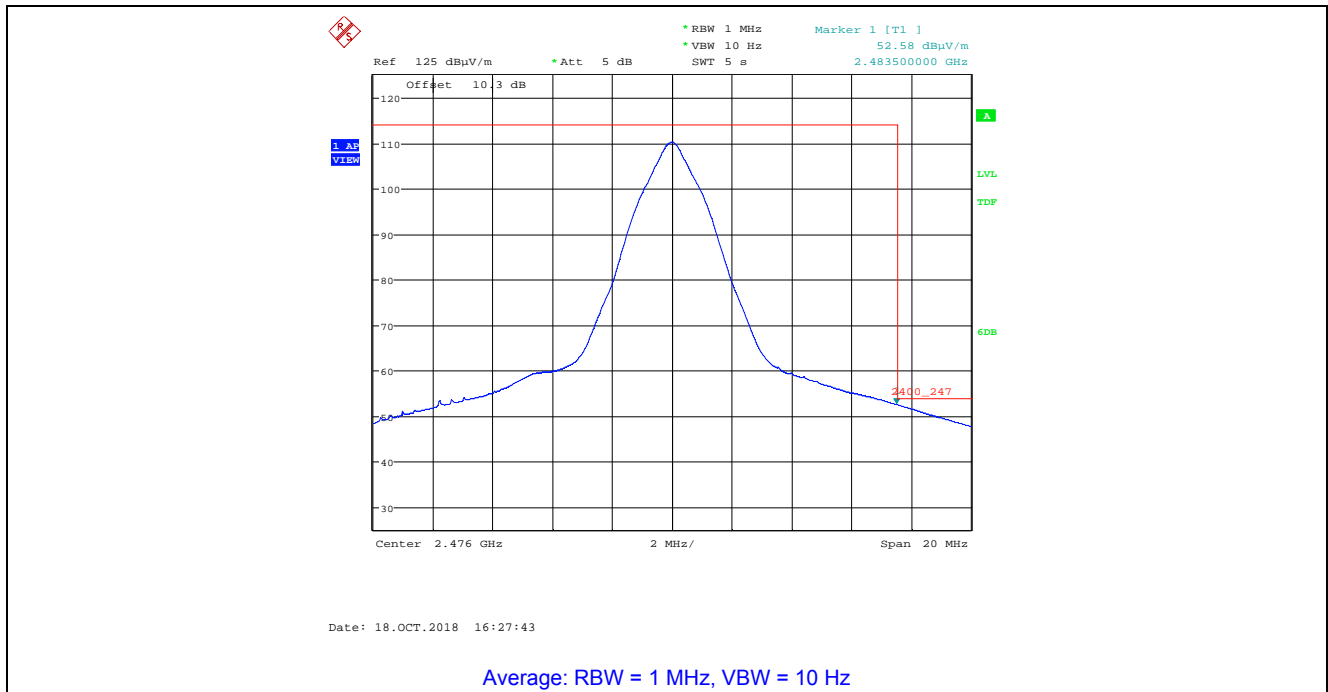

Plot 5.4.4.2.19. Band-Edge Radiated Emissions, Higher Band-edge
 Rx Antenna in Vertical Polarization, GFSK Modulation, 2 Mbps, Power Setting 200, Ch 36, 2478 MHz

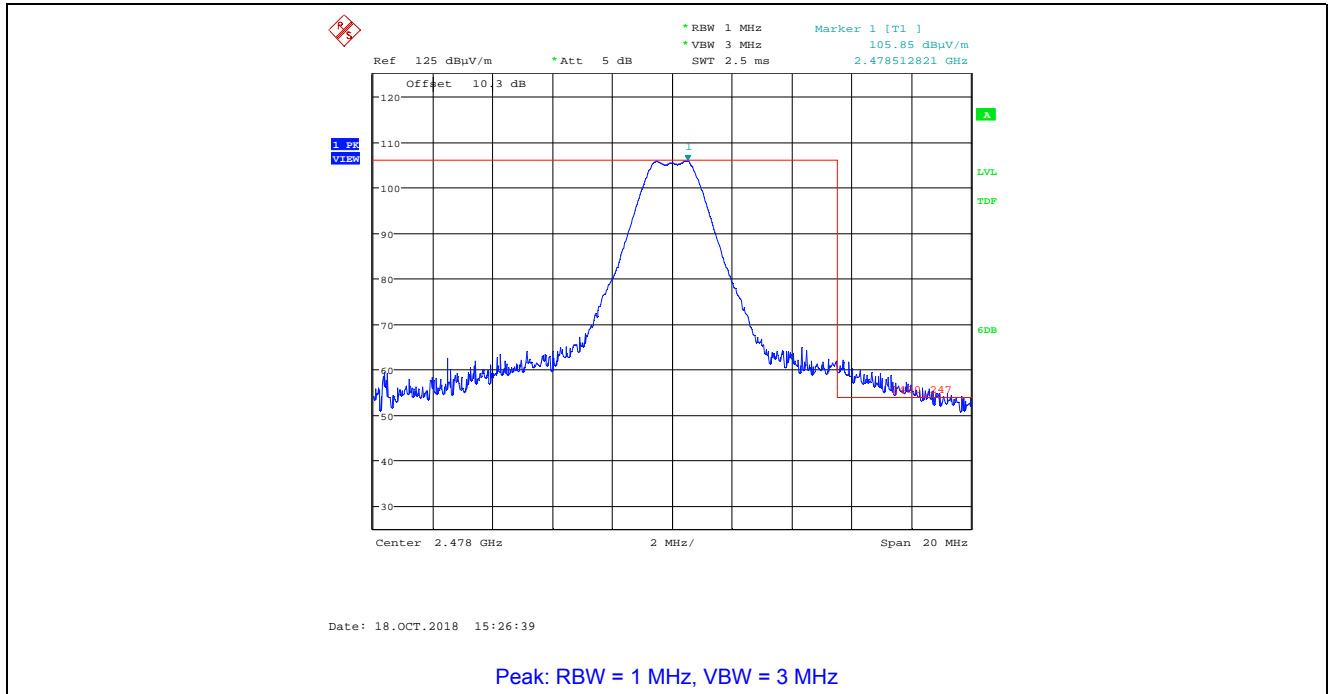

Plot 5.4.4.2.20. Band-Edge Radiated Emissions, Higher Band-edge
 Rx Antenna in Vertical Polarization, GFSK Modulation, 2 Mbps, Power Setting 200, Ch 36, 2478 MHz

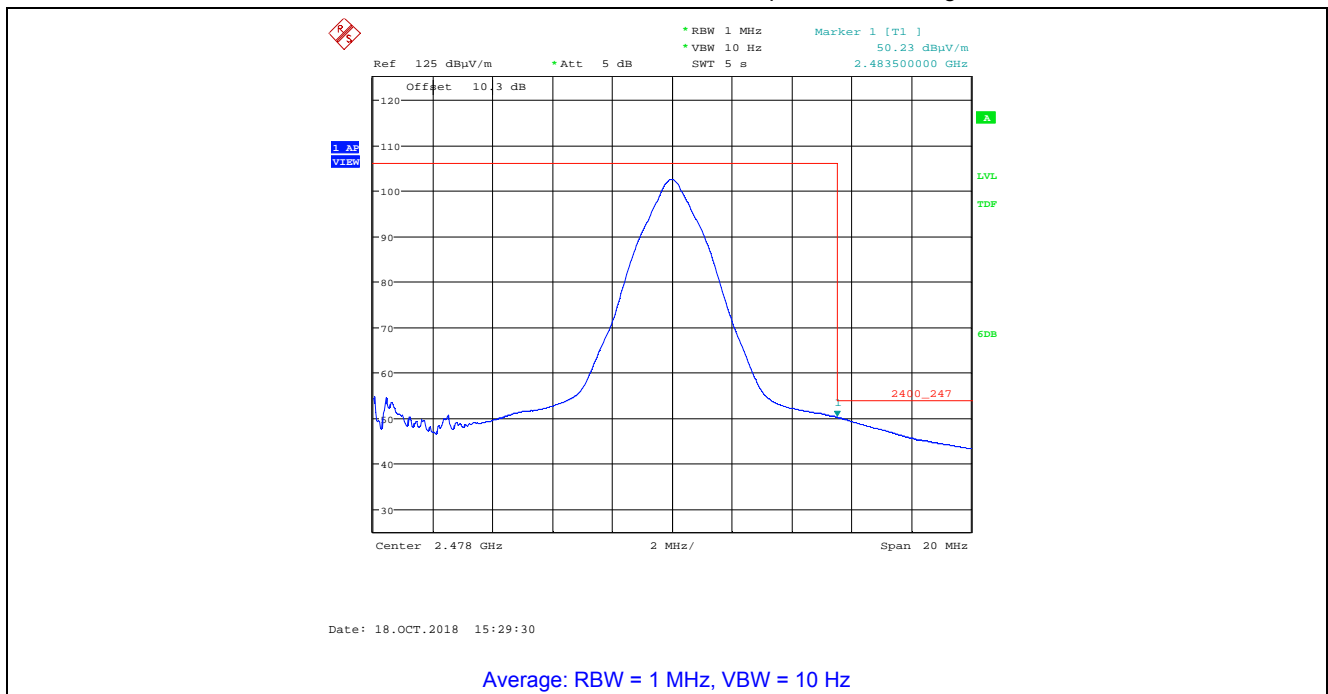

Plot 5.4.4.2.21. Band-Edge Radiated Emissions, Higher Band-edge
 Rx Antenna in Horizontal Polarization, GFSK Modulation, 2 Mbps, Power Setting 200, Ch 36, 2478 MHz

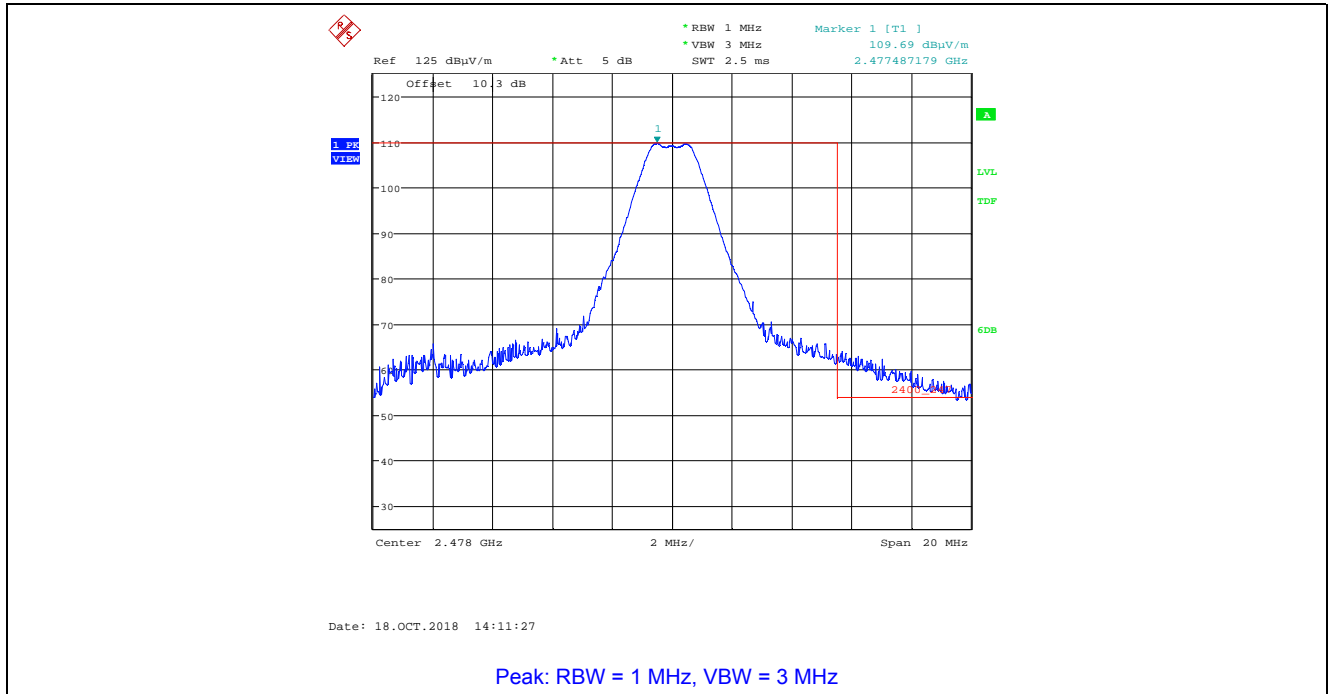

Plot 5.4.4.2.22. Band-Edge Radiated Emissions, Higher Band-edge
 Rx Antenna in Horizontal Polarization, GFSK Modulation, 2 Mbps, Power Setting 200, Ch 36, 2478 MHz

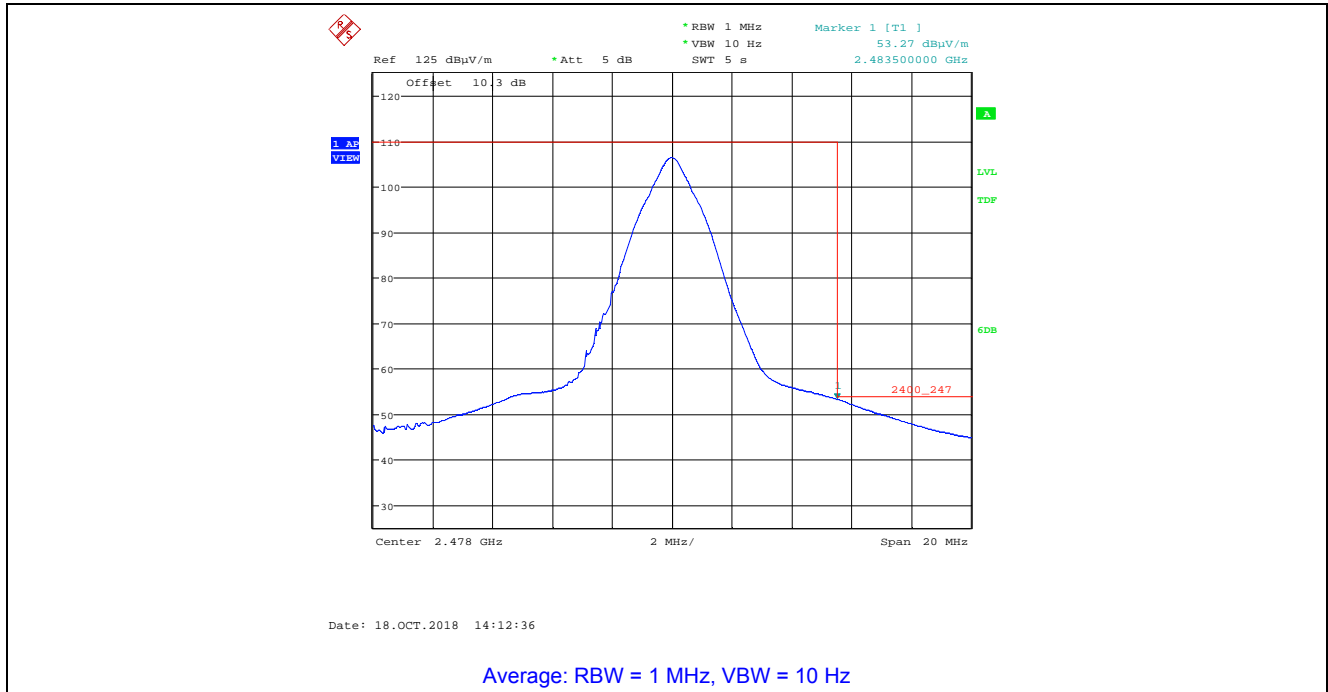

5.5. POWER SPECTRAL DENSITY [§ 15.247(e)]

5.5.1. Limit(s)

For digitally modulated systems, the power spectral density conducted from the intentional radiator to the antenna shall not be greater than 8 dBm in any 3 kHz band during any time interval of continuous transmission.

5.5.2. Method of Measurements

FCC KDB 558074 D01 15.247 Meas Guidance v05, Section 8.4 / ANSI C63.10 Subclause 11.10.2 Method PKPSD (peak PSD).

5.5.3. Test Arrangement

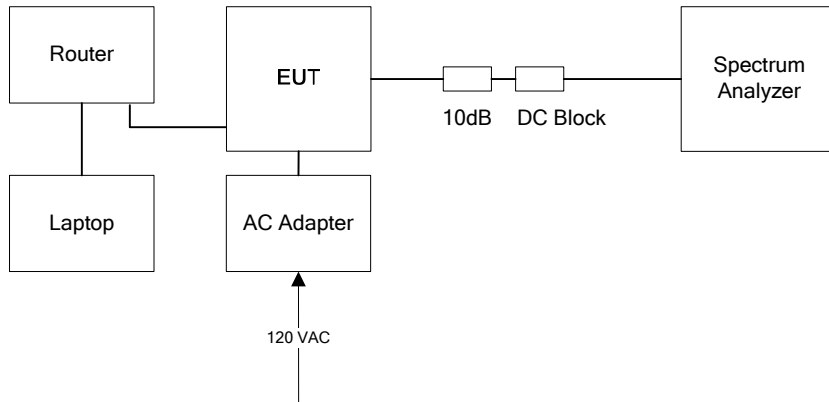

5.5.4. Test Data

Modulation	Data Rate (Mbps)	Power Setting	Channel	Frequency (MHz)	PSD (dBm)	Max. Limit (dBm)	Margin (dBm)
GFSK	1	200	37	2402	2.58	8	-5.42
		200	17	2440	2.59	8	-5.41
		200	39	2480	3.43	8	-4.57
	2	200	0	2404	0.09	8	-7.91
		200	17	2440	0.07	8	-7.93
		200	36	2478	-0.11	8	-8.11

Plot 5.5.4.1. Power Spectral Density, GFSK Modulation, 1 Mbps, Power Setting 200, Channel 37, 2402 MHz

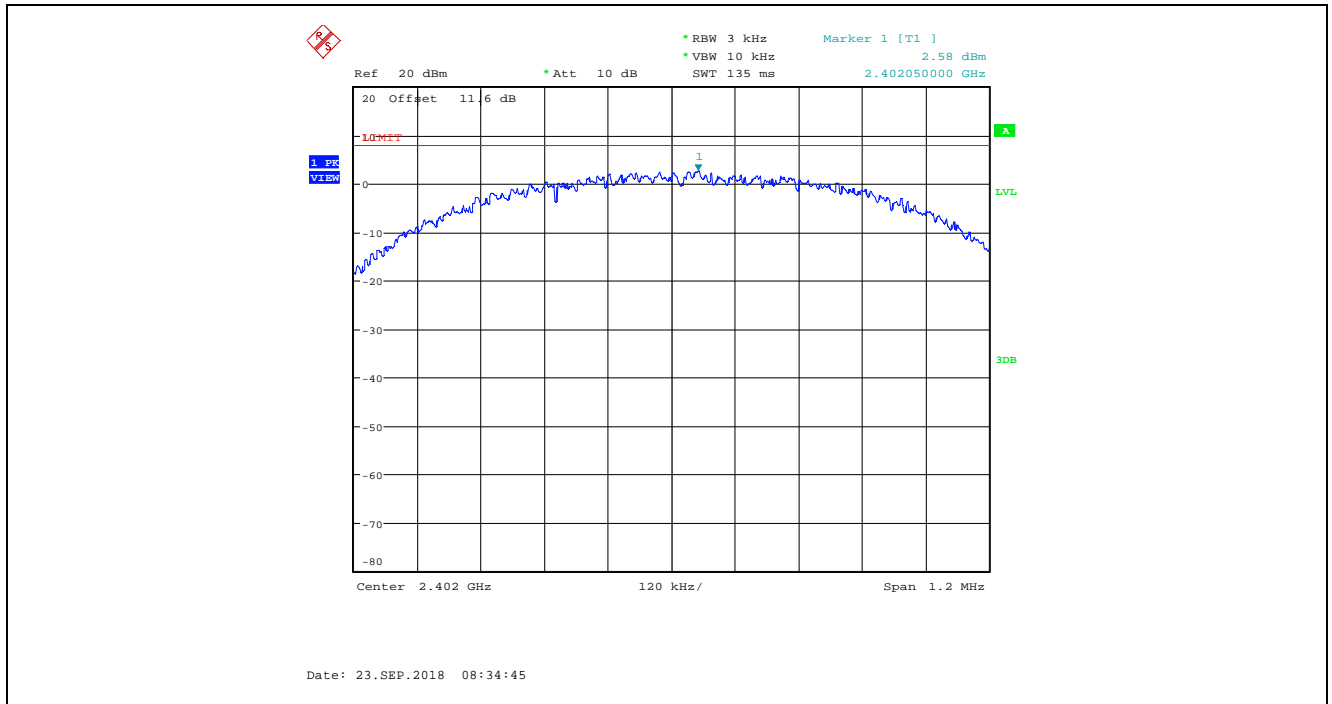

Plot 5.5.4.2. Power Spectral Density, GFSK Modulation, 1 Mbps, Power Setting 200, Channel 17, 2440 MHz

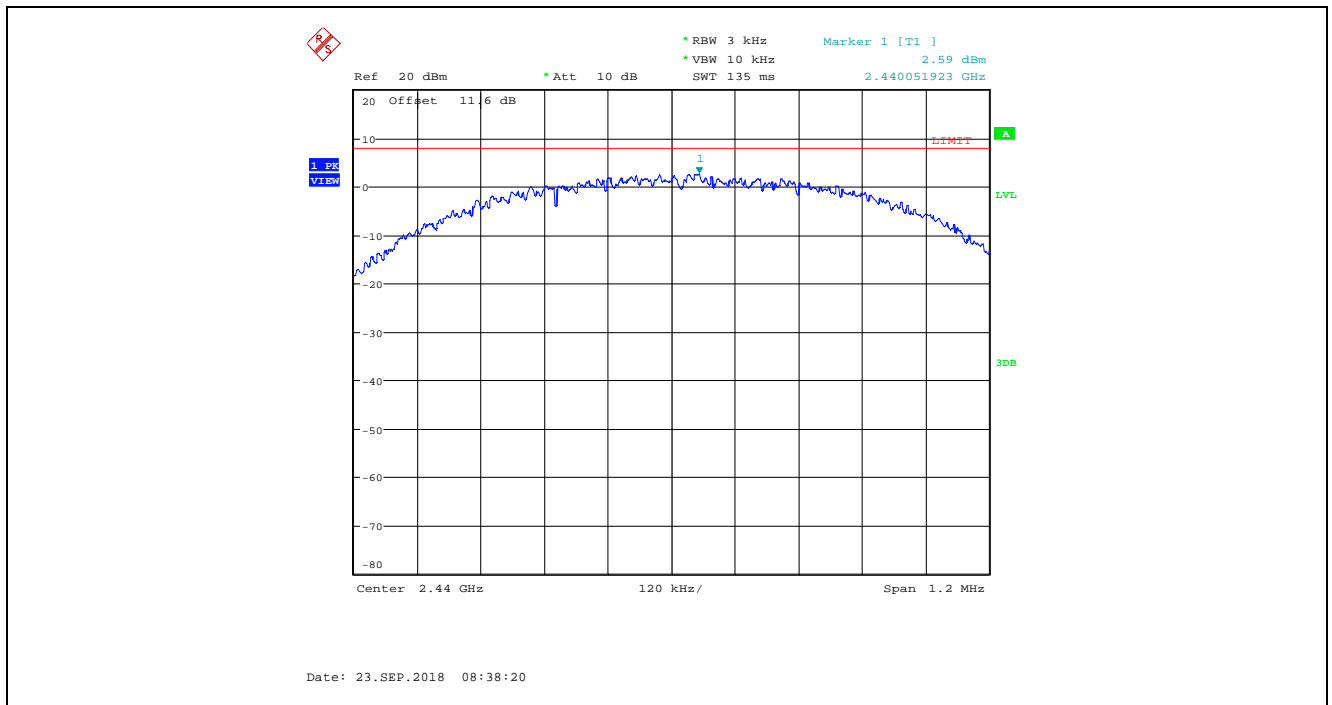

Plot 5.5.4.3. Power Spectral Density, GFSK Modulation, 1 Mbps, Power Setting 200, Channel 39, 2480 MHz

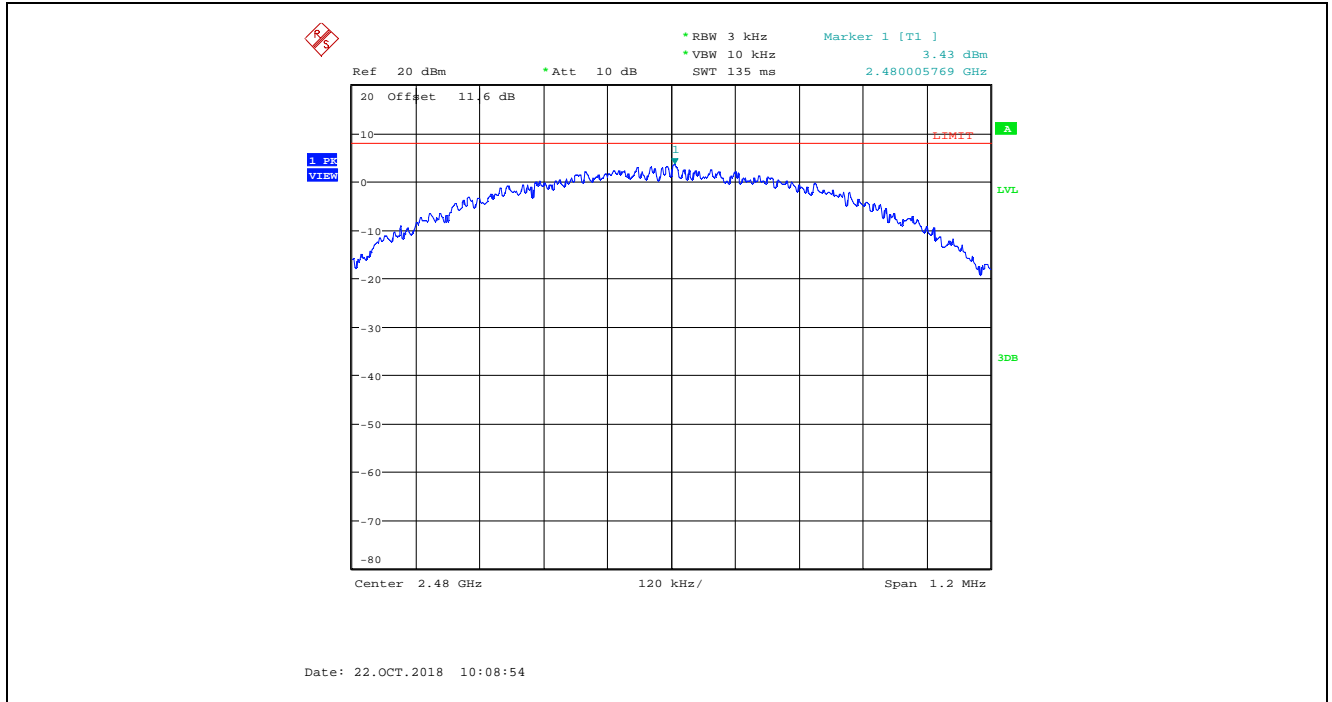

Plot 5.5.4.4. Power Spectral Density, GFSK Modulation, 2 Mbps, Power Setting 200, Channel 00, 2404 MHz

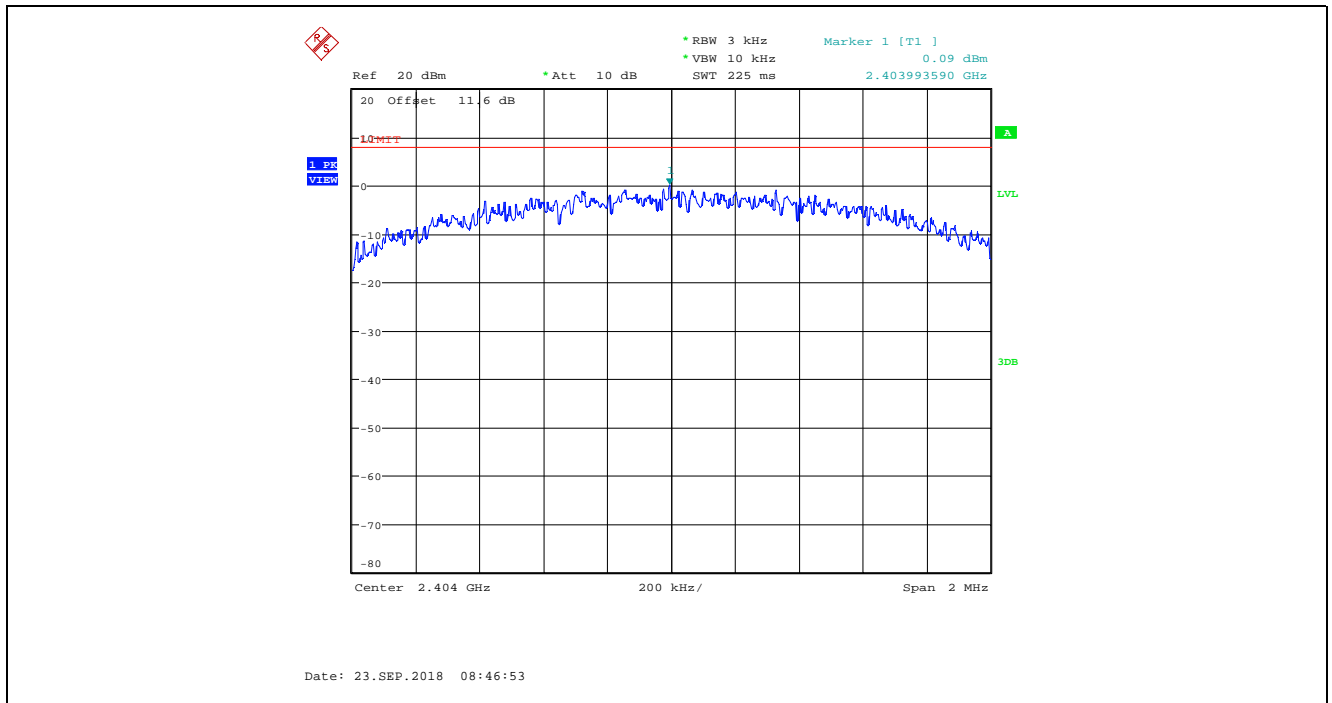

Plot 5.5.4.5. Power Spectral Density, GFSK Modulation, 2 Mbps, Power Setting 200, Channel 17, 2440 MHz

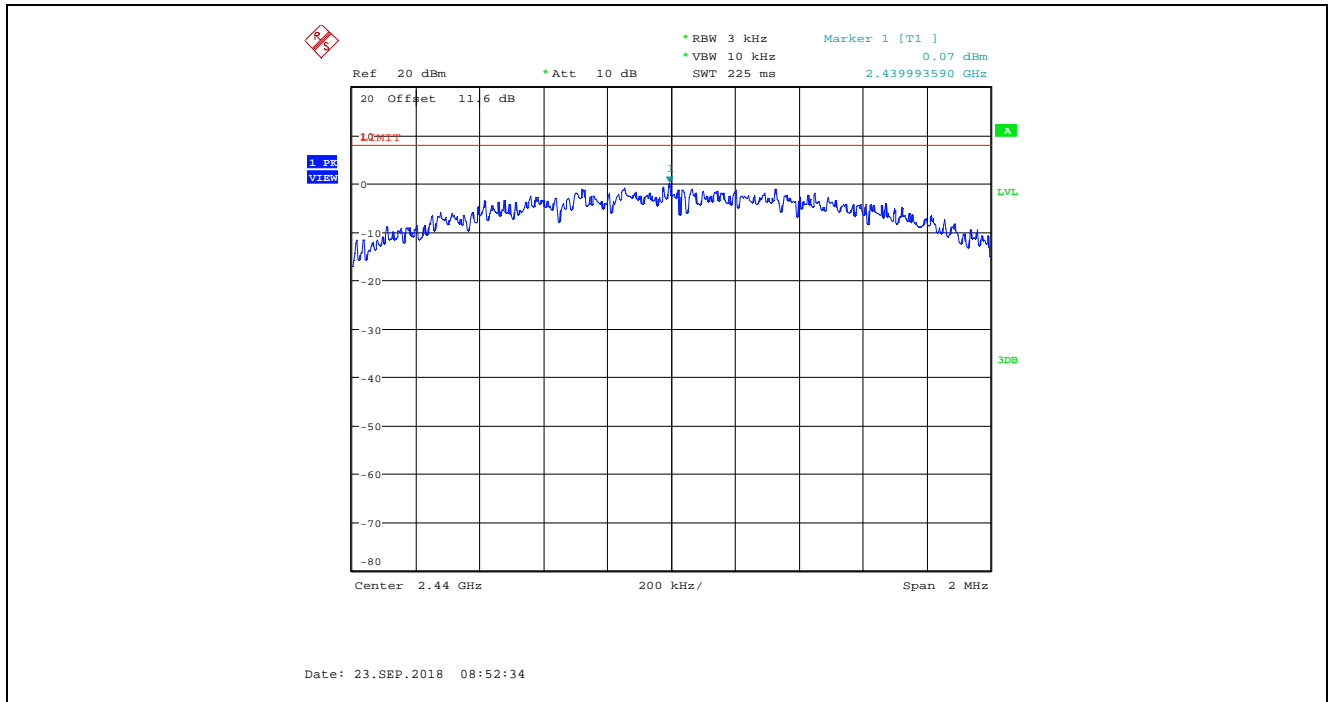

Plot 5.5.4.6. Power Spectral Density, GFSK Modulation, 2 Mbps, Power Setting 200, Channel 36, 2478 MHz

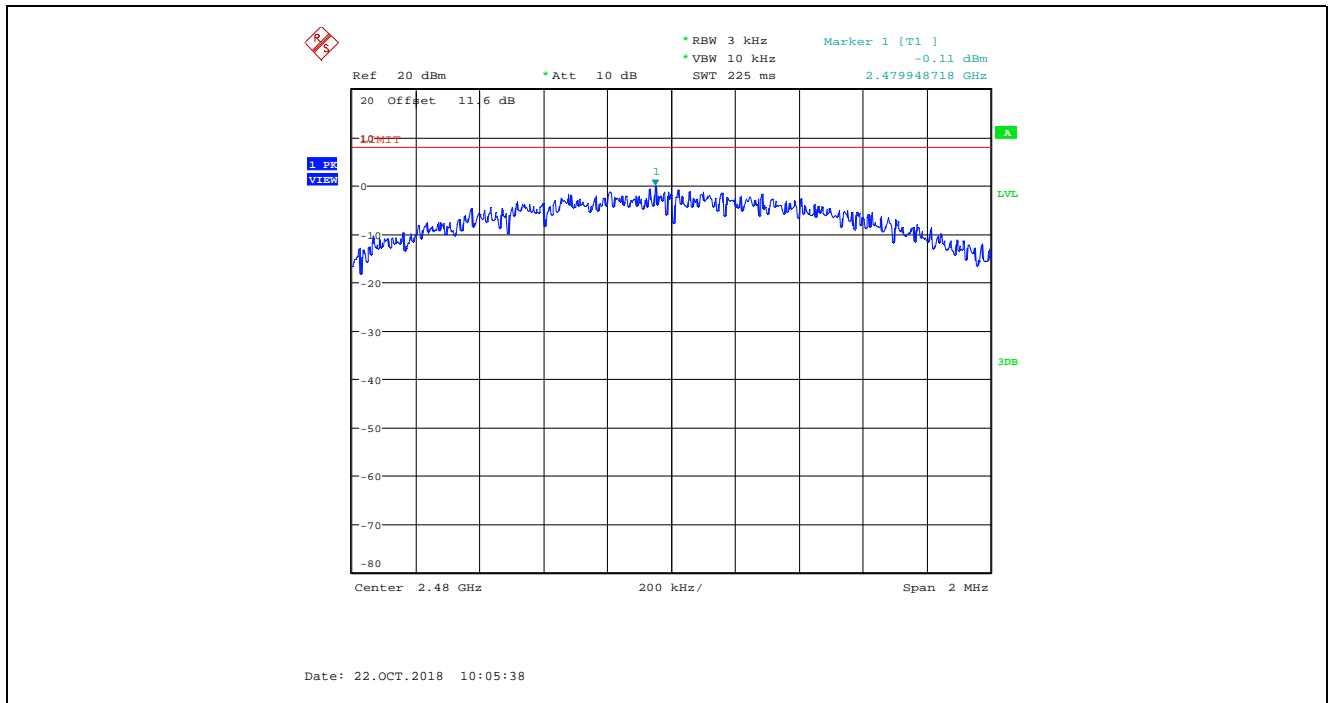

5.6. RF EXPOSURE REQUIRMENTS [§§ 15.247(i), 1.1310 & 2.1091]

5.6.1. Limits

§ 1.1310: The criteria listed in the following table shall be used to evaluate the environmental impact of human exposure to radio-frequency (RF) radiation as specified in 1.1307(b).

Limits for Maximum Permissible Exposure (MPE)

Frequency range (MHz)	Electric field strength (V/m)	Magnetic field strength (A/m)	Power density (mW/cm ²)	Averaging time (minutes)
(A) Limits for Occupational/Controlled Exposures				
0.3-3.0	614	1.63	*(100)	6
3.0-30	1842/f	4.89/f	*(900/f ²)	6
30-300	61.4	0.163	1.0	6
300-1500			f/300	6
1500-100,000			5	6
(B) Limits for General Population/Uncontrolled Exposure				
0.3-1.34	614	1.63	*(100)	30
1.34-30	824/f	2.19/f	*(180/f ²)	30
30-300	27.5	0.073	0.2	30
300-1500			f/1500	30
1500-100,000			1.0	30

f = frequency in MHz

* = Plane-wave equivalent power density

Note 1: Occupational/controlled limits apply in situations in which persons are exposed as a consequence of their employment provided those persons are fully aware of the potential for exposure and can exercise control over their exposure. Limits for occupational/controlled exposure also apply in situations when an individual is transient through a location where occupational/controlled limits apply provided he or she is made aware of the potential for exposure.

Note 2: General population/uncontrolled exposures apply in situations in which the general public may be exposed, or in which persons that are exposed as a consequence of their employment may not be fully aware of the potential for exposure or can not exercise control over their exposure.

5.6.2. Method of Measurements

Calculation Method of Power Density/RF Safety Distance:

$$S = \frac{PG}{4\pi \cdot r^2} = \frac{EIRP}{4\pi \cdot r^2}$$

Where, P: power input to the antenna in mW
 EIRP: Equivalent (effective) isotropic radiated power.
 S: power density mW/cm²
 G: numeric gain of antenna relative to isotropic radiator
 r: distance to centre of radiation in cm

5.6.3. RF Evaluation

Remark(s):

The EUT contained ZigBee/ BLE and WiFi radio modules with the following operating conditions:

- BLE and WiFi may transmit at the same time
- Zigbee and WiFi may transmit at the same time
- BLE and Zigbee will NOT transmit at the same time

Pursuant to KDB 447498 D01 General RF Exposure Guidance v06, Section 7.2:

Simultaneous transmission MPE test exclusion applies when the sum of the MPE ratios for all simultaneously transmitting antennas incorporated in a host device is ≤ 1.0, according to calculated/estimated, numerically modeled, or measured field strengths or power density.

The sum of the MPE ratios for all simultaneously transmitting antennas incorporated in the EUT is ≤ 1.0 as calculated in the following table.

EUT Co-located MPE for BLE/Zigbee with WiFi Radio								
Transmitter	Frequency Band (MHz)	Frequency	Max. EIRP (dBm)	Max. EIRP (mW)	Evaluation Distance (cm)	Power Density (mW/cm ²)	Power Density Limit (mW/cm ²)	Power Density MPE Ratio
BLE	2402-2480	2402	25.53	357.273	20	0.071	1.0	0.071
Zigbee	2405-2480	2405	25.47	352.371	20	0.070	1.0	0.070
802.11b	2412-2462	2412	28.36	685.488	20	0.136	1.0	0.136
802.11g	2412-2462	2412	28.83	763.836	20	0.152	1.0	0.152
802.11n	2412-2462	2412	28.65	732.825	20	0.146	1.0	0.146
Worst Case Combination (BLE with WiFi 802.11g mode) :								0.223

EXHIBIT 6. TEST EQUIPMENT LIST

Test Instruments	Manufacturer	Model No.	Serial No.	Frequency Range	Cal. Due Date
Spectrum Analyzer	Agilent	E7405A	US39440181	9 kHz–26.5 GHz	04 Feb 2019
Attenuator	Pasternack	PE7010-20	ATT13	DC–2 GHz	21 Mar 2019
LISN	EMCO	3825/2R	1165	10 kHz–30 MHz	03 Nov 2018
Spectrum Analyzer	Rohde & Schwarz	FSU26	200946	20Hz–26.5 GHz	25 Jul 2020
DC Block	Hewlett Packard	11742A	12460	0.045 – 26.5 GHz	See Note 1
Attenuator	Hewlett Packard	8493C	0465	DC - 26.5 GHz	See Note 1
EMI Receiver	Rohde & Schwarz	ESU40	100037	20Hz–40 GHz	04 May 2019
RF Amplifier	Com-Power	PAM-0118A	551052	0.5 – 18 GHz	26 Jun 2019
RF Amplifier	Hewlett Packard	84498	3008A00769	1 – 26.5 GHz	01 Oct 2019
Biconilog	EMCO	3142C	00026873	26-3000 MHz	27 Apr 2020
Horn Antenna	EMCO	3155	5061	1 – 18 GHz	30 Apr 2020
Horn Antenna	ETS-Lindgren	3160-09	001183858	18 – 26.5 GHz	11 Oct 2019
High Pass Filter	K & L	11SH10-4000/T12000	4	Cut off 2.4 GHz	See Note 1
Band Reject Filter	Micro-Tronics	BRM50701	105	Cut off 2.4-2.483 GHz	See Note 1
Attenuator	Pasternack	PE7024-10	4	DC–26.5 GHz	See Note 1

Note 1: Internal Verification/Calibration check

EXHIBIT 7. MEASUREMENT UNCERTAINTY

The measurement uncertainties stated were calculated in accordance with the requirements of CISPR 16-4-2 @ IEC:2003 and JCGM 100:2008 (GUM 1995) – Guide to the Expression of Uncertainty in Measurement.

7.1. LINE CONDUCTED EMISSION MEASUREMENT UNCERTAINTY

	Line Conducted Emission Measurement Uncertainty (9 kHz – 30 MHz):	Measured	Limit
u_c	Combined standard uncertainty: $u_c(y) = \sqrt{\sum_{i=1}^m u_i^2(y)}$	± 1.44	± 1.8
U	Expanded uncertainty U: $U = 2u_c(y)$	± 2.89	± 3.6

7.2. RADIATED EMISSION MEASUREMENT UNCERTAINTY

	Radiated Emission Measurement Uncertainty @ 3m, Horizontal (30-1000 MHz):	Measured (dB)	Limit (dB)
u_c	Combined standard uncertainty: $u_c(y) = \sqrt{\sum_{i=1}^m u_i^2(y)}$	± 2.39	± 2.6
U	Expanded uncertainty U: $U = 2u_c(y)$	± 4.79	± 5.2

	Radiated Emission Measurement Uncertainty @ 3m, Vertical (30-1000 MHz):	Measured (dB)	Limit (dB)
u_c	Combined standard uncertainty: $u_c(y) = \sqrt{\sum_{i=1}^m u_i^2(y)}$	± 2.39	± 2.6
U	Expanded uncertainty U: $U = 2u_c(y)$	± 4.78	± 5.2

	Radiated Emission Measurement Uncertainty @ 3 m, Horizontal & Vertical (1 – 18 GHz):	Measured (dB)	Limit (dB)
u_c	Combined standard uncertainty: $u_c(y) = \sqrt{\sum_{i=1}^m u_i^2(y)}$	± 1.87	Under consideration
U	Expanded uncertainty U: $U = 2u_c(y)$	± 3.75	Under consideration