

ENGINEERING TEST REPORT

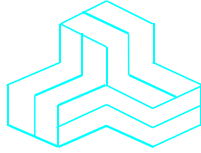

ZigBee/Thread/BLE Module
Model(s): CSB04PA10-CHP, CSB04PA10-RFC, CSB04PA11-CHP, CSB04PA11-RFC
FCC ID: XFF-CSB04PA1X

Applicant:

MMB Research Inc.
243 College St, Suite 500
Toronto, ON M5T 1R5
Canada

In Accordance With

Federal Communications Commission (FCC)
Part 15, Subpart C, Section 15.247
Digital Modulation Systems (DTS) Operating in 2400 – 2483.5 MHz Band

UltraTech's File No.: 18MMBN001_FCC15C247Z

This Test report is Issued under the Authority of
Tri M. Luu
Vice President of Engineering
UltraTech Group of Labs

Date: July 19, 2018

Report Prepared by: Dan Huynh

Tested by: Hung Trinh

Issued Date: July 19, 2018

Test Dates: May 11, 15 & 22, 2018
June 28, 2018

- *The results in this Test Report apply only to the sample(s) tested, and the sample tested is randomly selected.*
- *This report must not be used by the client to claim product endorsement by any agency of the US Government.*
- *This test report shall not be reproduced, except in full, without a written approval from UltraTech*

UltraTech

3000 Bristol Circle, Oakville, Ontario, Canada L6H 6G4
Tel.: (905) 829-1570 Fax.: (905) 829-8050
Website: www.ultratech-labs.com, Email: vic@ultratech-labs.com, Email: tri@ultratech-labs.com



91038



1309



46390-2049



AT-1945



SL2-IN-E-1119R



CA2049

TABLE OF CONTENTS

EXHIBIT 1. INTRODUCTION..... 1
1.1. SCOPE 1
1.2. RELATED SUBMITTAL(S)/GRANT(S) 1
1.3. NORMATIVE REFERENCES 1
EXHIBIT 2. PERFORMANCE ASSESSMENT 2
2.1. CLIENT INFORMATION 2
2.2. EQUIPMENT UNDER TEST (EUT) INFORMATION 2
2.3. EUT'S TECHNICAL SPECIFICATIONS..... 3
2.4. ASSOCIATED ANTENNA DESCRIPTIONS 3
2.5. LIST OF EUT'S PORTS..... 3
2.6. ANCILLARY EQUIPMENT 3
EXHIBIT 3. EUT OPERATING CONDITIONS AND CONFIGURATIONS DURING TESTS 4
3.1. CLIMATE TEST CONDITIONS 4
3.2. OPERATIONAL TEST CONDITIONS & ARRANGEMENT FOR TESTS..... 4
EXHIBIT 4. SUMMARY OF TEST RESULTS..... 5
4.1. LOCATION OF TESTS 5
4.2. APPLICABILITY & SUMMARY OF EMC EMISSION TEST RESULTS 5
4.3. MODIFICATIONS INCORPORATED IN THE EUT FOR COMPLIANCE PURPOSES 5
EXHIBIT 5. TEST DATA 6
5.1. POWER LINE CONDUCTED EMISSIONS [§15.207(a)]..... 6
5.2. OCCUPIED BANDWIDTH [§ 15.247(a)(2)]..... 11
5.3. PEAK CONDUCTED OUTPUT POWER - DTS [§ 15.247(b)(3)] 14
5.4. TRANSMITTER SPURIOUS RADIATED EMISSIONS AT 3 METERS [§§ 15.247(d), 15.209 & 15.205] 21
5.5. POWER SPECTRAL DENSITY [§ 15.247(e)] 36
5.6. RF EXPOSURE REQUIRMENTS [§§ 15.247(i), 1.1310 & 2.1091]..... 39
EXHIBIT 6. TEST EQUIPMENT LIST 41
EXHIBIT 7. MEASUREMENT UNCERTAINTY 42
7.1. LINE CONDUCTED EMISSION MEASUREMENT UNCERTAINTY 42
7.2. RADIATED EMISSION MEASUREMENT UNCERTAINTY 42

EXHIBIT 1. INTRODUCTION

1.1. SCOPE

Reference:	FCC Part 15, Subpart C, Section 15.247
Title:	Code of Federal Regulations (CFR), Title 47 – Telecommunication, Part 15 – Radio Frequency Devices
Purpose of Test:	Equipment Certification for Digital Modulation Systems (DTS) Operating Under §15.247
Test Procedures:	<ul style="list-style-type: none"> ▪ ANSI C63.4 ▪ ANSI C63.10 ▪ FCC KDB Publication No. 558074 D01 DTS Meas Guidance v04
Environmental Classification:	<input checked="" type="checkbox"/> Commercial, industrial or business environment <input checked="" type="checkbox"/> Residential environment

1.2. RELATED SUBMITTAL(S)/GRANT(S)

None.

1.3. NORMATIVE REFERENCES

Publication	Year	Title
47 CFR Parts 0-19	2018	Code of Federal Regulations (CFR), Title 47 – Telecommunication
ANSI C63.4	2014	American National Standard for Methods of Measurement of Radio-Noise Emissions from Low-Voltage Electrical and Electronic Equipment in the Range of 9 KHz to 40 GHz
ANSI C63.10	2013	American National Standard of Procedures for Compliance Testing of Unlicensed Wireless Devices
FCC, KDB Publication No. 558074 D01 DTS Meas Guidance v04	2017	Guidance for Performing Compliance Measurements for Digital Transmission Systems (DTS) Operating Under Section 15.247

EXHIBIT 2. PERFORMANCE ASSESSMENT

2.1. CLIENT INFORMATION

Applicant	
Name:	MMB Research Inc.
Address:	243 College St, Suite 500 Toronto, ON M5T 1R5 Canada
Contact Person:	Hussein Nagji Phone #: 416-636-3145 x237 Fax #: n/a Email Address: hussein.nagji@mmbnetworks.com

Manufacturer	
Name:	MMB Research Inc.
Address:	243 College St, Suite 500 Toronto, ON M5T 1R5 Canada
Contact Person:	Hussein Nagji Phone #: 416-636-3145 x237 Fax #: n/a Email Address: hussein.nagji@mmbnetworks.com

2.2. EQUIPMENT UNDER TEST (EUT) INFORMATION

The following information (with the exception of the Date of Receipt) has been supplied by the applicant.

Brand Name:	MMB Research Inc.
Product Name:	ZigBee/Thread/BLE Module
*Model(s):	19.5 dBm Variant: <ul style="list-style-type: none"> • CSB04PA10-CHP (with chip antenna) • CSB04PA10-RFC (with a U.FL connector) 10 dBm Variant: <ul style="list-style-type: none"> • CSB04PA11-CHP (with chip antenna) • CSB04PA11-RFC (with a U.FL connector)
Serial Number:	Test Sample
Type of Equipment:	Digital Transmission System (DTS)
Input Power Supply Type:	External DC Power Supply
Primary User Functions of EUT:	ZigBee/Thread/BLE Module

*Both variants have identical HW and output power is limited via software.

2.3. EUT’S TECHNICAL SPECIFICATIONS

Transmitter	
Equipment Type:	Mobile Base station (fixed use)
Intended Operating Environment:	Commercial, industrial or business environment Residential environment
Power Supply Requirement:	3.3 VDC
RF Output Power Rating:	10 dBm to 19.5 dBm
Operating Frequency Range:	2405 - 2480 MHz
RF Output Impedance:	50 Ω
Duty Cycle:	Continuous
Modulation Type:	O-QPSK
Antenna Connector Types:	Integral antenna or U.FL

2.4. ASSOCIATED ANTENNA DESCRIPTIONS

Antenna Type	Manufacturer	Model	Maximum Gain (dBi)
Integral Chip Antenna	Inpaq	ACA-2012-A1-CC-S	1.72
Dipole Antenna	Mag-Layers Scientific-Technics Co. Ltd.	EDA-1713-2G4C1-A2	5

2.5. LIST OF EUT’S PORTS

Port Number	EUT’s Port Description	Number of Identical Ports	Connector Type	Cable Type (Shielded/Non-shielded)
1	RF port	1	Integral antenna or U.FL	Shielded cable (N/A for integral antenna)
2	GPIO	1	Pins	Direct connection (no cable)

2.6. ANCILLARY EQUIPMENT

The EUT was tested while connected to the following representative configuration of ancillary equipment necessary to exercise the ports during tests:

Ancillary Equipment # 1	
Description:	Test Jig
Brand name:	MMB Research Inc.
Model Name or Number:	BSB03PA10-DM1
Serial Number:	N/A
Connected to EUT’s Port:	Module pin signals

EXHIBIT 3. EUT OPERATING CONDITIONS AND CONFIGURATIONS DURING TESTS

3.1. CLIMATE TEST CONDITIONS

The climate conditions of the test environment are as follows:

Temperature:	21 to 23 °C
Humidity:	45 to 58%
Pressure:	102 kPa
Power Input Source:	3.3 VDC

3.2. OPERATIONAL TEST CONDITIONS & ARRANGEMENT FOR TESTS

Operating Modes:	The transmitter was operated in a continuous transmission mode with the carrier modulated as specified in the Test Data.
Special Test Software:	Test software provided by the Applicant to operate the EUT at each channel frequency continuously and in the range of typical modes of operation.
Special Hardware Used:	Test Jig
Transmitter Test Antenna:	The EUT is tested with the antenna fitted in a manner typical of normal intended use as integral / non-integral antenna equipment as described with the test results.

Transmitter Test Signals	
Frequency Band(s):	2405 - 2480 MHz
Frequency(ies) Tested:	2405 MHz, 2440 MHz, 2475 MHz, 2480 MHz
RF Power Output: (measured maximum output power at antenna terminals)	19.77 dBm Peak
Normal Test Modulation:	O-QPSK
Modulating Signal Source:	Internal

EXHIBIT 4. SUMMARY OF TEST RESULTS

4.1. LOCATION OF TESTS

All of the measurements described in this report were performed at Ultratech Group of Labs located in the city of Oakville, Province of Ontario, Canada.

- AC Power Line Conducted Emissions were performed in UltraTech's shielded room, 24'(L) by 16'(W) by 8'(H).
- Radiated Emissions were performed at the Ultratech's 3-10 TDK Semi-Anechoic Chamber situated in the Town of Oakville, province of Ontario. This test site been calibrated in accordance with ANSI C63.4, and found to be in compliance with the requirements of Sec. 2.948 of the FCC Rules. The descriptions and site measurement data of the Oakville 3-10 TDK Semi-Anechoic Chamber has been filed with ANAB File No.: AT-1945.

4.2. APPLICABILITY & SUMMARY OF EMC EMISSION TEST RESULTS

FCC Section(s)	Test Requirements	Compliance (Yes/No)
15.203	Antenna requirements	Yes*
15.207(a)	AC Power Line Conducted Emissions	Yes
15.247(a)(2)	6 dB Bandwidth	Yes
15.247(b)(3)	Peak Conducted Output Power	Yes
15.247(d)	Band-Edge and RF Conducted Spurious Emissions at the Transmitter Antenna Terminal	Yes
15.247(d), 15.209 & 15.205	Transmitter Spurious Radiated Emissions	Yes
15.247(e)	Power Spectral Density	Yes
15.247(i), 1.1307, 1.1310, 2.1091	RF Exposure	Yes

* The EUT complies with the requirement; it employs a unique (non-standard) antenna connector or integral antenna.

4.3. MODIFICATIONS INCORPORATED IN THE EUT FOR COMPLIANCE PURPOSES

None.

EXHIBIT 5. TEST DATA

5.1. POWER LINE CONDUCTED EMISSIONS [§15.207(a)]

5.1.1. Limit(s)

The equipment shall meet the limits of the following table:

Frequency of emission (MHz)	Conducted Limits (dB μ V)	
	Quasi-peak	Average
0.15–0.5	66 to 56*	56 to 46*
0.5–5	56	46
5–30	60	50

*Decreases linearly with the logarithm of the frequency

5.1.2. Method of Measurements

ANSI C63.4

5.1.3. Test Arrangement

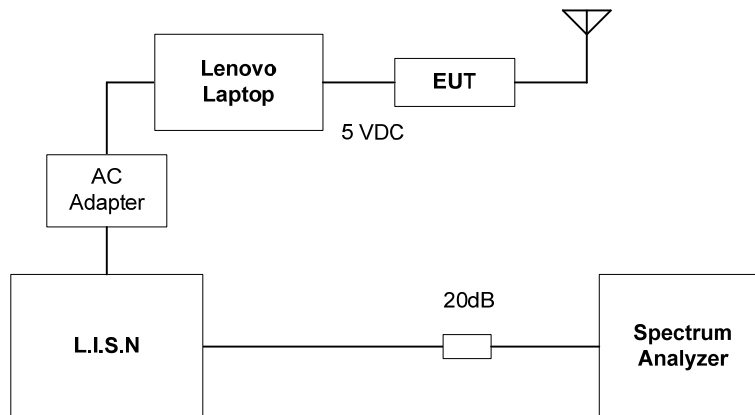

5.1.4. Test Data

Plot 5.1.4.1. Power Line Conducted Emissions (Tx Mode)
Line Voltage: 120 VAC; Line Tested: Hot

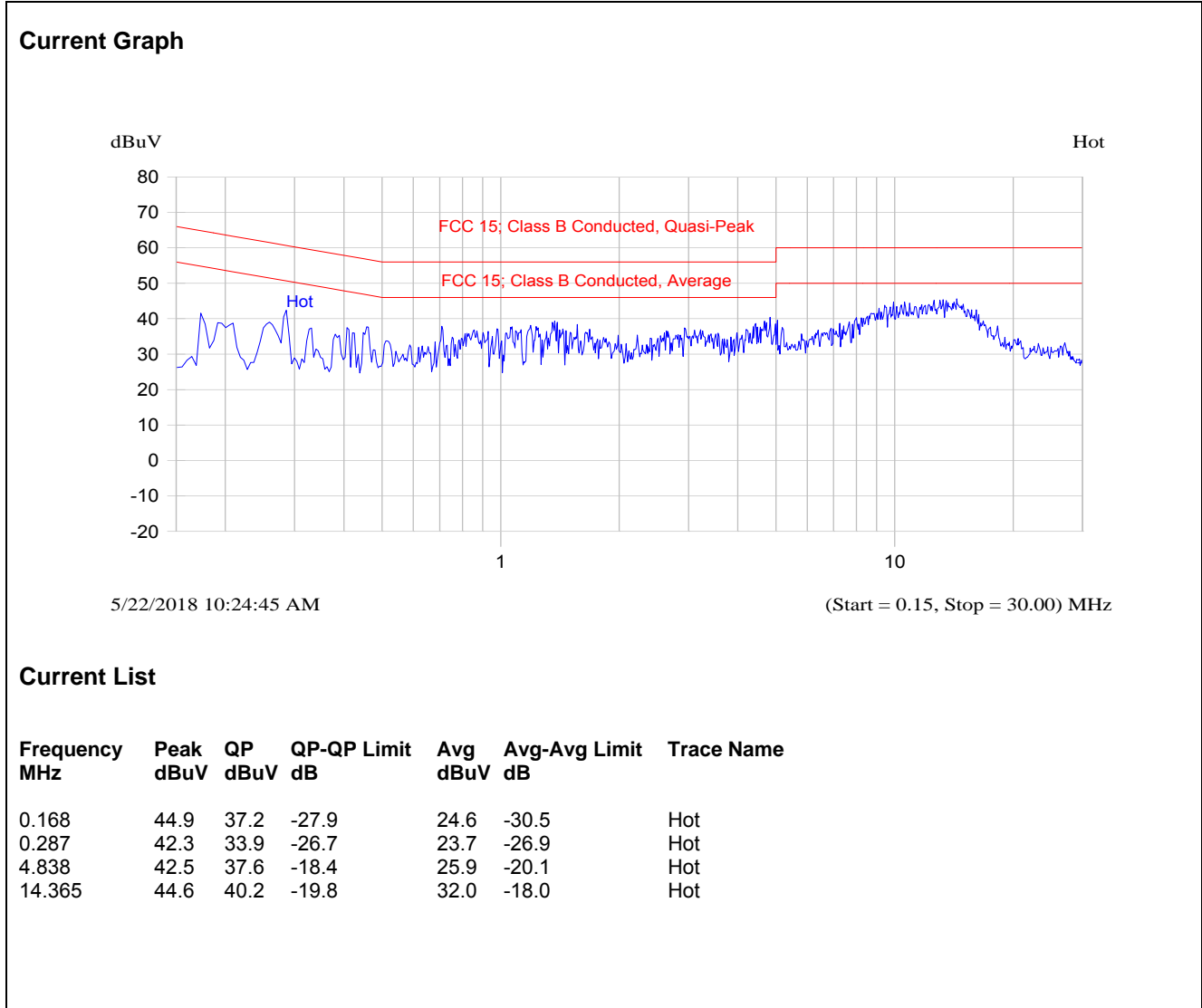

Plot 5.1.4.2. Power Line Conducted Emissions (Tx Mode)
 Line Voltage: 120 VAC Line Tested: Neutral

Current Graph

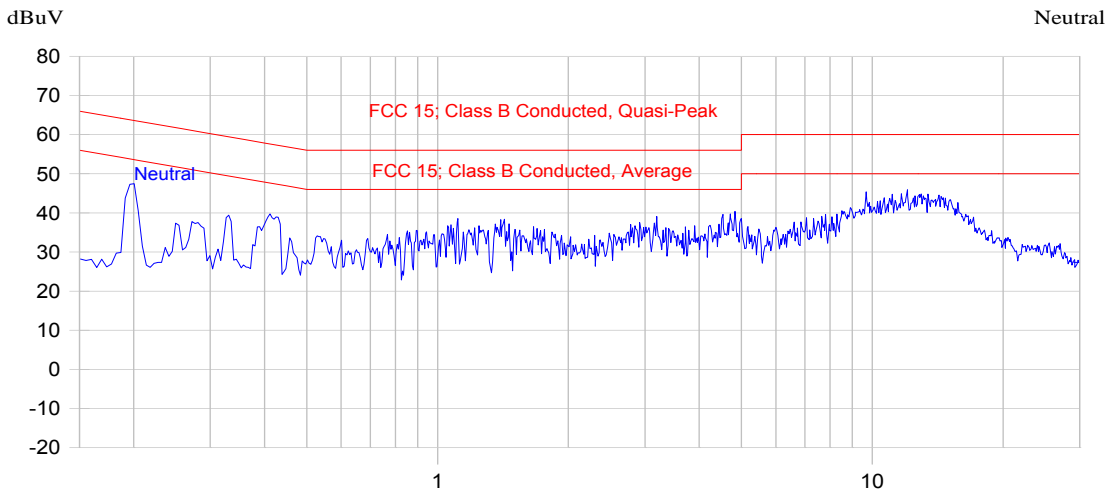

5/22/2018 10:13:10 AM

(Start = 0.15, Stop = 30.00) MHz

Current List

Frequency MHz	Peak dBuV	QP dBuV	QP-QP Limit dB	Avg dBuV	Avg-Avg Limit dB	Trace Name
0.192	46.6	42.9	-21.1	30.1	-23.8	Neutral
0.411	40.8	37.6	-20.0	25.8	-21.8	Neutral
1.125	40.4	35.6	-20.4	25.8	-20.2	Neutral
12.037	46.4	42.2	-17.8	31.6	-18.4	Neutral

Plot 5.1.4.3. Power Line Conducted Emissions (Rx Mode)
 Line Voltage: 120 VAC; Line Tested: Hot

Current Graph

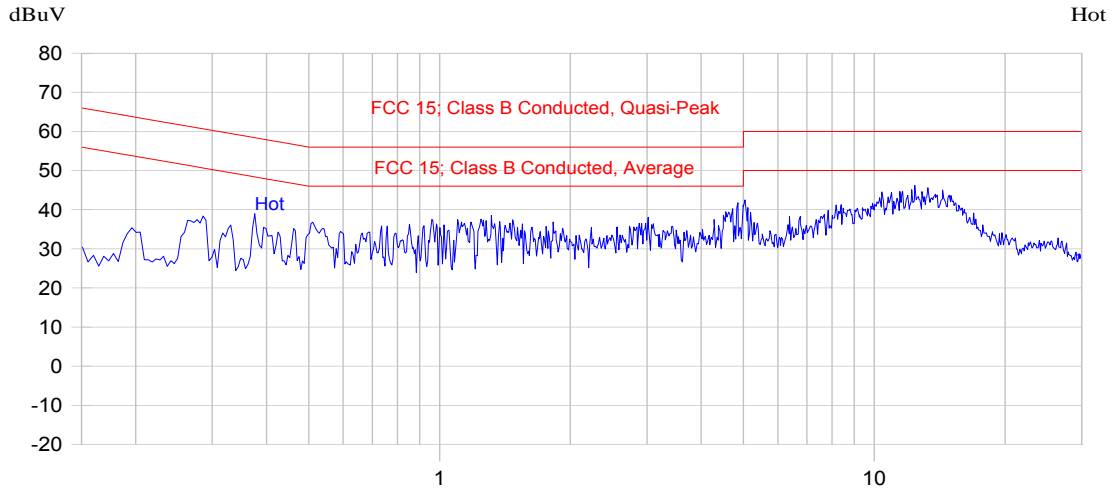

5/22/2018 9:51:22 AM

(Start = 0.15, Stop = 30.00) MHz

Current List

Frequency MHz	Peak dBuV	QP dBuV	QP-QP Limit dB	Avg dBuV	Avg-Avg Limit dB	Trace Name
0.286	42.0	34.4	-26.3	23.5	-27.2	Hot
0.384	41.4	36.0	-22.2	26.0	-22.2	Hot
4.987	39.7	34.5	-21.5	25.0	-21.0	Hot
12.385	44.3	37.9	-22.1	28.7	-21.3	Hot

Plot 5.1.4.4. Power Line Conducted Emissions (Rx Mode)
 Line Voltage: 120 VAC; Line Tested: Neutral

Current Graph

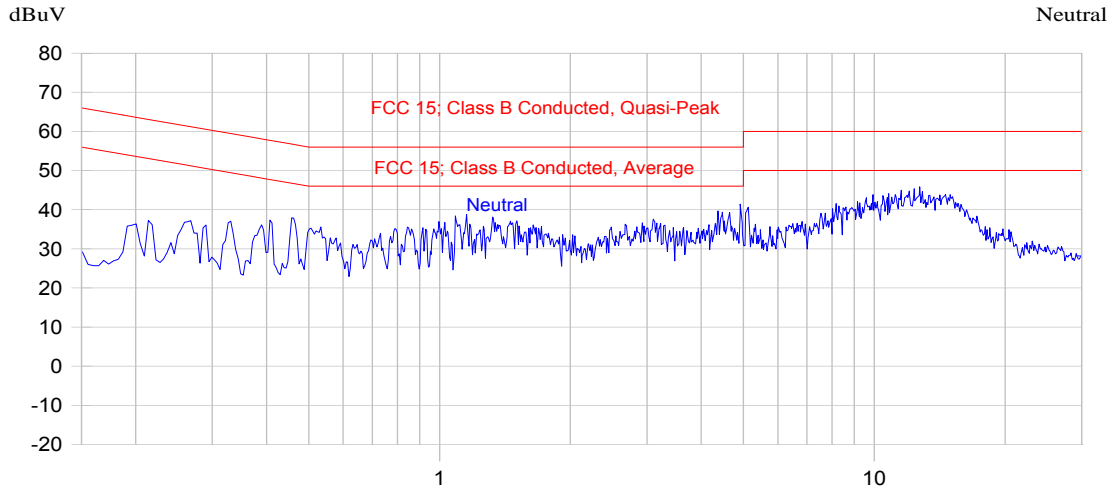

5/22/2018 10:02:43 AM

(Start = 0.15, Stop = 30.00) MHz

Current List

Frequency MHz	Peak dBuV	QP dBuV	QP-QP Limit dB	Avg dBuV	Avg-Avg Limit dB	Trace Name
0.210	46.1	40.3	-22.9	26.8	-26.4	Neutral
0.280	42.3	37.2	-23.6	25.2	-25.6	Neutral
0.414	41.5	36.8	-20.8	25.5	-22.1	Neutral
0.457	40.2	37.5	-19.2	30.1	-16.7	Neutral
1.164	39.9	35.1	-20.9	25.6	-20.4	Neutral
4.921	41.0	36.0	-20.0	25.6	-20.4	Neutral
12.721	47.1	42.6	-17.4	32.3	-17.7	Neutral

5.2. OCCUPIED BANDWIDTH [§ 15.247(a)(2)]

5.2.1. Limit(s)

The minimum 6 dB bandwidth shall be at least 500 kHz.

5.2.2. Method of Measurements

KDB 558074 D01 DTS Meas Guidance v04, Section 8.2 Option 2.

5.2.3. Test Arrangement

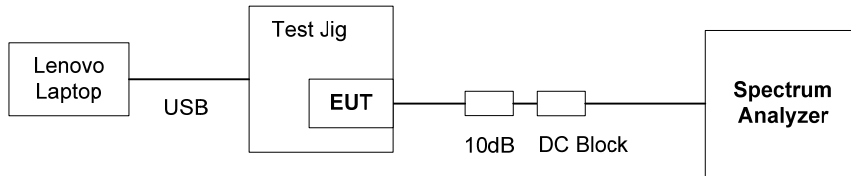

USB provide 5 Vdc and software to operate radio module

5.2.4. Test Data

Modulation	Power Setting	Channel	Frequency (MHz)	6dB BW (MHz)	Min. Limit (kHz)
O-QPSK	200	11	2405	1.68	500
	200	18	2440	1.68	500
	200	25	2475	1.69	500
	160	26	2480	1.69	500

Plot 5.2.4.1. 6 dB Bandwidth, O-QPSK Modulation, Power Setting at 200, Channel 11, 2405 MHz

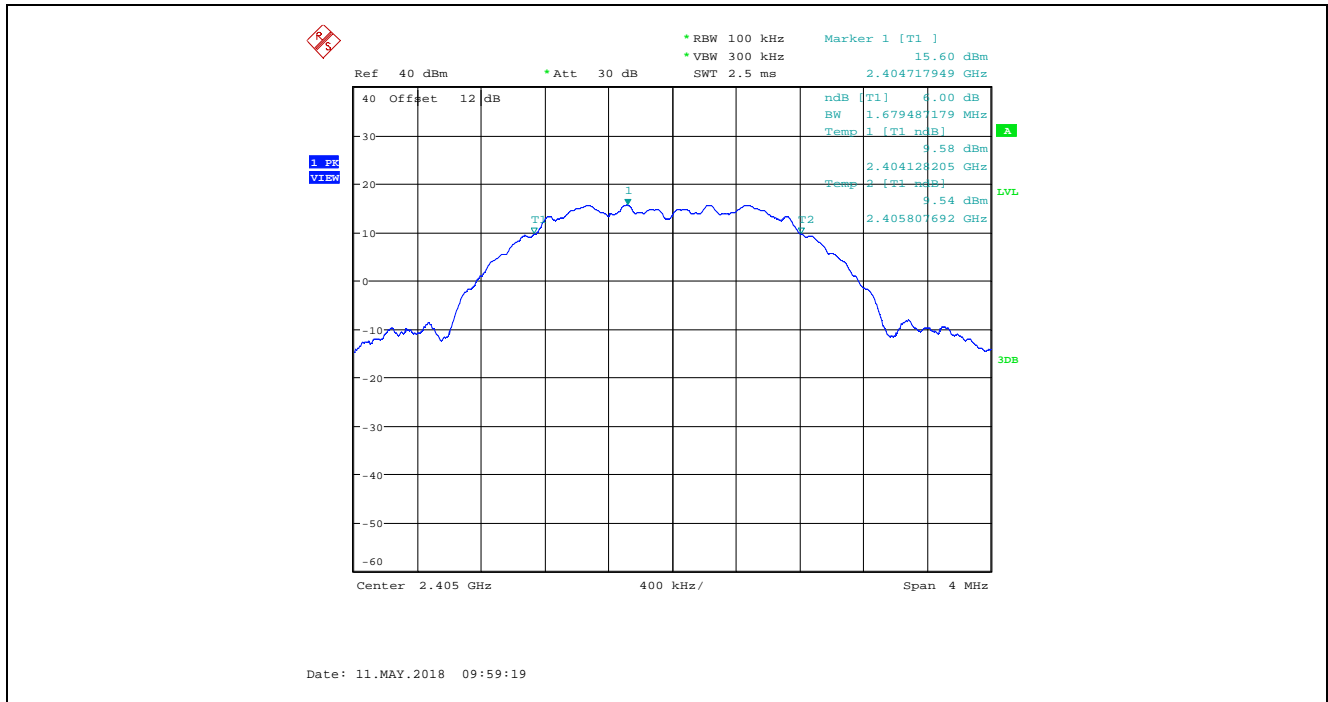

Plot 5.2.4.2. 6 dB Bandwidth, O-QPSK Modulation, Power Setting at 200, Channel 18, 2440 MHz

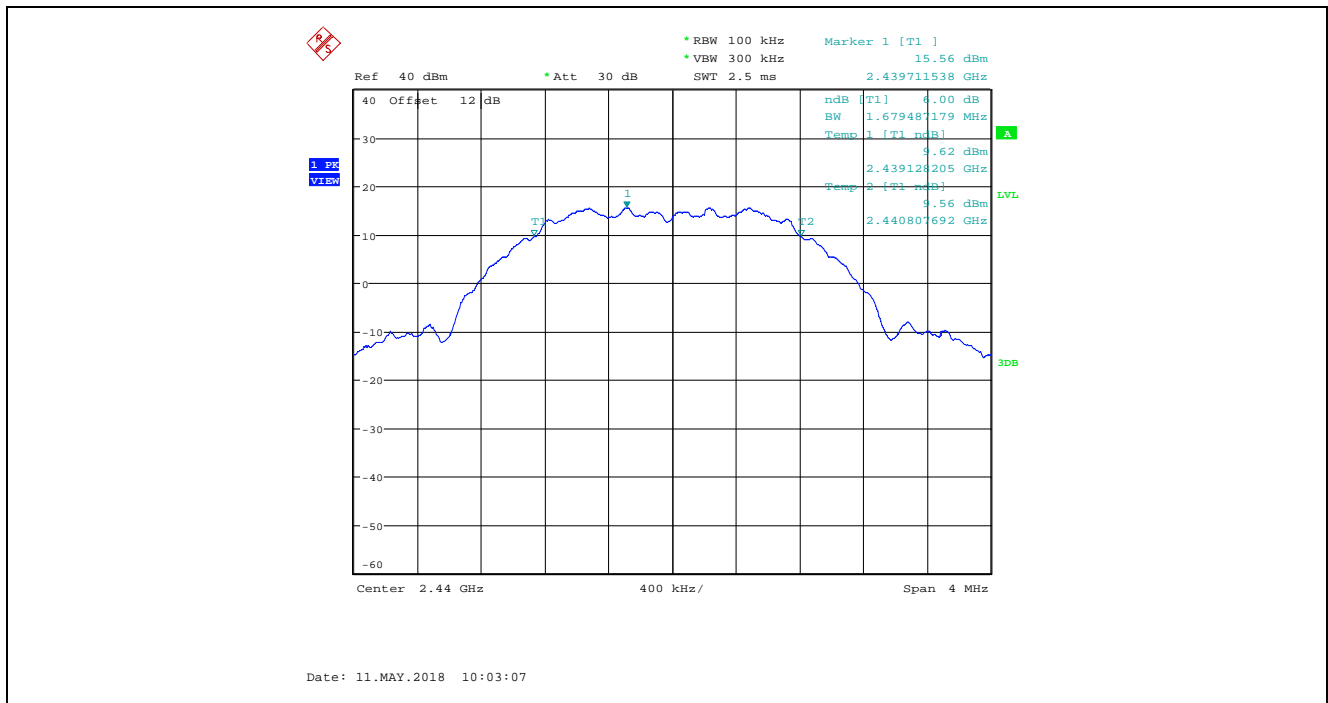

Plot 5.2.4.3. 6 dB Bandwidth, O-QPSK Modulation, Power Setting at 200, Channel 25, 2475 MHz

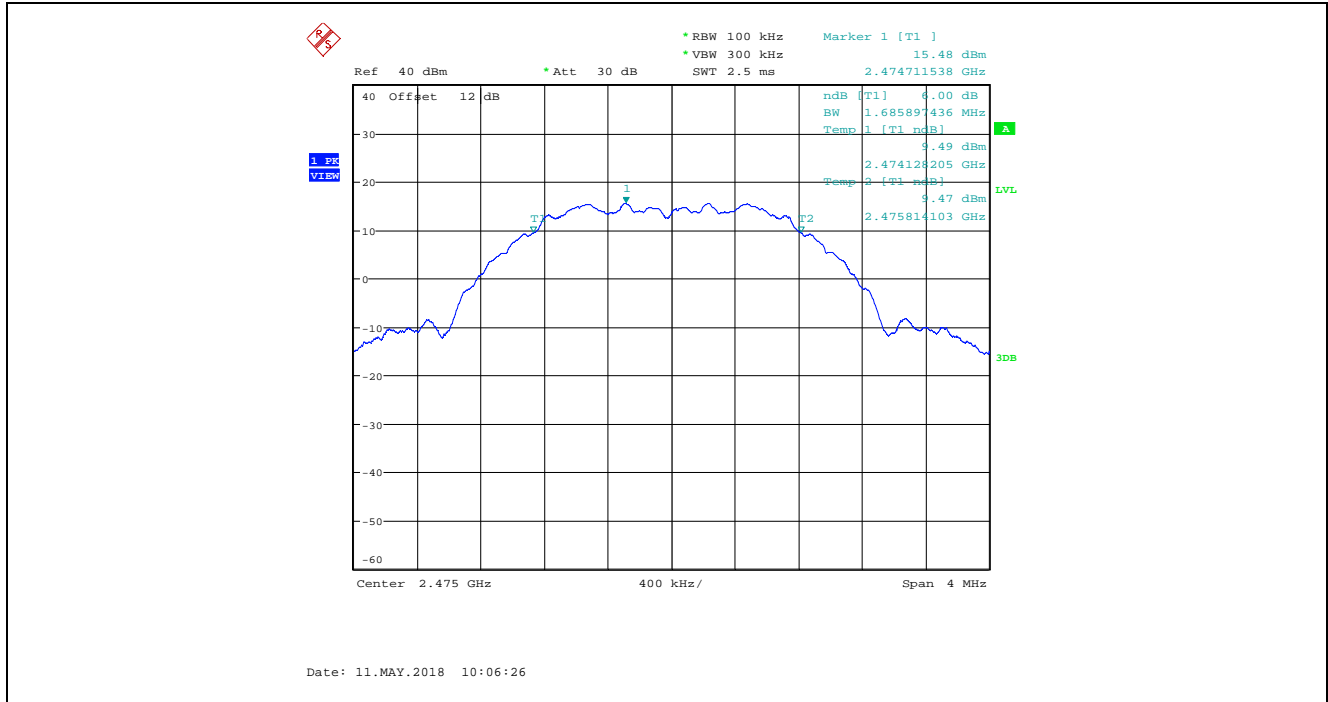

Plot 5.2.4.4. 6 dB Bandwidth, O-QPSK Modulation, Power Setting at 160, Channel 26, 2480 MHz

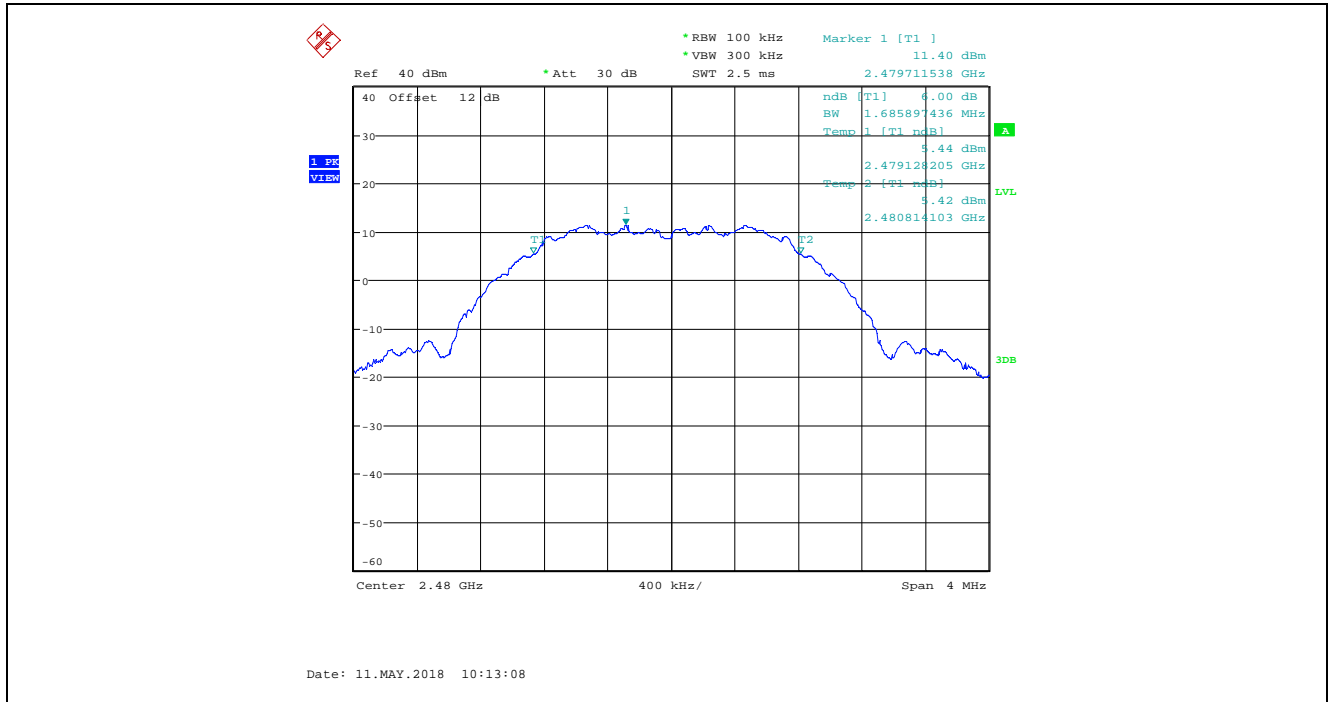

5.3. PEAK CONDUCTED OUTPUT POWER - DTS [§ 15.247(b)(3)]

5.3.1. Limit(s)

§ 15.247(b)(3): For systems using digital modulation in the 902-928 MHz, 2400-2483.5 MHz, and 5725-5850 MHz bands: 1 Watt. As an alternative to a peak power measurement, compliance with the one Watt limit can be based on a measurement of the maximum conducted output power. Maximum Conducted Output Power is defined as the total transmit power delivered to all antennas and antenna elements averaged across all symbols in the signaling alphabet when the transmitter is operating at its maximum power control level. Power must be summed across all antennas and antenna elements. The average must not include any time intervals during which the transmitter is off or is transmitting at a reduced power level. If multiple modes of operation are possible (e.g., alternative modulation methods), the *maximum conducted output power* is the highest total transmit power occurring in any mode.

§ 15.247(b)(4): The conducted output power limit specified in paragraph (b) of this section is based on the use of antennas with directional gains that do not exceed 6 dBi. Except as shown in paragraph (c) of this section, if transmitting antennas of directional gain greater than 6 dBi are used, the conducted output power from the intentional radiator shall be reduced below the stated values in paragraphs (b)(1), (b)(2), and (b)(3) of this section, as appropriate, by the amount in dB that the directional gain of the antenna exceeds 6 dBi.

5.3.2. Method of Measurements & Test Arrangement

KDB 558074 D01 DTS Meas Guidance V04, Section 9.1.1 RBW ≥ DTS bandwidth

5.3.3. Test Arrangement

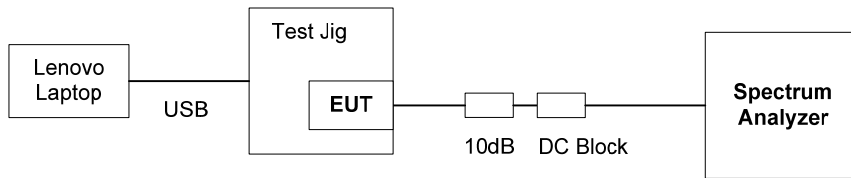

USB provide 5 Vdc and software to operate radio module

5.3.4. Test Data

Peak Conducted Power and Power Settings for EUT with 1.72 dBi Chip Antenna							
Modulation	Power Setting	Channel	Frequency (MHz)	Peak Power (dBm)	Assembly Gain (dB)	EIRP (dBm)	Peak Power Limit (dBm)
O-QPSK	High Power Level						
	200	11	2405	19.77	1.72	21.49	30
	200	18	2440	19.64	1.72	21.36	30
	200	25	2475	19.57	1.72	21.29	30
	160	26	2480	15.42	1.72	17.14	30
	Low Power Level						
	107	11	2405	10.09	1.72	11.81	30
	107	18	2440	9.99	1.72	11.71	30
	107	25	2475	10.12	1.72	11.84	30
	107	26	2480	10.12	1.72	11.84	30

Peak Conducted Power and Power Settings for EUT with 5 dBi Dipole Antenna							
Modulation	Power Setting	Channel	Frequency (MHz)	Peak Power (dBm)	Assembly Gain (dB)	EIRP (dBm)	Peak Power Limit (dBm)
O-QPSK	High Power Level						
	200	11	2405	19.77	5	24.77	30
	200	18	2440	19.64	5	24.64	30
	200	25	2475	19.57	5	24.57	30
	100	26	2480	8.34	5	13.34	30
	Low Power Level						
	107	11	2405	10.09	5	15.09	30
	107	18	2440	9.99	5	14.99	30
	107	25	2475	10.12	5	15.12	30
	100	26	2480	8.34	5	13.34	30

Plot 5.3.4.1. Maximum Peak Conducted Output Power, O-QPSK Modulation, Power Setting 200, Ch 11, 2405 MHz

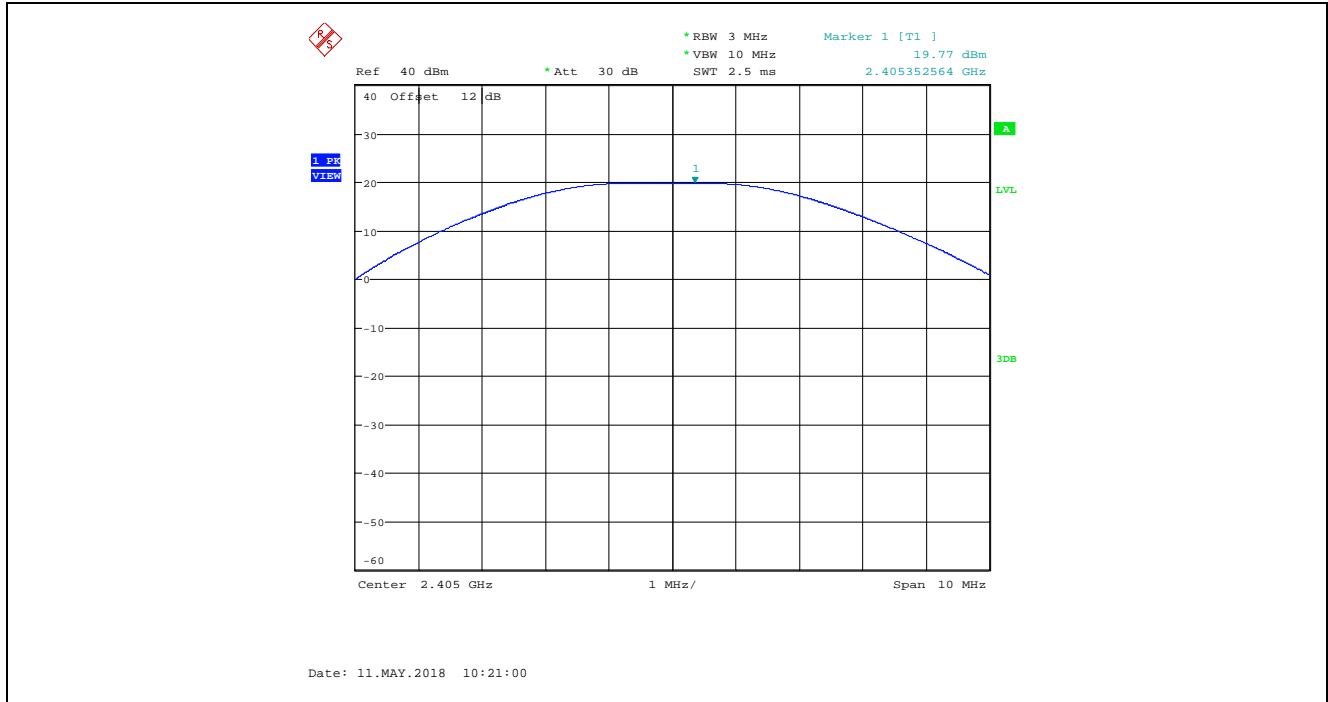

Plot 5.3.4.2. Maximum Peak Conducted Output Power, O-QPSK Modulation, Power Setting 200, Ch 18, 2440 MHz

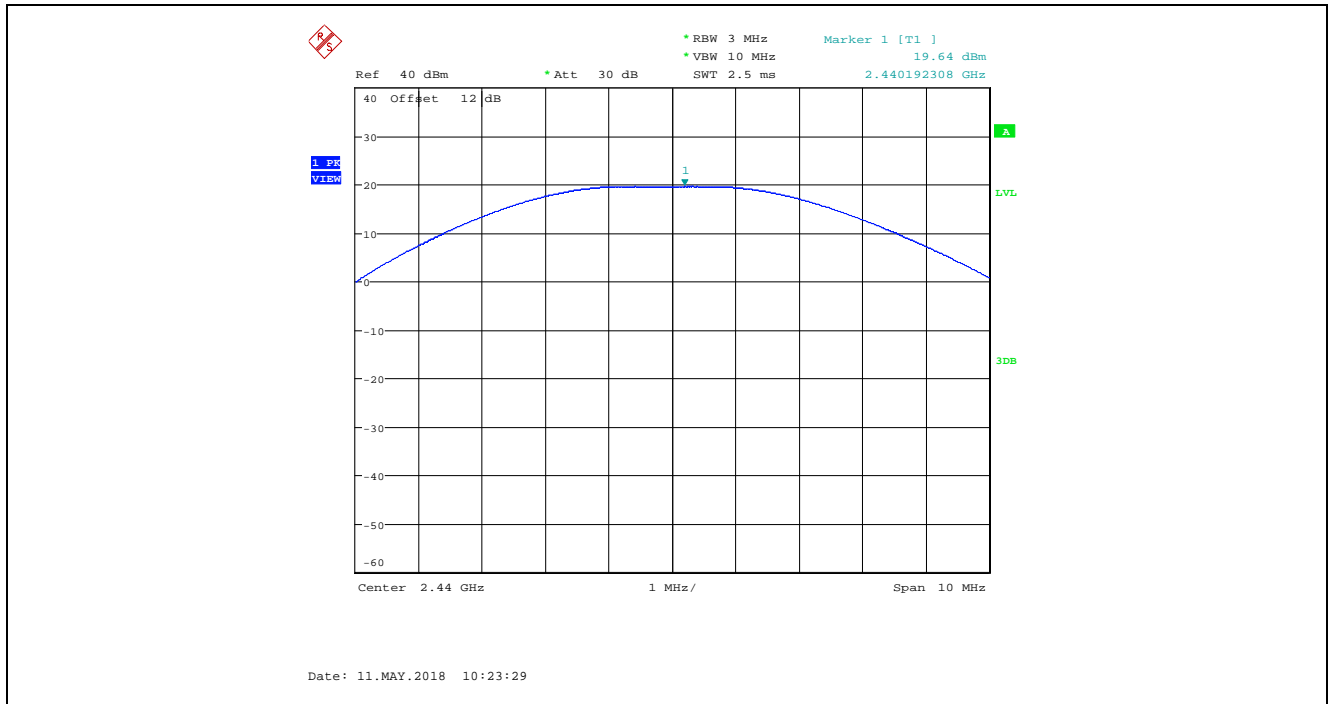

Plot 5.3.4.3. Maximum Peak Conducted Output Power, O-QPSK Modulation, Power Setting 200, Ch 25, 2475 MHz

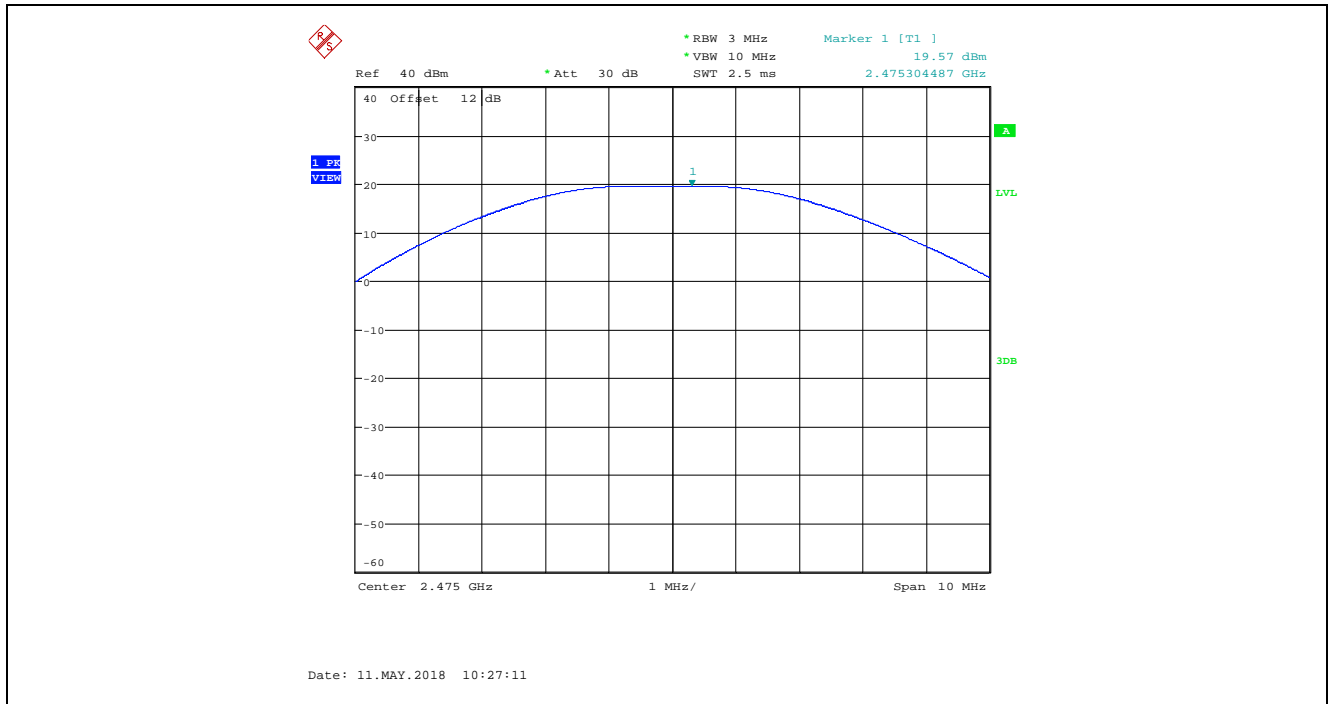

Plot 5.3.4.4. Maximum Peak Conducted Output Power, O-QPSK Modulation, Power Setting 160, Ch 26, 2480 MHz

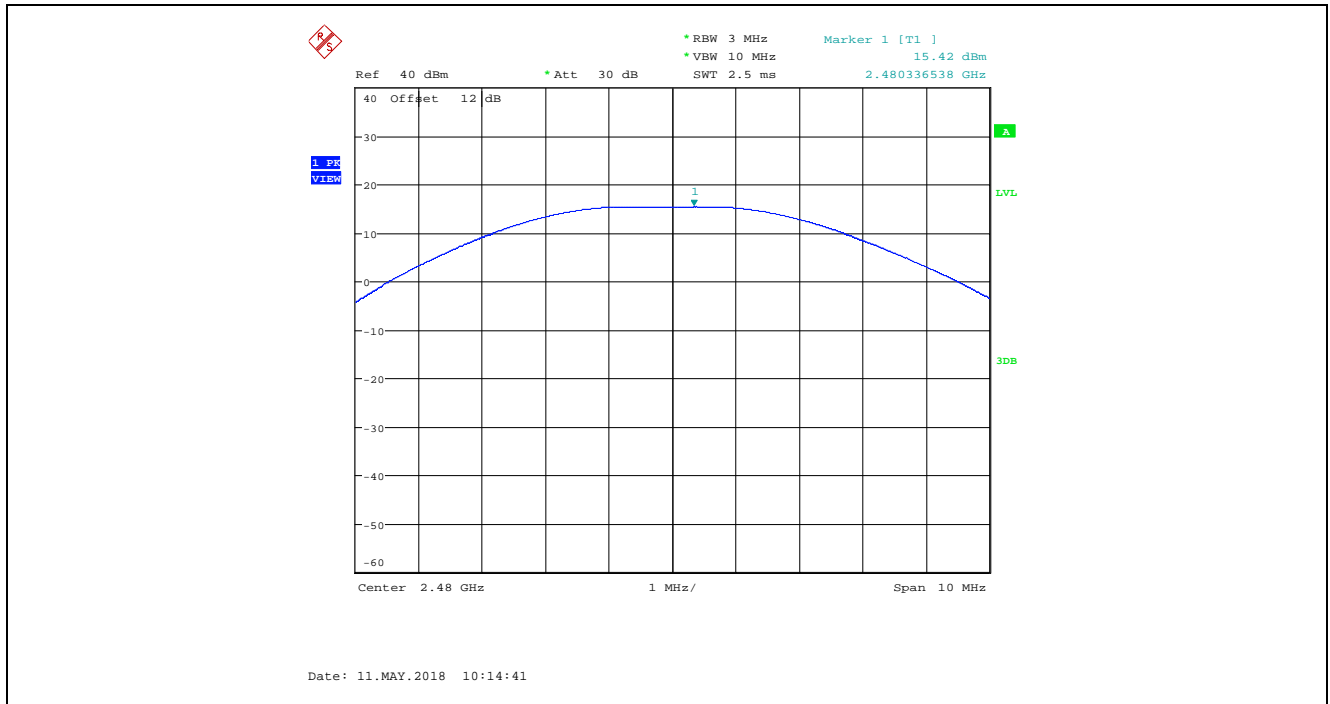

Plot 5.3.4.5. Maximum Peak Conducted Output Power, O-QPSK Modulation, Power Setting 107, Ch 11, 2405 MHz

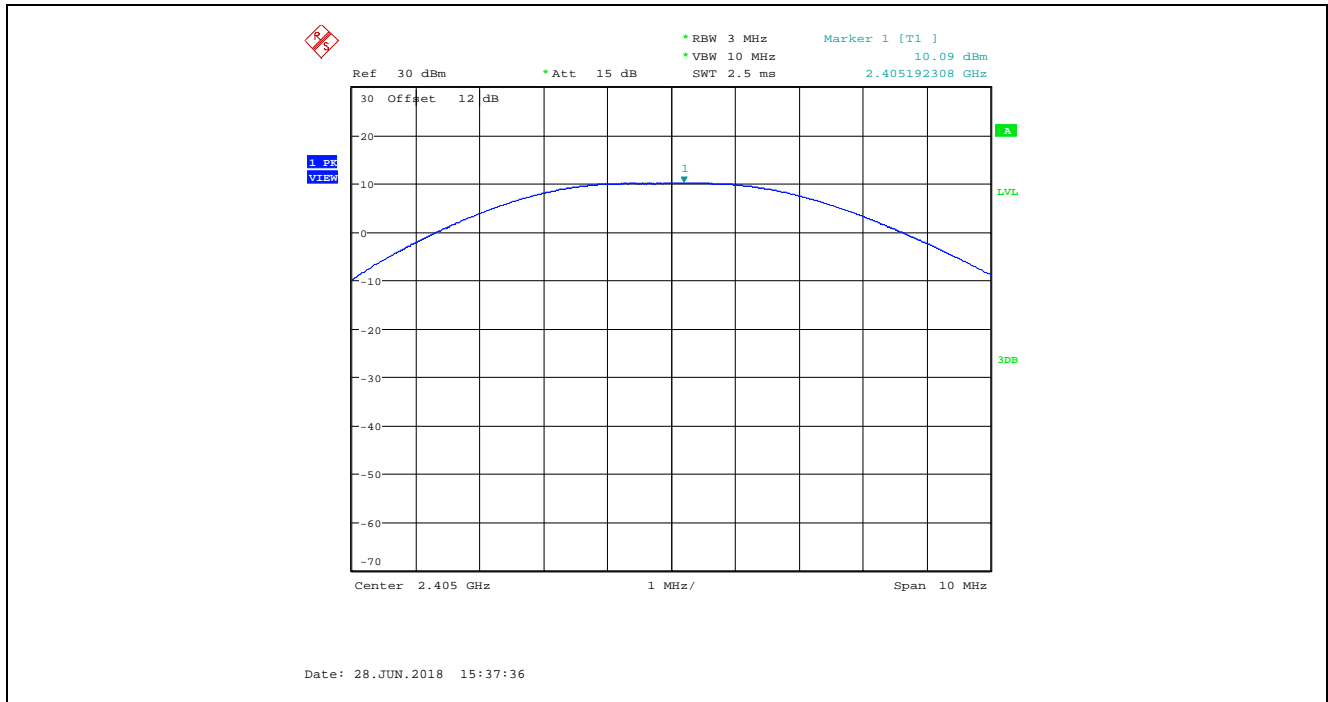

Plot 5.3.4.6. Maximum Peak Conducted Output Power, O-QPSK Modulation, Power Setting 107, Ch 18, 2440 MHz

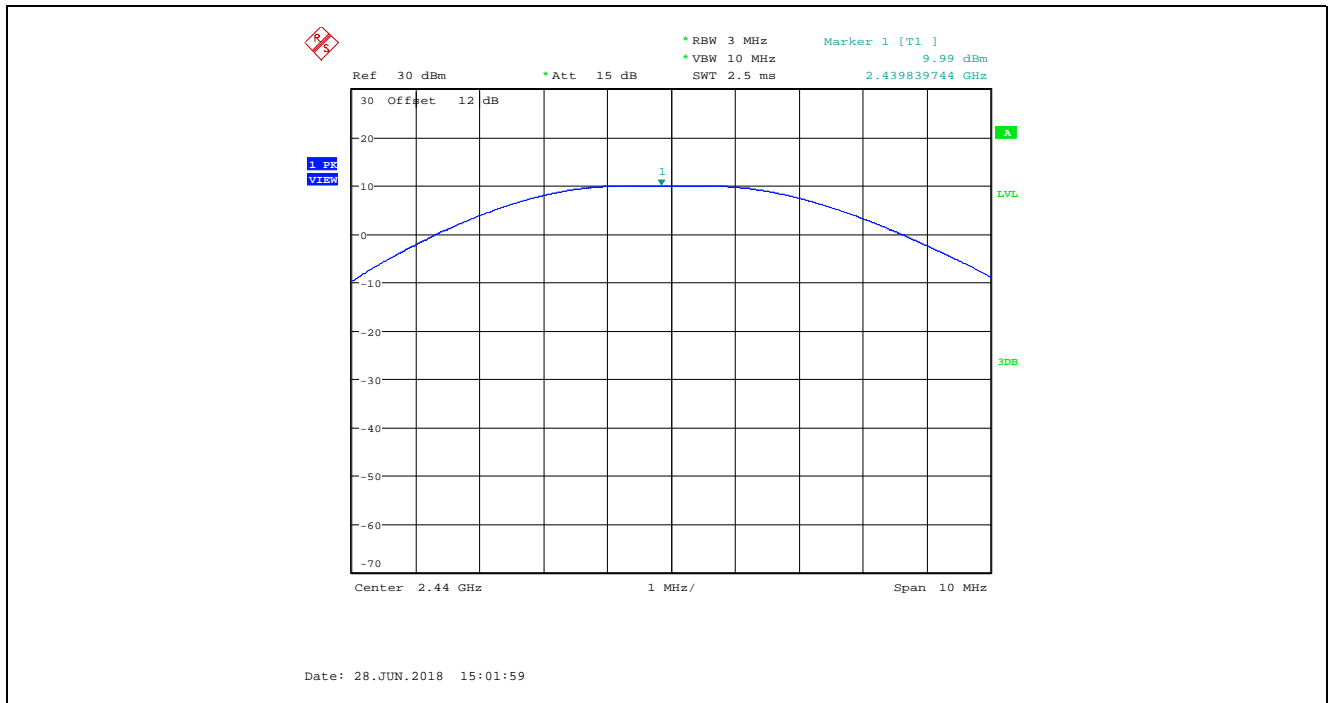

Plot 5.3.4.7. Maximum Peak Conducted Output Power, O-QPSK Modulation, Power Setting 107, Ch 25, 2475 MHz

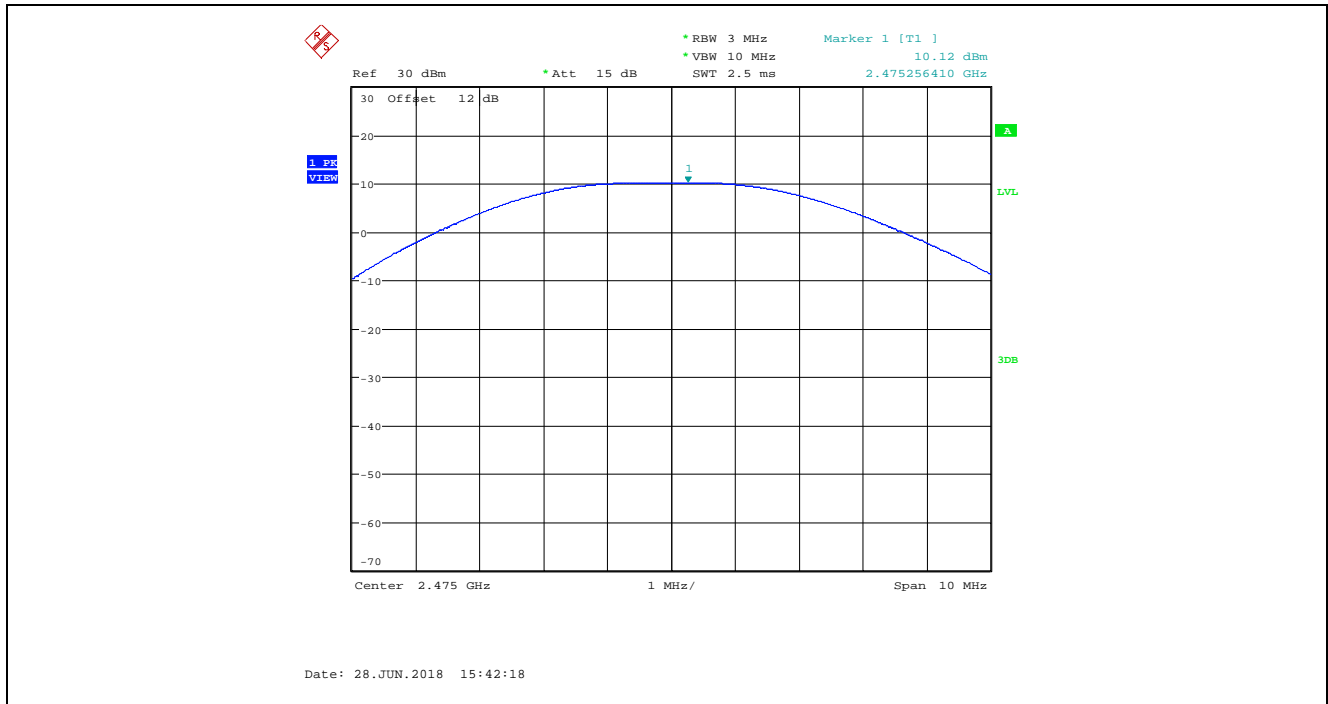

Plot 5.3.4.8. Maximum Peak Conducted Output Power, O-QPSK Modulation, Power Setting 107, Ch 26, 2480 MHz

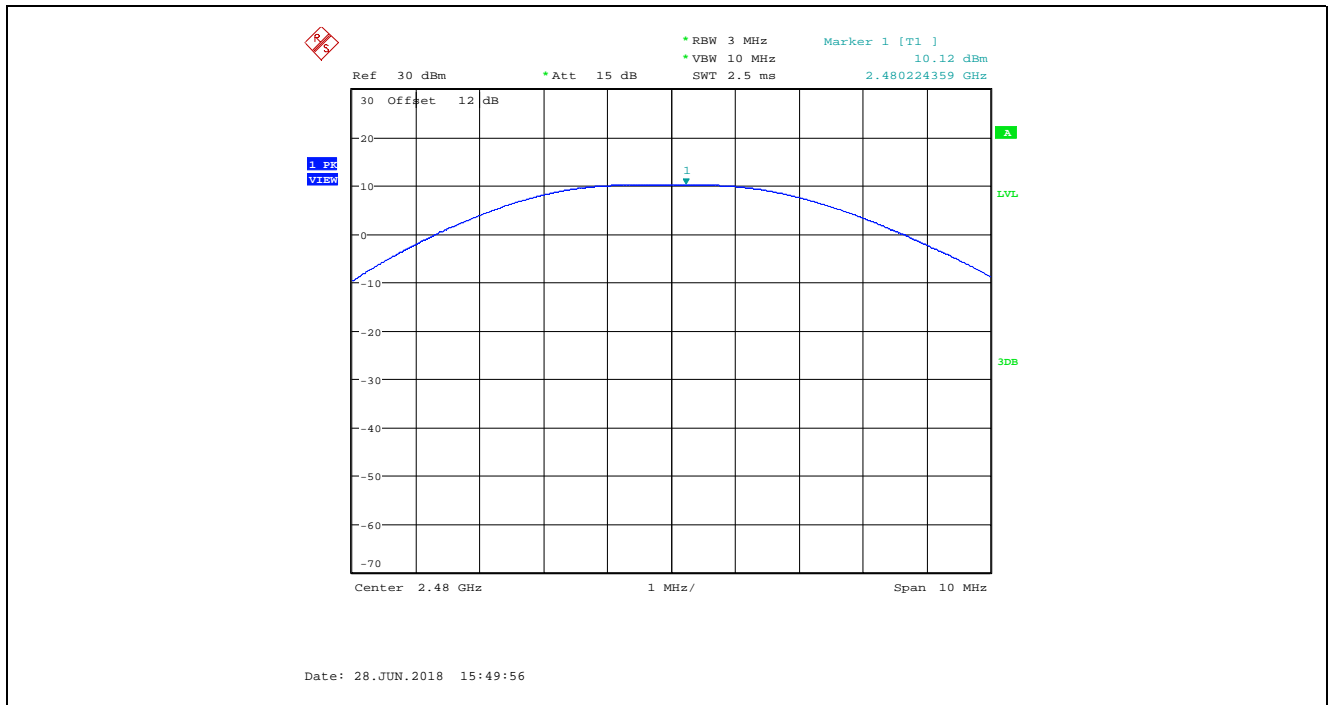

Plot 5.3.4.9. Maximum Peak Conducted Output Power, O-QPSK Modulation, Power Setting 100, Ch 26, 2480 MHz

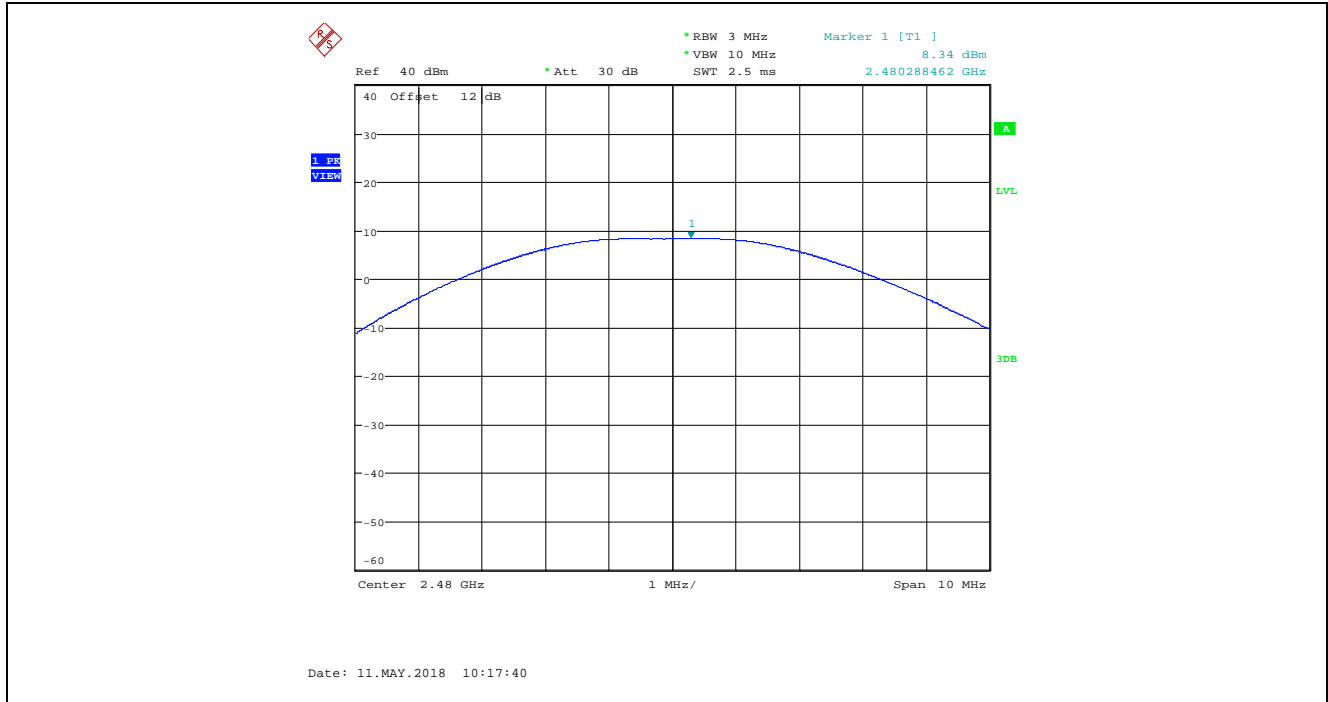

5.4. TRANSMITTER SPURIOUS RADIATED EMISSIONS AT 3 METERS [§§ 15.247(d), 15.209 & 15.205]

5.4.1. Limit(s)

§ 15.247 (d): In any 100 kHz bandwidth outside the frequency band in which the spread spectrum or digitally modulated intentional radiator is operating, the radio frequency power that is produced by the intentional radiator shall be at least 20 dB below that in the 100 kHz bandwidth within the band that contains the highest level of the desired power, based on either an RF conducted or a radiated measurement, provided the transmitter demonstrates compliance with the peak conducted power limits. If the transmitter complies with the conducted power limits based on the use of RMS averaging over a time interval, as permitted under paragraph (b)(3) of this section, the attenuation required under this paragraph shall be 30 dB instead of 20 dB. Attenuation below the general limits specified in Section 15.209(a) is not required. In addition, radiated emissions which fall in the restricted bands, as defined in Section 15.205(a), must also comply with the radiated emission limits specified in Section 15.209(a) (see Section 15.205(c)).

Section 15.205(a) - Restricted Bands of Operation

MHz	MHz	MHz	GHz
0.090–0.110	16.42–16.423	399.9–410	4.5–5.15
¹ 0.495–0.505	16.69475–16.69525	608–614	5.35–5.46
2.1735–2.1905	16.80425–16.80475	960–1240	7.25–7.75
4.125–4.128	25.5–25.67	1300–1427	8.025–8.5
4.17725–4.17775	37.5–38.25	1435–1626.5	9.0–9.2
4.20725–4.20775	73–74.6	1645.5–1646.5	9.3–9.5
6.215–6.218	74.8–75.2	1660–1710	10.6–12.7
6.26775–6.26825	108–121.94	1718.8–1722.2	13.25–13.4
6.31175–6.31225	123–138	2200–2300	14.47–14.5
8.291–8.294	149.9–150.05	2310–2390	15.35–16.2
8.362–8.366	156.52475–156.52525	2483.5–2500	17.7–21.4
8.37625–8.38675	156.7–156.9	2655–2900	22.01–23.12
8.41425–8.41475	162.0125–167.17	3260–3267	23.6–24.0
12.29–12.293	167.72–173.2	3332–3339	31.2–31.8
12.51975–12.52025	240–285	3345.8–3358	36.43–36.5
12.57675–12.57725	322–335.4	3600–4400	(²)
13.36–13.41.			

¹Until February 1, 1999, this restricted band shall be 0.490–0.510 MHz.

²Above 38.6

Section 15.209(a) - Field Strength Limits within Restricted Frequency Bands

Frequency (MHz)	Field Strength (microvolts/meter)	Measurement Distance (meters)
0.009 - 0.490	2,400 / F (kHz)	300
0.490 - 1.705	24,000 / F (kHz)	30
1.705 - 30.0	30	30
30 – 88	100	3
88 – 216	150	3
216 – 960	200	3
Above 960	500	3

5.4.2. Method of Measurements

KDB 558074 D01 DTS Meas Guidance v04 Sections 12.2.7, 13 and ANSI C63.10.

5.4.3. Test Arrangement

Radiated Emissions

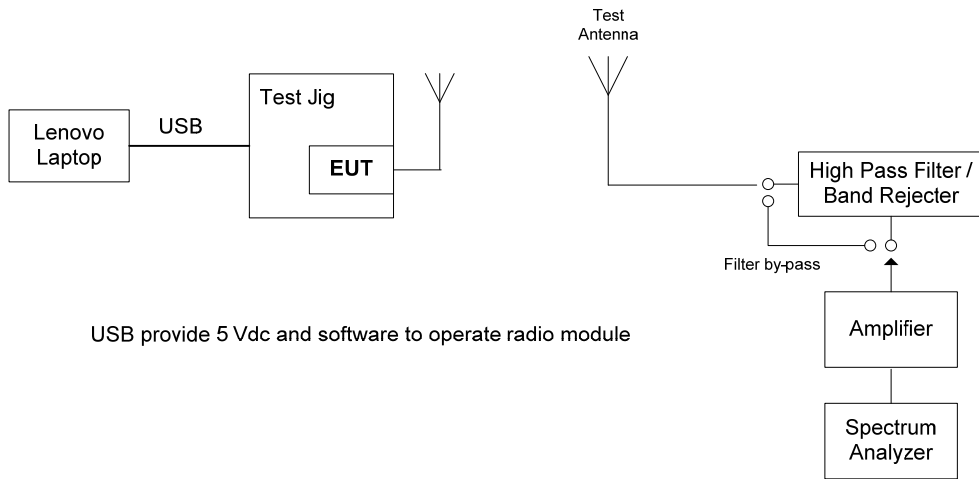

Band-Edge Radiated Emissions

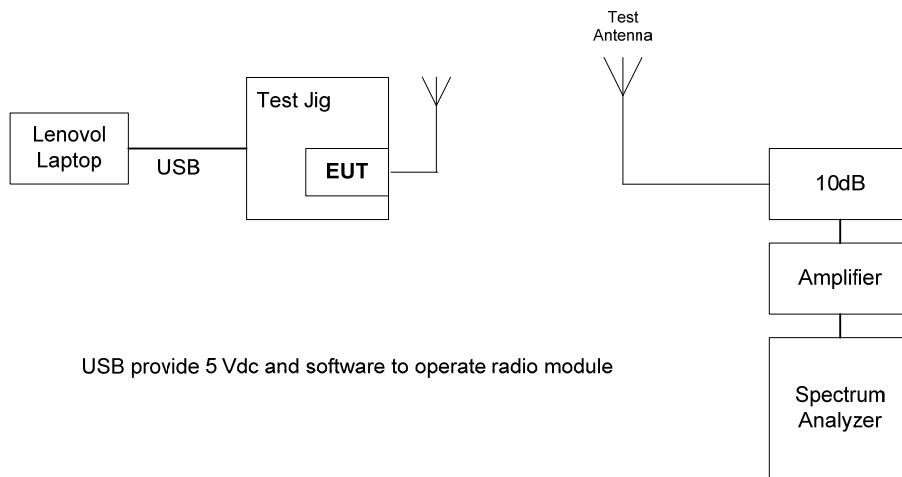

5.4.4. Test Data

Remark(s):

- All spurious emissions that are in excess of 20 dB below the specified limit shall be recorded.
- EUT shall be tested in three orthogonal positions.
- Exploratory tests performed to determined worst-case test configurations, the following test results at high power setting represent the worst-case.

5.4.4.1. Test Configuration 1: EUT with 1.72 dBi Chip Antenna

Fundamental Frequency:		2405 MHz					
Frequency Test Range:		30 MHz – 25 GHz					
Frequency (MHz)	RF Peak Level (dBµV/m)	RF Avg Level (dBµV/m)	Antenna Plane (H/V)	Limit 15.209 (dBµV/m)	Limit 15.247 (dBµV/m)	Margin (dB)	Pass/Fail
2405	114.13	--	V	--	--	--	--
2405	110.99	--	H	--	--	--	--
4810	56.68	46.39	V	54.0	94.1	-7.6	Pass*
4810	54.64	44.29	H	54.0	94.1	-9.7	Pass*

*Field strength of emissions appearing within restricted frequency bands shall not exceed the limits in § 15.209.

Fundamental Frequency:		2440 MHz					
Frequency Test Range:		30 MHz – 25 GHz					
Frequency (MHz)	RF Peak Level (dBµV/m)	RF Avg Level (dBµV/m)	Antenna Plane (H/V)	Limit 15.209 (dBµV/m)	Limit 15.247 (dBµV/m)	Margin (dB)	Pass/Fail
2440	115.61	--	V	--	--	--	--
2440	114.03	--	H	--	--	--	--
4880	52.12	41.43	V	54.0	95.6	-12.6	Pass*
4880	53.45	42.05	H	54.0	95.6	-12.0	Pass*

*Field strength of emissions appearing within restricted frequency bands shall not exceed the limits in § 15.209.

Fundamental Frequency:		2475 MHz					
Frequency Test Range:		30 MHz – 25 GHz					
Frequency (MHz)	RF Peak Level (dBµV/m)	RF Avg Level (dBµV/m)	Antenna Plane (H/V)	Limit 15.209 (dBµV/m)	Limit 15.247 (dBµV/m)	Margin (dB)	Pass/Fail
2475	113.45	--	V	--	--	--	--
2475	112.05	--	H	--	--	--	--
4950	50.97	40.53	V	54.0	93.5	-13.5	Pass*
4950	53.21	41.81	H	54.0	93.5	-12.2	Pass*

*Field strength of emissions appearing within restricted frequency bands shall not exceed the limits in § 15.209.

Fundamental Frequency:		2480 MHz					
Frequency Test Range:		30 MHz – 25 GHz					
Frequency (MHz)	RF Peak Level (dBµV/m)	RF Avg Level (dBµV/m)	Antenna Plane (H/V)	Limit 15.209 (dBµV/m)	Limit 15.247 (dBµV/m)	Margin (dB)	Pass/Fail
2480	110.23	--	V	--	--	--	--
2480	108.70	--	H	--	--	--	--
4960	51.28	40.04	V	54.0	90.2	-14.0	Pass*
4960	51.14	39.98	H	54.0	90.2	-14.0	Pass*

*Field strength of emissions appearing within restricted frequency bands shall not exceed the limits in § 15.209.

5.4.4.2. Test Configuration 2: EUT with 5 dBi Dipole Antenna

Fundamental Frequency:		2405 MHz					
Frequency Test Range:		30 MHz – 25 GHz					
Frequency (MHz)	RF Peak Level (dBµV/m)	RF Avg Level (dBµV/m)	Antenna Plane (H/V)	Limit 15.209 (dBµV/m)	Limit 15.247 (dBµV/m)	Margin (dB)	Pass/Fail
2405	116.58	--	V	--	--	--	--
2405	118.42	--	H	--	--	--	--
4810	58.91	48.59	V	54.0	98.4	-5.4	Pass*
4810	52.94	42.68	H	54.0	98.4	-11.3	Pass*

*Field strength of emissions appearing within restricted frequency bands shall not exceed the limits in § 15.209.

Fundamental Frequency:		2440 MHz					
Frequency Test Range:		30 MHz – 25 GHz					
Frequency (MHz)	RF Peak Level (dBµV/m)	RF Avg Level (dBµV/m)	Antenna Plane (H/V)	Limit 15.209 (dBµV/m)	Limit 15.247 (dBµV/m)	Margin (dB)	Pass/Fail
2440	117.86	--	V	--	--	--	--
2440	118.43	--	H	--	--	--	--
4880	56.65	46.39	V	54.0	98.4	-7.6	Pass*
4880	54.89	44.83	H	54.0	98.4	-9.2	Pass*

*Field strength of emissions appearing within restricted frequency bands shall not exceed the limits in § 15.209.

Fundamental Frequency:		2475 MHz					
Frequency Test Range:		30 MHz – 25 GHz					
Frequency (MHz)	RF Peak Level (dB μ V/m)	RF Avg Level (dB μ V/m)	Antenna Plane (H/V)	Limit 15.209 (dB μ V/m)	Limit 15.247 (dB μ V/m)	Margin (dB)	Pass/Fail
2475	117.19	--	V	--	--	--	--
2475	117.44	--	H	--	--	--	--
4950	55.78	45.21	V	54.0	97.4	-8.8	Pass*
4950	53.54	43.55	H	54.0	97.4	-10.5	Pass*

*Field strength of emissions appearing within restricted frequency bands shall not exceed the limits in § 15.209.

Fundamental Frequency:		2480 MHz					
Frequency Test Range:		30 MHz – 25 GHz					
Frequency (MHz)	RF Peak Level (dB μ V/m)	RF Avg Level (dB μ V/m)	Antenna Plane (H/V)	Limit 15.209 (dB μ V/m)	Limit 15.247 (dB μ V/m)	Margin (dB)	Pass/Fail
2480	107.98	--	V	--	--	--	--
2480	109.15	--	H	--	--	--	--
4960	49.46	36.31	V	54.0	89.2	-17.7	Pass*
4960	48.86	35.93	H	54.0	89.2	-18.1	Pass*

*Field strength of emissions appearing within restricted frequency bands shall not exceed the limits in § 15.209.

5.4.4.3. Band-Edge Radiated Emissions

Plot 5.4.4.3.1. Band-Edge Radiated Emissions, EUT with 1.72 dBi Chip Antenna, Lower Band-edge Rx Antenna in Vertical Polarization, O-QPSK Modulation, Power Setting 200, Ch 11, 2405 MHz

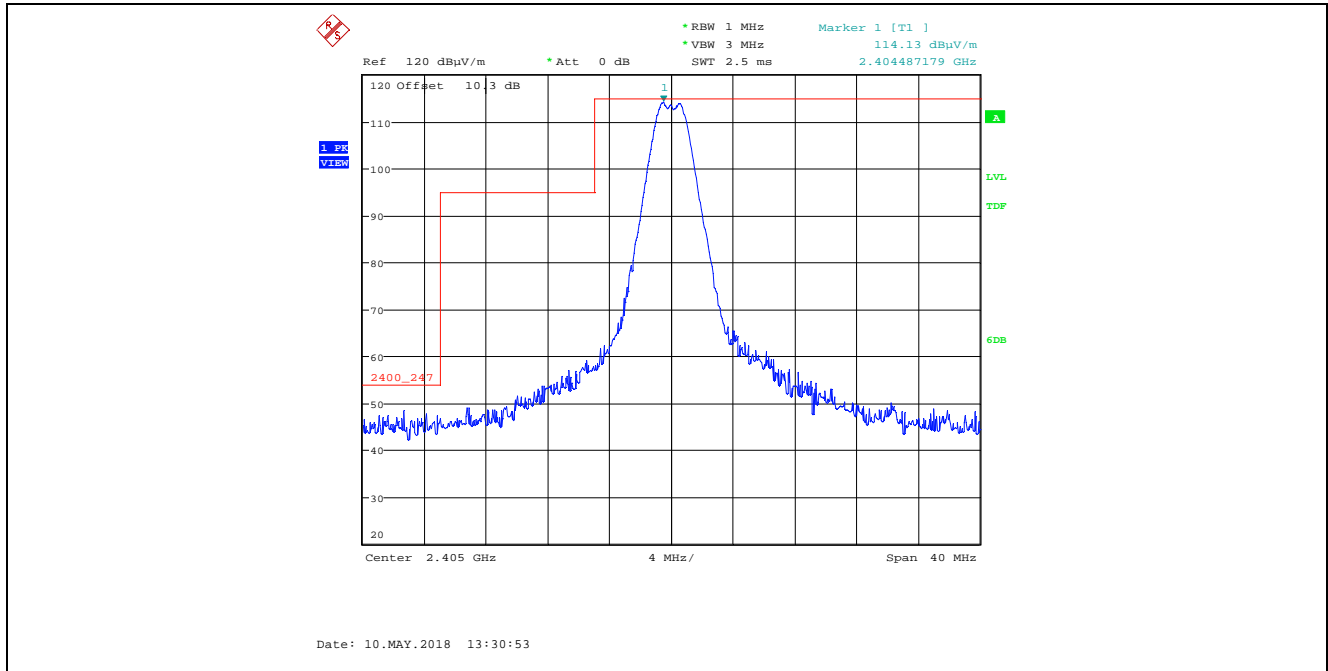

Plot 5.4.4.3.2. Band-Edge Radiated Emissions, EUT with 1.72 dBi Chip Antenna, Lower Band-edge Rx Antenna in Horizontal Polarization, O-QPSK Modulation, Power Setting 200, Ch 11, 2405 MHz

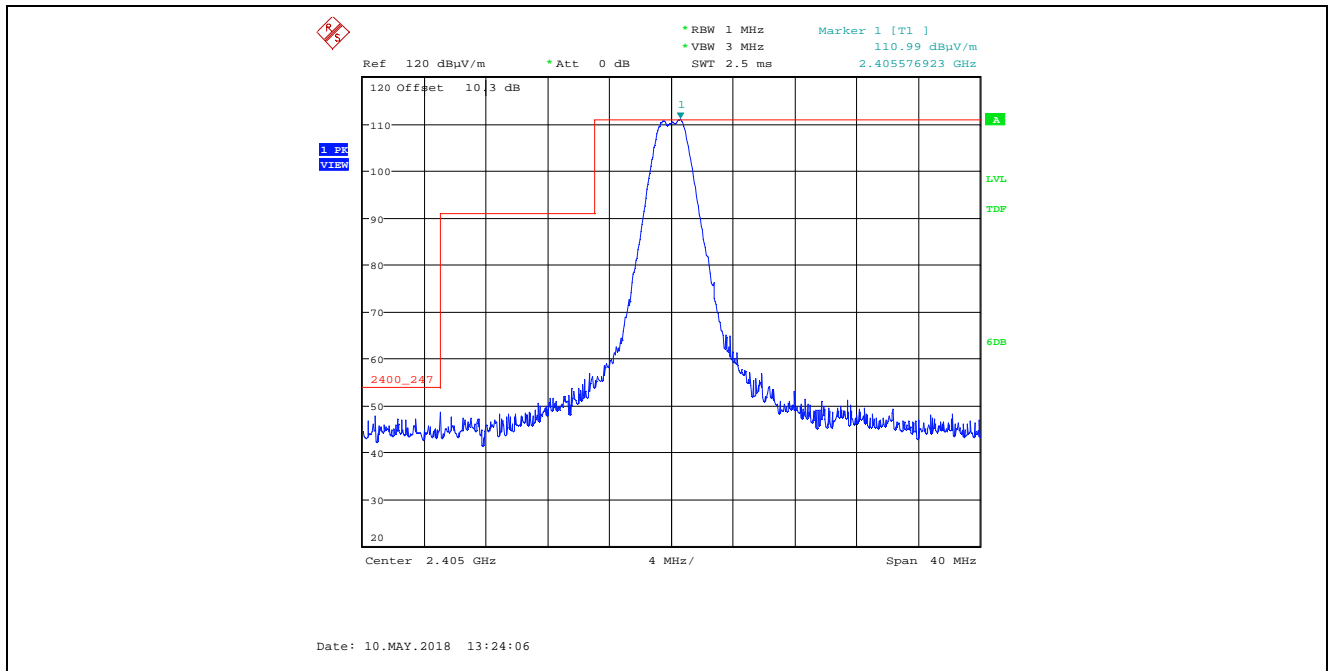

Plot 5.4.4.3.3. Band-Edge Radiated Emissions, EUT with 1.72 dBi Chip Antenna, Higher Band-edge Rx Antenna in Vertical Polarization, O-QPSK Modulation, Power Setting 200, Ch 25, 2475 MHz

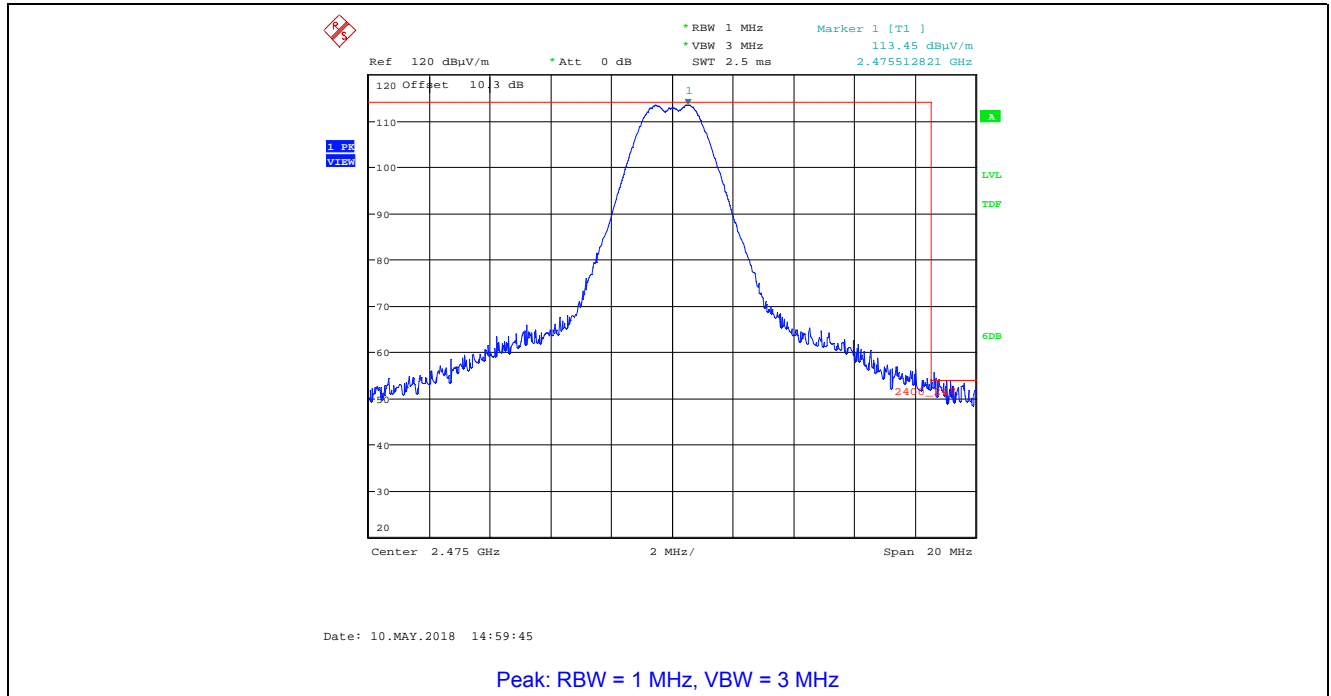

Plot 5.4.4.3.4. Band-Edge Radiated Emissions, EUT with 1.72 dBi Chip Antenna, Higher Band-edge Rx Antenna in Vertical Polarization, O-QPSK Modulation, Power Setting 200, Ch 25, 2475 MHz

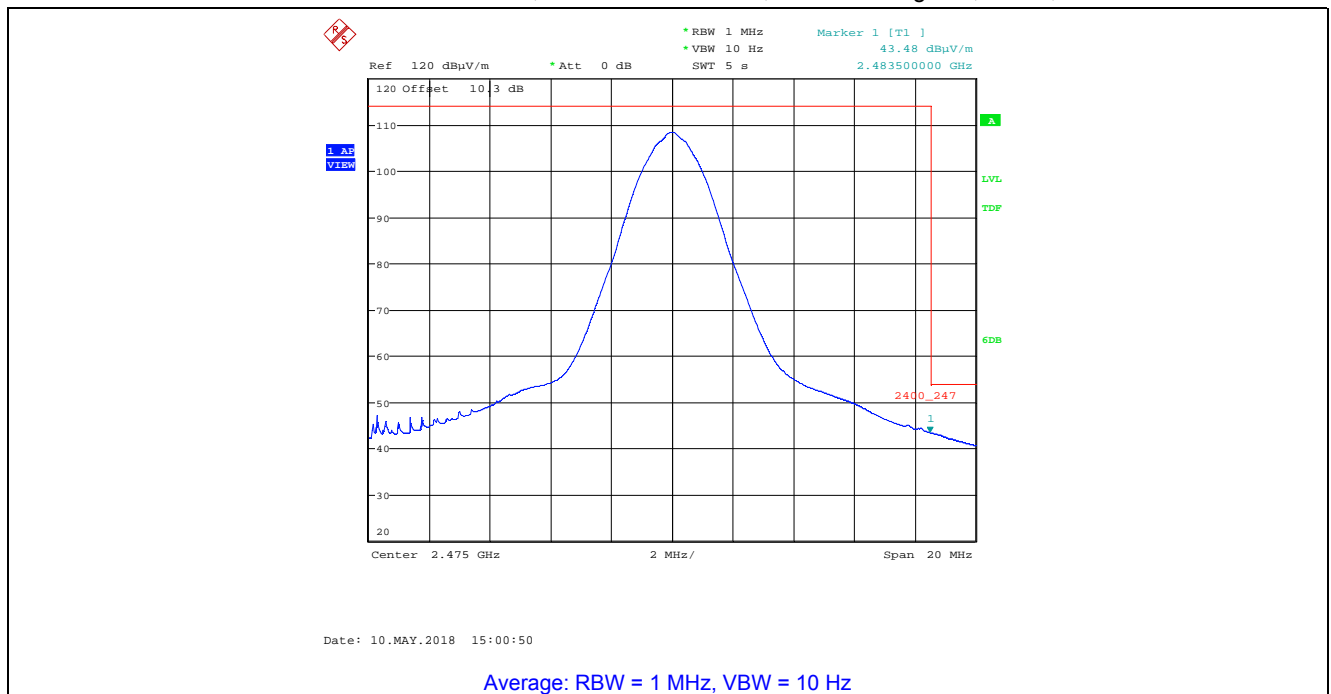

Plot 5.4.4.3.5. Band-Edge Radiated Emissions, EUT with 1.72 dBi Chip Antenna, Higher Band-edge Rx Antenna in Horizontal Polarization, O-QPSK Modulation, Power Setting 200, Ch 25, 2475 MHz

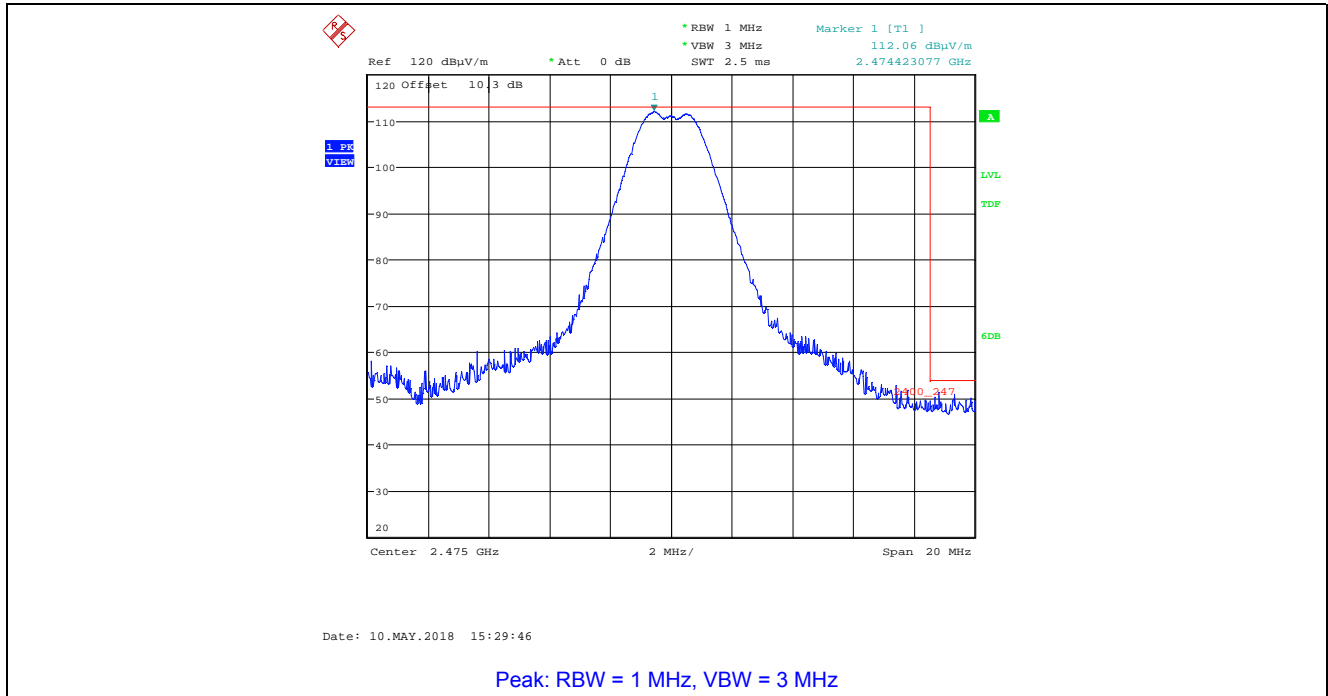

Plot 5.4.4.3.6. Band-Edge Radiated Emissions, EUT with 1.72 dBi Chip Antenna, Higher Band-edge Rx Antenna in Horizontal Polarization, O-QPSK Modulation, Power Setting 200, Ch 25, 2475 MHz

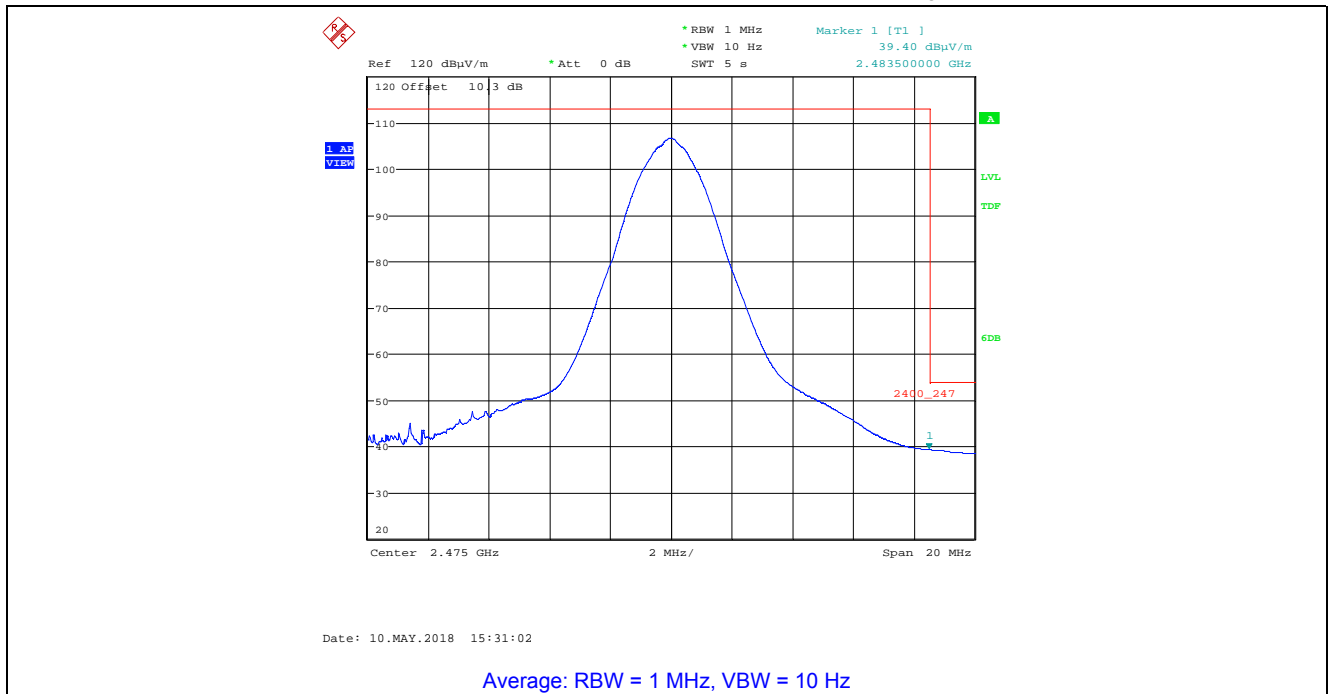

Plot 5.4.4.3.7. Band-Edge Radiated Emissions, EUT with 1.72 dBi Chip Antenna, Higher Band-edge Rx Antenna in Vertical Polarization, O-QPSK Modulation, Power Setting 160, Ch 26, 2480 MHz

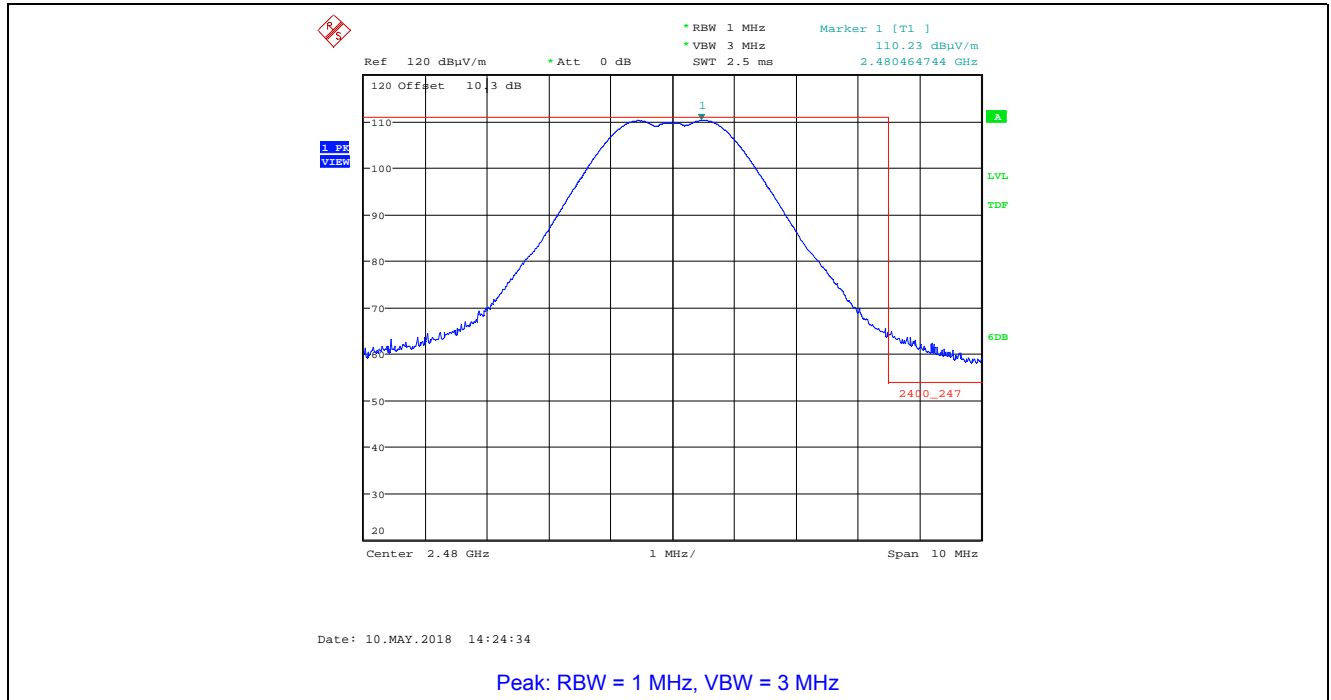

Plot 5.4.4.3.8. Band-Edge Radiated Emissions, EUT with 1.72 dBi Chip Antenna, Higher Band-edge Rx Antenna in Vertical Polarization, O-QPSK Modulation, Power Setting 160, Ch 26, 2480 MHz

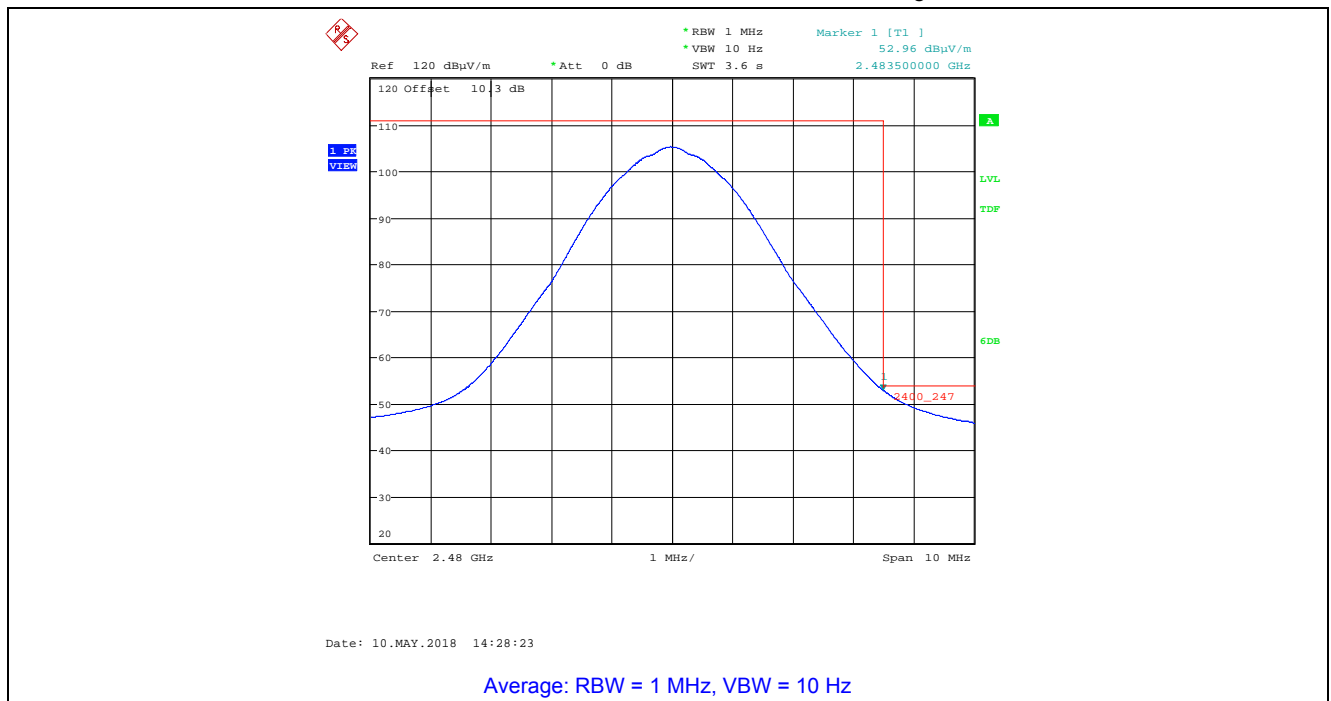

Plot 5.4.4.3.9. Band-Edge Radiated Emissions, EUT with 1.72 dBi Chip Antenna, Higher Band-edge Rx Antenna in Horizontal Polarization, O-QPSK Modulation, Power Setting 160, Ch 26, 2480 MHz

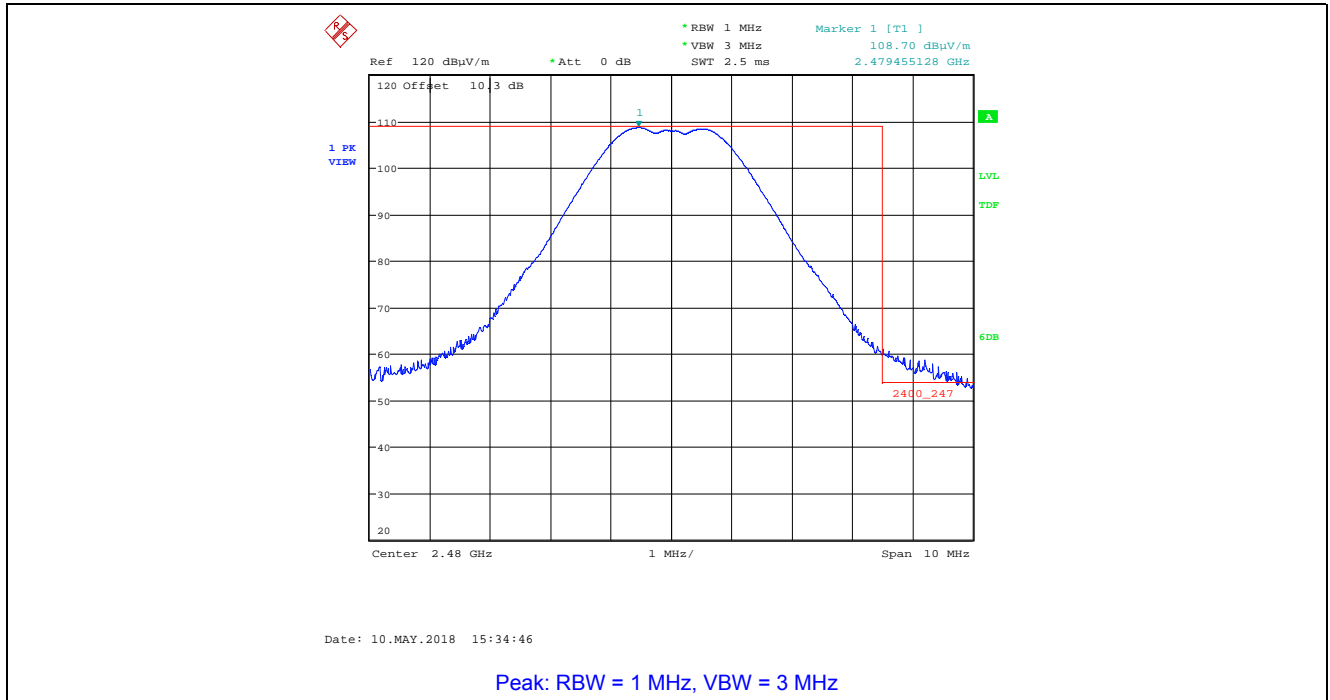

Plot 5.4.4.3.10. Band-Edge Radiated Emissions, EUT with 1.72 dBi Chip Antenna, Higher Band-edge Rx Antenna in Horizontal Polarization, O-QPSK Modulation, Power Setting 160, Ch 26, 2480 MHz

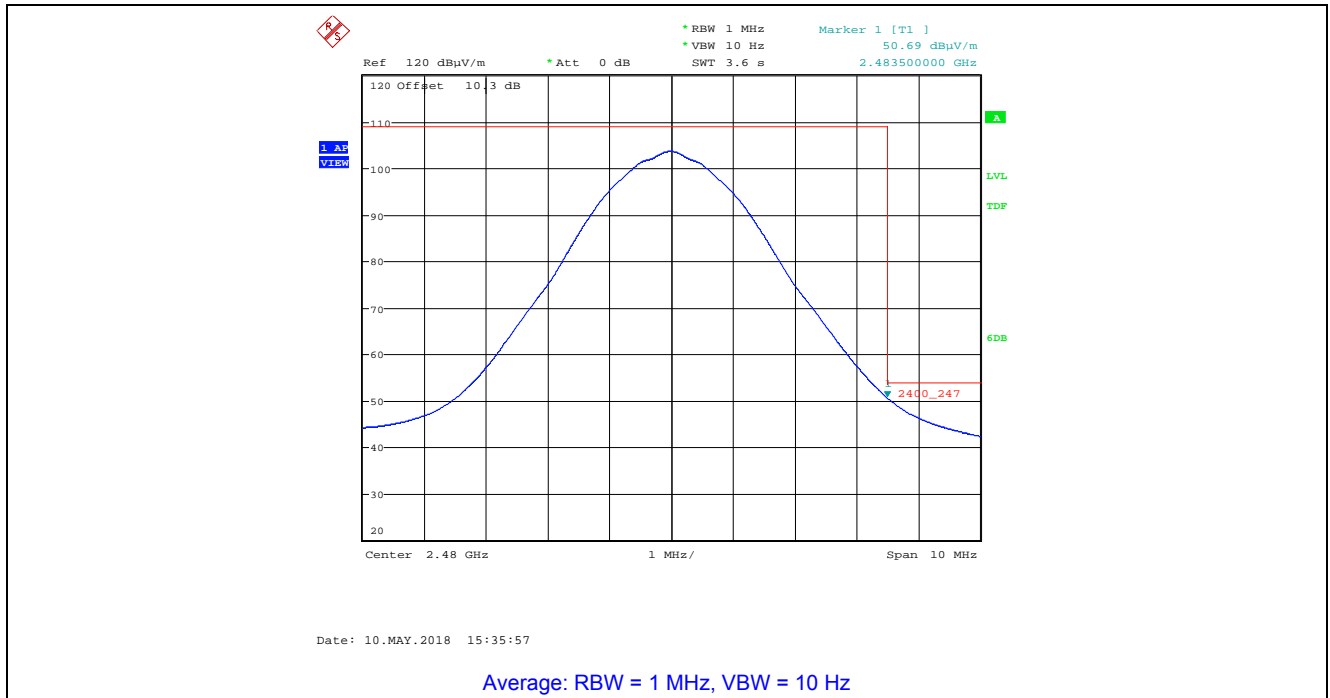

Plot 5.4.4.3.11. Band-Edge Radiated Emissions, EUT with 5 dBi Dipole Antenna, Lower Band-edge Rx Antenna in Vertical Polarization, O-QPSK Modulation, Power Setting 200, Ch 11, 2405 MHz

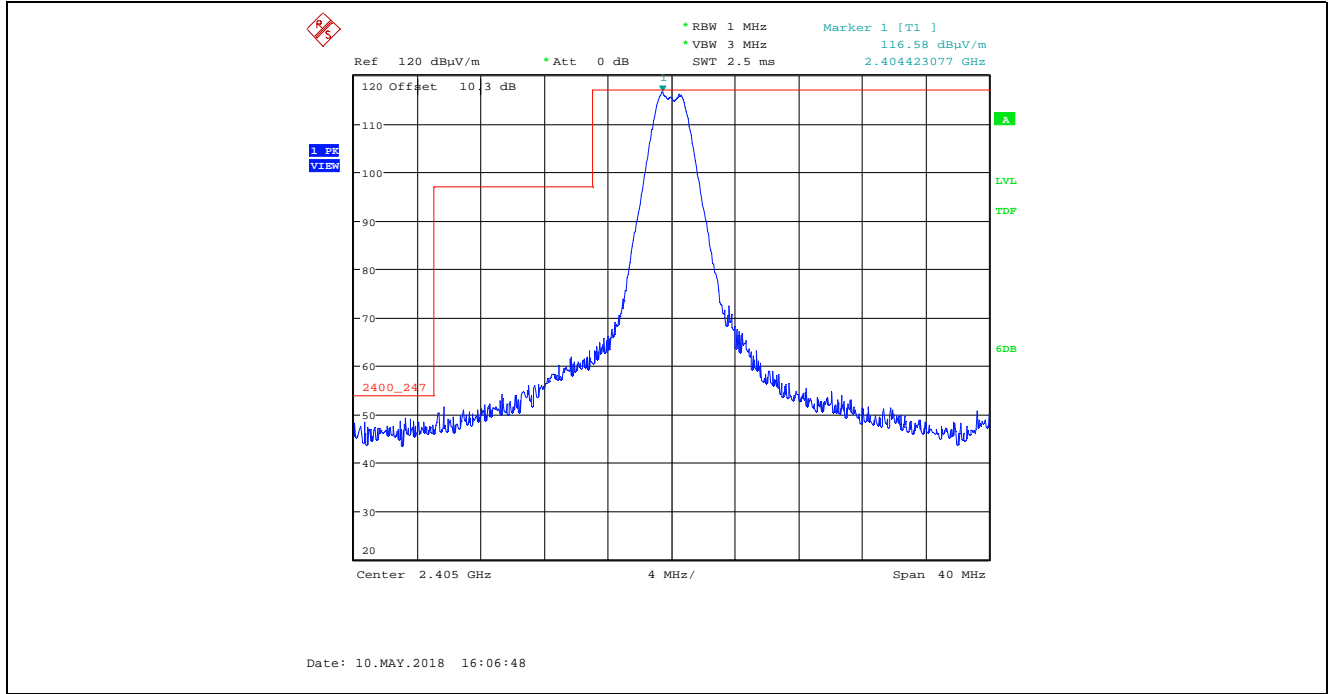

Plot 5.4.4.3.12. Band-Edge Radiated Emissions, EUT with 5 dBi Dipole Antenna, Lower Band-edge Rx Antenna in Horizontal Polarization, O-QPSK Modulation, Power Setting 200, Ch 11, 2405 MHz

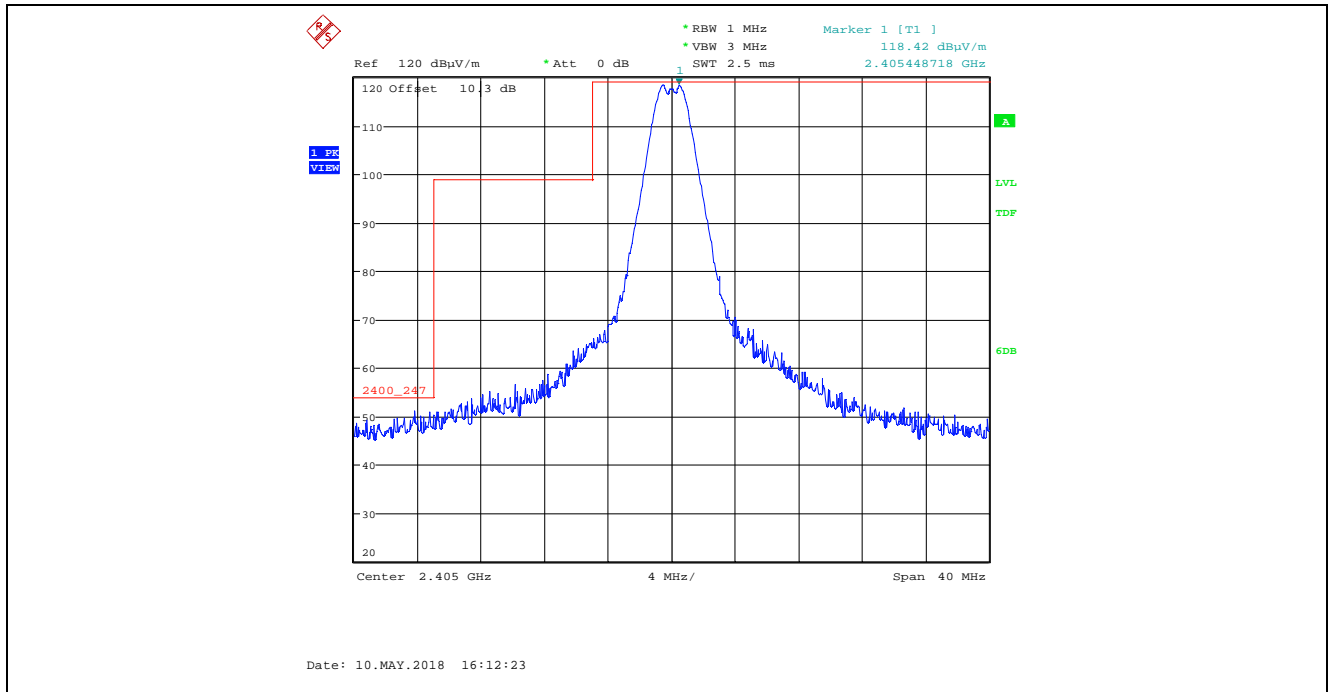

Plot 5.4.4.3.13. Band-Edge Radiated Emissions, EUT with 5 dBi Dipole Antenna, Higher Band-edge Rx Antenna in Vertical Polarization, O-QPSK Modulation, Power Setting 200, Ch 25, 2475 MHz

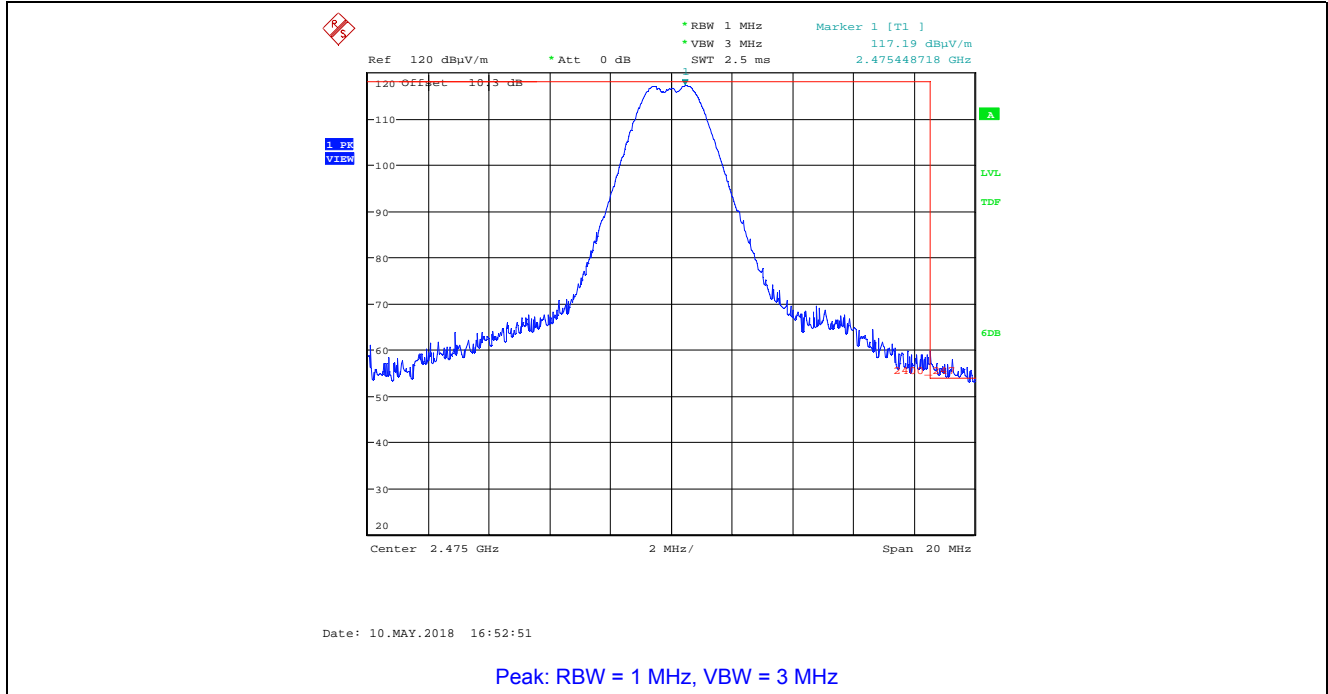

Plot 5.4.4.3.14. Band-Edge Radiated Emissions, EUT with 5 dBi Dipole Antenna, Higher Band-edge Rx Antenna in Vertical Polarization, O-QPSK Modulation, Power Setting 200, Ch 25, 2475 MHz

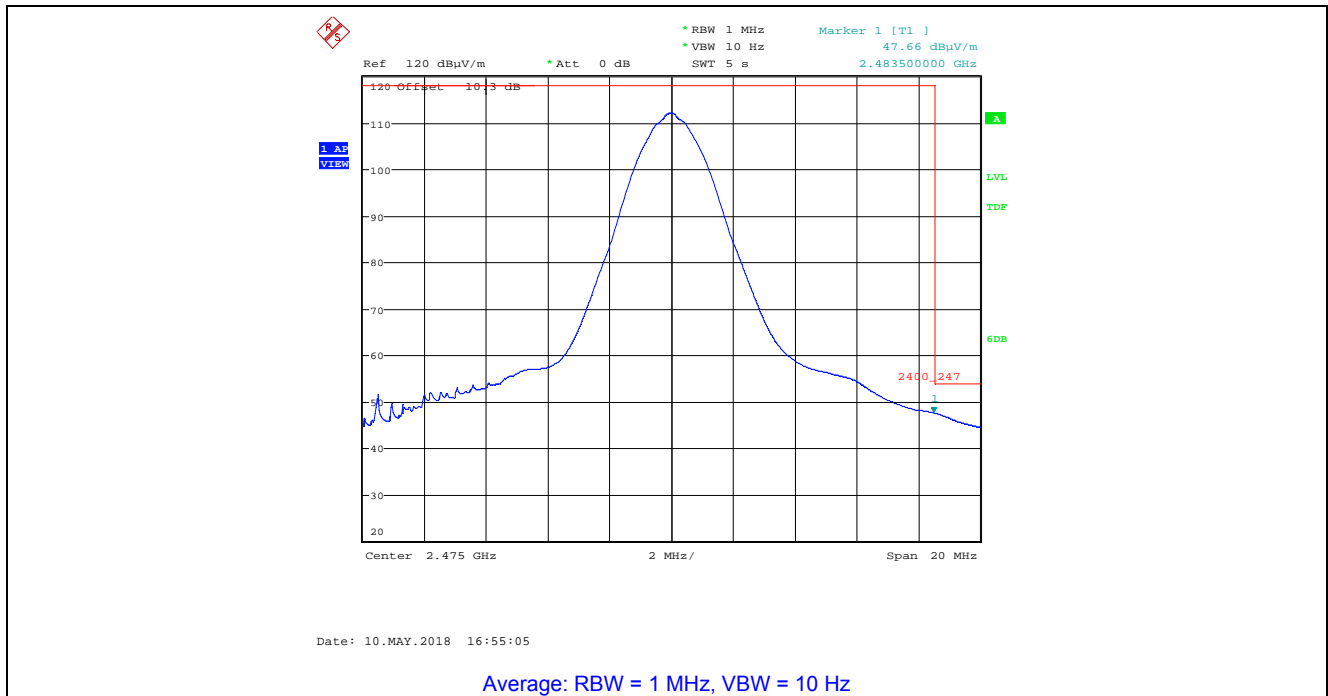

Plot 5.4.4.3.15. Band-Edge Radiated Emissions, EUT with 5 dBi Dipole Antenna, Higher Band-edge Rx Antenna in Horizontal Polarization, O-QPSK Modulation, Power Setting 200, Ch 25, 2475 MHz

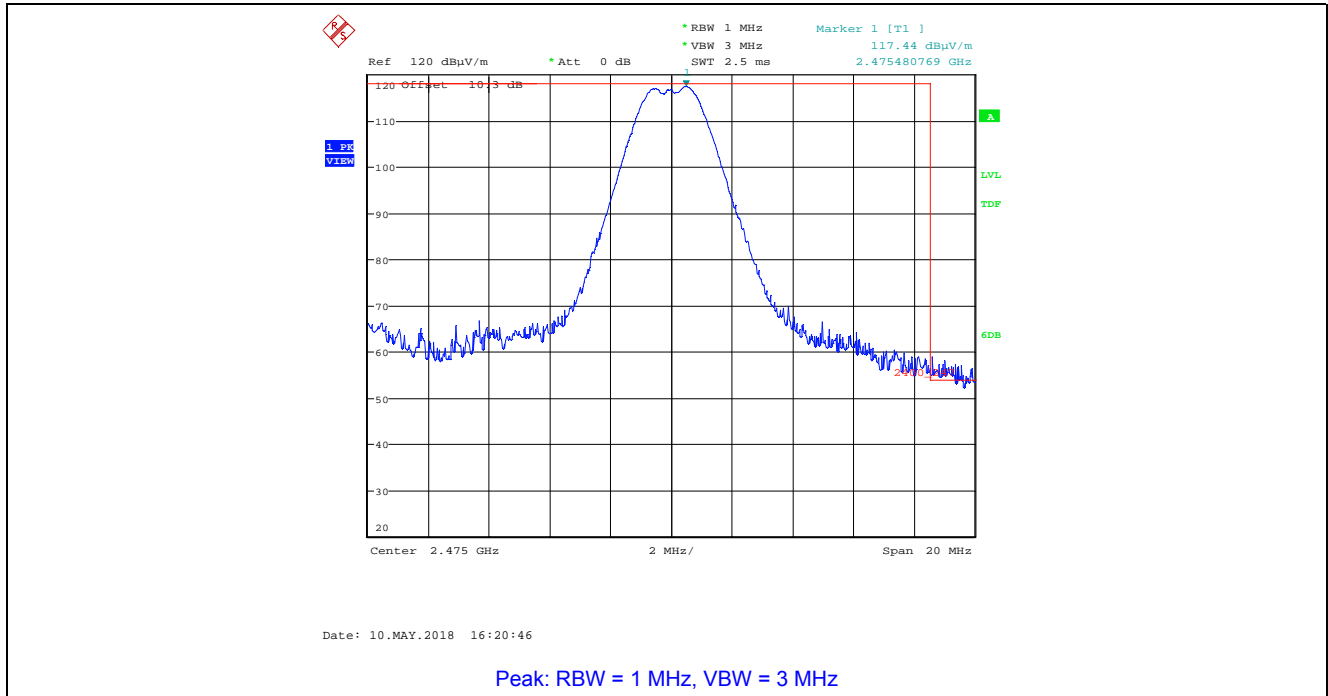

Plot 5.4.4.3.16. Band-Edge Radiated Emissions, EUT with 5 dBi Dipole Antenna, Higher Band-edge Rx Antenna in Horizontal Polarization, O-QPSK Modulation, Power Setting 200, Ch 25, 2475 MHz

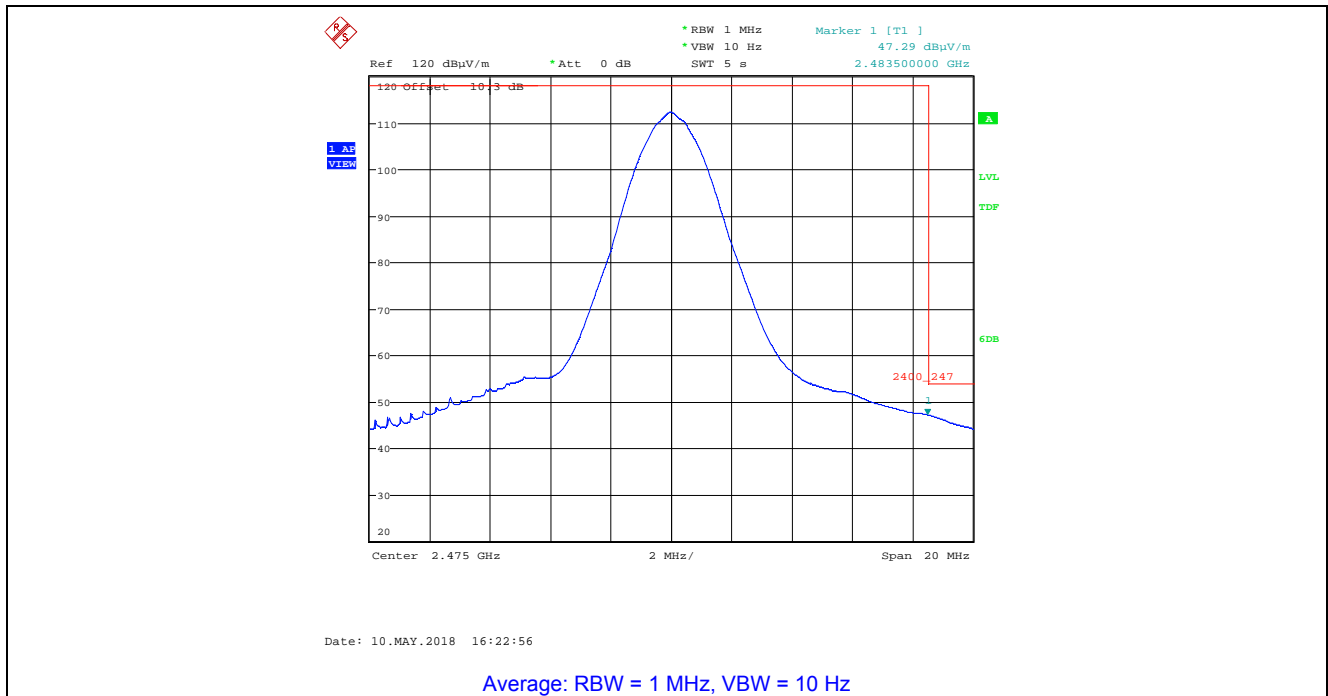

Plot 5.4.4.3.17. Band-Edge Radiated Emissions, EUT with 5 dBi Dipole Antenna, Higher Band-edge
Rx Antenna in Vertical Polarization, O-QPSK Modulation, Power Setting 100, Ch 26, 2480 MHz

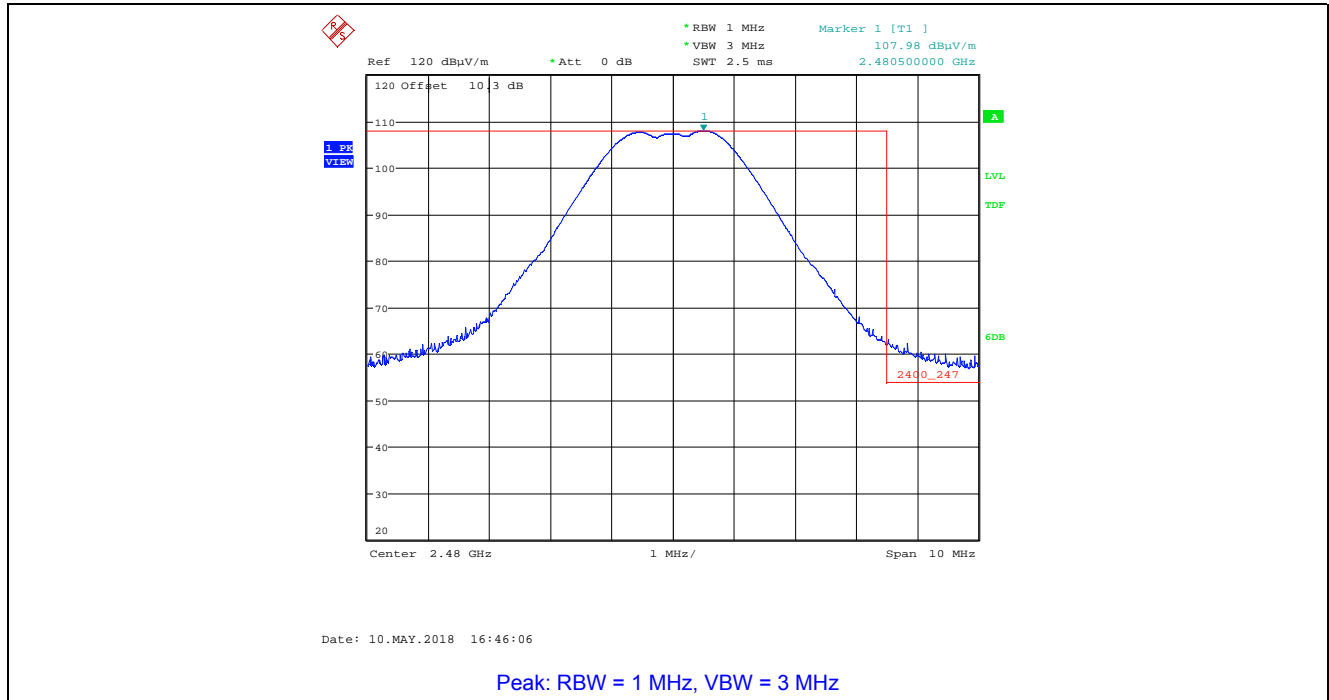

Plot 5.4.4.3.18. Band-Edge Radiated Emissions, EUT with 5 dBi Dipole Antenna, Higher Band-edge
Rx Antenna in Vertical Polarization, O-QPSK Modulation, Power Setting 100, Ch 26, 2480 MHz

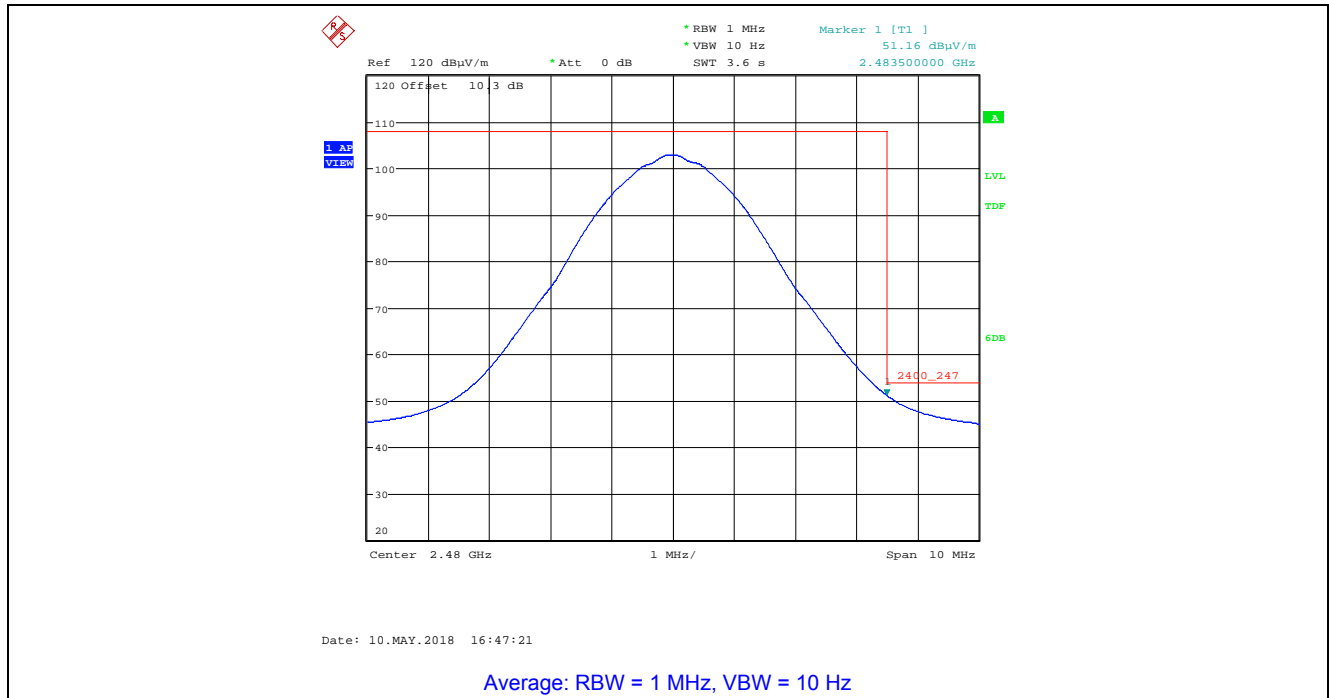

Plot 5.4.4.3.19. Band-Edge Radiated Emissions, EUT with 5 dBi Dipole Antenna, Higher Band-edge Rx Antenna in Horizontal Polarization, O-QPSK Modulation, Power Setting 100, Ch 26, 2480 MHz

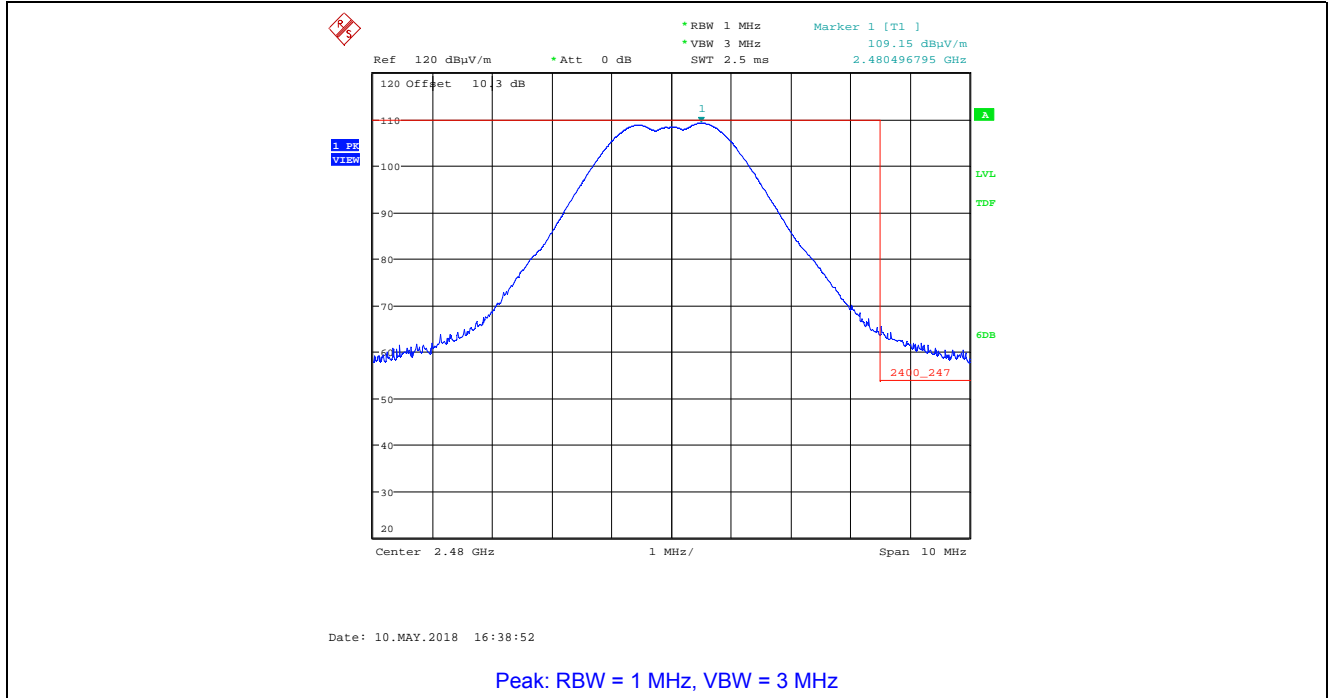

Plot 5.4.4.3.20. Band-Edge Radiated Emissions, EUT with 5 dBi Dipole Antenna, Higher Band-edge Rx Antenna in Horizontal Polarization, O-QPSK Modulation, Power Setting 100, Ch 26, 2480 MHz

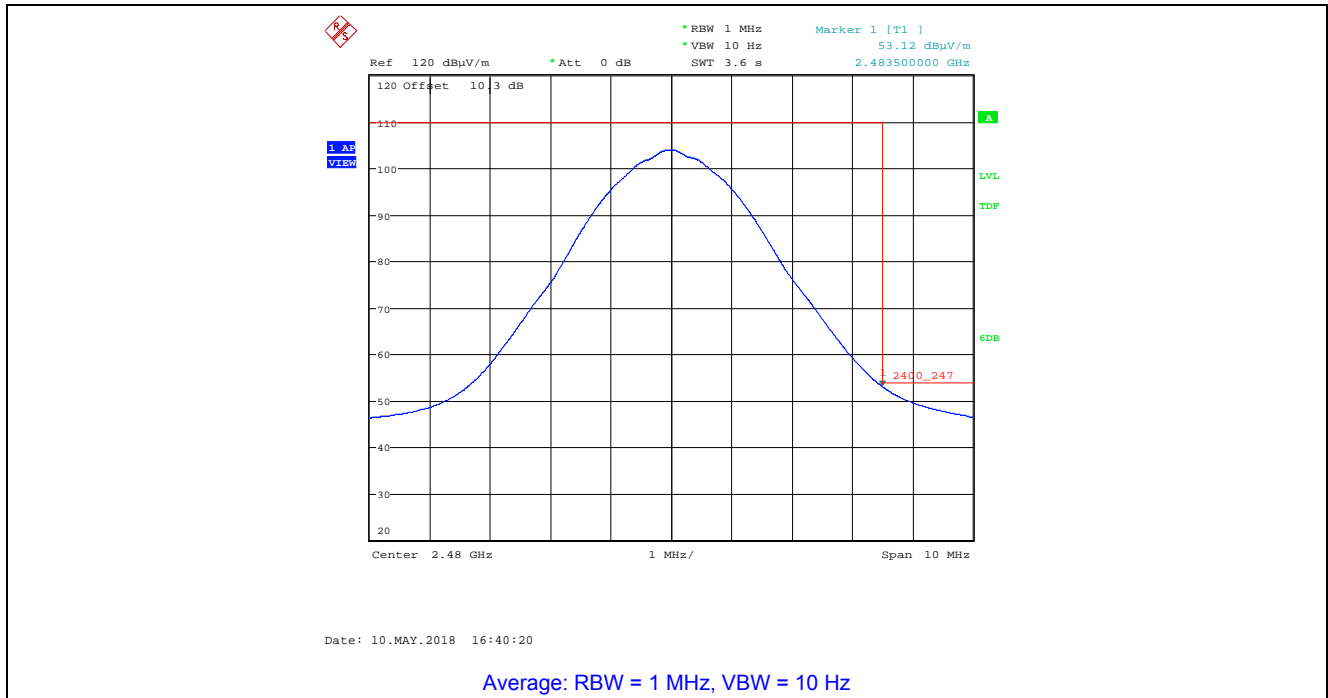

5.5. POWER SPECTRAL DENSITY [§ 15.247(e)]

5.5.1. Limit(s)

For digitally modulated systems, the power spectral density conducted from the intentional radiator to the antenna shall not be greater than 8 dBm in any 3 kHz band during any time interval of continuous transmission.

5.5.2. Method of Measurements

KDB 558074 D01 DTS Meas Guidance V04, Section 10.2 Method PKPSD (peak PSD)

5.5.3. Test Arrangement

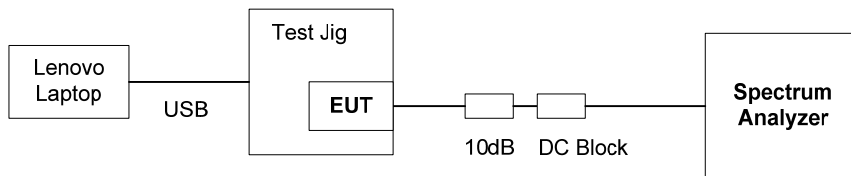

USB provide 5 Vdc and software to operate radio module

5.5.4. Test Data

Modulation	Power Setting	Channel	Frequency (MHz)	PSD (dBm)	Max. Limit (dBm)	Margin (dBm)
O-QPSK	200	11	2405	4.33	8	-3.67
		18	2440	4.13	8	-3.87
		25	2475	4.10	8	-3.90
	160	26	2480	-1.23	8	-9.23

Plot 5.5.4.1. Power Spectral Density, O-QPSK Modulation, Power Setting 200, Channel 11, 2405 MHz

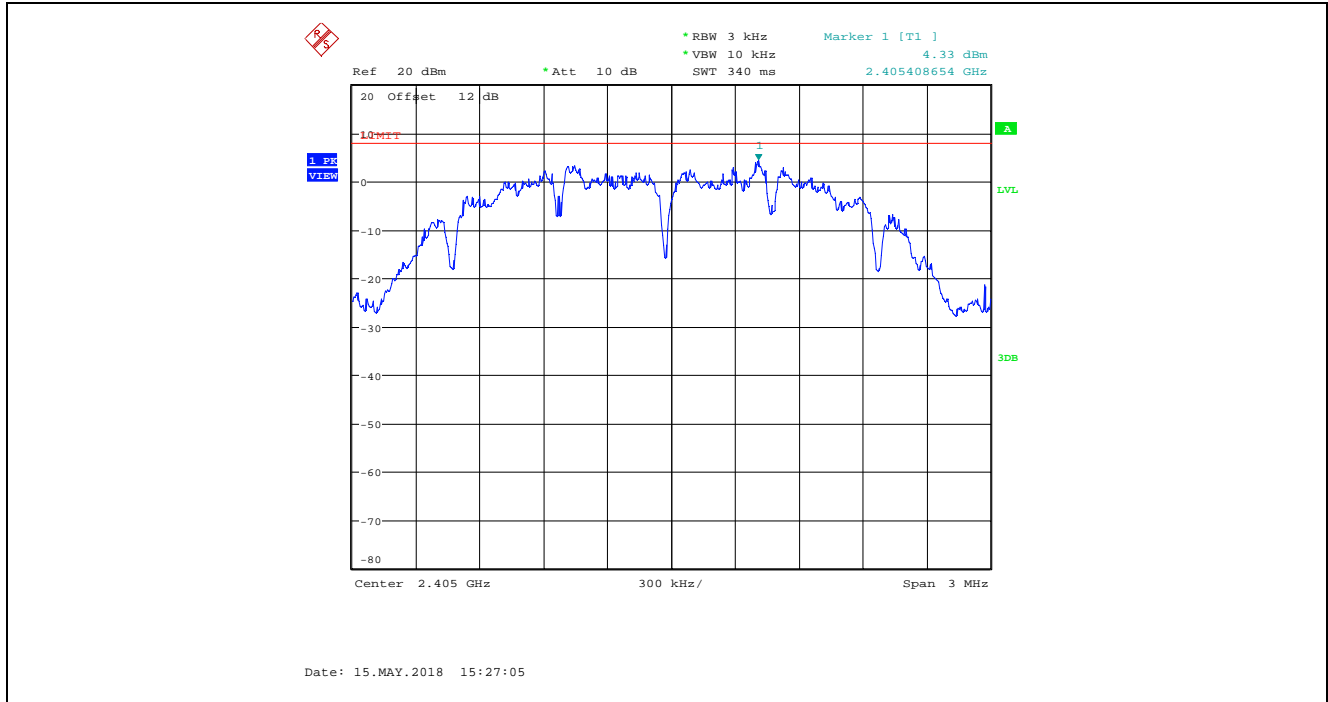

Plot 5.5.4.2. Power Spectral Density, O-QPSK Modulation, Power Setting 200, Channel 18, 2440 MHz

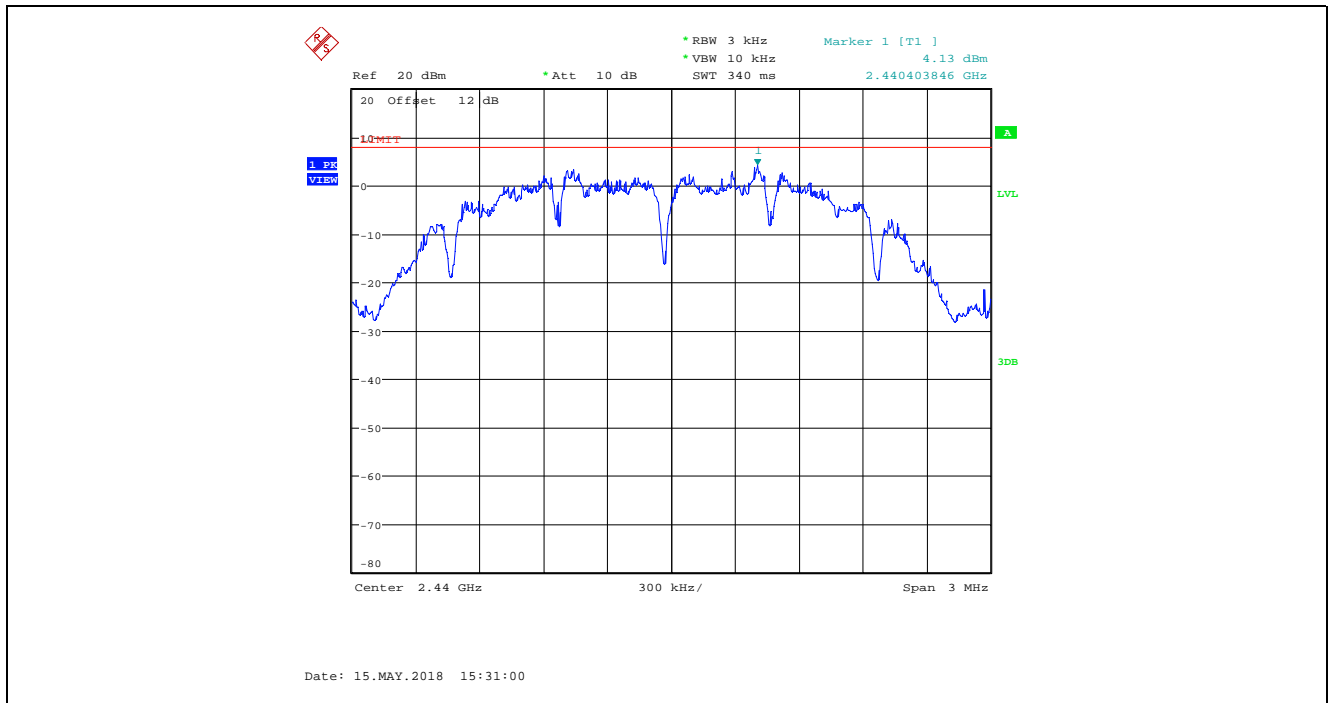

Plot 5.5.4.3. Power Spectral Density, O-QPSK Modulation, Power Setting 200, Channel 25, 2475 MHz

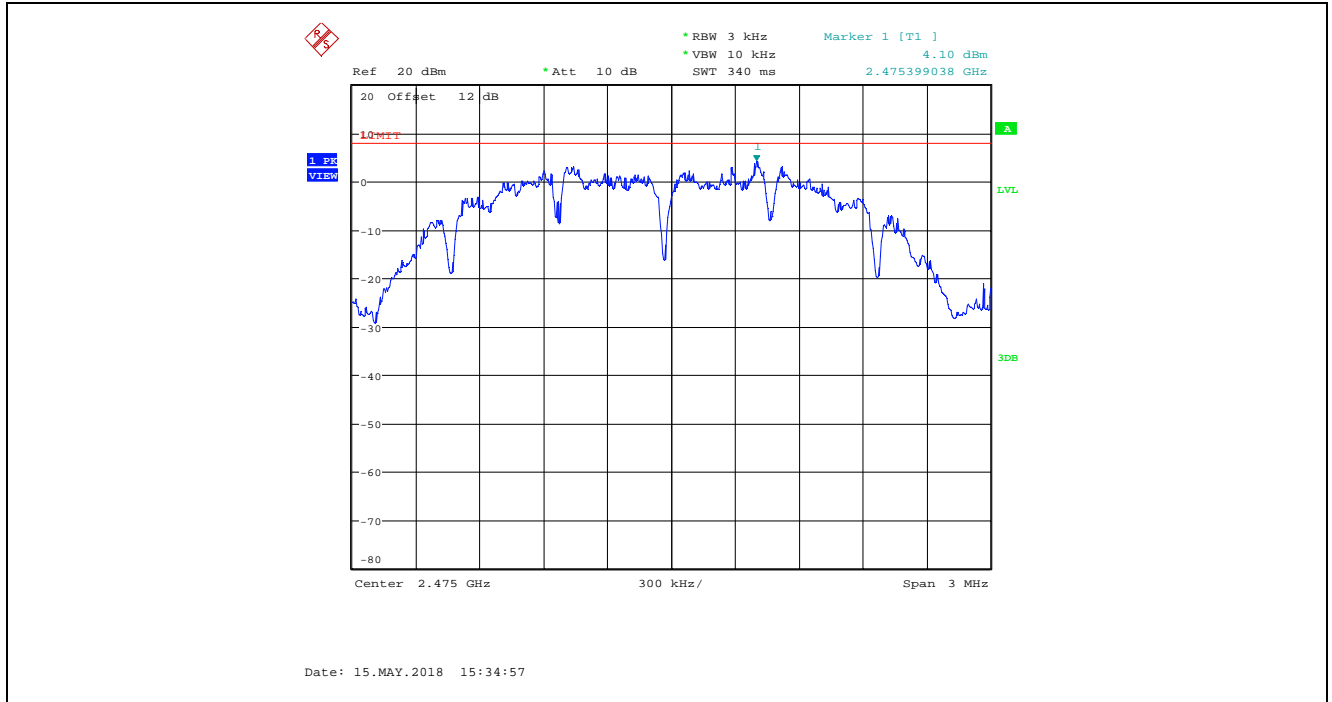

Plot 5.5.4.4. Power Spectral Density, O-QPSK Modulation, Power Setting 160, Channel 26, 2480 MHz

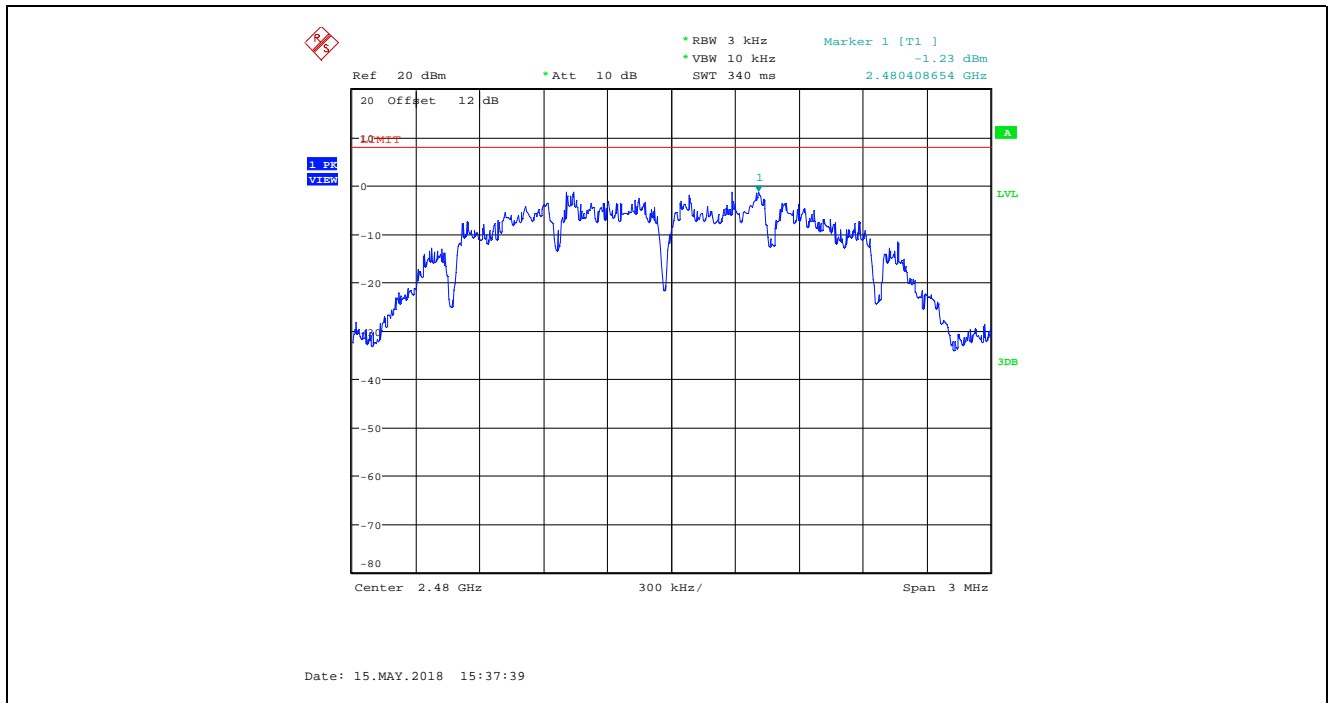

5.6. RF EXPOSURE REQUIRMENTS [§§ 15.247(i), 1.1310 & 2.1091]

5.6.1. Limits

§ 1.1310: The criteria listed in the following table shall be used to evaluate the environmental impact of human exposure to radio-frequency (RF) radiation as specified in 1.1307(b).

Limits for Maximum Permissible Exposure (MPE)

Frequency range (MHz)	Electric field strength (V/m)	Magnetic field strength (A/m)	Power density (mW/cm ²)	Averaging time (minutes)
(A) Limits for Occupational/Controlled Exposures				
0.3-3.0	614	1.63	*(100)	6
3.0-30	1842/f	4.89/f	*(900/f ²)	6
30-300	61.4	0.163	1.0	6
300-1500			f/300	6
1500-100,000			5	6
(B) Limits for General Population/Uncontrolled Exposure				
0.3-1.34	614	1.63	*(100)	30
1.34-30	824/f	2.19/f	*(180/f ²)	30
30-300	27.5	0.073	0.2	30
300-1500			f/1500	30
1500-100,000			1.0	30

f = frequency in MHz

* = Plane-wave equivalent power density

Note 1: Occupational/controlled limits apply in situations in which persons are exposed as a consequence of their employment provided those persons are fully aware of the potential for exposure and can exercise control over their exposure. Limits for occupational/controlled exposure also apply in situations when an individual is transient through a location where occupational/controlled limits apply provided he or she is made aware of the potential for exposure.

Note 2: General population/uncontrolled exposures apply in situations in which the general public may be exposed, or in which persons that are exposed as a consequence of their employment may not be fully aware of the potential for exposure or can not exercise control over their exposure.

5.6.2. Method of Measurements

Calculation Method of Power Density/RF Safety Distance:

$$S = \frac{PG}{4\pi \cdot r^2} = \frac{EIRP}{4\pi \cdot r^2}$$

Where,

P: power input to the antenna in mW

EIRP: Equivalent (effective) isotropic radiated power.

S: power density mW/cm²

G: numeric gain of antenna relative to isotropic radiator

r: distance to centre of radiation in cm

5.6.3. RF Evaluation

Frequency (MHz)	EIRP (dBm)	EIRP (mW)	Evaluation Distance, r (cm)	Power Density, S (mW/cm ²)	MPE Limit (mW/cm ²)	Margin (mW/cm ²)
2405	24.77	299.916	20	0.06	1.0	-0.94

EXHIBIT 6. TEST EQUIPMENT LIST

Test Instruments	Manufacturer	Model No.	Serial No.	Frequency Range	Cal. Due Date
Spectrum Analyzer	Agilent	E7405A	US39440181	9 kHz–26.5 GHz	04 Feb 2019
Attenuator	Pasternack	PE7010-20	ATT13	DC–2 GHz	21 Mar 2019
LISN Used	EMCO	3825/2R	1165	10 kHz–30 MHz	03 Nov 2018
AC Adapter	Lenovo	02P1160	---	Output 20V	---
Spectrum Analyzer	Rohde & Schwarz	FSU26	200946	20Hz–26.5 GHz	21 Jul 2018
Attenuator	Hewlett Packard	8493C	0465	DC–18 GHz	See Note 1
DC Block	Hewlett Packard	11742A	12460	0.045 – 26.5 GHz	See Note 1
Laptop	Lenovo	R61e	---	---	---
RF Amplifier	Hewlett Packard	84498	3008A00769	1 – 26.5 GHz	04 Oct 2018
Attenuator	Pasternack	PE7024-10	4	DC–26.5 GHz	See Note 1
Horn Antenna	EMCO	3155	6570	1 – 18 GHz	13 Oct 2018
EMI Receiver	Rohde & Schwarz	ESU40	100037	20Hz–40 GHz	04 May 2019
RF Amplifier	Com-Power	PAM-0118A	551052	0.5 – 18 GHz	17 Jul 2018
Biconilog	EMCO	3142C	00026873	26-3000 MHz	27 Apr 2020
Horn Antenna	ETS-Lindgren	3160-09	001183858	18 – 26.5 GHz	11 Oct 2018
High Pass Filter	K & L	11SH10-4000/T12000	4	Cut off 2.4 GHz	See Note 1
Band Reject Filter	Micro-Tronics	BRM50701	105	Cut off 2.4-2.483 GHz	See Note 1
Note 1: Internal Verification/Calibration check					

EXHIBIT 7. MEASUREMENT UNCERTAINTY

The measurement uncertainties stated were calculated in accordance with the requirements of CISPR 16-4-2 @ IEC:2003 and JCGM 100:2008 (GUM 1995) – Guide to the Expression of Uncertainty in Measurement.

7.1. LINE CONDUCTED EMISSION MEASUREMENT UNCERTAINTY

	Line Conducted Emission Measurement Uncertainty (9 kHz – 30 MHz):	Measured	Limit
u_c	Combined standard uncertainty: $u_c(y) = \sqrt{\sum_{i=1}^m u_i^2(y)}$	± 1.44	± 1.8
U	Expanded uncertainty U: U = 2u _c (y)	± 2.89	± 3.6

7.2. RADIATED EMISSION MEASUREMENT UNCERTAINTY

	Radiated Emission Measurement Uncertainty @ 3m, Horizontal (30-1000 MHz):	Measured (dB)	Limit (dB)
u_c	Combined standard uncertainty: $u_c(y) = \sqrt{\sum_{i=1}^m u_i^2(y)}$	± 2.39	± 2.6
U	Expanded uncertainty U: U = 2u _c (y)	± 4.79	± 5.2

	Radiated Emission Measurement Uncertainty @ 3m, Vertical (30-1000 MHz):	Measured (dB)	Limit (dB)
u_c	Combined standard uncertainty: $u_c(y) = \sqrt{\sum_{i=1}^m u_i^2(y)}$	± 2.39	± 2.6
U	Expanded uncertainty U: U = 2u _c (y)	± 4.78	± 5.2

	Radiated Emission Measurement Uncertainty @ 3 m, Horizontal & Vertical (1 – 18 GHz):	Measured (dB)	Limit (dB)
u_c	Combined standard uncertainty: $u_c(y) = \sqrt{\sum_{i=1}^m u_i^2(y)}$	± 1.87	Under consideration
U	Expanded uncertainty U: U = 2u _c (y)	± 3.75	Under consideration