

# ENGINEERING TEST REPORT

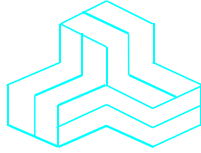

**ZigBee/Thread/BLE Module**  
**Model(s): CSB04PA10-CHP, CSB04PA10-RFC, CSB04PA11-CHP, CSB04PA11-RFC**  
**FCC ID: XFF-CSB04PA1X**

*Applicant:*

**MMB Research Inc.**  
243 College St, Suite 500  
Toronto, ON M5T 1R5  
Canada

*In Accordance With*

**Federal Communications Commission (FCC)**  
**Part 15, Subpart C, Section 15.247**  
**Digital Modulation Systems (DTS) Operating in 2400 – 2483.5 MHz Band**

**UltraTech's File No.: 18MMBN001\_FCC15C247B**

This Test report is Issued under the Authority of  
Tri M. Luu  
Vice President of Engineering  
UltraTech Group of Labs

Date: July 18, 2018

Report Prepared by: Dan Huynh

Tested by: Hung Trinh

Issued Date: July 18, 2018

Test Dates: June 5, 6, 11, 12 & 29, 2018

- *The results in this Test Report apply only to the sample(s) tested, and the sample tested is randomly selected.*
- *This report must not be used by the client to claim product endorsement by any agency of the US Government.*
- *This test report shall not be reproduced, except in full, without a written approval from UltraTech*

## UltraTech

3000 Bristol Circle, Oakville, Ontario, Canada L6H 6G4  
Tel.: (905) 829-1570 Fax.: (905) 829-8050  
Website: [www.ultratech-labs.com](http://www.ultratech-labs.com), Email: [vic@ultratech-labs.com](mailto:vic@ultratech-labs.com), Email: [tri@ultratech-labs.com](mailto:tri@ultratech-labs.com)



91038



1309



46390-2049



AT-1945



SL2-IN-E-1119R



CA2049

TABLE OF CONTENTS

EXHIBIT 1. INTRODUCTION..... 1
1.1. SCOPE ..... 1
1.2. RELATED SUBMITTAL(S)/GRANT(S) ..... 1
1.3. NORMATIVE REFERENCES ..... 1
EXHIBIT 2. PERFORMANCE ASSESSMENT ..... 2
2.1. CLIENT INFORMATION ..... 2
2.2. EQUIPMENT UNDER TEST (EUT) INFORMATION ..... 2
2.3. EUT'S TECHNICAL SPECIFICATIONS..... 3
2.4. ASSOCIATED ANTENNA DESCRIPTIONS ..... 3
2.5. LIST OF EUT'S PORTS..... 3
2.6. ANCILLARY EQUIPMENT ..... 3
EXHIBIT 3. EUT OPERATING CONDITIONS AND CONFIGURATIONS DURING TESTS ..... 4
3.1. CLIMATE TEST CONDITIONS ..... 4
3.2. OPERATIONAL TEST CONDITIONS & ARRANGEMENT FOR TESTS..... 4
EXHIBIT 4. SUMMARY OF TEST RESULTS..... 5
4.1. LOCATION OF TESTS ..... 5
4.2. APPLICABILITY & SUMMARY OF EMC EMISSION TEST RESULTS ..... 5
4.3. MODIFICATIONS INCORPORATED IN THE EUT FOR COMPLIANCE PURPOSES ..... 5
EXHIBIT 5. TEST DATA ..... 6
5.1. POWER LINE CONDUCTED EMISSIONS [§15.207(a)]..... 6
5.2. OCCUPIED BANDWIDTH [§ 15.247(a)(2)]..... 11
5.3. PEAK CONDUCTED OUTPUT POWER - DTS [§ 15.247(b)(3)] ..... 15
5.4. TRANSMITTER SPURIOUS RADIATED EMISSIONS AT 3 METERS [§§ 15.247(d), 15.209 & 15.205] ..... 25
5.5. POWER SPECTRAL DENSITY [§ 15.247(e)] ..... 44
5.6. RF EXPOSURE REQUIRMENTS [§§ 15.247(i), 1.1310 & 2.1091]..... 48
EXHIBIT 6. TEST EQUIPMENT LIST ..... 50
EXHIBIT 7. MEASUREMENT UNCERTAINTY ..... 51
7.1. LINE CONDUCTED EMISSION MEASUREMENT UNCERTAINTY ..... 51
7.2. RADIATED EMISSION MEASUREMENT UNCERTAINTY ..... 51

**EXHIBIT 1. INTRODUCTION****1.1. SCOPE**

<b>Reference:</b>	FCC Part 15, Subpart C, Section 15.247
<b>Title:</b>	Code of Federal Regulations (CFR), Title 47 – Telecommunication, Part 15 – Radio Frequency Devices
<b>Purpose of Test:</b>	Equipment Certification for Digital Modulation Systems (DTS) Operating Under §15.247
<b>Test Procedures:</b>	<ul style="list-style-type: none"> <li>▪ ANSI C63.4</li> <li>▪ ANSI C63.10</li> <li>▪ FCC KDB Publication No. 558074 D01 DTS Meas Guidance v04</li> </ul>
<b>Environmental Classification:</b>	<input checked="" type="checkbox"/> Commercial, industrial or business environment <input checked="" type="checkbox"/> Residential environment

**1.2. RELATED SUBMITTAL(S)/GRANT(S)**

None.

**1.3. NORMATIVE REFERENCES**

Publication	Year	Title
47 CFR Parts 0-19	2018	Code of Federal Regulations (CFR), Title 47 – Telecommunication
ANSI C63.4	2014	American National Standard for Methods of Measurement of Radio-Noise Emissions from Low-Voltage Electrical and Electronic Equipment in the Range of 9 KHz to 40 GHz
ANSI C63.10	2013	American National Standard of Procedures for Compliance Testing of Unlicensed Wireless Devices
FCC, KDB Publication No. 558074 D01 DTS Meas Guidance v04	2017	Guidance for Performing Compliance Measurements for Digital Transmission Systems (DTS) Operating Under Section 15.247

**EXHIBIT 2. PERFORMANCE ASSESSMENT**

**2.1. CLIENT INFORMATION**

<b>Applicant</b>	
<b>Name:</b>	MMB Research Inc.
<b>Address:</b>	243 College St, Suite 500 Toronto, ON M5T 1R5 Canada
<b>Contact Person:</b>	Hussein Nagji Phone #: 416-636-3145 x237 Fax #: n/a Email Address: hussein.nagji@mmbnetworks.com

<b>Manufacturer</b>	
<b>Name:</b>	MMB Research Inc.
<b>Address:</b>	243 College St, Suite 500 Toronto, ON M5T 1R5 Canada
<b>Contact Person:</b>	Hussein Nagji Phone #: 416-636-3145 x237 Fax #: n/a Email Address: hussein.nagji@mmbnetworks.com

**2.2. EQUIPMENT UNDER TEST (EUT) INFORMATION**

The following information (with the exception of the Date of Receipt) has been supplied by the applicant.

<b>Brand Name:</b>	MMB Research Inc.
<b>Product Name:</b>	ZigBee/Thread/BLE Module
<b>*Model(s):</b>	19.5 dBm Variant: <ul style="list-style-type: none"> <li>• CSB04PA10-CHP (with chip antenna)</li> <li>• CSB04PA10-RFC (with a U.FL connector)</li> </ul> 10 dBm Variant: <ul style="list-style-type: none"> <li>• CSB04PA11-CHP (with chip antenna)</li> <li>• CSB04PA11-RFC (with a U.FL connector)</li> </ul>
<b>Serial Number:</b>	Test Sample
<b>Type of Equipment:</b>	Digital Transmission System (DTS)
<b>Input Power Supply Type:</b>	External DC Power Supply
<b>Primary User Functions of EUT:</b>	ZigBee/Thread/BLE Module

\*Both variants have identical HW and output power is limited via software.

**2.3. EUT’S TECHNICAL SPECIFICATIONS**

<b>Transmitter</b>	
<b>Equipment Type:</b>	Mobile Base station (fixed use)
<b>Intended Operating Environment:</b>	Commercial, industrial or business environment Residential environment
<b>Power Supply Requirement:</b>	3.3 VDC
<b>RF Output Power Rating:</b>	10 dBm to 19.5 dBm
<b>Operating Frequency Range:</b>	2402 - 2480 MHz (for 1 Mbps) 2404 - 2478 MHz (for 2 Mbps)
<b>RF Output Impedance:</b>	50 Ω
<b>Duty Cycle:</b>	Continuous
<b>Modulation Type:</b>	GFSK
<b>Antenna Connector Types:</b>	Integral antenna or U.FL

**2.4. ASSOCIATED ANTENNA DESCRIPTIONS**

<b>Antenna Type</b>	<b>Manufacturer</b>	<b>Model</b>	<b>Maximum Gain (dBi)</b>
Integral Chip Antenna	Inpaq	ACA-2012-A1-CC-S	1.72
Dipole Antenna	Mag-Layers Scientific-Technics Co. Ltd.	EDA-1713-2G4C1-A2	5

**2.5. LIST OF EUT’S PORTS**

<b>Port Number</b>	<b>EUT’s Port Description</b>	<b>Number of Identical Ports</b>	<b>Connector Type</b>	<b>Cable Type (Shielded/Non-shielded)</b>
1	RF port	1	Integral antenna or U.FL	Shielded cable (N/A for integral antenna)
2	GPIO	1	Pins	Direct connection (no cable)

**2.6. ANCILLARY EQUIPMENT**

The EUT was tested while connected to the following representative configuration of ancillary equipment necessary to exercise the ports during tests:

<b>Ancillary Equipment # 1</b>	
Description:	Test Jig
Brand name:	MMB Research Inc.
Model Name or Number:	BSB03PA10-DM1
Serial Number:	N/A
Connected to EUT’s Port:	Module pin signals

**EXHIBIT 3. EUT OPERATING CONDITIONS AND CONFIGURATIONS DURING TESTS**

**3.1. CLIMATE TEST CONDITIONS**

The climate conditions of the test environment are as follows:

Temperature:	21 to 23 °C
Humidity:	45 to 58%
Pressure:	102 kPa
Power Input Source:	3.3 VDC

**3.2. OPERATIONAL TEST CONDITIONS & ARRANGEMENT FOR TESTS**

<b>Operating Modes:</b>	The transmitter was operated in a continuous transmission mode with the carrier modulated as specified in the Test Data.
<b>Special Test Software:</b>	Test software provided by the Applicant to operate the EUT at each channel frequency continuously and in the range of typical modes of operation.
<b>Special Hardware Used:</b>	Test Jig
<b>Transmitter Test Antenna:</b>	The EUT is tested with the antenna fitted in a manner typical of normal intended use as integral / non-integral antenna equipment as described with the test results.

<b>Transmitter Test Signals</b>	
<b>Frequency Band(s):</b>	1 Mbps: 2402 - 2480 MHz 2 Mbps: 2404 - 2478 MHz
<b>Frequency(ies) Tested:</b>	1 Mbps: 2402 MHz, 2440 MHz, 2478 MHz, 2480 MHz 2 Mbps: 2404 MHz, 2440 MHz, 2478 MHz
<b>RF Power Output:</b> (measured maximum output power at antenna terminals)	19.32 dBm Peak
<b>Normal Test Modulation:</b>	GFSK
<b>Modulating Signal Source:</b>	Internal

**EXHIBIT 4. SUMMARY OF TEST RESULTS**

**4.1. LOCATION OF TESTS**

All of the measurements described in this report were performed at Ultratech Group of Labs located in the city of Oakville, Province of Ontario, Canada.

- AC Power Line Conducted Emissions were performed in UltraTech's shielded room, 24'(L) by 16'(W) by 8'(H).
- Radiated Emissions were performed at the Ultratech's 3-10 TDK Semi-Anechoic Chamber situated in the Town of Oakville, province of Ontario. This test site been calibrated in accordance with ANSI C63.4, and found to be in compliance with the requirements of Sec. 2.948 of the FCC Rules. The descriptions and site measurement data of the Oakville 3-10 TDK Semi-Anechoic Chamber has been filed with ANAB File No.: AT-1945.

**4.2. APPLICABILITY & SUMMARY OF EMC EMISSION TEST RESULTS**

FCC Section(s)	Test Requirements	Compliance (Yes/No)
15.203	Antenna requirements	Yes*
15.207(a)	AC Power Line Conducted Emissions	Yes
15.247(a)(2)	6 dB Bandwidth	Yes
15.247(b)(3)	Peak Conducted Output Power	Yes
15.247(d)	Band-Edge and RF Conducted Spurious Emissions at the Transmitter Antenna Terminal	Yes
15.247(d), 15.209 & 15.205	Transmitter Spurious Radiated Emissions	Yes
15.247(e)	Power Spectral Density	Yes
15.247(i), 1.1307, 1.1310, 2.1091	RF Exposure	Yes

\* The EUT complies with the requirement; it employs a unique (non-standard) antenna connector or integral antenna.

**4.3. MODIFICATIONS INCORPORATED IN THE EUT FOR COMPLIANCE PURPOSES**

None.

**EXHIBIT 5. TEST DATA**

**5.1. POWER LINE CONDUCTED EMISSIONS [§15.207(a)]**

**5.1.1. Limit(s)**

The equipment shall meet the limits of the following table:

Frequency of emission (MHz)	Conducted Limits (dBμV)	
	Quasi-peak	Average
0.15–0.5 .....	66 to 56* .....	56 to 46*
0.5–5 .....	56 .....	46
5–30 .....	60 .....	50

\*Decreases linearly with the logarithm of the frequency

**5.1.2. Method of Measurements**

ANSI C63.4

**5.1.3. Test Arrangement**

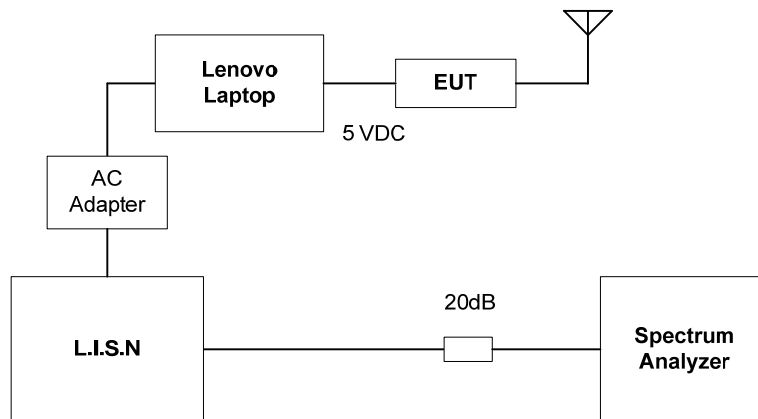



5.1.4. Test Data

Plot 5.1.4.1. Power Line Conducted Emissions (Tx Mode)  
Line Voltage: 120 VAC; Line Tested: Hot

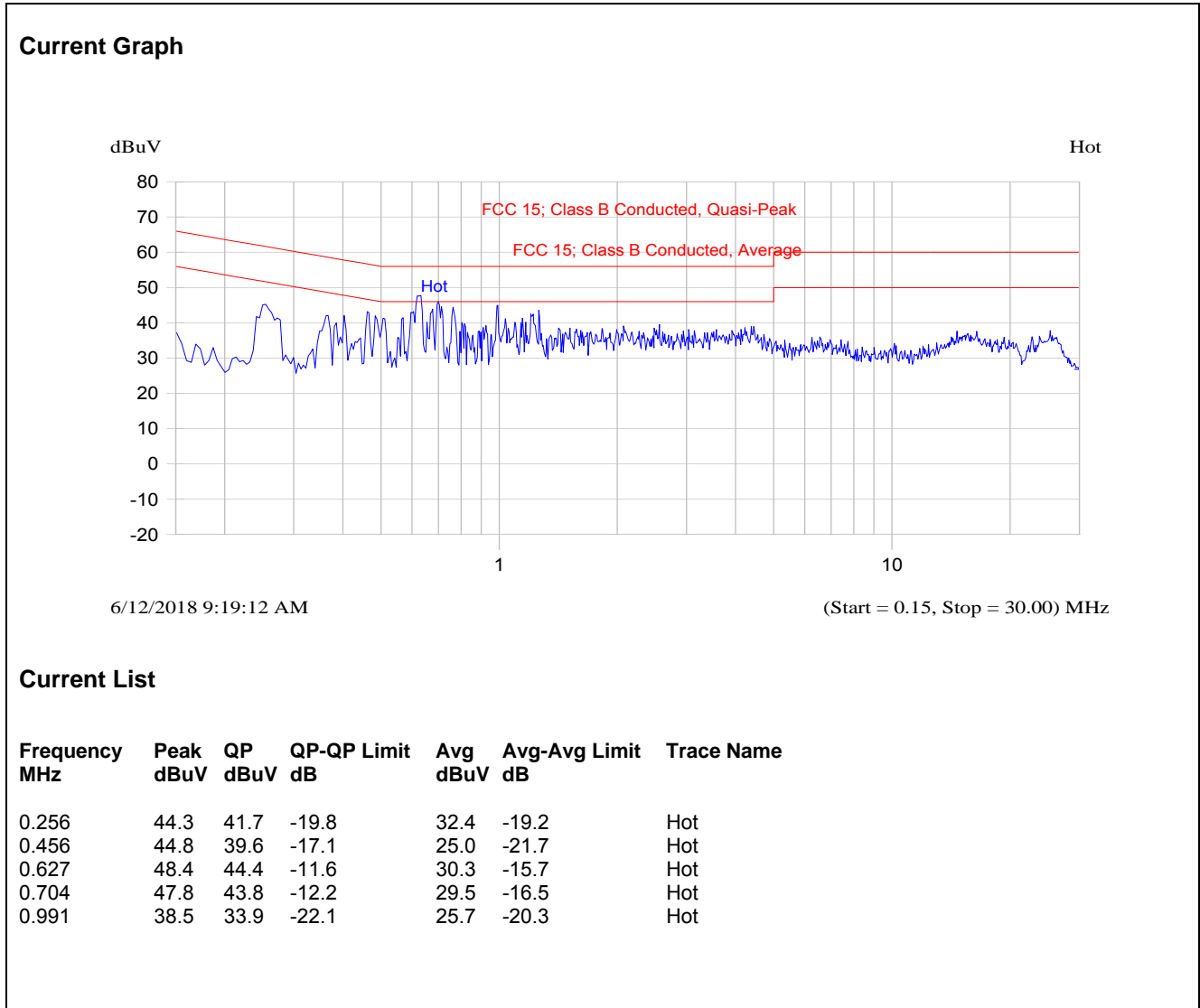

**Plot 5.1.4.2. Power Line Conducted Emissions (Tx Mode)**  
 Line Voltage: 120 VAC Line Tested: Neutral

**Current Graph**

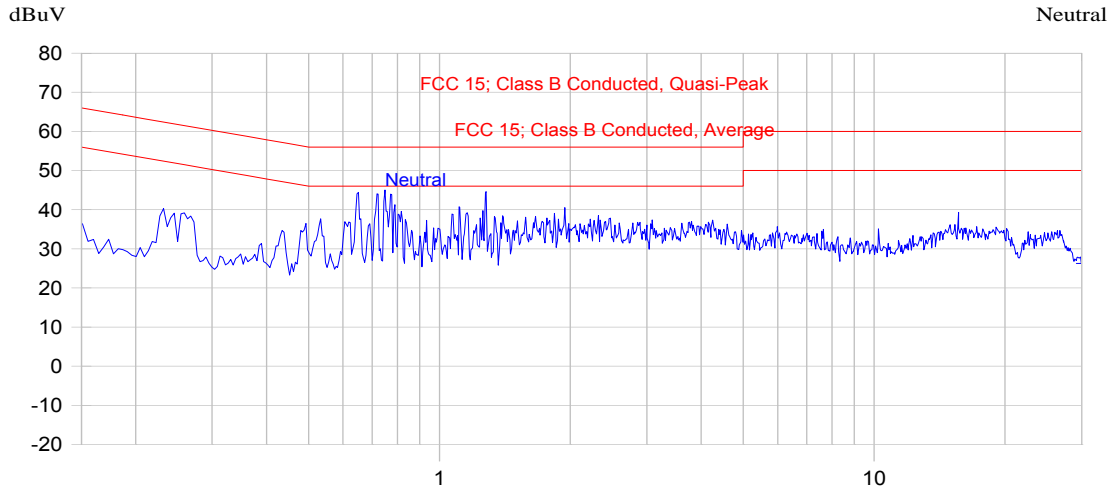

6/12/2018 9:30:06 AM

(Start = 0.15, Stop = 30.00) MHz

**Current List**

Frequency MHz	Peak dBuV	QP dBuV	QP-QP Limit dB	Avg dBuV	Avg-Avg Limit dB	Trace Name
0.232	42.7	39.5	-22.9	27.0	-25.4	Neutral
0.647	45.1	42.3	-13.7	29.4	-16.6	Neutral
0.749	46.5	42.5	-13.5	27.1	-18.9	Neutral
1.284	45.3	41.8	-14.2	28.1	-17.9	Neutral
15.619	38.5	31.3	-28.7	24.8	-25.2	Neutral

**Plot 5.1.4.3. Power Line Conducted Emissions (Rx Mode)**  
 Line Voltage: 120 VAC; Line Tested: Hot

**Current Graph**

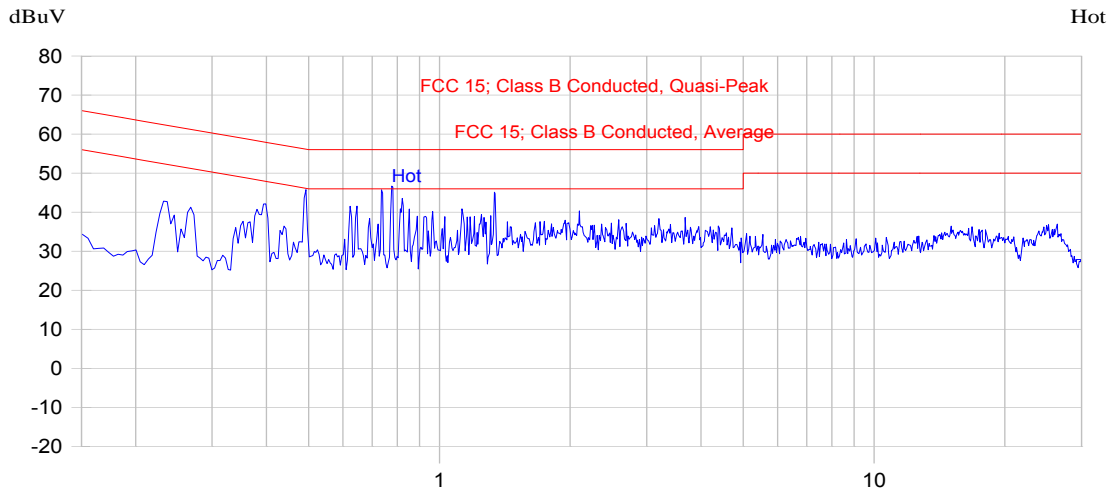

6/12/2018 9:49:58 AM

(Start = 0.15, Stop = 30.00) MHz

**Current List**

Frequency MHz	Peak dBuV	QP dBuV	QP-QP Limit dB	Avg dBuV	Avg-Avg Limit dB	Trace Name
0.237	44.5	42.0	-20.2	30.3	-21.9	Hot
0.390	44.5	41.6	-16.4	29.5	-18.6	Hot
0.494	47.0	42.3	-13.8	26.8	-19.3	Hot
0.778	48.2	43.4	-12.6	31.5	-14.5	Hot
1.331	46.0	38.3	-17.7	27.7	-18.3	Hot

**Plot 5.1.4.4. Power Line Conducted Emissions (Rx Mode)**  
 Line Voltage: 120 VAC; Line Tested: Neutral

**Current Graph**

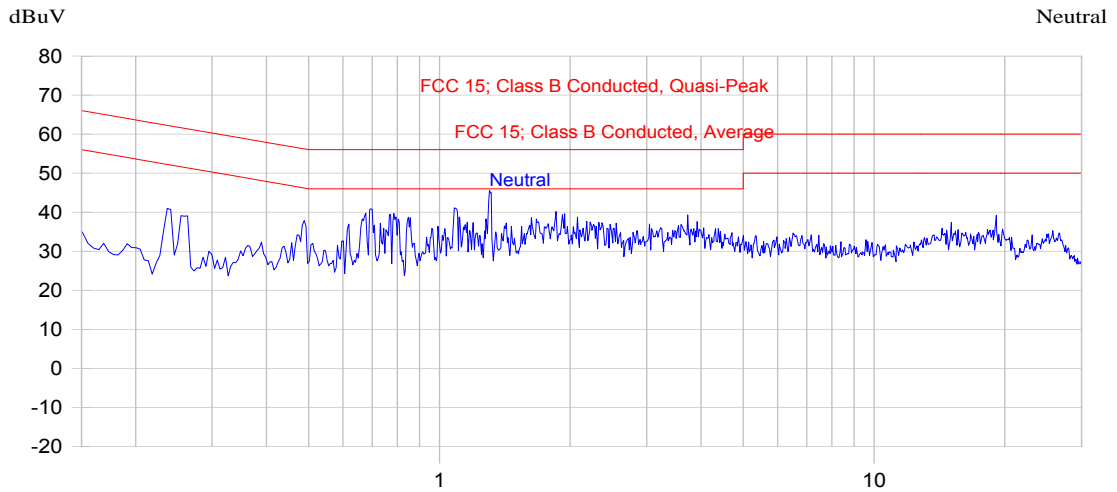

6/12/2018 9:39:39 AM

(Start = 0.15, Stop = 30.00) MHz

**Current List**

Frequency MHz	Peak dBuV	QP dBuV	QP-QP Limit dB	Avg dBuV	Avg-Avg Limit dB	Trace Name
0.230	44.2	39.1	-23.3	26.5	-26.0	Neutral
0.484	39.7	33.9	-22.4	25.2	-21.1	Neutral
0.700	44.7	39.1	-16.9	25.8	-20.2	Neutral
1.084	41.7	36.0	-20.0	25.8	-20.2	Neutral
1.307	45.2	37.4	-18.6	27.7	-18.3	Neutral
19.103	35.4	28.9	-31.1	22.6	-27.4	Neutral

**5.2. OCCUPIED BANDWIDTH [§ 15.247(a)(2)]**

**5.2.1. Limit(s)**

The minimum 6 dB bandwidth shall be at least 500 kHz.

**5.2.2. Method of Measurements**

KDB 558074 D01 DTS Meas Guidance v04, Section 8.2 Option 2.

**5.2.3. Test Arrangement**

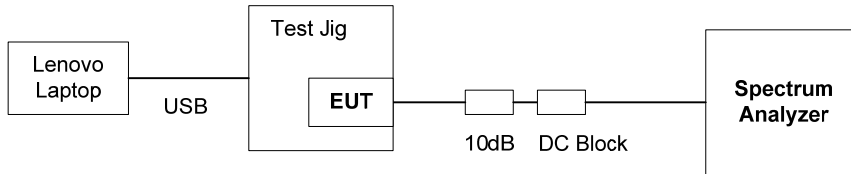

USB provide 5 Vdc and software to operate radio module

**5.2.4. Test Data**

Modulation	Data Rate (Mbps)	Power Setting	Channel	Frequency (MHz)	6dB BW (kHz)	Min. Limit (kHz)
GFSK	1	200	37	2402	713.94	500
		200	17	2440	706.73	500
		200	39	2480	706.73	500
	2	200	00	2404	1375.00	500
		200	17	2440	1375.00	500
		200	36	2478	1370.19	500

Plot 5.2.4.1. 6 dB Bandwidth, GFSK Modulation, Power Setting at 200, Channel 37, 2402 MHz, 1 Mbps

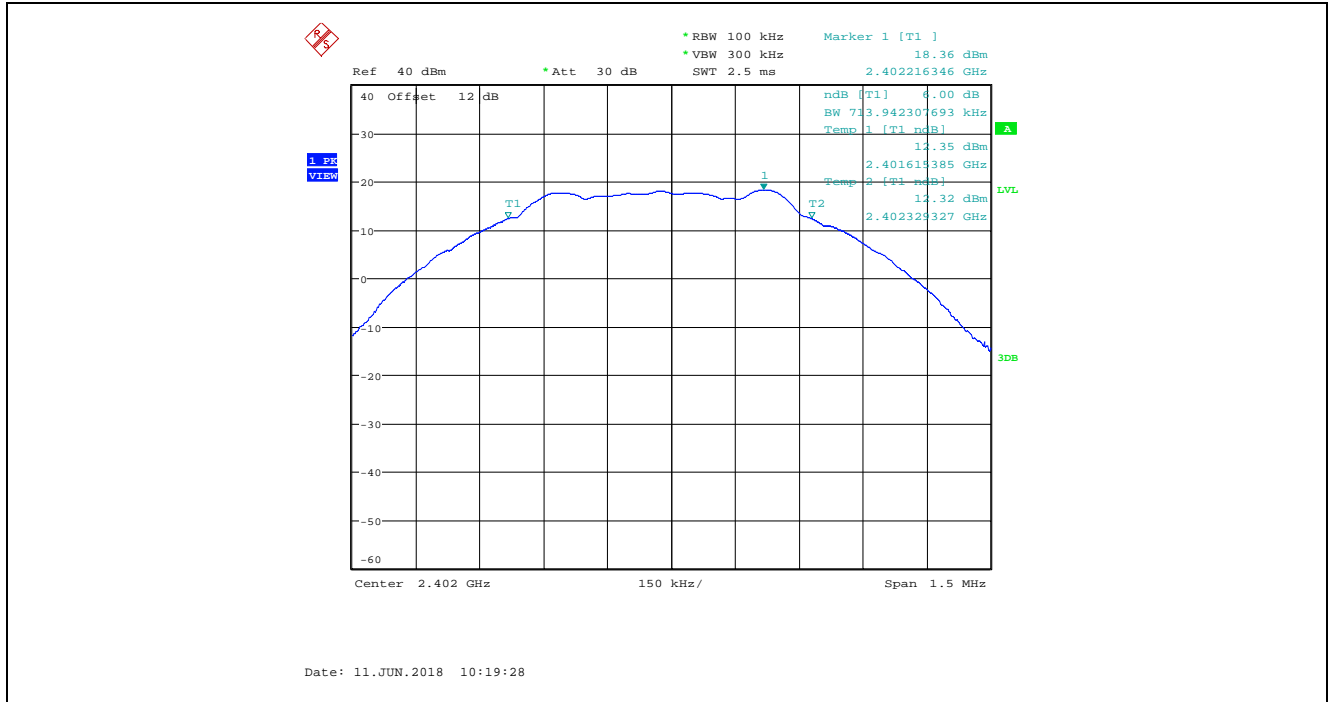

Plot 5.2.4.2. 6 dB Bandwidth, GFSK Modulation, Power Setting at 200, Channel 17, 2440 MHz, 1 Mbps

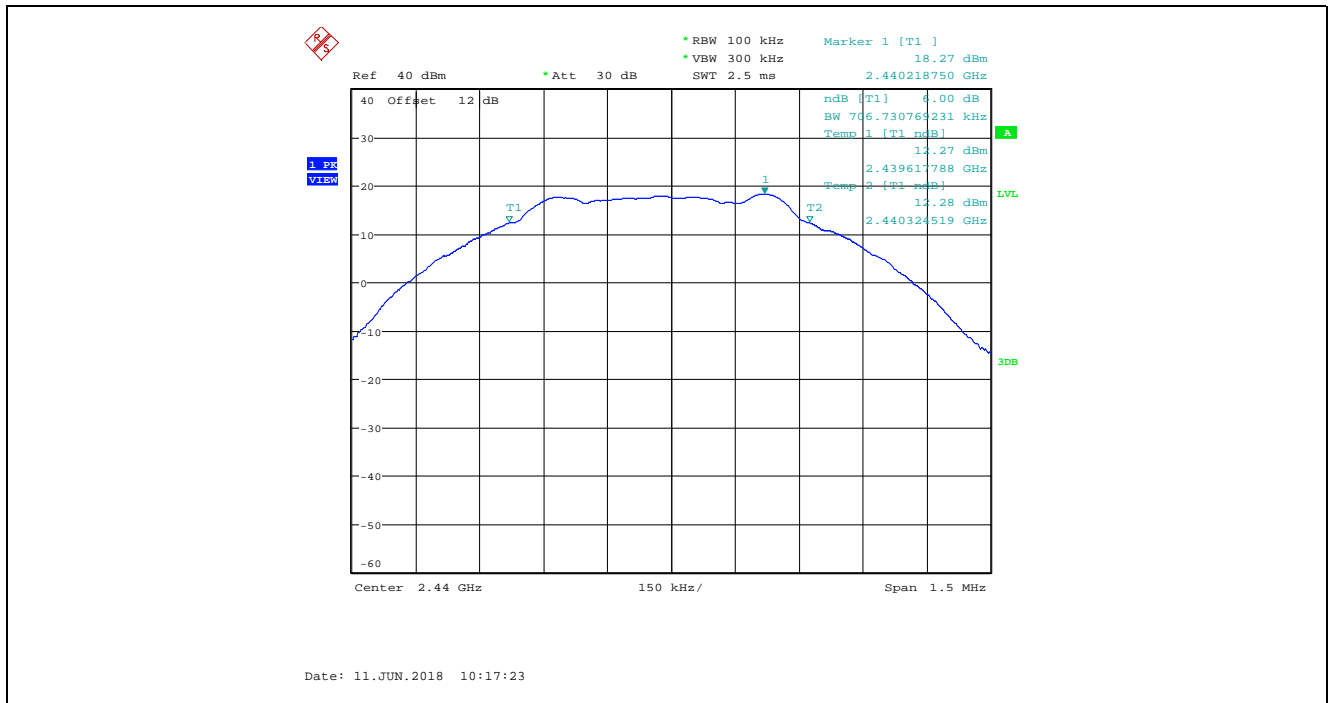

Plot 5.2.4.3. 6 dB Bandwidth, GFSK Modulation, Power Setting at 200, Channel 39, 2480 MHz, 1 Mbps

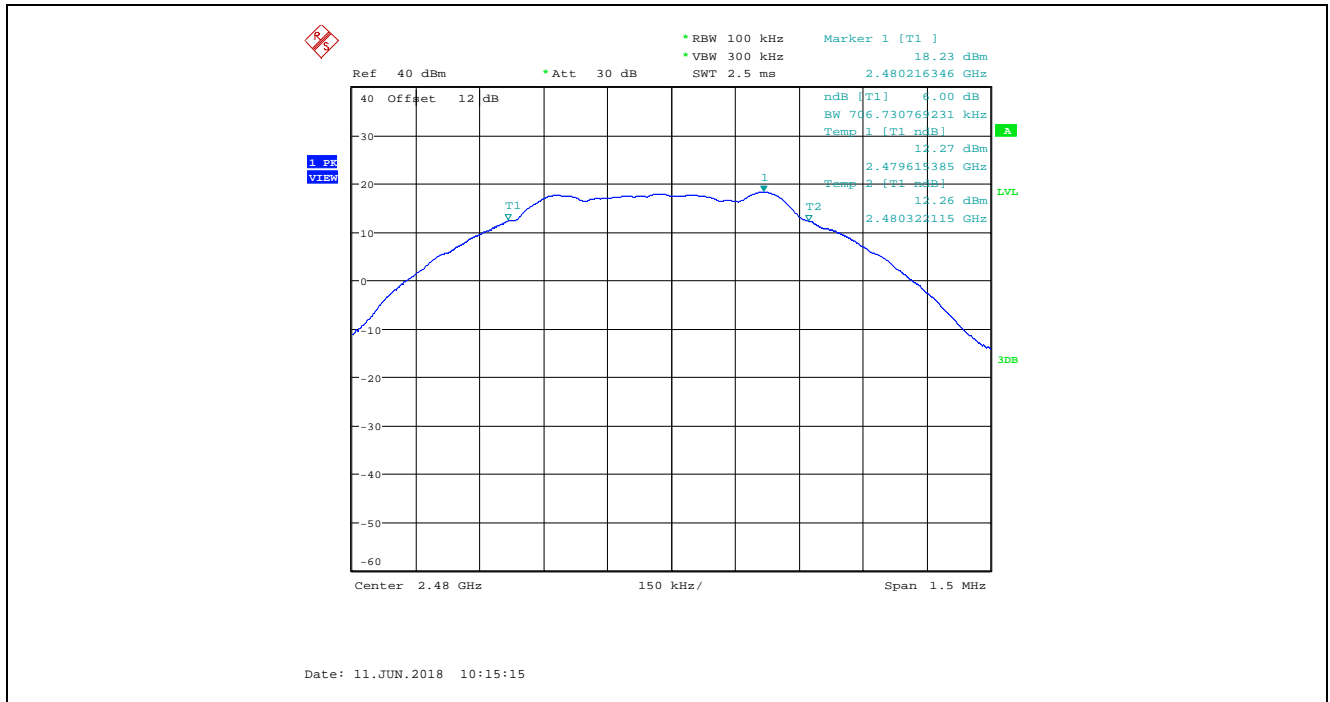

Plot 5.2.4.4. 6 dB Bandwidth, GFSK Modulation, Power Setting at 200, Channel 00, 2404 MHz, 2 Mbps

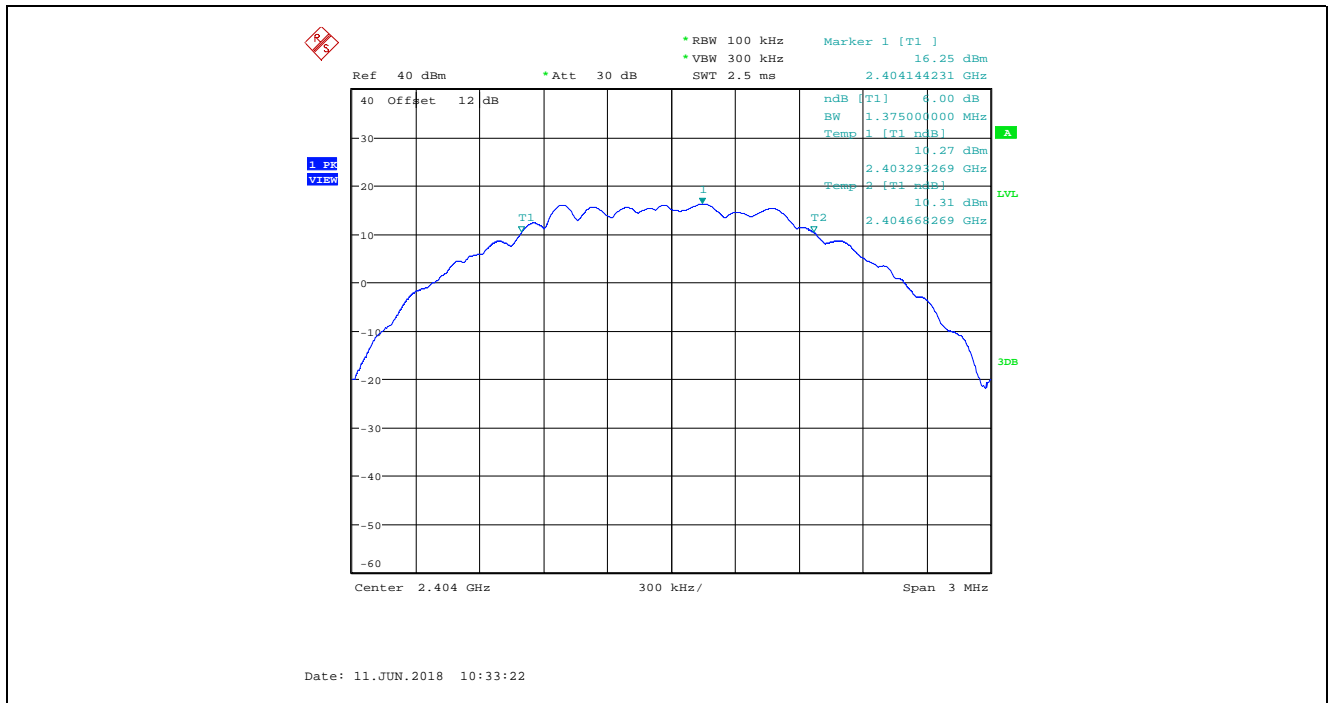

Plot 5.2.4.5. 6 dB Bandwidth, GFSK Modulation, Power Setting at 200, Channel 17, 2440 MHz, 2 Mbps

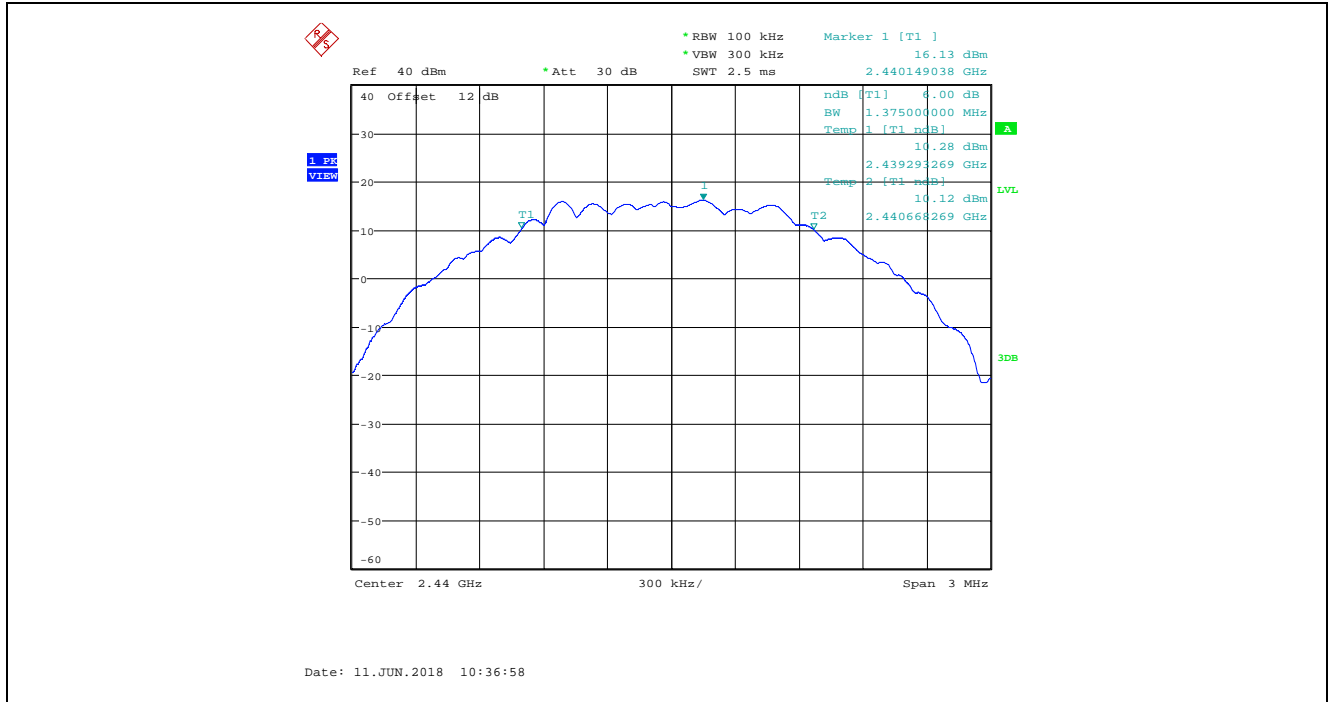

Plot 5.2.4.6. 6 dB Bandwidth, GFSK Modulation, Power Setting at 200, Channel 36, 2478 MHz, 2 Mbps

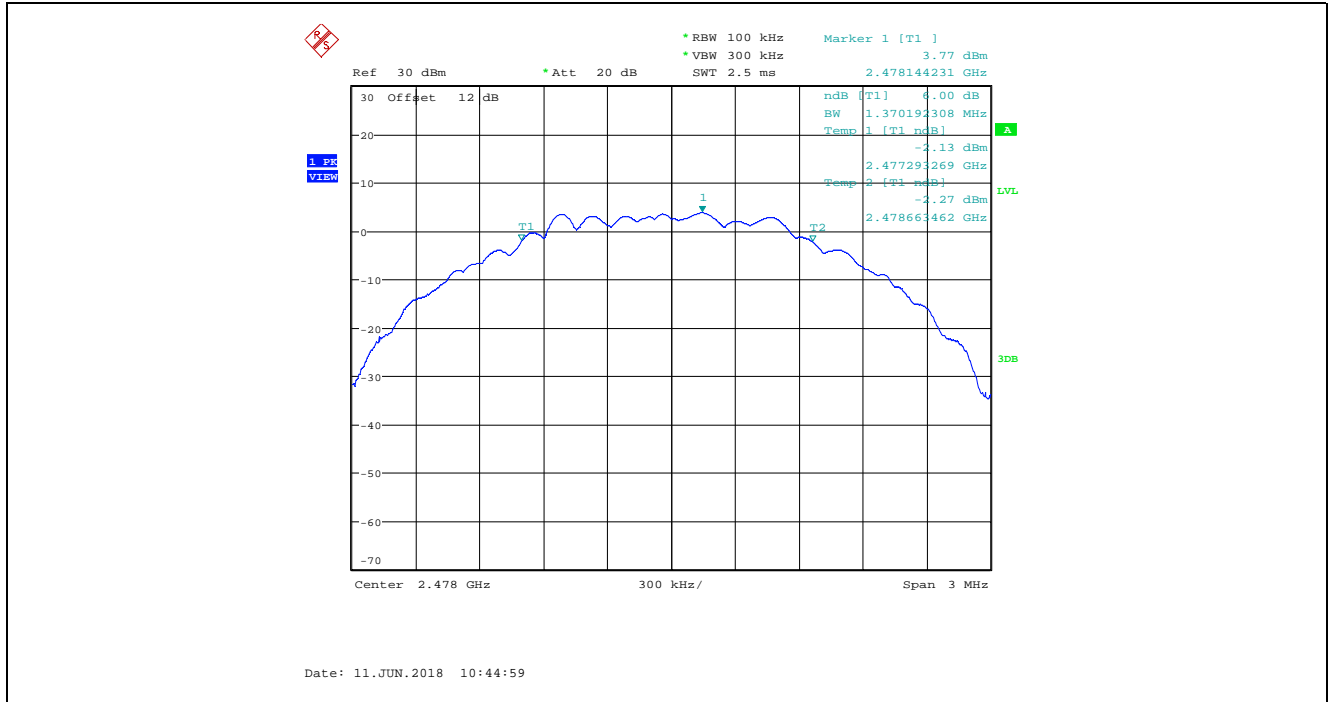



**5.3. PEAK CONDUCTED OUTPUT POWER - DTS [§ 15.247(b)(3)]**

**5.3.1. Limit(s)**

**§ 15.247(b)(3):** For systems using digital modulation in the 902-928 MHz, 2400-2483.5 MHz, and 5725-5850 MHz bands: 1 Watt. As an alternative to a peak power measurement, compliance with the one Watt limit can be based on a measurement of the maximum conducted output power. Maximum Conducted Output Power is defined as the total transmit power delivered to all antennas and antenna elements averaged across all symbols in the signaling alphabet when the transmitter is operating at its maximum power control level. Power must be summed across all antennas and antenna elements. The average must not include any time intervals during which the transmitter is off or is transmitting at a reduced power level. If multiple modes of operation are possible (e.g., alternative modulation methods), the *maximum conducted output power* is the highest total transmit power occurring in any mode.

**§ 15.247(b)(4):** The conducted output power limit specified in paragraph (b) of this section is based on the use of antennas with directional gains that do not exceed 6 dBi. Except as shown in paragraph (c) of this section, if transmitting antennas of directional gain greater than 6 dBi are used, the conducted output power from the intentional radiator shall be reduced below the stated values in paragraphs (b)(1), (b)(2), and (b)(3) of this section, as appropriate, by the amount in dB that the directional gain of the antenna exceeds 6 dBi.

**5.3.2. Method of Measurements & Test Arrangement**

KDB 558074 D01 DTS Meas Guidance V04, Section 9.1.1 RBW ≥ DTS bandwidth

**5.3.3. Test Arrangement**

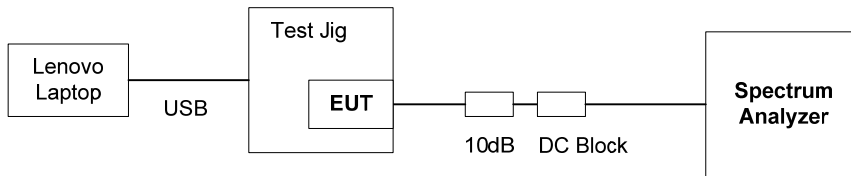

USB provide 5 Vdc and software to operate radio module

5.3.4. Test Data

Peak Conducted Power and Power Settings for EUT with 1.72 dBi Chip Antenna								
Modulation	Data Rate (Mbps)	Power Setting	Channel	Frequency (MHz)	Peak Power (dBm)	Assembly Gain (dB)	EIRP (dBm)	Peak Power Limit (dBm)
GFSK	High Power Level							
	1	200	37	2402	19.22	1.72	20.94	30
		200	17	2440	19.31	1.72	21.03	30
		200	36	2478	14.63	1.72	16.35	30
		200	39	2480	19.22	1.72	20.94	30
	2	200	00	2404	19.26	1.72	20.98	30
		200	17	2440	19.32	1.72	21.04	30
		200	36	2478	7.05	1.72	8.77	30
	GFSK	Low Power Level						
1		111	37	2402	10.09	1.72	11.81	30
		111	17	2440	10.09	1.72	11.81	30
		111	39	2480	10.24	1.72	11.96	30
2		111	00	2404	10.12	1.72	11.84	30
		111	17	2440	10.11	1.72	11.83	30
		111	36	2478	6.90	1.72	8.62	30

Peak Conducted Power and Power Settings for EUT with 5 dBi Dipole Antenna								
Modulation	Data Rate (Mbps)	Power Setting	Channel	Frequency (MHz)	Peak Power (dBm)	Assembly Gain (dB)	EIRP (dBm)	Peak Power Limit (dBm)
GFSK	High Power Level							
	1	200	37	2402	19.22	5	24.22	30
		200	17	2440	19.31	5	24.31	30
		200	36	2478	14.63	5	19.63	30
		160	39	2480	15.08	5	20.08	30
	2	200	0	2404	19.26	5	24.26	30
		200	17	2440	19.32	5	24.32	30
		200	36	2478	7.05	5	12.05	30
	GFSK	Low Power Level						
1		111	37	2402	10.09	5	15.09	30
		111	17	2440	10.09	5	15.09	30
		111	39	2480	10.24	5	15.24	30
2		111	0	2404	10.12	5	15.12	30
		111	17	2440	10.11	5	15.11	30
		111	36	2478	6.90	5	11.90	30

Plot 5.3.4.1. Maximum Peak Conducted Output Power, GFSK Modulation, 1 Mbps, Power Setting 200, Ch 37, 2402 MHz

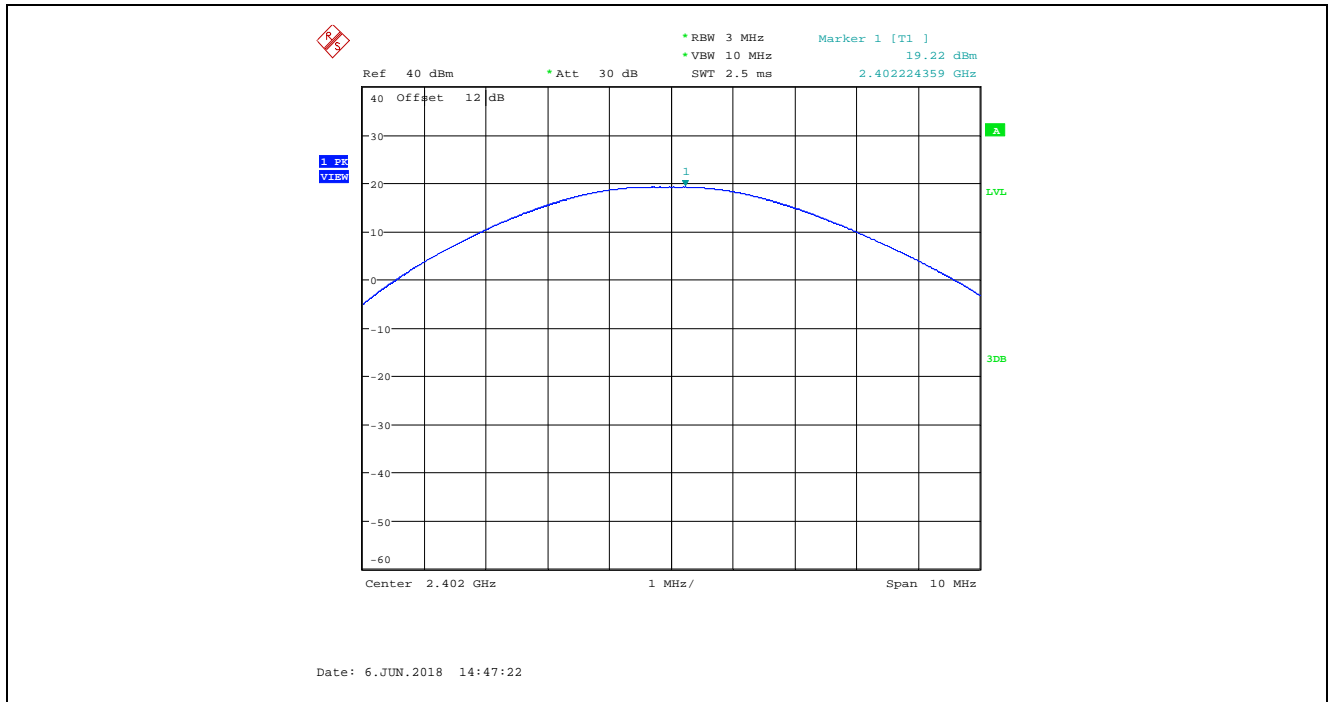

Plot 5.3.4.2. Maximum Peak Conducted Output Power, GFSK Modulation, 1 Mbps, Power Setting 200, Ch 17, 2440 MHz

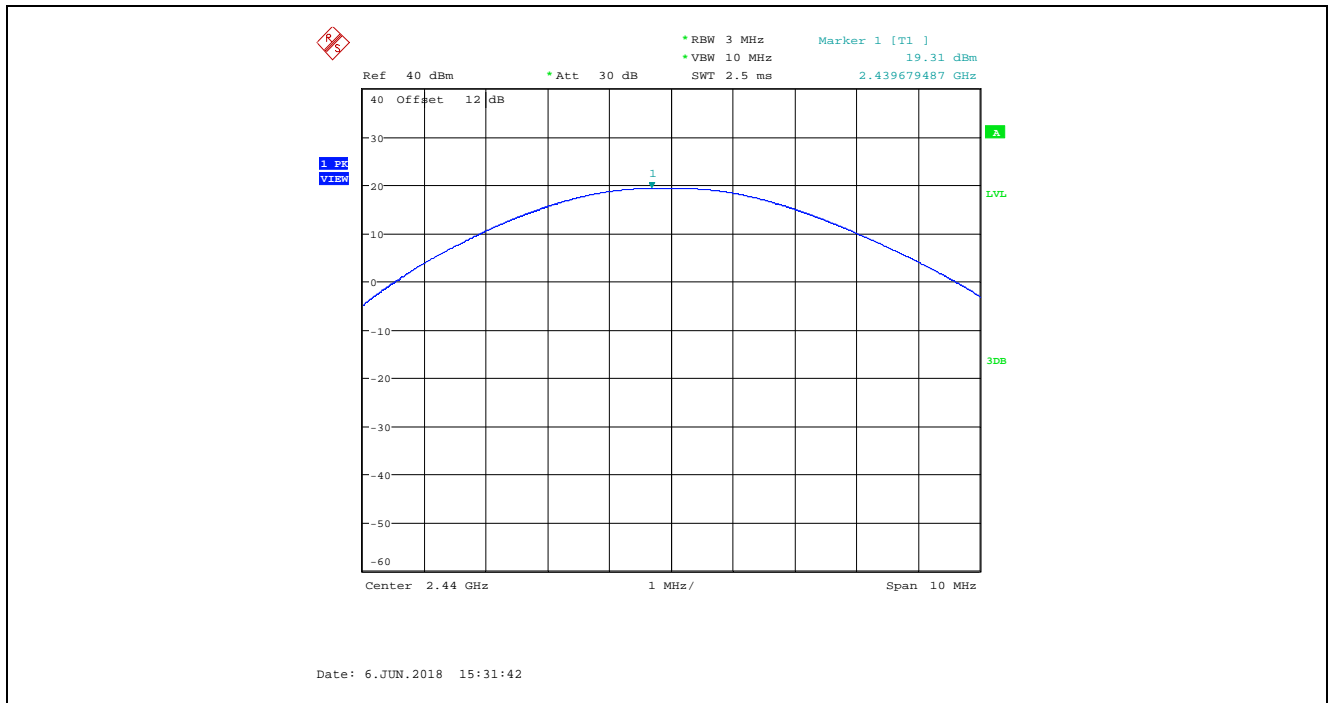

Plot 5.3.4.3. Maximum Peak Conducted Output Power, GFSK Modulation, 1 Mbps, Power Setting 200, Ch 36, 2478 MHz



Plot 5.3.4.4. Maximum Peak Conducted Output Power, GFSK Modulation, 1 Mbps, Power Setting 200, Ch 39, 2480 MHz

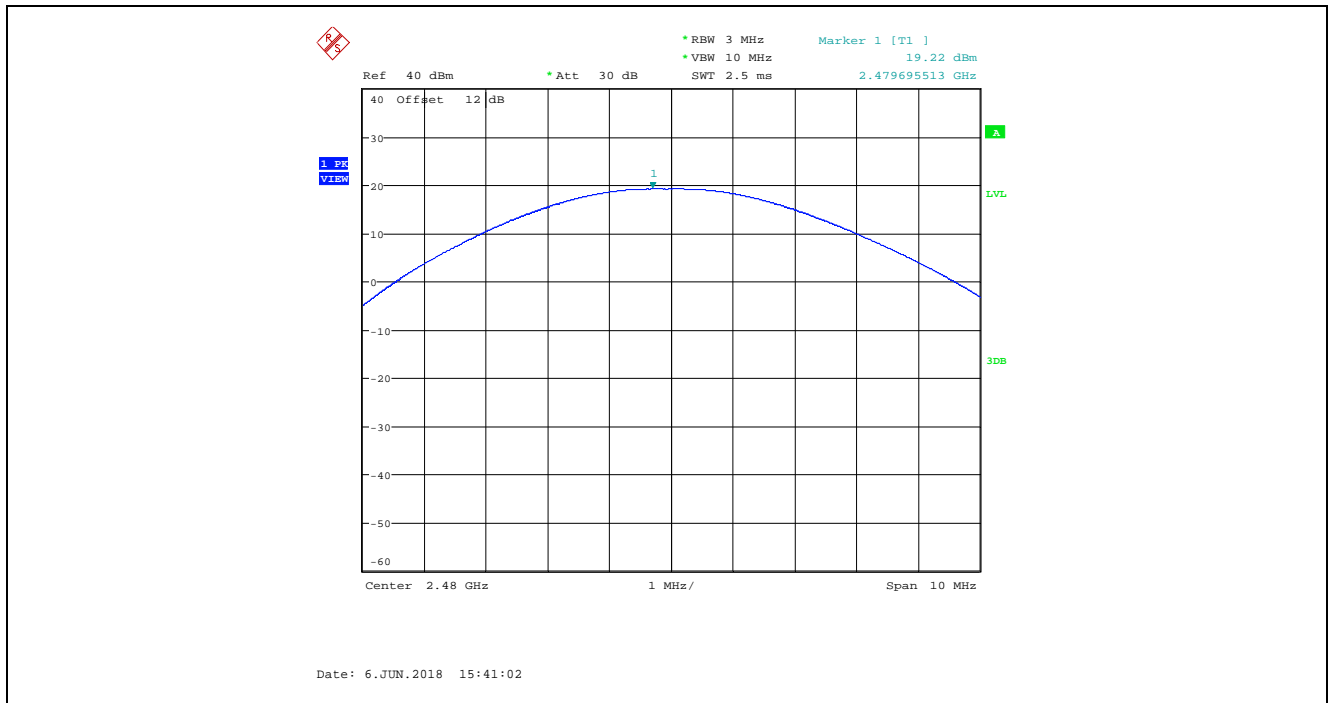

Plot 5.3.4.5. Maximum Peak Conducted Output Power, GFSK Modulation, 1 Mbps, Power Setting 160, Ch 39, 2480 MHz

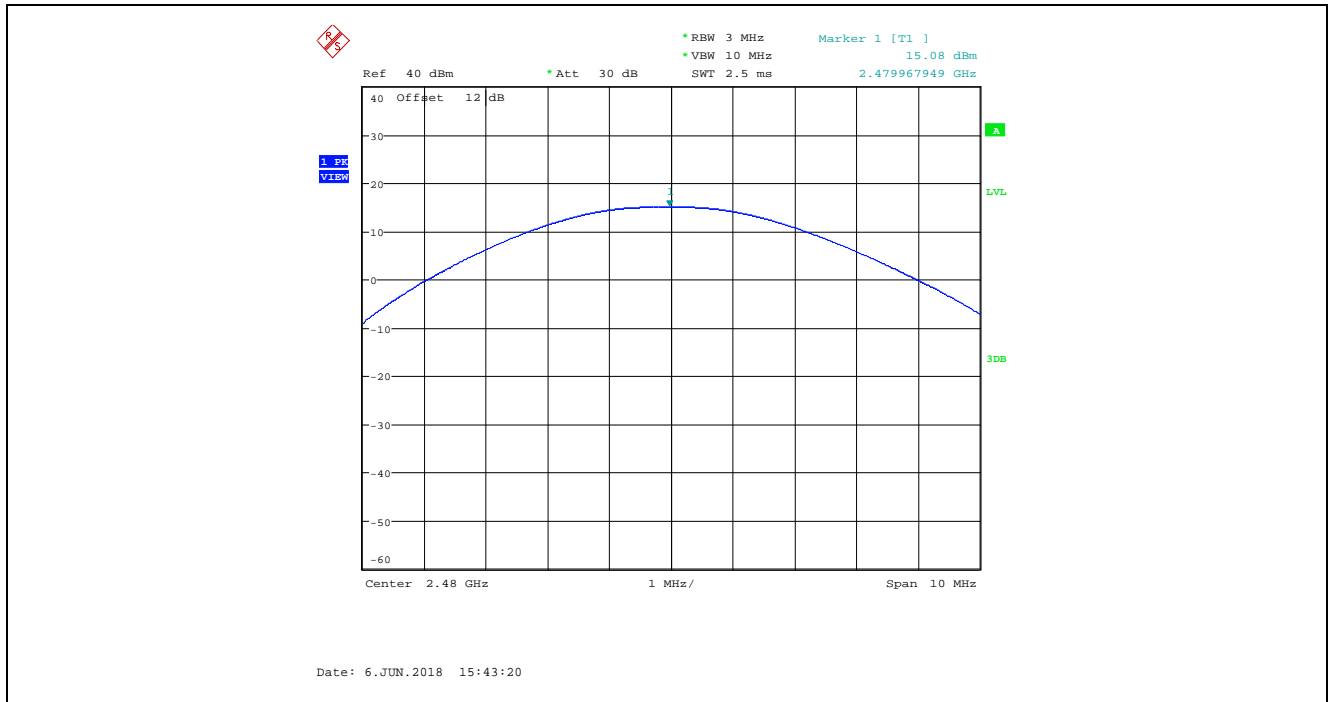

Plot 5.3.4.6. Maximum Peak Conducted Output Power, GFSK Modulation, 2 Mbps, Power Setting 200, Ch 00, 2404 MHz

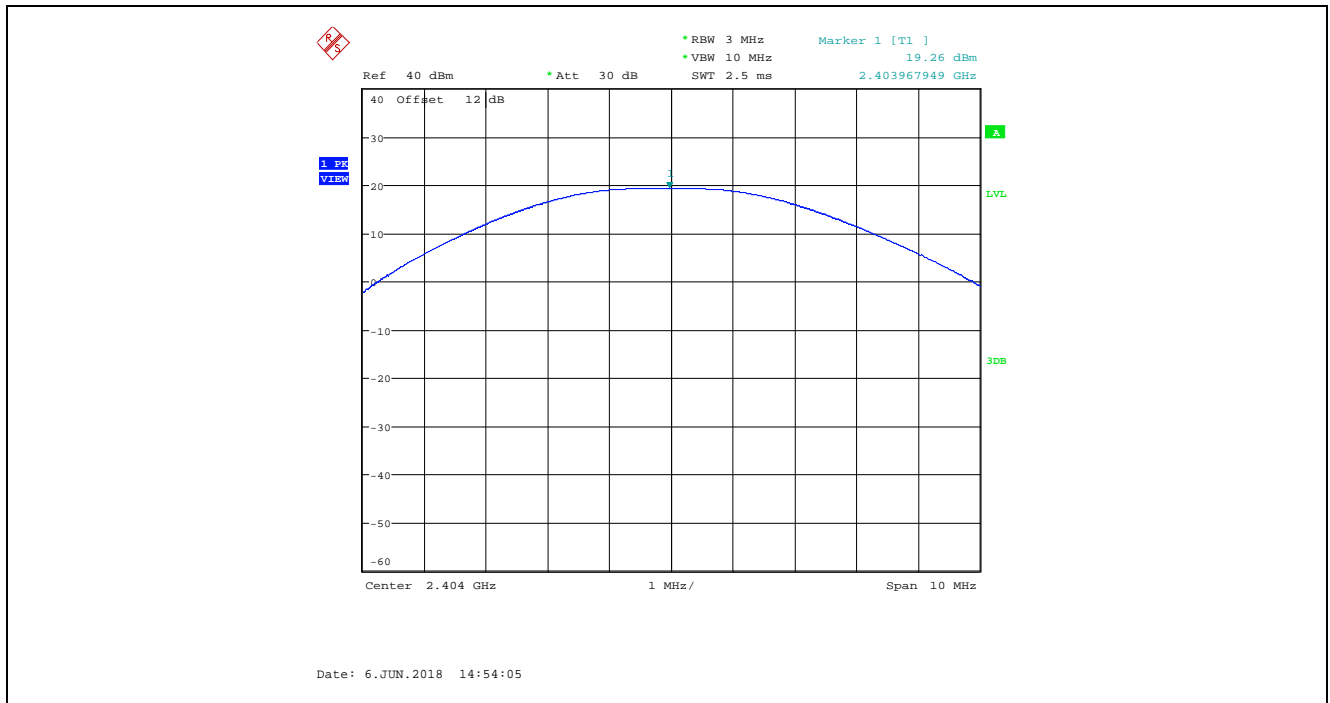

Plot 5.3.4.7. Maximum Peak Conducted Output Power, GFSK Modulation, 2 Mbps, Power Setting 200, Ch 17, 2440 MHz

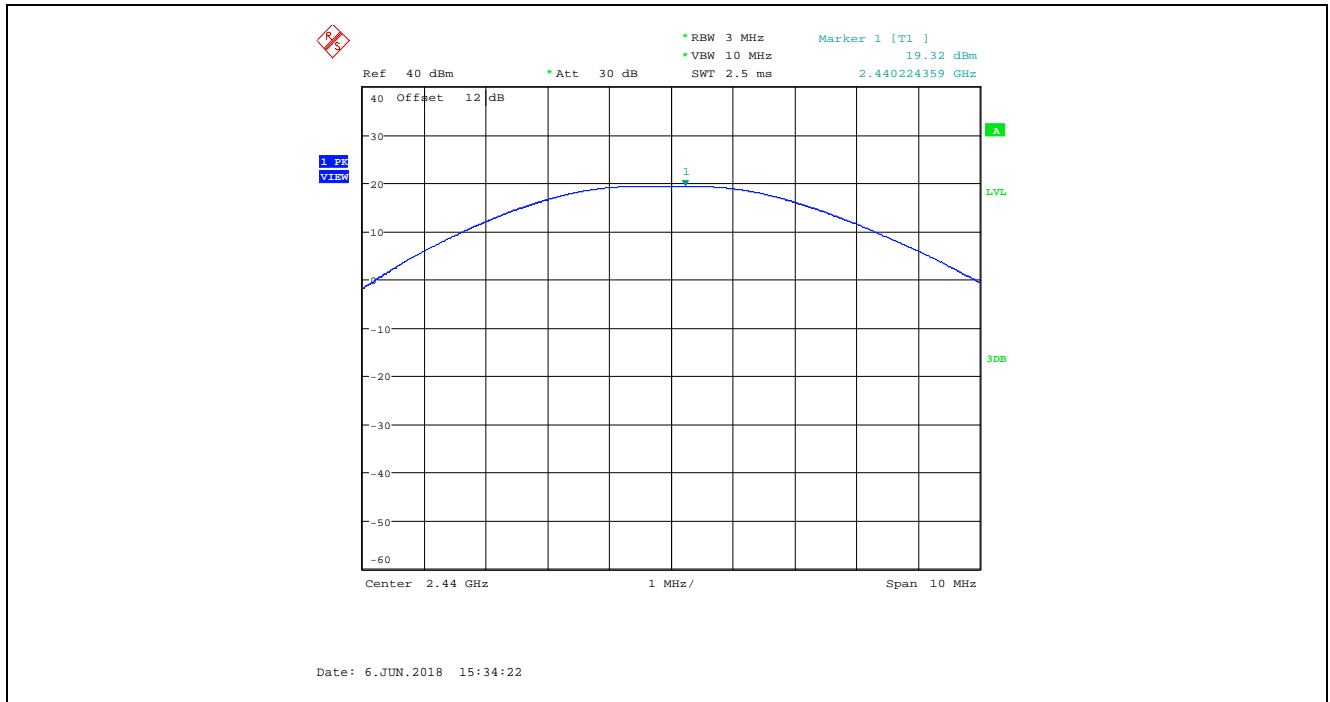

Plot 5.3.4.8. Maximum Peak Conducted Output Power, GFSK Modulation, 2 Mbps, Power Setting 200, Ch 36, 2478 MHz

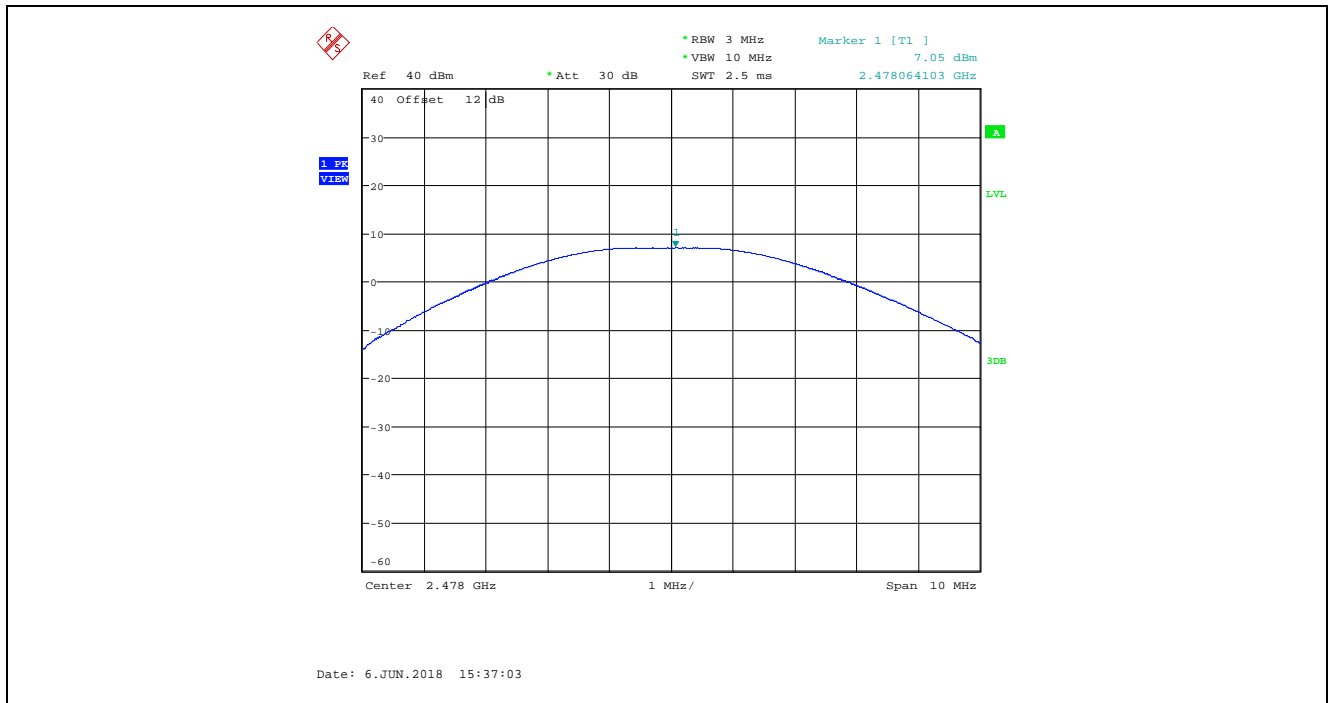

Plot 5.3.4.9. Maximum Peak Conducted Output Power, GFSK Modulation, 1 Mbps, Power Setting 111, Ch 37, 2402 MHz

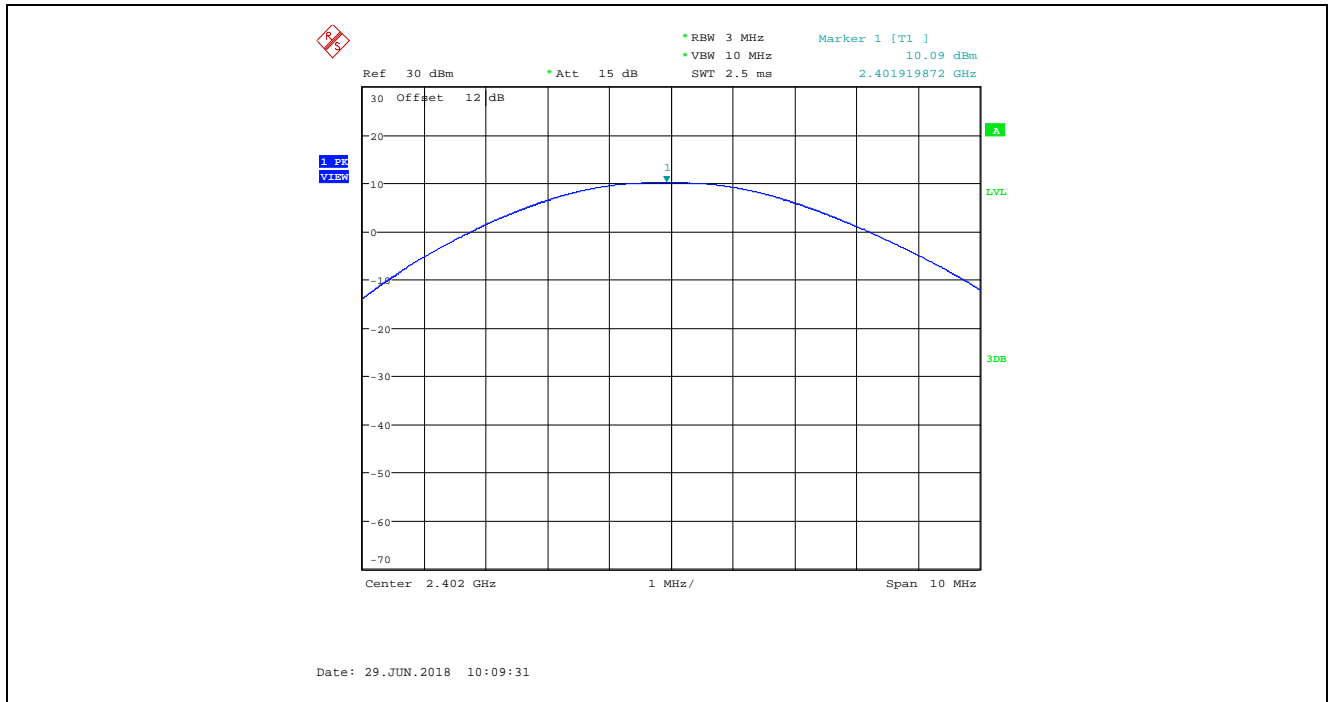

Plot 5.3.4.10. Maximum Peak Conducted Output Power, GFSK Modulation, 1 Mbps, Power Setting 111, Ch 17, 2440 MHz

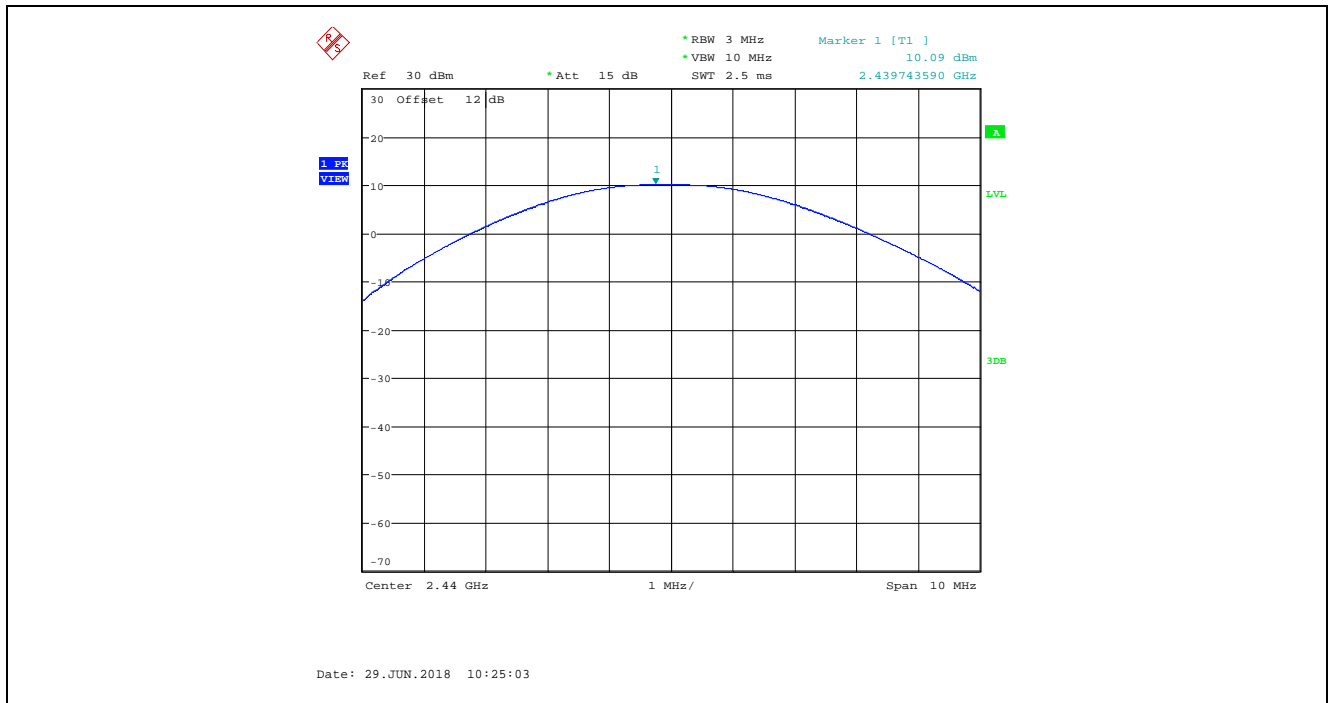



Plot 5.3.4.11. Maximum Peak Conducted Output Power, GFSK Modulation, 1 Mbps, Power Setting 111, Ch 39, 2480 MHz

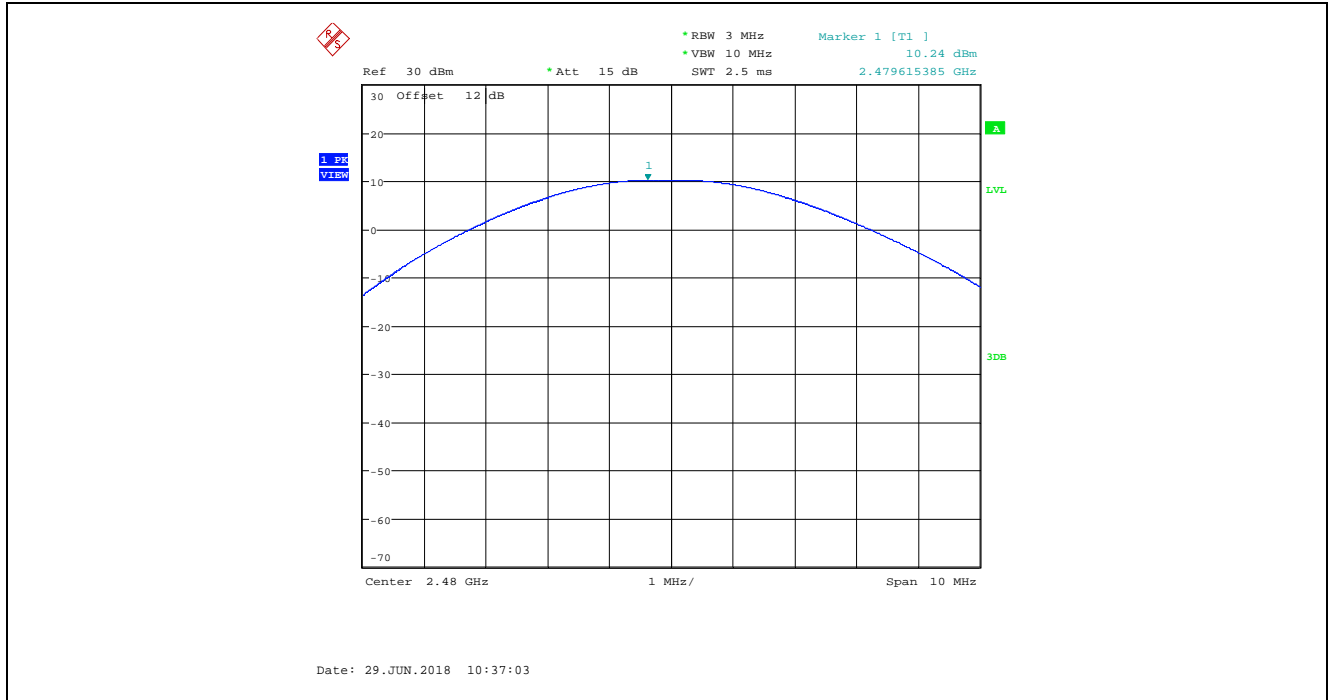

Plot 5.3.4.12. Maximum Peak Conducted Output Power, GFSK Modulation, 2 Mbps, Power Setting 111, Ch 00, 2404 MHz

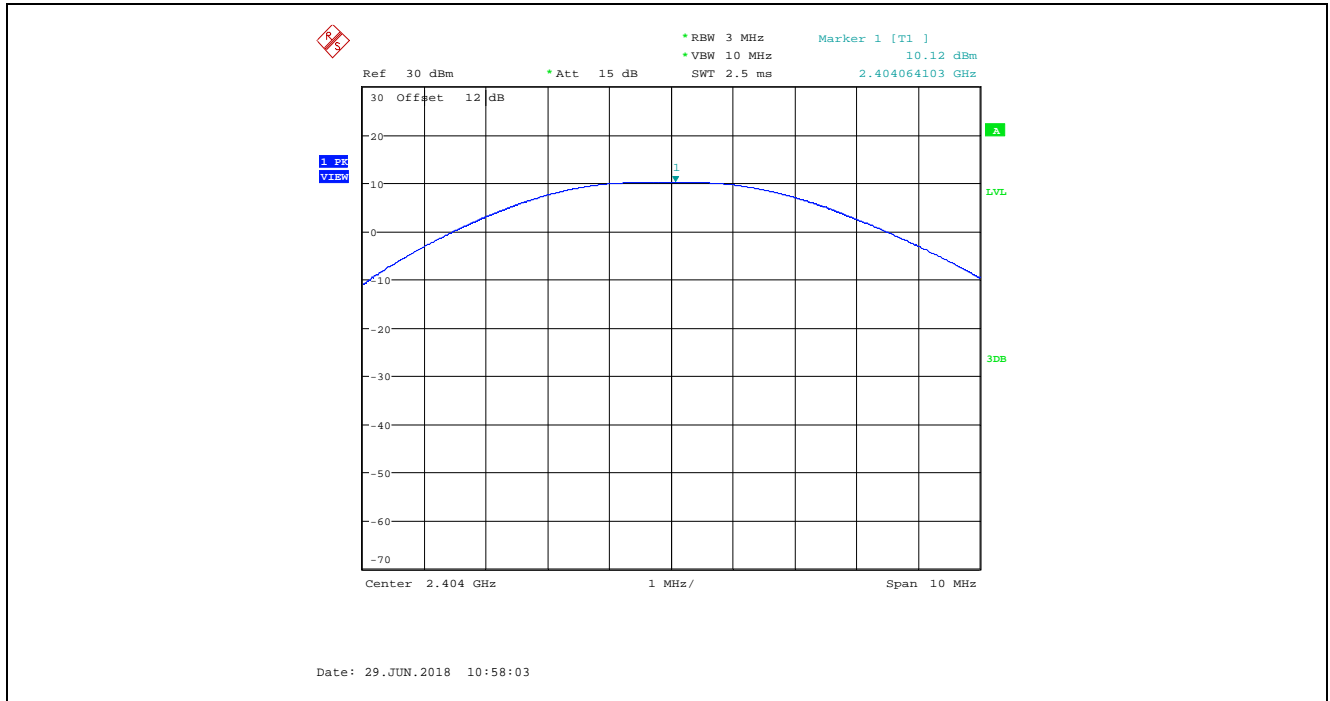

Plot 5.3.4.13. Maximum Peak Conducted Output Power, GFSK Modulation, 2 Mbps, Power Setting 111, Ch 17, 2440 MHz

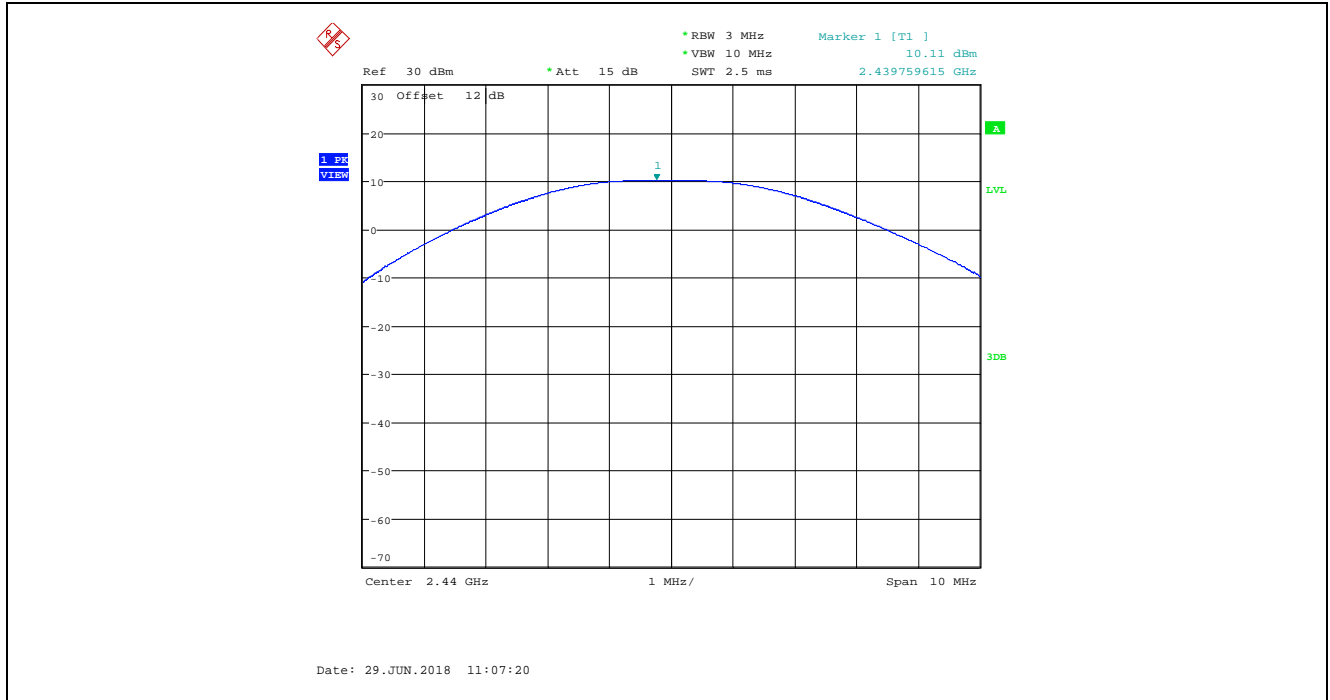

Plot 5.3.4.14. Maximum Peak Conducted Output Power, GFSK Modulation, 2 Mbps, Power Setting 111, Ch 36, 2478 MHz

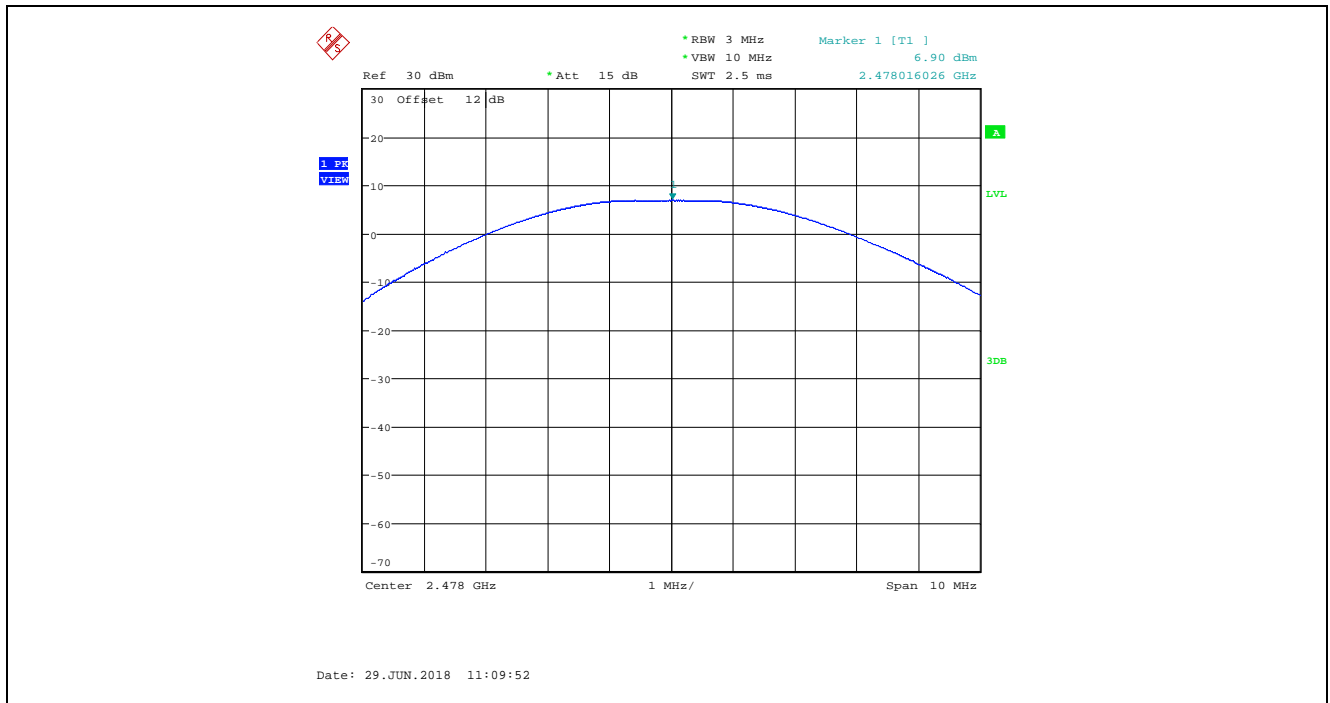

**5.4. TRANSMITTER SPURIOUS RADIATED EMISSIONS AT 3 METERS [§§ 15.247(d), 15.209 & 15.205]**

**5.4.1. Limit(s)**

**§ 15.247 (d):** In any 100 kHz bandwidth outside the frequency band in which the spread spectrum or digitally modulated intentional radiator is operating, the radio frequency power that is produced by the intentional radiator shall be at least 20 dB below that in the 100 kHz bandwidth within the band that contains the highest level of the desired power, based on either an RF conducted or a radiated measurement, provided the transmitter demonstrates compliance with the peak conducted power limits. If the transmitter complies with the conducted power limits based on the use of RMS averaging over a time interval, as permitted under paragraph (b)(3) of this section, the attenuation required under this paragraph shall be 30 dB instead of 20 dB. Attenuation below the general limits specified in Section 15.209(a) is not required. In addition, radiated emissions which fall in the restricted bands, as defined in Section 15.205(a), must also comply with the radiated emission limits specified in Section 15.209(a) (see Section 15.205(c)).

**Section 15.205(a) - Restricted Bands of Operation**

MHz	MHz	MHz	GHz
0.090–0.110 .....	16.42–16.423	399.9–410	4.5–5.15
<sup>1</sup> 0.495–0.505 .....	16.69475–16.69525	608–614	5.35–5.46
2.1735–2.1905 .....	16.80425–16.80475	960–1240	7.25–7.75
4.125–4.128 .....	25.5–25.67	1300–1427	8.025–8.5
4.17725–4.17775 .....	37.5–38.25	1435–1626.5	9.0–9.2
4.20725–4.20775 .....	73–74.6	1645.5–1646.5	9.3–9.5
6.215–6.218 .....	74.8–75.2	1660–1710	10.6–12.7
6.26775–6.26825 .....	108–121.94	1718.8–1722.2	13.25–13.4
6.31175–6.31225 .....	123–138	2200–2300	14.47–14.5
8.291–8.294 .....	149.9–150.05	2310–2390	15.35–16.2
8.362–8.366 .....	156.52475–156.52525	2483.5–2500	17.7–21.4
8.37625–8.38675 .....	156.7–156.9	2655–2900	22.01–23.12
8.41425–8.41475 .....	162.0125–167.17	3260–3267	23.6–24.0
12.29–12.293 .....	167.72–173.2	3332–3339	31.2–31.8
12.51975–12.52025 .....	240–285	3345.8–3358	36.43–36.5
12.57675–12.57725 .....	322–335.4	3600–4400	( <sup>2</sup> )
13.36–13.41.			

<sup>1</sup>Until February 1, 1999, this restricted band shall be 0.490–0.510 MHz.

<sup>2</sup>Above 38.6

**Section 15.209(a) - Field Strength Limits within Restricted Frequency Bands**

Frequency (MHz)	Field Strength (microvolts/meter)	Measurement Distance (meters)
0.009 - 0.490	2,400 / F (kHz)	300
0.490 - 1.705	24,000 / F (kHz)	30
1.705 - 30.0	30	30
30 – 88	100	3
88 – 216	150	3
216 – 960	200	3
Above 960	500	3

### 5.4.2. Method of Measurements

KDB 558074 D01 DTS Meas Guidance v04 Sections 12.2.7, 13 and ANSI C63.10.

### 5.4.3. Test Arrangement

#### Radiated Emissions

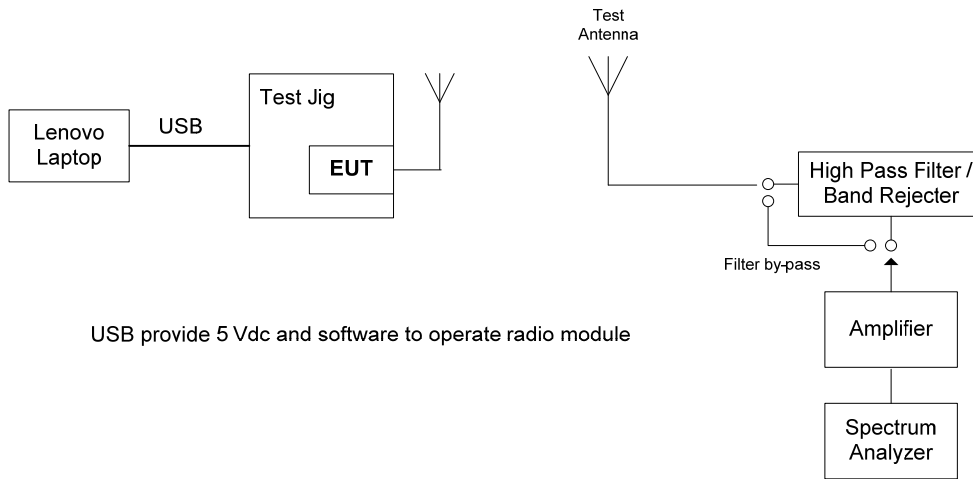

#### Band-Edge Radiated Emissions

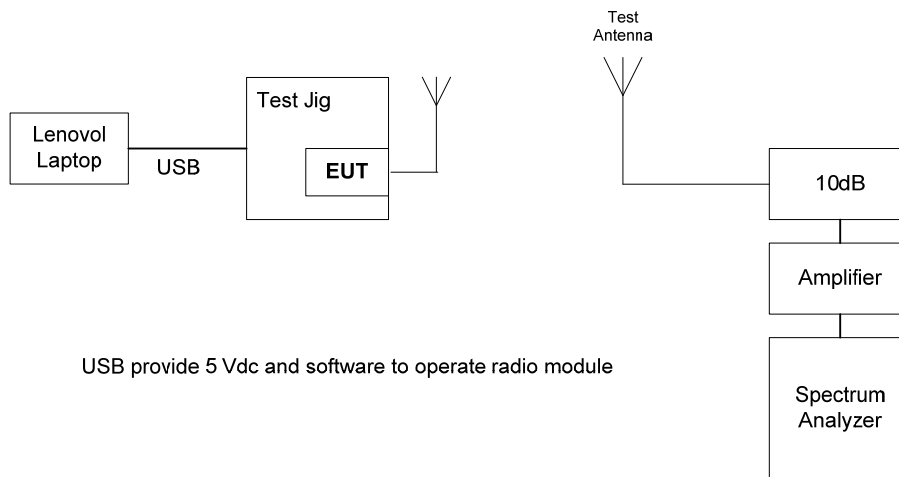

**5.4.4. Test Data**

**Remark(s):**

- All spurious emissions that are in excess of 20 dB below the specified limit shall be recorded.
- EUT shall be tested in three orthogonal positions.
- Exploratory tests performed to determined worst-case test configurations, the following test results at high power setting represent the worst-case.

**5.4.4.1. Test Configuration 1: EUT with 1.72 dBi Chip Antenna**

Fundamental Frequency:		2402 MHz					
Frequency Test Range:		30 MHz – 25 GHz					
Frequency (MHz)	RF Peak Level (dBµV/m)	RF Avg Level (dBµV/m)	Antenna Plane (H/V)	Limit 15.209 (dBµV/m)	Limit 15.247 (dBµV/m)	Margin (dB)	Pass/Fail
2402	111.87	--	V	--	--	--	--
2402	117.56	--	H	--	--	--	--
4804	52.86	46.64	V	54.0	97.6	-7.4	Pass*
4804	53.21	47.23	H	54.0	97.6	-6.8	Pass*

\*Field strength of emissions appearing within restricted frequency bands shall not exceed the limits in § 15.209.

Fundamental Frequency:		2440 MHz					
Frequency Test Range:		30 MHz – 25 GHz					
Frequency (MHz)	RF Peak Level (dBµV/m)	RF Avg Level (dBµV/m)	Antenna Plane (H/V)	Limit 15.209 (dBµV/m)	Limit 15.247 (dBµV/m)	Margin (dB)	Pass/Fail
2440	114.74	--	V	--	--	--	--
2440	116.70	--	H	--	--	--	--
4880	51.28	43.29	V	54.0	96.7	-10.7	Pass*
7320	51.90	43.08	V	54.0	96.7	-10.9	Pass*
4880	51.74	43.31	H	54.0	96.7	-10.7	Pass*
7320	52.68	40.13	H	54.0	96.7	-13.9	Pass*

\*Field strength of emissions appearing within restricted frequency bands shall not exceed the limits in § 15.209.

Fundamental Frequency:		2478 MHz					
Frequency Test Range:		30 MHz – 25 GHz					
Frequency (MHz)	RF Peak Level (dBµV/m)	RF Avg Level (dBµV/m)	Antenna Plane (H/V)	Limit 15.209 (dBµV/m)	Limit 15.247 (dBµV/m)	Margin (dB)	Pass/Fail
2478	109.42	--	V	--	--	--	--
2478	111.35	--	H	--	--	--	--
4956	48.27	37.19	V	54.0	91.4	-16.8	Pass*
4956	49.27	39.34	H	54.0	91.4	-14.7	Pass*

\*Field strength of emissions appearing within restricted frequency bands shall not exceed the limits in § 15.209.

Fundamental Frequency:		2480 MHz					
Frequency Test Range:		30 MHz – 25 GHz					
Frequency (MHz)	RF Peak Level (dBµV/m)	RF Avg Level (dBµV/m)	Antenna Plane (H/V)	Limit 15.209 (dBµV/m)	Limit 15.247 (dBµV/m)	Margin (dB)	Pass/Fail
2480	114.25	--	V	--	--	--	--
2480	115.12	--	H	--	--	--	--
4960	48.17	36.17	V	54.0	95.1	-17.8	Pass*
4960	48.83	38.81	H	54.0	95.1	-15.2	Pass*

\*Field strength of emissions appearing within restricted frequency bands shall not exceed the limits in § 15.209.

**5.4.4.2. Test Configuration 2: EUT with 5 dBi Dipole Antenna**

Fundamental Frequency:		2402 MHz					
Frequency Test Range:		30 MHz – 25 GHz					
Frequency (MHz)	RF Peak Level (dBµV/m)	RF Avg Level (dBµV/m)	Antenna Plane (H/V)	Limit 15.209 (dBµV/m)	Limit 15.247 (dBµV/m)	Margin (dB)	Pass/Fail
2402	117.55	--	V	--	--	--	--
2402	116.06	--	H	--	--	--	--
4804	56.64	52.75	V	54.0	97.6	-1.3	Pass*
4804	54.96	49.33	H	54.0	97.6	-4.7	Pass*

\*Field strength of emissions appearing within restricted frequency bands shall not exceed the limits in § 15.209.

Fundamental Frequency:		2440 MHz					
Frequency Test Range:		30 MHz – 25 GHz					
Frequency (MHz)	RF Peak Level (dB $\mu$ V/m)	RF Avg Level (dB $\mu$ V/m)	Antenna Plane (H/V)	Limit 15.209 (dB $\mu$ V/m)	Limit 15.247 (dB $\mu$ V/m)	Margin (dB)	Pass/Fail
2440	115.79	--	V	--	--	--	--
2440	117.05	--	H	--	--	--	--
4880	55.90	51.05	V	54.0	97.1	-3.0	Pass*
4880	54.57	49.14	H	54.0	97.1	-4.9	Pass*
7320	53.08	40.36	V	54.0	97.1	-13.6	Pass*
7320	52.12	38.67	H	54.0	97.1	-15.3	Pass*

\*Field strength of emissions appearing within restricted frequency bands shall not exceed the limits in § 15.209.

Fundamental Frequency:		2478 MHz					
Frequency Test Range:		30 MHz – 25 GHz					
Frequency (MHz)	RF Peak Level (dB $\mu$ V/m)	RF Avg Level (dB $\mu$ V/m)	Antenna Plane (H/V)	Limit 15.209 (dB $\mu$ V/m)	Limit 15.247 (dB $\mu$ V/m)	Margin (dB)	Pass/Fail
2478	115.21	--	V	--	--	--	--
2478	114.05	--	H	--	--	--	--
4956	52.45	46.18	V	54.0	95.2	-7.8	Pass*
4956	50.55	41.85	H	54.0	95.2	-12.2	Pass*

\*Field strength of emissions appearing within restricted frequency bands shall not exceed the limits in § 15.209.

Fundamental Frequency:		2480 MHz					
Frequency Test Range:		30 MHz – 25 GHz					
Frequency (MHz)	RF Peak Level (dB $\mu$ V/m)	RF Avg Level (dB $\mu$ V/m)	Antenna Plane (H/V)	Limit 15.209 (dB $\mu$ V/m)	Limit 15.247 (dB $\mu$ V/m)	Margin (dB)	Pass/Fail
2480	114.77	--	V	--	--	--	--
2480	112.51	--	H	--	--	--	--
4960	52.88	45.75	V	54.0	94.8	-8.3	Pass*
4960	51.36	43.45	H	54.0	94.8	-10.6	Pass*

\*Field strength of emissions appearing within restricted frequency bands shall not exceed the limits in § 15.209.

### 5.4.4.3. Band-Edge Radiated Emissions

**Plot 5.4.4.3.1.** Band-Edge Radiated Emissions, EUT with 1.72 dBi Chip Antenna, Lower Band-edge Rx Antenna in Vertical Polarization, GFSK Modulation, 1 Mbps, Power Setting 200, Ch 37, 2402 MHz

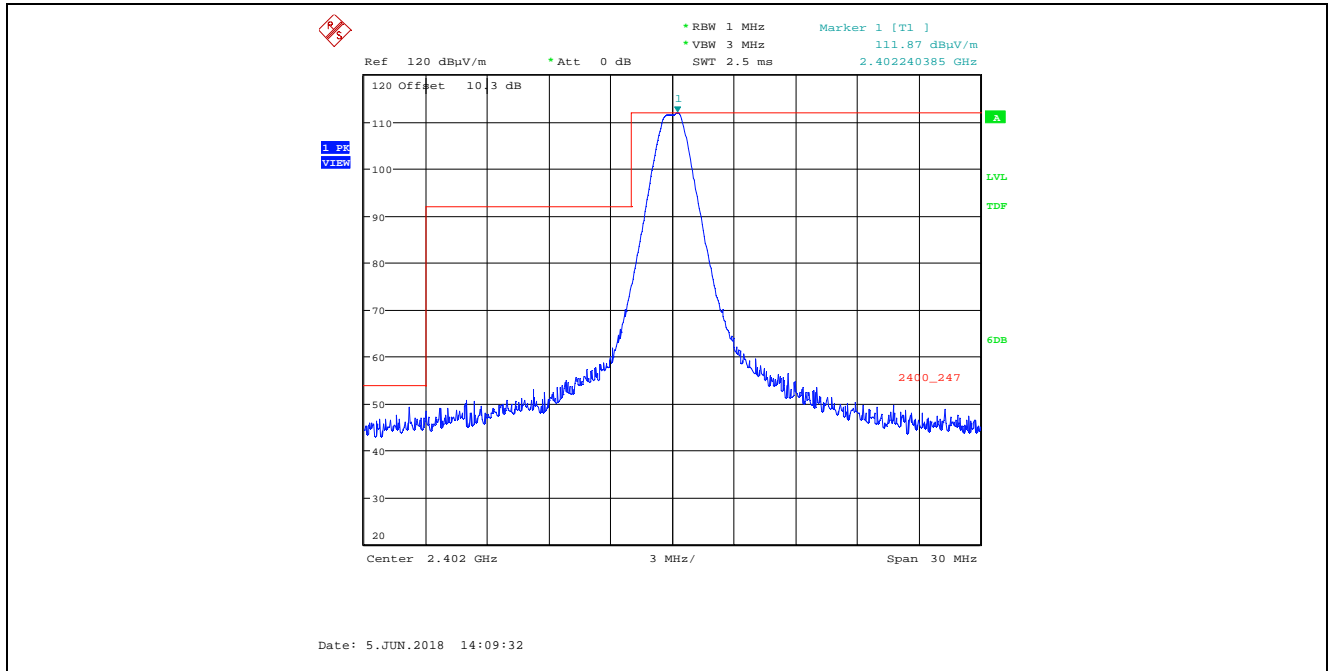

**Plot 5.4.4.3.2.** Band-Edge Radiated Emissions, EUT with 1.72 dBi Chip Antenna, Lower Band-edge Rx Antenna in Horizontal Polarization, GFSK Modulation, 1 Mbps, Power Setting 200, Ch 37, 2402 MHz

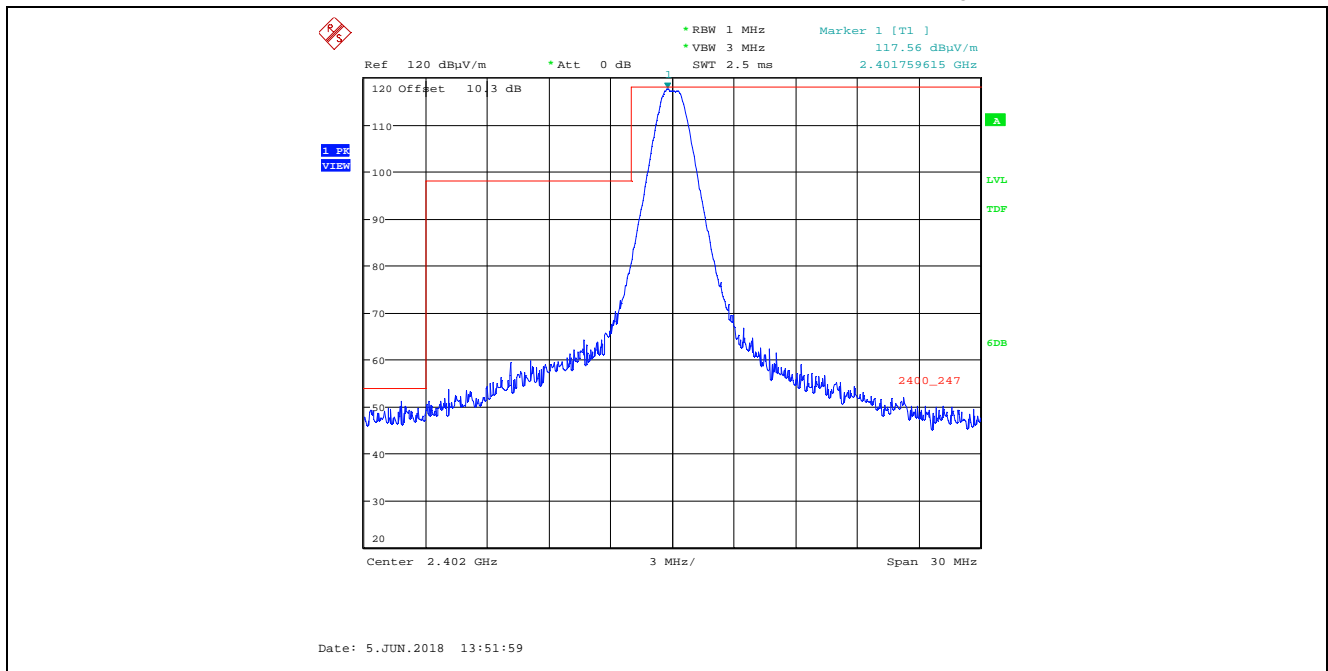



**Plot 5.4.4.3.3.** Band-Edge Radiated Emissions, EUT with 1.72 dBi Chip Antenna, Higher Band-edge Rx Antenna in Vertical Polarization, GFSK Modulation, 1 Mbps, Power Setting 200, Ch 39, 2480 MHz

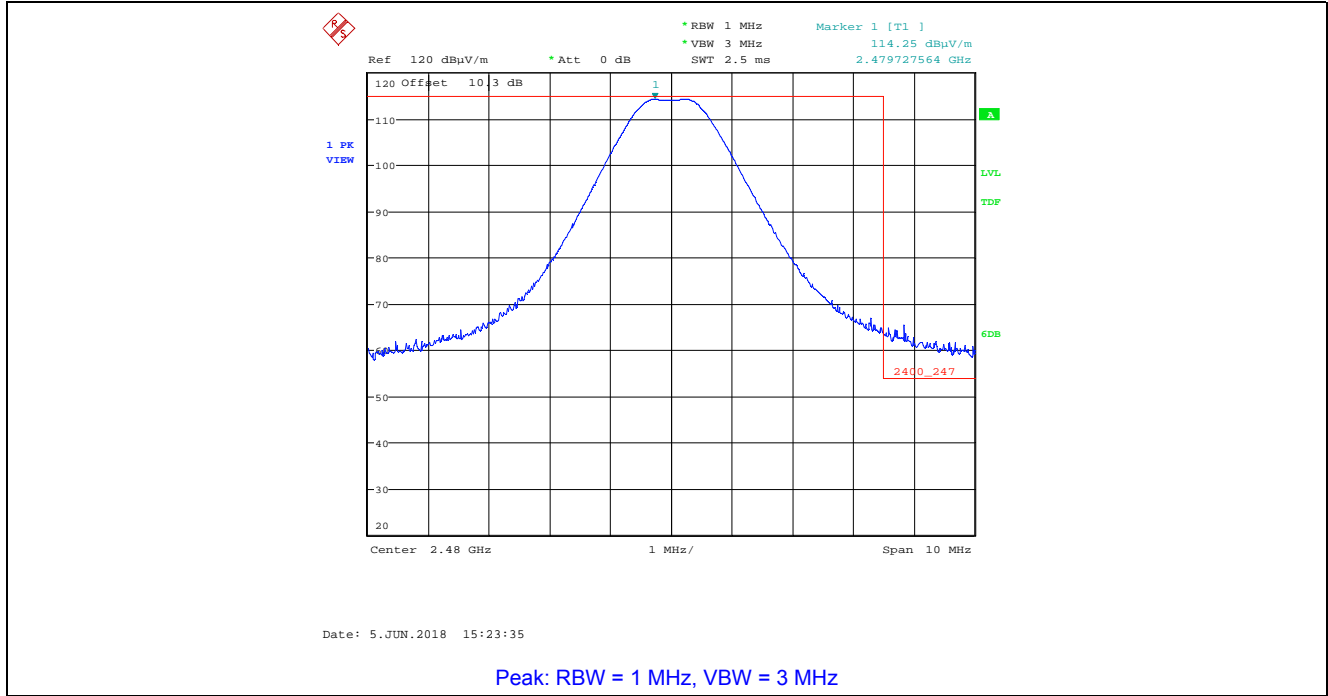

**Plot 5.4.4.3.4.** Band-Edge Radiated Emissions, EUT with 1.72 dBi Chip Antenna, Higher Band-edge Rx Antenna in Vertical Polarization, GFSK Modulation, 1 Mbps, Power Setting 200, Ch 39, 2480 MHz

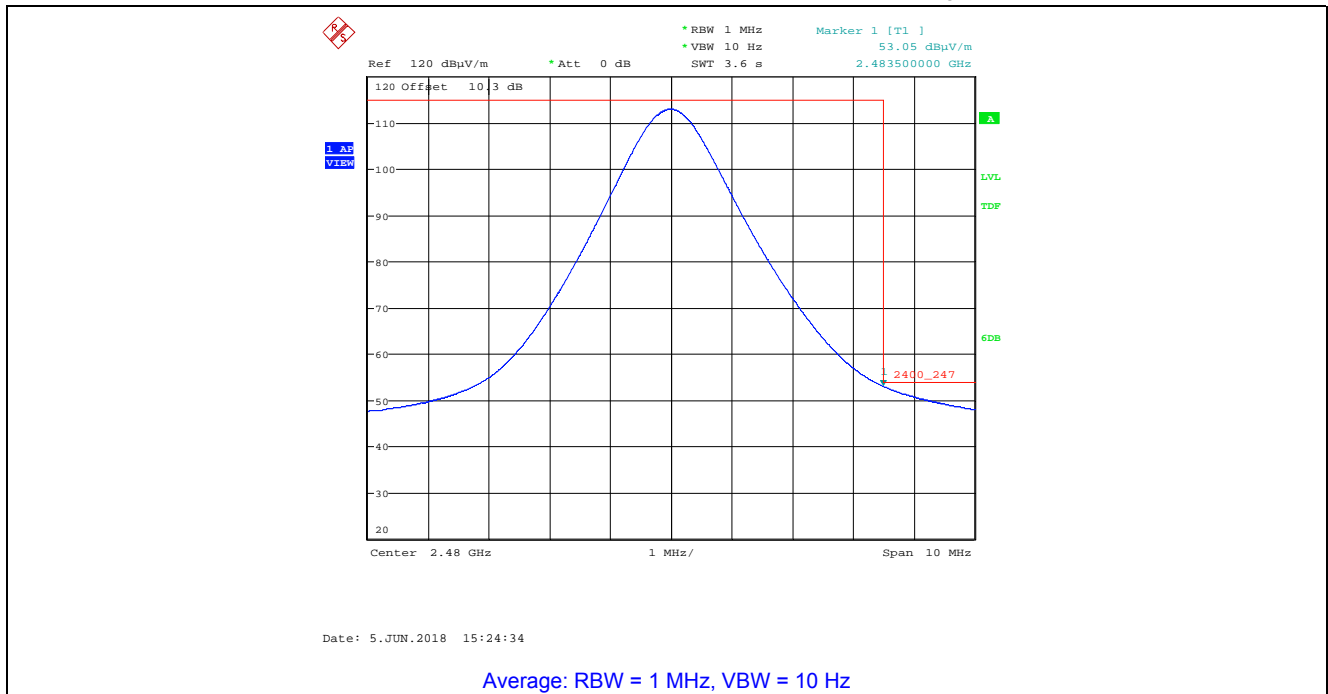

**Plot 5.4.4.3.5.** Band-Edge Radiated Emissions, EUT with 1.72 dBi Chip Antenna, Higher Band-edge Rx Antenna in Horizontal Polarization, GFSK Modulation, 1 Mbps, Power Setting 200, Ch 39, 2480 MHz

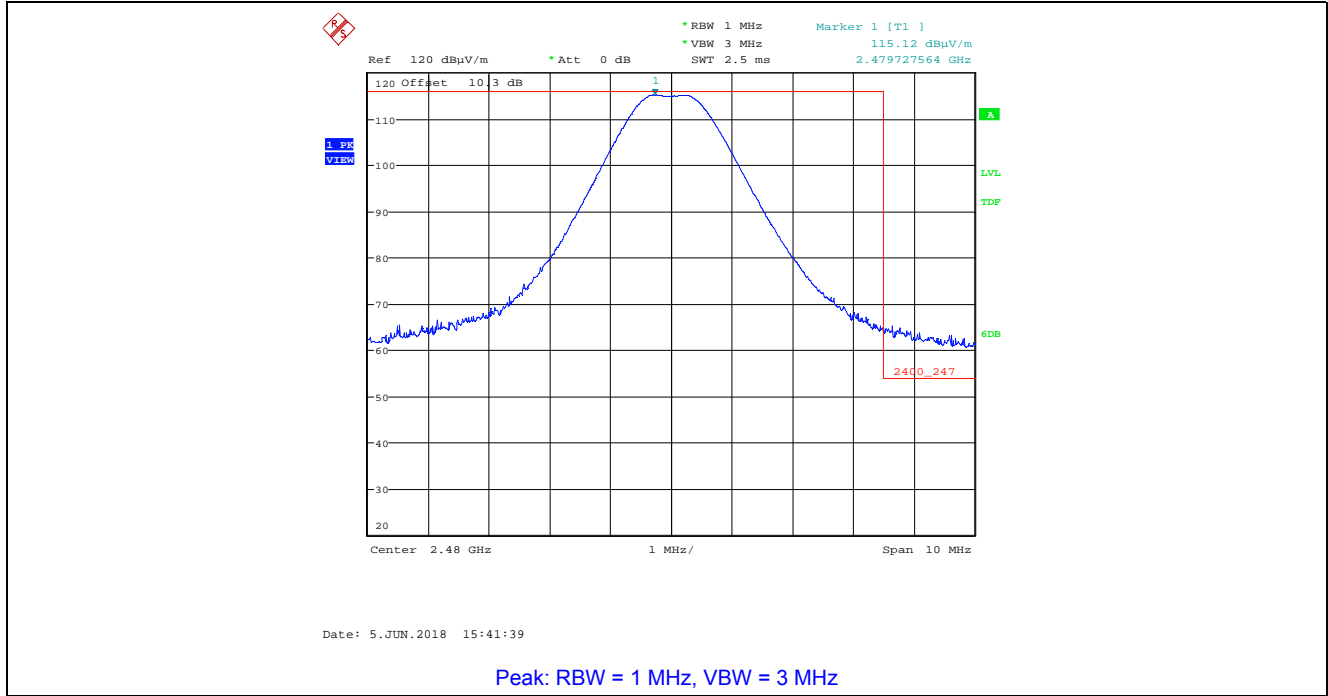

**Plot 5.4.4.3.6.** Band-Edge Radiated Emissions, EUT with 1.72 dBi Chip Antenna, Higher Band-edge Rx Antenna in Horizontal Polarization, GFSK Modulation, 1 Mbps, Power Setting 200, Ch 39, 2480 MHz

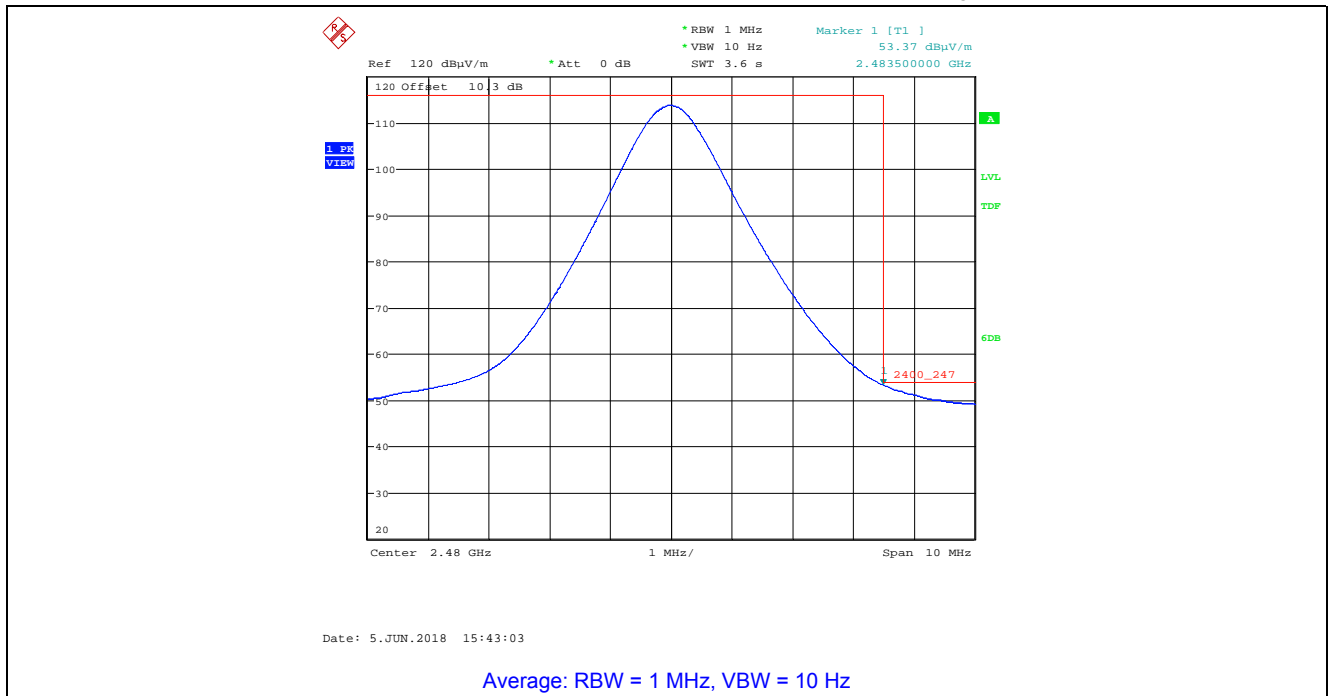

**Plot 5.4.4.3.7.** Band-Edge Radiated Emissions, EUT with 1.72 dBi Chip Antenna, Lower Band-edge Rx Antenna in Vertical Polarization, GFSK Modulation, 2 Mbps, Power Setting 200, Ch 00, 2404 MHz

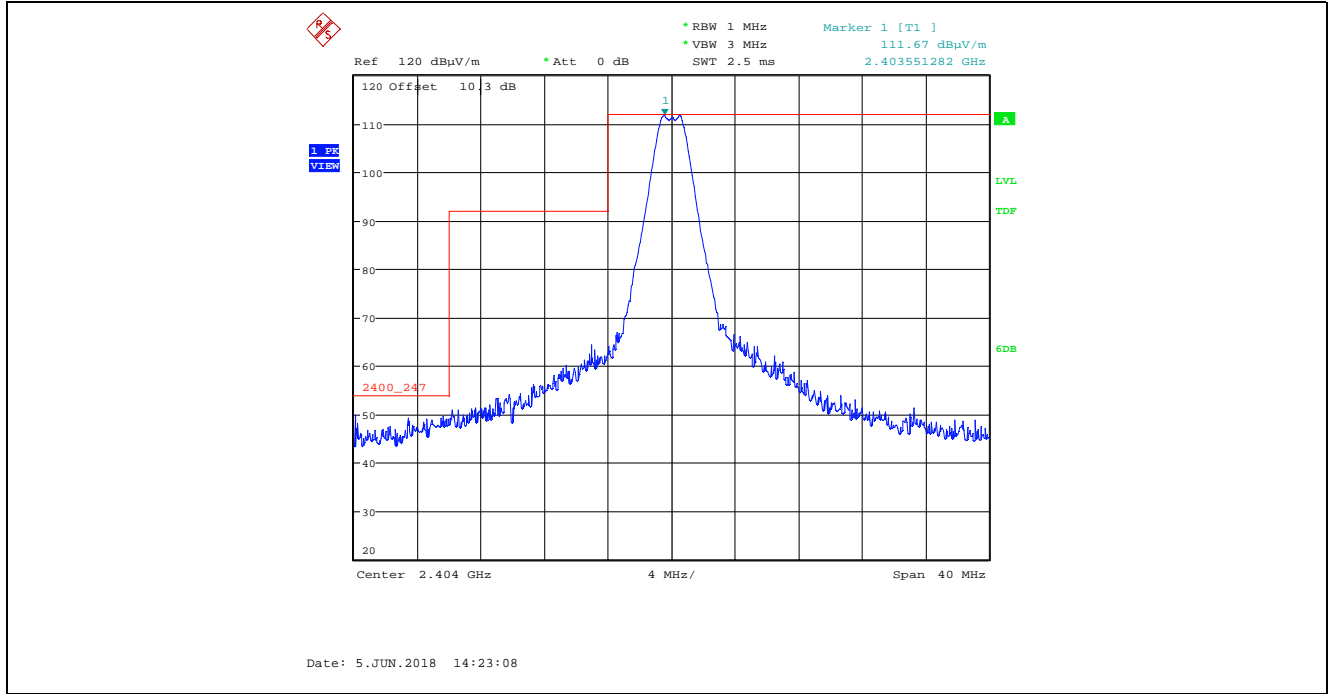

**Plot 5.4.4.3.8.** Band-Edge Radiated Emissions, EUT with 1.72 dBi Chip Antenna, Lower Band-edge Rx Antenna in Horizontal Polarization, GFSK Modulation, 2 Mbps, Power Setting 200, Ch 00, 2404 MHz

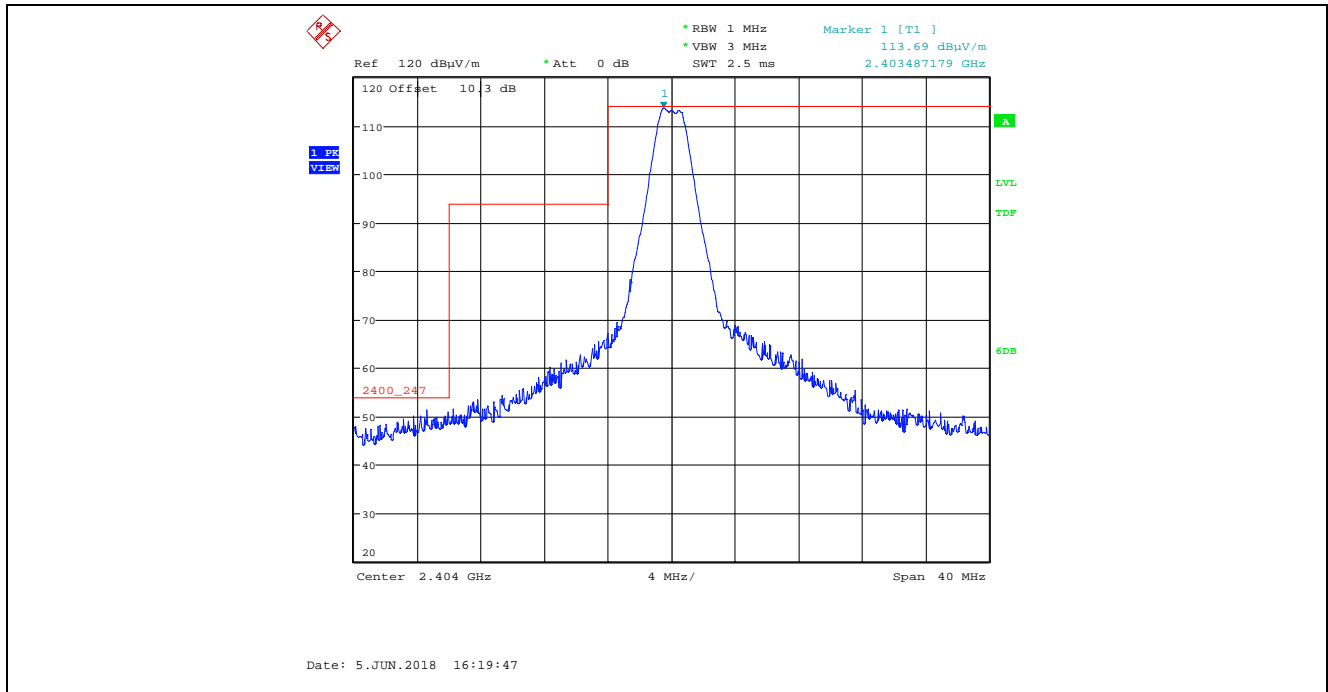

**Plot 5.4.4.3.9.** Band-Edge Radiated Emissions, EUT with 1.72 dBi Chip Antenna, Higher Band-edge Rx Antenna in Vertical Polarization, GFSK Modulation, 2 Mbps, Power Setting 200, Ch 36, 2478 MHz

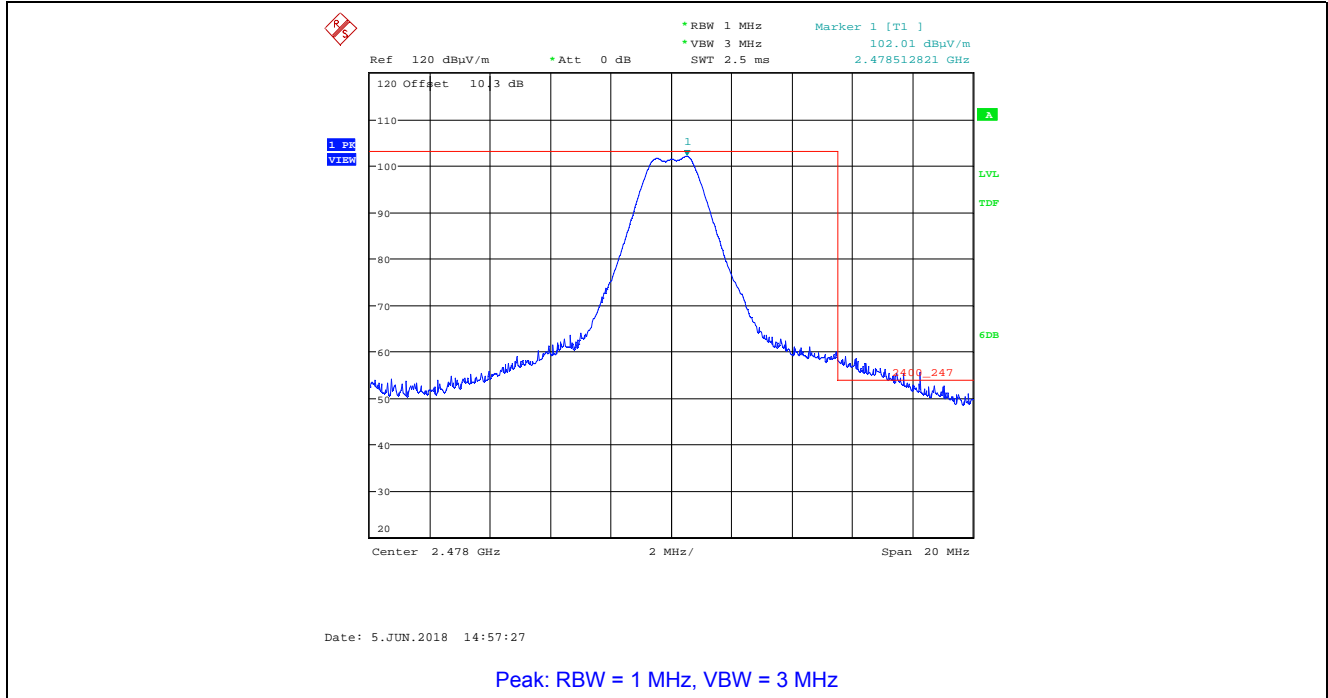

**Plot 5.4.4.3.10.** Band-Edge Radiated Emissions, EUT with 1.72 dBi Chip Antenna, Higher Band-edge Rx Antenna in Vertical Polarization, GFSK Modulation, 2 Mbps, Power Setting 200, Ch 36, 2478 MHz

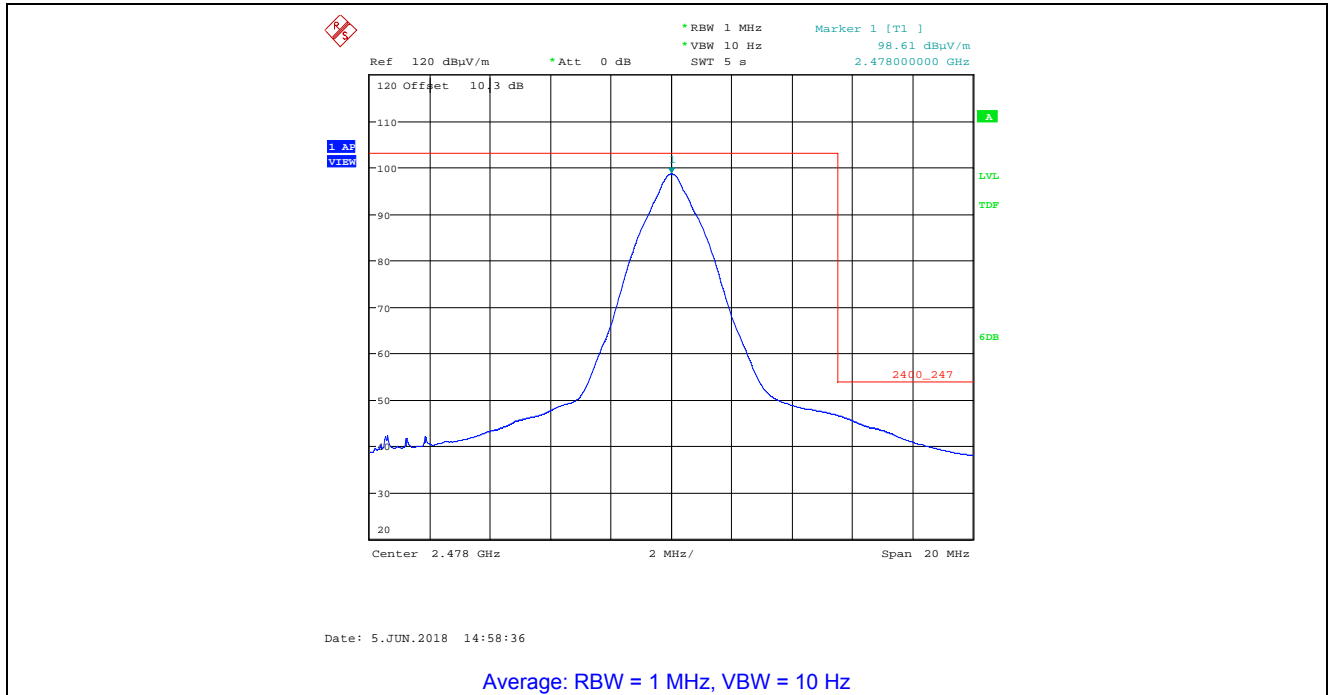

**Plot 5.4.4.3.11.** Band-Edge Radiated Emissions, EUT with 1.72 dBi Chip Antenna, Higher Band-edge Rx Antenna in Horizontal Polarization, GFSK Modulation, 2 Mbps, Power Setting 200, Ch 36, 2478 MHz

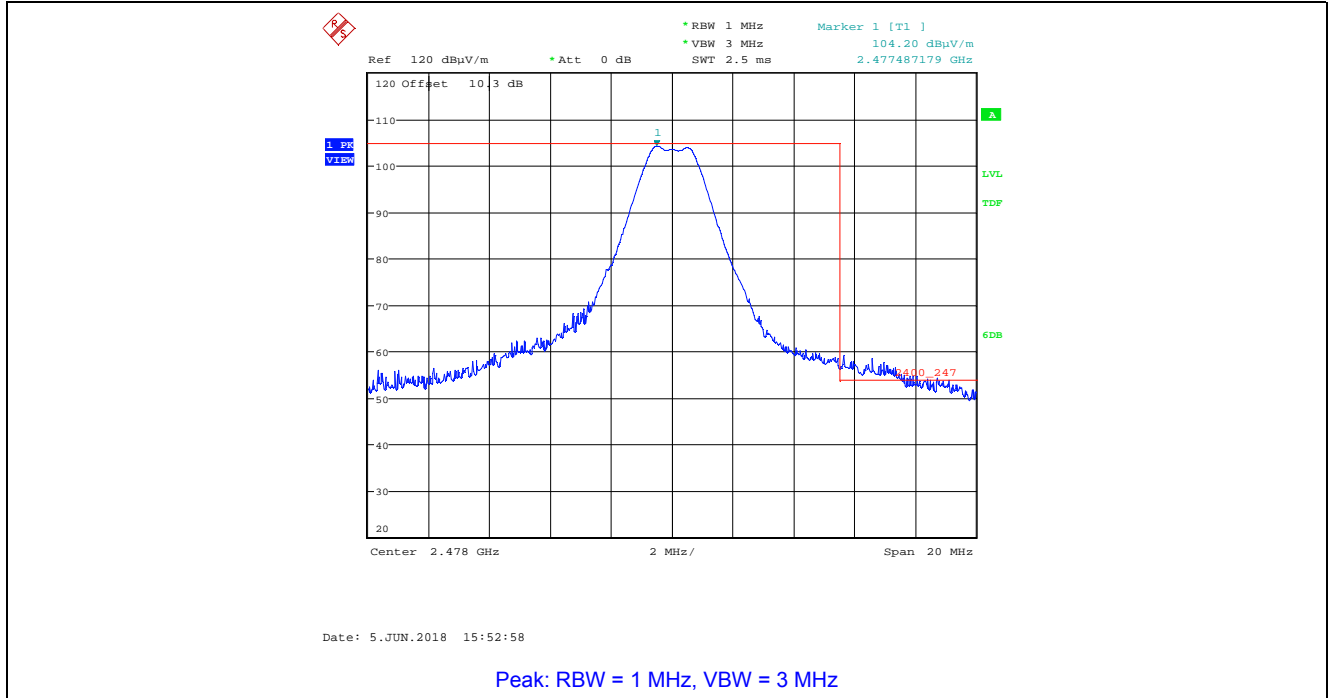

**Plot 5.4.4.3.12.** Band-Edge Radiated Emissions, EUT with 1.72 dBi Chip Antenna, Higher Band-edge Rx Antenna in Horizontal Polarization, GFSK Modulation, 2 Mbps, Power Setting 200, Ch 36, 2478 MHz

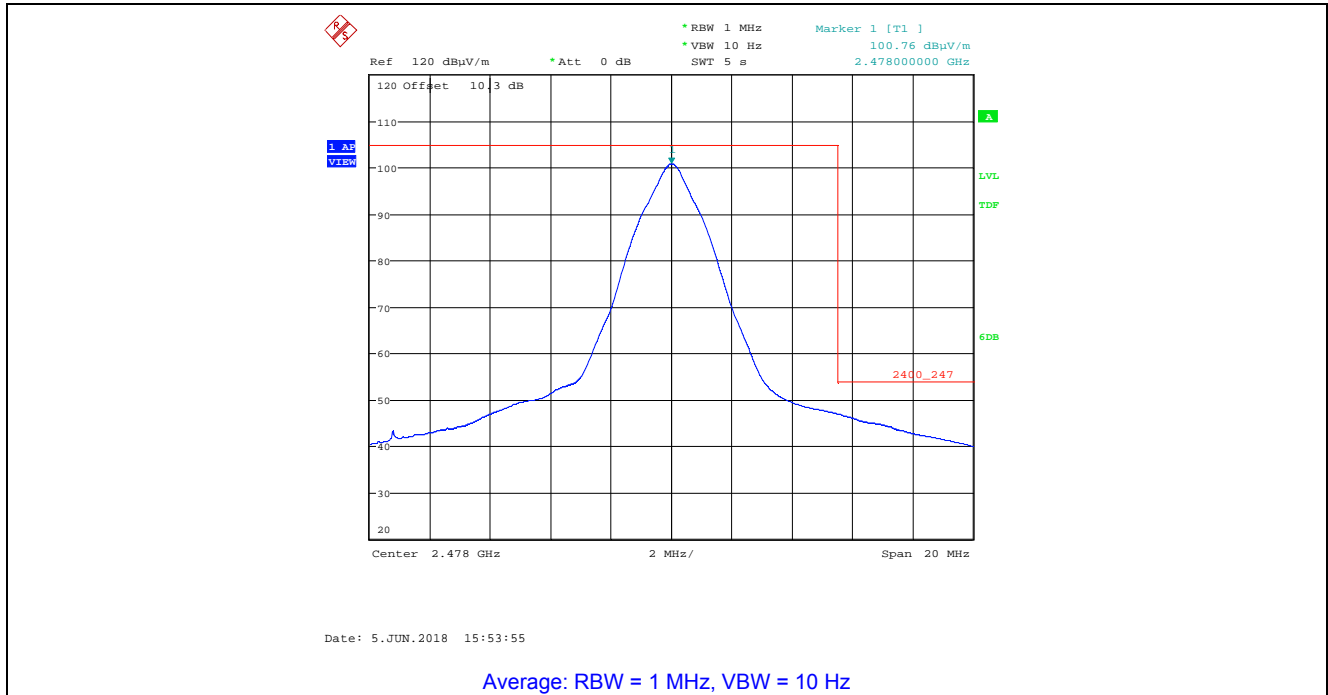

**Plot 5.4.4.3.13.** Band-Edge Radiated Emissions, EUT with 5 dBi Dipole Antenna, Lower Band-edge Rx Antenna in Vertical Polarization, GFSK Modulation, 1 Mbps, Power Setting 200, Ch 37, 2402 MHz

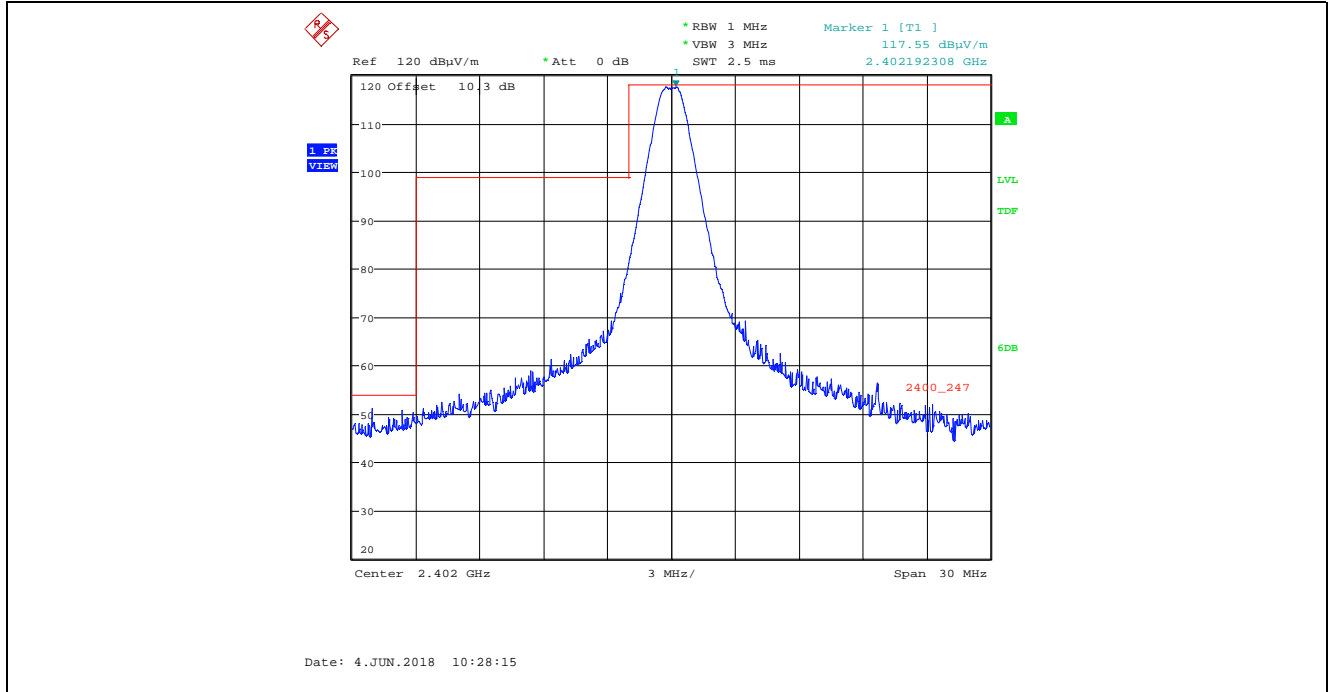

**Plot 5.4.4.3.14.** Band-Edge Radiated Emissions, EUT with 5 dBi Dipole Antenna, Lower Band-edge Rx Antenna in Horizontal Polarization, GFSK Modulation, 1 Mbps, Power Setting 200, Ch 37, 2402 MHz

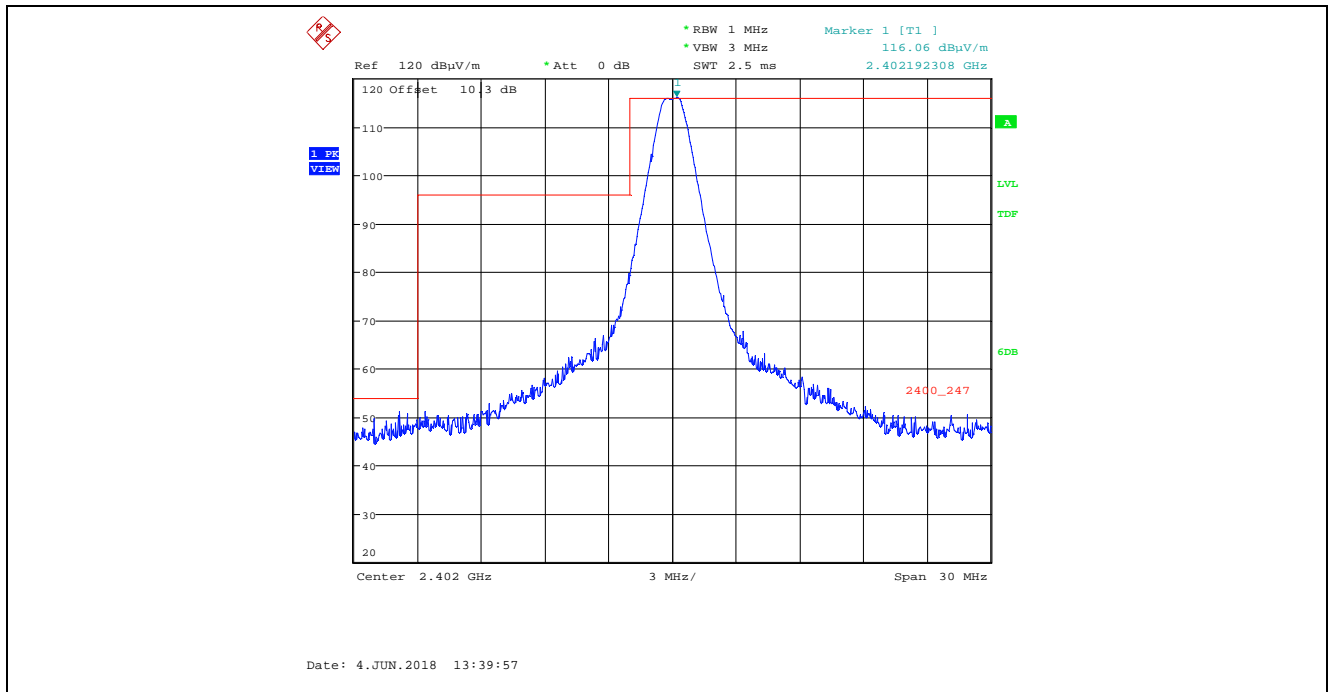

**Plot 5.4.4.3.15.** Band-Edge Radiated Emissions, EUT with 5 dBi Dipole Antenna, Higher Band-edge Rx Antenna in Vertical Polarization, GFSK Modulation, 1 Mbps, Power Setting 200, Ch 36, 2478 MHz

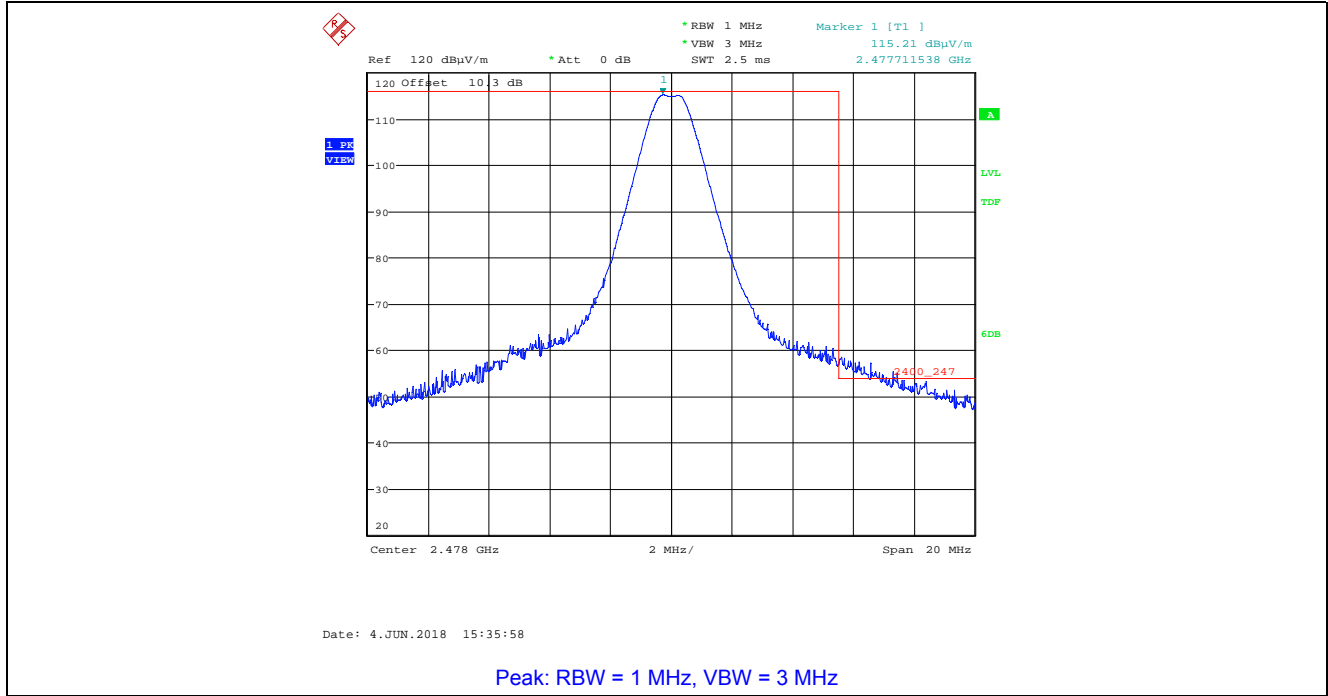

**Plot 5.4.4.3.16.** Band-Edge Radiated Emissions, EUT with 5 dBi Dipole Antenna, Higher Band-edge Rx Antenna in Vertical Polarization, GFSK Modulation, 1 Mbps, Power Setting 200, Ch 36, 2478 MHz

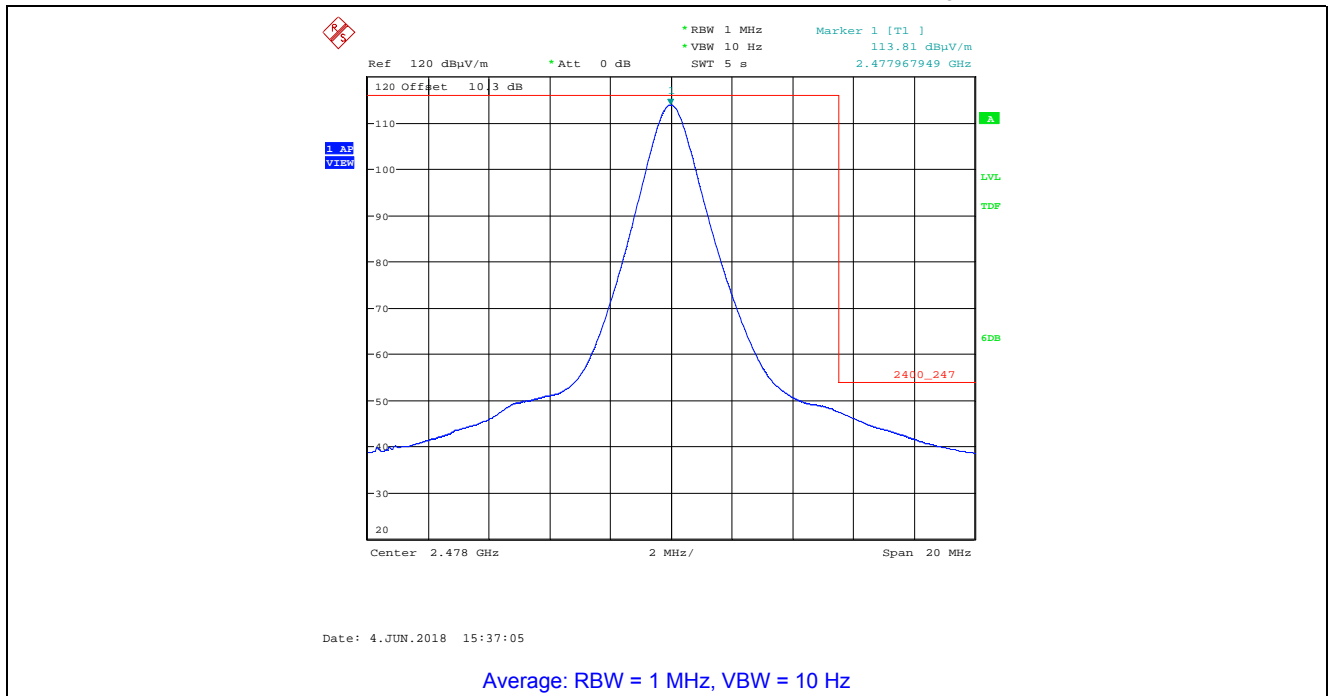

**Plot 5.4.4.3.17.** Band-Edge Radiated Emissions, EUT with 5 dBi Dipole Antenna, Higher Band-edge Rx Antenna in Horizontal Polarization, GFSK Modulation, 1 Mbps, Power Setting 200, Ch 36, 2478 MHz

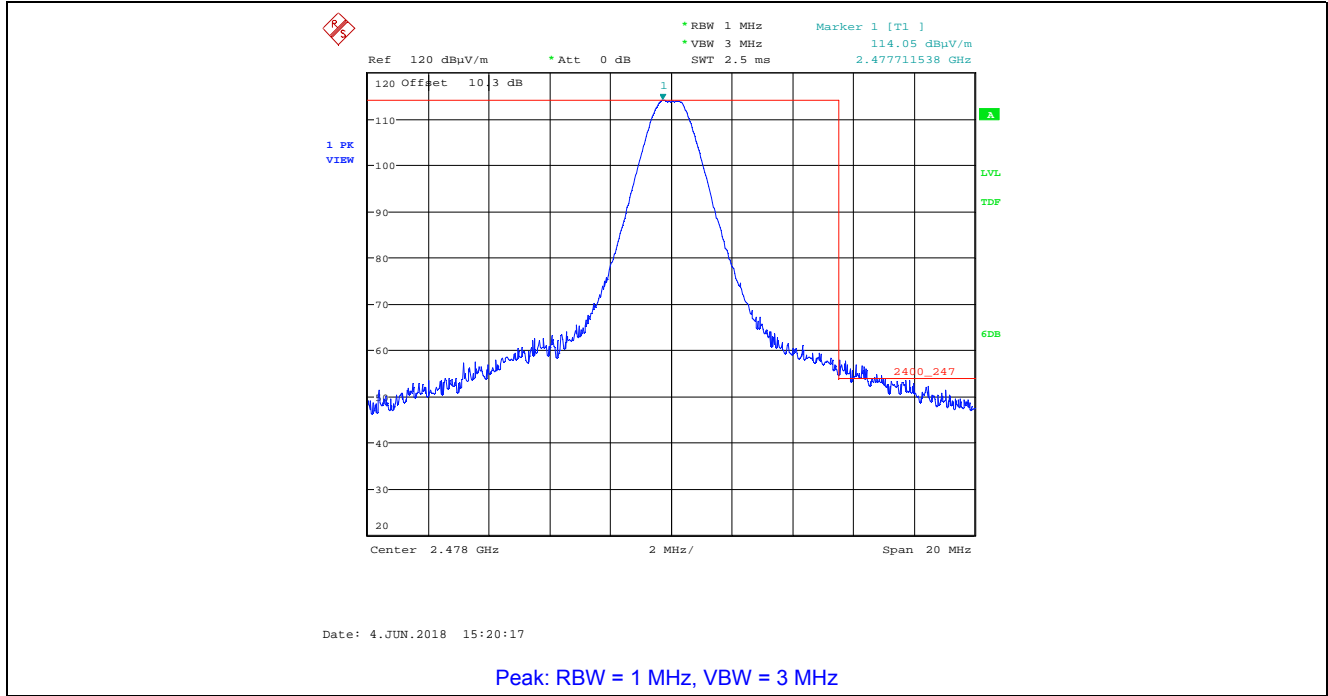

**Plot 5.4.4.3.18.** Band-Edge Radiated Emissions, EUT with 5 dBi Dipole Antenna, Higher Band-edge Rx Antenna in Horizontal Polarization, GFSK Modulation, 1 Mbps, Power Setting 200, Ch 36, 2478 MHz

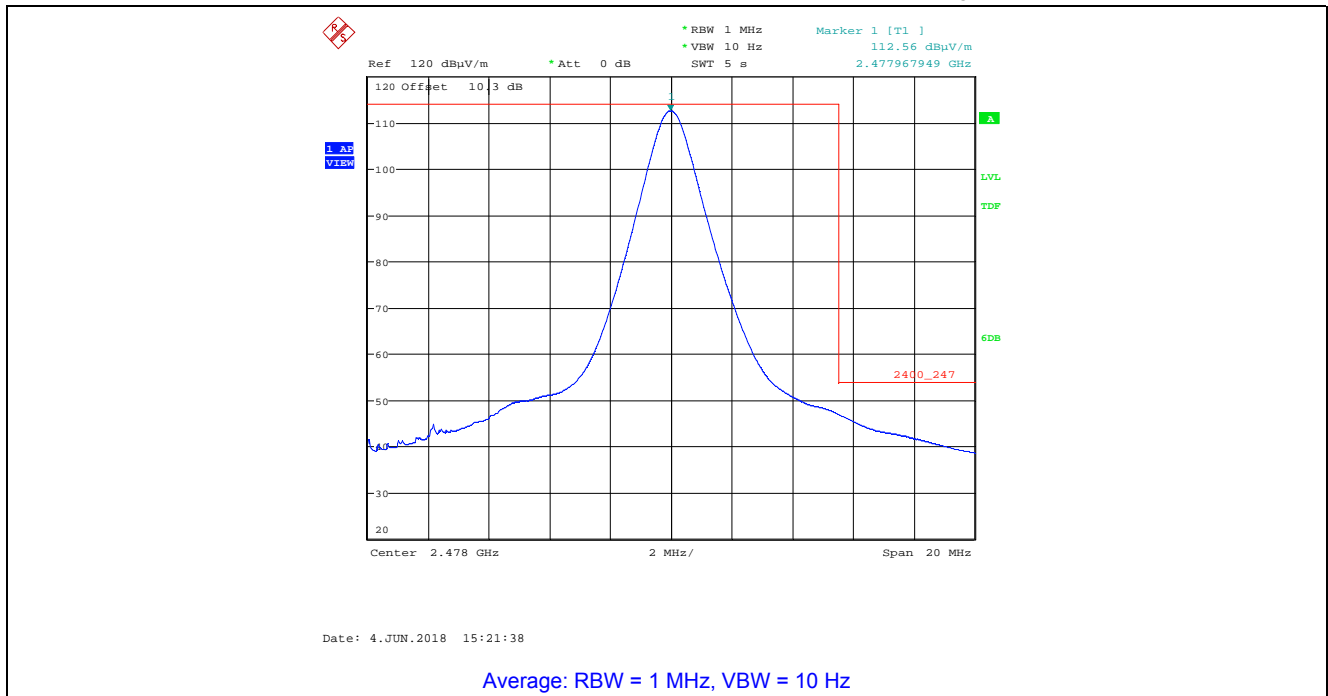



**Plot 5.4.4.3.19.** Band-Edge Radiated Emissions, EUT with 5 dBi Dipole Antenna, Higher Band-edge Rx Antenna in Vertical Polarization, GFSK Modulation, 1 Mbps, Power Setting 160, Ch 39, 2480 MHz

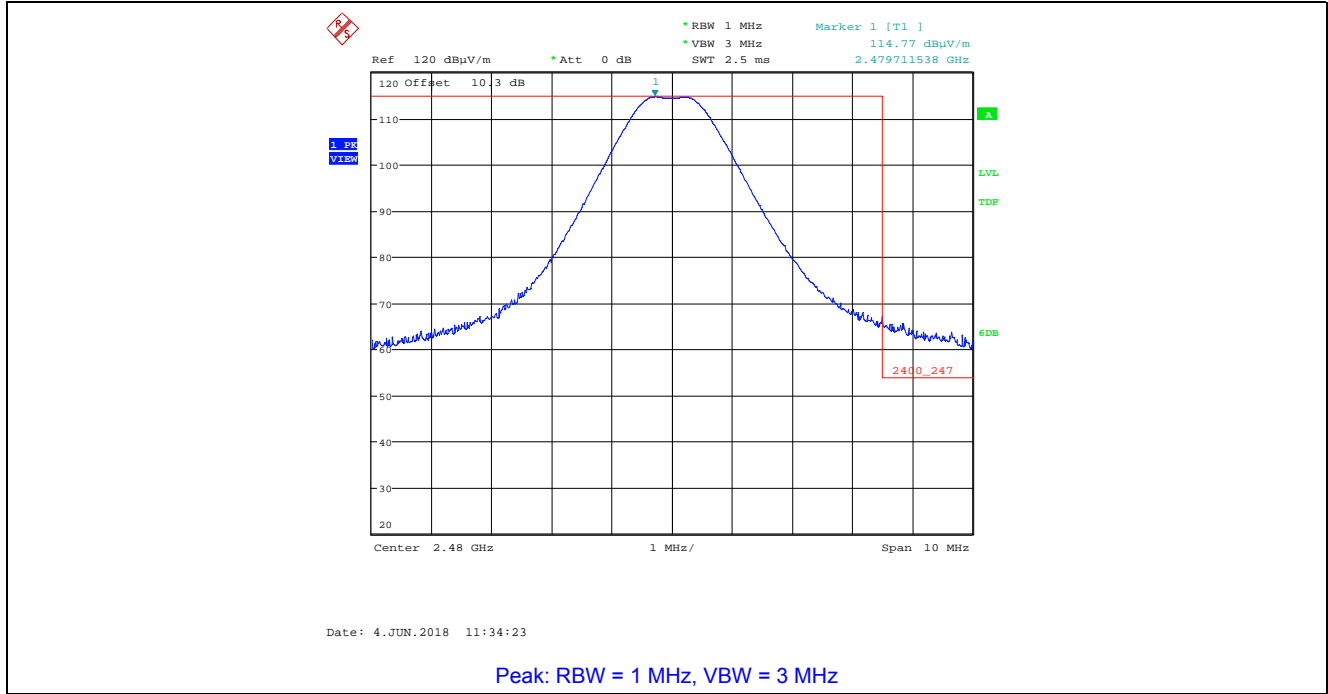

**Plot 5.4.4.3.20.** Band-Edge Radiated Emissions, EUT with 5 dBi Dipole Antenna, Higher Band-edge Rx Antenna in Vertical Polarization, GFSK Modulation, 1 Mbps, Power Setting 160, Ch 39, 2480 MHz

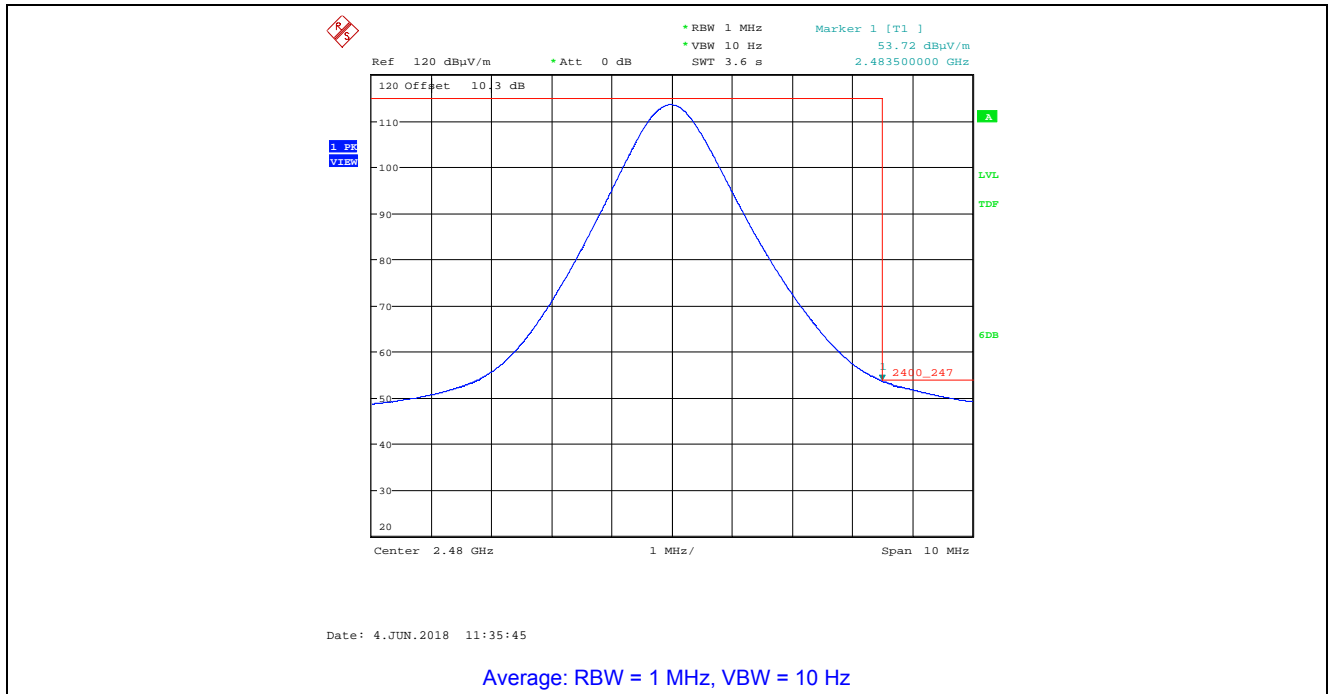

**Plot 5.4.4.3.21.** Band-Edge Radiated Emissions, EUT with 5 dBi Dipole Antenna, Higher Band-edge Rx Antenna in Horizontal Polarization, GFSK Modulation, 1 Mbps, Power Setting 160, Ch 39, 2480 MHz

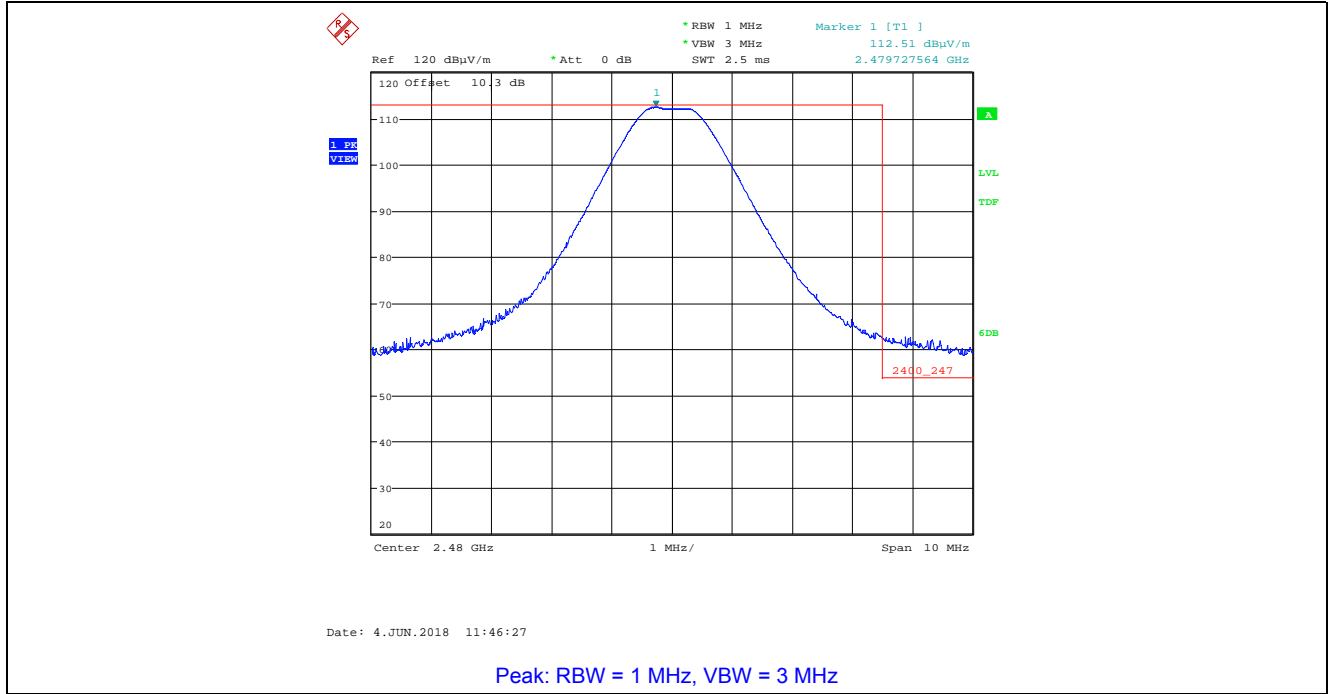

**Plot 5.4.4.3.22.** Band-Edge Radiated Emissions, EUT with 5 dBi Dipole Antenna, Higher Band-edge Rx Antenna in Horizontal Polarization, GFSK Modulation, 1 Mbps, Power Setting 160, Ch 39, 2480 MHz

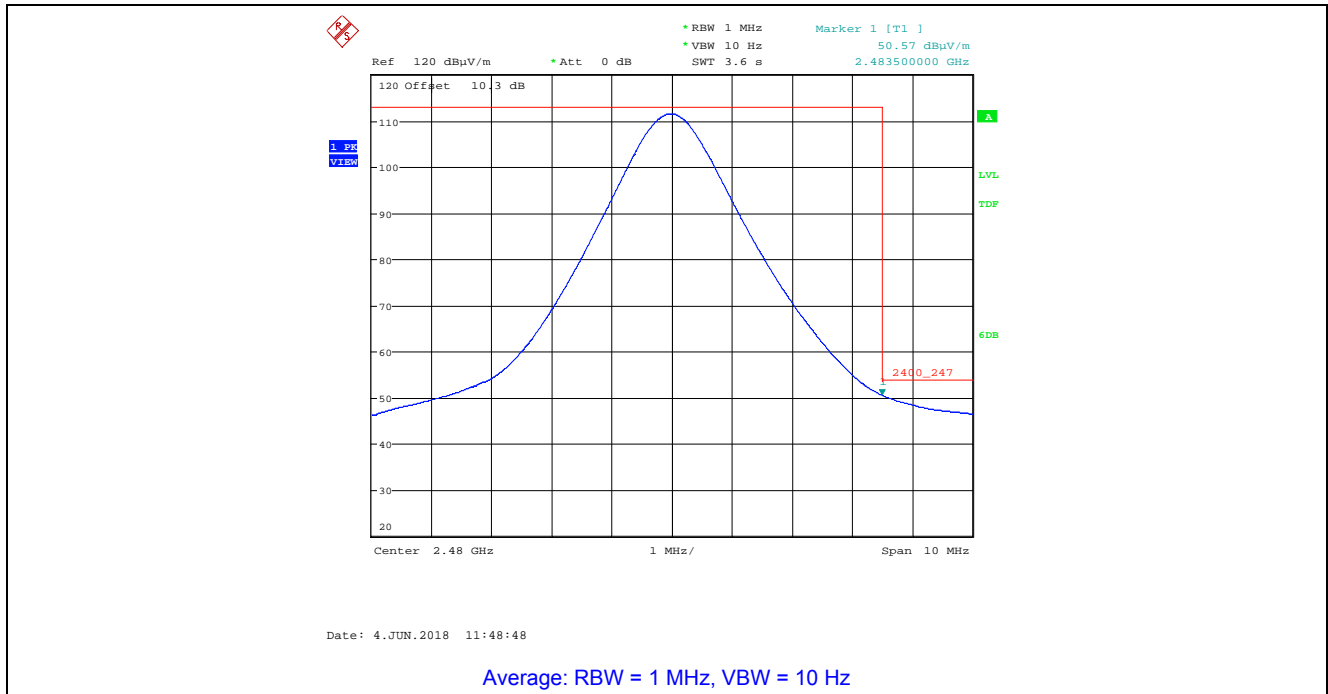

**Plot 5.4.4.3.23.** Band-Edge Radiated Emissions, EUT with 5 dBi Dipole Antenna, Lower Band-edge Rx Antenna in Vertical Polarization, GFSK Modulation, 2 Mbps, Power Setting 200, Ch 00, 2404 MHz

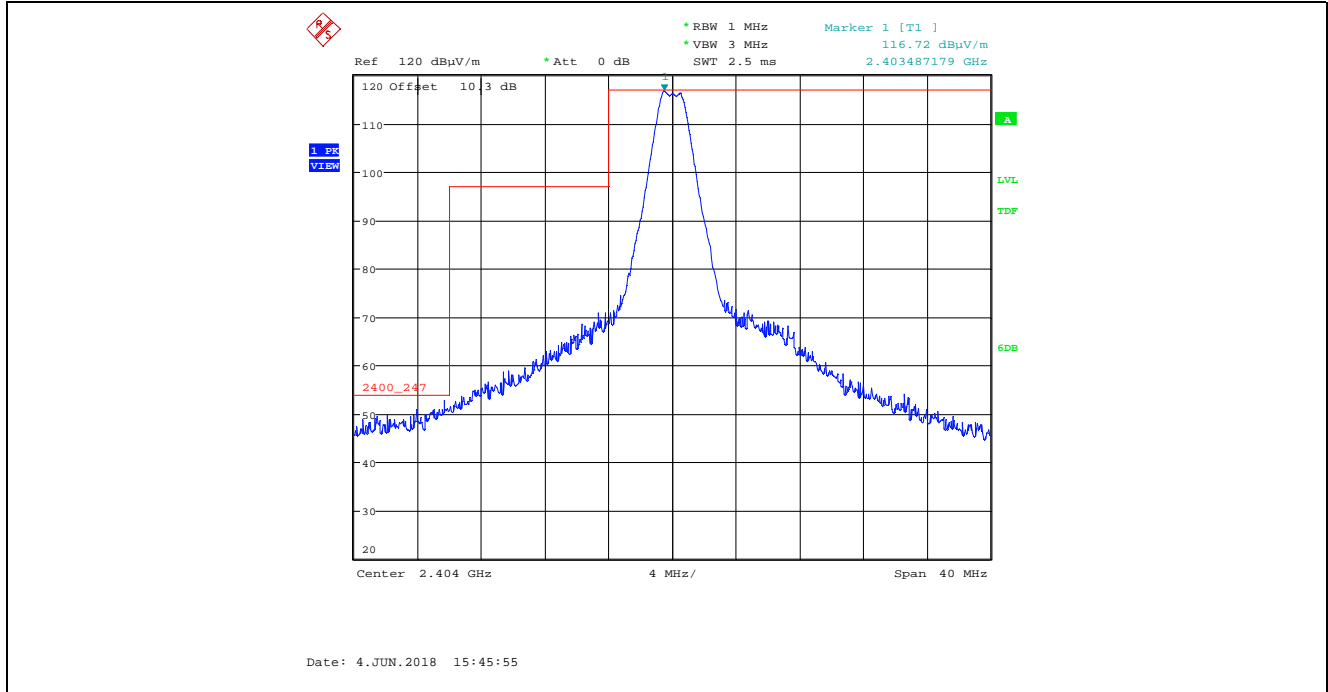

**Plot 5.4.4.3.24.** Band-Edge Radiated Emissions, EUT with 5 dBi Dipole Antenna, Lower Band-edge Rx Antenna in Horizontal Polarization, GFSK Modulation, 2 Mbps, Power Setting 200, Ch 00, 2404 MHz

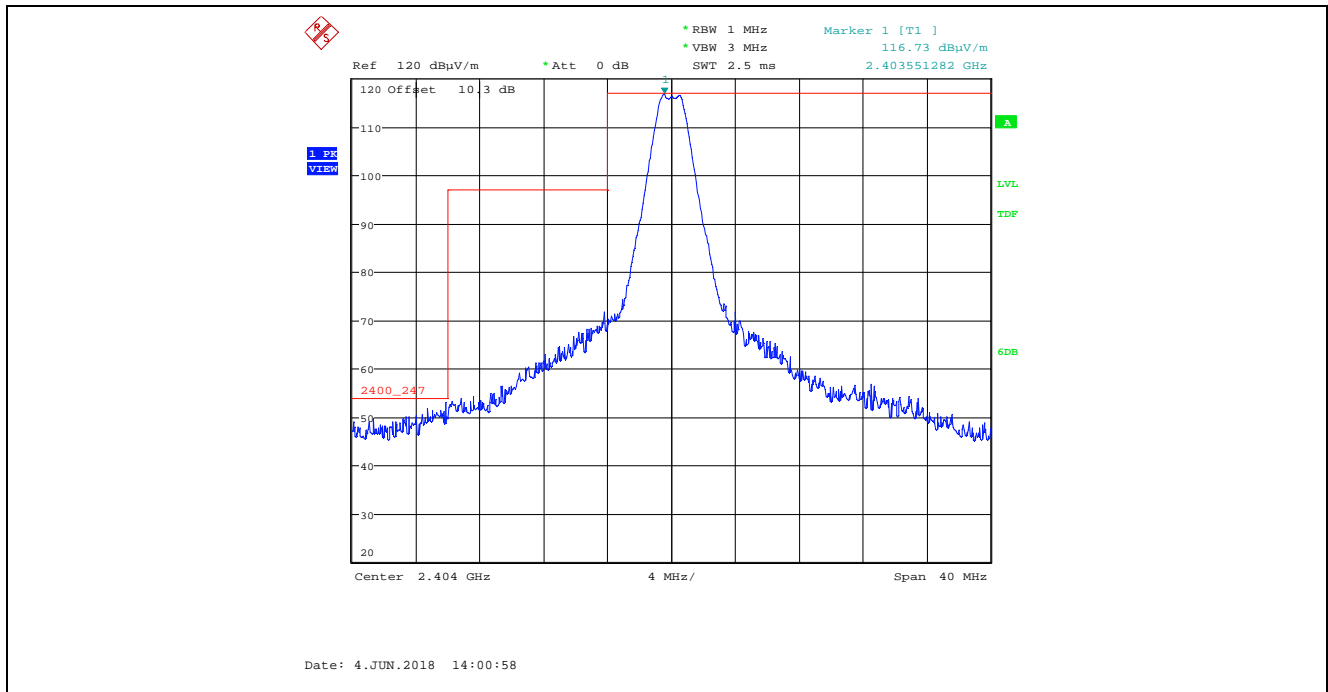

**Plot 5.4.4.3.25.** Band-Edge Radiated Emissions, EUT with 5 dBi Dipole Antenna, Higher Band-edge Rx Antenna in Vertical Polarization, GFSK Modulation, 2 Mbps, Power Setting 200, Ch 36, 2478 MHz

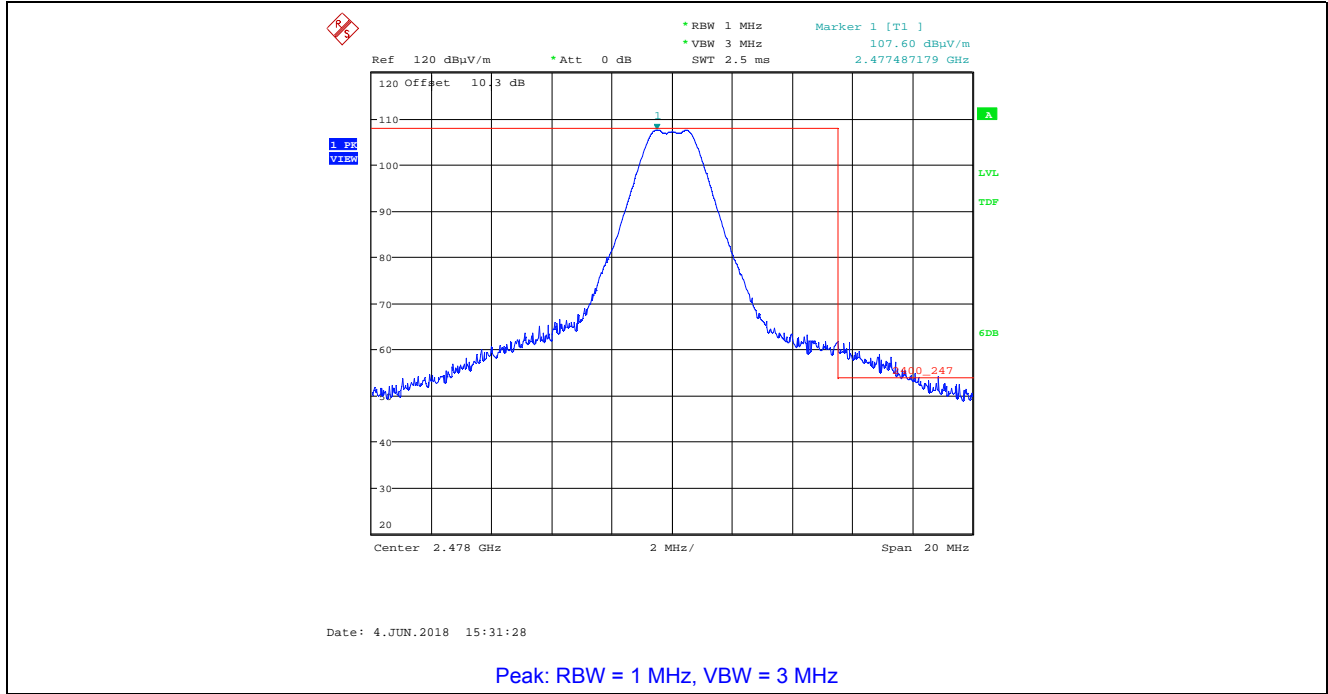

**Plot 5.4.4.3.26.** Band-Edge Radiated Emissions, EUT with 5 dBi Dipole Antenna, Higher Band-edge Rx Antenna in Vertical Polarization, GFSK Modulation, 2 Mbps, Power Setting 200, Ch 36, 2478 MHz

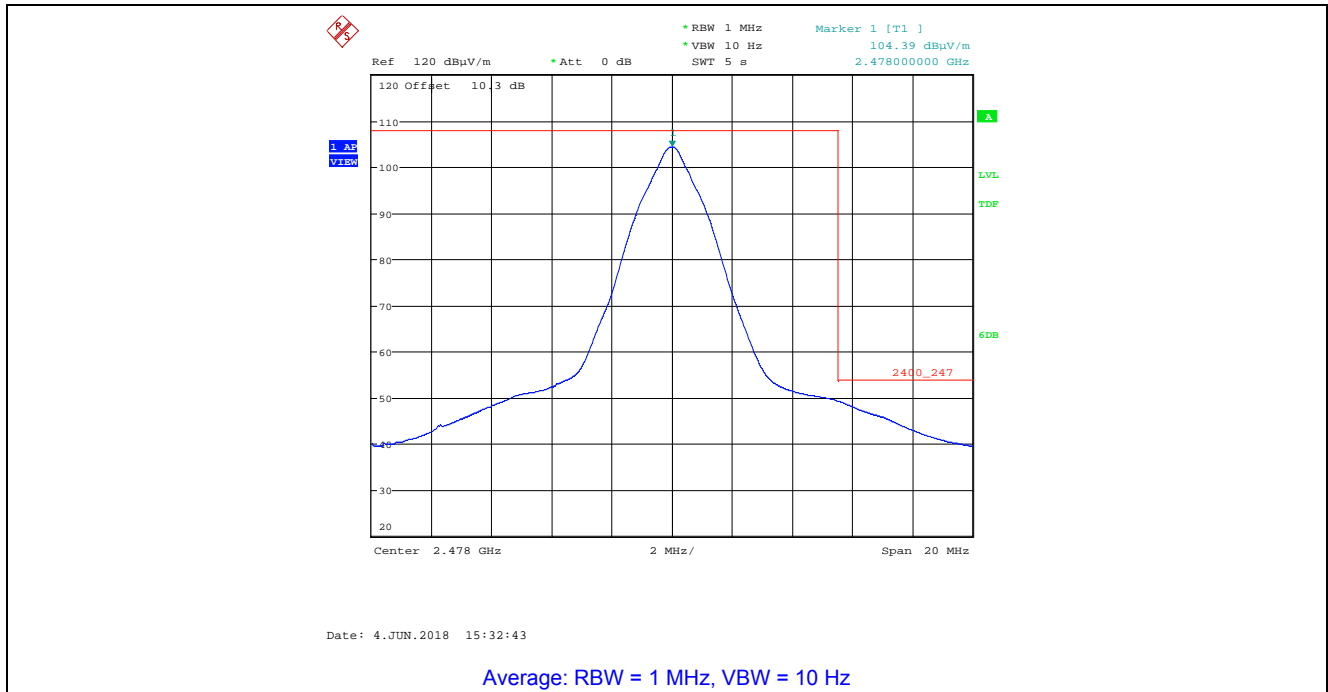

**Plot 5.4.4.3.27.** Band-Edge Radiated Emissions, EUT with 5 dBi Dipole Antenna, Higher Band-edge Rx Antenna in Horizontal Polarization, GFSK Modulation, 2 Mbps, Power Setting 200, Ch 36, 2478 MHz

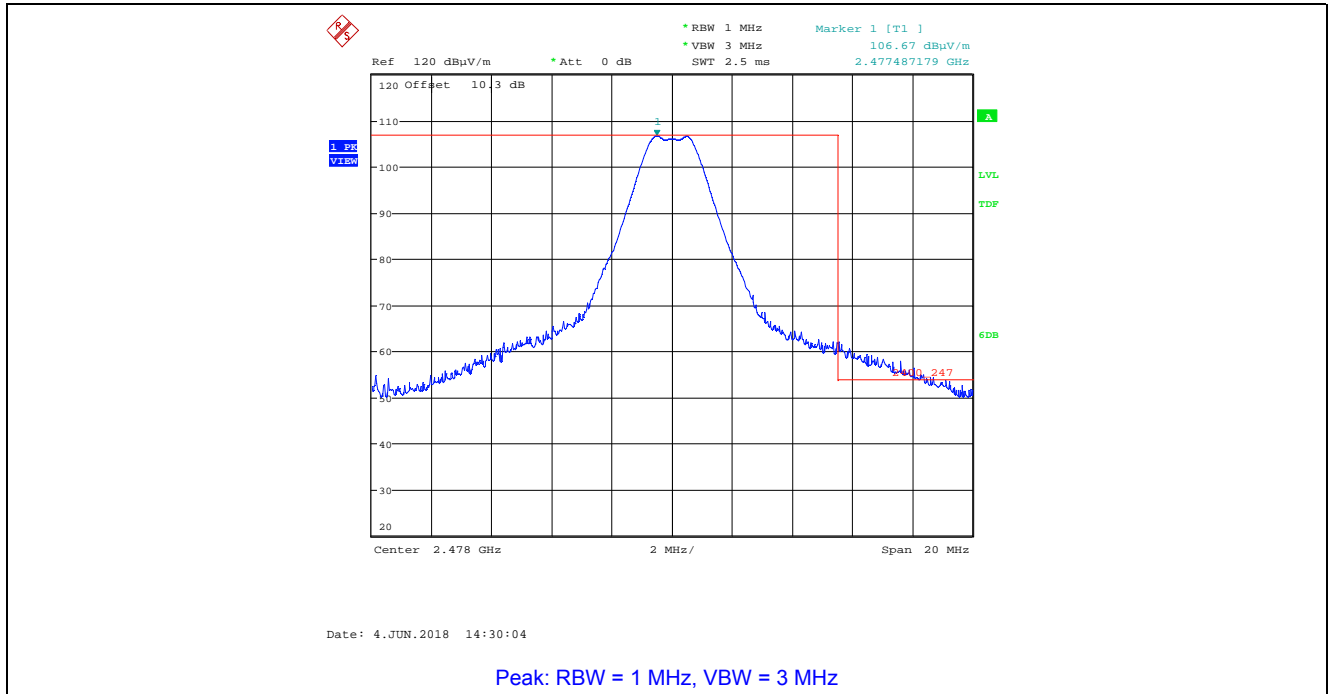

**Plot 5.4.4.3.28.** Band-Edge Radiated Emissions, EUT with 5 dBi Dipole Antenna, Higher Band-edge Rx Antenna in Horizontal Polarization, GFSK Modulation, 2 Mbps, Power Setting 200, Ch 36, 2478 MHz

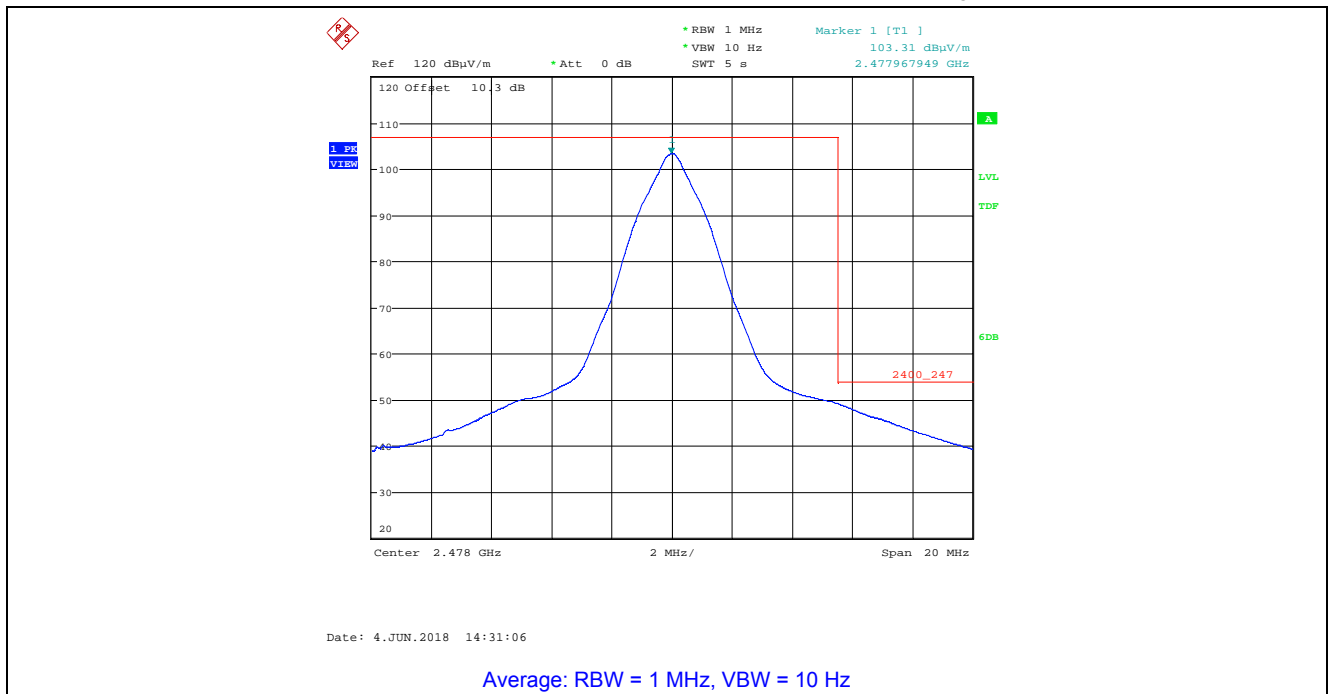

**5.5. POWER SPECTRAL DENSITY [§ 15.247(e)]**

**5.5.1. Limit(s)**

For digitally modulated systems, the power spectral density conducted from the intentional radiator to the antenna shall not be greater than 8 dBm in any 3 kHz band during any time interval of continuous transmission.

**5.5.2. Method of Measurements**

KDB 558074 D01 DTS Meas Guidance V04, Section 10.2 Method PKPSD (peak PSD)

**5.5.3. Test Arrangement**

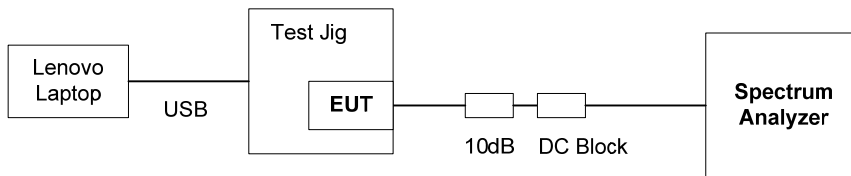

USB provide 5 Vdc and software to operate radio module

**5.5.4. Test Data**

Modulation	Data Rate (Mbps)	Power Setting	Channel	Frequency (MHz)	PSD (dBm)	Max. Limit (dBm)	Margin (dBm)
GFSK	1	200	37	2402	2.81	8	-5.19
		200	17	2440	2.71	8	-5.29
		200	39	2480	2.68	8	-5.32
	2	200	00	2404	-0.82	8	-8.82
		200	17	2440	-0.83	8	-8.83
		200	36	2478	-13.17	8	-21.17

Plot 5.5.4.1. Power Spectral Density, GFSK Modulation, 1 Mbps, Power Setting 200, Channel 37, 2402 MHz

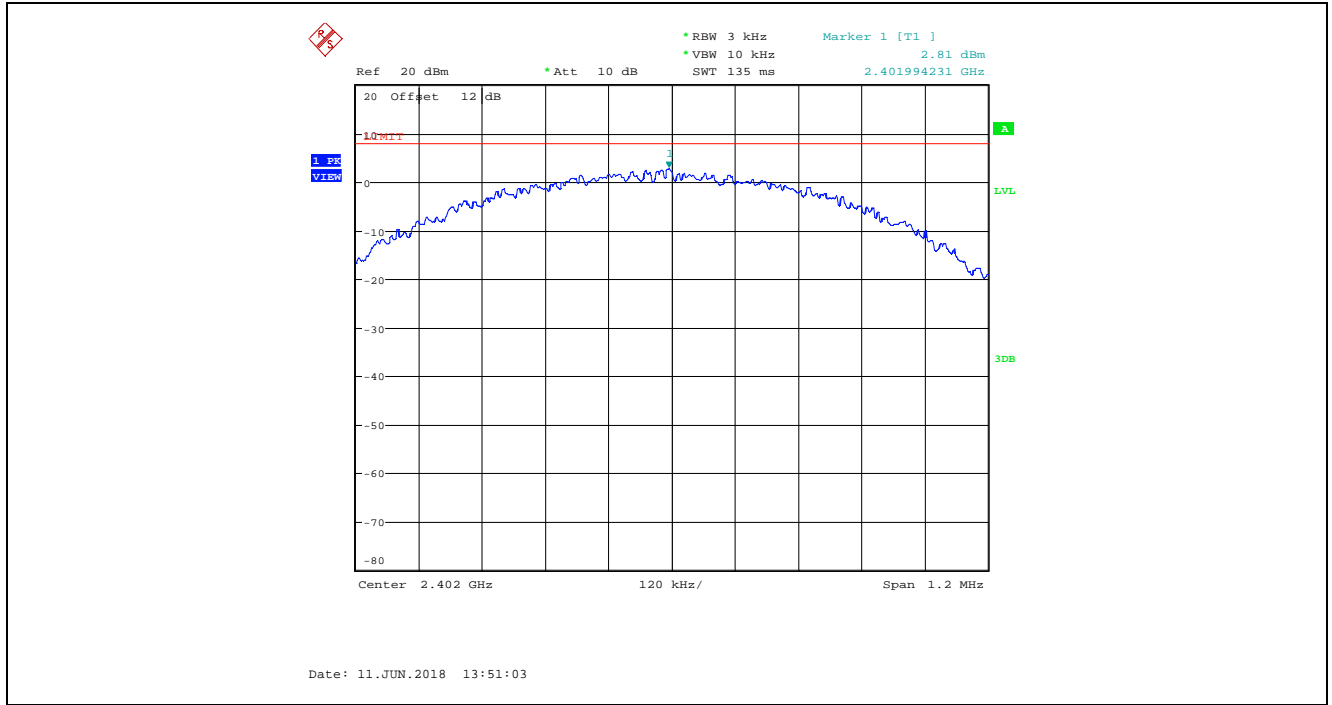

Plot 5.5.4.2. Power Spectral Density, GFSK Modulation, 1 Mbps, Power Setting 200, Channel 17, 2440 MHz

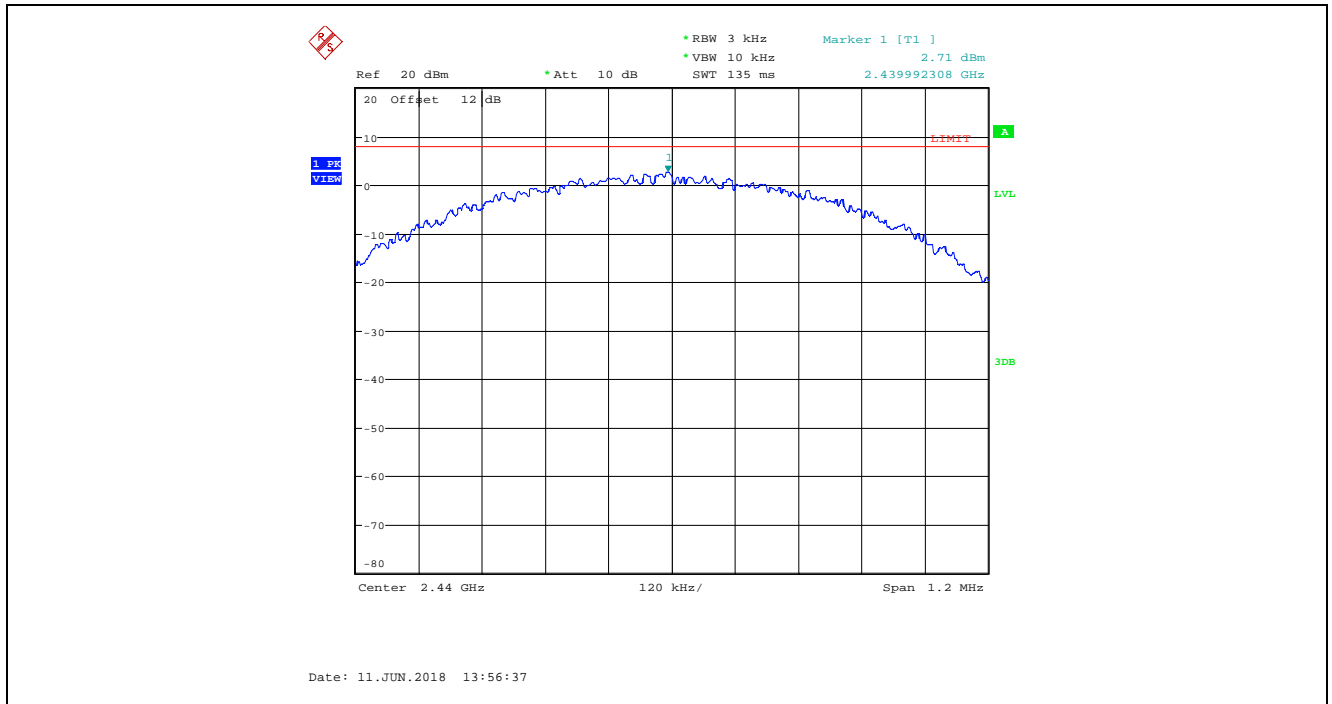

Plot 5.5.4.3. Power Spectral Density, GFSK Modulation, 1 Mbps, Power Setting 200, Channel 39, 2480 MHz

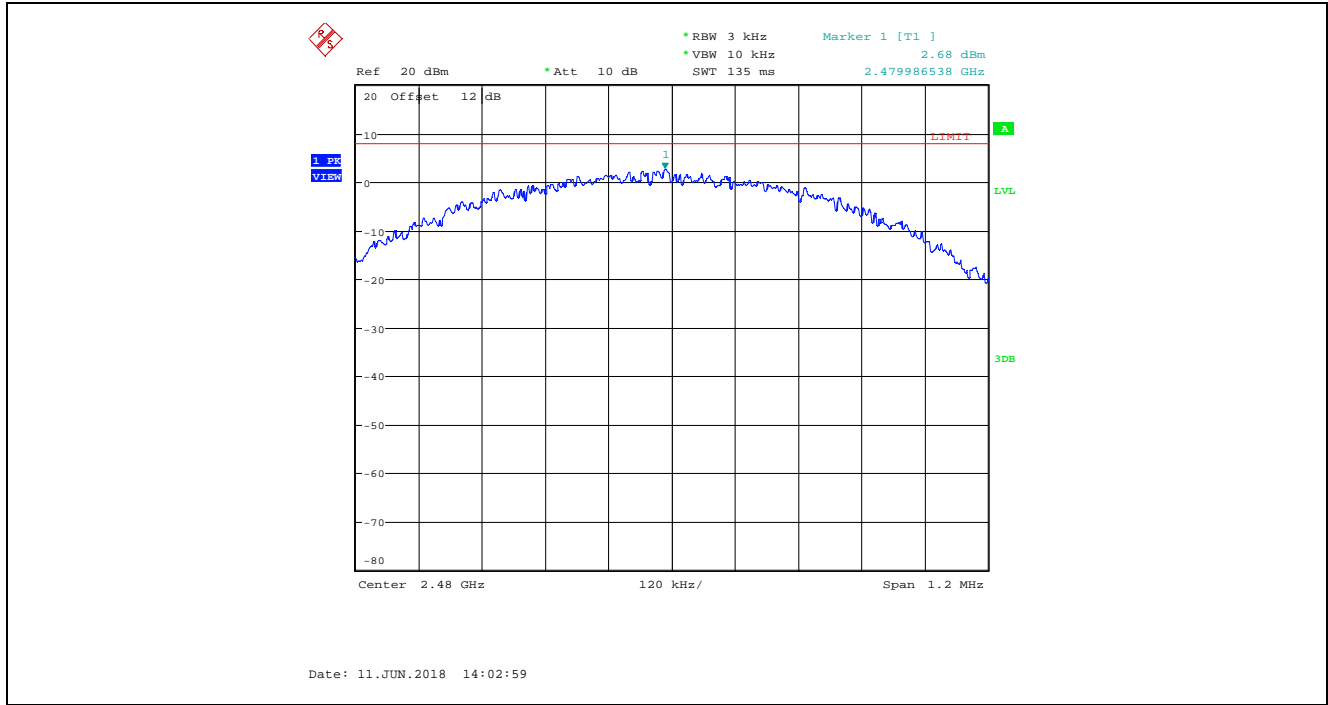

Plot 5.5.4.4. Power Spectral Density, GFSK Modulation, 2 Mbps, Power Setting 200, Channel 00, 2404 MHz

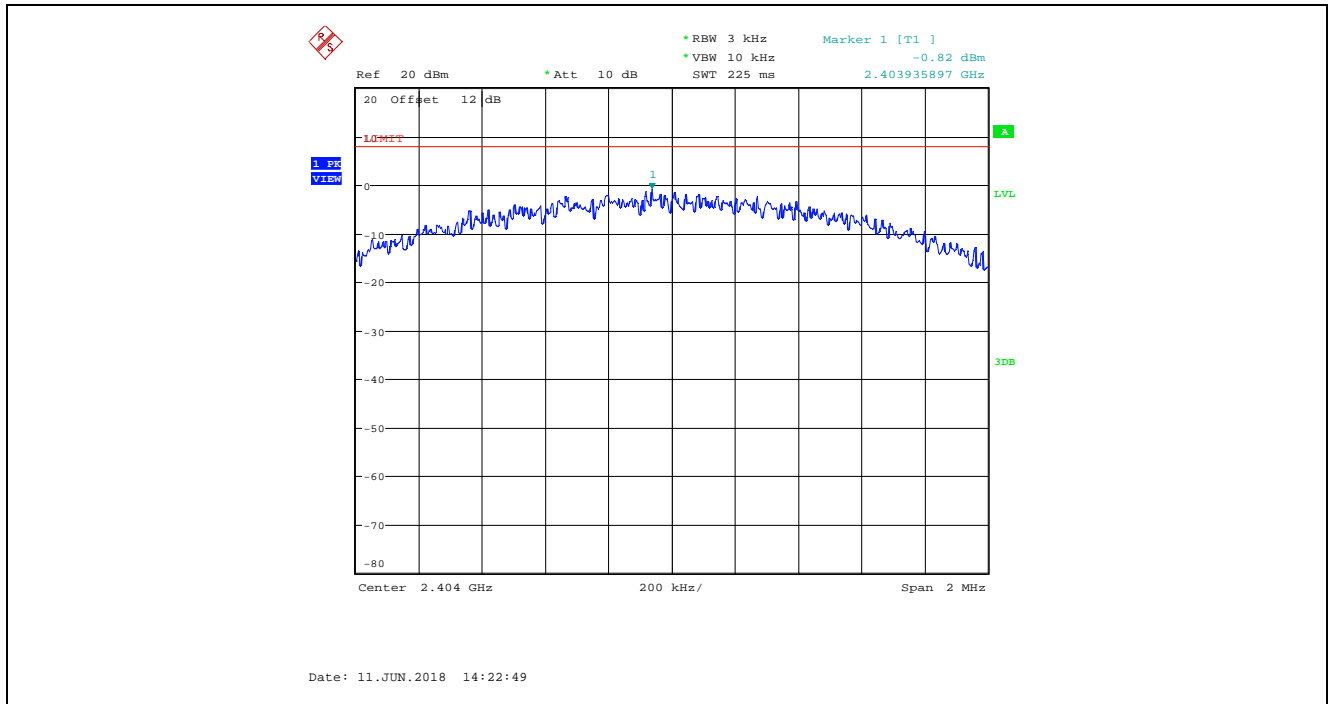



Plot 5.5.4.5. Power Spectral Density, GFSK Modulation, 2 Mbps, Power Setting 200, Channel 17, 2440 MHz

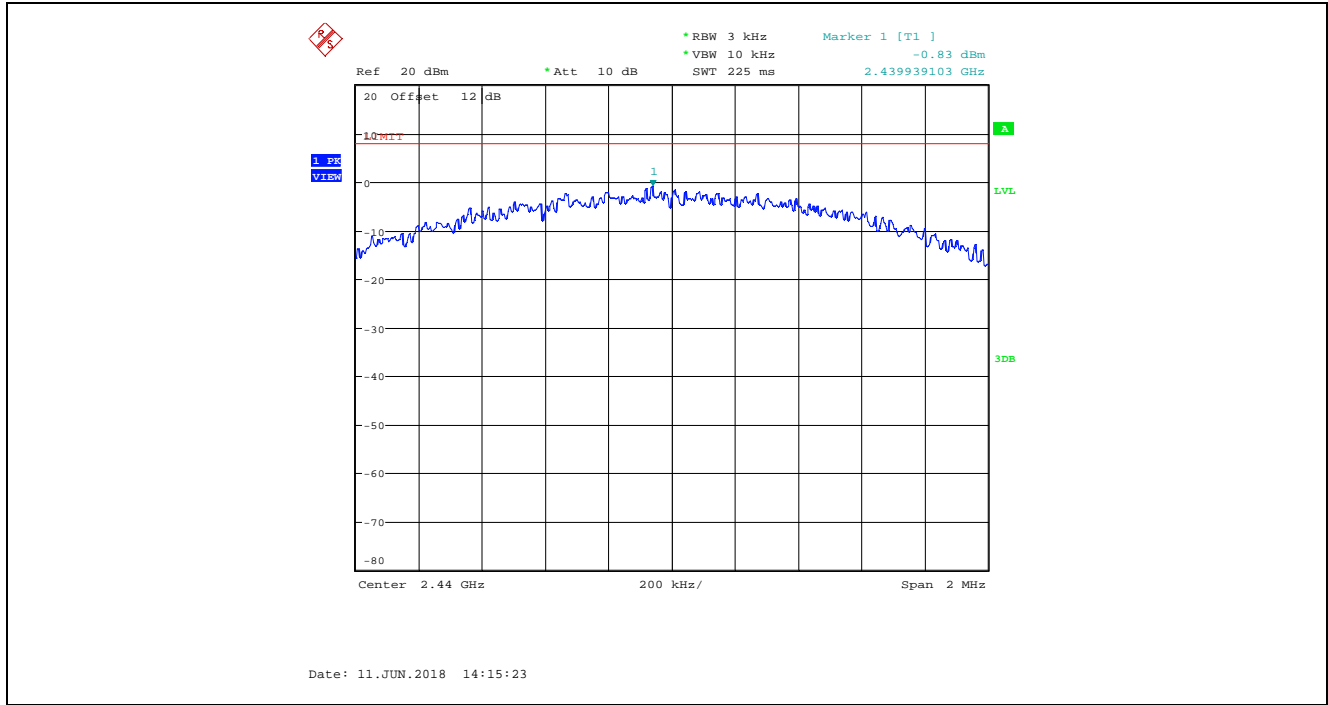

Plot 5.5.4.6. Power Spectral Density, GFSK Modulation, 2 Mbps, Power Setting 200, Channel 36, 2478 MHz

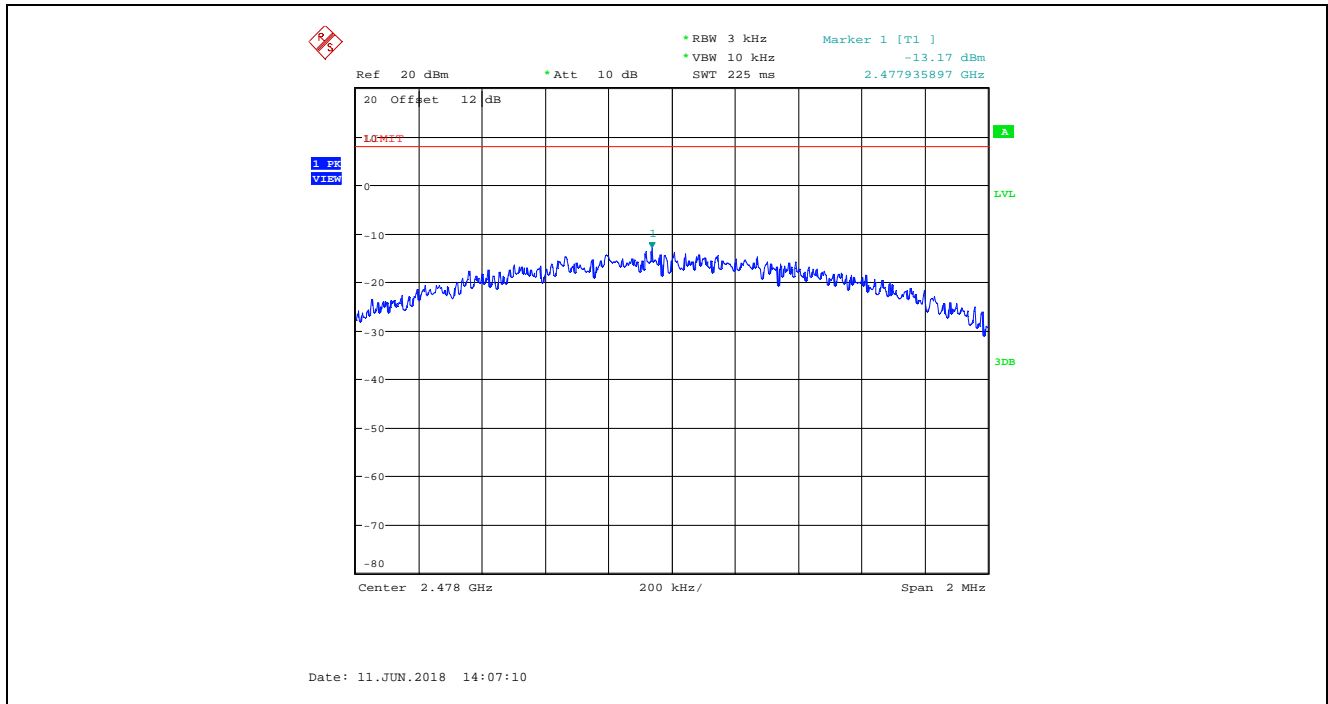

**5.6. RF EXPOSURE REQUIRMENTS [§§ 15.247(i), 1.1310 & 2.1091]**

**5.6.1. Limits**

§ 1.1310: The criteria listed in the following table shall be used to evaluate the environmental impact of human exposure to radio-frequency (RF) radiation as specified in 1.1307(b).

**Limits for Maximum Permissible Exposure (MPE)**

Frequency range (MHz)	Electric field strength (V/m)	Magnetic field strength (A/m)	Power density (mW/cm <sup>2</sup> )	Averaging time (minutes)
<b>(A) Limits for Occupational/Controlled Exposures</b>				
0.3-3.0	614	1.63	*(100)	6
3.0-30	1842/f	4.89/f	*(900/f <sup>2</sup> )	6
30-300	61.4	0.163	1.0	6
300-1500			f/300	6
1500-100,000			5	6
<b>(B) Limits for General Population/Uncontrolled Exposure</b>				
0.3-1.34	614	1.63	*(100)	30
1.34-30	824/f	2.19/f	*(180/f <sup>2</sup> )	30
30-300	27.5	0.073	0.2	30
300-1500			f/1500	30
1500-100,000			1.0	30

f = frequency in MHz

\* = Plane-wave equivalent power density

Note 1: Occupational/controlled limits apply in situations in which persons are exposed as a consequence of their employment provided those persons are fully aware of the potential for exposure and can exercise control over their exposure. Limits for occupational/controlled exposure also apply in situations when an individual is transient through a location where occupational/controlled limits apply provided he or she is made aware of the potential for exposure.

Note 2: General population/uncontrolled exposures apply in situations in which the general public may be exposed, or in which persons that are exposed as a consequence of their employment may not be fully aware of the potential for exposure or can not exercise control over their exposure.

### 5.6.2. Method of Measurements

#### Calculation Method of Power Density/RF Safety Distance:

$$S = \frac{PG}{4\pi \cdot r^2} = \frac{EIRP}{4\pi \cdot r^2}$$

Where,

P: power input to the antenna in mW

EIRP: Equivalent (effective) isotropic radiated power.

S: power density mW/cm<sup>2</sup>

G: numeric gain of antenna relative to isotropic radiator

r: distance to centre of radiation in cm

### 5.6.3. RF Evaluation

Frequency (MHz)	EIRP (dBm)	EIRP (mW)	Evaluation Distance, r (cm)	Power Density, S (mW/cm <sup>2</sup> )	MPE Limit (mW/cm <sup>2</sup> )	Margin (mW/cm <sup>2</sup> )
2402	24.32	270.396	20	0.054	1.0	-0.95

**EXHIBIT 6. TEST EQUIPMENT LIST**

Test Instruments	Manufacturer	Model No.	Serial No.	Frequency Range	Cal. Due Date
Spectrum Analyzer	Agilent	E7405A	US39440181	9 kHz–26.5 GHz	04 Feb 2019
Attenuator	Pasternack	PE7010-20	ATT13	DC–2 GHz	21 Mar 2019
LISN Used	EMCO	3825/2R	1165	10 kHz–30 MHz	03 Nov 2018
AC Adapter	Lenovo	02P1160	---	Output 20V	---
Spectrum Analyzer	Rohde & Schwarz	FSU26	200946	20Hz–26.5 GHz	21 Jul 2018
Attenuator	Hewlett Packard	8493C	0465	DC–18 GHz	See Note 1
DC Block	Hewlett Packard	11742A	12460	0.045 – 26.5 GHz	See Note 1
Laptop	Lenovo	R61e	---	---	---
RF Amplifier	Hewlett Packard	84498	3008A00769	1 – 26.5 GHz	04 Oct 2018
Attenuator	Pasternack	PE7024-10	4	DC–26.5 GHz	See Note 1
Horn Antenna	EMCO	3155	6570	1 – 18 GHz	13 Oct 2018
EMI Receiver	Rohde & Schwarz	ESU40	100037	20Hz–40 GHz	04 May 2019
RF Amplifier	Com-Power	PAM-0118A	551052	0.5 – 18 GHz	17 Jul 2018
Biconilog	EMCO	3142C	00026873	26-3000 MHz	27 Apr 2020
Horn Antenna	ETS-Lindgren	3160-09	001183858	18 – 26.5 GHz	11 Oct 2018
High Pass Filter	K & L	11SH10-4000/T12000	4	Cut off 2.4 GHz	See Note 1
Band Reject Filter	Micro-Tronics	BRM50701	105	Cut off 2.4-2.483 GHz	See Note 1
Note 1: Internal Verification/Calibration check					

**EXHIBIT 7. MEASUREMENT UNCERTAINTY**

The measurement uncertainties stated were calculated in accordance with the requirements of CISPR 16-4-2 @ IEC:2003 and JCGM 100:2008 (GUM 1995) – Guide to the Expression of Uncertainty in Measurement.

**7.1. LINE CONDUCTED EMISSION MEASUREMENT UNCERTAINTY**

	Line Conducted Emission Measurement Uncertainty (9 kHz – 30 MHz):	Measured	Limit
<b>u<sub>c</sub></b>	<b>Combined standard uncertainty:</b> $u_c(y) = \sqrt{\sum_{i=1}^m u_i^2(y)}$	<b>± 1.44</b>	<b>± 1.8</b>
<b>U</b>	<b>Expanded uncertainty U:</b> $U = 2u_c(y)$	<b>± 2.89</b>	<b>± 3.6</b>

**7.2. RADIATED EMISSION MEASUREMENT UNCERTAINTY**

	Radiated Emission Measurement Uncertainty @ 3m, Horizontal (30-1000 MHz):	Measured (dB)	Limit (dB)
<b>u<sub>c</sub></b>	<b>Combined standard uncertainty:</b> $u_c(y) = \sqrt{\sum_{i=1}^m u_i^2(y)}$	<b>± 2.39</b>	<b>± 2.6</b>
<b>U</b>	<b>Expanded uncertainty U:</b> $U = 2u_c(y)$	<b>± 4.79</b>	<b>± 5.2</b>

	Radiated Emission Measurement Uncertainty @ 3m, Vertical (30-1000 MHz):	Measured (dB)	Limit (dB)
<b>u<sub>c</sub></b>	<b>Combined standard uncertainty:</b> $u_c(y) = \sqrt{\sum_{i=1}^m u_i^2(y)}$	<b>± 2.39</b>	<b>± 2.6</b>
<b>U</b>	<b>Expanded uncertainty U:</b> $U = 2u_c(y)$	<b>± 4.78</b>	<b>± 5.2</b>

	Radiated Emission Measurement Uncertainty @ 3 m, Horizontal & Vertical (1 – 18 GHz):	Measured (dB)	Limit (dB)
<b>u<sub>c</sub></b>	<b>Combined standard uncertainty:</b> $u_c(y) = \sqrt{\sum_{i=1}^m u_i^2(y)}$	<b>± 1.87</b>	<b>Under consideration</b>
<b>U</b>	<b>Expanded uncertainty U:</b> $U = 2u_c(y)$	<b>± 3.75</b>	<b>Under consideration</b>