



OTA TEST REPORT

Applicant Espressif Systems
Product ESP ANT B
Model ESP ANT B
Report No. Y1806A0621-T1V3
Issue Date November 1, 2021

TA Technology (Shanghai) Co., Ltd. tested the above equipment in accordance with the requirements in **ANSI/IEEE Std 149-2008**. The test results show that the equipment tested is capable of demonstrating compliance with the requirements as documented in this report.

Handwritten signature of Peng Tao in black ink.

Prepared by: Peng Tao

Handwritten signature of Kai Xu in black ink.

Approved by: Kai Xu

TA Technology (Shanghai) Co., Ltd.

No.145, Jintang Rd, Tangzhen Industry Park, Pudong Shanghai, China

TEL: +86-021-50791141/2/3

FAX: +86-021-50791141/2/3-8000

TABLE OF CONTENTS

1.	General Information	3
1.1.	Notes of the Test Report	3
1.2.	Testing laboratory	3
1.3.	Laboratory Environment	3
2.	General Description of Equipment under Test	4
2.1.	Applicant Information	4
2.2.	Manufacturer Information	4
2.3.	Information of EUT	4
2.4.	Test Date	4
2.5.	Applied Standards	5
3.	Test Conditions	6
3.1.	Test Configuration	6
3.2.	Test Measurement	6
4.	Test Results	7
4.1.	Gain and Efficiency	7
4.2.	Voltage Standing Wave Ratio (VSWR)	8
4.3.	Antenna S11	9
5.	Test Equipment List	10
	APPENDIX A: 2-D Pattern Plots	11
	APPENDIX B: The EUT Appearance and Test Configuration	13
	B.1 EUT Appearance	13
	B.2 Test Configuration	14



1. General Information

1.1. Notes of the Test Report

This report shall not be reproduced in full or partial, without the written approval of TA technology (shanghai) co., Ltd. The results documented in this report apply only to the tested sample, under the conditions and modes of operation as described herein. Measurement Uncertainties were not taken into account and are published for informational purposes only. This report is written to support regulatory compliance of the applicable standards stated above. This report must not be used by the client to claim product certification, approval, or endorsement by any government agencies.

1.2. Testing laboratory

Company: TA Technology (Shanghai) Co., Ltd.
 Address: No.145, Jintang Rd, Tangzhen Industry Park, Pudong
 City: Shanghai
 Post code: 201201
 Country: P. R. China
 Contact: Xu Kai
 Telephone: +86-021-50791141/2/3
 Fax: +86-021-50791141/2/3-8000
 Website: <http://www.ta-shanghai.com>
 E-mail: xukai@ta-shanghai.com

1.3. Laboratory Environment

Temperature	Min. =19°C, Max. = 25°C	
Relative humidity	Min. =40%, Max. =72%	
Shield effect	0.7-6GHz	> 100dB
Ground resistance	<0.5Ω	

2. General Description of Equipment under Test

2.1. Applicant Information

Company: Espressif Systems
Address: #101, Block 2, 690 Bibo Road, Zhang Jiang High-Tech Park, Shanghai, China

2.2. Manufacturer Information

Company: Espressif Systems
Address: #101, Block 2, 690 Bibo Road, Zhang Jiang High-Tech Park, Shanghai, China

2.3. Information of EUT

General information

EUT Description	
Product Name:	ESP ANT B
Model	ESP ANT B
HW Version:	/
SW Version:	/
Antenna Type:	Fixed Antenna
Antenna Manufacturer:	Espressif Systems
Test Frequency:	2400MHz ~ 2500MHz

Test lab. of the antenna gain and radiation pattern measurement: TA Technology (Shanghai) Co., Ltd.

This revised report (Report No.: Y1806A0621-T1V3) supersedes and replaces the previously issued report (Report No.: Y1806A0621-T1V2 & Y1806A0621-T1V1 & Y1806A0621-T1). Please discard or destroy the previously issued report and dispose of it accordingly.

2.4. Test Date

The test is performed from June 25, 2018 to August 3, 2018.



2.5. Applied Standards

According to the specifications of the manufacturer, it must comply with the requirements of the following standards:

Test Method: **ANSI/IEEE Std 149-2008**



3. Test Conditions

3.1. Test Configuration

Great-Circle-Cut method is used to measure the antenna 3D GAIN of EUT in OTA qualified anechoic chamber. Equipment Under Test (EUT) geometry centre vertical projection at the centre of platform, the distance from EUT to measurement antenna is 5m.

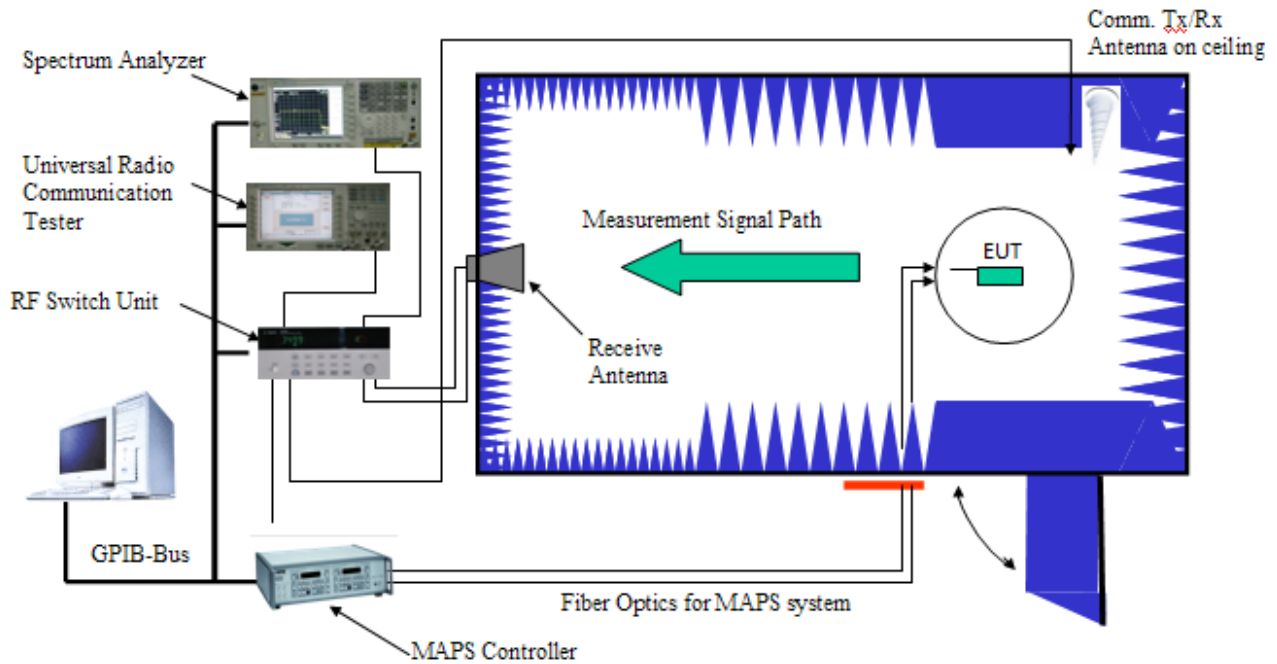

3.2. Test Measurement

Spherical coordinate system

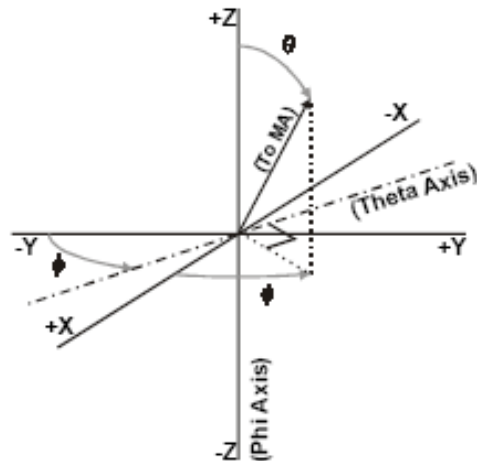

Figure 1 Test coordinate system

Note: Theta is from 0~180 degree. Phi is from 0~360. Rotate the EUT and record the Data, the step of rotation is 30 degree.



4. Test Results

4.1. Gain and Efficiency

Model	Test Item	Test State	Frequency (MHz)	Efficiency (%)	Gain (dBi)	Note
ESP-ANT B	Gain	Free Space	2412	73.79	2.39	Vertical 30°
			2417	77.04	2.97	
			2422	79.83	2.80	
			2427	81.19	2.89	
			2432	80.54	3.04	
			2437	76.86	2.86	
			2442	76.17	2.99	
			2447	73.99	2.96	
			2452	72.00	2.80	
			2457	70.71	2.72	
			2462	71.31	2.94	
			2467	71.32	3.12	
			2472	72.03	3.28	
			2477	72.71	3.24	
			2482	75.42	3.42	

Note: comment variation is +/- 0.02dBi



4.2. Voltage Standing Wave Ratio (VSWR)

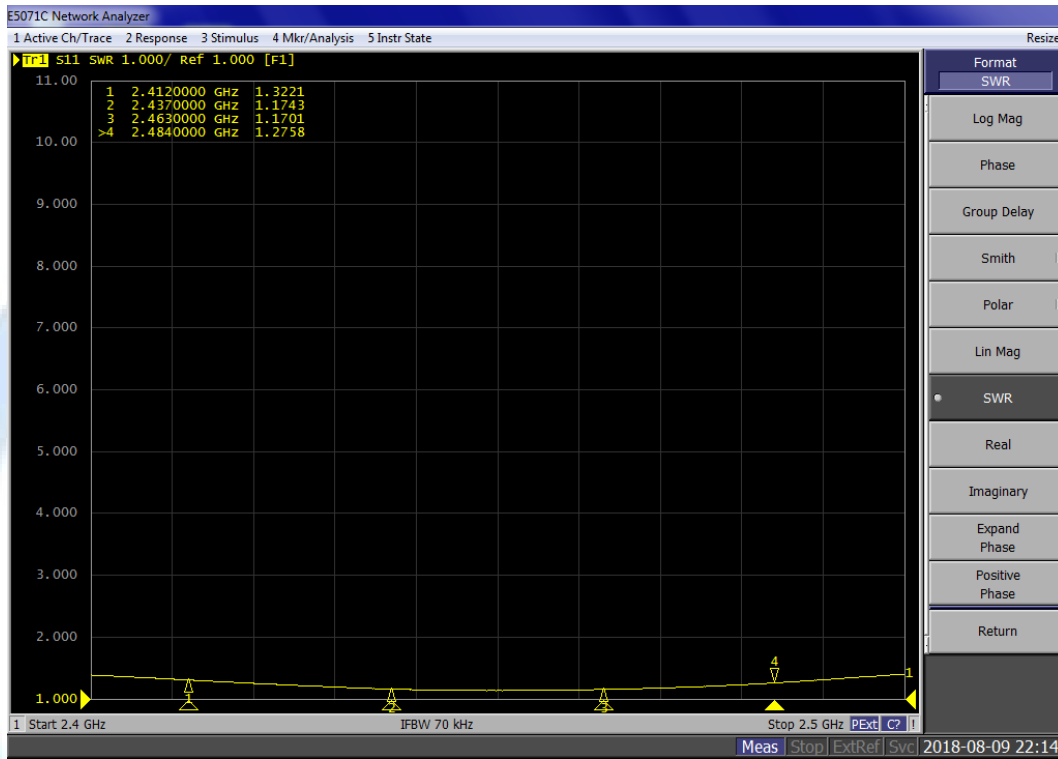

Frequency (MHz)	2412	2437	2463	2484
VSWR	1.32	1.17	1.17	1.28



4.3. Antenna S11

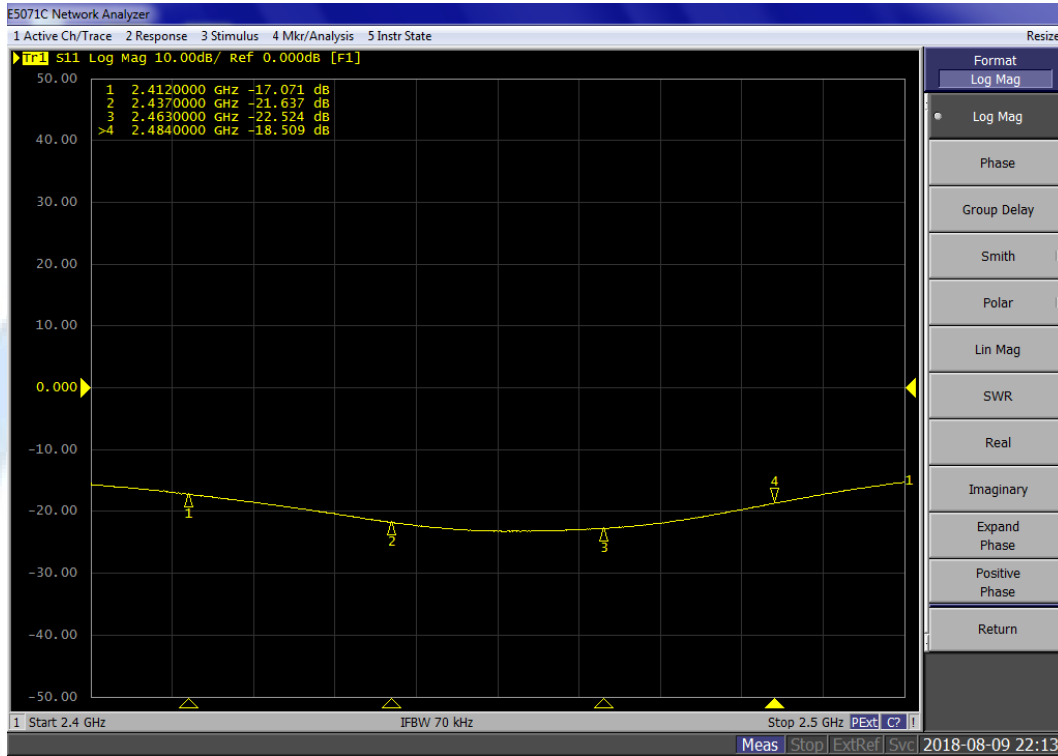

Frequency (MHz)	2412	2437	2463	2484
S11(dB)	-17.07	-21.64	-22.52	-18.51

5. Test Equipment List

Type of Equipment	Manufacture	Model Number	SN	Calibration Date	Expiration Time
Network Analyzer	Key sight	E5071B	MY42404014	2018-05-20	2019-05-19
Switch Control System	ETS	7006/7001	00059957/MY4 2001152	2018-05-20	2019-05-19
Dual polarized horn antenna	ETS	3164-04	00062743	2018-05-20	2019-05-19
Anechoic Chamber	ETS	AMS-8500	CT-001157- 1219	/	/
Software	ETS-lindgren	EMQ-100 Pattern Measureme nt software	1.09	/	/



APPENDIX A: 2-D Pattern Plots

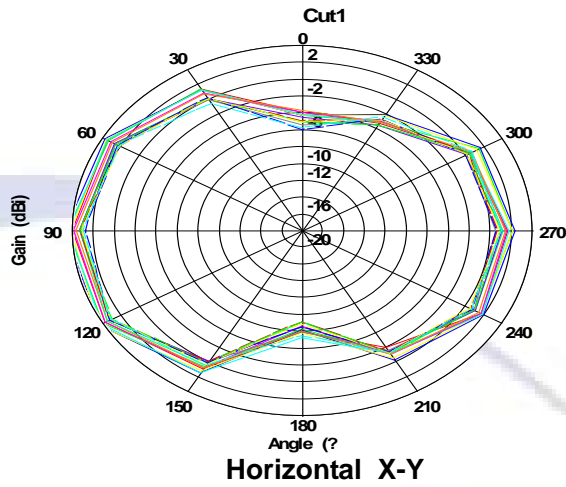

2412 MHz
2417 MHz
2422 MHz
2427 MHz
2432 MHz
2437 MHz
2442 MHz
2447 MHz
2452 MHz
2457 MHz
2462 MHz
2467 MHz
2472 MHz
2477 MHz
2482 MHz

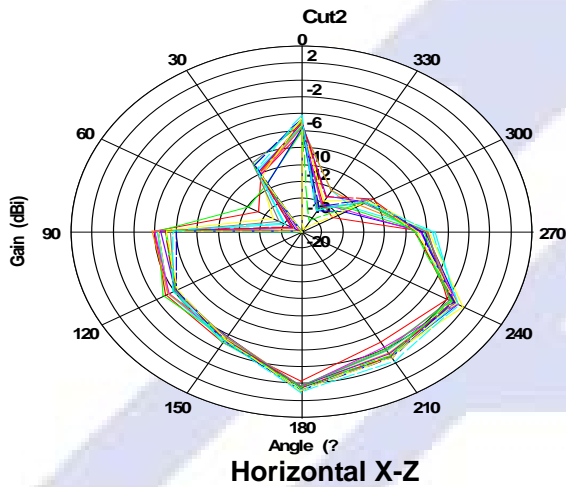

2412 MHz
2417 MHz
2422 MHz
2427 MHz
2432 MHz
2437 MHz
2442 MHz
2447 MHz
2452 MHz
2457 MHz
2462 MHz
2467 MHz
2472 MHz
2477 MHz
2482 MHz

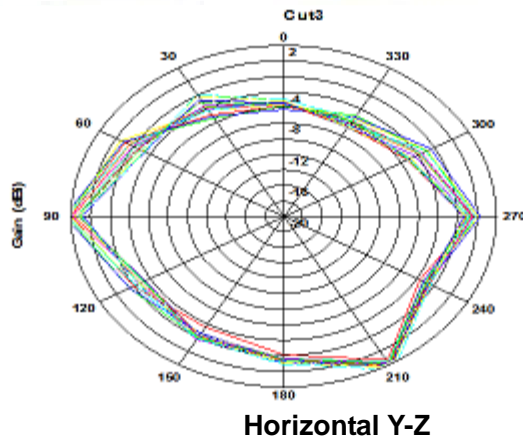

2412 MHz
2417 MHz
2422 MHz
2427 MHz
2432 MHz
2437 MHz
2442 MHz
2447 MHz
2452 MHz
2457 MHz
2462 MHz
2467 MHz
2472 MHz
2477 MHz
2482 MHz

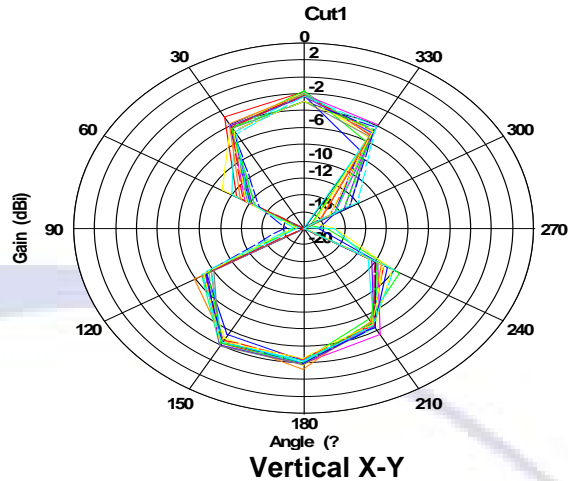

2412 MHz
2417 MHz
2422 MHz
2427 MHz
2432 MHz
2437 MHz
2442 MHz
2447 MHz
2452 MHz
2457 MHz
2462 MHz
2467 MHz
2472 MHz
2477 MHz
2482 MHz

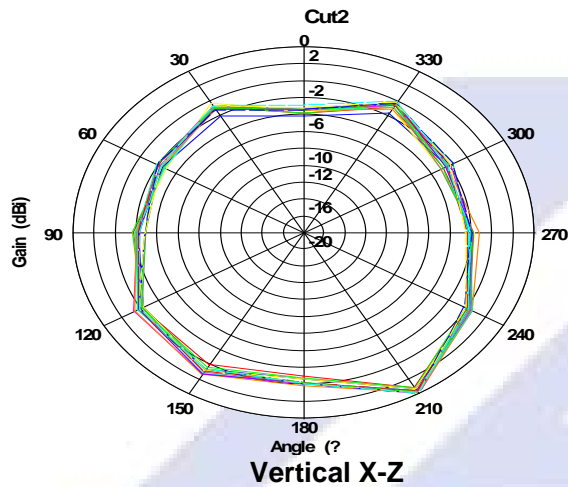

2412 MHz
2417 MHz
2422 MHz
2427 MHz
2432 MHz
2437 MHz
2442 MHz
2447 MHz
2452 MHz
2457 MHz
2462 MHz
2467 MHz
2472 MHz
2477 MHz
2482 MHz

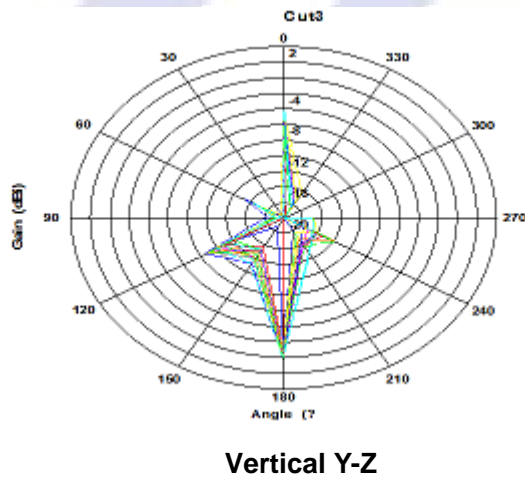

2412 MHz
2417 MHz
2422 MHz
2427 MHz
2432 MHz
2437 MHz
2442 MHz
2447 MHz
2452 MHz
2457 MHz
2462 MHz
2467 MHz
2472 MHz
2477 MHz
2482 MHz

APPENDIX B: The EUT Appearance and Test Configuration

B.1 EUT Appearance

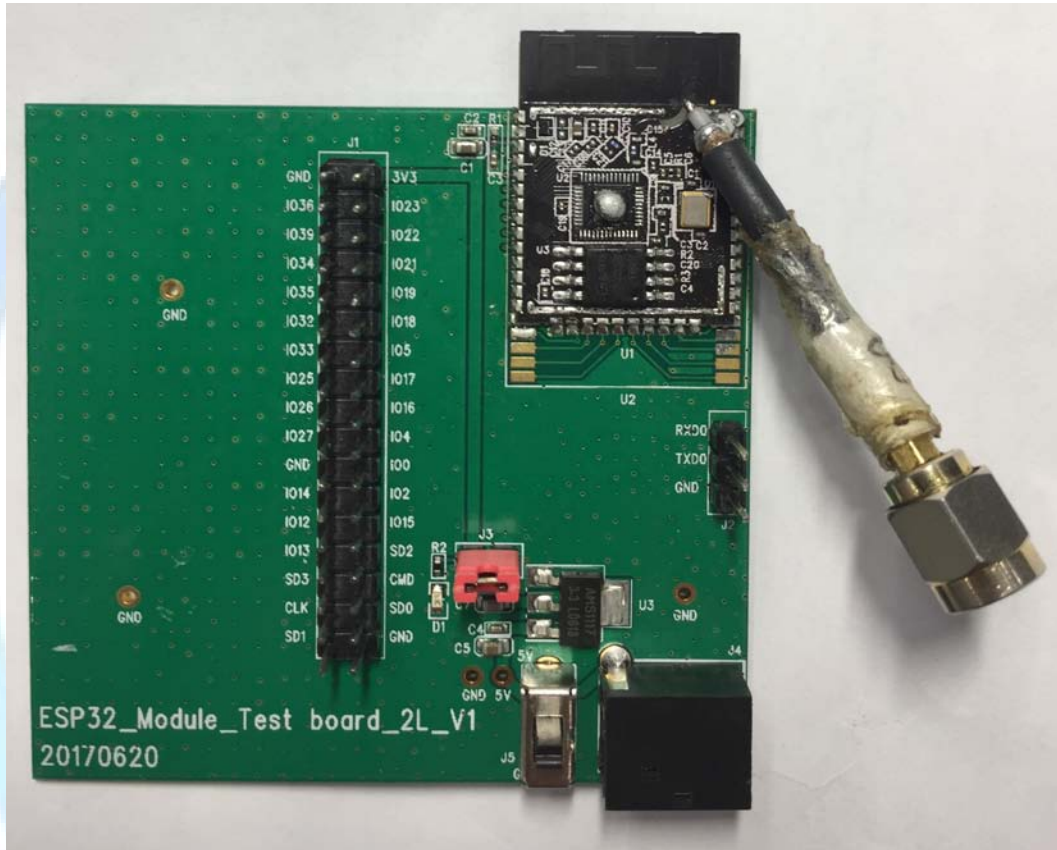

Picture 1 Constituents of EUT

B.2 Test Configuration

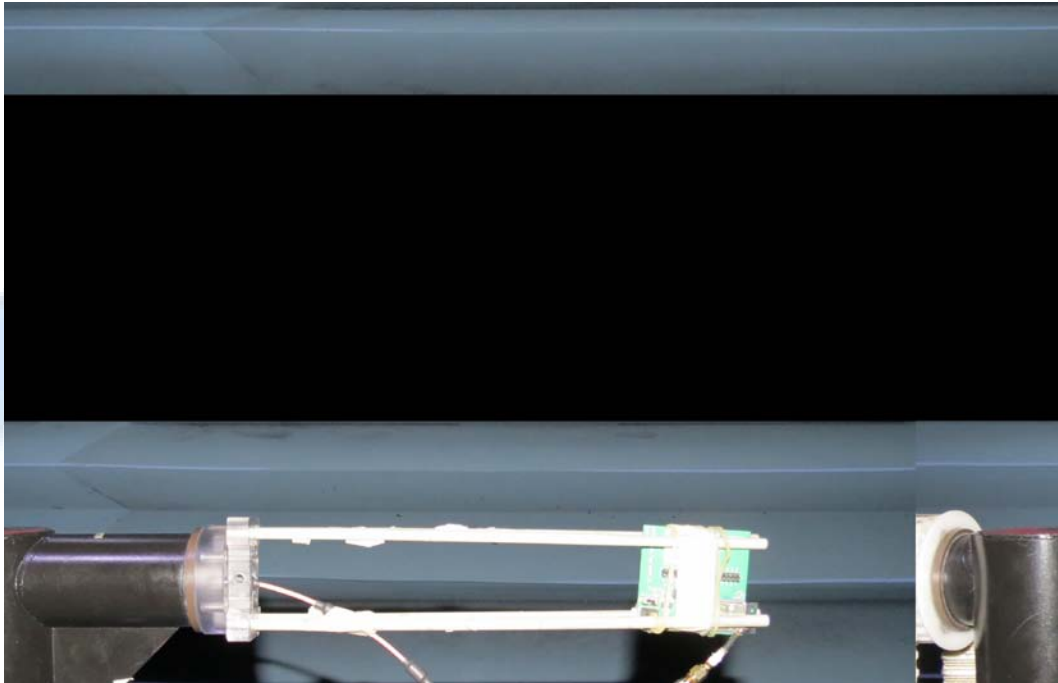

ESP-ANT B

Picture 2 Test Setup

*******END*******