

S

T

S

L

A

B



RADIO TEST REPORT

Report No: STS1612227F01

Issued for

Hangzhou Wistar Mechanical & Electric Technology Co., Ltd.

NO.290 Renliang Road, Renhe, Yuhang District, Hangzhou
China

Product Name:	Emitter
Brand Name:	WISTAR
Model Name:	WSRE201
Series Model:	WSRE204
FCC ID:	XFCWISTAR-RE201
Test Standard:	FCC Part 15.231

Any reproduction of this document must be done in full. No single part of this document may be reproduced without permission from STS, All Test Data Presented in this report is only applicable to presented Test sample.





TEST REPORT CERTIFICATION

Applicant's name: Hangzhou Wistar Mechanical & Electric Technology Co., Ltd.
Address: NO.290 Renliang Road, Renhe, Yuhang District, Hangzhou China

Manufacture's Name.....: Hangzhou Wistar Mechanical & Electric Technology Co., Ltd.
Address: NO.290 Renliang Road, Renhe, Yuhang District, Hangzhou China

Product description

Product name: Emitter

Brand name: WISTAR

Model and/or type reference.....: WSRE201,WSRE204

Standards: FCC Part 15.231

Test procedure.....: ANSI C63.10-2013

This device described above has been tested by STS, and the test results show that the equipment under test (EUT) is in compliance with the FCC requirements. And it is applicable only to the tested sample identified in the report.

This report shall not be reproduced except in full, without the written approval of STS, this document may be altered or revised by STS, personal only, and shall be noted in the revision of the document.

Date of Test.....

Date of performance of tests 25 Dec. 2016 ~03 Jan. 2017

Date of Issue..... 04 Jan. 2017

Test Result..... Pass

Testing Engineer :

Sean She

(Sean she)

Technical Manager :

Tony Liu

(Tony liu)

Authorized Signatory :

Bovey Yang

(Bovey Yang)



**TABLE OF CONTENTS**

1. SUMMARY OF TEST RESULTS	6
1.1 TEST FACTORY	6
1.2 MEASUREMENT UNCERTAINTY	6
2. GENERAL INFORMATION	7
2.1 GENERAL DESCRIPTION OF EUT	7
2.2 DESCRIPTION OF TEST MODES	8
2.3 BLOCK DIGRAM SHOWING THE CONFIGURATION OF SYSTEM TESTED	8
2.4 DESCRIPTION OF SUPPORT UNITS	9
2.5 EQUIPMENTS LIST FOR ALL TEST ITEMS	10
3. EMC EMISSION TEST	11
3.1 CONDUCTED EMISSION MEASUREMENT	11
3.2 TEST PROCEDURE	12
3.3 TEST SETUP	12
3.4 EUT OPERATING CONDITIONS	12
3.5 TEST RESULTS	13
4. RADIATED EMISSION MEASUREMENT	14
4.1 RADIATED EMISSION LIMITS	14
4.2 TEST PROCEDURE	15
4.3 DEVIATION FROM TEST STANDARD	15
5. BANDWIDTH TEST	22
5.1 APPLIED PROCEDURES / LIMIT	22
5.2 TEST REQUIREMENTS	22
5.3 TEST PROCEDURE	22
5.4 TEST SETUP	22
5.5 EUT OPERATION CONDITIONS	22
5.6 TEST RESULTS	23
6. DUTY CYCLE	24
6.1 TEST PROCEDURE	24
6.2 TEST SETUP	24
6.3 EUT OPERATION CONDITIONS	24
6.4 TEST RESULTS	25
7. AUTOMATICALLY DEACTIVATE	27
7.1 STANDARD REQUIREMENT	27
7.2 TEST PROCEDURE	27



8. ANTENNA REQUIREMENT	29
8.1 STANDARD REQUIREMENT	29
8.2 EUT ANTENNA	29
APPENDIX 1- PHOTOS OF TEST SETUP	30





Revision History

Rev.	Issue Date	Report NO.	Effect Page	Contents
00	04 Jan. 2017	STS1612227F01	ALL	Initial Issue





1. SUMMARY OF TEST RESULTS

Test procedures according to the technical standards:

FCC Part 15.231, Subpart C			
Standard Section	Test Item	Judgment	Remark
15.207	Conducted Emission	N/A	--
15.205(a)/15.209/ 15.231.(b)	Radiated Spurious Emission	PASS	--
15.231(a)(1)/ 15.231(b)	Transmission requirement	PASS	--
15.231(C)	20 dB Bandwidth	PASS	--
15.203	Antenna Requirement	PASS	--

NOTE: (1)"N/A" denotes test is not applicable in this Test Report

(2) All tests are according to ANSI C63.10-2013

1.1 TEST FACTORY

Shenzhen STS Test Services Co., Ltd.
1/F., Building B, Zhuoke Science Park, No.190, Chongqing Road,
Fuyong Street, Bao'an District, Shenzhen, Guangdong, China
FCC Registration No.: 842334; IC Registration No.: 12108A-1

1.2 MEASUREMENT UNCERTAINTY

The reported uncertainty of measurement $y \pm U$, where expanded uncertainty U is based on a standard uncertainty multiplied by a coverage factor of $k=2$, providing a level of confidence of approximately **95** %.

No.	Item	Uncertainty
1	Conducted Emission (9KHz-150KHz)	± 2.88 dB
2	Conducted Emission (150KHz-30MHz)	± 2.67 dB
3	RF power,conducted	± 0.70 dB
4	Spurious emissions,conducted	± 1.19 dB
5	All emissions,radiated(<1G) 30MHz-200MHz	± 2.83 dB
6	All emissions,radiated(<1G) 200MHz-1000MHz	± 2.94 dB
8	All emissions,radiated(>1G)	± 3.03 dB
9	Temperature	$\pm 0.5^{\circ}$ C
10	Humidity	$\pm 2\%$



2. GENERAL INFORMATION

2.1 GENERAL DESCRIPTION OF EUT

Equipment	Emitter
Trade Name	WISTAR
Model Name	WSRE201
Series Model	WSRE204
Model Difference	Only different in model name
Frequency band	433.92MHz
Modulation Type	ASK
Antenna Type	PCB Antenna
Antenna Gain	2dBi
Battery	Rated Voltage: 3V Capacity: 210mAh
Hardware version number	V1.0
Software version number	V1.0
Connecting I/O Port(s)	Please refer to the User's Manual

Note:

1. For a more detailed features description, please refer to the manufacturer's specifications or the User's Manual.

2. Table for filed Antenna

Ant.	Brand	Model Name	Antenna Type	Connector	Gain (dBi)	NOTE
1	WISTAR	WSRE201	PCB	N/A	2	Antenna

The EUT antenna is PCB Antenna. No antenna other than that furnished by the responsible party shall be used with the device.



2.2 DESCRIPTION OF TEST MODES

To investigate the maximum EMI emission characteristics generates from EUT, the test system was pre-scanning tested base on the consideration of following EUT operation mode or test configuration mode which possible have effect on EMI emission level. Each of these EUT operation mode(s) or test configuration mode(s) mentioned above was evaluated respectively.

Pretest Mode	Description
Mode 1	TX Mode

	For Radiated Emission
Final Test Mode	Description
Mode 1	TX Mode

2.3 BLOCK DIGRAM SHOWING THE CONFIGURATION OF SYSTEM TESTED

During test, Keep EUT is in continuous transmission mode, New battery is used during all test.

E-1
EUT



2.4 DESCRIPTION OF SUPPORT UNITS

The EUT has been tested as an independent unit together with other necessary accessories or support units. The following support units or accessories were used to form a representative test configuration during the tests.

Item	Equipment	Mfr/Brand	Model/Type No.	Serial No.	Note
E-1	Emitter	WISTAR	WSRE201	N/A	EUT

Item	Shielded Type	Ferrite Core	Length	Note
N/A	N/A	N/A	N/A	N/A

Note:

- (1)The support equipment was authorized by Declaration of Confirmation.
- (2)For detachable type I/O cable should be specified the length in cm in 『Length』 column.



2.5 EQUIPMENTS LIST FOR ALL TEST ITEMS

Kind of Equipment	Manufacturer	Type No.	Serial No.	Last calibration	Calibrated until
Spectrum Analyzer	Agilent	E4407B	MY50140340	2016.10.23	2017.10.22
Test Receiver	R&S	ESCI	101427	2016.10.23	2017.10.22
Bilog Antenna	TESEQ	CBL6111D	34678	2014.11.24	2017.11.23
Horn Antenna	Schwarzbeck	BBHA 9120D(1201) 1G-18G	9120D-1343	2015.03.05	2018.03.04
50Ω Coaxial Switch	Anritsu	MP59B	6200264416	2016.06.06	2017.06.05
PreAmplifier	Agilent	8449B	60538	2016.10.23	2017.10.22
Loop Antenna	EMCO	6502	9003-2485	2016.03.06	2019.03.05
Spectrum Analyzer	Agilent	E4407B	MY50140340	2016.10.23	2017.10.22
Low frequency cable (9KHz-1GHz)	SCHWARZBECK	R01	N/A	2016.10.23	2017.10.22
High frequency cable (1GHz-5GHz)	SCHWARZBECK	R02	N/A	2016.10.23	2017.10.22
Temporary Antenna Connector	N/A	P9MSP9MS	N/A	2016.10.23	2017.10.22
RF Cable	Murrata	MXHS83QE300 0	2085751	2016.10.23	2017.10.22
EMI Test Receiver	R&S	ESPI	102086	2016.10.23	2017.10.22
LISN	R&S	ENV216	101242	2016.10.23	2017.10.22
LISN	EMCO	3810/2NM	000-23625	2016.10.23	2017.10.22
Conduction Cable (150KHz-30MHz)	EM	C01	N/A	2016.10.23	2017.10.22

Note: The temporary antenna connector is soldered on the PCB board in order to perform conducted tests and this temporary antenna connector is listed in the equipment list.



3. EMC EMISSION TEST

3.1 CONDUCTED EMISSION MEASUREMENT

3.1.1 POWER LINE CONDUCTED EMISSION LIMITS

operating frequency band. In case the emission fall within the restricted band specified on Part 15. 207(a) limit in the table below has to be followed.

FREQUENCY (MHz)	Class B (dBuV)		Standard
	Quasi-peak	Average	
0.15 -0.5	66 - 56 *	56 - 46 *	CISPR
0.50 -5.0	56.00	46.00	CISPR
5.0 -30.0	60.00	50.00	CISPR

0.15 -0.5	66 - 56 *	56 - 46 *	FCC
0.50 -5.0	56.00	46.00	FCC
5.0 -30.0	60.00	50.00	FCC

Note:

- (1) The tighter limit applies at the band edges.
- (2) The limit of " * " marked band means the limitation decreases linearly with the logarithm of the frequency in the range.

The following table is the setting of the receiver

Receiver Parameters	Setting
Attenuation	10 dB
Start Frequency	0.15 MHz
Stop Frequency	30 MHz
IF Bandwidth	9 kHz

3.2 TEST PROCEDURE

- a. The EUT was placed 0.8 meters from the horizontal ground plane with EUT being connected to the power mains through a line impedance stabilization network (LISN). All other support equipments powered from additional LISN(s). The LISN provide 50 Ohm/ 50uH of coupling impedance for the measuring instrument.
- b. Interconnecting cables that hang closer than 40 cm to the ground plane shall be folded back and forth in the center forming a bundle 30 to 40 cm long.
- c. I/O cables that are not connected to a peripheral shall be bundled in the center. The end of the cable may be terminated, if required, using the correct terminating impedance. The overall length shall not exceed 1 m.
- d. LISN at least 80 cm from nearest part of EUT chassis.
- e. For the actual test configuration, please refer to the related Item –EUT Test Photos.

3.3 TEST SETUP

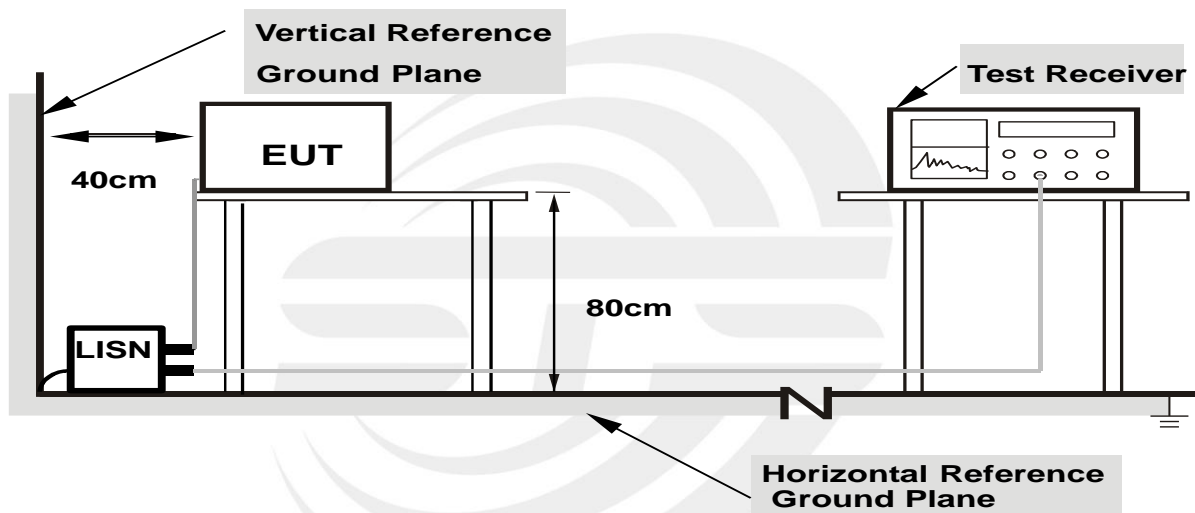

- Note: 1. Support units were connected to second LISN.**
2. Both of LISNs (AMN) are 80 cm from EUT and at least 80 from other units and other metal planes

3.4 EUT OPERATING CONDITIONS

The EUT was configured for testing in a typical fashion (as a customer would normally use it). The EUT has been programmed to continuously transmit during test. This operating condition was tested and used to collect the included data.



3.5 TEST RESULTS

Temperature:	26 °C	Relative Humidity:	54%
Pressure:	1010hPa	Phase :	L/N
Test Mode:	N/A		

Note: This device is a battery power supply equipment, AC conducted emission is not applicable.





4. RADIATED EMISSION MEASUREMENT

4.1 RADIATED EMISSION LIMITS

In case the emission fall within the restricted band specified on Part 15.205(a), then the Part 15.209(a) and Part 15.231(b) limit in the table below has to be followed.

LIMITS OF RADIATED EMISSION MEASUREMENT (0.009MHz - 1000MHz)

Frequencies (MHz)	Field Strength (microvolts/meter)	Measurement Distance (meters)
0.009~0.490	2400/F(KHz)	300
0.490~1.705	24000/F(KHz)	30
1.705~30.0	30	30
30~40.66	100	3
40.70~70	100	3

Fundamental Frequency (MHz)	Field Strength of fundamental (microvolts/meter)	Field Strength of Unwanted Emissions (microvolts/meter)
40.66~40.70	2,250	225
70~130	1,250	125
130~174	1,250 to 3,750**	125 to 375**
174~260	3750	375
260~470	3,750 to 12,500**	375 to 1,250**
Above 470	12,500	1,250

LIMITS OF RADIATED EMISSION MEASUREMENT (Above 1000MHz)

FREQUENCY (MHz)	Class B (dBuV/m) (at 3M)	
	PEAK	AVERAGE
Above 1000	74	54

NOTE:

- (1) The limit for radiated test was performed according to FCC PART 15C.
- (2) Emission level (dBuV/m) = 20log Emission level (uV/m).



Spectrum Parameter	Setting
Detector	Peak
Attenuation	Auto
Start Frequency	1000 MHz
Stop Frequency	10th carrier harmonic
RB / VB (emission in restricted band)	1 MHz / 3 MHz

Receiver Parameter	Setting
Attenuation	Auto
Start ~ Stop Frequency	9kHz~90kHz / RB 200Hz for PK & AV
Start ~ Stop Frequency	90kHz~110kHz / RB 200Hz for QP
Start ~ Stop Frequency	110kHz~490kHz / RB 200Hz for PK & AV
Start ~ Stop Frequency	490kHz~30MHz / RB 9kHz for QP
Start ~ Stop Frequency	30MHz~1000MHz / RB 120kHz for QP

4.2 TEST PROCEDURE

- a. The test is performed in a 3m Semi-Anechoic Chamber; the antenna factor, cable loss and so on of the site (factors) is calculated to correct the reading. The EUT is placed on a 0.8m high insulating Turn Table, and keeps 3m away from the Test Antenna, which is mounted on a variable-height antenna master tower. During test, The table was rotated 360 degrees to determine the position of the highest radiation.
- b. In the frequency range of 9KHz to 30MHz, magnetic field is measured with Loop Test Antenna. The Test Antenna is positioned with its plane vertical at 1m distance from the EUT. The center of the Loop Test Antenna is 1m above the ground. During the measurement the Loop Test Antenna rotates about its vertical axis for maximum response at each azimuth about the EUT.
- c. In the frequency range 30MHz-1GHz, Bi-Log Test Antenna used. Test Antenna is 3m away from the EUT. Test Antenna height is varied from 1m to 4m above the ground to determine the maximum value of the field strength. The emission levels at both horizontal and vertical polarizations should be tested.
- d. In the frequency above 1GHz, Place the measurement antenna 3m away from the EUT for each area of the EUT determined to be a source of emissions at the specified measurement distance, while keeping the measurement antenna aimed at the source of emissions at each frequency of significant emissions, with polarization oriented for maximum response. The measurement antenna elevation for maximum emissions shall be restricted to a range of heights of from 1 m to 4 m above the ground or reference ground plane.
- f. The initial step in collecting conducted emission data is a spectrum analyzer peak detector mode pre-scanning the measurement frequency range. Significant peaks are then marked and then Quasi Peak detector mode re-measured.
- g. If the Peak Mode measured value compliance with and lower than Quasi Peak Mode Limit, the EUT shall be deemed to meet QP Limits and then no additional QP Mode measurement performed.
- h. For the actual test configuration, please refer to the related Item –EUT Test Photos. Both horizontal and vertical antenna polarities and performed pretest to three orthogonal axis were tested. The worst case emissions were reported

4.3 DEVIATION FROM TEST STANDARD

No deviation

4.4 TEST SETUP

(A) Radiated Emission Test-Up Frequency Below 30MHz

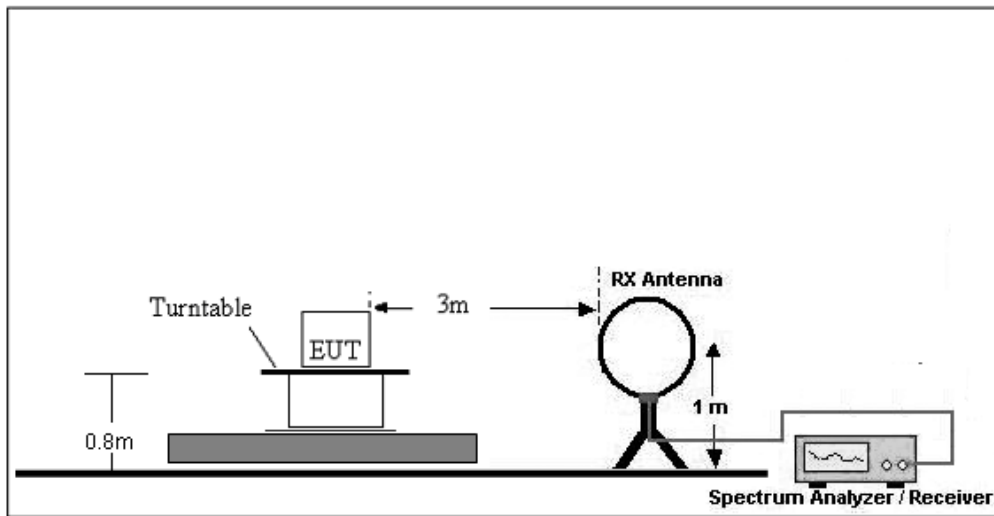

(B) Radiated Emission Test-Up Frequency 30MHz~1GHz

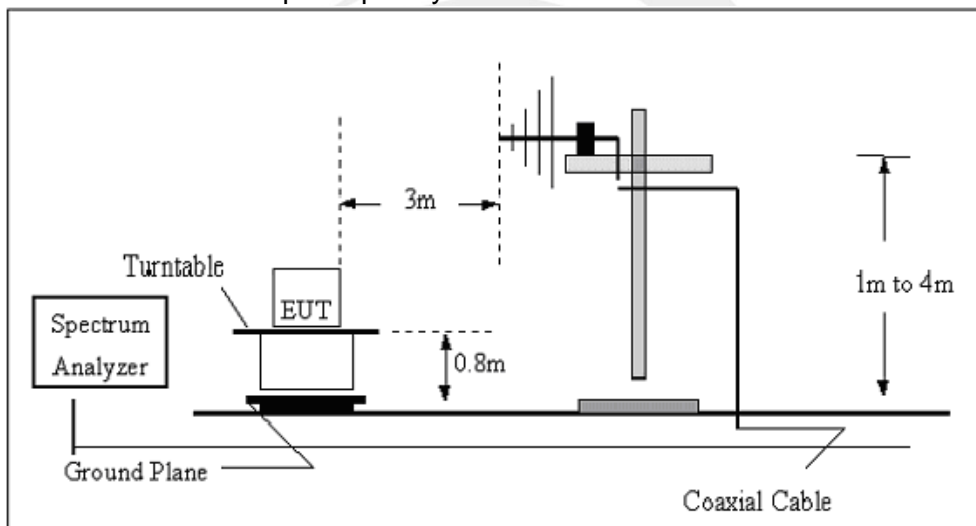

(C) Radiated Emission Test-Up Frequency Above 1GHz

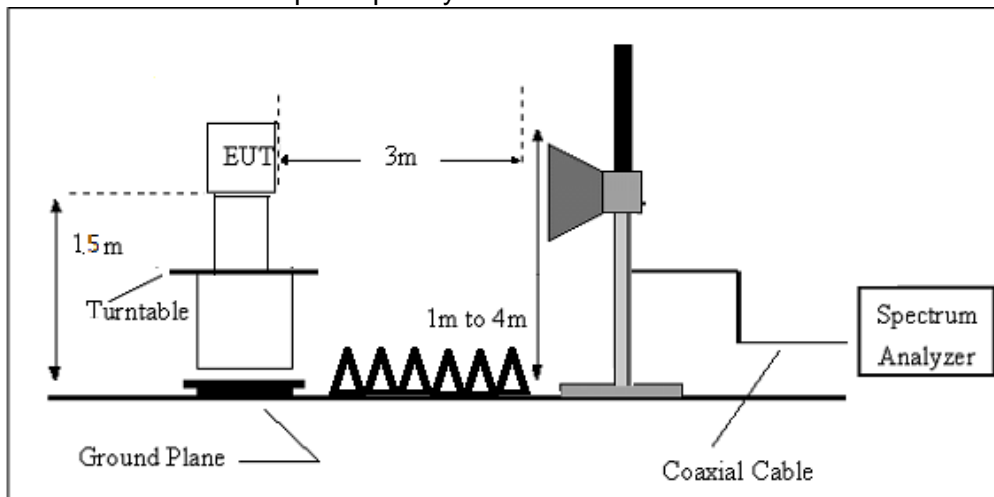

4.5 EUT OPERATING CONDITIONS

The EUT tested system was configured as the statements of 2.4 Unless otherwise a special operating condition is specified in the follows during the testing.

4.6 TEST RESULTS

INTRODUCTION TO PDCF

reference: (§15.35 Measurement detector functions and bandwidths.)

- a. Part 15 of the FCC Rules provides for the operation of low power communication devices without an individual license (e.g., intrusion detectors, pulsed water tank level gauges, etc.), subject to certain requirements. Some of these devices use extremely narrow pulses to generate wideband emissions, which are measured to determine compliance with the rules. These measurements are typically performed with a receiver or spectrum analyzer. Depending on a number of factors (e.g., resolution bandwidth, pulsewidth, etc.), the spectrum analyzer may not always display the true peak value of the measured emission. This effect, called “pulse desensitization,” relates to the capabilities of the measuring instrument. For the measurement and reporting of the true peak of pulsed emissions, it may be necessary to apply a “pulse desensitization correction factor” (PDCF) to the measured value, pursuant to 47 CFR 15.35(a).

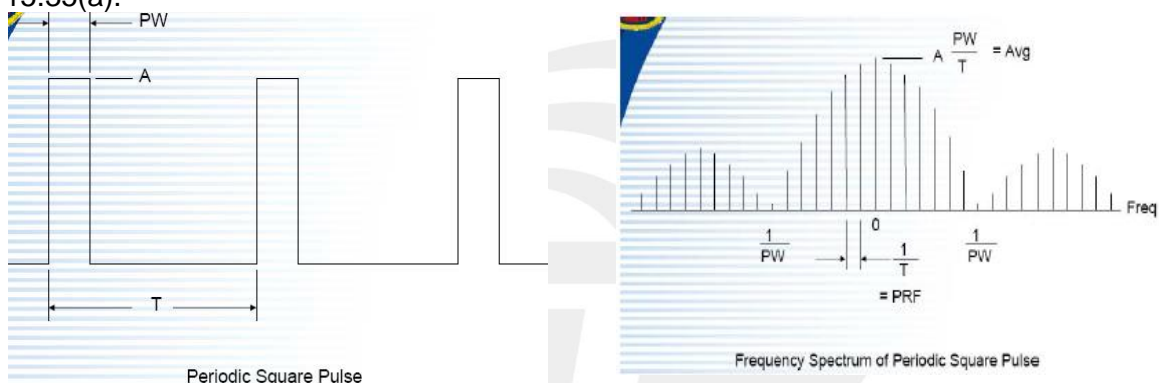

If using spectrum analyzer to measure pulse signal , it have to make sure the RBW use is at least $2/PW$.

•When RBW is less than $2/PW$, you are able to measure the true peak level of the pulse signal. If this is the case , PDCF is required to compensate to determine true peak value.

Pulse desensitization:

$PW = 48240 \text{ usec}$, $\text{Period} = 100000 \text{ usec}$, $\text{Level} = A$

$RBW > 2/PW = 0.00004K$, $1/T = 0.01K$

NOTE: $2 / PW < RBW$, first don't need

- b. For the actual test, please refer to the ANSI C63.10, Annex C refer to section 5 for more detail



4.7 TEST RESULTS

(Radiated Emission<30MHz (9KHz-30MHz, H-field))

Freq.	Reading	Limit	Margin	State
(MHz)	(dBuV/m)	(dBuV/m)	(dB)	P/F
--	--	--	--	PASS
--	--	--	--	PASS

Note: The amplitude of spurious emissions which are attenuated by more than 20dB below the permissible value has no need to be reported.

Distance extrapolation factor = $40 \log(\text{specific distance}/\text{test distance})$ (dB);

Limit line = specific limits(dBuv) + distance extrapolation factor.

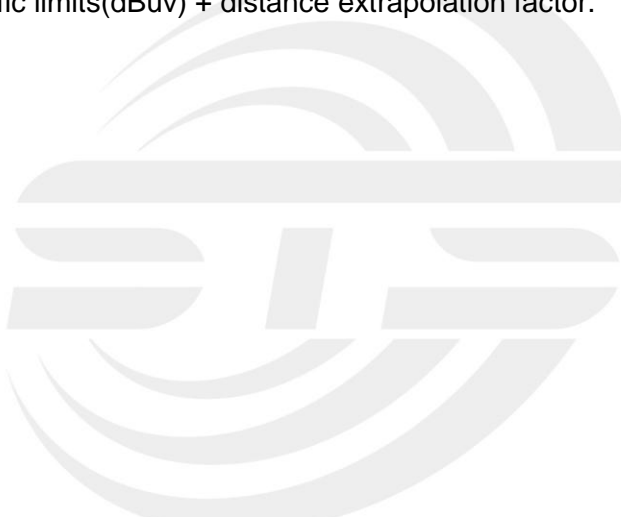



Between 30MHz – 5000 MHz

Temperature:	26 °C	Relative Humidity:	54%
Pressure:	1010hPa	Phase:	Horizontal
Test Mode:	Mode 1		

No.	Frequency (MHz)	Reading (dBuV)	Factor (dB)	Results (dBuV/m)	Limit (dBuV/m)	Margin (dB)	Detector
1	31.3992	37.59	-11.91	25.68	40.00	-14.32	QP
2	46.5030	44.48	-19.68	24.80	40.00	-15.20	QP
3	93.1132	45.86	-19.88	25.98	43.50	-17.52	QP
4	106.7587	43.40	-18.61	24.79	43.50	-18.71	QP
5	433.9200	74.48	-10.90	63.58	100.83	-37.25	PK
6	867.8400	45.83	-2.61	43.22	60.83	-17.61	QP

AV

No.	Frequency (MHz)	PK level (dBuV)	Duty cycle Factor(dBm)	Results (dBuV/m)	Limit (dBuV/m)	Margin (dB)	Detector
7	433.9200	63.58	-6.33	57.25	80.83	-23.58	AV

Remark:

1. All readings are Quasi-Peak and Average values.
2. Margin = Result (Result =Reading + Factor)–Limit

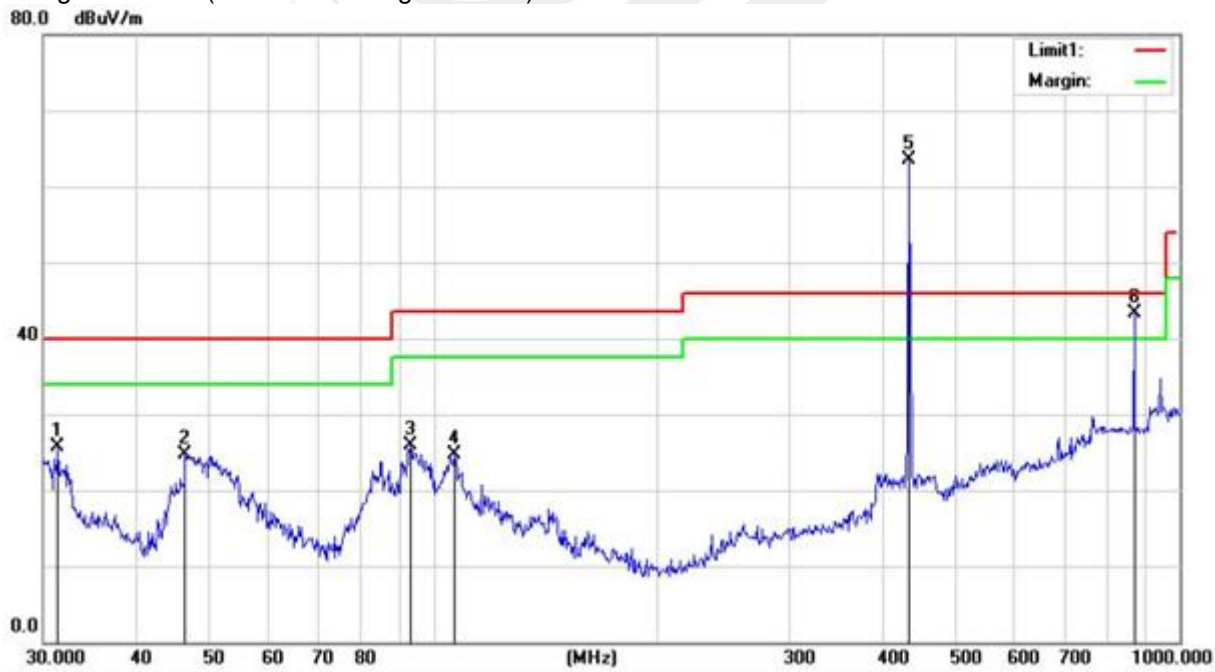



Temperature:	26 °C	Relative Humidity:	54%
Pressure:	1010hPa	Phase:	Vertical
Test Mode:	Mode 1		

No.	Frequency (MHz)	Reading (dBuV)	Factor (dB)	Results (dBuV/m)	Limit (dBuV/m)	Margin (dB)	Detector
1	30.5304	35.41	-11.47	23.94	40.00	-16.06	QP
2	45.8551	44.82	-19.34	25.48	40.00	-14.52	QP
3	50.9420	48.37	-21.75	26.62	40.00	-13.38	QP
4	102.3597	45.76	-18.99	26.77	43.50	-16.73	QP
5	433.9200	79.69	-10.90	68.79	100.83	-32.04	PK
6	867.8400	48.74	-2.61	46.13	60.83	-14.70	QP

AV

No.	Frequency (MHz)	PK level (dBuV)	Duty cycle Factor(dBm)	Results (dBuV/m)	Limit (dBuV/m)	Margin (dB)	Detector
7	433.9200	68.79	-6.33	62.46	80.83	-18.37	AV

Remark:

1. All readings are Quasi-Peak and Average values.
2. Margin = Result (Result = Reading + Factor) - Limit





PEAK Radiated Emission:

Frequency	Meter Reading	Detector	Amplifier	Loss	Antenna Factor	Orrected Factor	PK LEVEL Result	FCC Part 15.231/15.209/205		RX Antenna
								Limit	Margin	Polar
(MHz)	(dBµV/m)	(PK/QP/AV)	(dB)	(dB)	(dB/m)	(dB)	(dBµV/m)	(dBµV/m)	(dB)	(H/V)
867.84	35.36	PK	--	3.3	23	26.30	61.66	80.83	-19.17	H
867.84	35.8	PK	--	3.3	23	26.30	62.10	80.83	-18.73	V
1301.76	64.22	PK	45.1	4.0	25.1	-16.00	48.22	74	-25.78	H
1301.76	64.9	PK	45.1	4.0	25.1	-16.00	48.90	74	-25.10	V
1735.68	62.39	PK	44.1	5.3	25	-13.80	48.59	74	-25.41	H
1735.68	62.92	PK	44.1	5.3	25	-13.80	49.12	74	-24.88	V
2169.6	60.14	PK	43.8	5.4	25.9	-12.47	47.67	74	-26.33	H
2169.6	60.82	PK	43.8	5.4	25.9	-12.47	48.35	74	-25.65	V
2603.3	56.3	PK	44.4	6.0	27.6	-10.77	45.53	74	-28.47	H
2603.3	56.94	PK	44.4	6.0	27.6	-10.77	46.17	74	-27.83	V

Note: Above 2.6 GHz The amplitude of spurious emissions which are attenuated by more than 20dB below the permissible value has no need to be reported.
 Result = Reading +Orrected factor; Orrected factor=Ant factor +loss-Amp factor

AV Radiated Emission:

AV = Peak +20Log10(duty cycle) =PK+(-6.33) [refer to section 5 for more detail]

Frequency	PK Reading	Duty cycle Factor	Corrected Amplitude	FCC Part 15.231/15.209/205		RX Antenna
				Limit	Margin	Polar
(MHz)	(dBµV/m)	(dB)	(dBµV/m)	(dBµV/m)	(dB)	(H/V)
867.84	61.66	-6.33	55.33	60.83	-5.50	H
867.84	62.1	-6.33	55.77	60.83	-5.06	V
1301.76	48.22	-6.33	41.89	54	-12.11	H
1301.76	48.9	-6.33	42.57	54	-11.43	V
1735.68	48.59	-6.33	42.26	54	-11.74	H
1735.68	49.12	-6.33	42.79	54	-11.21	V
2169.6	47.67	-6.33	41.34	54	-12.66	H
2169.6	48.35	-6.33	42.02	54	-11.98	V
2603.3	45.53	-6.33	39.20	54	-14.80	H
2603.3	46.17	-6.33	39.84	54	-14.16	V



5. BANDWIDTH TEST

5.1 APPLIED PROCEDURES / LIMIT

FCC Part 15.231, Subpart C				
Section	Test Item	Limit	Frequency Range (MHz)	Result
15.231(C)	20 Bandwidth	The 20dB bandwidth of the emissions shall not exceed 0.25% of the center frequency	433.92	PASS

Spectrum Parameter	Setting
Attenuation	Auto
Span Frequency	> Measurement Bandwidth
RB	10 kHz (20dB Bandwidth)
VB	30 kHz (20dB Bandwidth)
Detector	Peak
Trace	Max Hold
Sweep Time	Auto

5.2 TEST REQUIREMENTS

The bandwidth of the emission shall be no wider than 0.25% of the center frequency for devices operating above 70 MHz and below 900 MHz. For devices operating above 900 MHz, the emission shall be no wider than 0.5% of the center frequency. Bandwidth is determined at the points 20 dB down from the modulated carrier.

5.3 TEST PROCEDURE

- The EUT was directly connected to the spectrum analyzer and antenna output port as show in the block diagram below.
- Spectrum Setting : RBW= 10KHz, VBW=30KHz, Sweep time = Auto.

5.4 TEST SETUP



5.5 EUT OPERATION CONDITIONS

TX mode.



5.6 TEST RESULTS

Centre Frequency	Measurement		
	20dB Bandwidth (KHz)	Limit(kHz)	Frequency Range (MHz)
433.92 MHz	60	1084.8	PASS

CH00 -1Mbps



6. DUTY CYCLE

6.1 TEST PROCEDURE

The EUT was directly connected to the spectrum analyzer and antenna output port as show in the block diagram below.

The Duty Cycle Was Determined By The Following Equation: To Calculate The Actual Field Intensity,The Duty Cycle Correction Factor In Decibel Is Needed For Later Use And Can Be Obtained From Following Conversion

Duty Cycle(%)=Total On Interval In A Complete Pulse Train/ Length Of A Complete Pulse Train * %

Duty Cycle Correction Factor(Db)=20 * Log10(Duty Cycle(%))

6.2 TEST SETUP

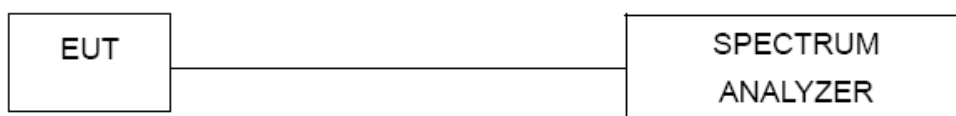

6.3 EUT OPERATION CONDITIONS

TX mode.





TX Mode

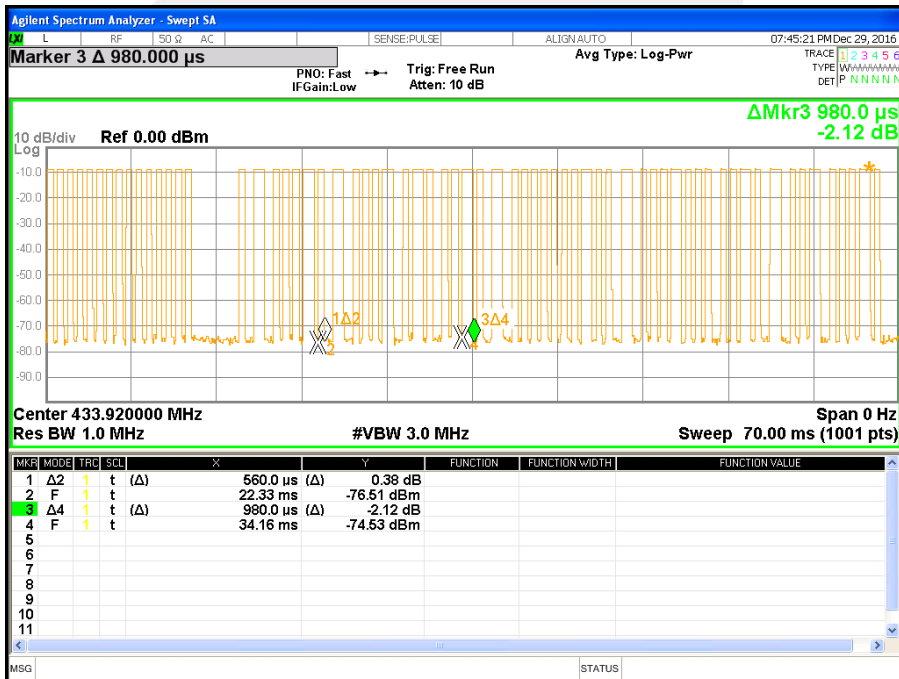
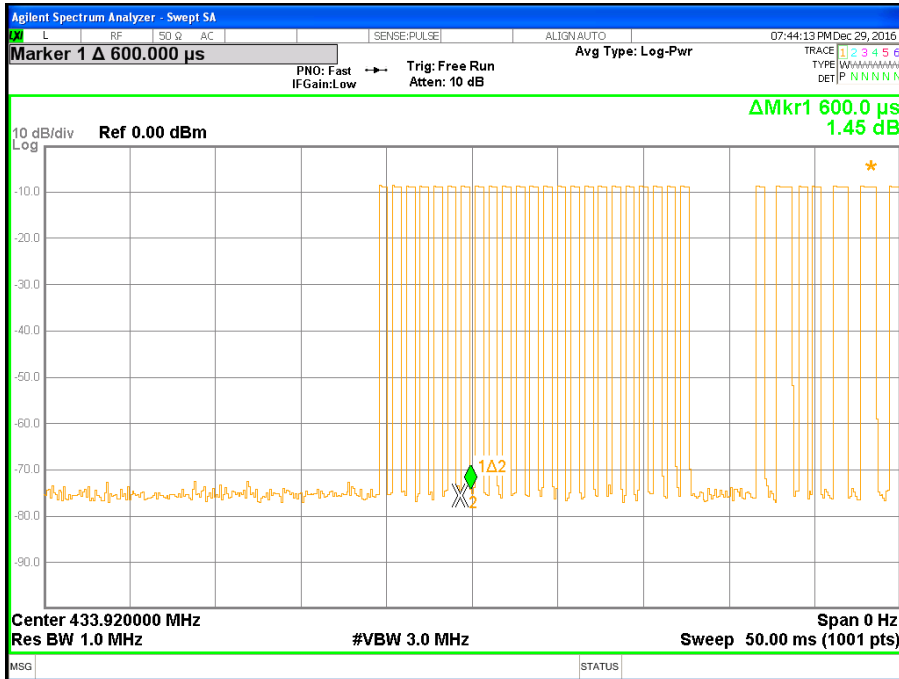



7. AUTOMATICALLY DEACTIVATE

7.1 STANDARD REQUIREMENT

A manually operated transmitter shall employ a switch that will automatically deactivate the transmitter within not more than 5 seconds of being released.

7.2 TEST PROCEDURE

The EUT was directly connected to the spectrum analyzer and antenna output port as show in the block diagram below.

Spectrum Setting : RBW= 1MHz, VBW=3MHz, Sweep time = 10s.

Note:

(1)Refer to the plot (As Below),We find a manumotive operated transmitter shall employ a switch that will automatically deactivate the transmitteri immediately, within not more than 5 seconds of being released.

(2)The EUT is comply with FCC PART 15 clause 15.231(a)(1). manumotive working mode are pre-tested.and only the worst result is reported.

7.3 TEST SETUP



7.4 TEST RESULTS

Activation time	Limit(Sec)	Result
0.07 s	5 s	Pass

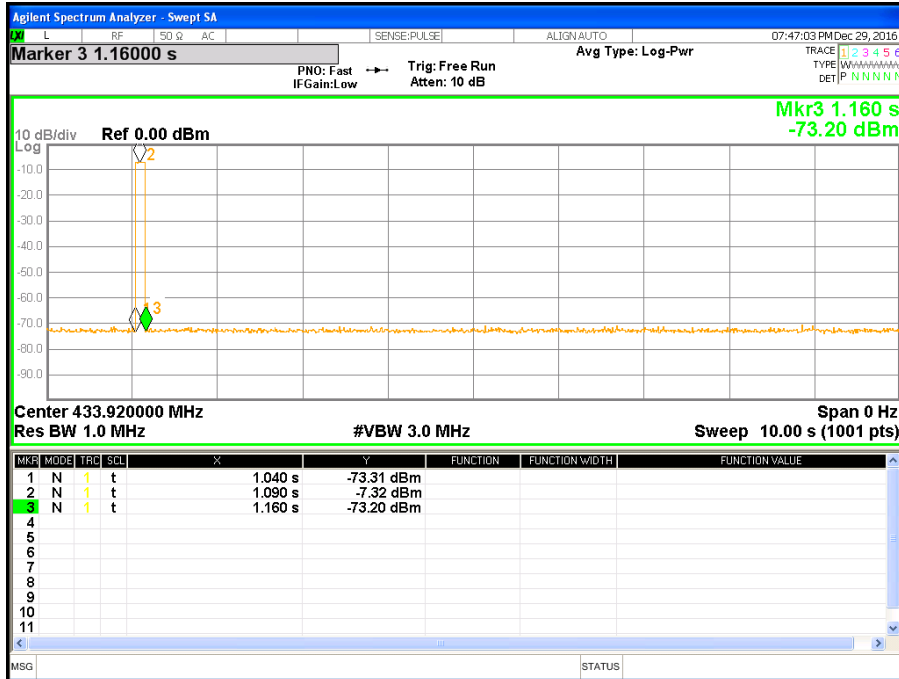

Mark 1: Hold down the Key(Start transmitting)

Mark 2: Loose the Key

Mark 3: Stop transmitting

Activation time= Mark 3- Mark 2=1.160 – 1.090=0.07 s



8. ANTENNA REQUIREMENT

8.1 STANDARD REQUIREMENT

According to the FCC Part 15 Paragraph 15.203, an intentional radiator shall be designed to ensure that no antenna other than that furnished by the responsible party shall be used with the device.

8.2 EUT ANTENNA

The EUT antenna is Internal PCB Antenna. It conforms to the standard requirements.



APPENDIX 1- PHOTOS OF TEST SETUP

Radiated Measurement Photos

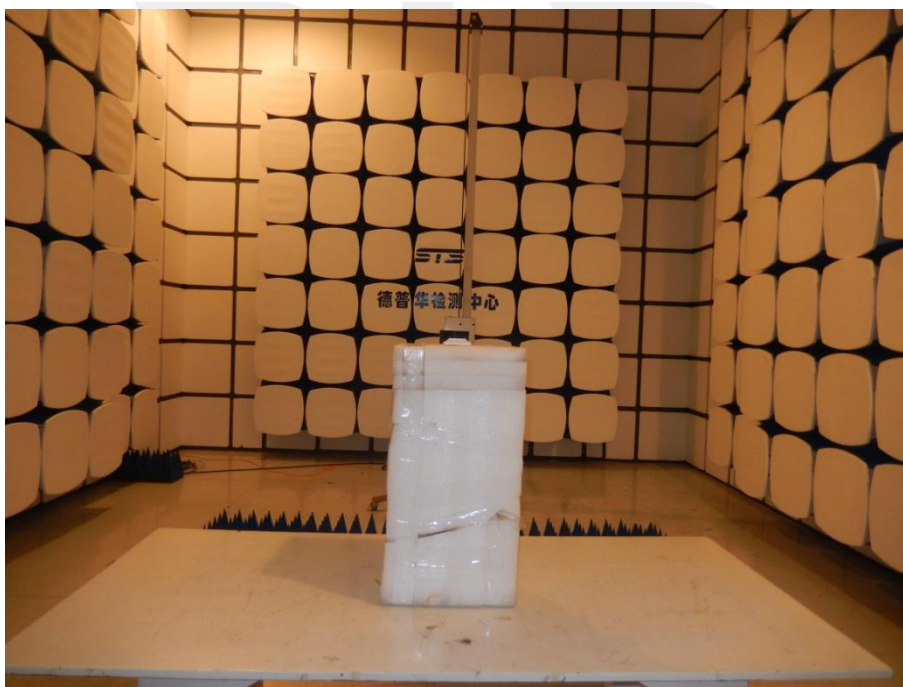

※※※※END OF THE REPORT※※※※