

FCC/ISED RF Test Report
As per

RSS-247 Issue 2

FCC Part 15.247 Subpart C

Unlicensed Intentional Radiators
(FHSS)
ZX Door Switch

IC:8410A-ZXDS; FCC ID: XEY-ZX-DS

Prepared to:

Verdant. Environmental Technologies, Inc.

1850 – 55th Avenue, Lachine, Quebec, H8T 3J5
CANADA



Product Service

Choose certainty.
Add value.

RESPONSIBLE FOR	NAME	DATE	SIGNATURE
Test Specialist	Jose Martinez	12-09-2019	
Authorised Signatory	Scott Drysdale	12-09-2019	

Signatures in this approval box have checked this document in line with the requirements of TÜV SÜD Product Service document control rules.

EXECUTIVE SUMMARY

A sample of this product was tested and found to be in compliance with FCC Part 15.247 Subpart C/ ICES 003 Issue 6 and RSS-247 Issue 2.



A2LA Cert. No. 2955.20

DISCLAIMER AND COPYRIGHT

This non-binding report has been prepared by TÜV SÜD Canada with all reasonable skill and care. The document is confidential to the potential Client and TÜV SÜD Canada. No part of this document may be reproduced without the prior written approval of TÜV SÜD Canada. © TÜV SÜD.

ACCREDITATION

Our A2LA Accreditation does not cover opinions and interpretations and any expressed are outside the scope of our A2LA Accreditation.

TÜV SÜD Product Service
is a trading name of TÜV SÜD Ltd
2972 Joseph-A-Bombardier
Laval, QC H7P 6E3 Canada

TUV SUD Ltd is a
TÜV SÜD Group Company

Phone: +450-687-4976
www.tuv-sud.ca



Contents

- 1 Report Summary 6**
- 2 Introduction 7**
- 3 EUT: ZX DOOR SWITCH..... 12**
 - 3.1 Radio Specifications:..... 12
 - 3.2 Modes of Operation..... 14
 - 3.3 Setup Diagram 14
- 4 Deviations from the Standard..... 15**
- 5 Measurement Uncertainty..... 15**
- 6 99% Bandwidth 16**
 - 6.1 Purpose & Methods..... 16
 - 6.2 Test Specifications 16
 - 6.3 Test Results..... 17
 - 6.4 Graphs..... 18
 - 6.5 Test Instruments 21
- 7 Hopping Channel 22**
 - 7.1 Purpose & Methods..... 22
 - 7.2 Test Specifications 22
 - 7.3 Limits 23
 - 7.4 Test Results..... 23
 - 7.5 Graphs..... 24
 - 7.6 Test Instruments 27
- 8 Channel Separation..... 28**
 - 8.1 Purpose & Methods..... 28
 - 8.2 Test Specifications 28
 - 8.3 Limits 29
 - 8.4 Test Results..... 29
 - 8.5 Graphs..... 30
 - 8.6 Test Instruments 31
- 9 Time of Occupancy 32**
 - 9.1 Purpose & Methods..... 32
 - 9.2 Test Specifications 32
 - 9.3 Limits 33
 - 9.4 Test Results..... 33
 - 9.5 Graphs..... 34
 - 9.6 Test Instruments 35
- 10 Maximum Peak Envelope Conducted Power – Digital Modulated 36**
 - 10.1 Purpose & Methods..... 36
 - 10.2 Test Specifications 36
 - 10.3 Limits 37
 - 10.4 Tests Results 37
 - 10.5 Graphs..... 37



Product Service

ZX Door Switch Sensor

10.6	Test Instruments	41
11	Band Edge Spurious Emission (-20 dBc Requirement).....	42
11.1	Purpose & Methods.....	42
11.2	Test Specifications	42
11.3	Limits	43
11.4	Test Setup	43
11.5	Test Results.....	43
11.6	Graphs.....	44
11.7	Test Instruments	50
12	Tx Spurious Radiated Emissions	51
12.1	Purpose & Methods.....	51
12.2	Test Specifications	52
12.3	Limits	53
12.4	Results.....	53
12.5	Graphs.....	54
12.6	Test Instruments	62

TABLE OF APPENDICES

APPENDIX A	Tx Spurious Emissions – Worst Cases.....	63
-------------------	-------------------------------------------------	-----------



LIST OF TABLES

Table 1 – Modification Records 6

Table 2 – Test Summary Table 9

Table 3 – EUT – ZX DOOR SWITCH – Radio Specifications 12

Table 4 List of Channels for ZX Door Switch 900 MHz Band 13

Table 5 Acceptable Uncertainties 15

Table 6 – 99% Bandwidth Results..... 17

Table 7: 99%BW Test Equipment..... 21

Table 8 – Hopping Channel Results 23

Table 9 – Hopping Channel Results 23

Table 10: Hopping Channel Test Equipment 27

Table 11 – Channel Separation Results 29

Table 12 – Channel Separation Results 29

Table 13: Channel Separation Test Equipment 31

Table 14 – Time Occupancy Results..... 33

Table 15: Time of Occupancy Test Equipment 35

Table 16 – Test Results Peak-Power Measurements ZX Door Switch 37

Table 17: Conducted Peak Power Test Equipment..... 41

Table 18- Results – ZX Door Switch – Band Edge..... 43

Table 19 – Test Instrumentation – Band Edge..... 50

Table 20 Limits – Tx Spurious..... 51

Table 21 – Test Results for Tx Spurious Emission – Lowest Margin – Peak Measurements..... 53

Table 22 – Test Instrumentation – Tx Spurious Emission 62

LIST OF FIGURES

Figure 1: EUT Setup Diagram – ZX DOOR SWITCH – Spurious emissions 14



Product Service

ZX Door Switch Sensor

LIST OF GRAPHS

Graph 1 Test Results – 99% Bandwidth Results – Low Channel ZX Door Switch 18

Graph 2 Test Results – 99% Bandwidth Results – Mid Channel ZX Door Switch 19

Graph 3 Test Results – 99% Bandwidth Results – High Channel ZX Door Switch..... 20

Graph 4: Hopping Channel – ZX Door Switch –902MHz to 912.1MHz 24

Graph 5: Hopping Channel – ZX Door Switch – 912.1MHz – 920.1MHz 25

Graph 6: Hopping Channel – ZX Door Switch – 920.1MHz – 928MHz 26

Graph 7: Channel Separation – ZX Door Switch..... 30

Graph 8: Time of Occupancy – ZX Door Switch..... 34

Graph 9 Test Results – Conducted Peak Power Measurements – Low Channel..... 38

Graph 10 Test Results – Conducted Peak Power Measurements – Mid Channel..... 39

Graph 11 Test Results – Conducted Peak Power Measurements – High Channel 40

Graph 12 Test Results – Band Edge – 9kHz to 150kHz – Low Channel..... 44

Graph 13 Test Results – Band Edge –150kHz to 30MHz – Low Channel..... 45

Graph 14 Test Results – Low Band Edge –30MHz to 1GHz – Low Channel 46

Graph 15 Test Results – Low Band Edge – 902.22 MHz– Mid Channel 47

Graph 16 Test Results – Band Edge – 927.73MHz to 928.43MHz– Mid Channel 48

Graph 17 Test Results – Band Edge –1GHz to 10 GHz – High Channel 49

Graph 18 Test Results – Tx Spurious 9kHz to 150kHz – Mid Channel 55

Graph 19 Test Results – Tx Spurious Emission 30MHz to 1GHz – Mid Channel – Vertical Polarization 56

Graph 20 Test Results – Tx Spurious emission 30MHz to 1GHz – Mid Channel – Horizontal Polarization..... 57

Graph 21 Test Results – Tx Spurious emission 1GHz to 3GHz – Mid Channel – Vertical Polarization..... 58

Graph 22 Test Results – Tx Spurious emission 1GHz – 3GHz – Mid Channel – Horizontal Polarization..... 59

Graph 23 Test Results – Tx Spurious emission 3GHz – 10GHz – Mid Channel – Horizontal Polarization..... 60

Graph 24 Test Results – Tx Spurious emission 3GHz – 10GHz – Mid Channel – Vertical polarisation 61



1 Report Summary

Report Modification Record

Alterations and additions to this report will be issued to the holders of each copy in the form of a complete document.

Issue	Description of Change	Date of Issue
1	First Issue	April 27, 2020

Table 1 – Modification Records

Acronyms & Definitions

The following definitions and acronyms are applicable in this report. See also ANSI C63.14.

Acronyms

AM	Amplitude Modulation
DTS	Digital Transmission System
EIRP	Equivalent Isotropical Radiated Power
ETSI	European Telecommunications Standards Institute
EUT	Equipment Under Test
FVIN	Firmware Version Identification Number
HVIN	Hardware Version Identification Number(s)
OOB	Out of Band
PKPSD	Peak Power Spectrum Density
RBW	Resolution Bandwidth
RF	Radio Frequency of oscillation rate of electromagnetic fields (e.g. radio waves: 9kHz to 300GHz)
RMS	Root mean square, i.e., $V_p / \sqrt{2}$
Rx	Referred as antennae for receiving RF signals
SD	Spurious Domain
TR	Technical Report
Tx	Referred as antenna for transmitting RF signals
VBW	Video Bandwidth
Vp	Peak Voltage



2 Introduction

Applicant:	Verdant Environmental Technologies, Inc.
Manufacturer:	Verdant Environmental Technologies, Inc.
Number of Samples Tested:	1
Test Specification/Issue/Date:	RSS-247 Issue 2 : February 2017 FCC Part 15 Subpart C.247 2016 ICES 003 Issue 6:2019
Test Plan/Issue/Date:	N/A
Project Number:	7169005571
Date:	2019-02-26
Date of Receipt of EUT:	2019-02-10
Start of Test:	2019-02-26
Finish of Test:	2019-04-08
Name of Tester(s):	Abderrahmane Ferhat
Related Documents:	ANSI C63.10:2013 FCC 15. Subpart 15 Subpart C/RSS-247



Brief Summary of Results

A brief summary of the tests carried out in accordance with RSS-247 Issue 2, FCC Part 15 Subpart 15.247, FCC Part 15 Subpart 15.207 & FCC Part 15 Subpart 15.209 is summarized in Table 2.

Report Section	FCC Rule	IC Rule	Description	Class/Limit	Result
6	15.247(a)(1)(i)	RSS-247.5.1	99% Bandwidth Hopping System	≤500kHz	Pass
7	15.247(a)(1)(i)	RSS 247 5.1 (c)	Hopping Channels	≥50	Pass
8	15.247(a)(1)	RSS 247 5.1 (2)	Channel Separation	> 25 kHz or 20 dB BW	Pass
90	15.247(a)(1)(i)	RSS 247 5.1 (c)	Time of occupancy	<0.4 s in 20s period	Pass
10	15.247(b)(2)	RSS-247.5.4(a)	Maximum Peak Output Power (FHSS)	< 1W	Pass
11	§15.247(d)	RSS-247 5.5	Band-Edge Spurious Conducted Emission	≤ 20dBc	Pass
12	§15.209(a)	RSS-247 5.5	Tx Spurious Radiated Emission	Quasi-Peak Average	Pass



Product Service

ZX Door Switch Sensor

-	15.247(h)	RSS 247 5.1	FHSS Intelligence	Note 3	Pass
-	15.247(b)(4)	RSS 247 5.4 (3)	Antenna Gain	<6dBi <Note 2>	Pass
-	15.203 & 15.247(b)	RSS-210	Antenna Requirement	Note 1	Not Applicable
<p>Note 1: Manufacture uses a SMA antenna connector for unique coupling to the intentional radiator Note 2: For the Antenna requirement specified in FCC 15.203 (RSS-247 section 5.5), the unit uses a trace antenna with a gain of 1.2dBi. Note 3: The EUT does not coordinate transmission with any other FHSS to avoid simultaneous occupation of hopping frequencies Note 4: For maximum permissible exposure, this device operates at less than 1 Watt at 902 - 928MHz. It is designed to operate less than 20 cm from any personnel during normal operation. No testing is required; however, it complies with SAR exemption evaluation as determined the RF Exposure exhibits</p>					

Table 2 – Test Summary Table



Declaration of Build Status

This report addresses the Radio verification testing and test results of the ZX DOOR SWITCH and is herein referred to as EUT (Equipment Under Test). The EUT was tested for compliance against the following standards:

RSS-247 Issue 2:2017

FCC Part 15 Subpart C 15.247:2016

ICES 003 Issue 6: 2019

Test procedures, results, justifications, and engineering considerations, if any, follow later in this report.

This report does not imply product endorsement by any government, accreditation agency, or TÜV SÜD Canada Inc.

Opinions or interpretations expressed in this report, if any, are outside the scope of TÜV SÜD Canada Inc accreditations. Any opinions expressed do not necessarily reflect the opinions of TÜV SÜD Canada Inc, unless otherwise stated.

For a more detailed list of the standards and the revision used, see the "Applicable Standards, Specifications and Methods" section of this report.

Notes, Justification

The following notes, justifications for tests not performed or deviations from the above listed specifications apply:

For the Antenna requirement specified in FCC 15.203 (RSS-247 section 5.5), the unit uses a trace antenna with a gain of 1.2dBi.

For the Restricted Bands of operation, the EUT is designed to only operate between 902 – 907.6 MHz.



Product Service

ZX Door Switch Sensor

The EUT does not coordinate transmission with any other FHSS to avoid simultaneous occupation of hopping frequencies.

For maximum permissible exposure, this device operates at less than 1 Watt at 902 - 928MHz. It is designed to operate less than 20 cm from any personnel during normal operation. No testing is required; however, it complies with SAR exemption evaluation as determined the RF Exposure exhibits.

For antenna requirements, the antenna is soldered to a printed circuit board (see internal photos in Exhibit 09 Internal Photos_ZX-door-switch-sensor). Therefore, complies with section 15.203 2a (i).

For the scope of this test report, the EUT was mounted in three orthogonal axes to maximize emissions. Worst case results are presented



3 EUT: ZX DOOR SWITCH

3.1 Radio Specifications:

PRODUCT NAME:	ZX Door Switch
MANUFACTURER:	Verdant Environmental Technologies, Inc
MODEL	DS
FREQUENCY RANGE (MHz)	902-928
VOLTAGE RATING:	5Vdc
HVIN	DS
FVIN	V1.00

Table 3 – EUT – ZX DOOR SWITCH – Radio Specifications



Product Service

ZX Door Switch Sensor

Channels	Frequency (MHz)	Channels	Frequency (MHz)	Channels	Frequency (MHz)
#0	902.46	#31	914.24	#62	926.02
#1	902.84	#32	914.62	#63	926.4
#2	903.22	#33	915	#64	926.78
#3	903.6	#34	915.38	#65	927.16
#4	903.98	#35	915.76	#66	927.54
#5	904.36	#36	916.14	#67	927.92
#6	904.74	#37	916.52		
#7	905.12	#38	916.90		
#8	905.5	#39	917.28		
#9	905.88	#40	917.66		
#10	906.26	#41	918.04		
#11	906.64	#42	918.42		
#12	907.02	#43	918.8		
#13	907.4	#44	919.18		
#14	907.78	#45	919.56		
#15	908.16	#46	919.94		
#16	908.54	#47	920.32		
#17	908.92	#48	920.7		
#18	909.3	#49	921.08		
#19	909.68	#50	921.46		
#20	910.06	#51	921.84		
#21	910.44	#52	922.22		
#22	910.82	#53	922.6		
#23	911.2	#54	922.98		
#24	911.58	#55	923.36		
#25	911.96	#56	923.74		
#26	912.34	#57	924.12		
#27	912.72	#58	924.5		
#28	913.1	#59	924.88		
#29	913.48	#60	925.26		
#30	913.86	#61	925.64		

Table 4 List of Channels for ZX Door Switch 900 MHz Band



3.2 Modes of Operation

The ZX DOOR SWITCH is operating at 915 MHz and for operation, wireless was configured to transmit at 100% duty cycle:

The transmitter was provided in 2 different settings:

- A configuration with special test firmware was installed on the EUT to control hopping through its pseudo random sequence and single channel
- A configuration with low, medium and high channels transmitting continuously at a 100% duty cycle.

3.3 Setup Diagram

During the EUT was exercised by powering to the rated voltage and connecting according to Figure 1.

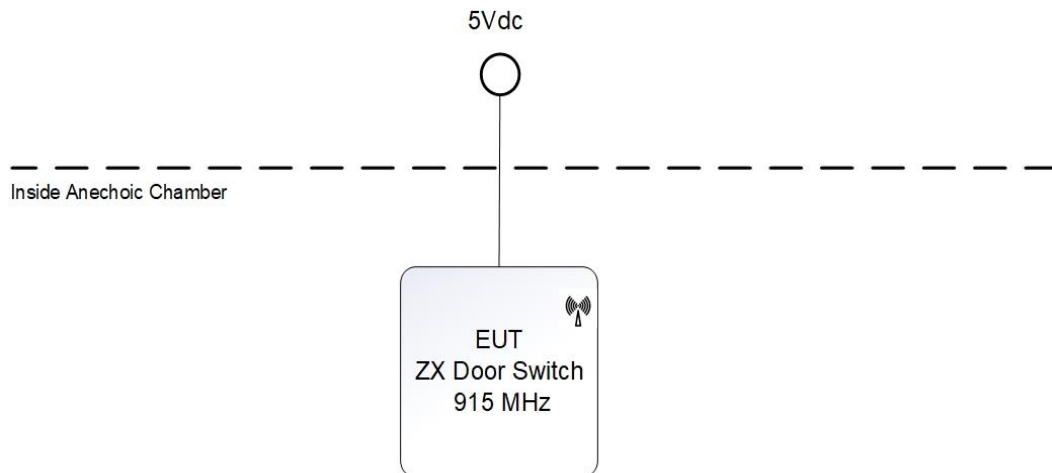

Figure 1: EUT Setup Diagram – ZX DOOR SWITCH – Spurious emissions



4 Deviations from the Standard

No deviations from the applicable test standard were made during testing.

5 Measurement Uncertainty

The expanded measurement uncertainty is calculated in accordance with CISPR 16-4-2. For instance, for the range of 0.15MHz-30MHz, 30MHz – 1GHz and 1GHz – 18GHz is ± 3.3 dB, ± 4.25 dB and ± 4.93 dB, respectively with a 'k=2' coverage factor and a 95% confidence level.

Parameter	Uncertainty
Occupied channel Bandwidth	$\pm 5\%$
RF output power, conducted	± 1.5 dB
Power Spectral Density, conducted	± 3 dB
Unwanted Emission, conducted	± 3 dB
All emission, radiated	± 6 dB
Temperature	$\pm 3^{\circ}\text{C}$
Time Occupancy	$\pm 3\%$

Table 5 Acceptable Uncertainties



6 99% Bandwidth

6.1 Purpose & Methods

The Purpose & Methods of this test is to ensure that the bandwidth occupied exceeds a stated minimum. This helps ensure the utilization of the frequency allocation is sufficiently wide. This also helps prevent corruption of data by ensuring adequate data separation to distinguish the reception of the intended information. The test method is a defined in ANSI C63.10.

6.2 Test Specifications

REFERENCE STANDARD	FCC 15.247(a)(1) ANSI C63.10-2013 Clause 6.9 RSS-247.5.1
SPECIFICATIONS	
Limit – Bandwidth (kHz)	≤500
Frequency range (MHz)	902.46 915 927.54
RBW (kHz):	Set to 1% to 3% of the 99% bandwidth
VBW (kHz)	3xRBW
EUT	
Identification	ZX Door Switch (915MHz)
Voltage Input	5Vdc
ENVIROMENTAL & TEST INFO	
Test Date (YYYY-MM-DD)	2019-04-08
Temperature (°C)	23.4± 2
Humidity (%)	36.3 ± 5
Atmospheric Pressure kPa (For Info Only)	109.7
Tester	Abderrahmane Ferhat
Client Witness	No Witness



6.3 Test Results

ZX Door Switch

The Channel #0 gave a maximum of 181.89 kHz for 99% BW. Details are depicted in Table 6.

Channel	Frequency (MHz)	20 dB Bandwidth (kHz)	Limits (kHz)	Results
Low channel	902.46	181.1	≤500	Pass
Middle Channel	915	181.89	≤500	Pass
Highest Channel	927.52		≤500	Pass

Table 6 – 99% Bandwidth Results



6.4 Graphs

The graphs showed below show the OBW during the operation of the device. This is measured by a max hold on the spectrum analyzer and the highest resolution bandwidth that is sufficiently low to exhibit the 99% bandwidth of a channel during operation of the EUT. Max hold is performed for a duration of not less than 1 minute. No attenuator was used between the EUT and the Spectrum Analyzer.

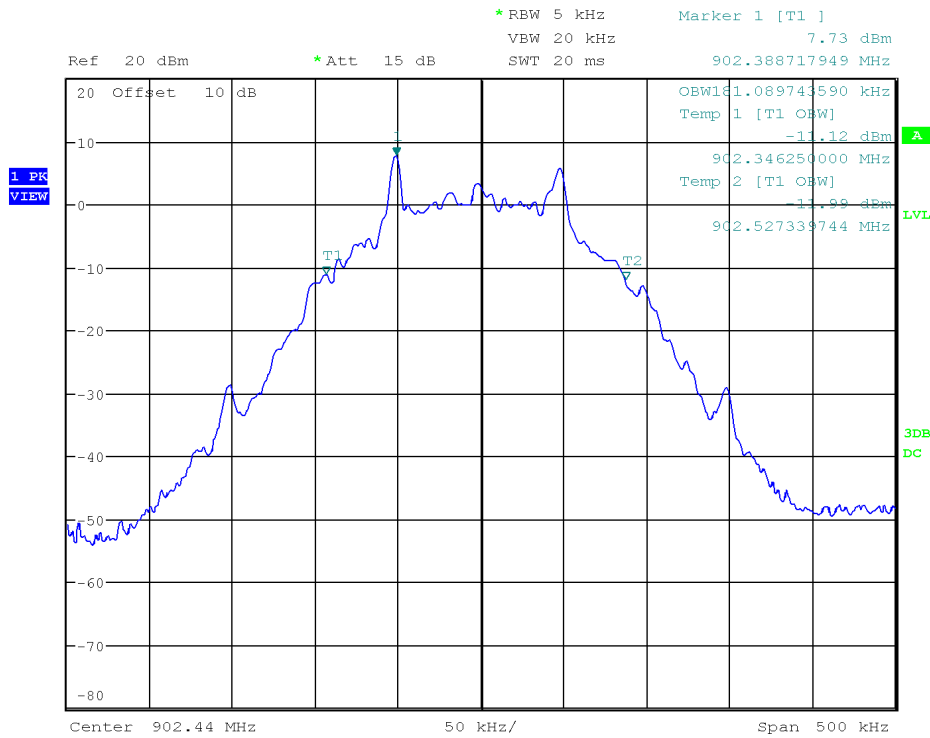

Date: 8.APR.2019 04:07:18

Graph 1 Test Results – 99% Bandwidth Results – Low Channel ZX Door Switch



Product Service

ZX Door Switch Sensor

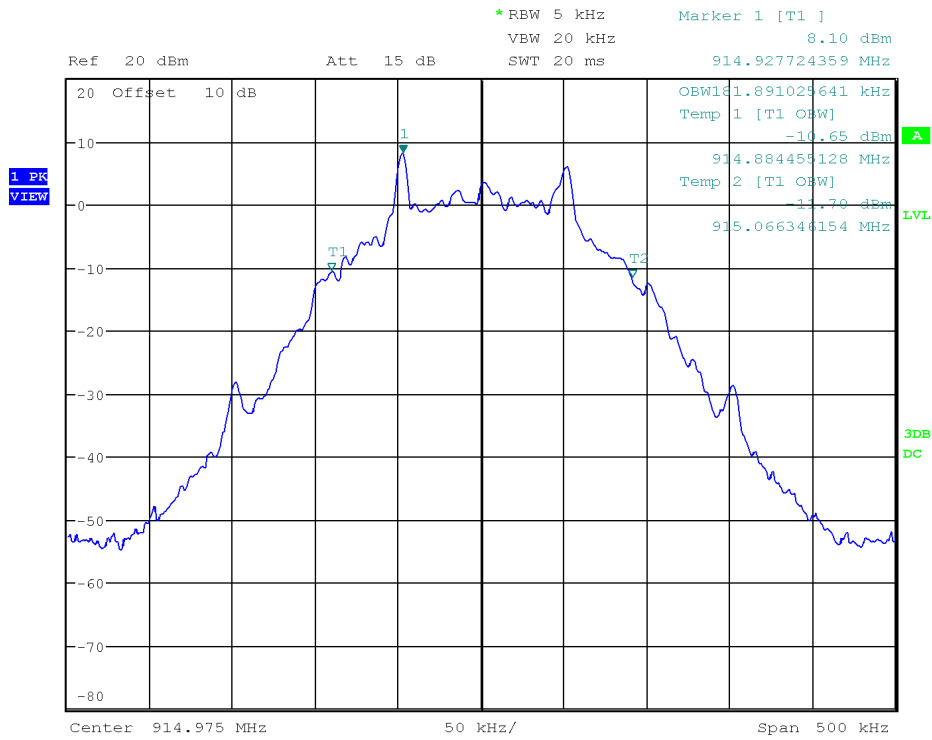

Date: 8.APR.2019 04:21:51

Graph 2 Test Results – 99% Bandwidth Results – Mid Channel ZX Door Switch

COMMERCIAL-IN-CONFIDENCE

No part of this document may be reproduced without the prior written approval of TÜV SÜD Canada. © TÜV SÜD.



Product Service

ZX Door Switch Sensor

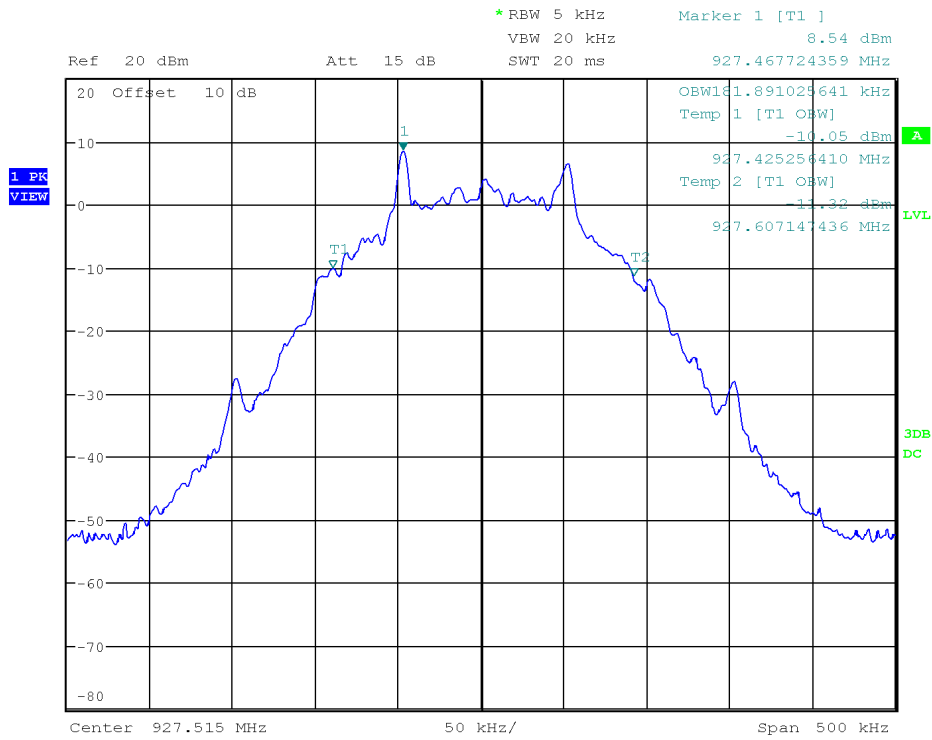

Date: 8.APR.2019 03:54:24

Graph 3 Test Results – 99% Bandwidth Results – High Channel ZX Door Switch

COMMERCIAL-IN-CONFIDENCE

No part of this document may be reproduced without the prior written approval of TÜV SÜD Canada. © TÜV SÜD.



6.5 Test Instruments

This test was carried out in Laval test location. Instrumentation used is depicted in Table 7.

Equipment	Model No.	Manufacturer	Calibration Period (months)	Calibration Due (YYY-MM-DD)	Asset No: LAVE
Spectrum Analyzer	ESU-40	Rohde & Schwarz	24	2019-04-20	4092
Attenuator 10 dB	4779-10	Narda	NCR	NCR	4096

Table 7: 99%BW Test Equipment



7 Hopping Channel

7.1 Purpose & Methods

The Purpose & Methods of this test is to ensure that the RF energy of frequency hopping systems is sufficiently spread over a spectrum and that the radio energy is not overly dense. This limit helps allow for other spread spectrum devices to co-exist in the same frequency spectrum. This also helps prevent corruption of data by ensuring adequate channel separation to distinguish the reception of the intended information. The test method is a defined in ANSI C63.10.

7.2 Test Specifications

REFERENCE STANDARD	FCC Part 15.247(a)(1)(i) RSS 247 5.1 (c)
SPECIFICATIONS	
Limits	See Section 15.247(a)(1)
Test Frequency (MHz):	902.46 915 927.52
RBW (kHz)	200
VBW (kHz)	500
EUT	
Identification	ZX Door Switch (900MHz)
Voltage Input	5Vdc
Environmental	Normal Conditions
Test Date (YYYY-MM-DD)	2019-04-08
Temperature (°C)	23.4 ± 1
Humidity (%)	36.3 ± 5
Atmospheric Pressure kPa (For Info Only)	109.7
Tester(s)	Abderrahmane Ferhat



Client Witness

No witness

7.3 Limits

The limits are as defined in 47 CFR FCC Part 15 Section 15.247(a)(1) and depicted in Table 8. The test method is defined in ANSI C63.10.

Frequency Band (MHz)	20 dB Bandwidth of the hopping channel	Hopping Number
902 – 928	≤250kHz	≥ 50 channels
	≥250 kHz	≥ 25 channels
	≥250 kHz	≥ 75 channels

Table 8 – Hopping Channel Results

7.4 Test Results

The EUT passed the requirements of the number of channels. The number of channels occupied by the EUT and 64 channels in the allocation band of 902 MHz to 928 MHz. Results are depicted in Table 9.

Channel	Range (MHz)	Number of Hopping Measured	Limits	Results
Middle Channel:	902 - 928	64	≥50 channels	Pass

Table 9 – Hopping Channel Results



7.5 Graphs

The graphs below show the number of occupied channels during the operation of the device. This is measured by a max hold on the spectrum analyser and the highest resolution bandwidth that is sufficiently low to exhibit the channel spacing of the signal being measured. This measurement is a peak measurement. Max hold is performed for a duration of not less than 10 minutes, or as sufficient to capture the channels occupied.

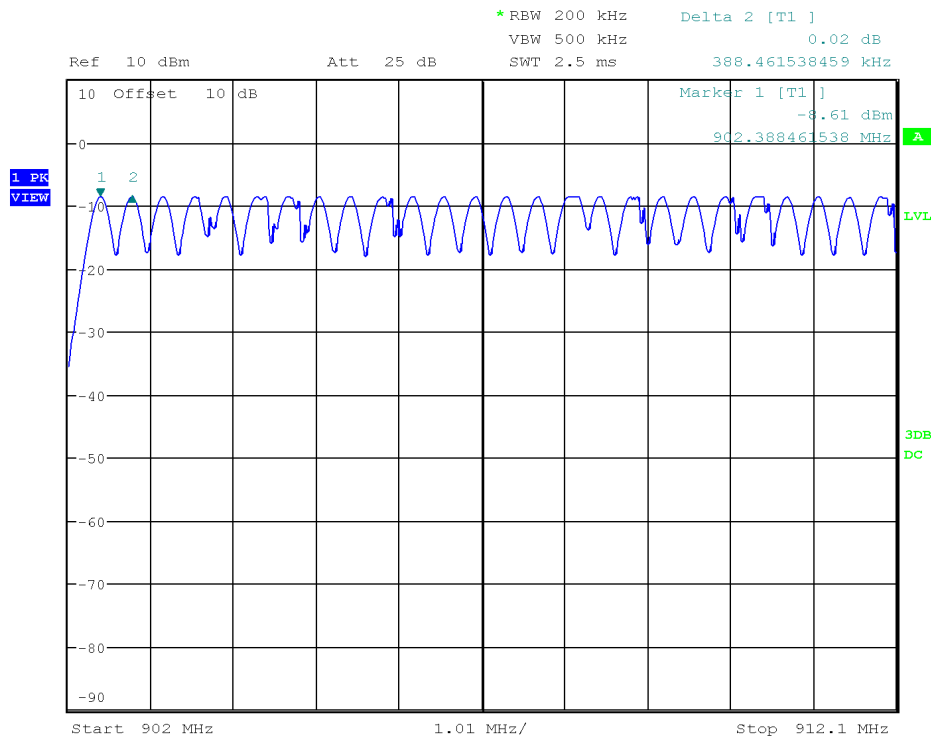

Date: 8.APR.2019 04:39:45

Graph 4: Hopping Channel – ZX Door Switch –902MHz to 912.1MHz



Product Service

ZX Door Switch Sensor

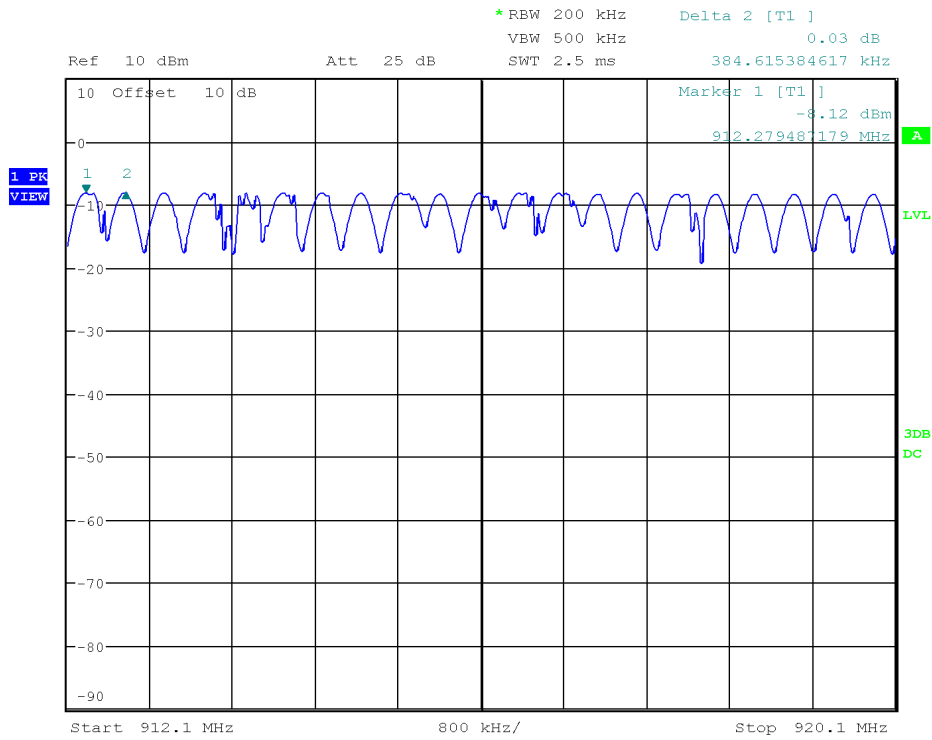

Date: 8.APR.2019 04:51:25

Graph 5: Hopping Channel – ZX Door Switch – 912.1MHz – 920.1MHz



Product Service

ZX Door Switch Sensor

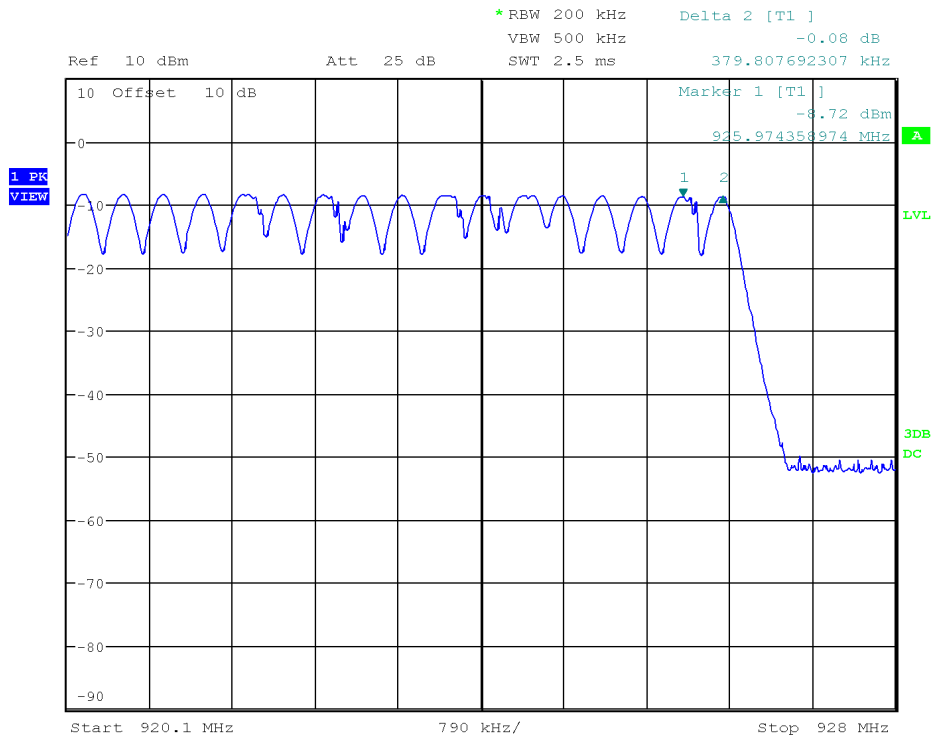

Date: 8.APR.2019 04:54:42

Graph 6: Hopping Channel – ZX Door Switch – 920.1MHz – 928MHz



7.6 Test Instruments

This test was carried out in Laval test location. Instrumentation used is depicted in Table 10.

Equipment	Model No.	Manufacturer	Calibration Period (months)	Calibration Due (YYY-MM-DD)	Asset No: LAVE
Spectrum Analyzer	ESU-40	Rohde & Schwarz	24	2019-04-20	4092
Attenuator 10 dB	4779-10	Narda	NCR	NCR	4096

Table 10: Hopping Channel Test Equipment



8 Channel Separation

8.1 Purpose & Methods

The Purpose & Methods of this test is to ensure that the RF energy of frequency hopping systems is sufficiently spread over a spectrum and that the radio energy is not overly dense. This limit helps allow for other spread spectrum devices to co-exist in the same frequency spectrum. This also helps prevent corruption of data by ensuring adequate channel separation to distinguish the reception of the intended information. The test method is a defined in ANSI C63.10.

8.2 Test Specifications

REFERENCE STANDARD FCC Part 15.247(a)(1).
RSS 247 5.1 (2)

SPECIFICATIONS

Limit ≥ 20 dB Bandwidth

Frequency range (MHz) 902.46
915
927.52

RBW (kHz): 100

VBW (kHz) 300

EUT

Identification ZX DOOR SWITCH

Voltage Input 5Vdc

ENVIROMENTAL & TEST INFO

Test Date (YYYY-MM-DD) 2019-04-08

Temperature (°C) 23.4 ± 1

Humidity (%) 36.3 ± 5

Atmospheric Pressure kPa (For Info Only) 109.7

Tester Abderrahmane Ferhat

Client Witness No Witness



8.3 Limits

The limits are as defined in 47 CFR FCC Part 15 Section 15.247(a)(1). The test method is defined in ANSI C63.10 as shown in the Table 11, below.

Frequency Band	20 dB Bandwidth of the hopping channel	Limits <Note 1>
902 - 928	≤250kHz	25kHz or 20dB BW
Note 1: The minimum channel separation is given by the greater of 25 kHz or 20 dB BW for unconditional operation. The 20 dB BW of the system was measured to be 184.63 kHz. Therefore, a channel separation limit of 182.7kHz applies.		

Table 11 – Channel Separation Results

8.4 Test Results

The results of the EUT are detailed in Table 12.

Channel	Range (MHz)	Channel Separation Measured (kHz)	Limits < kHz>	Results
Middle Channel:	902 - 915	381.53	≥182.7	Pass

Table 12 – Channel Separation Results



8.5 Graphs

The graphs shown below shows the channel spacing during the operation of the device. This is measured by a max hold on the spectrum analyser and the highest resolution bandwidth that is sufficiently low to exhibit the channel spacing of the signal being measured. This measurement is a peak measurement. Max hold is performed for a duration of not less than 1 minute, as the device is stepping through its hopping table.

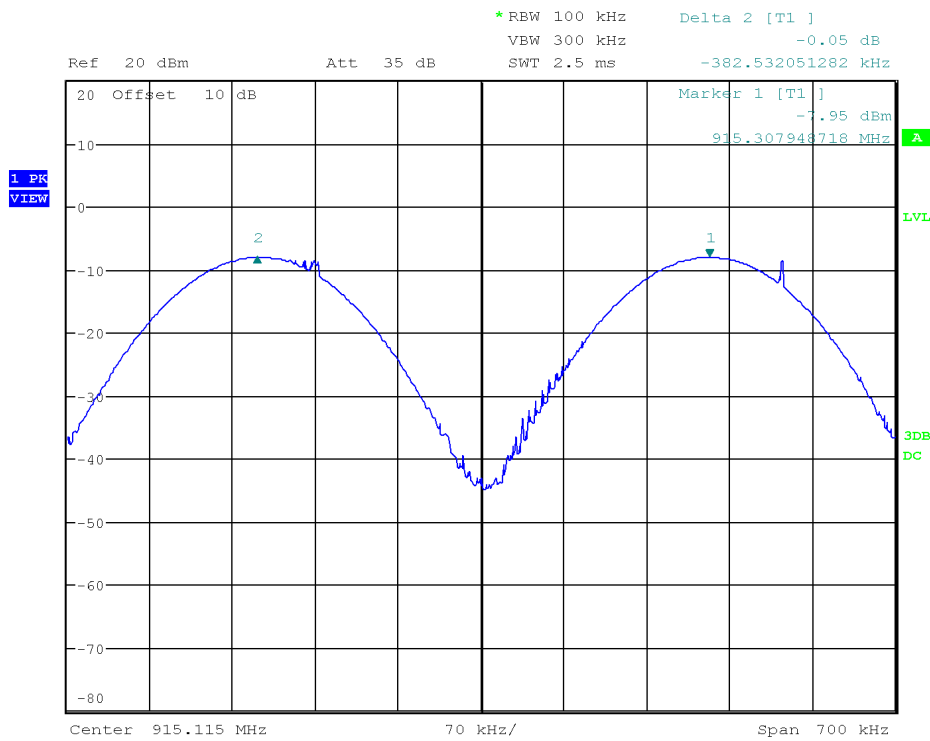

Date: 8.APR.2019 04:59:08

Graph 7: Channel Separation – ZX Door Switch



8.6 Test Instruments

This test was carried out in Laval test location. Instrumentation used is depicted in Table 13.

Equipment	Model No.	Manufacturer	Calibration Period (months)	Calibration Due (YYY-MM-DD)	Asset No: LAVE
Spectrum Analyzer	ESU-40	Rohde & Schwarz	24	2019-04-20	4092
Attenuator 10 dB	4779-10	Narda	NCR	NCR	4096

Table 13: Channel Separation Test Equipment



9 Time of Occupancy

9.1 Purpose & Methods

The purpose of this test is to ensure that the RF energy of frequency hopping systems is hopping at a minimum defined rate. This helps ensure sufficient time off to enable other frequency hopping devices to co-operate within this allocated band.

9.2 Test Specifications

REFERENCE STANDARD	FCC Part 15.247(a)(1). RSS 247 5.1 (2)
SPECIFICATIONS	
Limit	See FCC 15.247(a)(1)(i).
Frequency range (MHz)	902.46 915 927.52
RBW (kHz):	200
VBW (kHz)	500
EUT	
Identification	ZX DOOR SWITCH
Voltage Input	5Vdc
ENVIROMENTAL & TEST INFO	
Test Date (YYYY-MM-DD)	2019-03-21
Temperature (°C)	23.4 ± 1
Humidity (%)	36.3 ± 5
Atmospheric Pressure kPa (For Info Only)	109.7
Tester	Abderrahmane Ferhat
Client Witness	No Witness



9.3 Limits

For frequency hopping systems operating in the 902-928 MHz band: if the 20 dB bandwidth of the hopping channel is less than 250 kHz, the system shall use at least 50 hopping frequencies and the average time of occupancy on any frequency shall not be greater than 0.4 seconds within a 20 second period; if the 20 dB bandwidth of the hopping channel is 250 kHz or greater, the system shall use at least 25 hopping frequencies and the average time of occupancy on any frequency shall not be greater than 0.4 seconds within a 10 second period. The maximum allowed 20 dB bandwidth of the hopping channel is 500 kHz.

9.4 Test Results

The EUT cycles through its pseudo-random generated list of hopping frequencies. There are 64 channels occupied in total. The average transmit time is 4.5 ms per channel and each channel is repeated approximately every 1s. Average time of occupancy = $20 \times 4.5 \text{ ms} = 90 \text{ ms}$. Results are depicted in Table 14.

Channel	Frequency (MHz)	Average Transmit Time/ Channel (ms)	Number of Hops in 20s	Average Time of Occupancy (ms)	Limit (ms)	Results
Middle Channel: #34	915	4.5	20	90	≤400	Pass

Table 14 – Time Occupancy Results



9.5 Graphs

The graphs shown below shows the Time of Occupancy during the operation of the device. This is measured by a max hold on the spectrum analyser and the highest resolution bandwidth that is sufficiently low to exhibit the Time of Occupancy of the signal being measured. This measurement is a peak measurement.

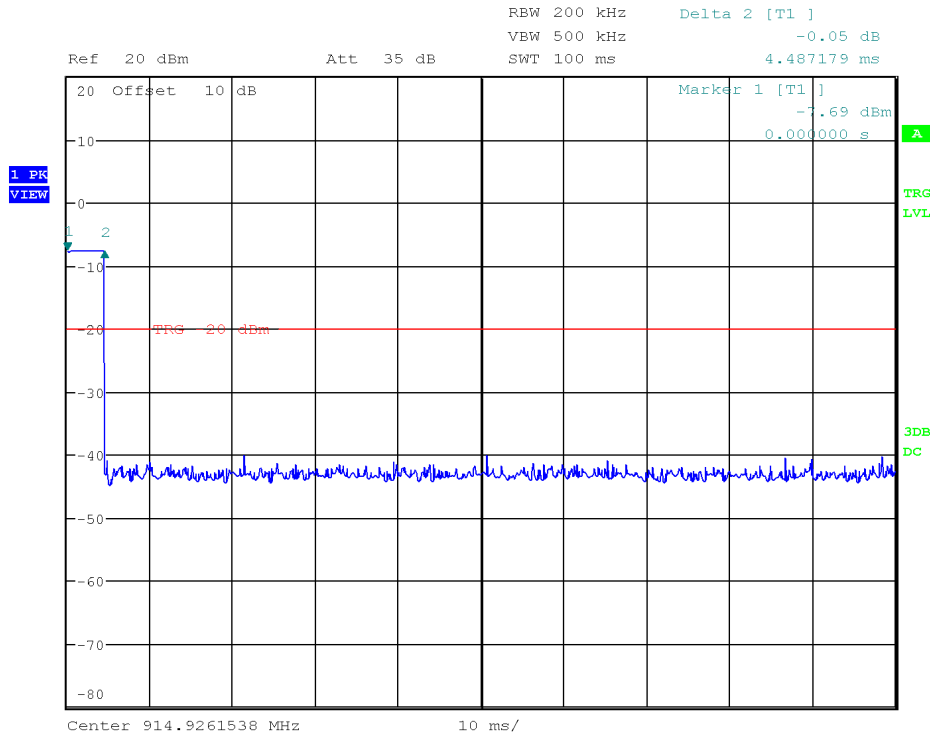

Date: 8.APR.2019 05:02:35

Graph 8: Time of Occupancy – ZX Door Switch



9.6 Test Instruments

This test was carried out in Laval test location. Instrumentation used is depicted in Table 15.

Equipment	Model No.	Manufacturer	Calibration Period (months)	Calibration Due (YYY-MM-DD)	Asset No: LAVE
Spectrum Analyzer	ESU-40	Rohde & Schwarz	24	2019-04-20	4092
Attenuator 10 dB	4779-10	Narda	NCR	NCR	4096

Table 15: Time of Occupancy Test Equipment



10 Maximum Peak Envelope Conducted Power – Digital Modulated

10.1 Purpose & Methods

The purpose of this test is to ensure that the maximum power conducted to the radiating element does not exceed the limits specified. The test method is defined in ANSI C63.10.

10.2 Test Specifications

REFERENCE STANDARD	FCC Part 15.247(b)(3) FCC Part 15.247(b)(2) RSS-247.5.4(d) ANSI C63.10. Clause 11.9.1
SPECIFICATIONS	
Limit – Power (W)	<1
Frequencies (MHz)	902.46 915 927.52
RBW (MHz):	0.2
VBW (MHz)	0.5
Span (MHz)	1.5
EUT	
Identification	ZX DOOR SWITCH
Voltage Input	5Vdc
Test Date (YYYY-MM-DD)	2019-04-08
Temperature (°C)	23.4 ± 2
Humidity (%)	36.3± 5
Atmospheric Pressure kPa (For Info Only)	109.7
Tester	Abderrahmane Ferhat
Client Witness	No Witness



10.3 Limits

The limits are defined in 15.247(b)(2) and 15.247(b)(3). For frequency hopping systems operating in the 902-928 MHz band: 1 watt for systems employing at least 50 hopping channels; and, 0.25 watts for systems employing less than 50 hopping channels, but at least 25 hopping channels, as permitted under paragraph (a)(1)(i) of this section.

For systems using digital modulation in the 902-928 MHz, 2400-2483.5 MHz, and 5725-5850 MHz bands: 1 Watt.

10.4 Tests Results

ZX Door Switch

The High Channel gave a maximum Peak Power of 10.29 dBm (11mW). The peak power measurements of channels tested are depicted in Table 16.

Channel	Frequency (MHz)	Measured Peak Power (dBm)	Peak Power (mW)	Limit (mW)	Result
Low	902.44	9.43	9	1000	Pass
Middle	914.98	9.78	10	1000	Pass
High	927.52	10.29	11	1000	Pass

Table 16 – Test Results Peak-Power Measurements ZX Door Switch

10.5 Graphs

The plots shown below show the Peak Power Output of the device during the antenna conducted measurements during transmit operation of the EUT. Note that no attenuator was used between the EUT and the Spectrum Analyzer.



ZX Door Switch Sensor

ZX Door Switch

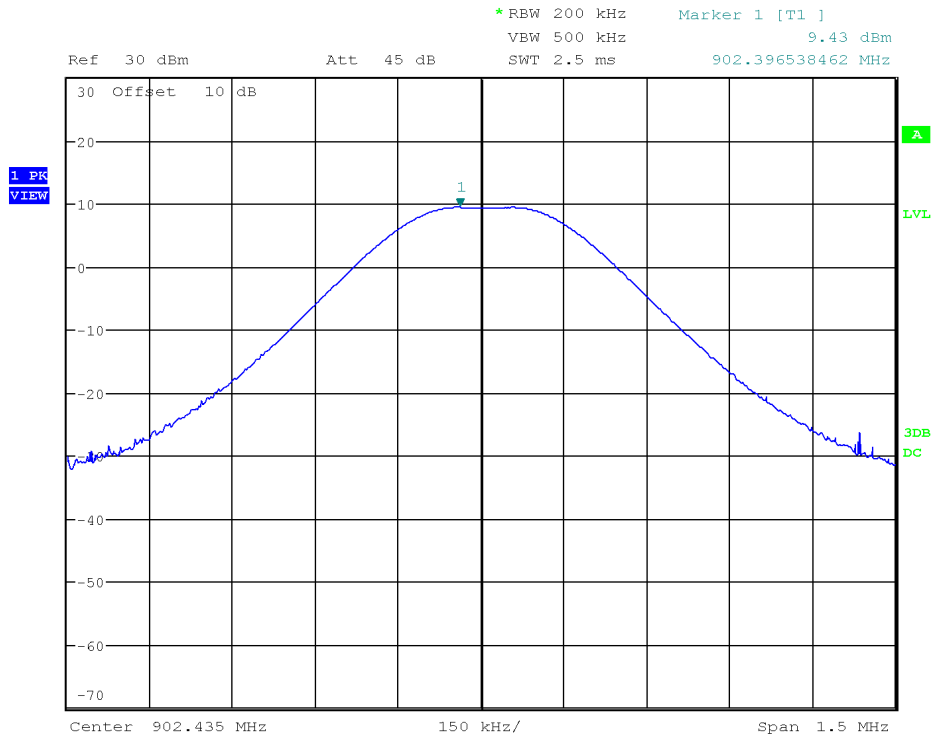

Date: 8.APR.2019 04:17:03

Graph 9 Test Results – Conducted Peak Power Measurements – Low Channel



ZX Door Switch Sensor

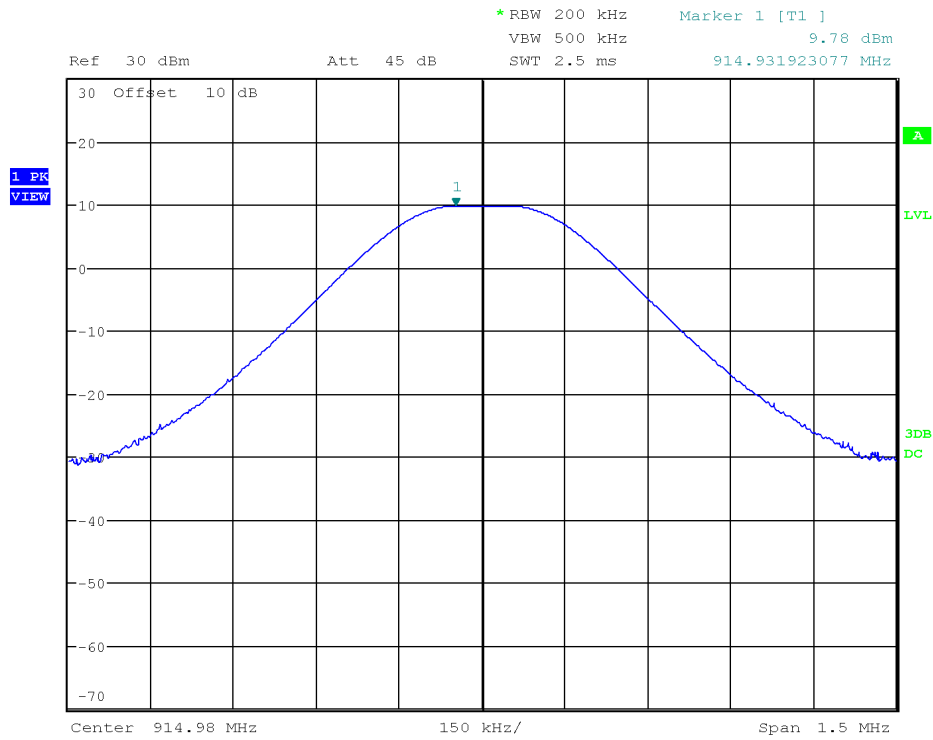

Date: 8.APR.2019 04:19:29

Graph 10 Test Results – Conducted Peak Power Measurements – Mid Channel



ZX Door Switch Sensor

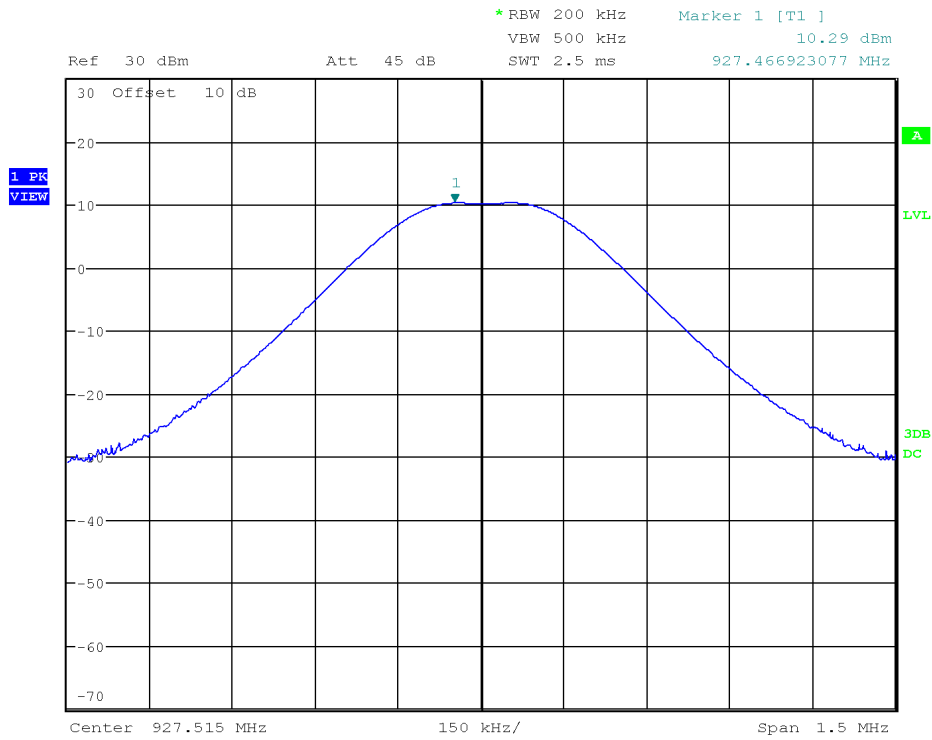

Date: 8.APR.2019 03:52:32

Graph 11 Test Results – Conducted Peak Power Measurements – High Channel

COMMERCIAL-IN-CONFIDENCE

No part of this document may be reproduced without the prior written approval of TÜV SÜD Canada. © TÜV SÜD.



10.6 Test Instruments

This test was carried out in Laval test location. Instrumentation used is depicted in Table 17.

Equipment	Model No.	Manufacturer	Calibration Period (months)	Calibration Due (YYY-MM-DD)	Asset No: LAVE
Spectrum Analyzer	ESU-40	Rohde & Schwarz	24	2019-04-20	4092
Attenuator 10 dB	4779-10	Narda	NCR	NCR	4096

Table 17: Conducted Peak Power Test Equipment



11 Band Edge Spurious Emission (-20 dBc Requirement)

11.1 Purpose & Methods

The Purpose of this test is to ensure that the maximum power conducted to the radiating element at frequencies outside of the authorized spectrum does not exceed the limits specified. This ensures that the only the intended signal is delivered to the radiating element. The method applied is described in ANSI C63.10-2013 in Clause 11.11.1.

11.2 Test Specifications

REFERENCE STANDARD	FCC Part 15.247(d) RSS-247 5.5 ANSI C63.10 Clause 11.11.1
SPECIFICATIONS	
Limit (dBc)	<20
Frequencies (MHz)	902.46 915 927.52
EUT	
Identification	ZX DOOR SWITCH
Voltage Input	5Vdc
ENVIROMENTAL & TEST INFO	
Test Date (YYYY-MM-DD)	2019-04-08
Temperature (°C)	23.4 ± 2
Humidity (%)	36.3 ± 5
Atmospheric Pressure kPa (For Info Only)	109.7
Tester	Abderrahmane Ferhat
Client Witness	No Witness



11.3 Limits

The limits are defined in 15.247(d). In any 100 kHz band, the peak spurious harmonics emissions must be at least 20 dB below the fundamental. Band Edge is to be evaluated up to the 10th harmonic. This -20 dBc requirement also applies at the 'band edge' of 2.4 GHz and 2.4835 GHz.

11.4 Test Setup

The Setup for the Maximum Peak Power testing is identical to the 99% Bandwidth setup.

11.5 Test Results

ZX DOOR SWITCH (900MHz)

The EUT was tested on: Low, medium, and high bands. The worst-case value is -34.65 dBm on Middle channel. The peak power of channels tested are depicted in Table 18.

Frequency Band (MHz)	Channel	Frequency (MHz)	Measured Spurious Conducted (dBm)	Results <Note 1>
902 – 907.6	Low	0.009-0.15	-69.54	Pass
	Low	0.15-30	-67.39	Pass
	Low	30-1000	-60.0	Pass
	Low	900-902.46	-43.74	Pass
	Middle	902 - 928	-34.65	Pass
	High	1000 - 10000	-63.55	Pass

Note 1. The highest level of the fundamental is 10.73dBm based on RF output Power results (see [Table 16](#))

Table 18- Results – ZX Door Switch – Band Edge



11.6 Graphs

The graphs shown below show the worst-case peak power output of the device during the antenna conducted measurement during transmit operation of the EUT. No attenuator was used between the EUT and the Spectrum Analyzer.

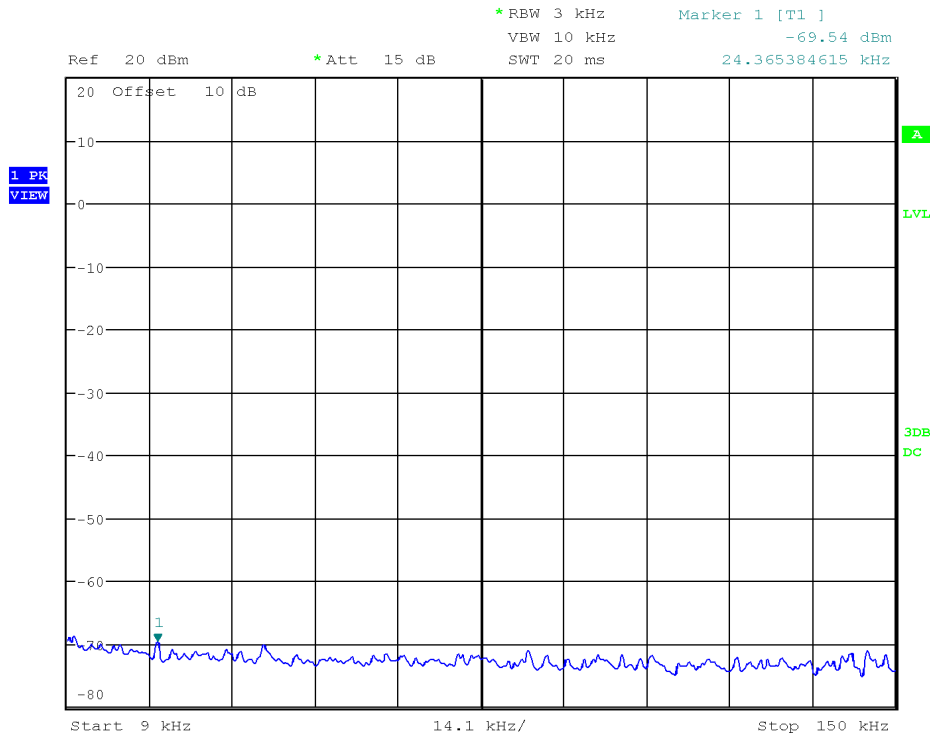

Date: 8.APR.2019 04:03:31

Graph 12 Test Results – Band Edge – 9kHz to 150kHz – Low Channel



Product Service

ZX Door Switch Sensor

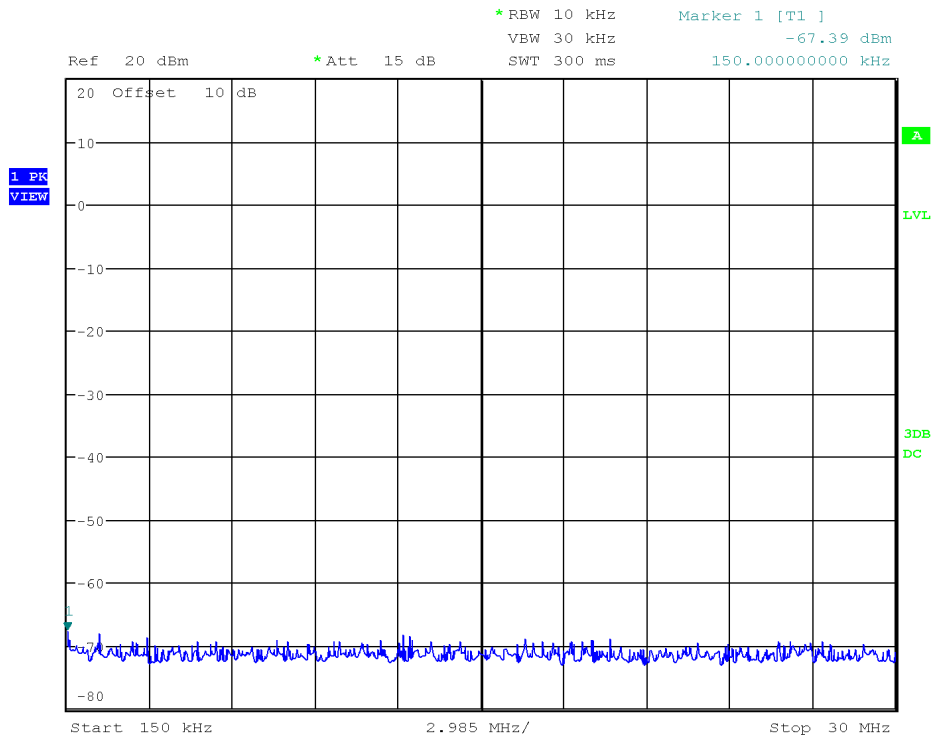

Date: 8.APR.2019 04:04:53

Graph 13 Test Results – Band Edge –150kHz to 30MHz – Low Channel

COMMERCIAL-IN-CONFIDENCE

No part of this document may be reproduced without the prior written approval of TÜV SÜD Canada. © TÜV SÜD.



Product Service

ZX Door Switch Sensor

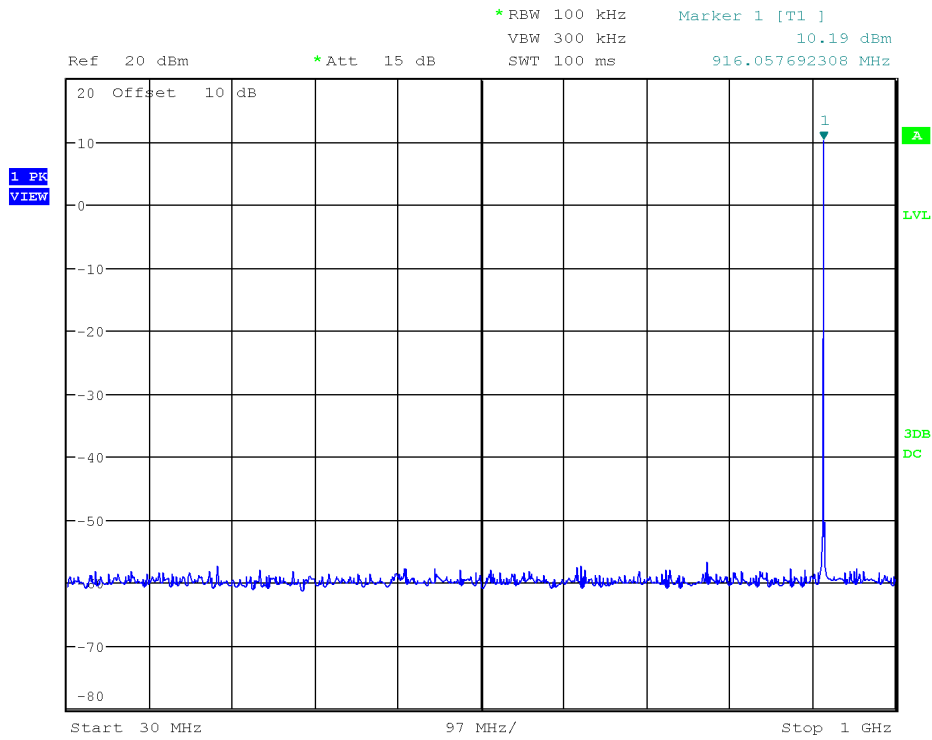

Date: 8.APR.2019 04:24:52

Graph 14 Test Results – Low Band Edge –30MHz to 1GHz – Low Channel

COMMERCIAL-IN-CONFIDENCE

No part of this document may be reproduced without the prior written approval of TÜV SÜD Canada. © TÜV SÜD.



Product Service

ZX Door Switch Sensor

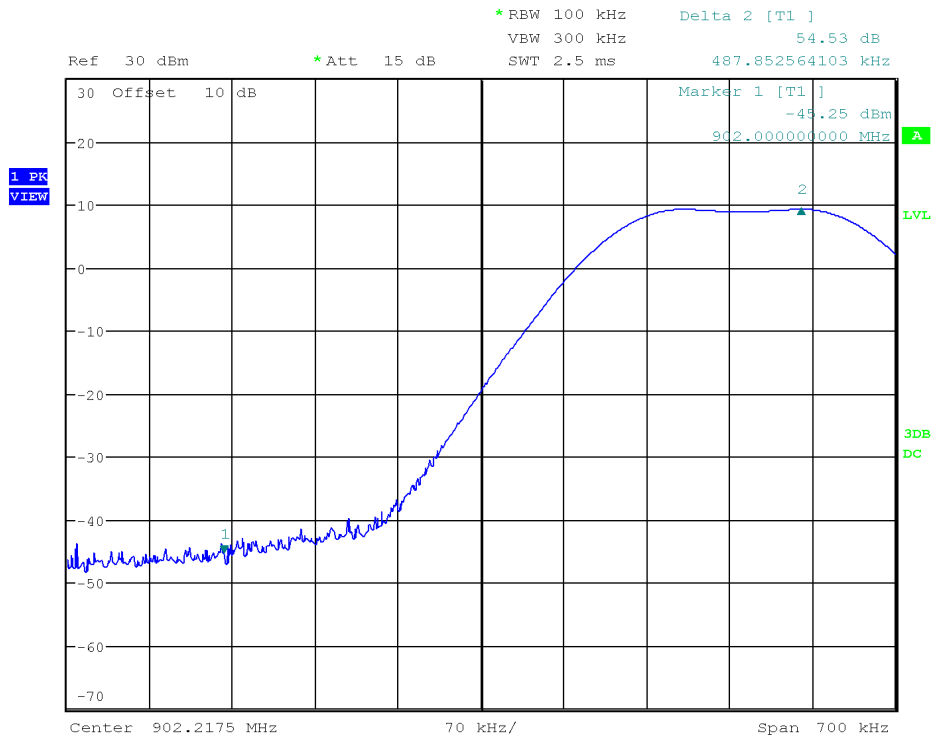

Date: 8.APR.2019 04:11:13

Graph 15 Test Results – Low Band Edge – 902.22 MHz– Mid Channel

COMMERCIAL-IN-CONFIDENCE

No part of this document may be reproduced without the prior written approval of TÜV SÜD Canada. © TÜV SÜD.



Product Service

ZX Door Switch Sensor

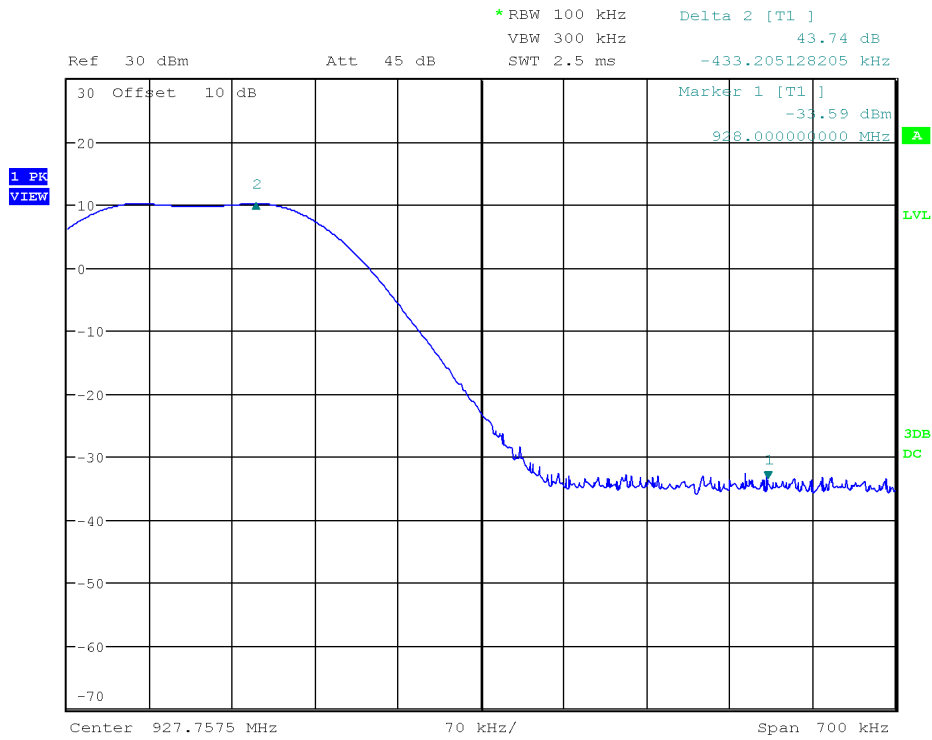

Date: 8.APR.2019 03:58:00

Graph 16 Test Results – Band Edge – 927.73MHz to 928.43MHz– Mid Channel

COMMERCIAL-IN-CONFIDENCE

No part of this document may be reproduced without the prior written approval of TÜV SÜD Canada. © TÜV SÜD.



Product Service

ZX Door Switch Sensor

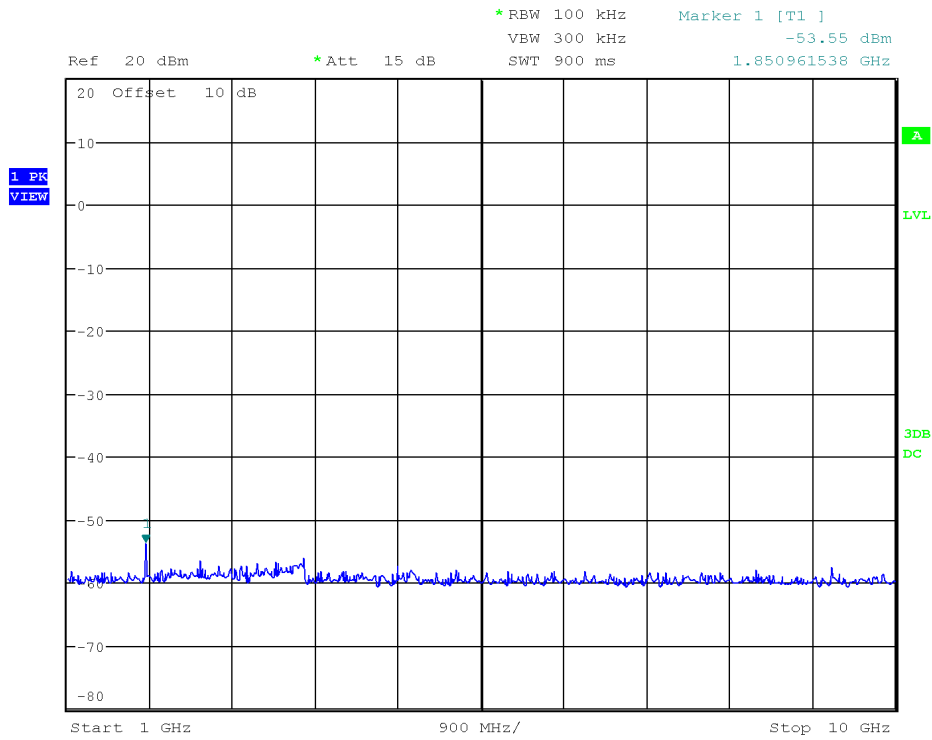

Date: 8.APR.2019 04:00:37

Graph 17 Test Results – Band Edge –1GHz to 10 GHz – High Channel

COMMERCIAL-IN-CONFIDENCE

No part of this document may be reproduced without the prior written approval of TÜV SÜD Canada. © TÜV SÜD.



11.7 Test Instruments

This test was carried out in Laval test location. Instrumentation used is depicted in Table 19.

Equipment	Model No.	Manufacturer	Calibration Period (months)	Calibration Due (YYY-MM-DD)	Asset No: LAVE
Spectrum Analyzer	ESU-40	Rohde & Schwarz	24	2019-04-20	4092
Attenuator 10 dB	4779-10	Narda	NCR	NCR	4096

Table 19 – Test Instrumentation – Band Edge



12 Tx Spurious Radiated Emissions

12.1 Purpose & Methods

The Purpose of this test is to ensure that the RF energy unintentionally emitted from the EUT does not exceed the limits listed below as defined in the applicable test standard, as measured from a receiving antenna. This helps protect broadcast radio services such as television, FM radio, pagers, cellular telephones, emergency services, and so on, from unwanted interference. The method is as defined in Section 12.1 of FCC KDB 558074 and ANSI C63.10.

All unintentional emissions must also meet the 'Spurious Conducted Emissions' requirements of -20 dBc or greater. See also '[Band Edge](#)' for further details. Limits are depicted in Table 20.

Frequency	Limit
0.009 MHz – 0.490 MHz	2400/F(kHz) uV/m at 300m ⁽¹⁾
0.490 MHz – 1.705 MHz	24000/F(kHz) uV/m at 30m ⁽¹⁾
1.705 MHz – 30 MHz	30 uV/m at 30m ⁽¹⁾
30 MHz – 88 MHz	100 uV/m (40.0 dBuV/m) at 3m ⁽¹⁾
88 MHz – 216 MHz	150 uV/m (43.5 dBuV/m) at 3m ⁽¹⁾
216 MHz – 960 MHz	200 uV/m (46.0 dBuV/m) at 3m ⁽¹⁾
Above 960 MHz	500 uV/m (54.0 dBuV/m) at 3m ⁽¹⁾
Above 1000 MHz	500 uV/m (54 dBuV/m) at 3m ⁽²⁾
Above 1000 MHz	500 uV/m (74 dBuV/m) at 3m ⁽³⁾
¹ Limit is with Quasi Peak detector with bandwidths as defined in CISPR-16-1-1	
² Limit is with 1 MHz measurement bandwidth and using an Average detector	
³ Limit is with 1 MHz measurement bandwidth and using a Peak detector	

Table 20 Limits – Tx Spurious

Based on ANSI C63.4 Section 4.2, if the Peak detector measurements do not exceed the Quasi-Peak limits, where defined, then the EUT is deemed to have passed the requirements.



12.2 Test Specifications

REFERENCE STANDARD	FCC Part 15.209(a) RSS-247 5.5 ANSI C63.10 Clause 5.5			
SPECIFICATIONS				
Limit (dBμV/m)	Table 20			
Frequencies (MHz)	902.46 915 927.52			
EUT				
Identification	ZX Door Switch			
Voltage Input	5Vdc			
ENVIROMENTAL & TEST INFO				
Test Date (YYYY-MM-DD)	2019-02-26	2019-03-19	2019-04-05	2019-04-08
Temperature (°C)	243 \pm 2	21.3 \pm 2	22 \pm 2	21 \pm 2
Humidity (%)	14 \pm 5	17 \pm 5	21 \pm 5	19 \pm 5
Atmospheric Pressure kPa (For Info Only)	101.6	102.6	102	100.2
Tester	Abderrahmane Ferhat			
Client Witness	No Witness			



12.3 Limits

The limits, as defined in 15.247(d) for intentional radiated emissions, apply for those emissions that fall in the restricted bands, as defined in Section 15.205(a). These emissions must comply with the radiated emission limits specified in Section 15.209(a).

12.4 Results

The EUT passed. Low, medium, and high bands were tested. The worst-case are only presented and final measurements are given in [Appendix A](#).

Channel	Frequency Range (MHz)	Frequency (MHz)	Polarization	Detector	Limit	Margin	Results <Note 2>	
Low	0.009 – 0.015	-	-	-	See Table 20	<Note 1>	Pass	
	0.015 – 30						Pass	
	30 – 1000						Pass	
	>1000						Pass	
Mid	0.009 – 0.015	-	-	-			<Note 1>	Pass
	0.015 – 30							Pass
	30 – 1000	933.40	Vertical	Peak			6.4	Pass
	>1000	1830.26	Vertical	Average			0.7	Pass
High	0.009 – 0.015	-	-	-			<Note 1>	Pass
	0.015 – 30							Pass
	30 – 1000							Pass
	>1000							Pass

Note 1: No significant emission, i.e., 10dB below the limit was measured.
 Note 2: For Worst cases based on Peak measurements can be found in [Appendix A](#): Table A1 to Table A2.

Table 21 – Test Results for Tx Spurious Emission – Lowest Margin – Peak Measurements



12.5 Graphs

The graphs shown below are maximized peak measurement graphs measured with a resolution bandwidth greater than or equal to the final required detector over a full 0-360°. This peaking process is done as a worst-case measurement and enables the detection of frequencies of concern for final measurement. For final measurements with the appropriate detector, where applicable, please refer to the tables under Final Measurements.

Devices scanned may be scanned at alternate test distances and in accordance with FCC Part 15, Subpart A, Section 15.31, an extrapolation factor of 20 dB/decade was used above 30 MHz and 40 dB/decade below 30 MHz for example, for 1-meter measurements, an extrapolation factor 9.5 dB from 20 Log (1m / 3m) is applied.

Low, middle and high channels. However, the worst-case graphs are presented.



ZX Door Switch Sensor

Frequency range from 9kHz to 150kHz

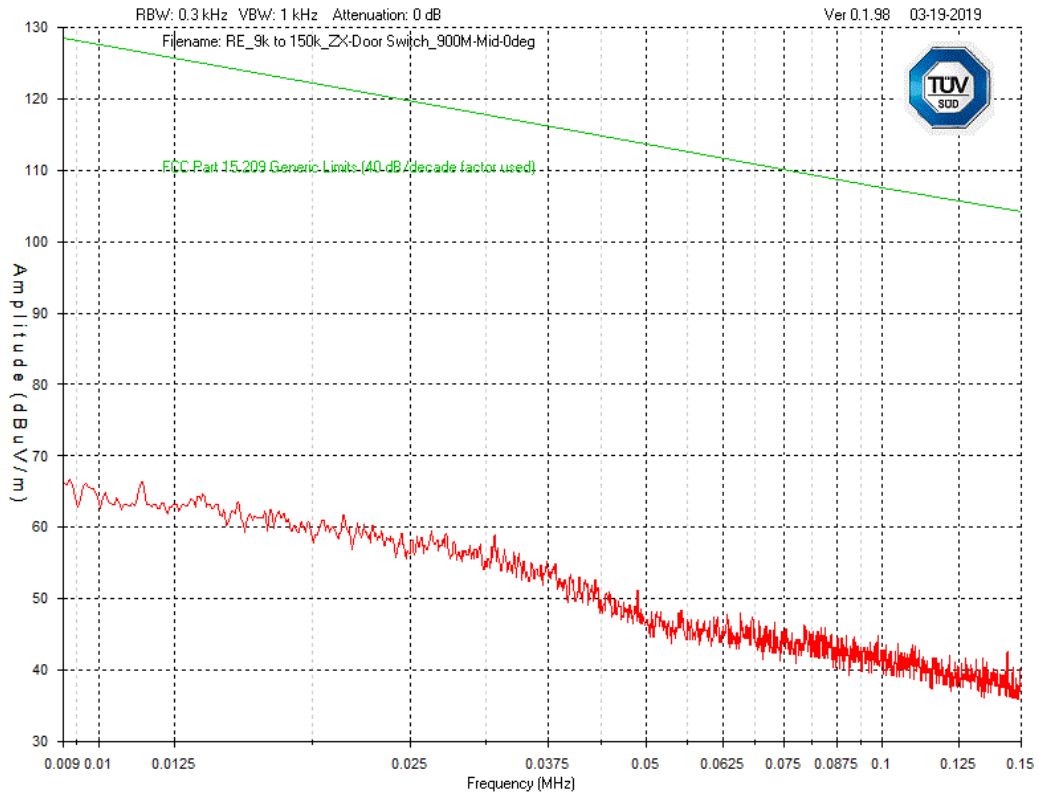

Graph 18 Test Results – Tx Spurious 9kHz to 150kHz – Mid Channel



Frequency Range from 30MHz to 1GHz – Worst case – Mid Channel

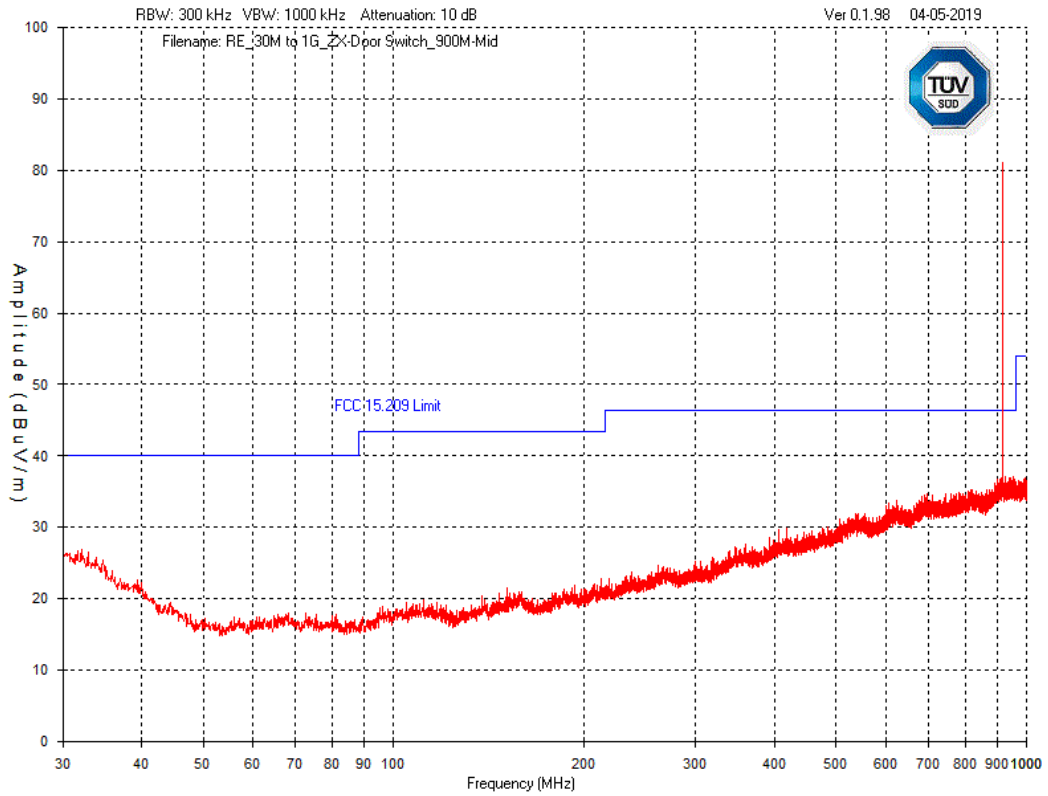

Graph 19 Test Results – Tx Spurious Emission 30MHz to 1GHz – Mid Channel – Vertical Polarization



ZX Door Switch Sensor

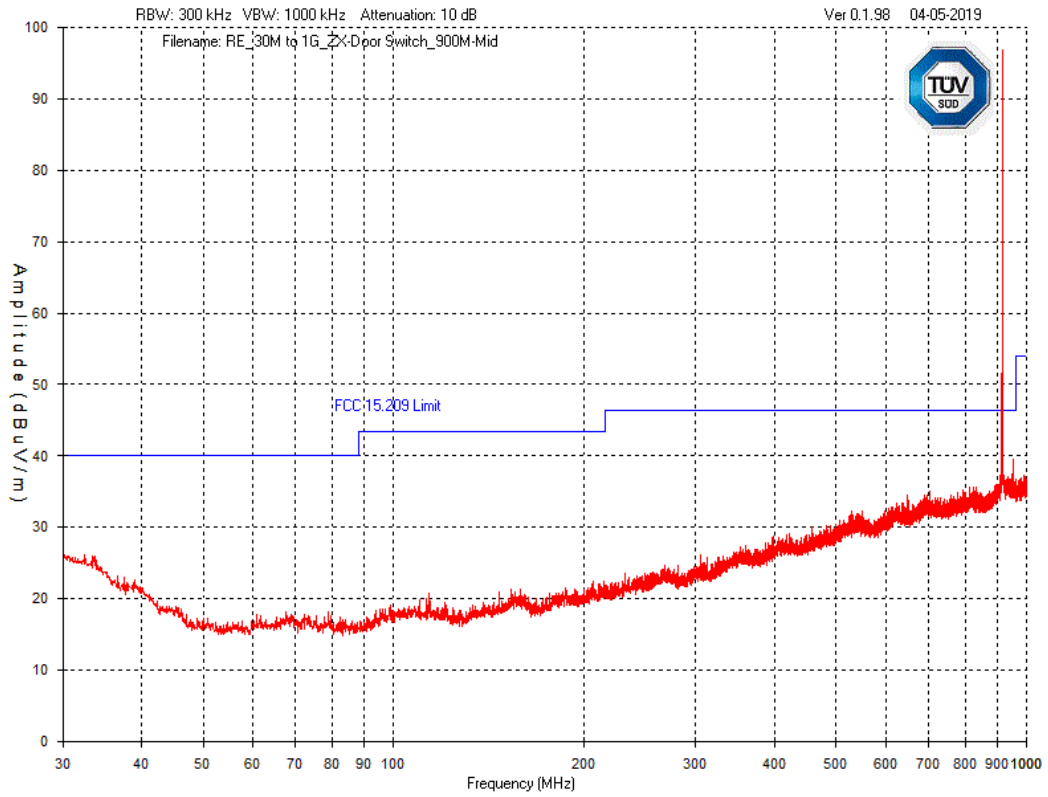

Graph 20 Test Results – Tx Spurious emission 30MHz to 1GHz – Mid Channel – Horizontal Polarization

Note. From the above Graph, the peak measurement of the emission is recorded at 915MHz and corresponds to 96 dB μ V/m.



Frequency Range from 1GHz to 3GHz – Worst case – Mid Channel

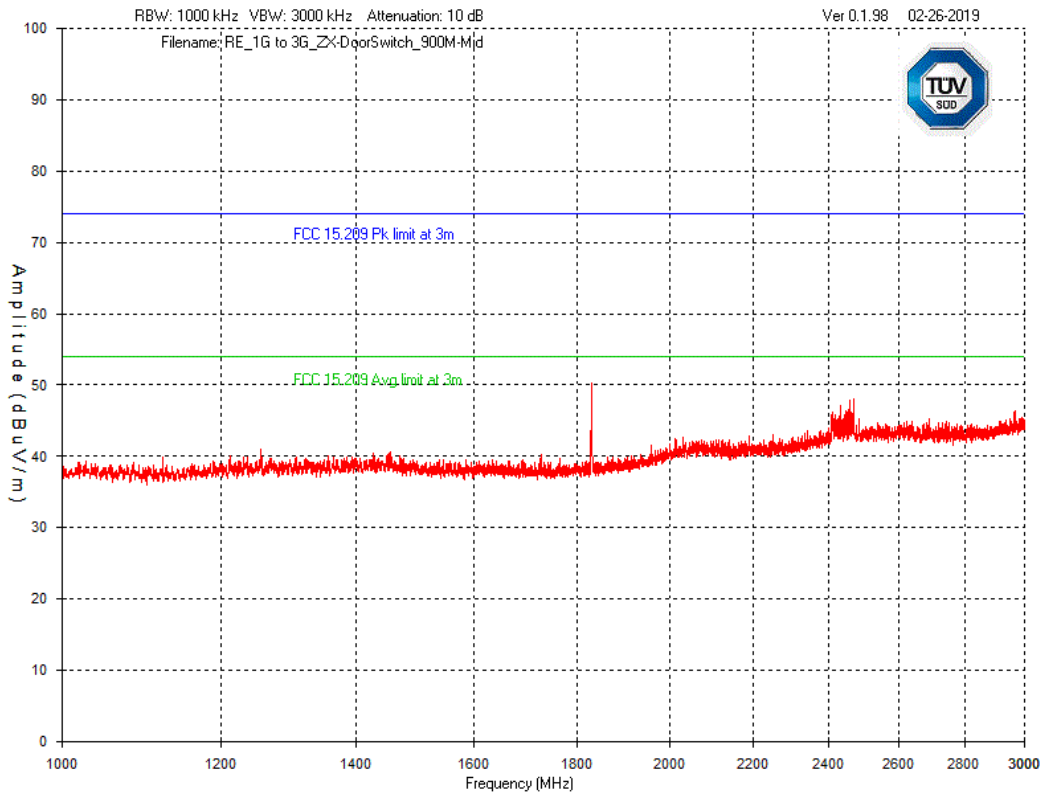

Graph 21 Test Results – Tx Spurious emission 1GHz to 3GHz – Mid Channel – Vertical Polarization



ZX Door Switch Sensor

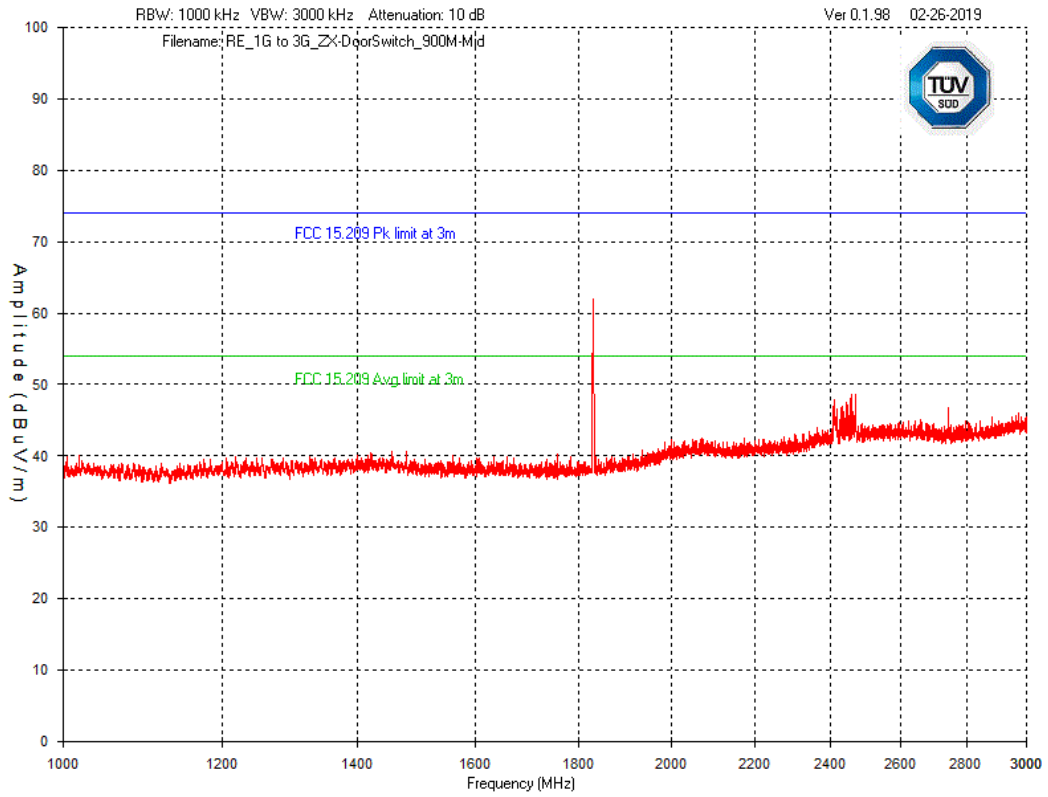

Graph 22 Test Results – Tx Spurious emission 1GHz – 3GHz – Mid Channel – Horizontal Polarization



Frequency Range from 3GHz – 10GHz – Worst case – Mid Channel

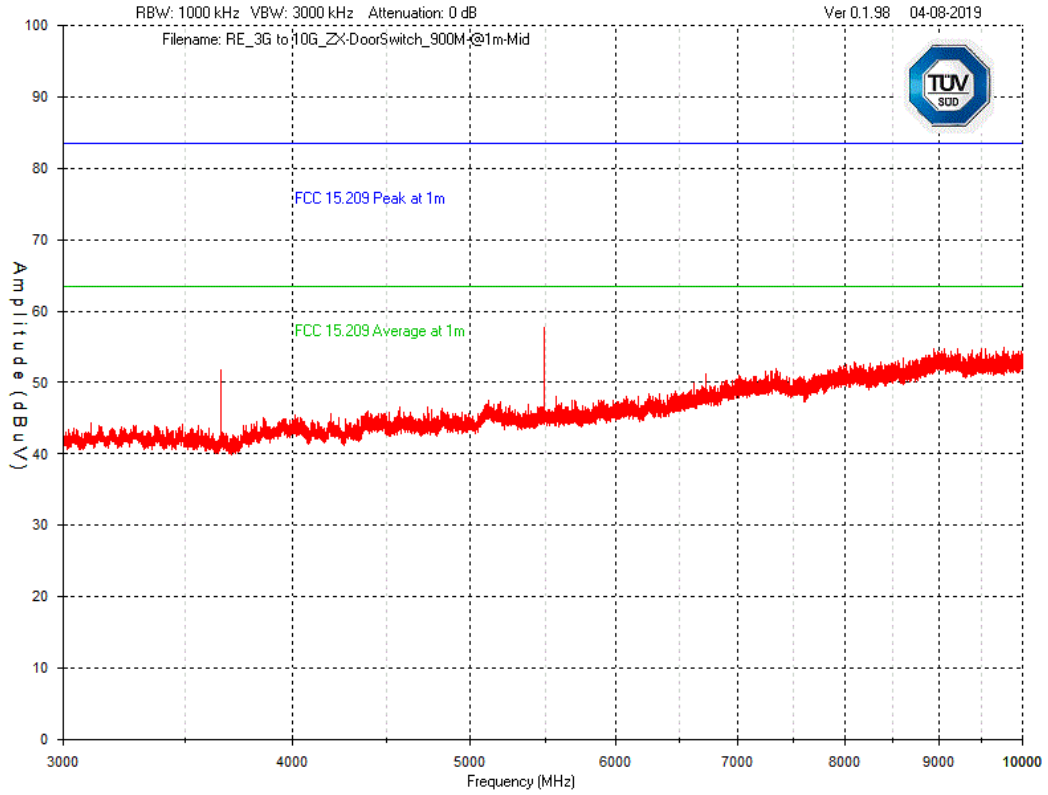

Graph 23 Test Results – Tx Spurious emission 3GHz – 10GHz – Mid Channel – Horizontal Polarization



ZX Door Switch Sensor

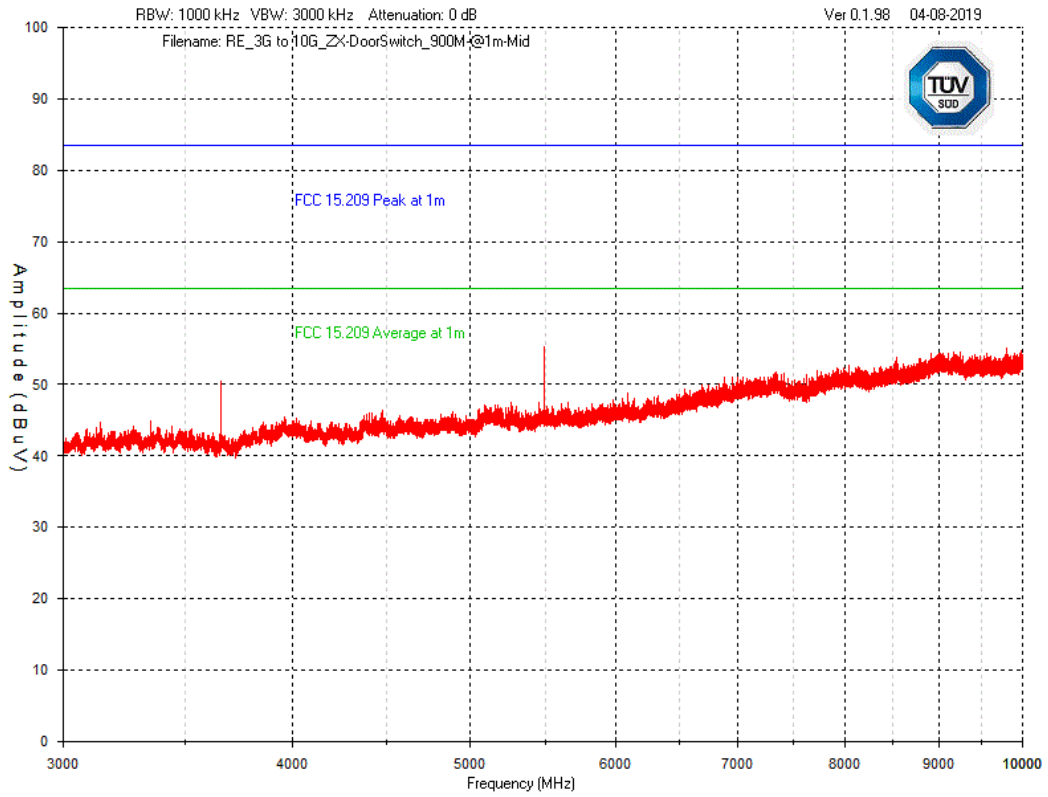

Graph 24 Test Results – Tx Spurious emission 3GHz – 10GHz – Mid Channel – Vertical polarisation



12.6 Test Instruments

This test was carried out in Laval test location. Instrumentation used is depicted in Table 22.

Equipment	Model No.	Manufacturer	Calibration Period (months)	Calibration Due (YYY-MM-DD)	Asset No LAV0
Spectrum Analyzer	ESU-40	Rohde & Schwarz	24	2019-04-20	4092
BiLog Antenna	3142-E	ETS	24	2020-11-29	4002
Horn Antenna	ATH1G18G	AR	24	2019-04-25	4003
Biconical Antenna	EM-6913	Electro-Metrics	24	2019-05-02	4060
Log Periodic Antenna	LPA-25	Electro-Metrics	24	2019-04-20	4087
Loop Antenna	EM 6879	Electro-Metrics	24	2019-04-19	4040
Attenuator 3 dB	FP-50-3	Trilithic	NCR	NCR	4028
LNA pre-amp	LNA-1450	RF Bay Inc.	24	2019-07-22	4089
1-26.5GHz preamp	8449B	Agilent	24	2019-09-09	4006
RF Cable 10m	LMR-400-10M-50OHM-MN-MN	LexTec	NCR	NCR	4025
RF Cable 7m	LMR-400-7M-50OHM-MN-MN	LexTec	NCR	NCR	4026
Emission software	0.1.97	Global EMC	NCR	NCR	58

Table 22 – Test Instrumentation – Tx Spurious Emission



APPENDIX A: Tx Spurious Emissions – Worst Cases



ZX WIRED THERMOSTAT

Product Service

Frequency (MHz)	Detector	Raw Reading	Antenna Factor (dB/m)	Atten Factor (dB)	Cable Factor (dB)	Pre-Amp (dB)	Level dBµV/m	FCC 15.209 Ave. Limit	FCC 15.209 Limit Margin
927.468	PEAK	94.3	28.2	4	2.3	-32.2	96.6	46.4	-50.2 <Note 1>
933.391	PEAK	37.7	28.2	4	2.3	-32.2	40	46.4	6.4
816.195	PEAK	35.5	27.1	4	2.1	-32.8	35.9	46.4	10.5
30.0971	PEAK	33.2	21.3	4	0.5	-32.4	26.6	40	13.4
30	PEAK	32.8	21.4	4	0.5	-32.4	26.3	40	13.7
277.792	PEAK	36.1	17.5	4	1.3	-33.3	25.6	46.4	20.8

Note 1. Emitter frequency excluded from the limit.

Table A.1 Tx Spurious Emission Mid Channel – 30MHz – 1GHz – Horizontal Polarization- Peak Measurements

Frequency (MHz)	Detector	Raw Reading	Antenna Factor (dB/m)	Atten Factor (dB)	Cable Factor (dB)	Pre-Amp (dB)	Level dBµV/m	FCC 15.209 Ave. Limit	FCC 15.209 Limit Margin
927.468	PEAK	81.1	28.2	4	2.3	-32.2	83.4	46.4	-37 <Note 1>
825.517	PEAK	35.3	27	4	2.2	-32.8	35.7	46.4	10.7
762.792	PEAK	36	26.2	4	2.1	-33	35.3	46.4	11.1
30.1942	PEAK	33.8	21.3	4	0.5	-32.4	27.2	40	12.8
30	PEAK	33.4	21.4	4	0.5	-32.4	26.9	40	13.1
539.76	PEAK	34.9	24.5	4	1.7	-33.2	31.9	46.4	14.5

Note 1. Emitter frequency excluded from the limit.

Table A.2 Tx Spurious Emission Mid Channel – 30MHz – 1GHz – Vertical Polarization- Peak Measurements



Product Service

ZX WIRED THERMOSTAT

Frequency (MHz)	Detector	Raw Reading	Antenna Factor (dB/m)	Atten Factor (dB)	Cable Factor (dB)	Pre-Amp (dB)	Level	FCC 15.209 Ave. Limit	FCC 15.209 Limit Margin	FCC 15.209 Avg limit at 3m Margin
1830.26	AVG	58	24.9	3.3	0.2	-33.1	53.3	54	74	0.7
2456.31	PEAK	48.9	28.3	4.1	0.3	-33.1	48.5	54	74	5.5
2469.18	PEAK	48.7	28.4	4.2	0.3	-33.1	48.5	54	74	5.5
2408.27	PEAK	48.4	28.2	4.1	0.3	-33.1	47.9	54	74	6.1
2444.02	PEAK	47.9	28.3	4.1	0.3	-33.1	47.5	54	74	6.5
1000	PEAK	43.5	23.5	2.4	3.1	-34.4	38.1	54	74	15.9

Table A.3 Tx Spurious Emission Mid Channel – 1GHz – 3GHz – Horizontal Polarization- Peak Measurement

Frequency (MHz)	Detector	Raw Reading	Antenna Factor (dB/m)	Atten Factor (dB)	Cable Factor (dB)	Pre-Amp (dB)	Level	FCC 15.209 Ave. Limit	FCC 15.209 Limit Margin	FCC 15.209 Avg limit at 3m Margin
1830.26	AVG	52.8	24.9	3.3	0.2	-33.1	48.1	54	74	5.9
1830.26	PEAK	55	24.9	3.3	0.2	-33.1	50.3	54	74	3.7
2467.75	PEAK	48.3	28.4	4.2	0.3	-33.1	48.1	54	74	5.9
2457.17	PEAK	48.2	28.3	4.1	0.3	-33.1	47.8	54	74	6.2
2432	PEAK	47.5	28.2	4.1	0.3	-33.1	47	54	74	7
1685.83	PEAK	43.1	24.7	3.2	0.2	-33.2	38	54	74	16
1000	PEAK	42.8	23.5	2.4	3.1	-34.4	37.4	54	74	16.6

Table A.4 Tx Spurious Emission Mid Channel – 1GHz – 3GHz – Vertical Polarization- Peak Measurement