



---

# FCC Test Report

---

Report No.: AGC00019140402FE08

**FCC ID** : XELBH-501

**APPLICATION PURPOSE** : Original Equipment

**PRODUCT DESIGNATION** : Bluetooth Stereo Headset

**BRAND NAME** : ORiCORE

**MODEL NAME** : BH-501

**CLIENT** : SHENZHEN HONG NAN KE COMMUNICATION  
EQUIPMENT CO., LTD

**DATE OF ISSUE** : Apr.24, 2014

**STANDARD(S)** : FCC Part 15 Rules

**REPORT VERSION** : V1.0

Attestation of Global Compliance (Shenzhen) Co., Ltd



**CAUTION:**

This report shall not be reproduced except in full without the written permission of the test laboratory and shall not be quoted out of context.

### Report Revise Record

Report Version	Revise Time	Issued Date	Valid Version	Notes
V1.0	/	Apr.24, 2014	Valid	Original Report

## TABLE OF CONTENTS

<b>1. VERIFICATION OF COMPLIANCE</b> .....	<b>5</b>
<b>2. GENERAL INFORMATION</b> .....	<b>6</b>
2.1 PRODUCT DESCRIPTION .....	6
2.2 RELATED SUBMITTAL(S)/GRANT(S).....	6
2.3 TEST METHODOLOGY .....	6
2.4 TEST FACILITY.....	6
2.5 SPECIAL ACCESSORIES.....	6
2.6 EQUIPMENT MODIFICATIONS.....	7
2.7 MEASUREMENT UNCERTAINTY .....	7
<b>3. SYSTEM TEST CONFIGURATION</b> .....	<b>8</b>
3.1 CONFIGURATION OF TESTED SYSTEM .....	8
3.2 EQUIPMENT USED IN TESTED SYSTEM .....	8
<b>4. SUMMARY OF TEST RESULTS</b> .....	<b>9</b>
<b>5. DESCRIPTION OF TEST MODES</b> .....	<b>9</b>
<b>6. ANTENNA REQUIREMENT</b> .....	<b>10</b>
6.1. STANDARD APPLICABLE .....	10
6.2. TEST RESULT .....	10
<b>7. RADIATED EMISSION</b> .....	<b>11</b>
7.1 MEASUREMENT PROCEDURE.....	11
7.2 TEST SETUP.....	12
7.3 TEST EQUIPMENT .....	13
7.4 LIMITS AND MEASUREMENT RESULT .....	13
7.5 TEST RESULT .....	13
<b>8. BAND EDGE EMISSION</b> .....	<b>26</b>
8.1. MEASUREMENT PROCEDURE.....	26
8.2. TEST SET-UP .....	26
8.3. TEST RESULT .....	27
<b>9. 6DB BANDWIDTH</b> .....	<b>31</b>
9.1. TEST EQUIPMENT LIST AND DETAILS.....	31
9.2. TEST PROCEDURE.....	31
9.3. SUMMARY OF TEST RESULTS/PLOTS .....	31
<b>10. CONDUCTED OUTPUT POWER</b> .....	<b>34</b>
10.1. MEASUREMENT PROCEDURE.....	34
10.2. TEST SET-UP (BLOCK DIAGRAM OF CONFIGURATION).....	34
10.3. LIMITS AND MEASUREMENT RESULT .....	35
<b>11. MAXIMUM CONDUCTED OUTPUT POWER SPECTRAL DENSITY</b> .....	<b>37</b>

11.1 MEASUREMENT PROCEDURE .....	37
11.2 TEST SET-UP (BLOCK DIAGRAM OF CONFIGURATION).....	37
11.3 MEASUREMENT EQUIPMENT USED.....	37
11.4 LIMITS AND MEASUREMENT RESULT .....	37
<b>12. FCC LINE CONDUCTED EMISSION TEST .....</b>	<b>40</b>
12.1 LIMITS.....	40
12.2 TEST SETUP.....	40
12.3 PRELIMINARY PROCEDURE .....	41
12.4 FINAL TEST PROCEDURE.....	41
12.5 TEST RESULT OF POWER LINE .....	42
<b>APPENDIX A: PHOTOGRAPHS OF TEST SETUP .....</b>	<b>43</b>
<b>APPENDIX B: PHOTOGRAPHS OF EUT .....</b>	<b>44</b>

**1. VERIFICATION OF COMPLIANCE**

<b>Applicant</b>	SHENZHEN HONG NAN KE COMMUNICATION EQUIPMENT CO., LTD
<b>Address</b>	No.16,2nd Industrial Area, Xiakeng Tongle District, Shen Zhen, Guang Dong, China
<b>Manufacturer</b>	SHENZHEN HONG NAN KE COMMUNICATION EQUIPMENT CO., LTD
<b>Address</b>	No.16,2nd Industrial Area, Xiakeng Tongle District, Shen Zhen, Guang Dong, China
<b>Product Designation</b>	Bluetooth Stereo Headset
<b>Brand Name</b>	ORICORE
<b>Test Model</b>	BH-501 (There are two different samples of BH-501,the only difference is charging interface)
<b>Date of test</b>	Apr.21, 2014 to Apr.23, 2014
<b>Deviation</b>	None
<b>Condition of Test Sample</b>	Normal
<b>Report Template</b>	AGCRT-US-BLE/RF (2013-03-01)

**WE HEREBY CERTIFY THAT:**

The above equipment was tested by Attestation of Global Compliance (Shenzhen) Co., Ltd. The test data, data evaluation, test procedures, and equipment configurations shown in this report were made in accordance with the procedures given in ANSI C63.4 (2003) and the energy emitted by the sample EUT tested as described in this report is in compliance with requirement of FCC Part 15 Rules requirement.

Prepared By

*Water Zuo*

Water Zuo                      Apr.24, 2014

Checked By

*Forrest Lei*

Forrest Lei                      Apr.24, 2014

Authorized By

*Solger Zhang*

Solger Zhang                      Apr.24, 2014

## 2.GENERAL INFORMATION

### 2.1PRODUCT DESCRIPTION

The EUT is designed as a “Bluetooth Stereo Headset”. It is designed by way of utilizing the FHSS technology to achieve the system operation.

A major technical description of EUT is described as following

<b>Operation Frequency</b>	2.402 GHz to 2.480GHz
<b>Bluetooth Version</b>	V4.0
<b>Modulation</b>	GFSK
<b>Number of channels</b>	40 Channel(37 Hopping Channel,3 advertising Channel)
<b>Antenna Designation</b>	PCB Antenna
<b>Antenna Gain</b>	0dBi
<b>Hardware Version</b>	The chip reports stack version 8648 (0x21c8): "dal_10compact_rom_bt4.0_dal_a04_1112061248_encr128 2011-12-06"
<b>Software Version</b>	N/A
<b>Power Supply</b>	DC3.7V by Built-in Li-ion Battery

Note: The USB Port can not be used for communication with PC. It's only for charging.  
The BT is not active when charging.

### 2.2 RELATED SUBMITTAL(S)/GRANT(S)

This submittal(s) (test report) is intended for **FCC ID: XELBH-501** filing to comply with Section 15.247of the FCC Part 15, Subpart C Rules.

### 2.3TEST METHODOLOGY

All measurements contained in this report were conducted with ANSI C63.4-2003, American National Standard for Methods of Measurement of Radio-Noise Emissions from Low-Voltage Electrical and Electronic Equipment in the range of 9 kHz to 40 GHz.

The equipment under test (EUT) was configured to measure its highest possible emission level. The test modes were adapted accordingly in reference to the Operating Instructions. The EUT was tested in all three orthogonal planes and the worse case was showed.

### 2.4 TEST FACILITY

All measurement facilities used to collect the measurement data are located at Attestation of Global Compliance (Shenzhen) Co, Ltd

2/F., Building 2, No.1-No.4, Chaxi Sanwei Technical Industrial Park, Gushu, Xixiang, Bao'an District, Shenzhen, Guangdong, China.

FCC register No.: 259865

### 2.5 SPECIAL ACCESSORIES

Refer to section 2.2.

## **2.6 EQUIPMENT MODIFICATIONS**

Not available for this EUT intended for grant.

## **2.7 MEASUREMENT UNCERTAINTY**

Radiation Emission: +/-3.2

Conduction Emission: +/-2.5

### 3. SYSTEM TEST CONFIGURATION

#### 3.1 CONFIGURATION OF TESTED SYSTEM

**Configuration:** Normal Operating

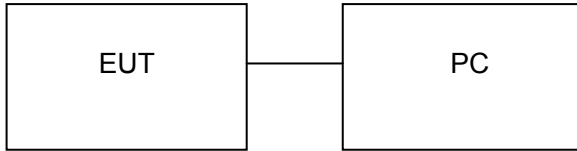

**Configuration:** Continuous TX

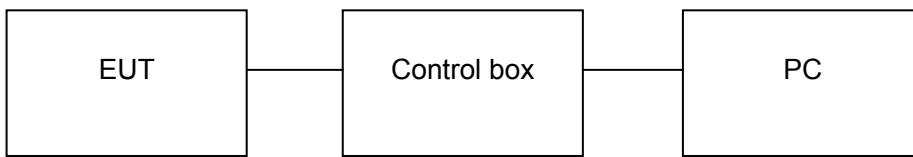

#### 3.2 EQUIPMENT USED IN TESTED SYSTEM

Item	Equipment	Mfr/Brand	Model/Type No.	Remark
1	Bluetooth Stereo Headset	ORiCORE	BH-501	EUT
2	Battery	N/A	N/A	Accessory
3	PC	Dell	INSPIRON	A.E
4	Control box	N/A	N/A	A.E



#### 4. SUMMARY OF TEST RESULTS

FCC RULES	DESCRIPTION OF TEST	RESULT
§ 15.203	Antenna Requirement	Compliant
§15.209 §15.247(d)	Radiated Emission	Compliant
§15.247(d)	Band Edges	Compliant
§15.247	6 dB Bandwidth	Compliant
§15.247(b)	Conducted Power	Compliant
§15.247(e)	Maximum Conducted Output Power SPECTRAL Density	Compliant
§15.207	Line Conduction Emission	N/A

Note: N/A means not applicable

#### 5. DESCRIPTION OF TEST MODES

The EUT has been operated in one modulation: GFSK .

NO.	TEST MODE DESCRIPTION
1	Low channel TX
2	Middle channel TX
3	High channel TX
4	Normal Operating (BT)

Note:

- All the test modes can be supply by Built-in Li-ion battery, only the result of the worst case was recorded in the report if no any records.
- For Radiated Emission, 3axis were chosen for testing for each applicable mode.

## **6. ANTENNA REQUIREMENT**

### **6.1. STANDARD APPLICABLE**

According to FCC 15.203, An intentional radiator shall be designed to ensure that no antenna other than that furnished by the responsible party shall be used with the device. The use of a permanently attached antenna or of an antenna that uses a unique coupling to the intentional radiator shall be considered sufficient to comply with the provisions of this Section. The manufacturer may design the unit so that a broken antenna can be replaced by the user, but the use of a standard antenna jack or electrical connector is prohibited. This requirement does not apply to carrier current devices or to devices operated under the provisions of Sections 15.211, 15.213, 15.217, 15.219, or 15.221. Further, this requirement does not apply to intentional radiators that must be professionally installed, such as perimeter protection systems and some field disturbance sensors, or to other intentional radiators which, in accordance with Section 15.31(d), must be measured at the installation site. However, the installer shall be responsible for ensuring that the proper antenna is employed so that the limits in this Part are not exceeded.

### **6.2. TEST RESULT**

This product has a permanent antenna, fulfill the requirement of this section.

## 7. RADIATED EMISSION

### 7.1 MEASUREMENT PROCEDURE

1. Configure the EUT according to ANSI C63.4. The EUT was placed on the top of the turntable 0.8 meter above ground. The phase center of the receiving antenna mounted on the top of a height-variable antenna tower was placed 3 meters far away from the turntable.
2. Power on the EUT and all the supporting units. The turntable was rotated by 360 degrees to determine the position of the highest radiation.
3. The height of the broadband receiving antenna was varied between one meter and four meters above ground to find the maximum emissions field strength of both horizontal and vertical polarization.
4. For each suspected emissions, the antenna tower was scan (from 1 M to 4 M) and then the turntable was rotated (from 0 degree to 360 degrees) to find the maximum reading.
5. Set the test-receiver system to Peak or CISPR quasi-peak Detect Function with specified bandwidth under Maximum Hold Mode.
6. For emissions above 1GHz, use 1MHz VBW and RBW for peak reading. Then 1MHz RBW and 10Hz VBW for average reading in spectrum analyzer.
7. When the radiated emissions limits are expressed in terms of the average value of the emissions, and pulsed operation is employed, the measurement field strength shall be determined by averaging over one complete pulse train, including blanking intervals, as long as the pulse train does not exceed 0.1 seconds. As an alternative (provided the transmitter operates for longer than 0.1 seconds) or in cases where the pulse train exceeds 0.1 seconds, the measured field strength shall be determined from the average absolute voltage during a 0.1 second interval during which the field strength is at its maximum values.
8. If the emissions level of the EUT in peak mode was 3 dB lower than the average limit specified, then testing will be stopped and peak values of EUT will be reported, otherwise, the emissions which do not have 3 dB margin will be repeated one by one using the quasi-peak method for below 1GHz.
9. For testing above 1GHz, the emissions level of the EUT in peak mode was lower than average limit (that means the emissions level in peak mode also complies with the limit in average mode), then testing will be stopped and peak values of EUT will be reported, otherwise, the emissions will be measured in average mode again and reported.
10. In case the emission is lower than 30MHz, loop antenna has to be used for measurement and the recorded data should be QP measured by receiver. High - Low scan is not required in this case.

## 7.2 TEST SETUP

### RADIATED EMISSION TEST SETUP BELOW 30MHz

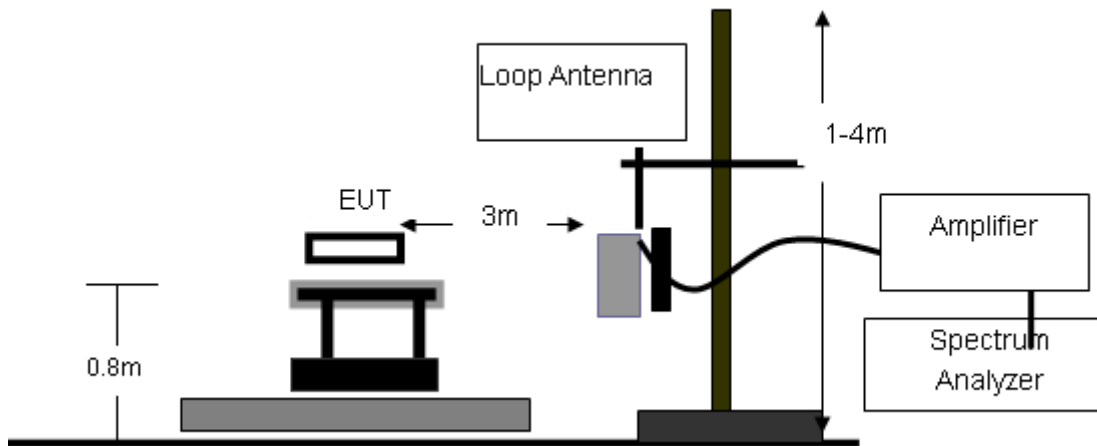

### RADIATED EMISSION TEST SETUP 30MHz-1000MHz

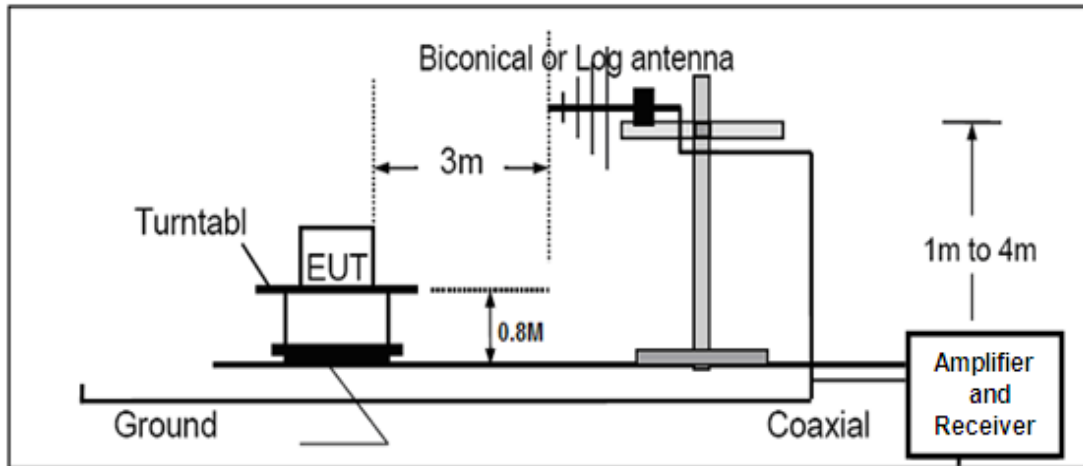

### RADIATED EMISSION TEST SETUP ABOVE 1000MHz

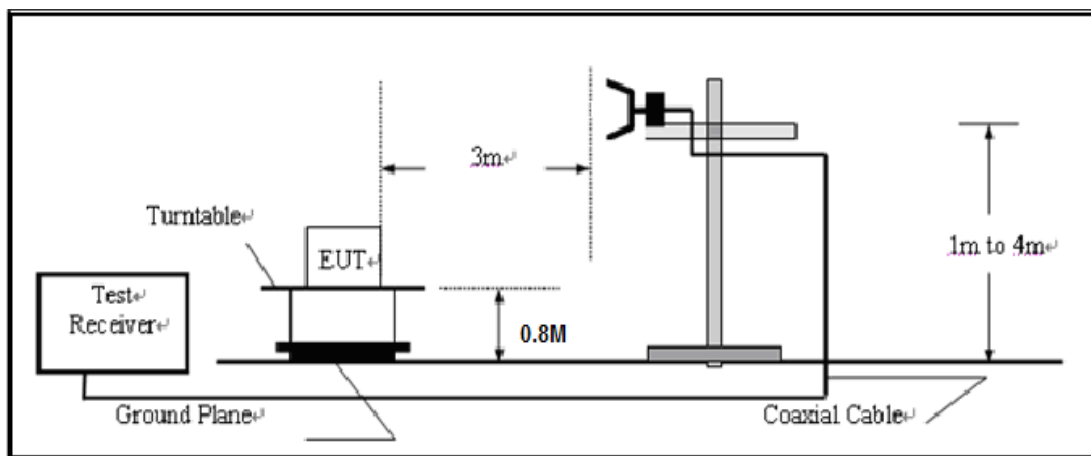

**7.3 TEST EQUIPMENT**

Description	Manufacturer	Model	S/N	Cal. Date	Cal. Due
Amplifier	EM	EM30180	0607030	02/28/2014	02/27/2015
Horn Antenna	EM	EM-AH-10180	67	04/19/2014	04/18/2015
Horn Antenna	A.H. Systems Inc.	SAS-574	--	07/17/2013	07/16/2014
EMI Test Receiver	Rohde & Schwarz	ESCI	100694	07/17/2013	07/16/2014
Biological Antenna	A.H. Systems Inc.	SAS-521-4	26	06/07/2013	06/06/2014
Loop Antenna	Daze	ZN30900N	SEL0097	07/17/2013	07/16/2014
Isolation Transformer	LETEAC	LTBK	--	07/17/2013	07/16/2014

**7.4 LIMITS AND MEASUREMENT RESULT**

15.209 Limit in the below table has to be followed

Frequencies (MHz)	Field Strength (micorvolts/meter)	Measurement Distance (meters)
0.009~0.490	2400/F(KHz)	300
0.490~1.705	24000/F(KHz)	30
1.705~30.0	30	30
30~88	100	3
88~216	150	3
216~960	200	3
Above 960	500	3

Note: All modes were tested For restricted band radiated emission, the test records reported below are the worst result compared to other modes.

**7.5 TEST RESULT**

**RADIATED EMISSION BELOW 30MHZ**

No emission found between lowest internal used/generated frequencies to 30MHz.

**RADIATED EMISSION BELOW 1GHZ**

**RADIATED EMISSION TEST- (30MHZ-1GHZ)-LOW CHANNEL-HORIZONTAL**

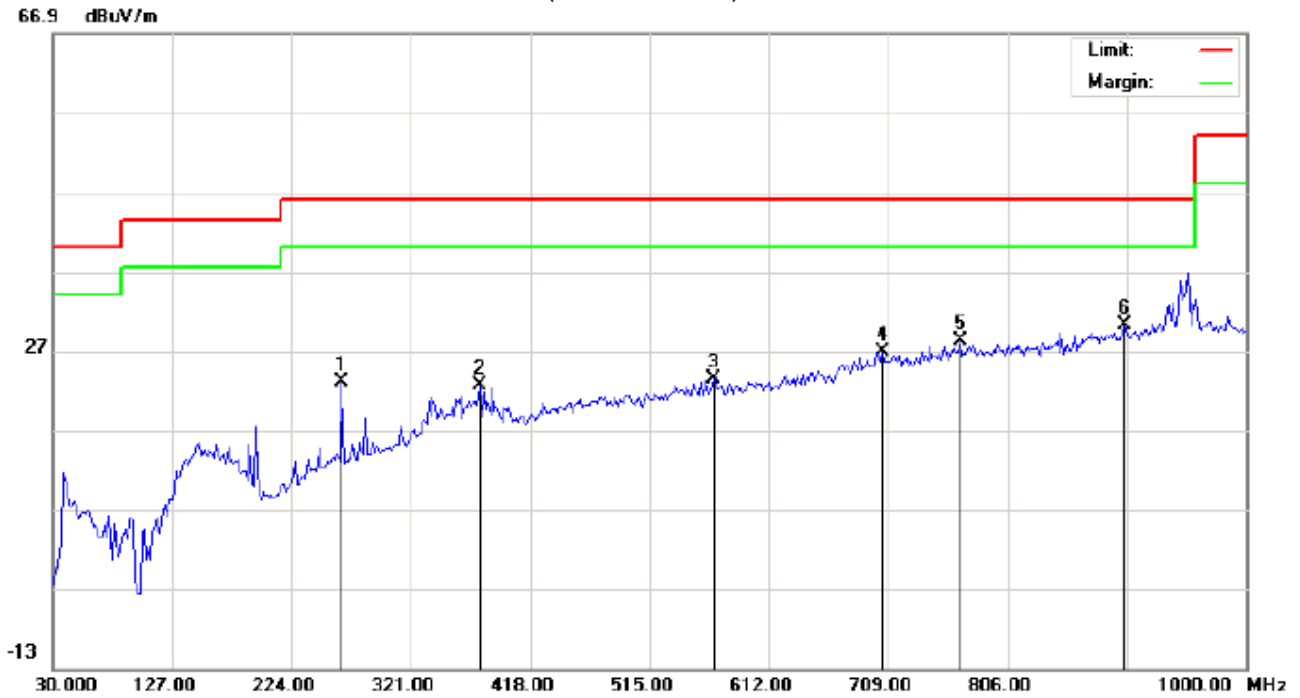

Site: site #1  
 Limit: FCC Class B 3M Radiation  
 EUT:Bluetooth Stereo Headset  
 M/N:BH-501  
 Mode:Low Channel TX  
 Note:

Polarization: *Horizontal*  
 Power:  
 Distance:

Temperature: 26  
 Humidity: 60 %

No.	Mk	Freq.	Reading	Factor	Measurement	Limit	Over	Detector	Antenna Height	Table Degree	Comment
		MHz	dBuV	dB/m	dBuV/m	dBuV/m	dB		cm	degree	
1		264.4167	8.76	14.34	23.10	46.00	-22.90	peak			
2		377.5833	3.65	18.92	22.57	46.00	-23.43	peak			
3		566.7333	0.89	22.56	23.45	46.00	-22.55	peak			
4		704.1500	1.53	25.31	26.84	46.00	-19.16	peak			
5		767.2000	1.34	26.87	28.21	46.00	-17.79	peak			
6	*	901.3833	1.61	28.65	30.26	46.00	-15.74	peak			

**RESULT: PASS**

RADIATED EMISSION TEST- (30MHZ-1GHZ)-LOW CHANNEL -VERTICAL

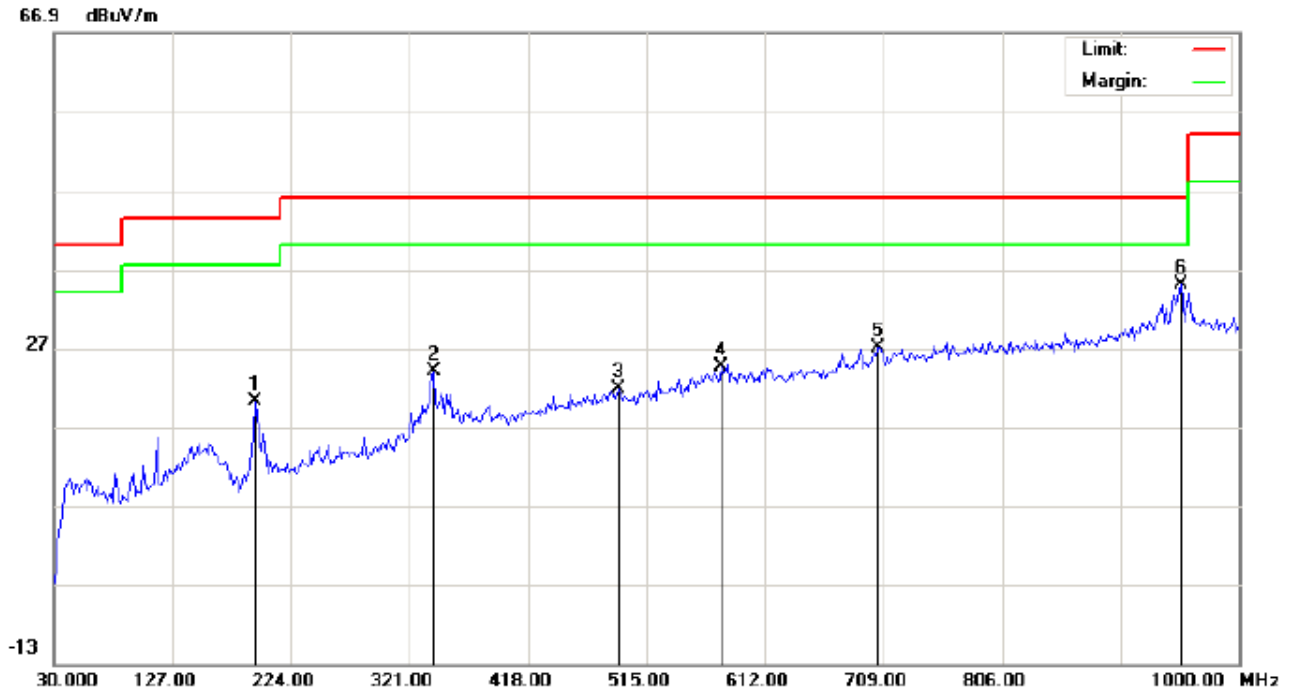

Site: site #1  
 Limit: FCC Class B 3M Radiation  
 EUT:Bluetooth Stereo Headset  
 M/N:BH-501  
 Mode:Low Channel TX  
 Note:

Polarization: *Vertical*  
 Power:  
 Distance:

Temperature: 26  
 Humidity: 60 %

No.	Mk	Freq.	Reading	Factor	Measurement	Limit	Over	Detector	Antenna Height	Table Degree	Comment
		MHz	dBuV	dB/m	dBuV/m	dBuV/m	dB		cm	degree	
1		194.9000	8.39	11.76	20.15	43.50	-23.35	peak			
2		340.4000	5.83	18.10	23.93	46.00	-22.07	peak			
3		492.3667	0.82	21.05	21.87	46.00	-24.13	peak			
4		576.4333	1.47	23.14	24.61	46.00	-21.39	peak			
5		704.1500	1.79	25.31	27.10	46.00	-18.90	peak			
6	*	953.1167	5.13	29.97	35.10	46.00	-10.90	peak			

**RESULT: PASS**

**Note:** 1. Factor=Antenna Factor + Cable loss, Margin=Measurement-Limit.

2. The "Factor" value can be calculated automatically by software of measurement system.

RADIATED EMISSION TEST- (30MHZ-1GHZ)-MIDDLE CHANNEL-HORIZONTAL

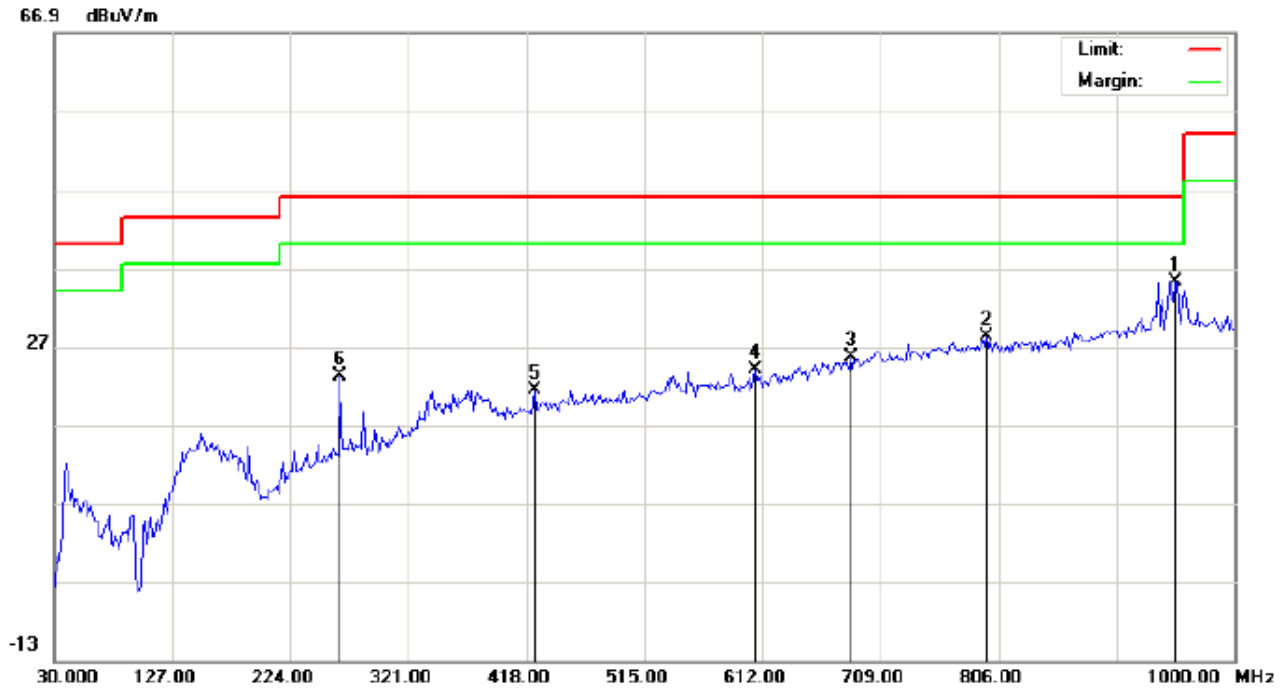

Site: site #1  
 Limit: FCC Class B 3M Radiation  
 EUT:Bluetooth Stereo Headset  
 M/N:BH-501  
 Mode:Middle channel TX  
 Note:

Polarization: *Horizontal*  
 Power:  
 Distance:

Temperature: 26  
 Humidity: 60 %

No.	Mk	Freq.	Reading	Factor	Measurement	Limit	Over	Detector	Antenna Height	Table Degree	Comment
		MHz	dBuV	dB/m	dBuV/m	dBuV/m	dB		cm	degree	
1	*	951.5000	5.29	29.99	35.28	46.00	-10.72	peak			
2		796.3000	0.86	27.27	28.13	46.00	-17.87	peak			
3		684.7500	0.79	24.78	25.57	46.00	-20.43	peak			
4		605.5333	1.11	22.85	23.96	46.00	-22.04	peak			
5		424.4667	1.57	19.81	21.38	46.00	-24.62	peak			
6		264.4167	8.92	14.34	23.26	46.00	-22.74	peak			

**RESULT: PASS**



RADIATED EMISSION TEST- (30MHZ-1GHZ)- MIDDLE CHANNEL -VERTICAL

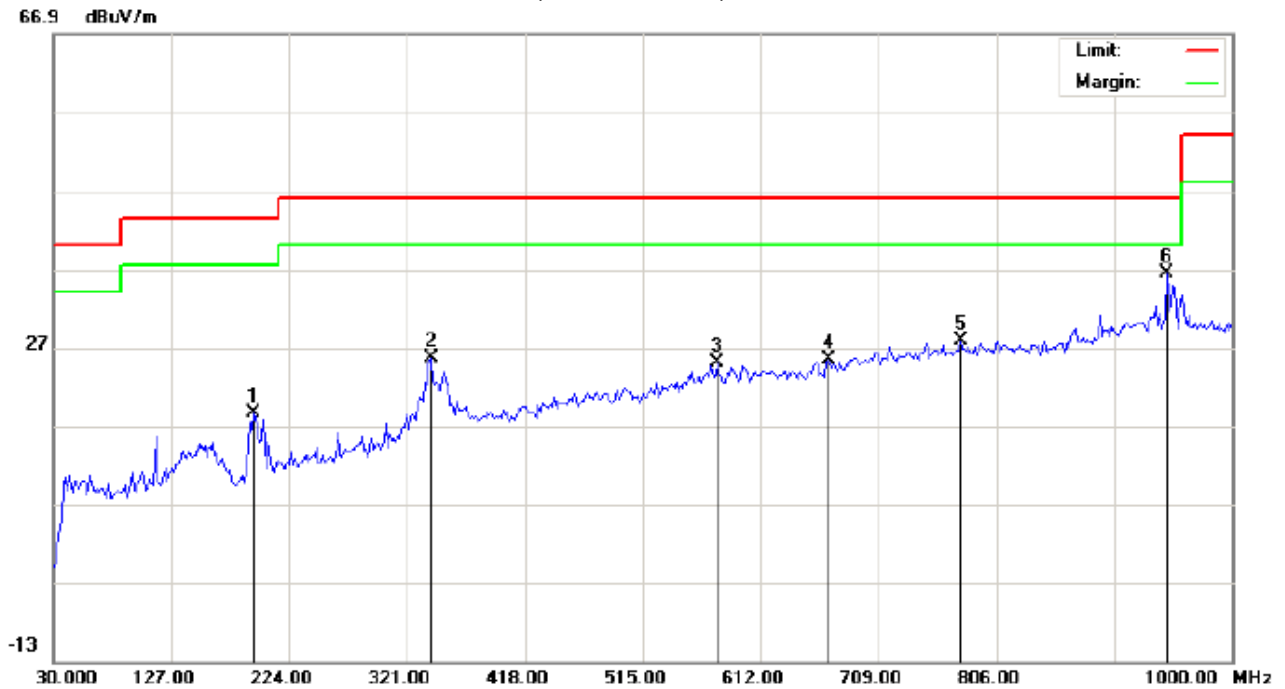

Site: site #1  
 Limit: FCC Class B 3M Radiation  
 EUT:Bluetooth Stereo Headset  
 M/N:BH-501  
 Mode:Middle channel TX  
 Note:

Polarization: **Vertical**  
 Power:  
 Distance:

Temperature: 26  
 Humidity: 60 %

No.	Mk	Freq.	Reading	Factor	Measurement	Limit	Over	Detector	Antenna Height	Table Degree	Comment
		MHz	dBuV	dB/m	dBuV/m	dBuV/m	dB		cm	degree	
1		194.9000	6.85	11.76	18.61	43.50	-24.89	peak			
2		340.4000	7.60	18.10	25.70	46.00	-20.30	peak			
3		576.4333	1.95	23.14	25.09	46.00	-20.91	peak			
4		668.5833	1.04	24.35	25.39	46.00	-20.61	peak			
5		776.9000	0.87	27.00	27.87	46.00	-18.13	peak			
6	*	946.6500	6.55	29.91	36.46	46.00	-9.54	peak			

**RESULT: PASS**

**Note:** 1. Factor=Antenna Factor + Cable loss, Margin=Measurement-Limit.

2. The "Factor" value can be calculated automatically by software of measurement system.

RADIATED EMISSION TEST- (30MHZ-1GHZ)-HIGH CHANNEL-HORIZONTAL

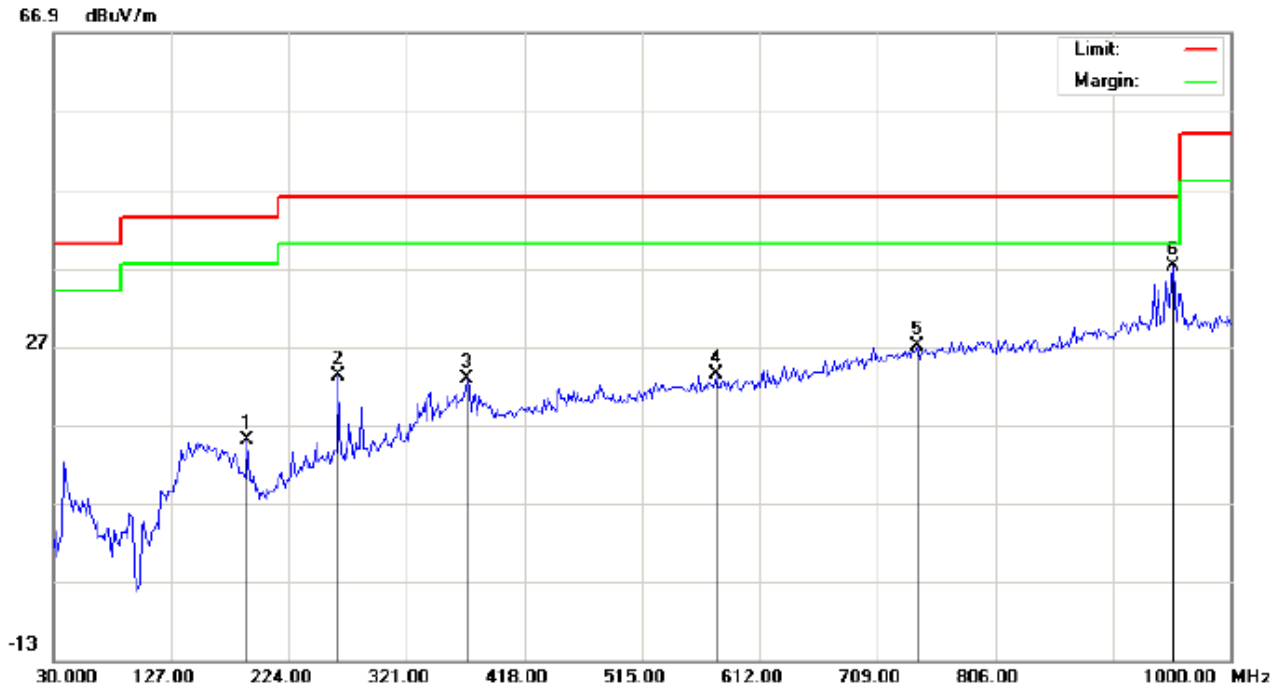

Site: site #1  
Limit: FCC Class B 3M Radiation  
EUT:Bluetooth Stereo Headset  
M/N:BH-501  
Mode:High Channel TX  
Note:

Polarization: *Horizontal*  
Power:  
Distance:

Temperature: 26  
Humidity: 60 %

No.	Mk	Freq.	Reading	Factor	Measurement	Limit	Over	Detector	Antenna	Table	Comment
		MHz	dBuV	dB/m	dBuV/m	dBuV/m	dB		Height	Degree	
1		190.0500	3.39	11.52	14.91	43.50	-28.59	peak	cm	degree	
2		264.4167	8.81	14.34	23.15	46.00	-22.85	peak			
3		371.1167	3.91	18.88	22.79	46.00	-23.21	peak			
4		576.4333	0.70	22.61	23.31	46.00	-22.69	peak			
5		741.3333	0.59	26.38	26.97	46.00	-19.03	peak			
6	*	953.1167	7.20	29.97	37.17	46.00	-8.83	peak			

**RESULT: PASS**

RADIATED EMISSION TEST- (30MHZ-1GHZ)-HIGH CHANNEL -VERTICAL



Site: site #1  
Limit: FCC Class B 3M Radiation  
EUT:Bluetooth Stereo Headset  
M/N:BH-501  
Mode:High Channel TX  
Note:

Polarization: *Vertical*  
Power:  
Distance:

Temperature: 26  
Humidity: 60 %

No.	Mk	Freq.	Reading	Factor	Measurement	Limit	Over	Detector	Antenna Height	Table Degree	Comment
		MHz	dBuV	dB/m	dBuV/m	dBuV/m	dB		cm	degree	
1		194.9000	5.82	11.76	17.58	43.50	-25.92	peak			
2		338.7833	8.35	17.99	26.34	46.00	-19.66	peak			
3		505.3000	0.77	21.27	22.04	46.00	-23.96	peak			
4		663.7333	0.06	24.22	24.28	46.00	-21.72	peak			
5		775.2833	1.27	26.98	28.25	46.00	-17.75	peak			
6	*	953.1167	6.46	29.97	36.43	46.00	-9.57	peak			

**RESULT: PASS**

**Note:** 1. Factor=Antenna Factor + Cable loss, Margin=Measurement-Limit.

2. The "Factor" value can be calculated automatically by software of measurement system.

**RADIATED EMISSION ABOVE 1GHZ**

**RADIATED EMISSION TEST- (ABOVE 1GHZ)-LOW CHANNEL-HORIZONTAL**

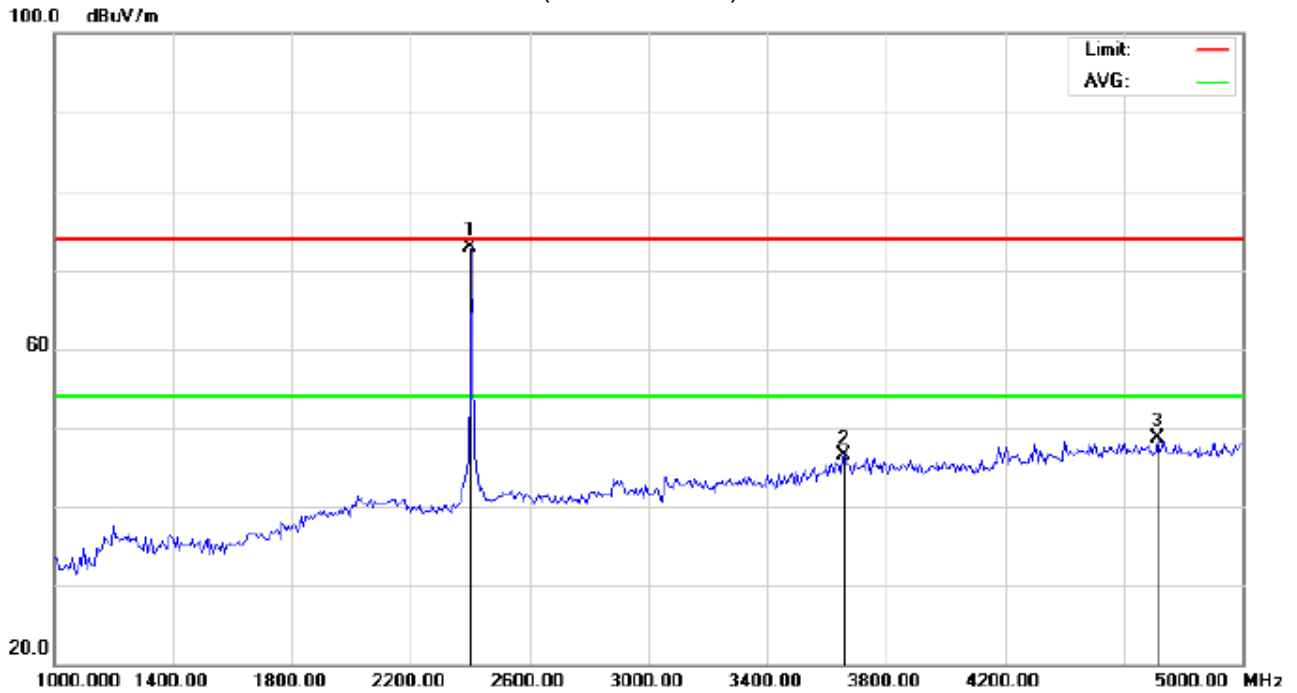

Site: site #1 Polarization: *Horizontal* Temperature: 26  
 Limit: FCC Class B 3M Radiation above 1GHZ(PK) Power: Humidity: 60 %  
 EUT:Bluetooth Stereo Headset Distance:  
 M/N:BH-501  
 Mode: Low channel TX  
 Note:

No.	Mk	Freq.	Reading	Factor	Measurement	Limit	Over	Detector	Antenna Height	Table Degree	Comment
		MHz	dBuV	dB/m	dBuV/m	dBuV/m	dB		cm	degree	
1	*	2402.000	82.61	-9.68	72.93	74.00	-1.07	peak			
2		3660.000	53.42	-6.90	46.52	74.00	-27.48	peak			
3		4713.333	51.24	-2.55	48.69	74.00	-25.31	peak			

**RESULT: PASS**

RADIATED EMISSION TEST-(ABOVE 1GHZ)-LOW CHANNEL-VERTICAL

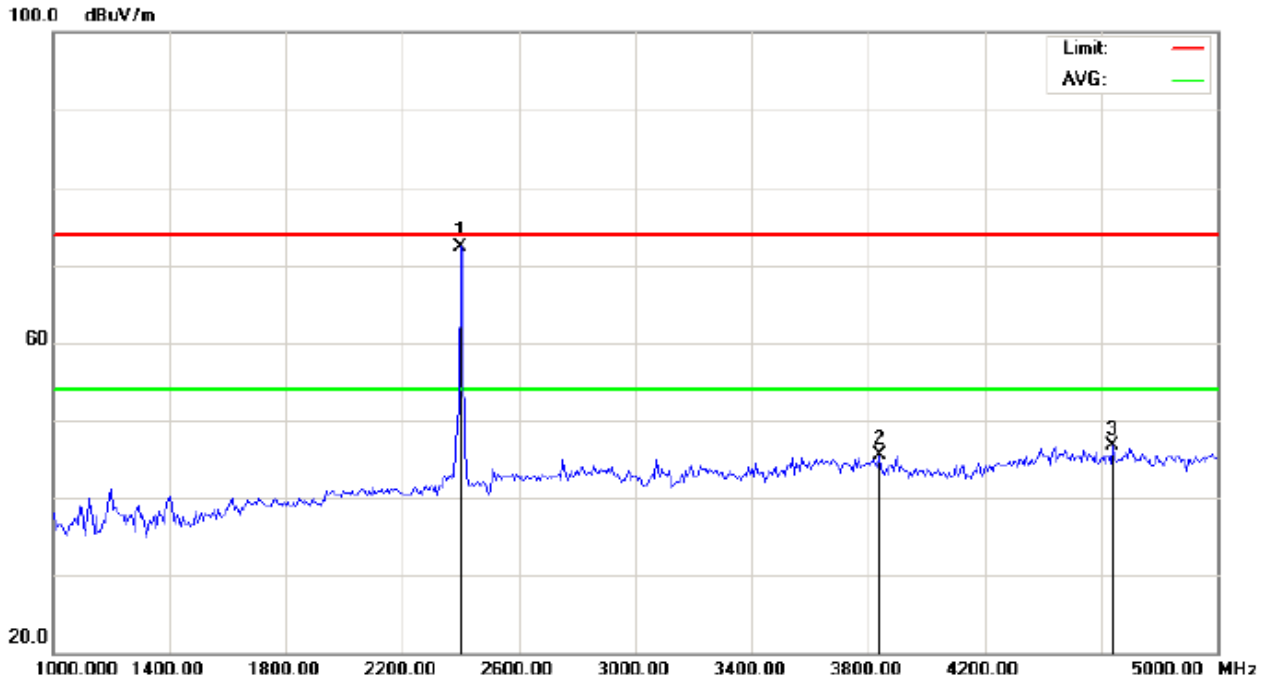

Site: site #1 Polarization: *Vertical* Temperature: 26  
 Limit: FCC Class B 3M Radiation above 1GHZ(PK) Power: Humidity: 60 %  
 EUT:Bluetooth Stereo Headset Distance:  
 M/N:BH-501  
 Mode: Low channel TX  
 Note:

No.	Mk	Freq.	Reading	Factor	Measurement	Limit	Over	Detector	Antenna Height	Table Degree	Comment
		MHz	dBuV	dB/m	dBuV/m	dBuV/m	dB		cm	degree	
1	*	2402.000	81.95	-9.68	72.27	74.00	-1.73	peak			
2		3840.000	51.22	-5.80	45.42	74.00	-28.58	peak			
3		4640.000	49.39	-2.74	46.65	74.00	-27.35	peak			

**RESULT: PASS**

**Note:** 1. Factor=Antenna Factor + Cable loss, Margin=Measurement-Limit.

2. The "Factor" value can be calculated automatically by software of measurement system.

RADIATED EMISSION TEST-(ABOVE 1GHZ)-MIDDLE CHANNEL-HORIZONTAL

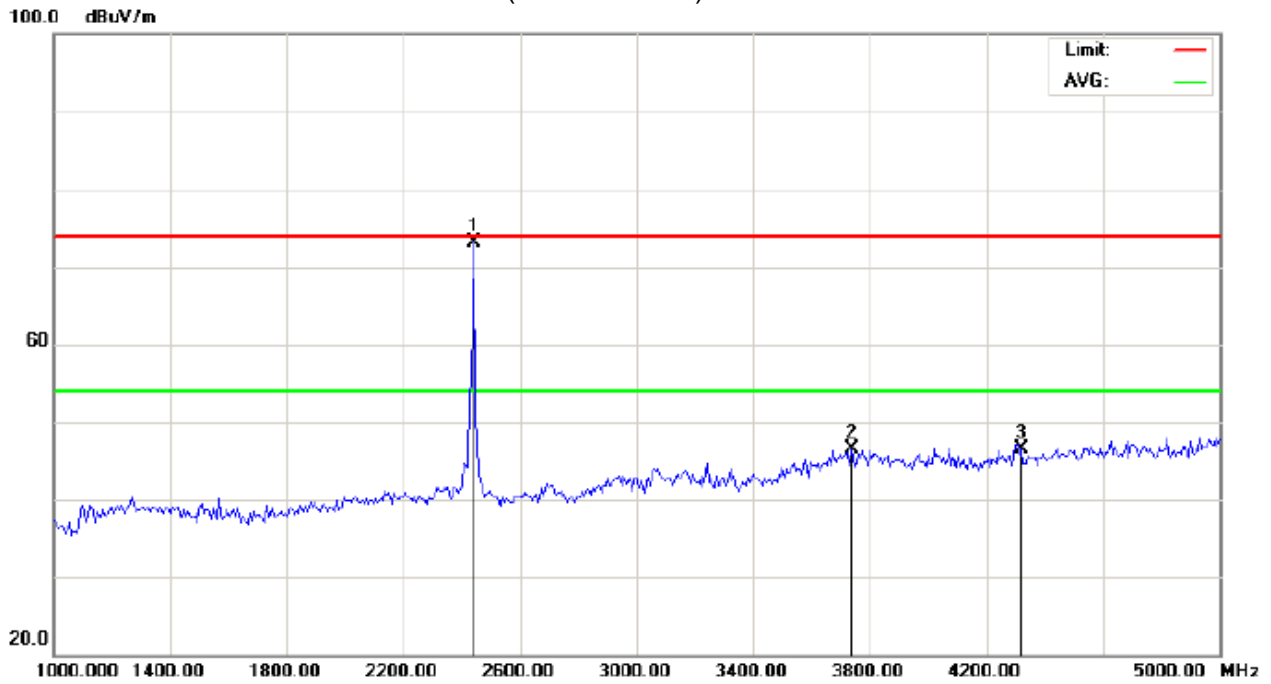

Site: site #1 Polarization: *Horizontal* Temperature: 26  
 Limit: FCC Class B 3M Radiation above 1GHZ(PK) Power: Humidity: 60 %  
 EUT:Bluetooth Stereo Headset Distance:  
 M/N:BH-501  
 Mode: Middle channel TX  
 Note:

No.	Mk	Freq.	Reading	Factor	Measurement	Limit	Over	Detector	Antenna Height	Table Degree	Comment
		MHz	dBuV	dB/m	dBuV/m	dBuV/m	dB		cm	degree	
1	*	2440.000	82.76	-9.64	73.12	74.00	-0.88	peak			
2		3740.000	52.89	-6.41	46.48	74.00	-27.52	peak			
3		4320.000	50.18	-3.72	46.46	74.00	-27.54	peak			

**RESULT: PASS**

RADIATED EMISSION TEST-(ABOVE 1GHZ)-MIDDLE CHANNEL-VERTICAL

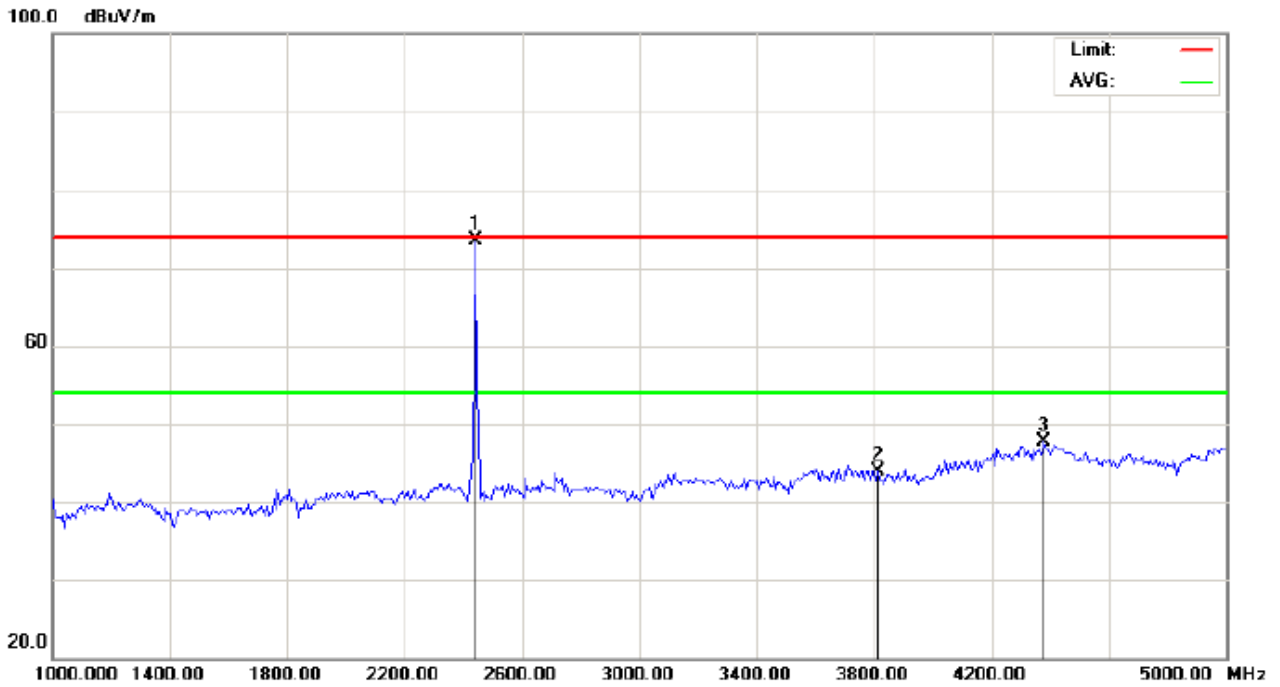

Site: site #1 Polarization: *Vertical* Temperature: 26  
 Limit: FCC Class B 3M Radiation above 1GHZ(PK) Power: Humidity: 60 %  
 EUT:Bluetooth Stereo Headset Distance:  
 M/N:BH-501  
 Mode: Middle channel TX  
 Note:

No.	Mk	Freq.	Reading	Factor	Measurement	Limit	Over	Detector	Antenna Height	Table Degree	Comment
		MHz	dBuV	dB/m	dBuV/m	dBuV/m	dB		cm	degree	
1	*	2440.000	83.17	-9.64	73.53	74.00	-0.47	peak			
2		3813.333	49.77	-5.96	43.81	74.00	-30.19	peak			
3		4380.000	51.17	-3.52	47.65	74.00	-26.35	peak			

**RESULT: PASS**

**Note:** 1. Factor=Antenna Factor + Cable loss, Margin=Measurement-Limit.

2. The "Factor" value can be calculated automatically by software of measurement system.

RADIATED EMISSION TEST-(ABOVE 1GHZ)-HIGH CHANNEL-HORIZONTAL

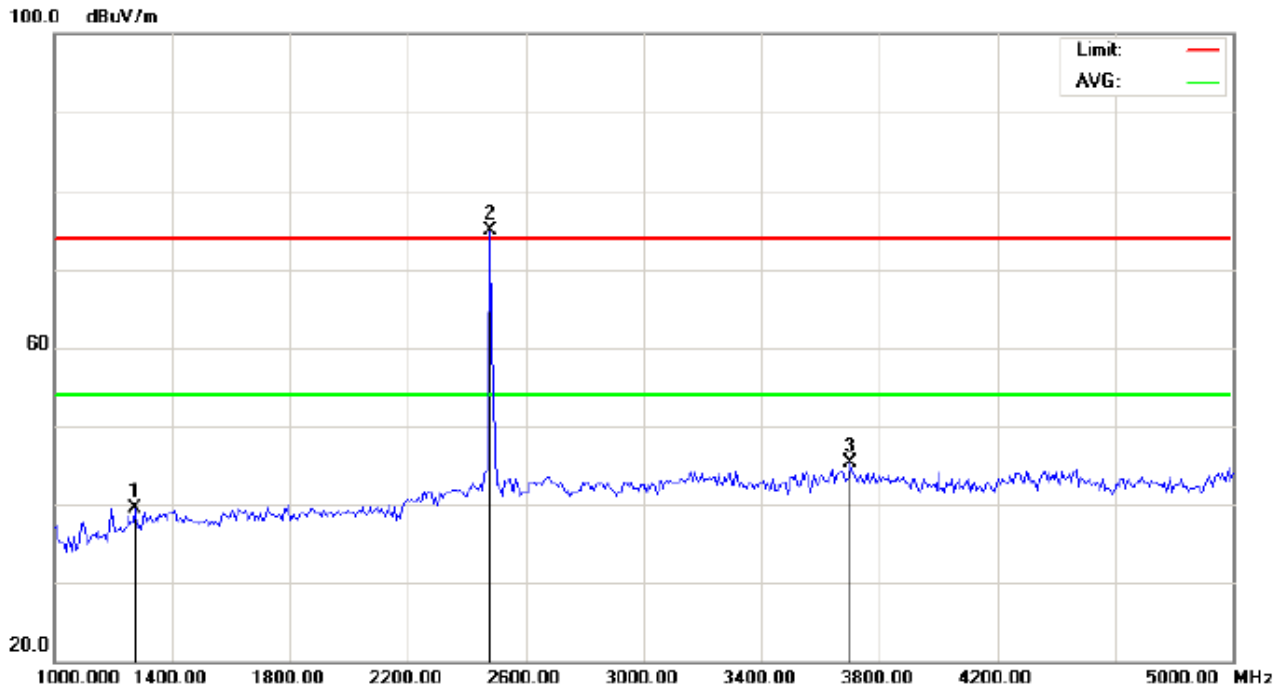

Site: site #1 Polarization: *Horizontal* Temperature: 26  
 Limit: FCC Class B 3M Radiation above 1GHZ(PK) Power: Humidity: 60 %  
 EUT:Bluetooth Stereo Headset Distance:  
 M/N:BH-501  
 Mode: High channel TX  
 Note:

No.	Mk	Freq.	Reading	Factor	Measurement	Limit	Over	Detector	Antenna Height	Table Degree	Comment
		MHz	dBuV	dB/m	dBuV/m	dBuV/m	dB		cm	degree	
1		1273.333	54.97	-15.48	39.49	74.00	-34.51	peak			
2	*	2480.000	84.46	-9.59	74.87	74.00	0.87	peak			
3		3700.000	51.99	-6.66	45.33	74.00	-28.67	peak			

**RESULT: PASS**



RADIATED EMISSION TEST-(ABOVE 1GHZ)-HIGH CHANNEL-VERTICAL

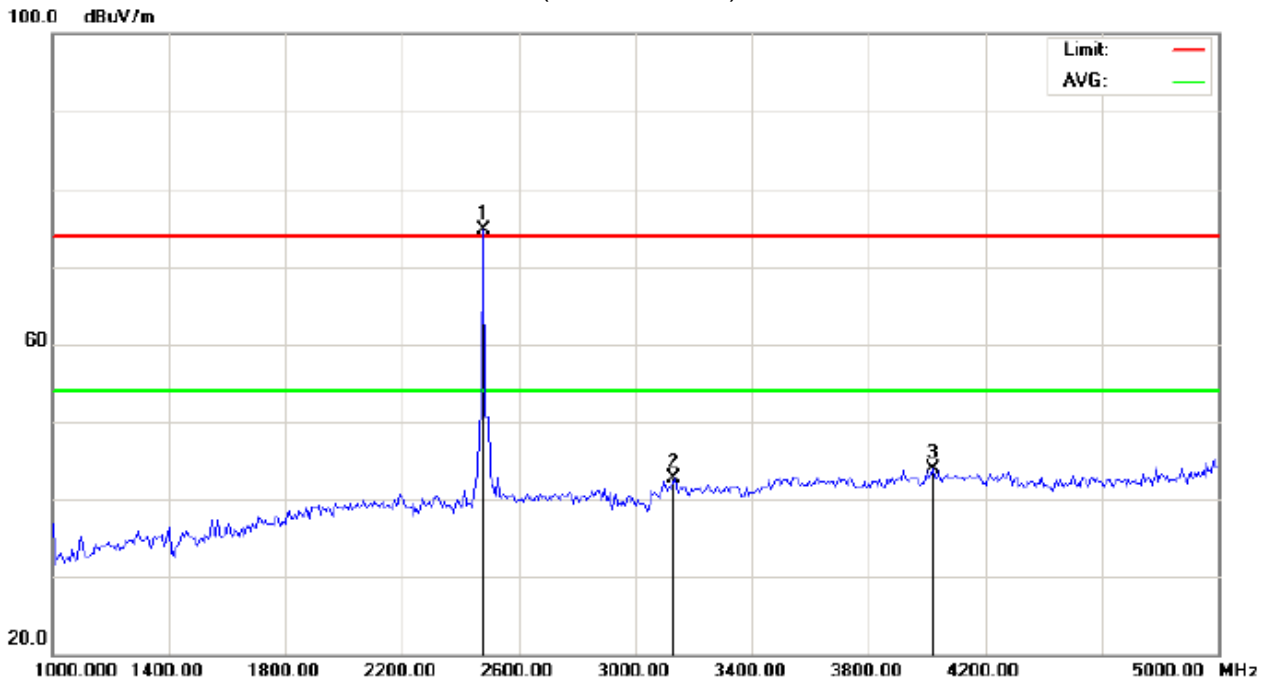

Site: site #1  
 Limit: FCC Class B 3M Radiation above 1GHZ(PK)  
 EUT:Bluetooth Stereo Headset  
 M/N:BH-501  
 Mode: High channel TX  
 Note:

Polarization: *Vertical*  
 Power:  
 Distance:

Temperature: 26  
 Humidity: 60 %

No.	Mk	Freq.	Reading	Factor	Measurement	Limit	Over	Detector	Antenna Height	Table Degree	Comment
		MHz	dBuV	dB/m	dBuV/m	dBuV/m	dB		cm	degree	
1	*	2480.000	84.27	-9.59	74.68	74.00	0.68	peak			
2		3133.333	50.93	-8.23	42.70	74.00	-31.30	peak			
3		4020.000	48.69	-4.74	43.95	74.00	-30.05	peak			

**RESULT: PASS**

**Note:** 5~25GHz at least have 20dB margin. No recording in the test report.

Factor=Antenna Factor+ Cable loss-Amplifier gain,

Margin=Measurement-Limit.

The "Factor" value can be calculated automatically by software of measurement system.

## **8. BAND EDGE EMISSION**

### **8.1. MEASUREMENT PROCEDURE**

1. Set the EUT Work on the top, the bottom operation frequency individually.
2. Set Span = 2MHz, RBW $\geq$ 100 KHz, VBW $\geq$ 3RBW, Center frequency =Operation frequency
3. The band edges was measured and recorded.

### **8.2. TEST SET-UP**

Radiated same as 7.2

### 8.3. TEST RESULT

#### TEST PLOT OF BAND EDGE FOR LOW CHANNEL -Horizontal

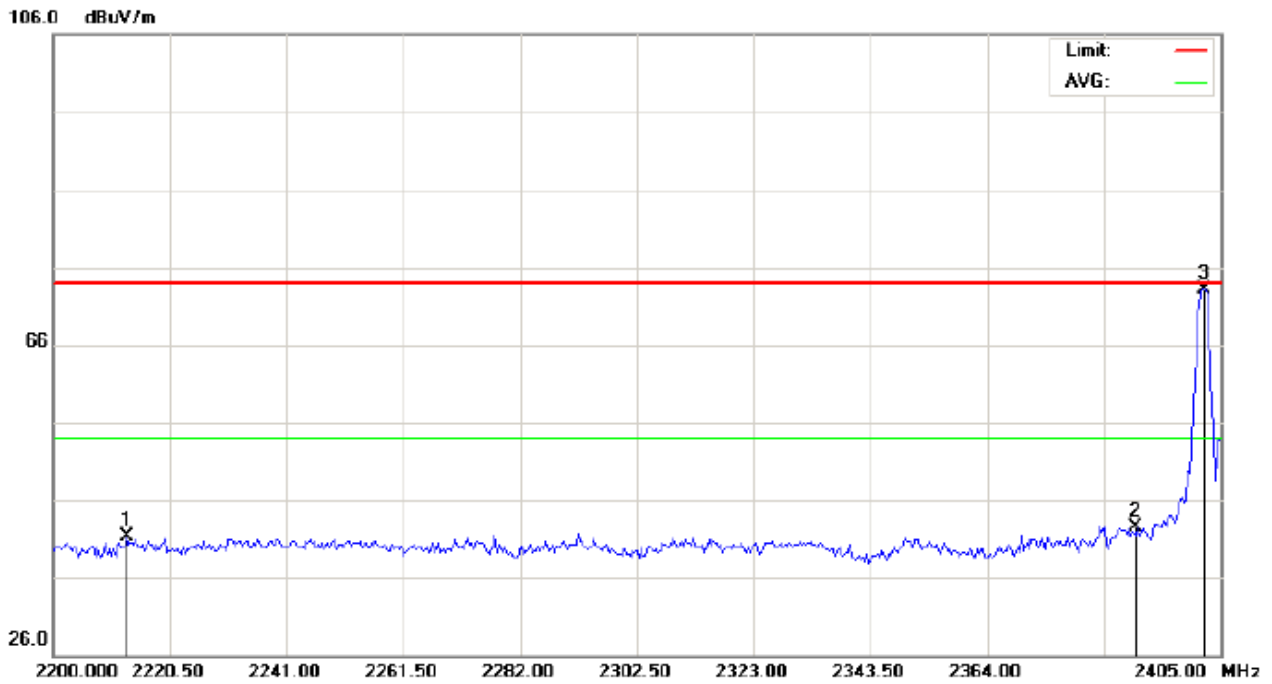

Site: site #1 Polarization: *Horizontal* Temperature: 26  
Limit: FCC Class B 3M Radiation above 1GHZ(PK) Power: Humidity: 60 %  
EUT:Bluetooth Stereo Headset Distance:  
M/N:BH-501  
Mode: Low Channel TX  
Note:

No.	Mk	Freq.	Reading	Factor	Measurement	Limit	Over	Detector	Antenna Height	Table Degree	Comment
		MHz	dBuV	dB/m	dBuV/m	dBuV/m	dB		cm	degree	
1		2212.983	51.26	-9.89	41.37	74.00	-32.63	peak			
2		2390.000	52.26	-9.69	42.57	74.00	-31.43	peak			
3	*	2402.000	82.87	-9.68	73.19	74.00	-0.81	peak			

TEST PLOT OF BAND EDGE FOR LOW CHANNEL - Vertical

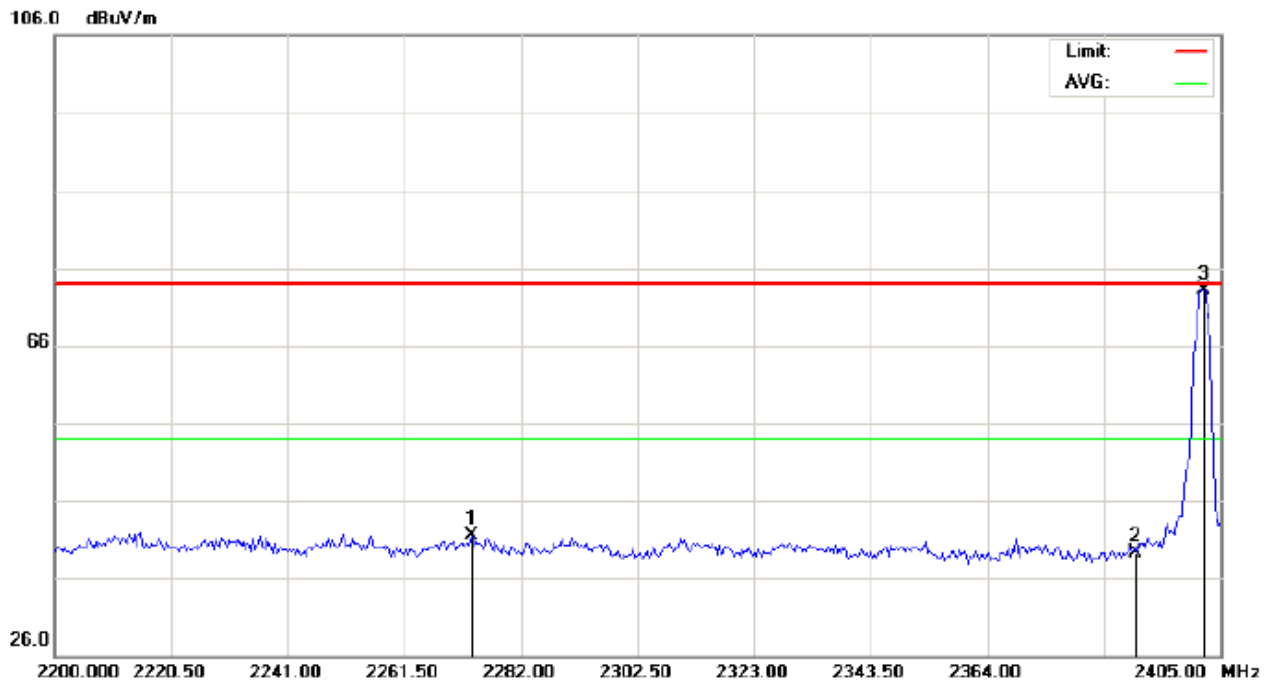

Site: site #1      Polarization: *Vertical*      Temperature: 26  
 Limit: FCC Class B 3M Radiation above 1GHZ(PK)      Power:      Humidity: 60 %  
 EUT:Bluetooth Stereo Headset      Distance:  
 M/N:BH-501  
 Mode: Low Channel TX  
 Note:

No.	Mk	Freq.	Reading	Factor	Measurement	Limit	Over	Detector	Antenna Height	Table Degree	Comment
		MHz	dBuV	dB/m	dBuV/m	dBuV/m	dB		cm	degree	
1		2273.458	51.23	-9.82	41.41	74.00	-32.59	peak			
2		2390.000	49.06	-9.69	39.37	74.00	-34.63	peak			
3	*	2402.000	82.87	-9.68	73.19	74.00	-0.81	peak			

**RESULT: PASS**

TEST PLOT OF BAND EDGE FOR HIGH CHANNEL –Horizontal

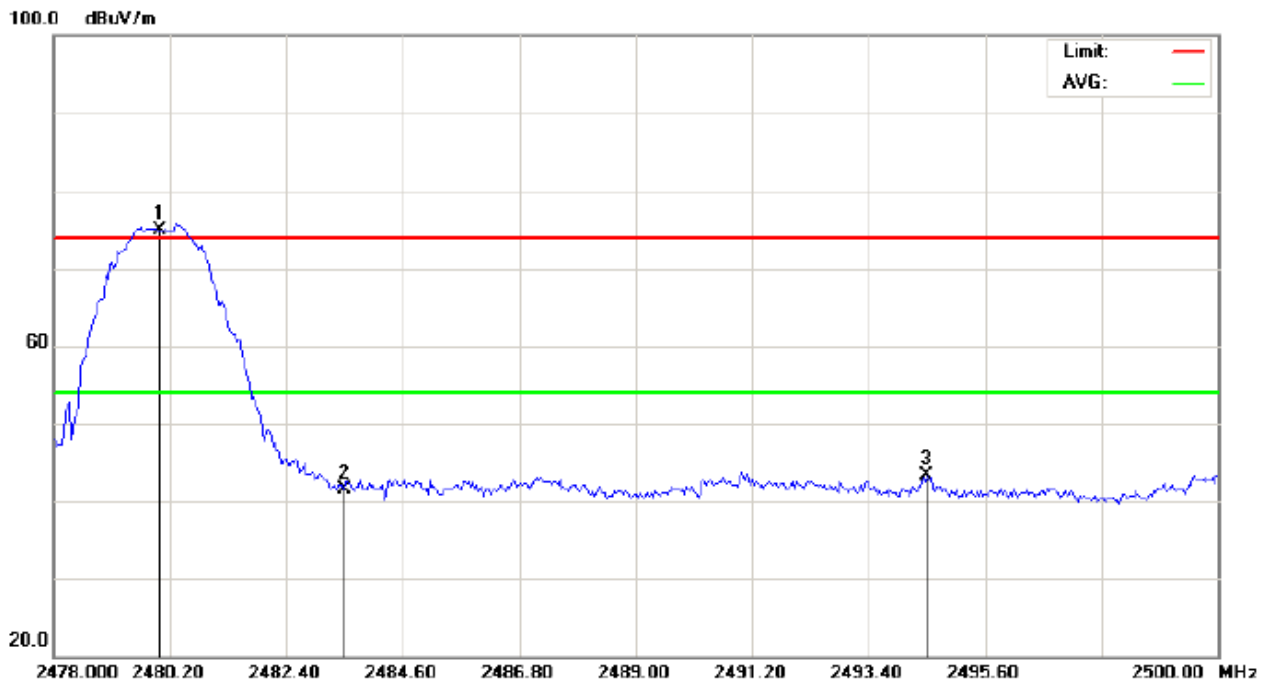

Site: site #1 Polarization: *Horizontal* Temperature: 26  
 Limit: FCC Class B 3M Radiation above 1GHZ(PK) Power: Humidity: 60 %  
 EUT:Bluetooth Stereo Headset Distance:  
 M/N:BH-501  
 Mode: High Channel TX  
 Note:

No.	Mk	Freq.	Reading	Factor	Measurement	Limit	Over	Detector	Antenna	Table	Comment
		MHz	dBuV	dB/m	dBuV/m	dBuV/m	dB		Height	Degree	
									cm	degree	
1	*	2480.000	84.54	-9.59	74.95	74.00	0.95	peak			
2		2483.500	51.10	-9.59	41.51	74.00	-32.49	peak			
3		2494.500	52.90	-9.58	43.32	74.00	-30.68	peak			

TEST PLOT OF BAND EDGE FOR HIGH CHANNEL -Vertical

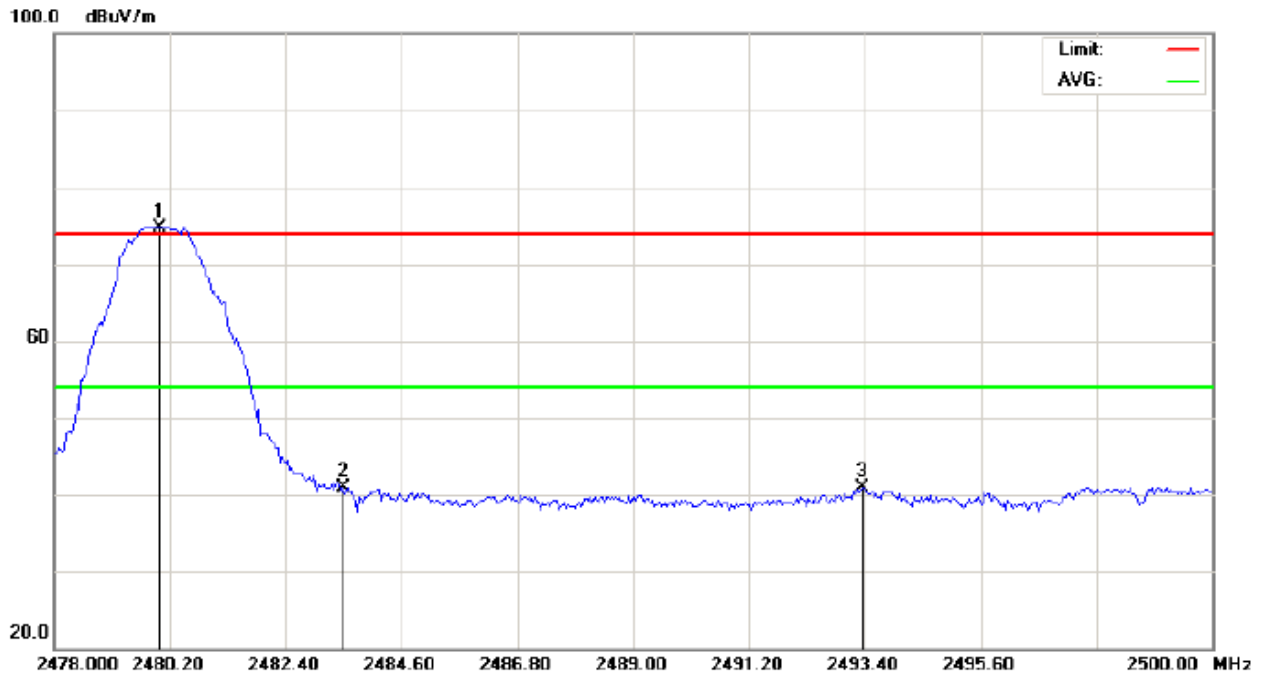

Site: site #1 Polarization: *Vertical* Temperature: 26  
Limit: FCC Class B 3M Radiation above 1GHZ(PK) Power: Humidity: 60 %  
EUT:Bluetooth Stereo Headset Distance:  
M/N:BH-501  
Mode: High Channel TX  
Note:

No.	Mk	Freq.	Reading	Factor	Measurement	Limit	Over	Detector	Antenna Height	Table Degree	Comment
		MHz	dBuV	dB/m	dBuV/m	dBuV/m	dB		cm	degree	
1	*	2480.000	84.31	-9.59	74.72	74.00	0.72	peak			
2		2483.500	50.58	-9.59	40.99	74.00	-33.01	peak			
3		2493.363	50.45	-9.58	40.87	74.00	-33.13	peak			

**RESULT: PASS**

## 9. 6DB BANDWIDTH

### 9.1. TEST EQUIPMENT LIST AND DETAILS

Equipment	Manufacturer	Model	S/N	Cal. Date	Cal. Due
PSA SERIES SPECTRUM ANALYZER	AGILENT	E4440A	US41421290	07/17/2013	07/16/2014
RECEIVER ANTENNA	ETS	2175	57337	07/17/2013	07/16/2014

### 9.2. TEST PROCEDURE

1. The EUT was placed on a table which is 0.8m above ground plane.
2. Connect EUT RF output port to the Spectrum Analyzer through an RF attenuator
3. Set the EUT Work on the top, the middle and the bottom operation frequency individually.
3. Set SPA Centre Frequency = Operation Frequency, RBW= 100 KHz, VBW $\geq$ 3\*RBW.
4. Set SPA Trace 1 Max hold, then View.

### 9.3. SUMMARY OF TEST RESULTS/PLOTS

Channel	6dB Bandwidth (KHz)	Minimum Limit (KHz)	Pass/Fail
Low	691	500KHz	Pass
Middle	696		Pass
High	690		Pass

TEST PLOT OF BANDWIDTH FOR LOW CHANNEL

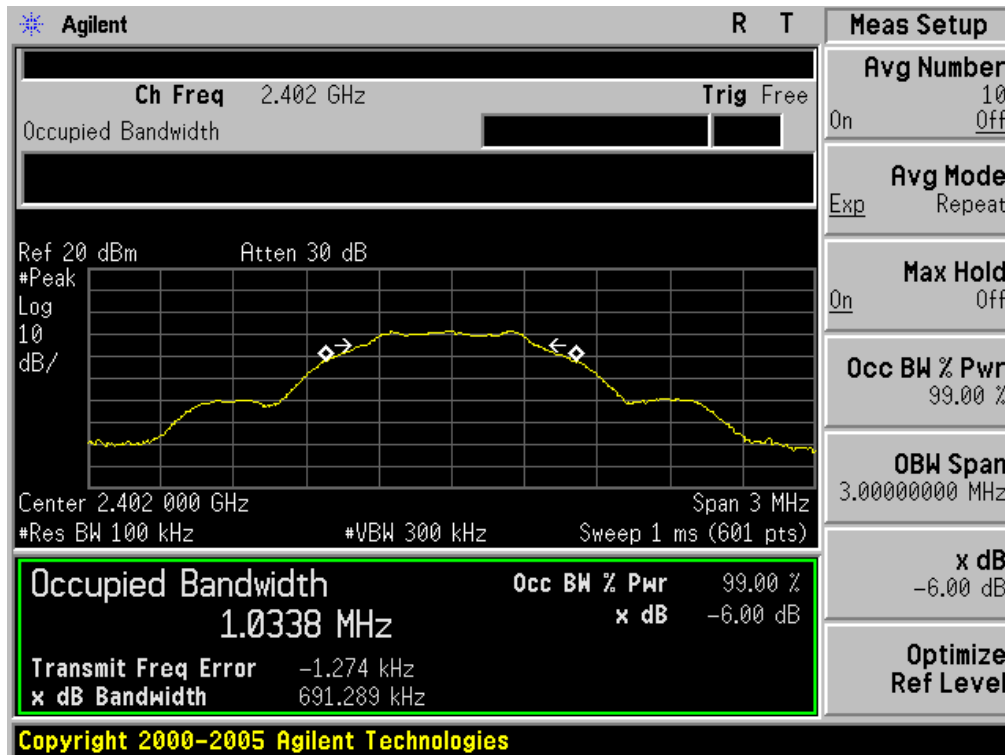

TEST PLOT OF BANDWIDTH FOR MIDDLE CHANNEL

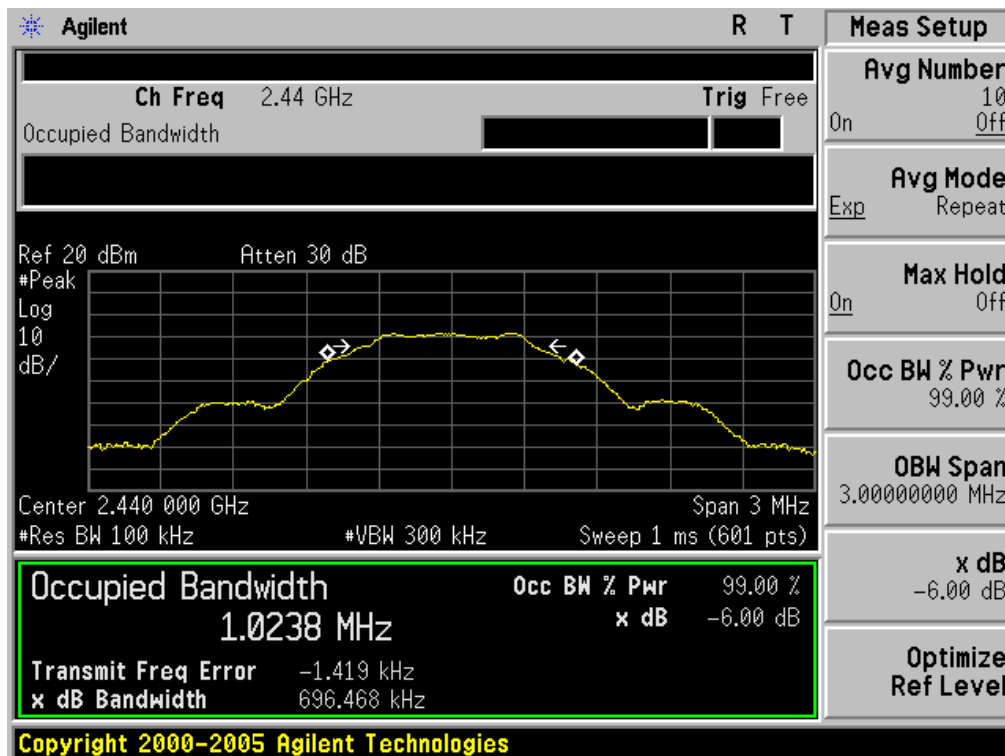



TEST PLOT OF BANDWIDTH FOR HIGH CHANNEL

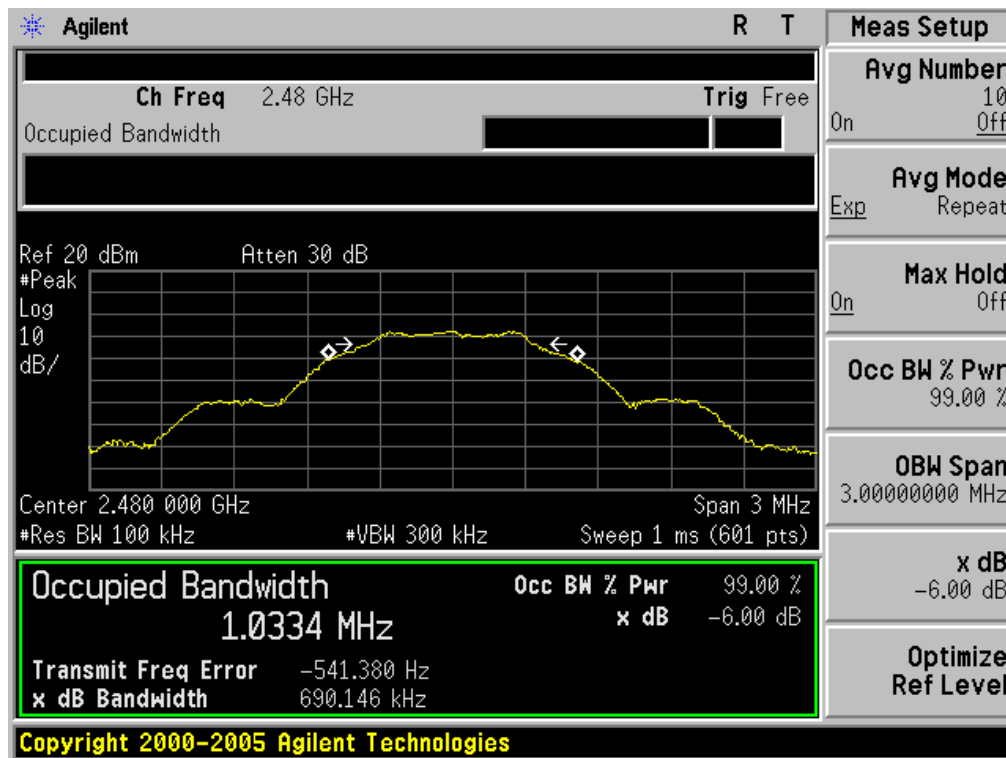

## 10. CONDUCTED OUTPUT POWER

### 10.1. MEASUREMENT PROCEDURE

For peak power test:

1. The EUT was placed on a turn table which is 0.8m above ground plane.
2. Connect EUT RF output port to the Spectrum Analyzer through an RF attenuator
3. Set the EUT Work on the top, middle and the bottom operation frequency individually.
4. Use the following spectrum analyzer settings:
  - a) Set the RBW  $\geq$  DTS bandwidth.
  - b) Set VBW  $\geq 3$  RBW.
  - c) Set span  $\geq 3 \times$  RBW
  - d) Sweep time = auto couple.
  - e) Detector = peak.
  - f) Trace mode = max hold.
  - g) Allow trace to fully stabilize.
  - h) Use peak marker function to determine the peak amplitude level.
5. Allow the trace to stabilize.
6. Record the result form the Spectrum Analyzer.

For average power test:

1. The EUT was placed on a table which is 0.8m above ground plane.
2. Connect EUT RF output port to power probe through an RF attenuator.
3. Connect the power probe to the PC.
4. Set the EUT Work on the top, the middle and the bottom operation frequency individually.
5. Record the maximum power from the software.
6. The maximum peak power shall be less 1W (30dBm).

**Note:** The EUT was tested according to KDB 558074 for compliance to FCC 47CFR 15.247 requirements

### 10.2. TEST SET-UP (BLOCK DIAGRAM OF CONFIGURATION)

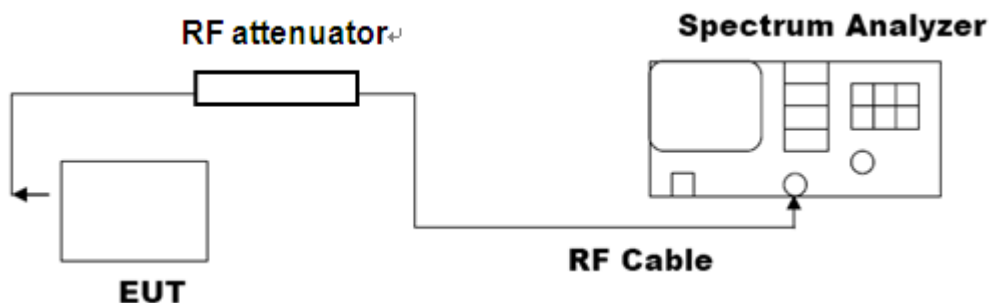

10.3. LIMITS AND MEASUREMENT RESULT

Channel	Average Power (dBm)	Peak Power (dBm)	Applicable Limits (dBm)	Pass/Fail
Low Channel	-9.55	-7.7	30	Pass
Middle Channel	-9.16	-7.27	30	Pass
High Channel	-8.69	-6.78	30	Pass

The Low Channel Result

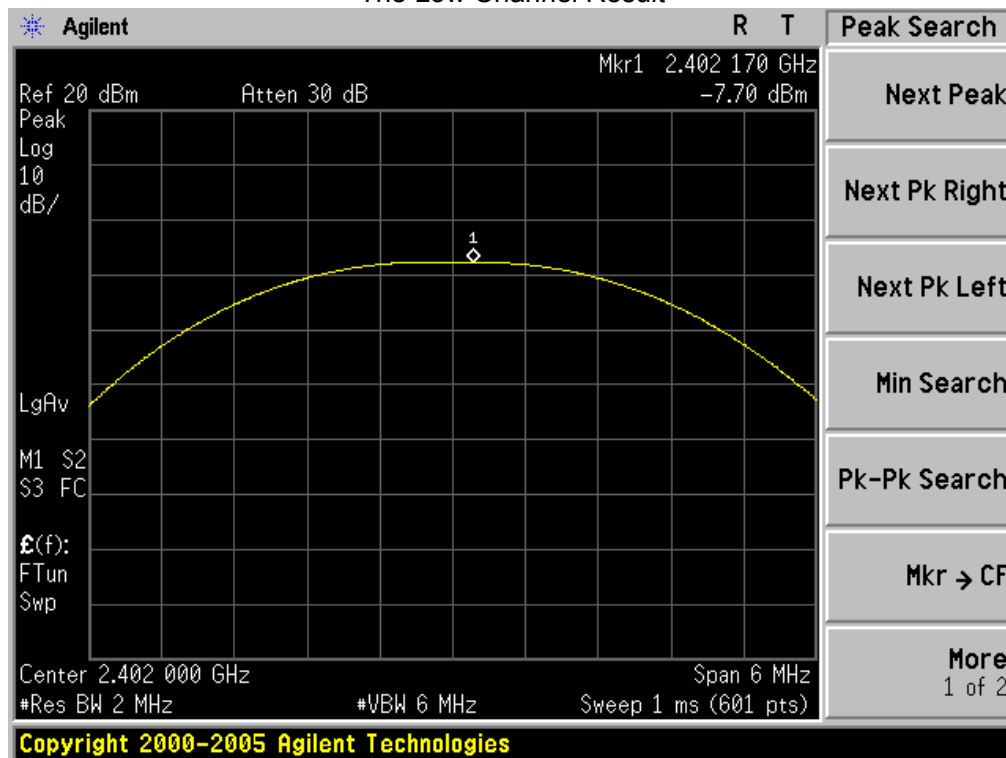

The Middle Channel Result

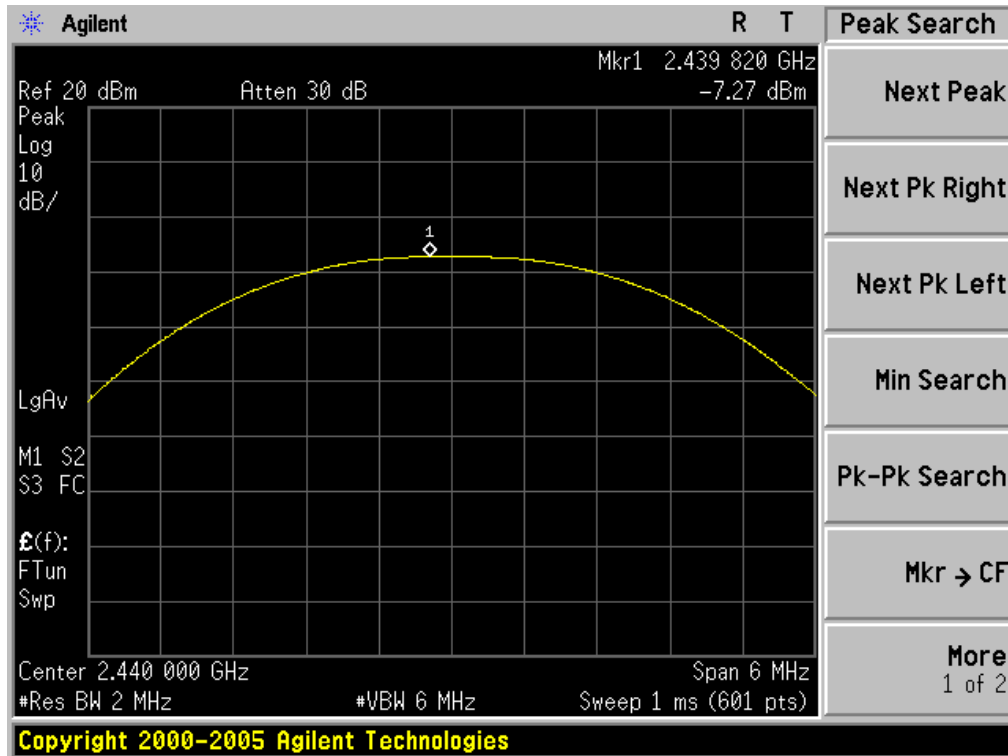

The High Channel Result

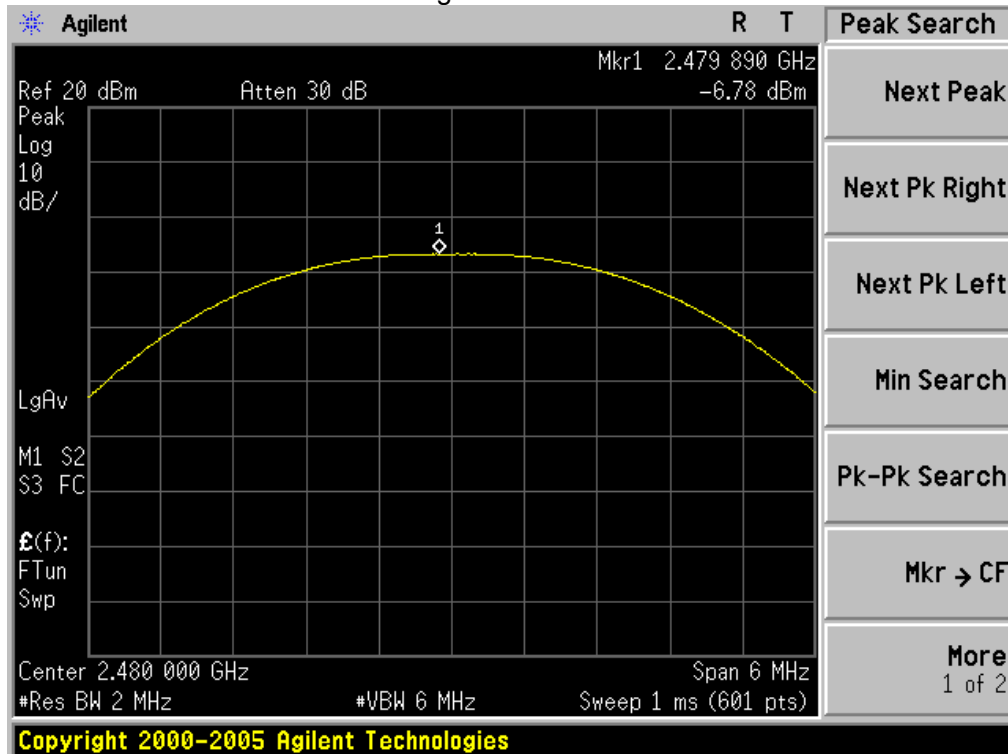

## 11. MAXIMUM CONDUCTED OUTPUT POWER SPECTRAL DENSITY

### 11.1 MEASUREMENT PROCEDURE

- (1). The EUT was placed on a turn table which is 0.8m above ground plane.
- (2). Connect EUT RF output port to the Spectrum Analyzer through an RF attenuator
- (3). Set the EUT Work on the top, the middle and the bottom operation frequency individually.
- (4). Set the span to 1.5times the DTS bandwidth, RBW:  $3\text{kHz} \leq \text{RBW} \leq 100\text{KHz}$ , VBW  $> 3 * \text{RBW}$
- (5). Set SPA Trace 1 Max hold, then View.

**Note:** The EUT was tested according to KDB 558074 for compliance to FCC 47CFR 15.247 requirements.

### 11.2 TEST SET-UP (BLOCK DIAGRAM OF CONFIGURATION)

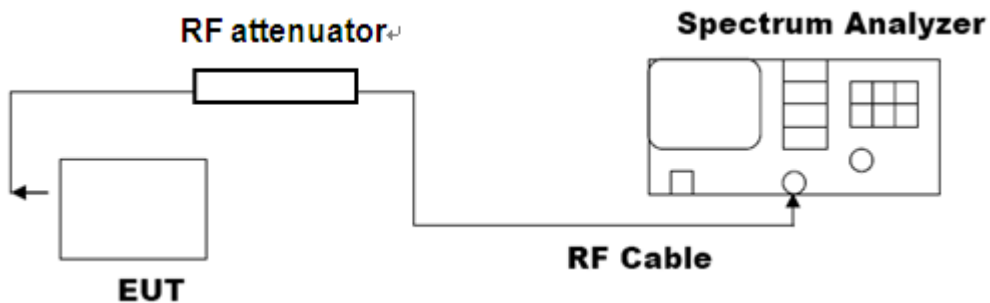

### 11.3 MEASUREMENT EQUIPMENT USED

Equipment	Manufacturer	Model	S/N	Cal. Date	Cal. Due
PSA SERIES SPECTRUM ANALYZER	AGILENT	E4440A	US41421290	07/17/2013	07/16/2014
RECEIVER ANTENNA	ETS	2175	57337	07/17/2013	07/16/2014

### 11.4 LIMITS AND MEASUREMENT RESULT

Channel No.	PSD (dBm)	Limit (dBm)	Result
Low Channel	-23.04	8	Pass
Middle Channel	-22.6	8	Pass
High Channel	-22.13	8	Pass

TEST PLOT OF SPECTRAL DENSITY FOR LOW CHANNEL

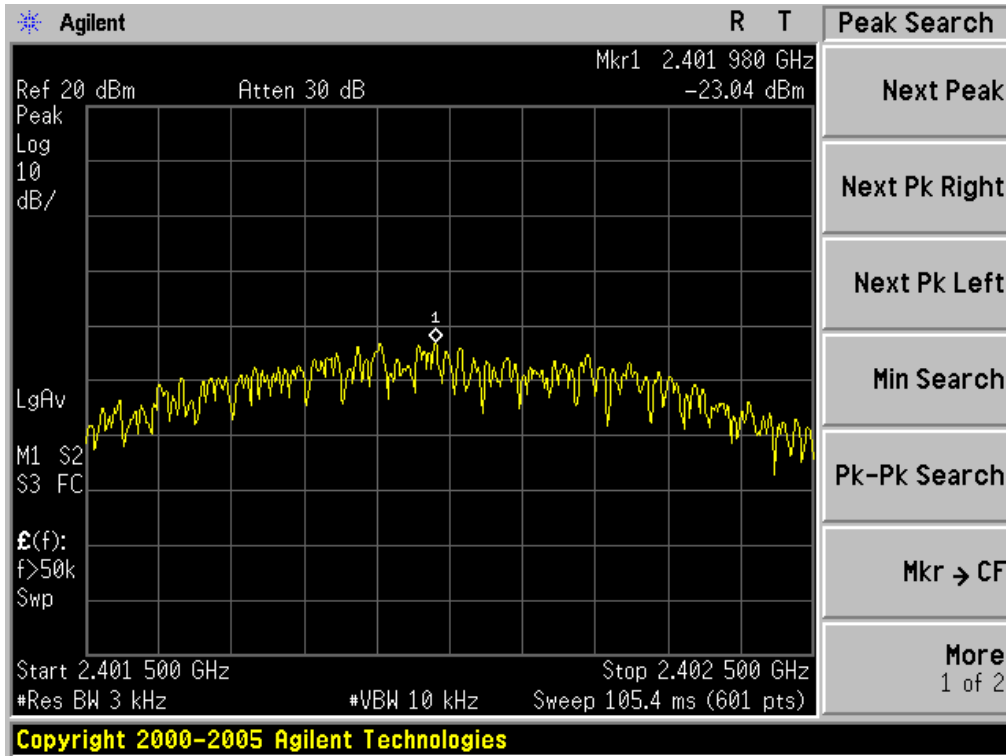

TEST PLOT OF SPECTRAL DENSITY FOR MIDDLE CHANNEL

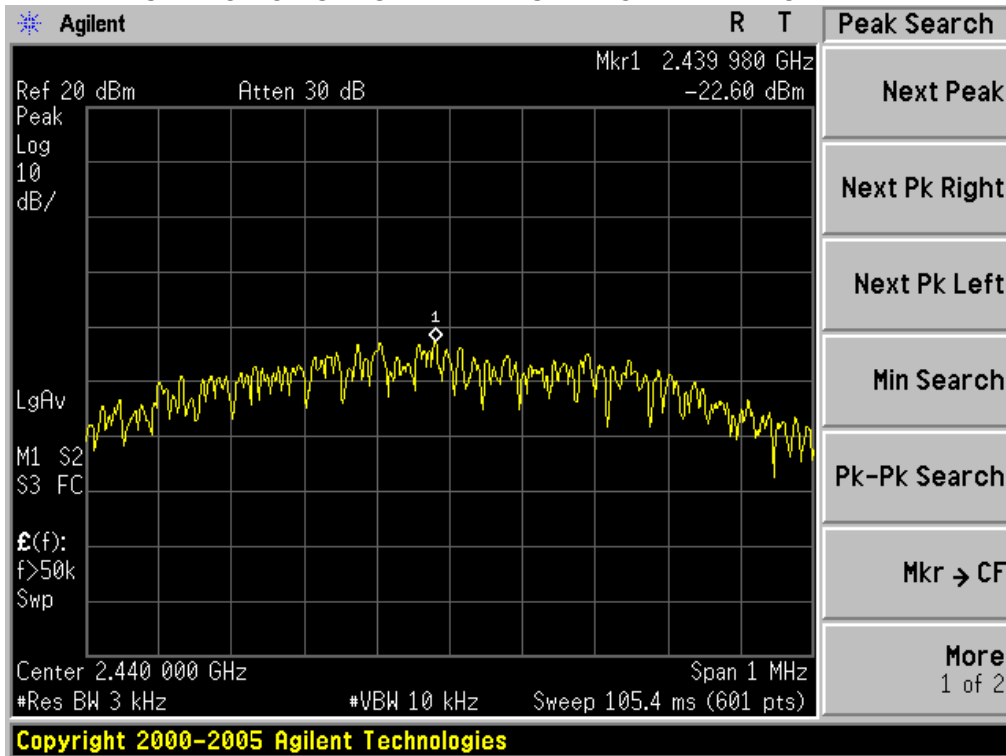

### TEST PLOT OF SPECTRAL DENSITY FOR HIGH CHANNEL

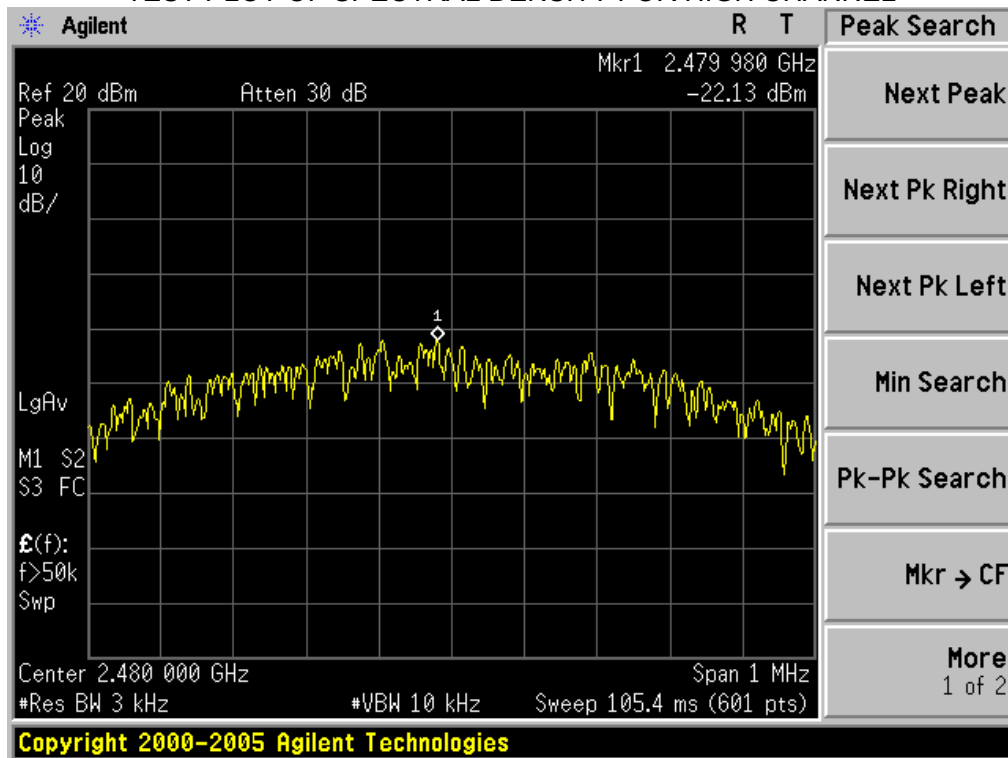

## 12. FCC LINE CONDUCTED EMISSION TEST

### 12.1 LIMITS

Frequency	Maximum RF Line Voltage	
	Q.P.( dBuV)	Average( dBuV)
150kHz~500kHz	66-56	56-46
500kHz~5MHz	56	46
5MHz~30MHz	60	50

**\*\*Note:** 1. The lower limit shall apply at the transition frequency.  
2. The limit decreases linearly with the logarithm of the frequency in the range 0.15 MHz to 0.50 MHz

### 12.2 TEST SETUP

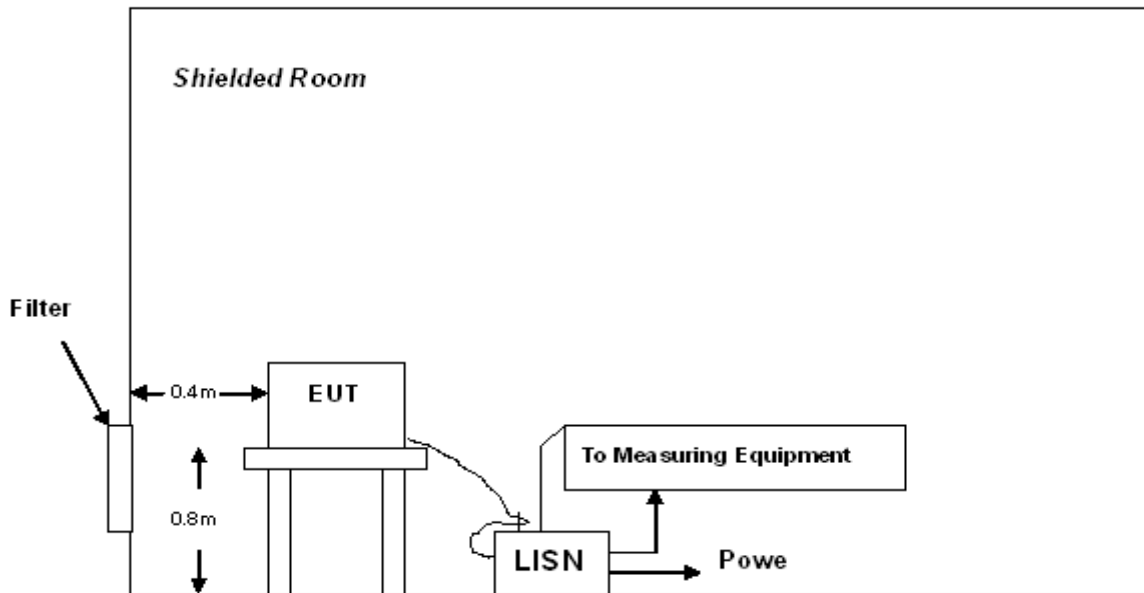

A: Powered through filter



### 12.3 PRELIMINARY PROCEDURE

- 1) The equipment was set up as per the test configuration to simulate typical actual usage per the user's manual. When the EUT is a tabletop system, a wooden table with a height of 0.8 meters is used and is placed on the ground plane as per ANSI C63.4 (see Test Facility for the dimensions of the ground plane used). When the EUT is a floor-standing equipment, it is placed on the ground plane which has a 3-12 mm non-conductive covering to insulate the EUT from the ground plane.
- 2) Support equipment, if needed, was placed as per ANSI C63.4.
- 3) All I/O cables were positioned to simulate typical actual usage as per ANSI C63.4.
- 4) All support equipments received AC120V/60Hz power from a LISN, if any.
- 5) The EUT received power by adapter which received power by a LISN.
- 6) The test program was started. Emissions were measured on each current carrying line of the EUT using a spectrum Analyzer / Receiver connected to the LISN powering the EUT. The LISN has two monitoring points: Line 1 (Hot Side) and Line 2 (Neutral Side). Two scans were taken: one with Line 1 connected to Analyzer / Receiver and Line 2 connected to a 50 ohm load; the second scan had Line 1 connected to a 50 ohm load and Line 2 connected to the Analyzer / Receiver.
- 7) Analyzer / Receiver scanned from 150 kHz to 30MHz for emissions in each of the test modes.
- 8) During the above scans, the emissions were maximized by cable manipulation.
- 9) The following test mode(s) were scanned during the preliminary test.  
Then, the EUT configuration and cable configuration of the above highest emission level were recorded for reference of final testing.

### 12.4 FINAL TEST PROCEDURE

- 10) EUT and support equipment was set up on the test bench as per step 2 of the preliminary test.
- 11) 2) A scan was taken on both power lines, Line 1 and Line 2, recording at least the six highest emissions. Emission frequency and amplitude were recorded into a computer in which correction factors were used to calculate the emission level and compare reading to the applicable limit. If EUT emission level was less -2dB to the A.V. limit in Peak mode, then the emission signal was re-checked using Q.P and Average detector.
- 12) 3) The test data of the worst case condition(s) was reported on the Summary Data page.

**12.5 TEST RESULT OF POWER LINE**  
N/A

## APPENDIX A: PHOTOGRAPHS OF TEST SETUP

### FCC RADIATED EMISSION TEST SETUP

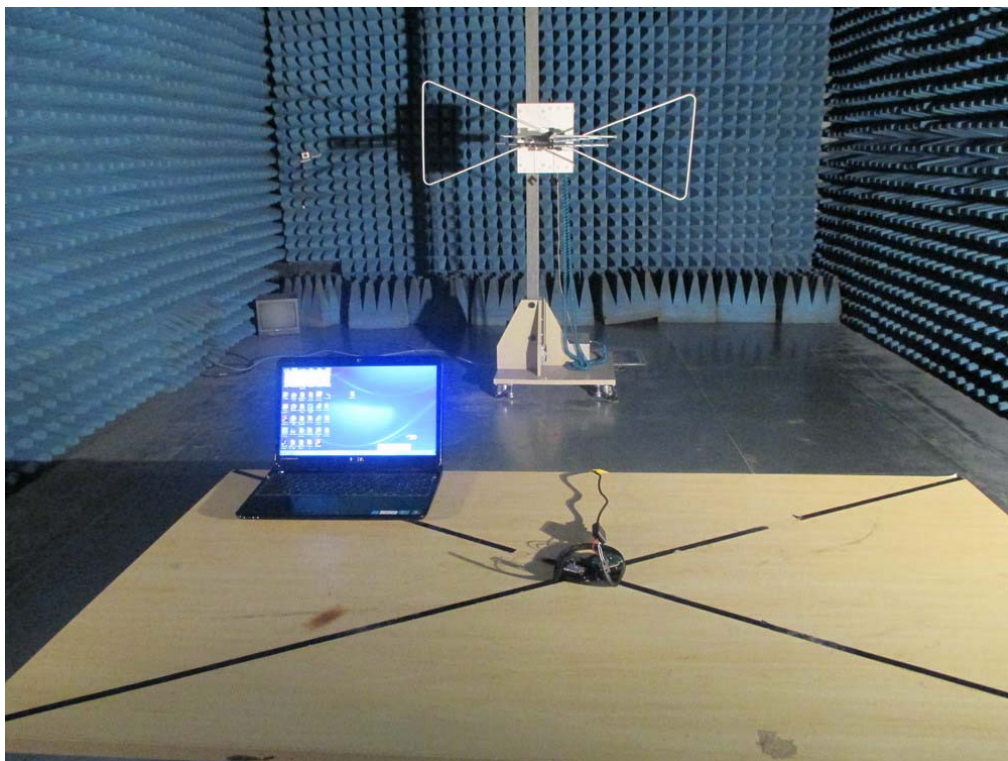
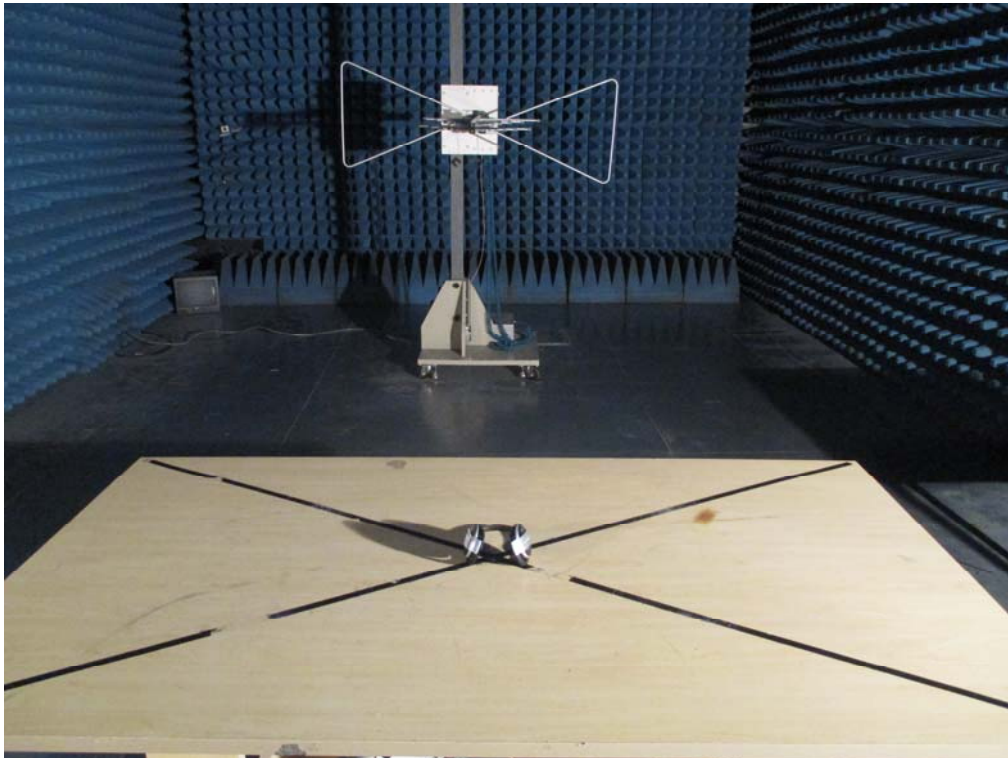

## APPENDIX B: PHOTOGRAPHS OF EUT

TOP VIEW OF EUT (EUT1)



BOTTOM VIEW OF EUT



FRONT VIEW OF EUT



BACK VIEW OF EUT



LEFT VIEW OF EUT



RIGHT VIEW OF EUT



OPEN VIEW OF EUT



OPEN VIEW OF EUT

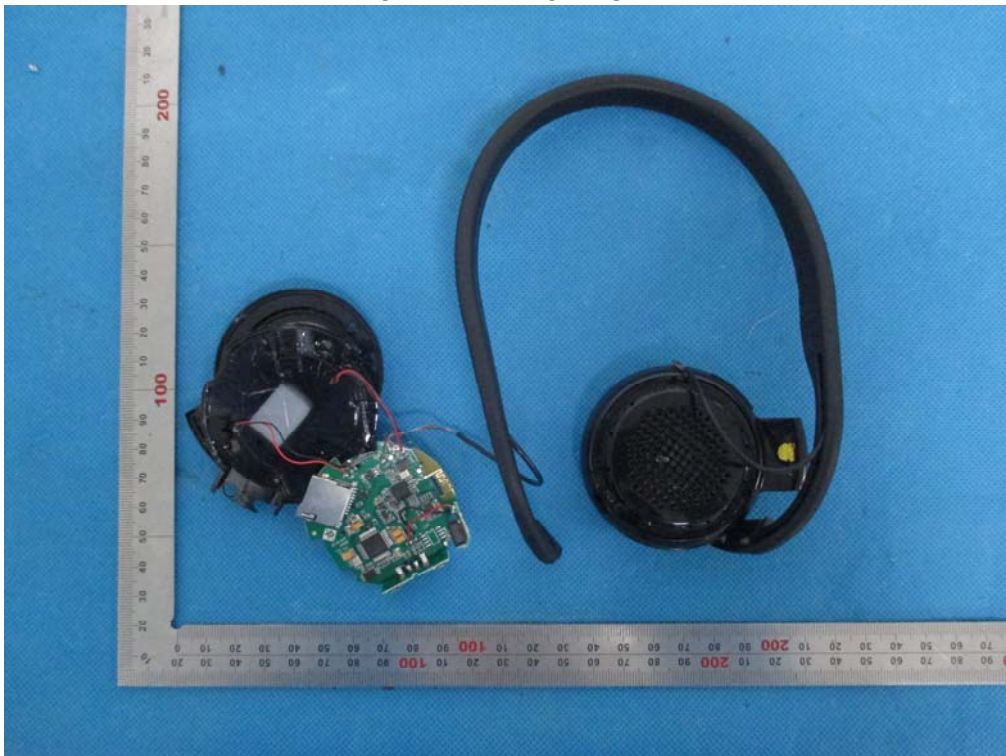

INTERNAL VIEW OF EUT

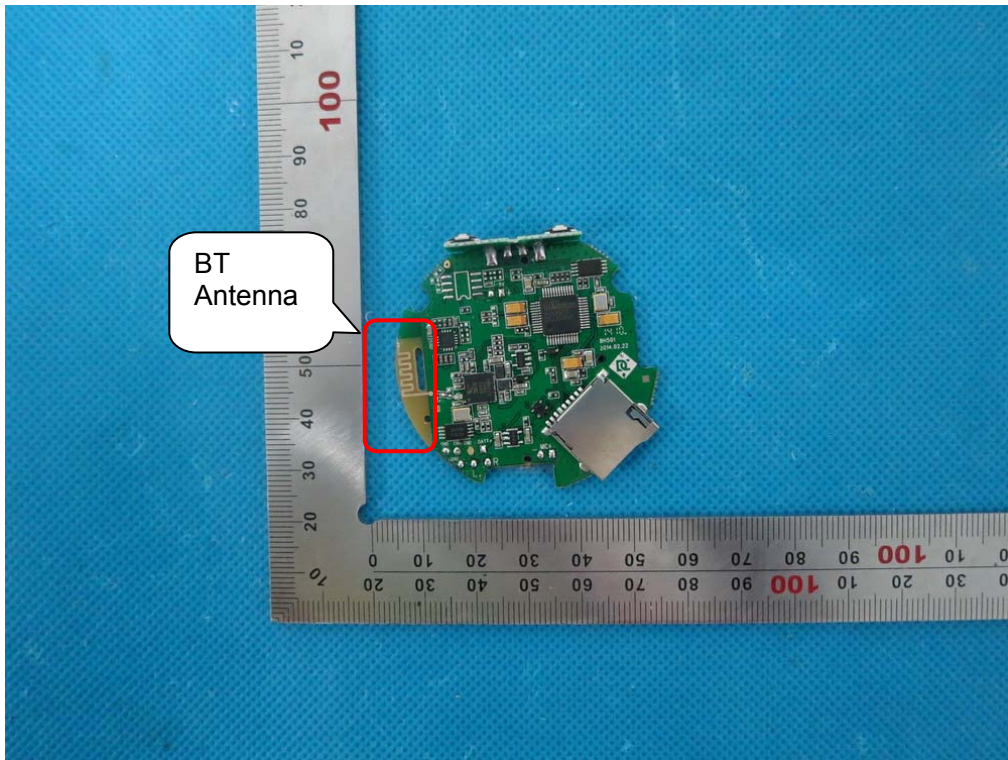

INTERNAL VIEW OF EUT

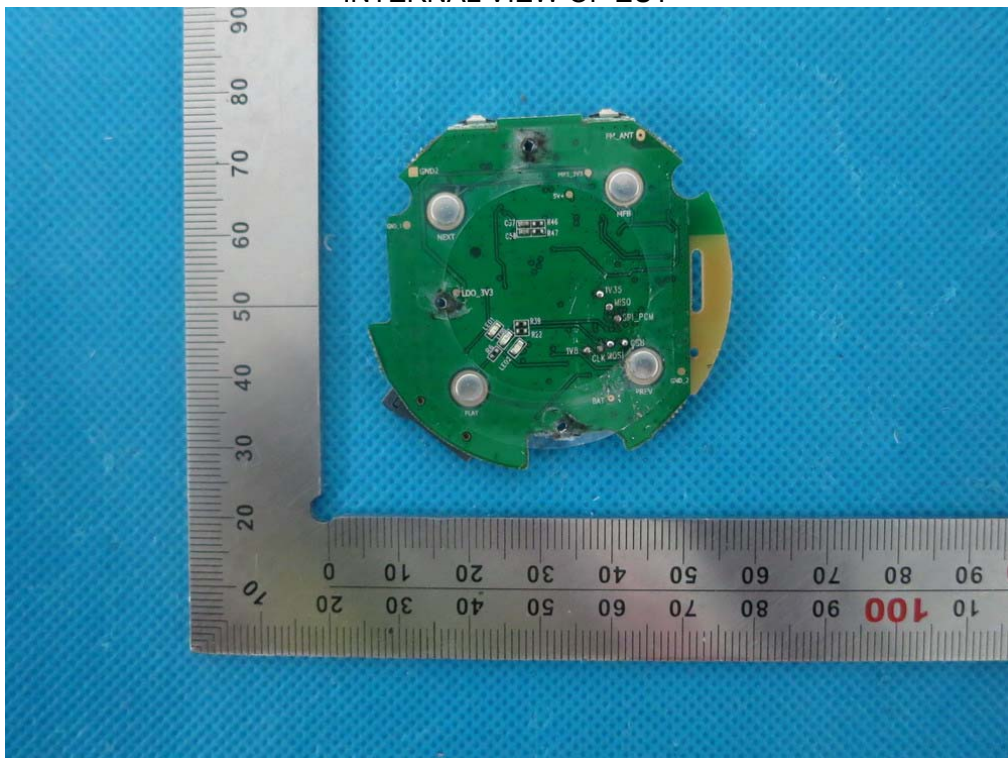



TOP VIEW OF EUT (EUT2)



BOTTOM VIEW OF EUT



FRONT VIEW OF EUT



BACK VIEW OF EUT



LEFT VIEW OF EUT



RIGHT VIEW OF EUT



OPEN VIEW OF EUT



OPEN VIEW OF EUT



INTERNAL VIEW OF EUT

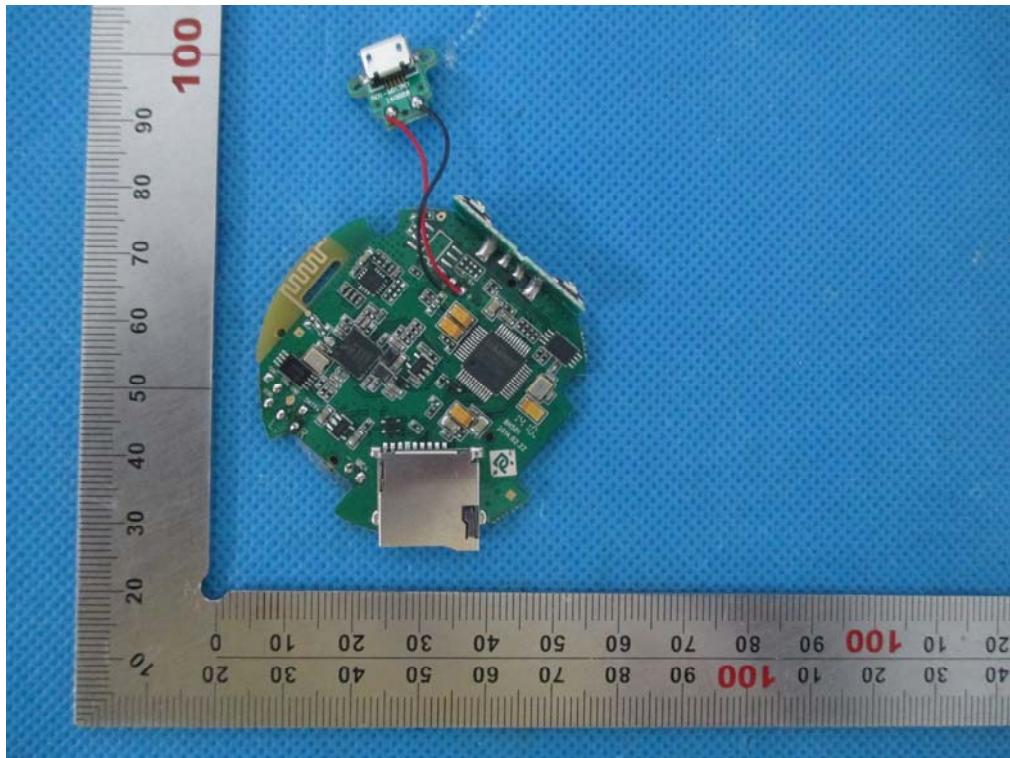

INTERNAL VIEW OF EUT



-----END OF REPORT-----