

---

# FCC Test Report

---

Report No.: AGC00019161001FE03

**FCC ID** : XELBC02  
**APPLICATION PURPOSE** : Original Equipment  
**PRODUCT DESIGNATION** : Bluetooth Headset  
**BRAND NAME** : ORiCORE  
**MODEL NAME** : BC02, BC01, BC03  
**CLIENT** : Shenzhen Hongnanke Communication Equipment Co., Ltd.  
**DATE OF ISSUE** : Nov.08, 2016  
**STANDARD(S)** : FCC Part 15 Rules  
**TEST PROCEDURE(S)**  
**REPORT VERSION** : V1.0

Attestation of Global Compliance (Shenzhen) Co., Ltd



**CAUTION:**

This report shall not be reproduced except in full without the written permission of the test laboratory and shall not be quoted out of context.



### Report Revise Record

Report Version	Revise Time	Issued Date	Valid Version	Notes
V1.0	/	Nov.08, 2016	Valid	Original Report

## TABLE OF CONTENTS

<b>1. VERIFICATION OF CONFORMITY .....</b>	<b>4</b>
<b>2. GENERAL INFORMATION .....</b>	<b>5</b>
2.1. PRODUCT DESCRIPTION .....	5
2.2. TABLE OF CARRIER FREQUENCYS .....	5
<b>3. MEASUREMENT UNCERTAINTY.....</b>	<b>6</b>
<b>4. DESCRIPTION OF TEST MODES.....</b>	<b>6</b>
<b>5. SYSTEM TEST CONFIGURATION .....</b>	<b>7</b>
5.1. CONFIGURATION OF EUT SYSTEM.....	7
5.2. EQUIPMENT USED IN EUT SYSTEM.....	7
5.3. SUMMARY OF TEST RESULTS.....	7
<b>6. TEST FACILITY .....</b>	<b>8</b>
<b>TEST METHODOLOGY.....</b>	<b>8</b>
<b>7. ALL TEST EQUIPMENT LIST .....</b>	<b>8</b>
<b>8. RADIATED EMISSION .....</b>	<b>10</b>
8.1TEST LIMIT.....	10
8.2. MEASUREMENT PROCEDURE.....	11
8.3. TEST SETUP.....	13
8.4. TEST RESULT .....	15
<b>9. BAND EDGE EMISSION .....</b>	<b>30</b>
9.1. MEASUREMENT PROCEDURE.....	30
9.2 TEST SETUP.....	30
9.3 RADIATED TEST RESULT .....	31
<b>10. 20DB BANDWIDTH.....</b>	<b>35</b>
10.1. MEASUREMENT PROCEDURE.....	35
10.2. TEST SET-UP.....	35
10.3. LIMITS AND MEASUREMENT RESULTS.....	35
<b>11. FCC LINE CONDUCTED EMISSION TEST .....</b>	<b>42</b>
11.1. LIMITS OF LINE CONDUCTED EMISSION TEST .....	42
11.2. BLOCK DIAGRAM OF LINE CONDUCTED EMISSION TEST .....	42
11.3. PRELIMINARY PROCEDURE OF LINE CONDUCTED EMISSION TEST .....	43
11.4. FINAL PROCEDURE OF LINE CONDUCTED EMISSION TEST .....	43
11.5. TEST RESULT OF LINE CONDUCTED EMISSION TEST .....	43
<b>APPENDIX A: PHOTOGRAPHS OF TEST SETUP .....</b>	<b>44</b>
<b>APPENDIX B: PHOTOGRAPHS OF EUT .....</b>	<b>45</b>

## 1. VERIFICATION OF CONFORMITY

<b>Applicant</b>	Shenzhen Hongnanke Communication Equipment Co., Ltd.
<b>Address</b>	No. 16, the Second Industry Park Xiakeng, Tongle, Longgang District, Shenzhen, Guangdong, China
<b>Manufacturer</b>	Shenzhen Hongnanke Communication Equipment Co., Ltd.
<b>Address</b>	No. 16, the Second Industry Park Xiakeng, Tongle, Longgang District, Shenzhen, Guangdong, China
<b>Product Designation</b>	Bluetooth Headset
<b>Brand Name</b>	ORiCORE
<b>Test Model</b>	BC02
<b>Series Model</b>	BC01, BC03
<b>Difference description</b>	All the same except for the car charger appearance structure and the headset appearance color
<b>Date of test</b>	Nov.02, 2016 to Nov.03, 2016
<b>Deviation</b>	None
<b>Condition of Test Sample</b>	Normal
<b>Report Template</b>	AGCRT-US-BR/RF

We hereby certify that:

The above equipment was tested by Dongguan Precise Testing Service Co., Ltd. The test data, the energy emitted by the sample tested as described in this report is in compliance with the requirements of FCC Rules Part 15.249.



Tested By \_\_\_\_\_  
Time Huang(Huang Nanhui)      Nov.07, 2016



Reviewed By \_\_\_\_\_  
Forrest Lei(Lei Yonggang)      Nov.08, 2016



Approved By \_\_\_\_\_  
Solger Zhang(Zhang Hongyi)  
Authorized Officer      Nov.08, 2016

## 2. GENERAL INFORMATION

### 2.1. PRODUCT DESCRIPTION

A major technical description of EUT is described as following

<b>Operation Frequency</b>	2.402 GHz to 2.480GHz
<b>RF Output Power</b>	2.62dBm
<b>Bluetooth Version</b>	V4.1
<b>Modulation</b>	GFSK ,π /4-DQPSK, 8DPSK
<b>Number of channels</b>	79
<b>Hardware Version</b>	The chip reports stack version 8648 (0x21c8): "dal_10compact_rom_bt4.0_dal_a04_1112061248_encr128 2011-12-06"
<b>Software Version</b>	BC01_8610_V02_160921
<b>Antenna Designation</b>	Ceramic Antenna
<b>Antenna Gain</b>	0dBi
<b>Power Supply (Headset)</b>	DC 3.7V
<b>Charging Voltage (By Car Charger)</b>	INPUT:DC 12V and DC 24V OUTPUT:5V~2.4A
Note: The EUT didn't support BLE.	

### 2.2. TABLE OF CARRIER FREQUENCIES

BR/EDR channel List

Frequency Band	Channel Number	Frequency
2400~2483.5MHZ	0	2402MHZ
	1	2403MHZ
	:	:
	38	2440 MHZ
	39	2441 MHZ
	40	2442 MHZ
	:	:
	77	2479 MHZ
	78	2480 MHZ

### 3. MEASUREMENT UNCERTAINTY

The reported uncertainty of measurement  $y \pm U$ , where expanded uncertainty  $U$  is based on a standard uncertainty multiplied by a coverage factor of  $k=2$ , providing a level of confidence of approximately 95 %.

No.	Item	Uncertainty
1	Conducted Emission Test	$\pm 3.18\text{dB}$
2	All emissions, radiated	$\pm 3.91\text{dB}$
3	Temperature	$\pm 0.5^\circ\text{C}$
4	Humidity	$\pm 2\%$

### 4. DESCRIPTION OF TEST MODES

NO.	TEST MODE DESCRIPTION
1	Low channel TX(GFSK)
2	Middle channel TX (GFSK)
3	High channel TX (GFSK)
4	Low channel TX( $\pi/4$ -DQPSK)
5	Middle channel TX( $\pi/4$ -DQPSK)
6	High channel TX ( $\pi/4$ -DQPSK)
7	Low channel TX(8DPSK)
8	Middle channel TX (8DPSK)
9	High channel TX (8DPSK)
10	BT Link

Note:

- All the test modes can be supply by battery, only the result of the worst case was recorded in the report, if no other cases.
- For Radiated Emission, 3axis were chosen for testing for each applicable mode.
- The EUT used fully-charged battery when tested.

## 5. SYSTEM TEST CONFIGURATION

### 5.1. CONFIGURATION OF EUT SYSTEM

Configure 1: (Normal hopping)

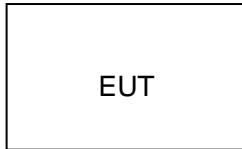

Configure 2: (Control continuous TX)

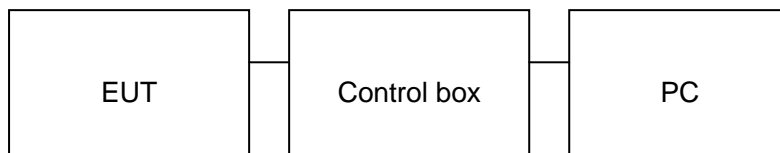

### 5.2. EQUIPMENT USED IN EUT SYSTEM

ITEM	EQUIPMENT	MFR/BRAND	MODEL/TYPE NO.	REMARK
1	Bluetooth Headset	ORICORE	BC02	EUT
2	Battery	JIN YU ZHOU	401214	Accessory
3	PC	Sony	E1412AYCW	A.E
4	Control box	CSR	USB_SPI_TOOLS	A.E

### 5.3. SUMMARY OF TEST RESULTS

FCC RULES	DESCRIPTION OF TEST	RESULT
§15.249	Radiated Emission	Compliant
§15.249	Band Edges	Compliant
§15.207	Conduction Emission	N/A
§15.215	Bandwidth	Compliant

**Note** : N/A means it's not applicable to this item.

## 6. TEST FACILITY

<b>Site</b>	Dongguan Precise Testing Service Co., Ltd.
<b>Location</b>	Building D, Baoding Technology Park, Guangming Road2, Dongcheng District, Dongguan, Guangdong, China,
<b>FCC Registration No.</b>	371540
<b>Description</b>	The test site is constructed and calibrated to meet the FCC requirements in documents ANSI C63.10:2013.

## TEST METHODOLOGY

All measurements contained in this report were conducted with ANSI C63.10-2013.

## 7. ALL TEST EQUIPMENT LIST

FOR RADIATED EMISSION TEST (BELOW 1GHZ)

Radiated Emission Test Site					
Name of Equipment	Manufacturer	Model Number	Serial Number	Last Calibration	Due Calibration
EMI Test Receiver	Rohde & Schwarz	ESCI	101417	July 4, 2016	July 3, 2017
Trilog Broadband Antenna (25M-1GHz)	SCHWARZBECK	VULB9160	9160-3355	July 4, 2016	July 3, 2017
Signal Amplifier	SCHWARZBECK	BBV 9475	9745-0013	July 4, 2016	July 3, 2017
RF Cable	SCHWARZBECK	AK9515E	96221	July 4, 2016	July 3, 2017
3m Anechoic Chamber	CHENGYU	966	PTS-001	June 6, 2016	June 5, 2017
MULTI-DEVICE Positioning Controller	Max-Full	MF-7802	MF780208339	N/A	N/A
Active loop antenna (9K-30MHz)	Schwarzbeck	FMZB1519	1519-038	June 6, 2016	June 5, 2017
Spectrum analyzer	Agilent	E4407B	MY46185649	June 6, 2016	June 5, 2017
Radiation Cable 1	MXT	RS1	R005	June 6, 2016	June 5, 2017
Radiation Cable 2	MXT	RS1	R006	June 6, 2016	June 5, 2017



## FOR RADIATED EMISSION TEST (1GHZ ABOVE)

<b>Radiated Emission Test Site</b>					
<b>Name of Equipment</b>	<b>Manufacturer</b>	<b>Model Number</b>	<b>Serial Number</b>	<b>Last Calibration</b>	<b>Due Calibration</b>
EMI Test Receiver	Rohde & Schwarz	ESCI	101417	July 4, 2016	July 3, 2017
Horn Antenna (1G-18GHz)	SCHWARZBECK	BBHA9120D	9120D-1246	July 11, 2016	July 10, 2017
Spectrum Analyzer	Agilent	E4411B	MY4511453	July 4, 2016	July 3, 2017
Signal Amplifier	SCHWARZBECK	BBV 9718	9718-269	July 4, 2016	July 3, 2017
RF Cable	SCHWARZBECK	AK9515H	96220	July 4, 2016	July 3, 2017
3m Anechoic Chamber	CHENGYU	966	PTS-001	June 6, 2016	June 5, 2017
MULTI-DEVICE Positioning Controller	Max-Full	MF-7802	MF780208339	N/A	N/A
Horn Ant (18G-40GHz)	Schwarzbeck	BBHA 9170	9170-181	June 6, 2016	June 5, 2017
Radiation Cable 1	MXT	RS1	R005	June 6, 2016	June 5, 2017
Radiation Cable 2	MXT	RS1	R006	June 6, 2016	June 5, 2017

## 8. RADIATED EMISSION

### 8.1 TEST LIMIT

#### Standard FCC15.249

Fundamental Frequency	Field Strength of Fundamental (millivolts/meter)	Field Strength of Harmonics (microvolts/meter)
900-928MHz	50	500
2400-2483.5MHz	50	500
5725-5875MHz	50	500
24.0-24.25GHz	250	2500

#### Standard FCC 15.209

Frequency (MHz)	Distance Meters	Field Strengths Limit	
		$\mu$ V/m	dB( $\mu$ V)/m
0.009 ~ 0.490	300	2400/F(kHz)	---
0.490 ~ 1.705	30	24000/F(kHz)	---
1.705 ~ 30	30	30	---
30 ~ 88	3	100	40.0
88 ~ 216	3	150	43.5
216 ~ 960	3	200	46.0
960 ~ 1000	3	500	54.0
Above 1000	3	Other:74.0 dB( $\mu$ V)/m (Peak) 54.0 dB( $\mu$ V)/m (Average)	

Remark: (1) Emission level dB $\mu$  V = 20 log Emission level  $\mu$  V/m  
(2) The smaller limit shall apply at the cross point between two frequency bands.  
(3) Distance is the distance in meters between the measuring instrument, antenna and the closest point of any part of the device or system.

## 8.2. MEASUREMENT PROCEDURE

1. The measuring distance of 3m shall be used for measurements. The EUT was placed on the top of a rotating table 0.8 meter above the ground at a 3 meter semi-anechoic chamber. The table was rotated 360 degrees to determine the position of the highest radiation(Below 1GHz)
2. The measuring distance of 3m shall used for measurements. The EUT was placed on the top of a rotating table 1.5 meter above the ground at a 3 meter semi-anechoic chamber. The table was rotated 360 degrees to determine the position of the highest radiation(Above 1GHz)
3. The height of the test antenna shall vary between 1m to 4m.Both horizontal and vertical polarization Of the antenna are set to make the measurement.
4. The initial step in collecting radiated emission data is a receive peak detector mode. Pre-scanning the measurement frequency range. Significant peaks are then marked and then Quasi Peak detector mode re-measured.
5. All readings are peak unless otherwise stated QP in column of Note. Peak denoted that the Peak reading compliance with the QP limits and then QP Mode measurement didn't perform(Below 1GHz)
6. All readings are Peak mode value unless otherwise stated AVG in column of Note. If the Peak mode measured value compliance with the Peak limits and lower than AVG Limits, the EUT shall be deemed to meet Peak & AVG limits and then only Peak mode was measured, but AVG mode didn't perform.(Above 1GHz)

The following table is the setting of spectrum analyzer and receiver.

<b>Spectrum Parameter</b>	<b>Setting</b>
Start ~Stop Frequency	9KHz~150KHz/RB 200Hz for QP
Start ~Stop Frequency	150KHz~30MHz/RB 9KHz for QP
Start ~Stop Frequency	30MHz~1000MHz/RB 120KHz for QP
Start ~Stop Frequency	1GHz~26.5GHz 1MHz/3MHz for Peak, 1MHz/10Hz for Average
<b>Receiver Parameter</b>	<b>Setting</b>
Start ~Stop Frequency	9KHz~150KHz/RB 200Hz for QP
Start ~Stop Frequency	150KHz~30MHz/RB 9KHz for QP
Start ~Stop Frequency	30MHz~1000MHz/RB 120KHz for QP

### 8.3. TEST SETUP

Radiated Emission Test-Setup Frequency Below 30MHz

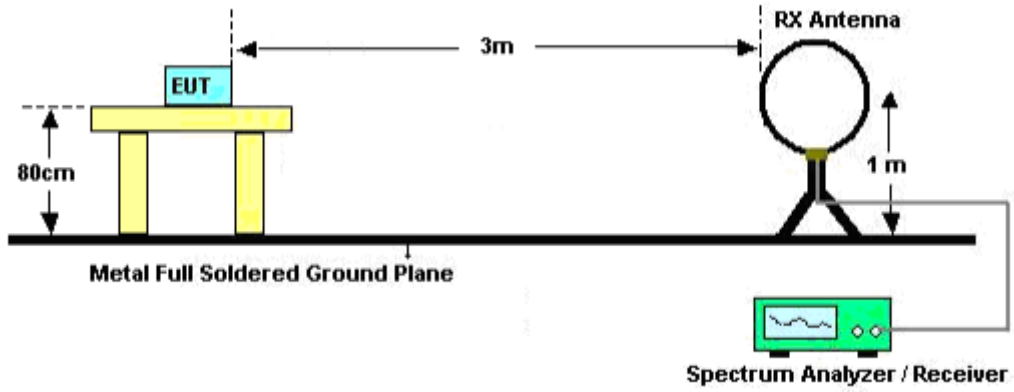

RADIATED EMISSION TEST SETUP 30MHz-1000MHz

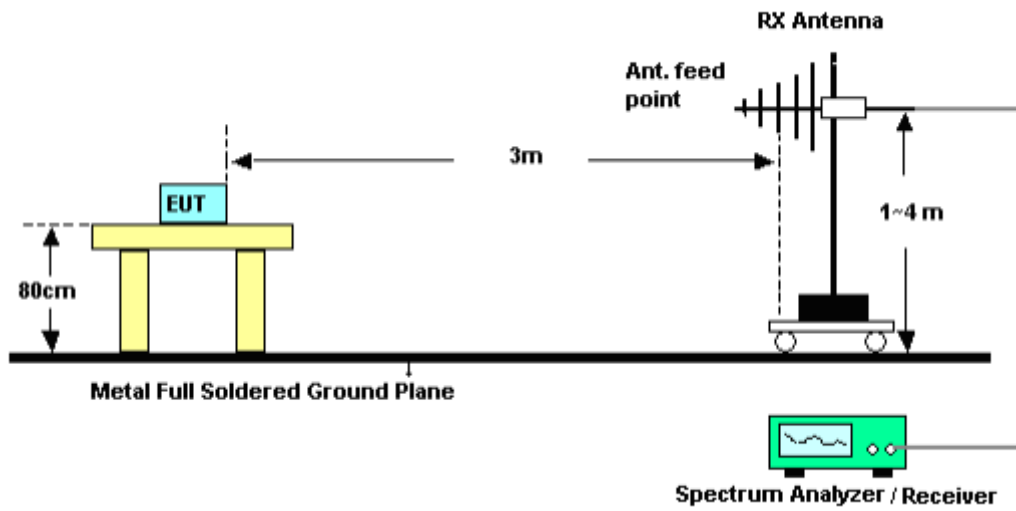

### RADIATED EMISSION TEST SETUP ABOVE 1000MHz

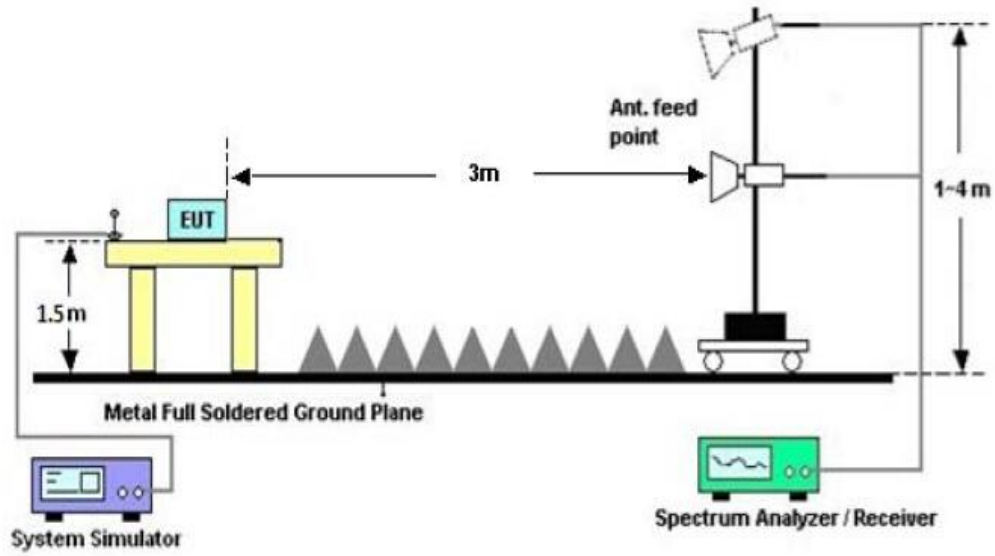

**8.4. TEST RESULT** (Worst modulation: GFSK)

**RADIATED EMISSION BELOW 30MHZ**

No emission found between lowest internal used/generated frequencies to 30MHz.

**RADIATED EMISSION BELOW 1GHZ**

**RADIATED EMISSION TEST- (30MHZ-1GHZ)-LOW CHANNEL-HORIZONTAL**

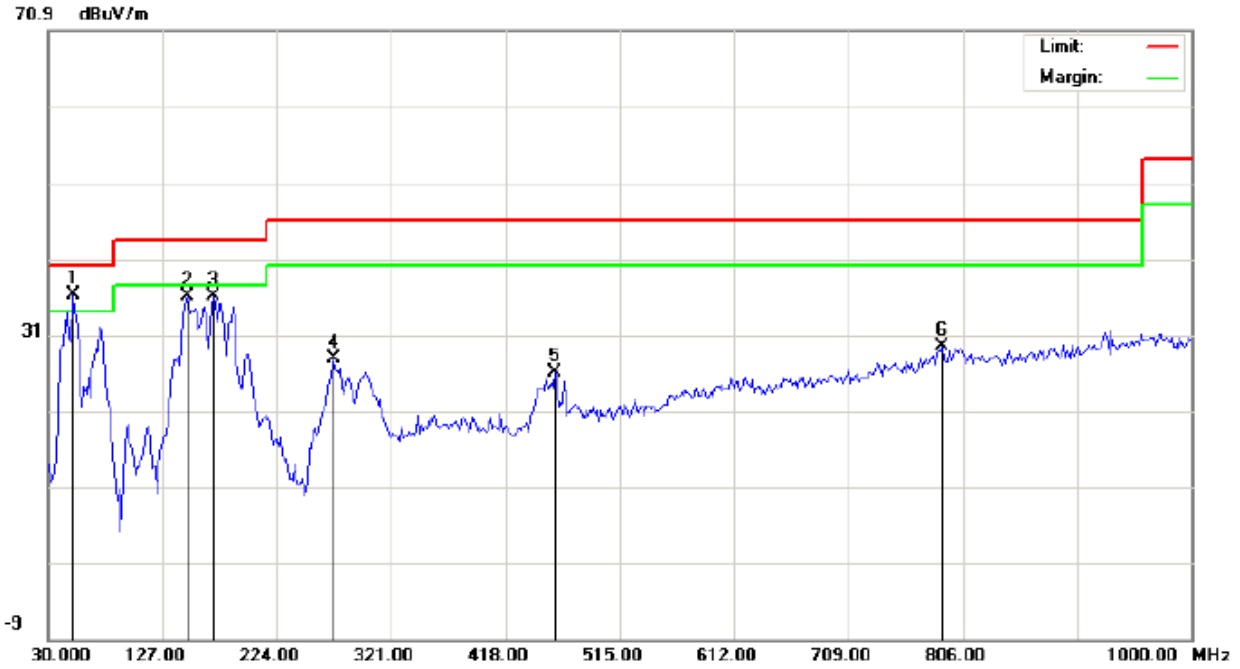

Site: site #1  
 Limit: FCC Class B 3M Radiation  
 EUT: Bluetooth Headset  
 M/N: BC02  
 Mode: Low Channel TX  
 Note:

Polarization: *Horizontal*  
 Power:  
 Distance:

Temperature: 24.6  
 Humidity: 57.8 %

No.	Mk	Freq.	Reading	Factor	Measurement	Limit	Over	Detector	Antenna	Table	Comment
		MHz	dBuV	dB/m	dBuV/m	dBuV/m	dB		Height	Degree	
									cm	degree	
1	*	51.0167	26.01	10.15	36.16	40.00	-3.84	peak			
2		148.0166	22.75	13.25	36.00	43.50	-7.50	peak			
3		170.6500	25.35	10.72	36.07	43.50	-7.43	peak			
4		272.5000	17.17	10.73	27.90	46.00	-18.10	peak			
5		460.0333	5.38	20.70	26.08	46.00	-19.92	peak			
6		788.2166	2.18	27.16	29.34	46.00	-16.66	peak			

**RESULT: PASS**

RADIATED EMISSION TEST- (30MHZ-1GHZ)-LOW CHANNEL -VERTICAL

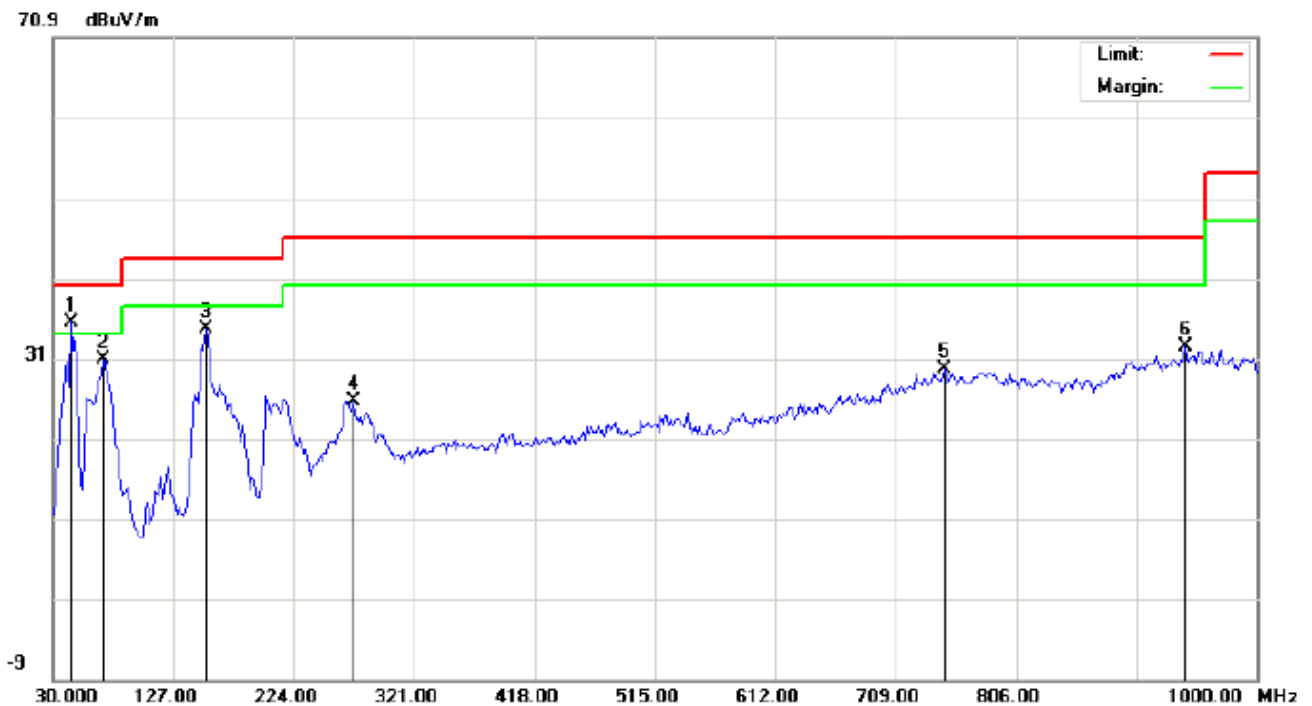

Site: site #1  
 Limit: FCC Class B 3M Radiation  
 EUT: Bluetooth Headset  
 M/N: BC02  
 Mode: Low Channel TX  
 Note:

Polarization: **Vertical**  
 Power:  
 Distance:

Temperature: 24.6  
 Humidity: 57.8 %

No.	Mk	Freq.	Reading	Factor	Measurement	Limit	Over	Detector	Antenna Height	Table Degree	Comment
		MHz	dBuV	dB/m	dBuV/m	dBuV/m	dB		cm	degree	
1	*	44.5500	26.90	8.60	35.50	40.00	-4.50	peak			
2		70.4167	26.65	4.16	30.81	40.00	-9.19	peak			
3		152.8667	19.28	15.28	34.56	43.50	-8.94	peak			
4		272.5000	11.07	14.58	25.65	46.00	-20.35	peak			
5		747.8000	3.08	26.57	29.65	46.00	-16.35	peak			
6		941.8000	2.55	29.77	32.32	46.00	-13.68	peak			

**RESULT: PASS**

**Note:** 1. Factor=Antenna Factor + Cable loss, Margin=Measurement-Limit.

2. The "Factor" value can be calculated automatically by software of measurement system.



RADIATED EMISSION TEST- (30MHZ-1GHZ)-MIDDLE CHANNEL-HORIZONTAL

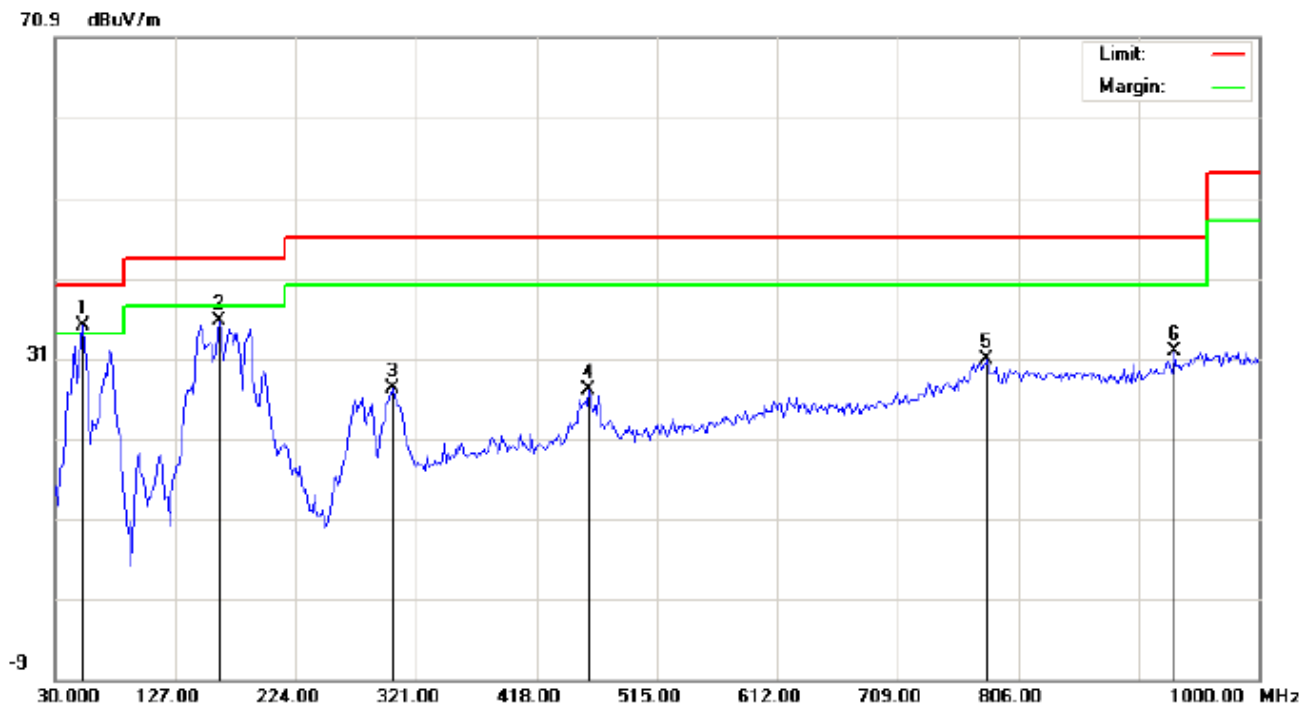

Site: site #1  
Limit: FCC Class B 3M Radiation  
EUT: Bluetooth Headset  
M/N: BC02  
Mode: Middle Channel TX  
Note:

Polarization: *Horizontal*  
Power:  
Distance:

Temperature: 24.6  
Humidity: 57.8 %

No.	Mk	Freq.	Reading	Factor	Measurement	Limit	Over	Detector	Antenna Height	Table Degree	Comment
		MHz	dBuV	dB/m	dBuV/m	dBuV/m	dB		cm	degree	
1	*	52.6333	26.57	8.41	34.98	40.00	-5.02	peak			
2		162.5667	25.20	10.42	35.62	43.50	-7.88	peak			
3		301.6000	11.72	15.52	27.24	46.00	-18.76	peak			
4		460.0333	6.38	20.70	27.08	46.00	-18.92	peak			
5		780.1333	3.74	27.05	30.79	46.00	-15.21	peak			
6		932.1000	2.34	29.50	31.84	46.00	-14.16	peak			

**RESULT: PASS**



RADIATED EMISSION TEST- (30MHZ-1GHZ)-HIGH CHANNEL-HORIZONTAL

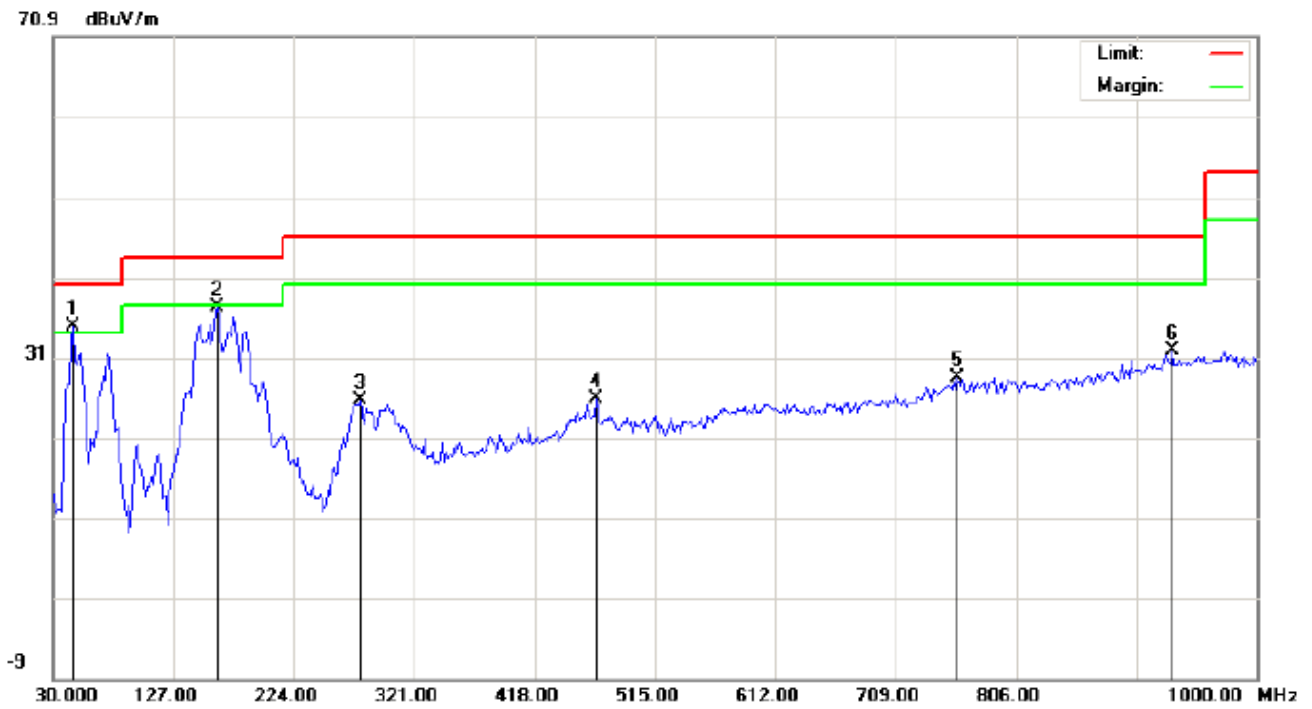

Site: site #1  
Limit: FCC Class B 3M Radiation  
EUT: Bluetooth Headset  
M/N: BC02  
Mode: High Channel TX  
Note:

Polarization: *Horizontal*  
Power:  
Distance:

Temperature: 24.6  
Humidity: 57.8 %

No.	Mk	Freq.	Reading	Factor	Measurement	Limit	Over	Detector	Antenna Height	Table Degree	Comment
		MHz	dBuV	dB/m	dBuV/m	dBuV/m	dB		cm	degree	
1	*	46.1667	23.35	11.49	34.84	40.00	-5.16	peak			
2		162.5667	26.70	10.42	37.12	43.50	-6.38	peak			
3		277.3500	14.00	11.55	25.55	46.00	-20.45	peak			
4		468.1167	5.00	20.79	25.79	46.00	-20.21	peak			
5		759.1167	1.74	26.76	28.50	46.00	-17.50	peak			
6		932.1000	2.34	29.50	31.84	46.00	-14.16	peak			

**RESULT: PASS**

RADIATED EMISSION TEST- (30MHZ-1GHZ)-HIGH CHANNEL -VERTICAL

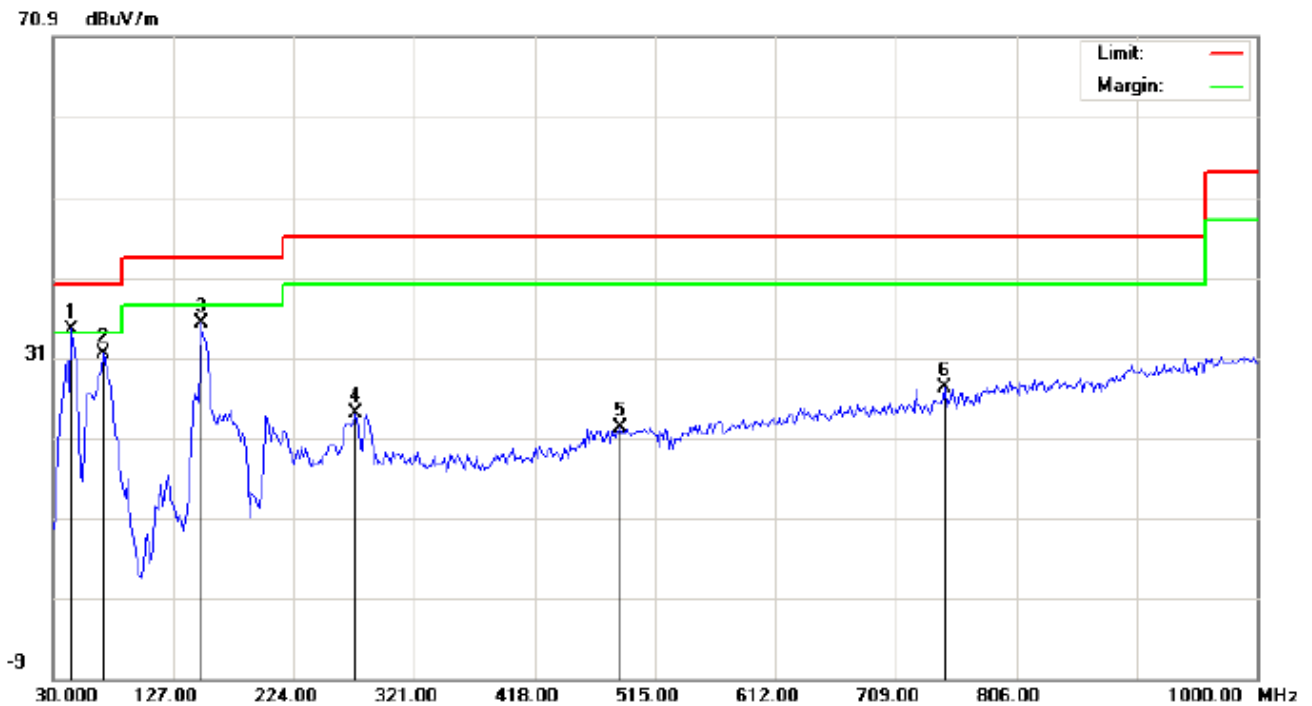

Site: site #1  
Limit: FCC Class B 3M Radiation  
EUT: Bluetooth Headset  
M/N: BC02  
Mode: High Channel TX  
Note:

Polarization: **Vertical**  
Power:  
Distance:

Temperature: 24.6  
Humidity: 57.8 %

No.	Mk	Freq.	Reading	Factor	Measurement	Limit	Over	Detector	Antenna Height	Table Degree	Comment
		MHz	dBuV	dB/m	dBuV/m	dBuV/m	dB		cm	degree	
1	*	44.5500	25.90	8.60	34.50	40.00	-5.50	peak			
2		70.4167	27.15	4.16	31.31	40.00	-8.69	peak			
3		149.6333	19.91	15.26	35.17	43.50	-8.33	peak			
4		274.1167	9.41	14.63	24.04	46.00	-21.96	peak			
5		487.5167	1.24	21.00	22.24	46.00	-23.76	peak			
6		747.8000	0.58	26.57	27.15	46.00	-18.85	peak			

**RESULT: PASS**

**Note:** 1. Factor=Antenna Factor + Cable loss, Margin=Measurement-Limit.

2. The "Factor" value can be calculated automatically by software of measurement system.

**RADIATED EMISSION ABOVE 1GHZ**  
**(Worst modulation: GFSK)**  
**FOR BR/EDR**

**RADIATED EMISSION TEST- (ABOVE 1GHZ)-LOW CHANNEL-HORIZONTAL**

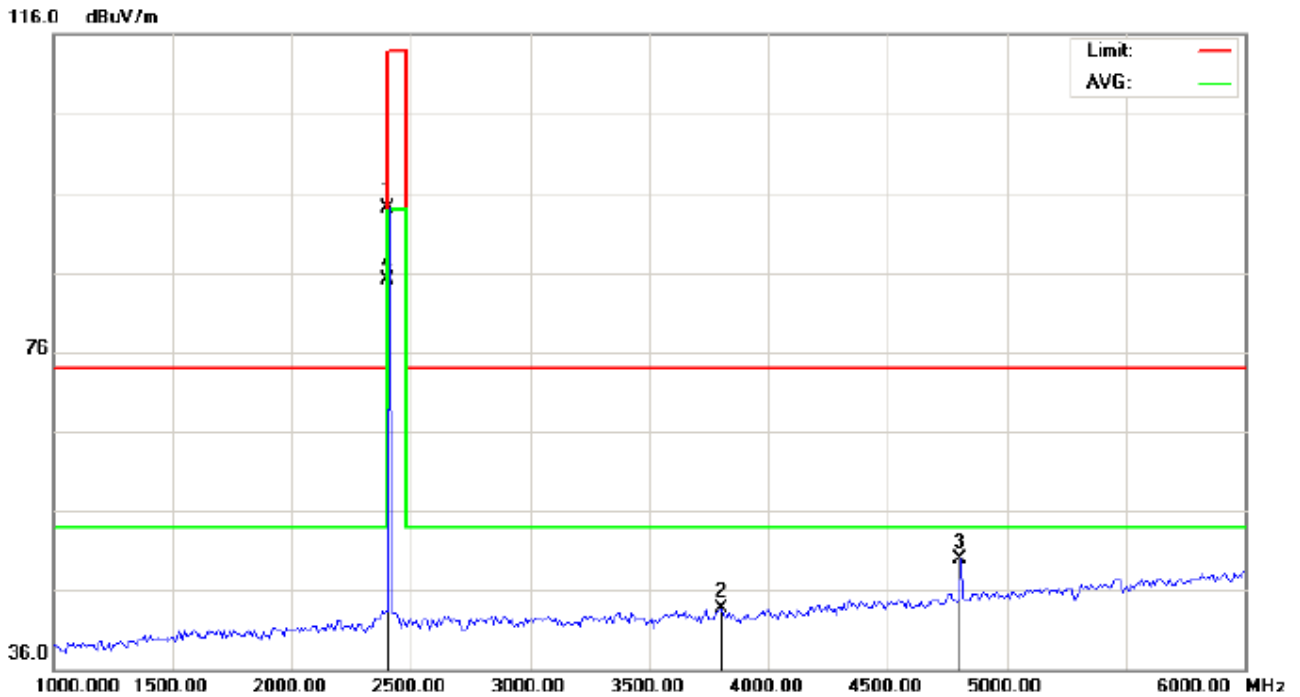

Site: site #1 Polarization: *Horizontal* Temperature: 22.7  
Limit: FCC Class B 3M Radiation above 1GHZ(PK)- Power: Humidity: 53.6 %  
EUT: Bluetooth Headset Distance:  
M/N: BC02  
Mode: Low Channel TX  
Note:

No.	Mk	Freq.	Reading	Factor	Measurement	Limit	Over	Detector	Antenna	Table	Comment
		MHz	dBuV	dB/m	dBuV/m	dBuV/m	dB		Height	Degree	
1		2402.000	83.73	10.32	94.05	114.00	-19.95	peak			
2		3800.000	29.74	13.96	43.70	74.00	-30.30	peak			
3		4804.000	42.24	7.69	49.93	74.00	-24.07	peak			
4	*	2402.000	74.82	10.32	85.14	94.00	-8.86	AVG	100	109	

**RESULT: PASS**



RADIATED EMISSION TEST- (ABOVE 1GHZ)-MIDDLE CHANNEL-HORIZONTAL

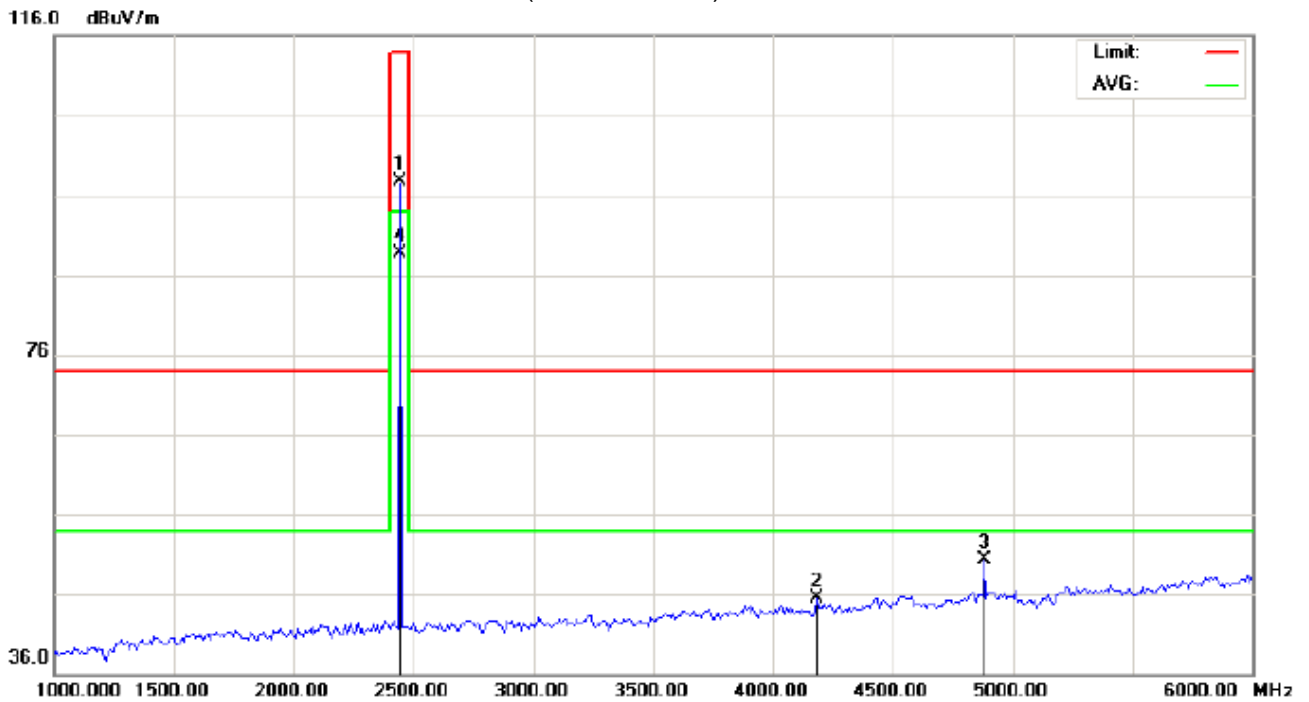

Site: site #1 Polarization: *Horizontal* Temperature: 22.7  
 Limit: FCC Class B 3M Radiation above 1GHZ(PK)- Power: Humidity: 53.6 %  
 EUT: Bluetooth Headset Distance:  
 M/N: BC02  
 Mode: Middle Channel TX  
 Note:

No.	Mk	Freq.	Reading	Factor	Measurement	Limit	Over	Detector	Antenna Height	Table Degree	Comment
		MHz	dBuV	dB/m	dBuV/m	dBuV/m	dB		cm	degree	
1		2441.000	87.27	10.36	97.63	114.00	-16.37	peak			
2		4183.333	33.29	12.15	45.44	74.00	-28.56	peak			
3		4882.000	42.38	7.89	50.27	74.00	-23.73	peak			
4	*	2441.000	78.38	10.36	88.74	94.00	-5.26	AVG	100	113	

**RESULT: PASS**

RADIATED EMISSION TEST- (ABOVE 1GHZ)-MIDDLE CHANNEL- VERTICAL

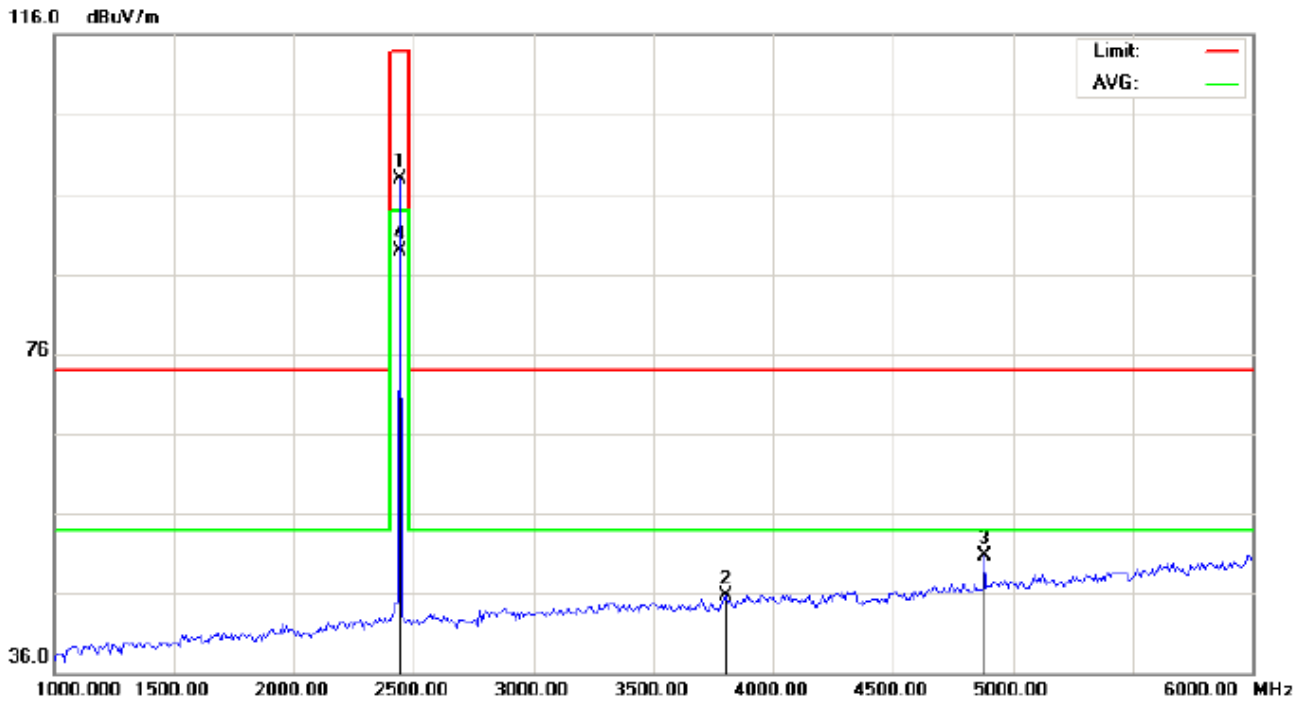

Site: site #1  
 Limit: FCC Class B 3M Radiation above 1GHZ(PK)-  
 EUT: Bluetooth Headset  
 M/N: BC02  
 Mode: Middle Channel TX  
 Note:

Polarization: *Vertical*  
 Power:  
 Distance:

Temperature: 22.7  
 Humidity: 53.6 %

No.	Mk	Freq.	Reading	Factor	Measurement	Limit	Over	Detector	Antenna	Table	Comment
		MHz	dBuV	dB/m	dBuV/m	dBuV/m	dB		Height	Degree	
									cm	degree	
1		2441.000	87.45	10.36	97.81	114.00	-16.19	peak			
2		3800.000	31.77	13.96	45.73	74.00	-28.27	peak			
3		4882.000	42.81	7.89	50.70	74.00	-23.30	peak			
4	*	2441.000	78.60	10.36	88.96	94.00	-5.04	AVG	100	296	

**RESULT: PASS**







**Field strength of the fundamental signal****1Mbps Result:****Peak value**

Frequency	Reading Level	Factor	Measurement	Limit	Over	Antenna
(MHz)	(dBuv)	(dB/m)	(dBuv/m)	(dBuv/m)	(dB)	Polarization
2402	83.73	10.32	94.05	114	-19.95	Horizontal
2402	83.80	10.32	94.12	114	-19.88	Vertical
2441	87.27	10.36	97.63	114	-16.37	Horizontal
2441	87.45	10.36	97.81	114	-16.19	Vertical
2480	86.50	10.41	96.91	114	-17.09	Horizontal
2480	86.71	10.41	97.12	114	-16.88	Vertical

**Average value**

Frequency	Reading Level	Factor	Measurement	Limit	Over	Antenna
(MHz)	(dBuv)	(dB/m)	(dBuv/m)	(dBuv/m)	(dB)	Polarization
2402	74.82	10.32	85.14	94	-8.86	Horizontal
2402	74.99	10.32	85.31	94	-8.69	Vertical
2441	78.38	10.36	88.74	94	-5.26	Horizontal
2441	78.60	10.36	88.96	94	-5.04	Vertical
2480	77.82	10.41	88.23	94	-5.77	Horizontal
2480	78.04	10.41	88.45	94	-5.55	Vertical

**2Mbps Result:****Peak value**

Frequency	Reading Level	Factor	Measurement	Limit	Over	Antenna
(MHz)	(dBuv)	(dB/m)	(dBuv/m)	(dBuv/m)	(dB)	Polarization
2402	83.55	10.32	93.87	114	-20.13	Horizontal
2402	83.44	10.32	93.76	114	-20.24	Vertical
2441	87.26	10.36	97.62	114	-16.38	Horizontal
2441	87.15	10.36	97.51	114	-16.49	Vertical
2480	86.48	10.41	96.89	114	-17.11	Horizontal
2480	86.34	10.41	96.75	114	-17.25	Vertical

**Average value**

Frequency	Reading Level	Factor	Measurement	Limit	Over	Antenna
(MHz)	(dBuv)	(dB/m)	(dBuv/m)	(dBuv/m)	(dB)	Polarization
2402	74.80	10.32	85.12	94	-8.88	Horizontal
2402	74.69	10.32	85.01	94	-8.99	Vertical
2441	78.43	10.36	88.79	94	-5.21	Horizontal
2441	78.31	10.36	88.67	94	-5.33	Vertical
2480	77.86	10.41	88.27	94	-5.73	Horizontal
2480	77.73	10.41	88.14	94	-5.86	Vertical

**3Mbps Result:****Peak value**

Frequency	Reading Level	Factor	Measurement	Limit	Over	Antenna
(MHz)	(dBuv)	(dB/m)	(dBuv/m)	(dBuv/m)	(dB)	Polarization
2402	83.32	10.32	93.64	114	-20.36	Horizontal
2402	83.19	10.32	93.51	114	-20.49	Vertical
2441	86.99	10.36	97.35	114	-16.65	Horizontal
2441	86.88	10.36	97.24	114	-16.76	Vertical
2480	86.17	10.41	96.58	114	-17.42	Horizontal
2480	86.04	10.41	96.45	114	-17.55	Vertical

**Average value**

Frequency	Reading Level	Factor	Measurement	Limit	Over	Antenna
(MHz)	(dBuv)	(dB/m)	(dBuv/m)	(dBuv/m)	(dB)	Polarization
2402	74.55	10.32	84.87	94	-9.13	Horizontal
2402	74.44	10.32	84.76	94	-9.24	Vertical
2441	78.10	10.36	88.46	94	-5.54	Horizontal
2441	77.95	10.36	88.31	94	-5.69	Vertical
2480	77.61	10.41	88.02	94	-5.98	Horizontal
2480	77.48	10.41	87.89	94	-6.11	Vertical

## 9. BAND EDGE EMISSION

### 9.1. MEASUREMENT PROCEDURE

1. The EUT operates at hopping-off test mode. The lowest or highest channels are tested to verify the largest transmission and spurious emissions power at the continuous transmission mode.
2. Max hold the trace of the setup1, and the EUT operates at hopping-on test mode to verify the largest spurious emissions power.
3. Set the spectrum analyzer in the following setting in order to capture the lower and upper band-edges of the emission

### 9.2 TEST SETUP

RADIATED EMISSION TEST SETUP

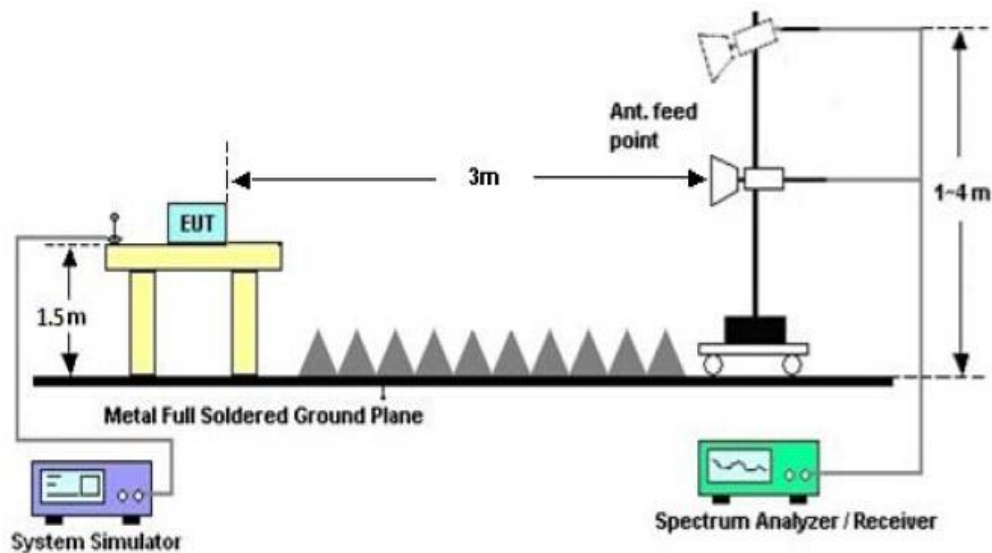







TEST PLOT OF BAND EDGE FOR HIGH CHANNEL -Horizontal

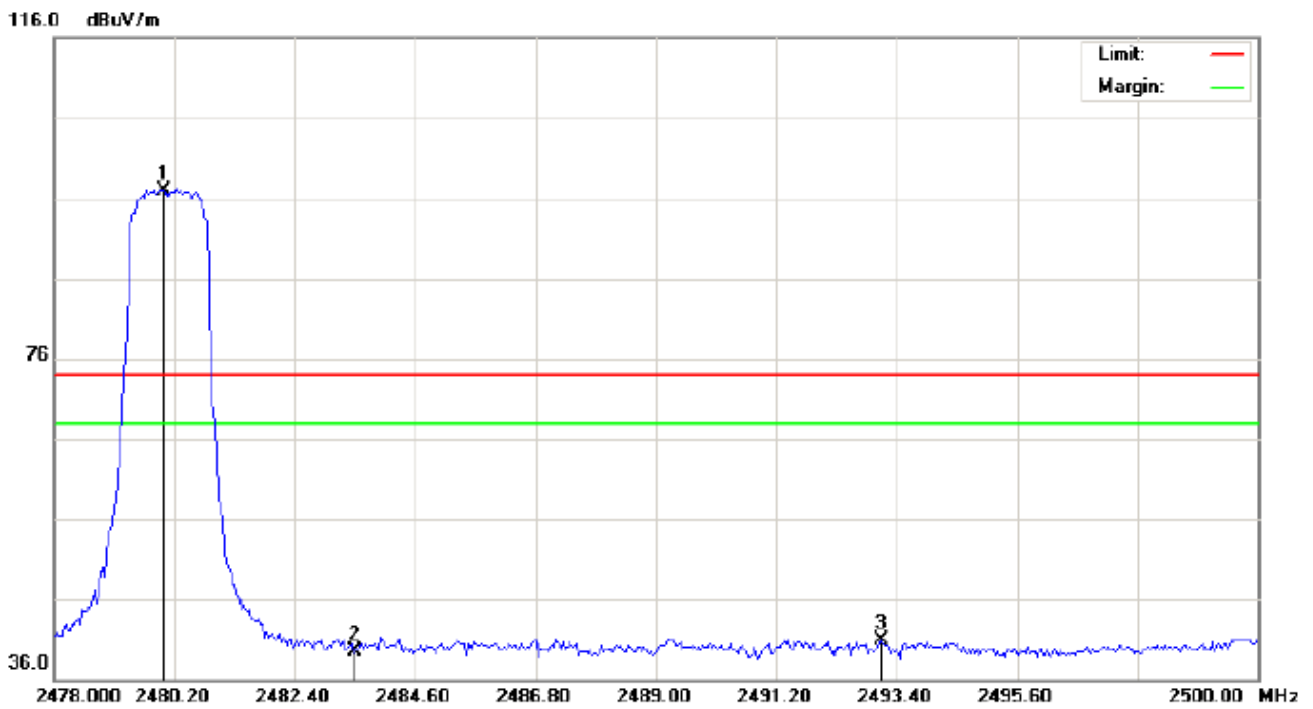

Site: site #1 Polarization: *Horizontal* Temperature: 26  
 Limit: FCC Class B 3M Radiation above 1GHZ(PK) Power: Humidity: 60 %  
 EUT: Bluetooth Headset Distance:  
 M/N: BC02  
 Mode: High Channel TX  
 Note:

No.	Mk	Freq.	Reading	Factor	Measurement	Limit	Over	Detector	Antenna Height	Table Degree	Comment
		MHz	dBuV	dB/m	dBuV/m	dBuV/m	dB		cm	degree	
1	*	2480.000	86.55	10.41	96.96	74.00	22.96	peak			
2		2483.500	29.19	10.41	39.60	74.00	-34.40	peak			
3		2493.107	30.54	10.42	40.96	74.00	-33.04	peak			



## 10. 20DB BANDWIDTH

### 10.1. MEASUREMENT PROCEDURE

1. Connect EUT RF output port to the Spectrum Analyzer through an RF attenuator
2. Set the EUT Work on the top, the middle and the bottom operation frequency individually.
3. Set Span = approximately 2 to 3 times the 20 dB bandwidth, centered on a hoping channel  
RBW  $\geq$  1% of the 20 dB bandwidth, VBW  $\geq$  RBW; Sweep = auto; Detector function = peak
4. Set SPA Trace 1 Max hold, then View.

### 10.2. TEST SET-UP

(BLOCK DIAGRAM OF CONFIGURATION)

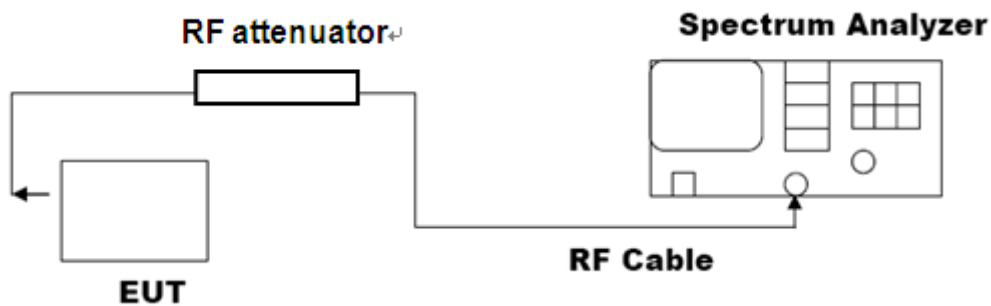

Note: The EUT has been used temporary antenna connector for testing.

### 10.3. LIMITS AND MEASUREMENT RESULTS

FOR BR/EDR

BLUETOOTH 1MBPS LIMITS AND MEASUREMENT RESULT				
Applicable Limits	Measurement Result			
	Test Data (MHz)			Result
		99%OBW (MHz)	-20dB BW(MHz)	
N/A	Low Channel	0.932	1.096	PASS
	Middle Channel	0.931	1.097	PASS
	High Channel	0.936	1.097	PASS

TEST PLOT OF BANDWIDTH FOR LOW CHANNEL

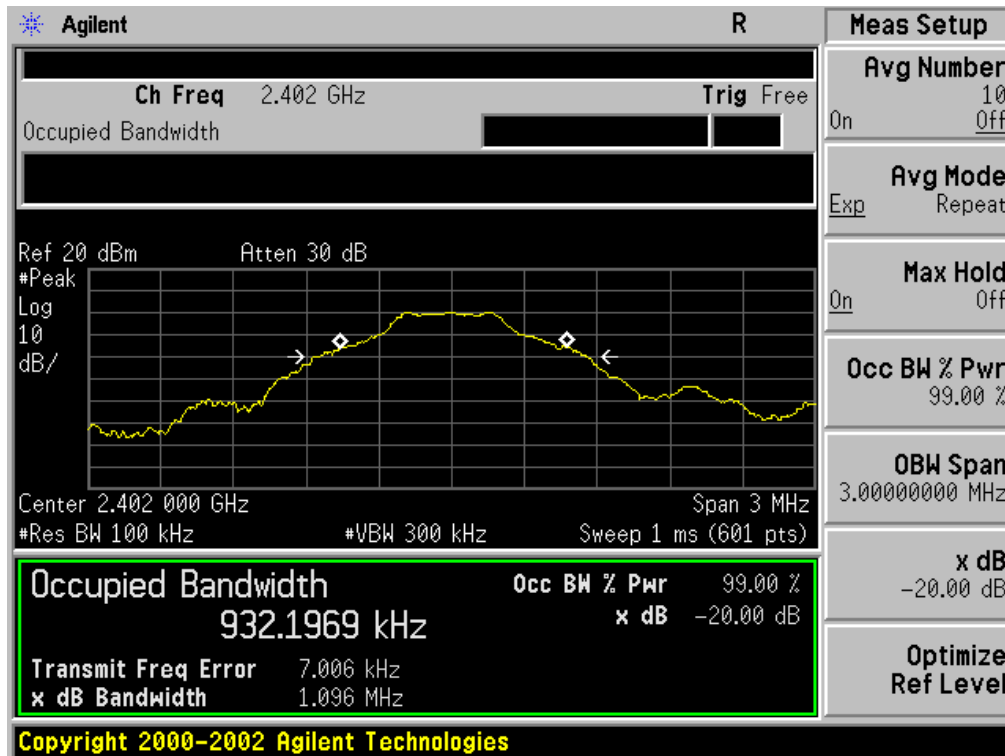

TEST PLOT OF BANDWIDTH FOR MIDDLE CHANNEL

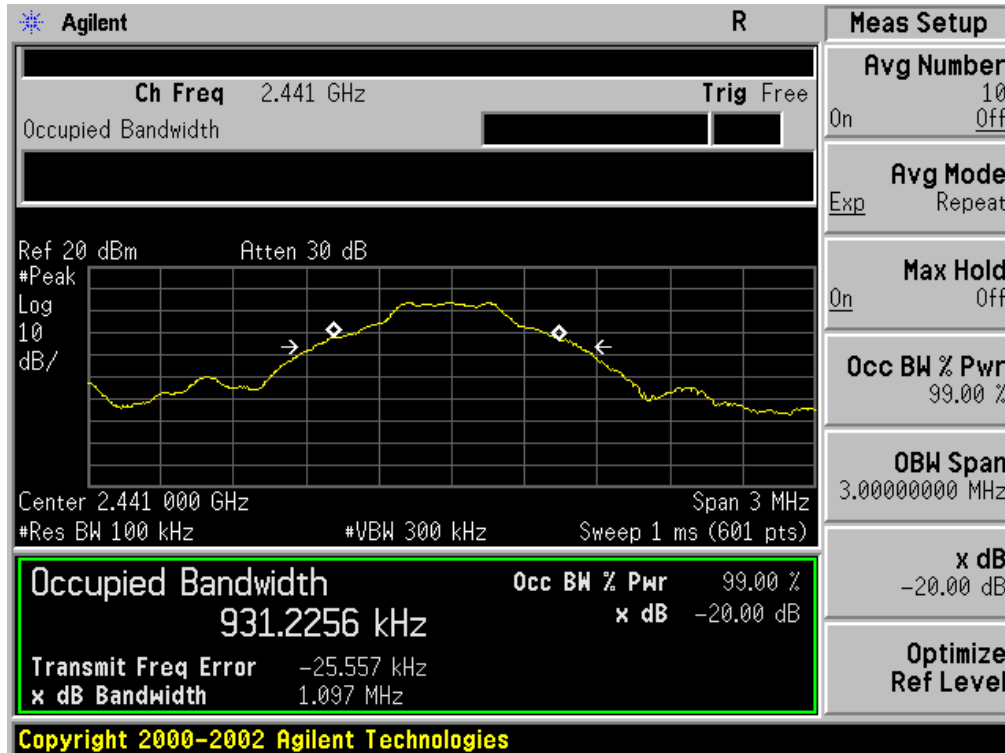

TEST PLOT OF BANDWIDTH FOR HIGH CHANNEL

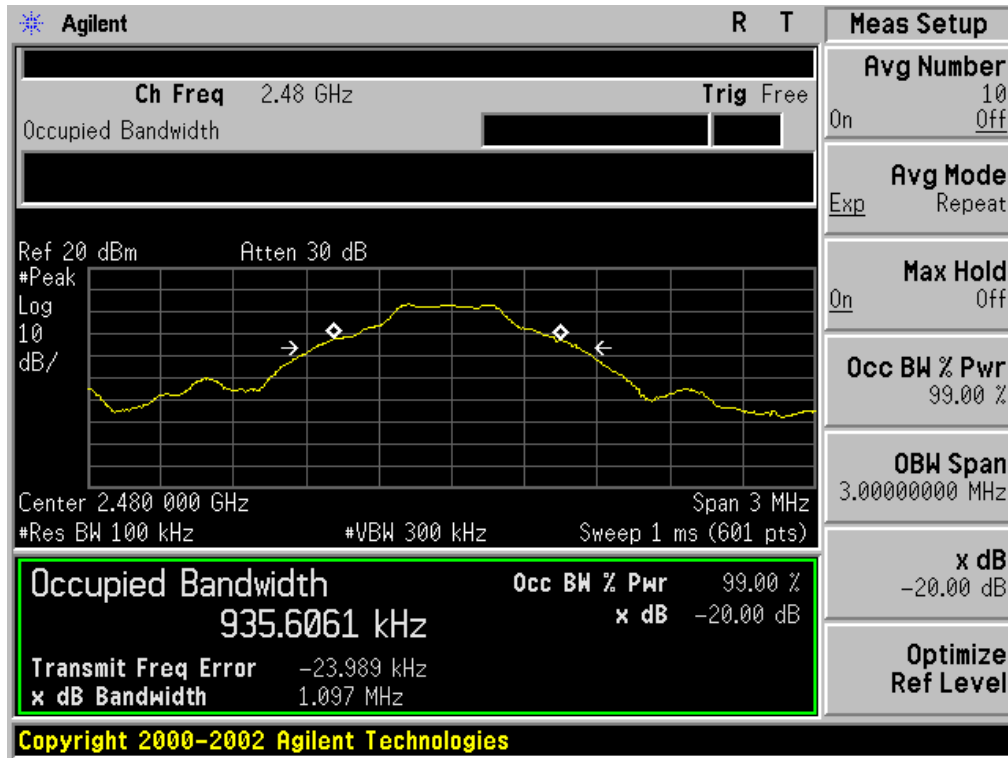

BLUETOOTH 2MBPS LIMITS AND MEASUREMENT RESULT				
Applicable Limits	Measurement Result			
	Test Data (MHz)			Result
		99%OBW (MHz)	-20dB BW(MHz)	
N/A	Low Channel	1.214	1.376	PASS
	Middle Channel	1.207	1.366	PASS
	High Channel	1.197	1.364	PASS

TEST PLOT OF BANDWIDTH FOR LOW CHANNEL

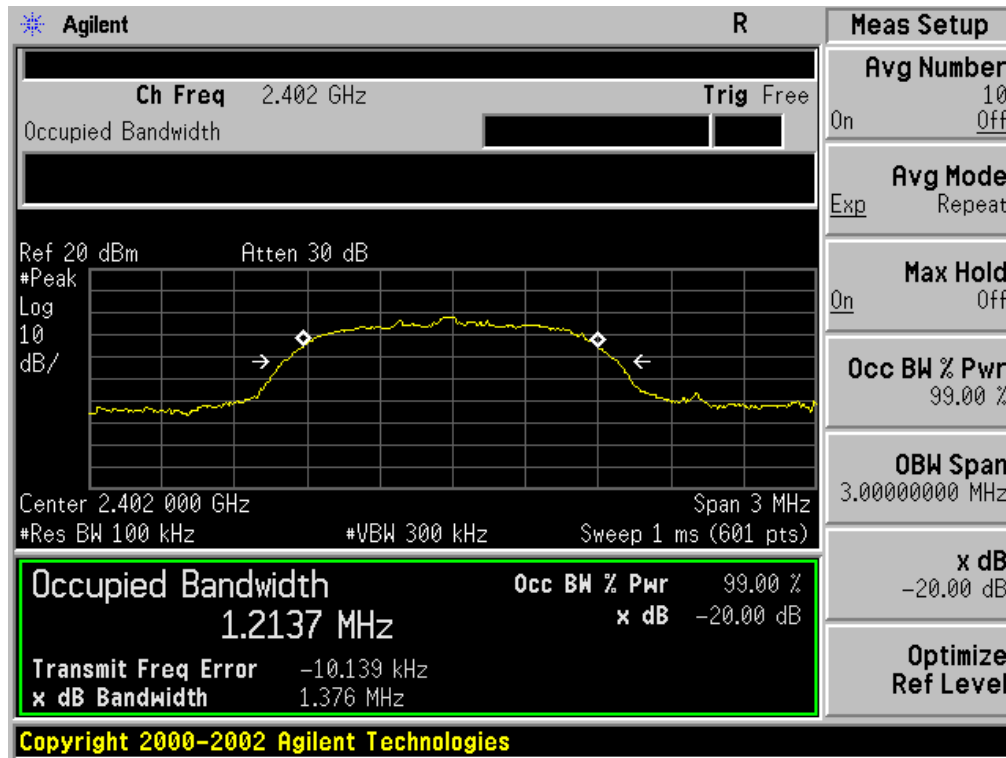

TEST PLOT OF BANDWIDTH FOR MIDDLE CHANNEL

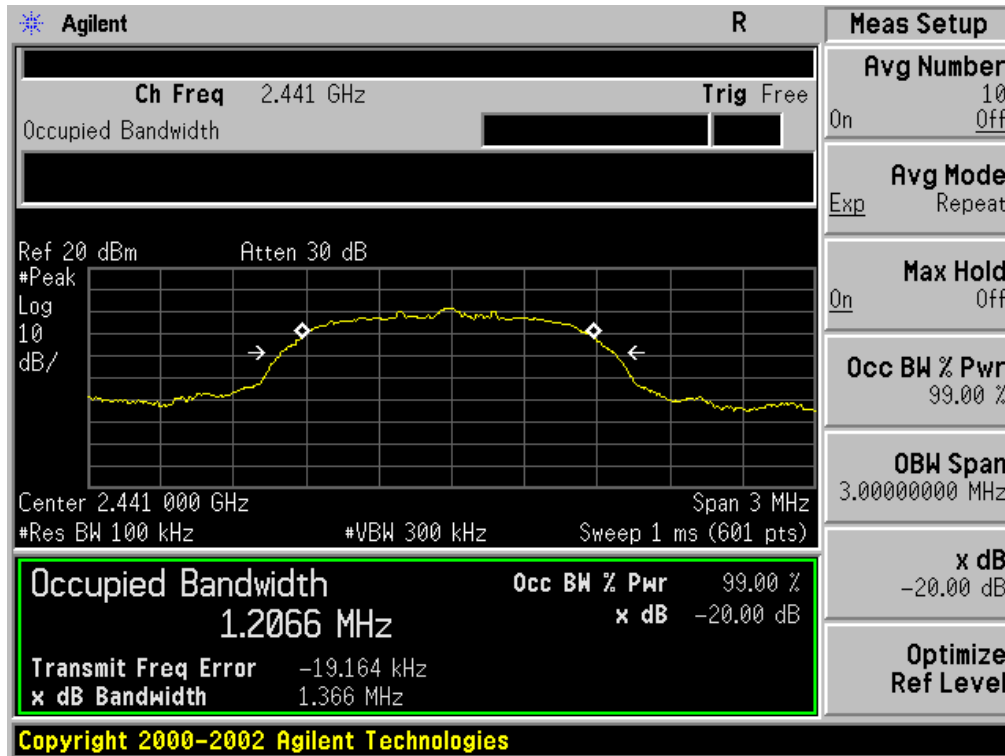

TEST PLOT OF BANDWIDTH FOR HIGH CHANNEL

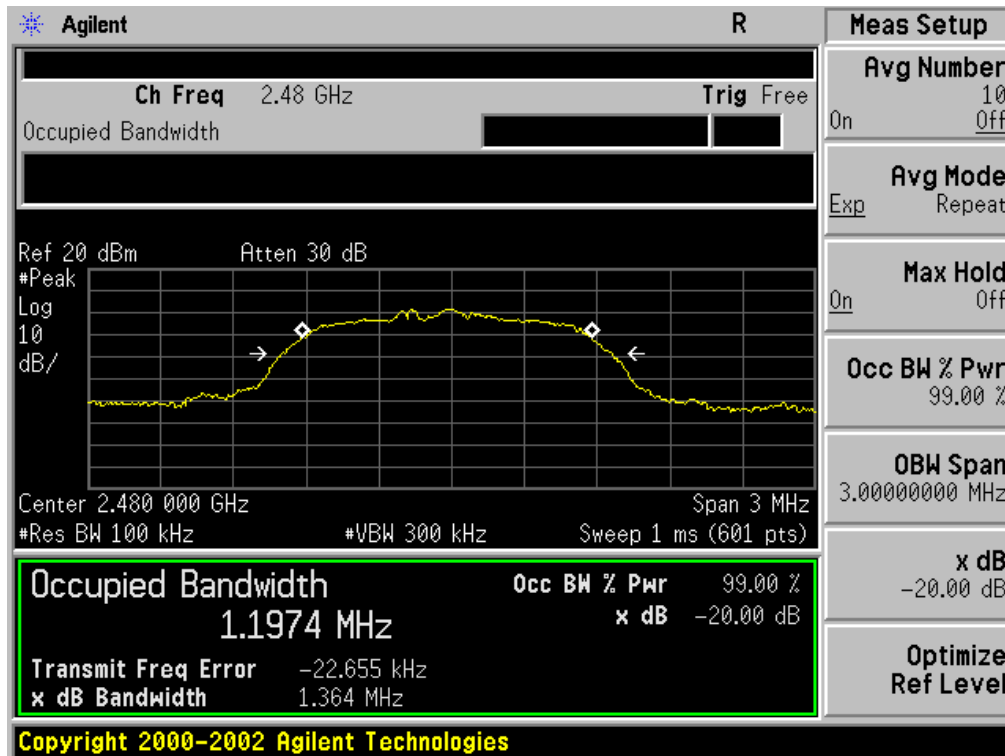

BLUETOOTH 3MBPS LIMITS AND MEASUREMENT RESULT				
Applicable Limits	Measurement Result			
	Test Data (MHz)			Result
		99%OBW (MHz)	-20dB BW(MHz)	
N/A	Low Channel	1.203	1.360	PASS
	Middle Channel	1.219	1.368	PASS
	High Channel	1.202	1.351	PASS

TEST PLOT OF BANDWIDTH FOR LOW CHANNEL

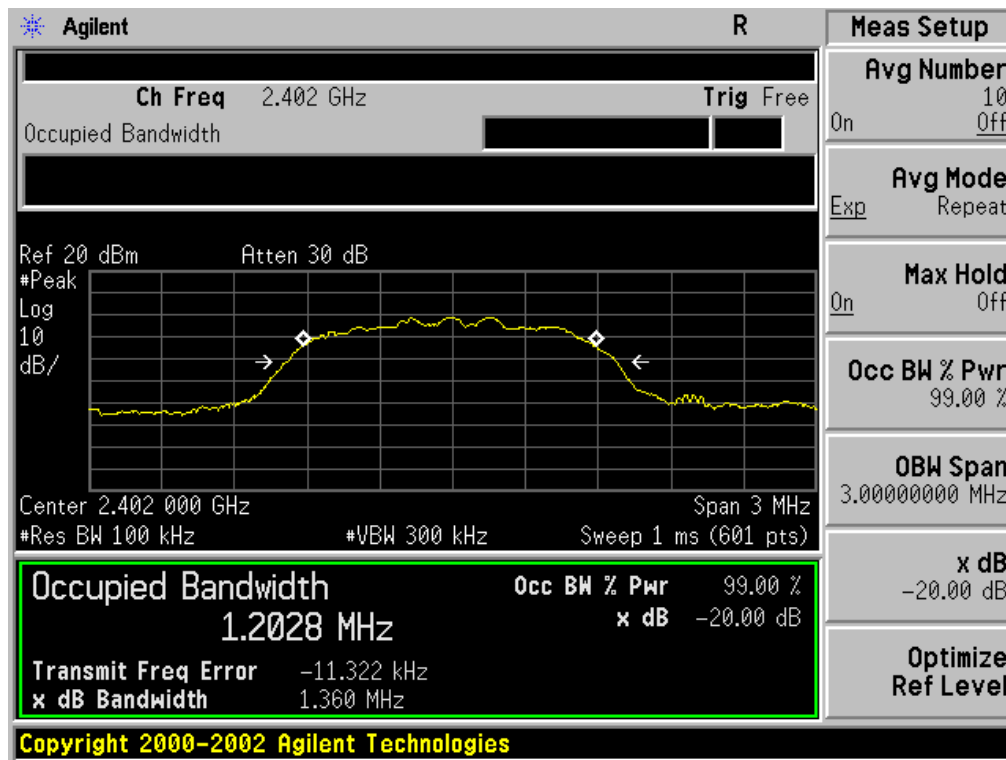



TEST PLOT OF BANDWIDTH FOR MIDDLE CHANNEL

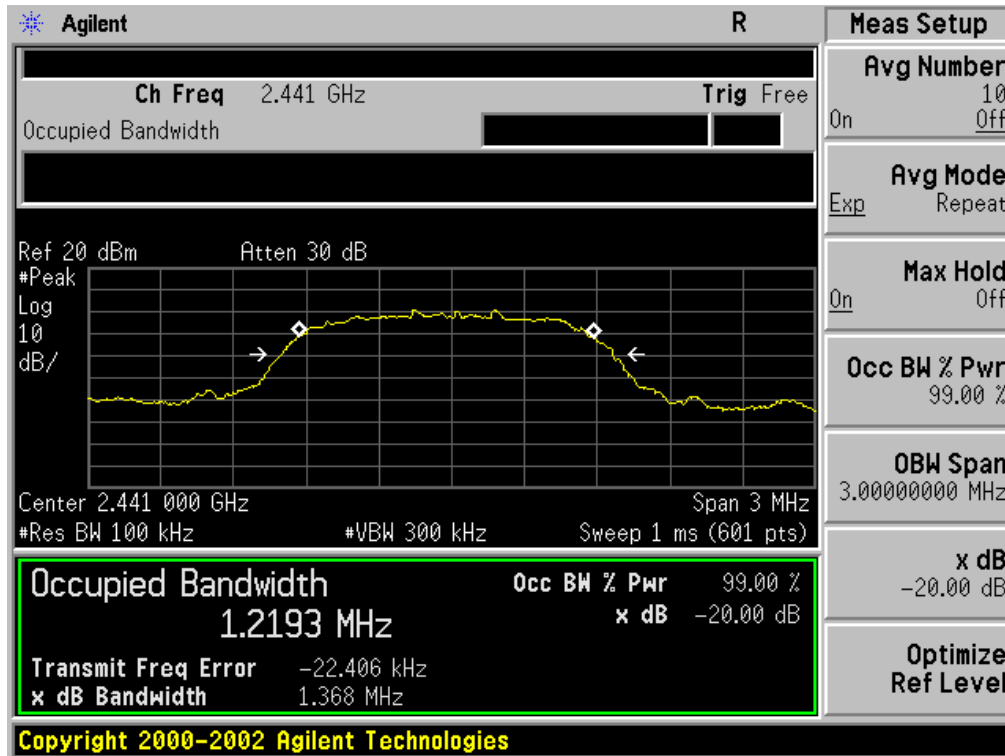

TEST PLOT OF BANDWIDTH FOR HIGH CHANNEL

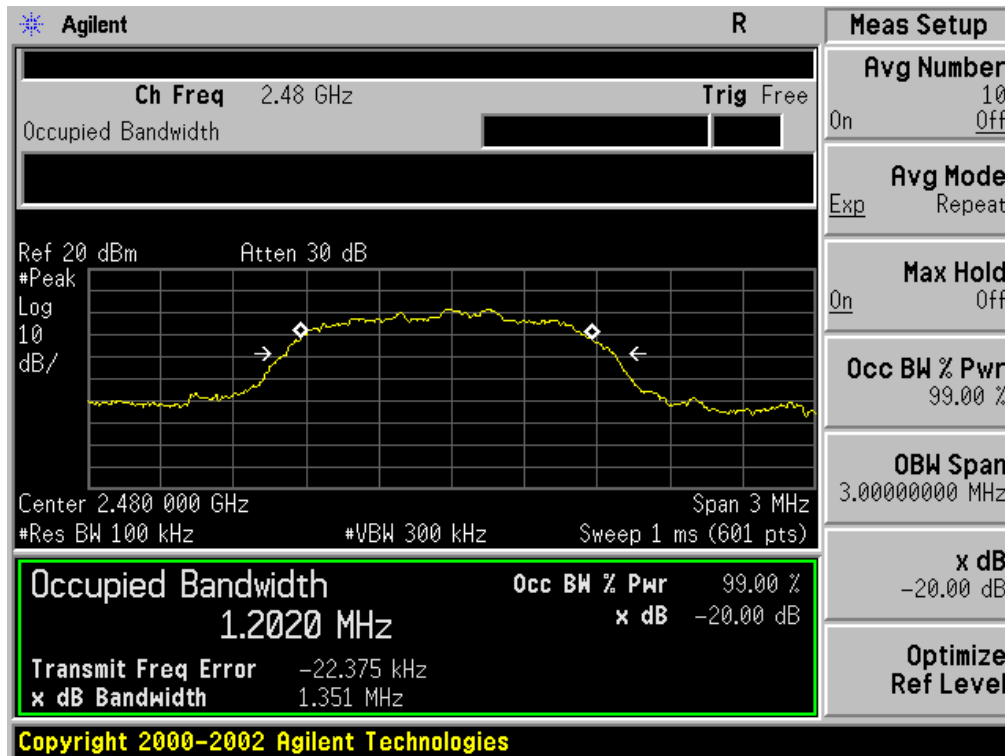

## 11. FCC LINE CONDUCTED EMISSION TEST

### 11.1. LIMITS OF LINE CONDUCTED EMISSION TEST

Frequency	Maximum RF Line Voltage	
	Q.P.( dBuV)	Average( dBuV)
150kHz~500kHz	66-56	56-46
500kHz~5MHz	56	46
5MHz~30MHz	60	50

Note:

1. The lower limit shall apply at the transition frequency.
2. The limit decreases linearly with the logarithm of the frequency in the range 0.15 MHz to 0.50 MHz.

### 11.2. BLOCK DIAGRAM OF LINE CONDUCTED EMISSION TEST

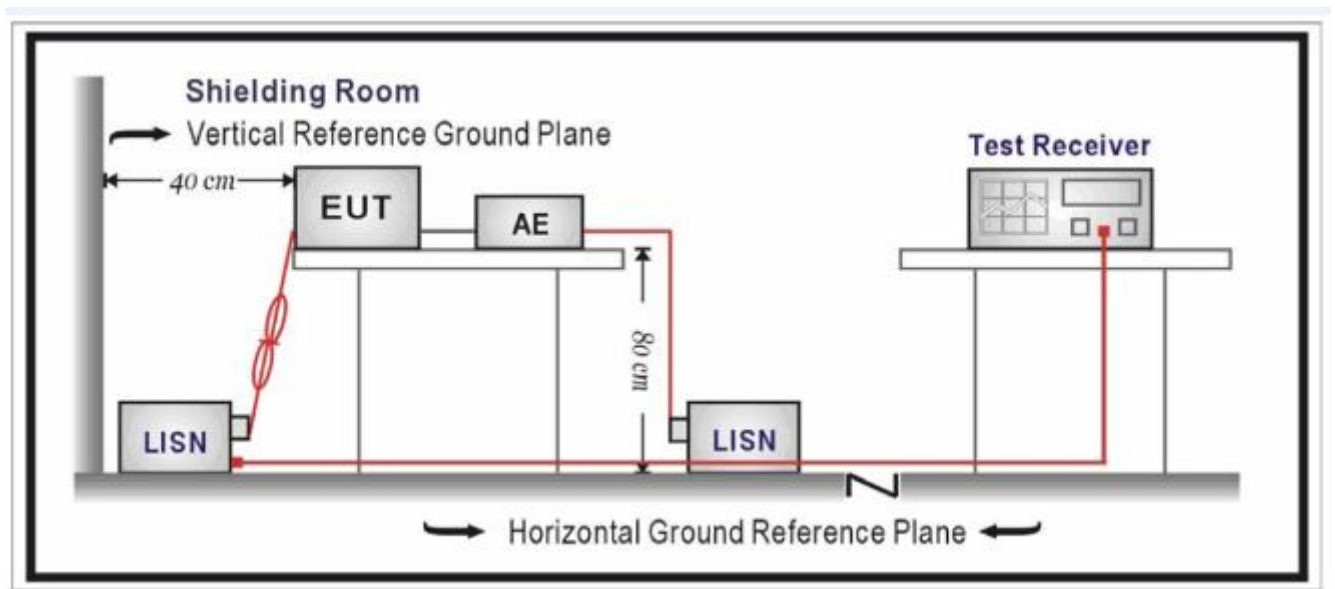

### 11.3. PRELIMINARY PROCEDURE OF LINE CONDUCTED EMISSION TEST

1. The equipment was set up as per the test configuration to simulate typical actual usage per the user's manual. When the EUT is a tabletop system, a wooden table with a height of 0.8 meters is used and is placed on the ground plane as per ANSI C63.10 (see Test Facility for the dimensions of the ground plane used). When the EUT is a floor-standing equipment, it is placed on the ground plane which has a 3-12 mm non-conductive covering to insulate the EUT from the ground plane.
2. Support equipment, if needed, was placed as per ANSI C63.10.
3. All I/O cables were positioned to simulate typical actual usage as per ANSI C63.10.
4. All support equipments received AC120V/60Hz power from a LISN, if any.
5. The EUT received DC charging voltage by adapter or PC which received 120V/60Hz power by a LISN.
6. The test program was started. Emissions were measured on each current carrying line of the EUT using a spectrum Analyzer / Receiver connected to the LISN powering the EUT. The LISN has two monitoring points: Line 1 (Hot Side) and Line 2 (Neutral Side). Two scans were taken: one with Line 1 connected to Analyzer / Receiver and Line 2 connected to a 50 ohm load; the second scan had Line 1 connected to a 50 ohm load and Line 2 connected to the Analyzer / Receiver.
7. Analyzer / Receiver scanned from 150 kHz to 30MHz for emissions in each of the test modes.
8. During the above scans, the emissions were maximized by cable manipulation.
9. The test mode(s) were scanned during the preliminary test.

Then, the EUT configuration and cable configuration of the above highest emission level were recorded for reference of final testing.

### 11.4. FINAL PROCEDURE OF LINE CONDUCTED EMISSION TEST

1. EUT and support equipment was set up on the test bench as per step 2 of the preliminary test.
2. A scan was taken on both power lines, Line 1 and Line 2, recording at least the six highest emissions. Emission frequency and amplitude were recorded into a computer in which correction factors were used to calculate the emission level and compare reading to the applicable limit. If EUT emission level was less -2dB to the A.V. limit in Peak mode, then the emission signal was re-checked using Q.P and Average detector.
3. The test data of the worst case condition(s) was reported on the Summary Data page.

### 11.5. TEST RESULT OF LINE CONDUCTED EMISSION TEST

N/A

**Note:** Owing to The EUT was charging by DC source, and the BT function of EUT didn't work when charging, the test item is not applicable.

## APPENDIX A: PHOTOGRAPHS OF TEST SETUP

### FCC RADIATED EMISSION TEST SETUP

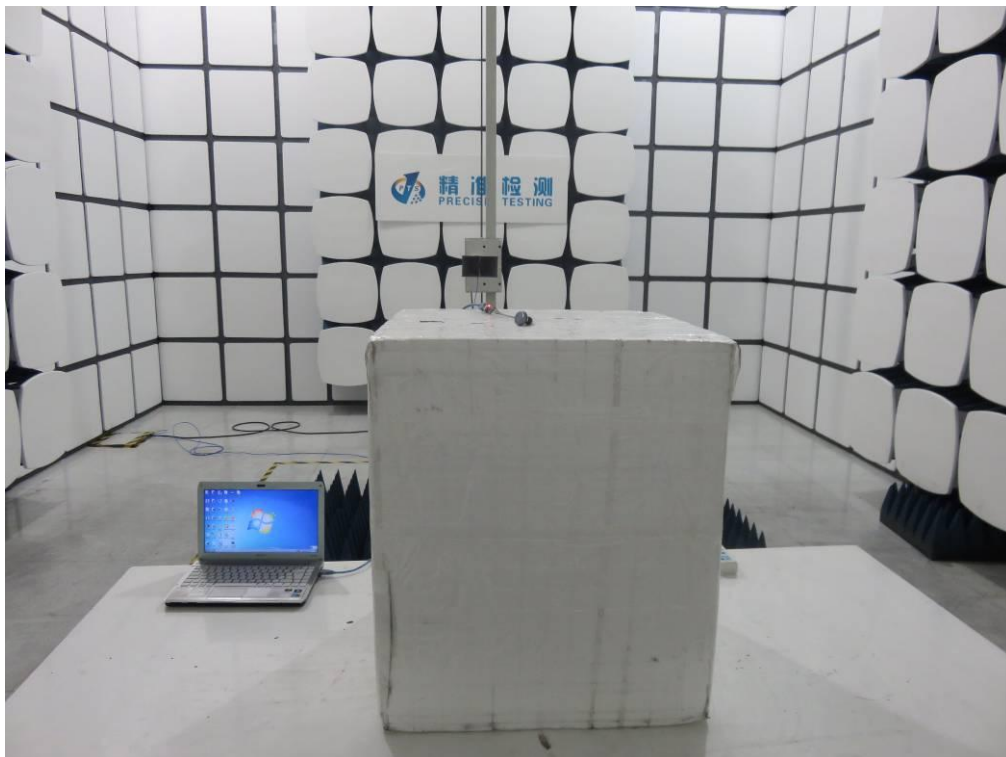
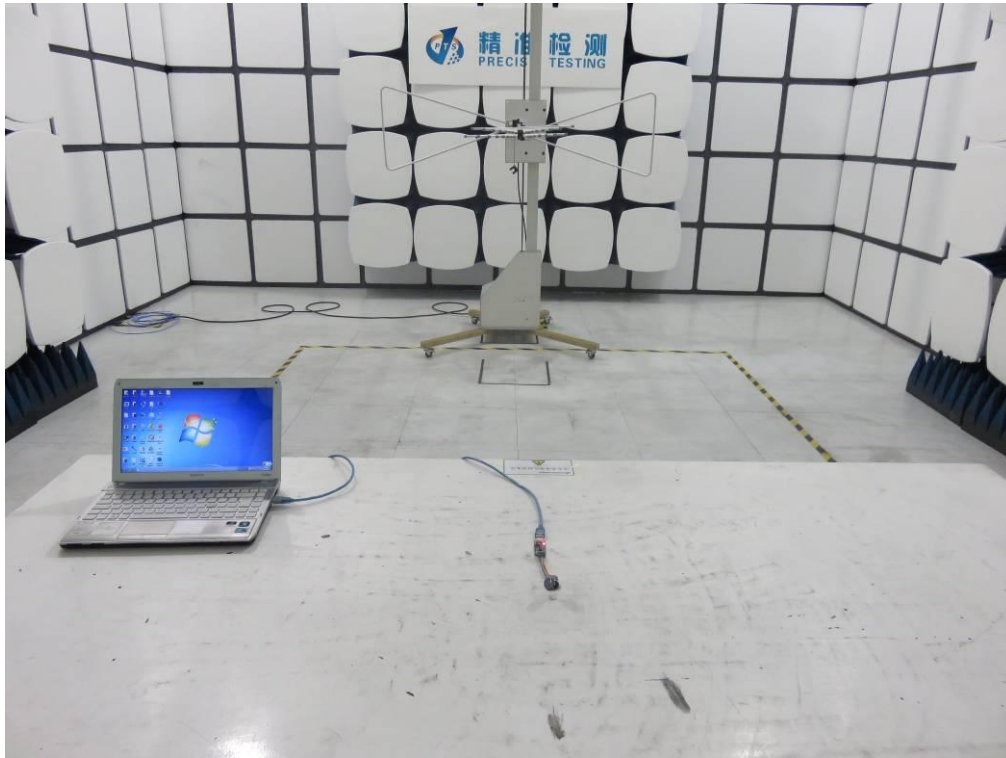

**APPENDIX B: PHOTOGRAPHS OF EUT**  
TOTAL VIEW OF EUT-1 (BC02)



TOTAL VIEW OF EUT-2 (BC02)





TOP VIEW OF EUT (BC02)

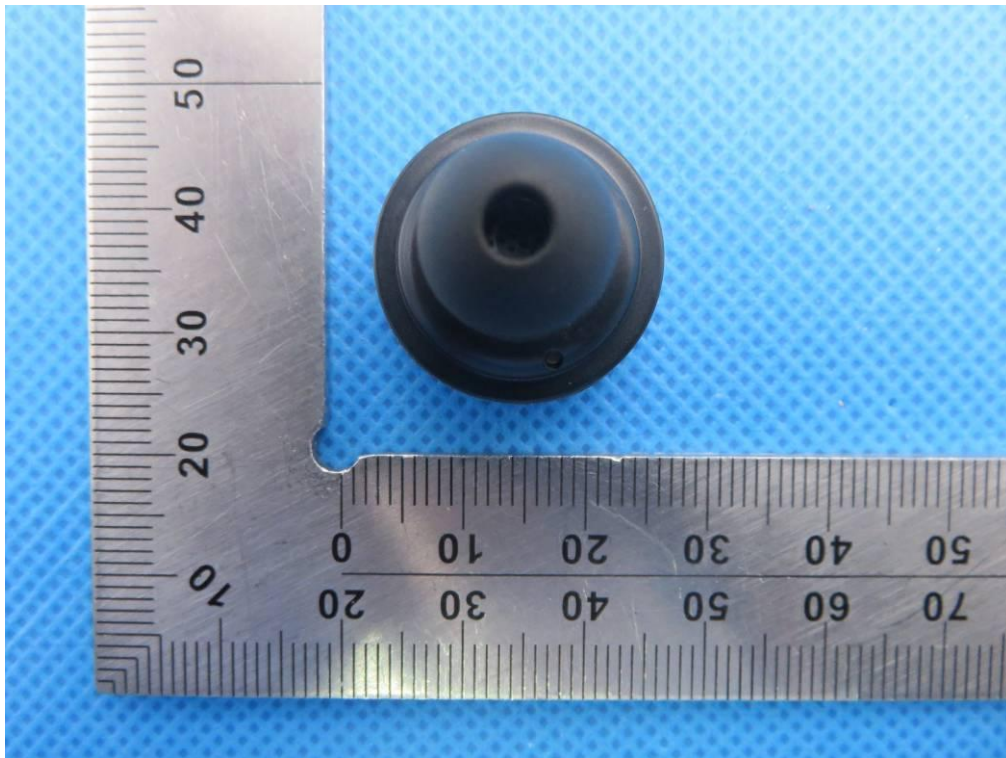

BOTTOM VIEW OF EUT (BC02)

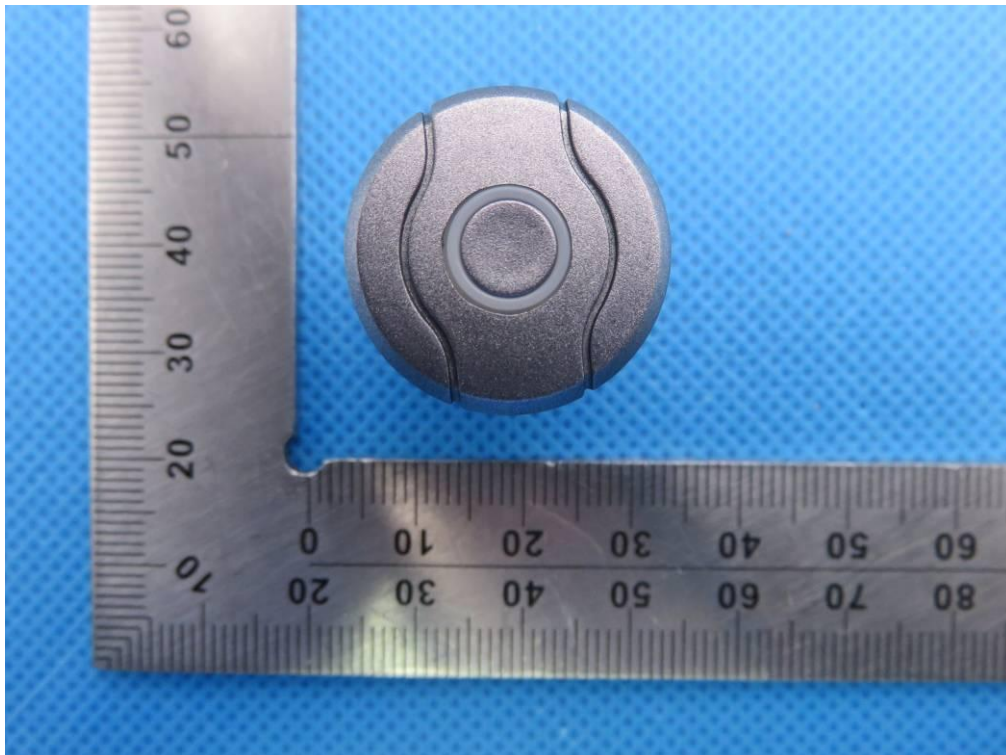

FRONT VIEW OF EUT (BC02)



BACK VIEW OF EUT (BC02)

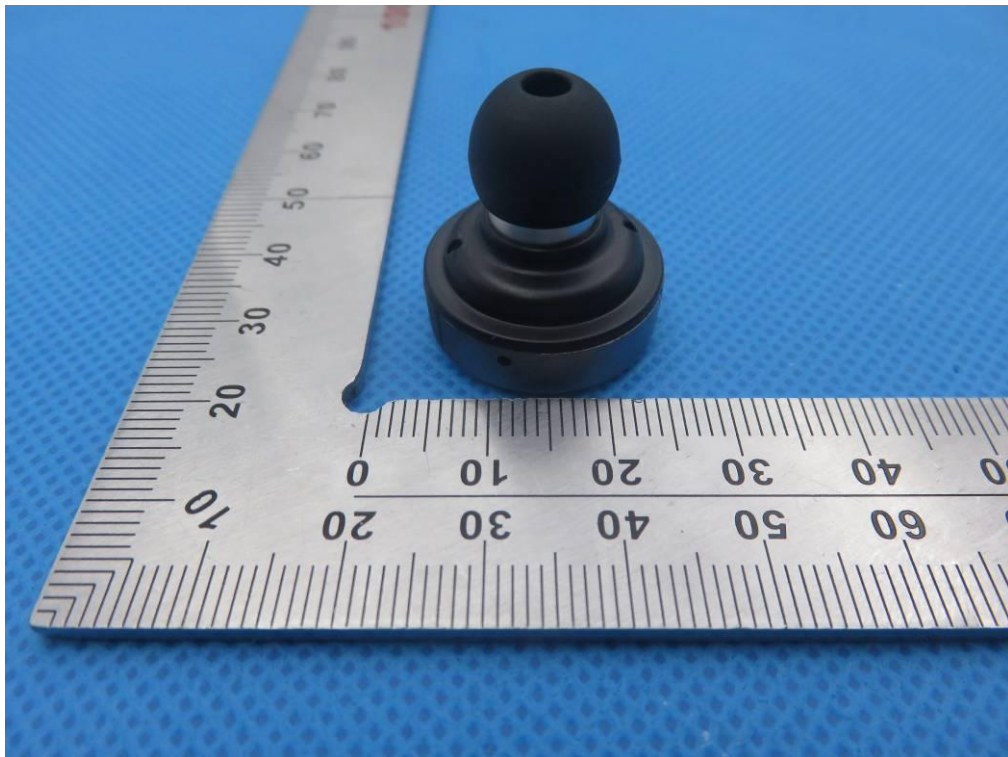



LEFT VIEW OF EUT (BC02)

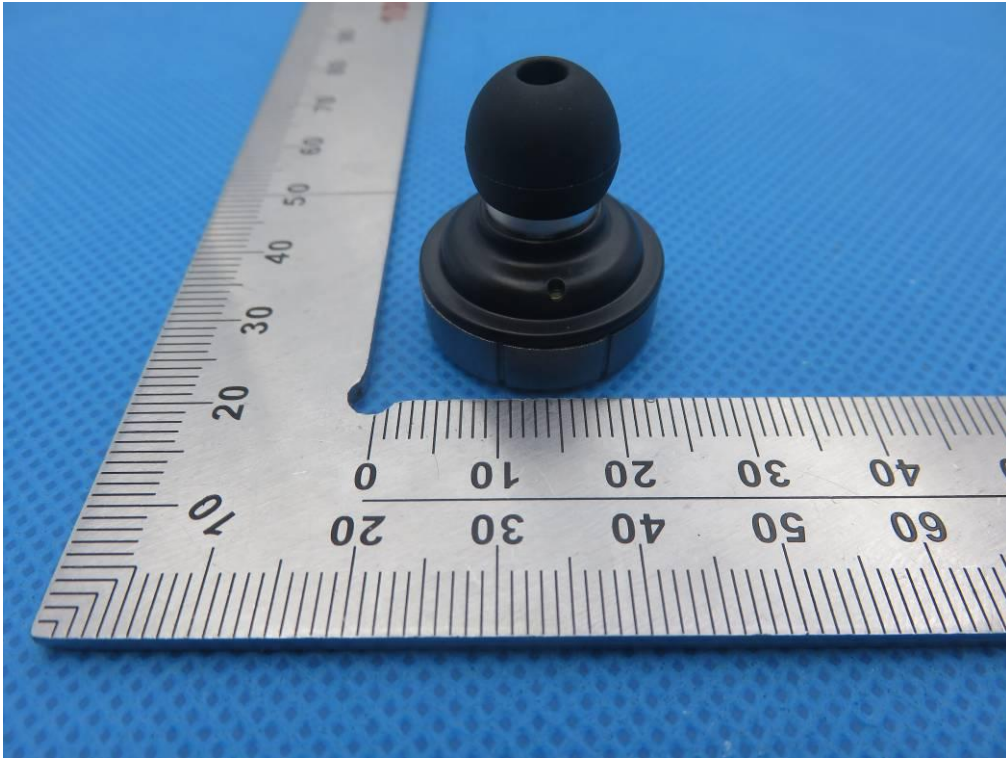

RIGHT VIEW OF EUT (BC02)

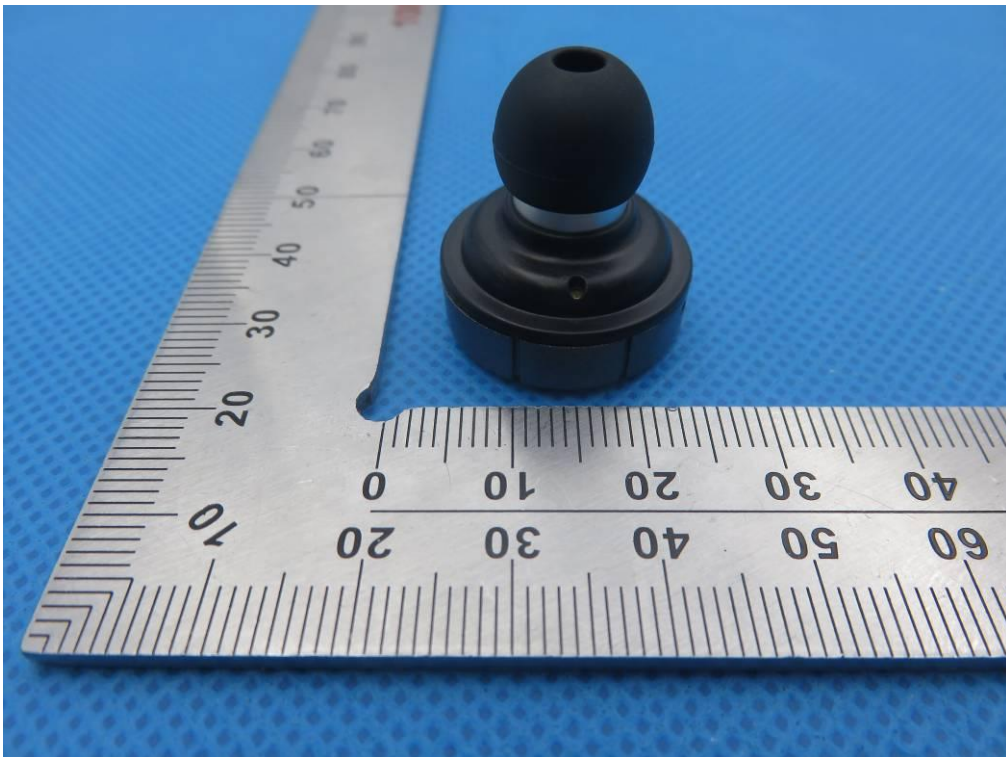



OPEN VIEW OF EUT (BC02)



INTERNAL VIEW OF EUT-1 (BC02)

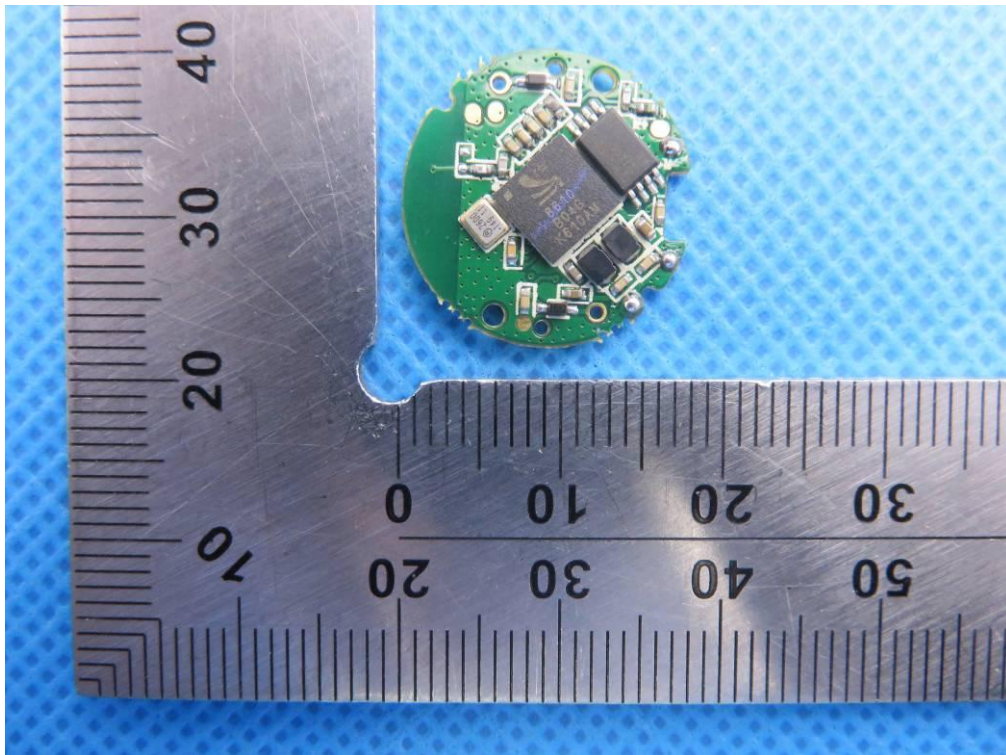

INTERNAL VIEW OF EUT-2 (BC02)

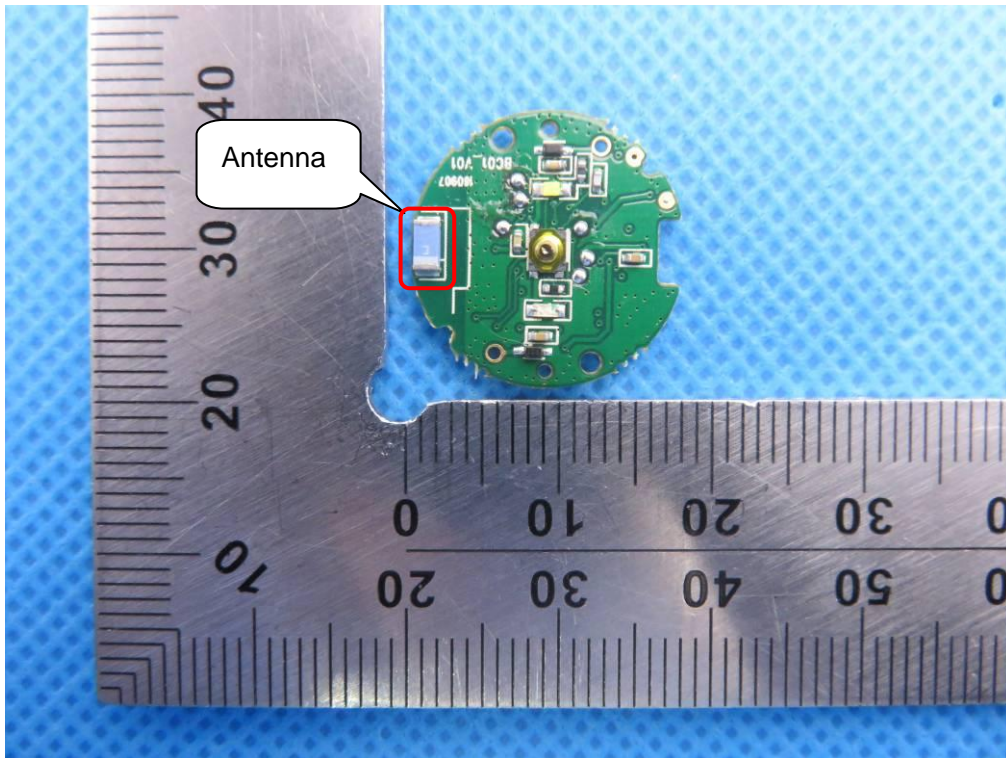

INTERNAL VIEW OF EUT-3 (BC02)

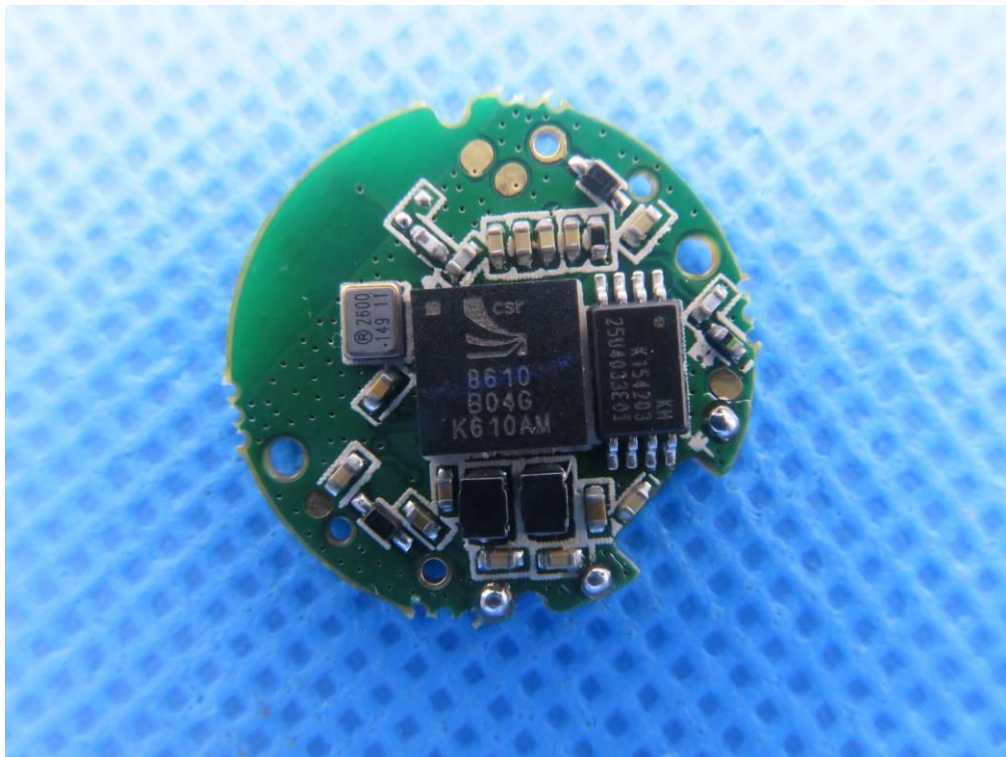



**Series Model**

ALL VIEW OF EUT-1 (BC01)

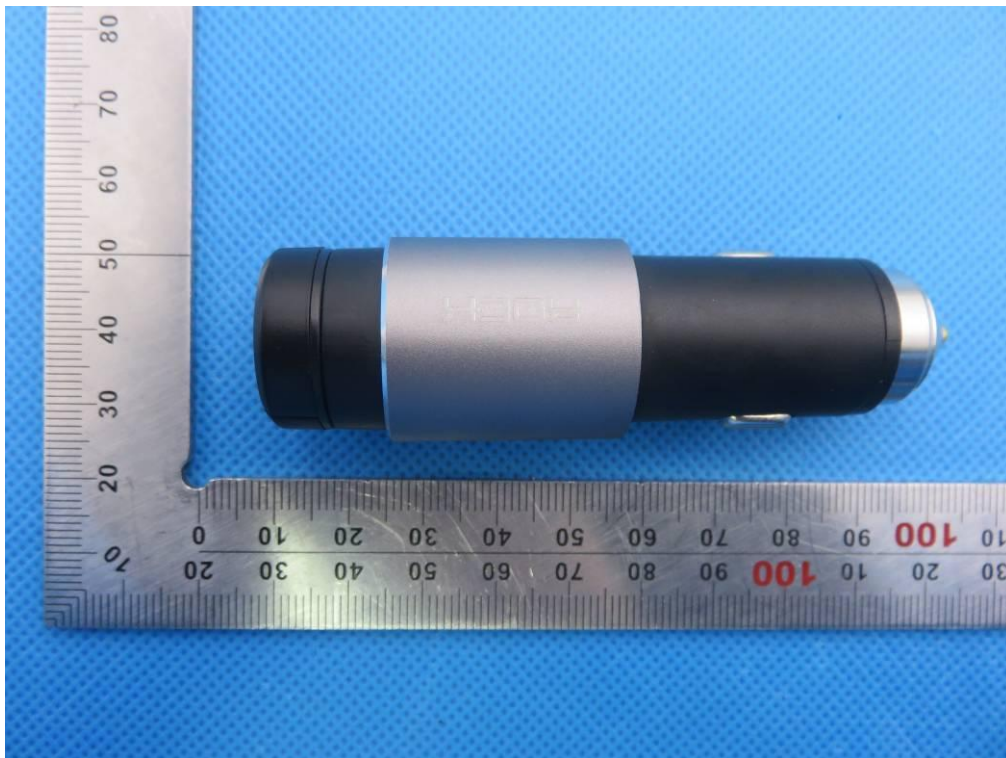

ALL VIEW OF EUT-2 (BC01)



TOP VIEW OF EUT (BC01)

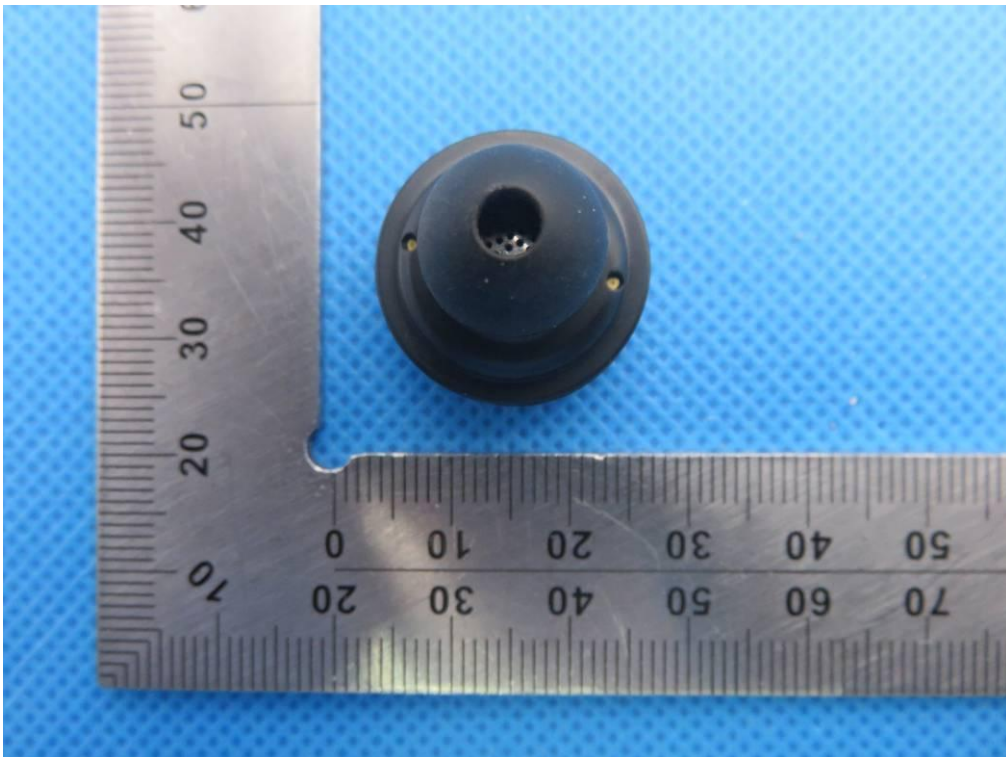

BOTTOM VIEW OF EUT (BC01)



ALL VIEW OF EUT-1 (BC03)

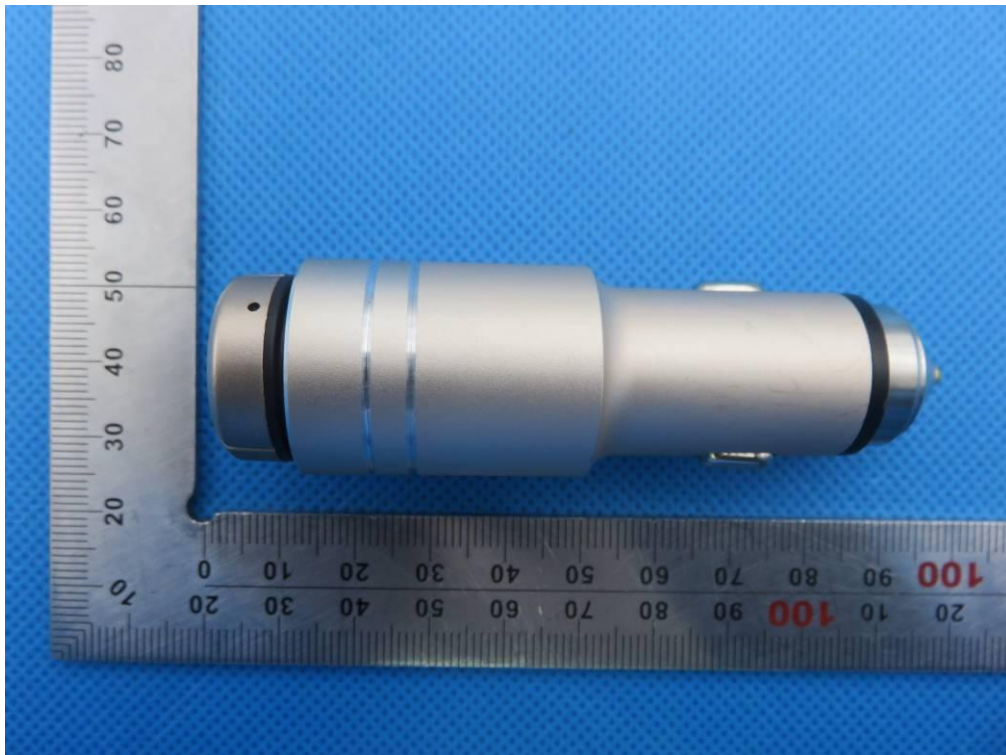



ALL VIEW OF EUT-2 (BC03)



TOP VIEW OF EUT (BC03)

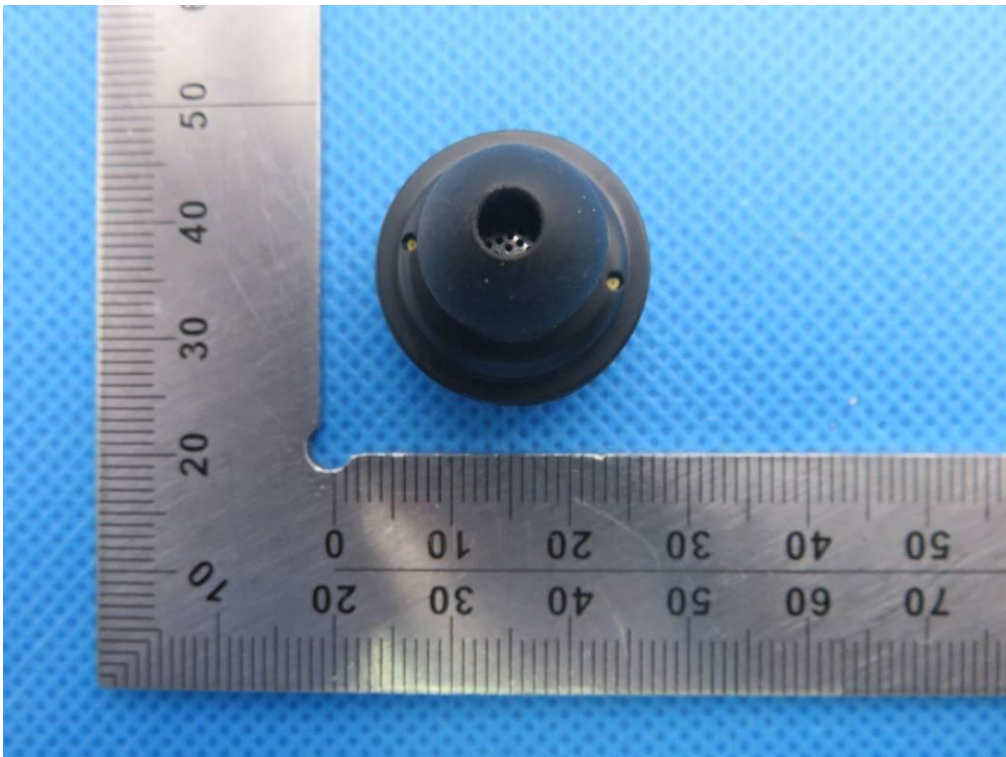

BOTTOM VIEW OF EUT (BC03)



----END OF REPORT----