

## TEST REPORT

**Applicant** : TEAC Corporation  
**Address** : 1-47 Ochiai, Tama-shi, Tokyo, 206-8530 Japan

**Products** : Network CD Reciever  
**Model No.** : NR-7CD  
**Serial No.** : No.6  
ES07

**FCC ID** : XEG-NR7CD

**Test Standard** : CFR 47 FCC Rules and Regulations Part 15

**Test Results** : **Passed**

**Date of Test** : February 7 ~ 15, 2017



A handwritten signature in black ink, appearing to read 'K. Shibata', is written over a horizontal line.

Kousei Shibata  
Manager  
Japan Quality Assurance Organization  
KITA-KANSAI Testing Center  
SAITO EMC Branch  
7-3-10, Saito-asagi, Ibaraki-shi, Osaka 567-0085, Japan

- 
- The test results in this test report was made by using the measuring instruments which are traceable to national standards of measurement in accordance with ISO/IEC 17025.
  - The applicable standard, testing condition and testing method which were used for the tests are based on the request of the applicant.
  - The test results presented in this report relate only to the offered test sample.
  - The contents of this test report cannot be used for the purposes, such as advertisement for consumers.
  - This test report shall not be reproduced except in full without the written approval of JQA.
  - VLAC does not approve, certify or warrant the product by this test report.

**TABLE OF CONTENTS**

	<b>Page</b>
1 Description of the Equipment Under Test .....	3
2 Summary of Test Results .....	4
3 Test Procedure.....	5
4 Test Location .....	5
5 Recognition of Test Laboratory .....	5
6 Description of Test Setup .....	6
7 Test Requirements .....	9

**DEFINITIONS FOR ABBREVIATION AND SYMBOLS USED IN THIS TEST REPORT****EUT** : Equipment Under Test**EMC** : Electromagnetic Compatibility**AE** : Associated Equipment**EMI** : Electromagnetic Interference**N/A** : Not Applicable**EMS** : Electromagnetic Susceptibility**N/T** : Not Tested - indicates that the listed condition, standard or equipment is applicable for this report. - indicates that the listed condition, standard or equipment is not applicable for this report.

## 1 Description of the Equipment Under Test

1. Manufacturer : TEAC Corporation  
1-47 Ochiai, Tama-shi, Tokyo, 206-8530 Japan
2. Products : Network CD Reciever
3. Model No. : NR-7CD
4. Serial No. : No.6  
ES07
5. Product Type : Pre-production
6. Date of Manufacture : January, 2017
7. Power Rating : 120VAC 60Hz
8. Grounding : Grounded at the plug end of the power line
9. Transmitting Frequency : 2402.0 MHz(00CH) – 2480.0MHz(78CH)
10. Receiving Frequency : 2402.0 MHz(00CH) – 2480.0MHz(78CH)
11. Max. RF Output Power : 8.27dBm(Measure Value)
12. Antenna Type : Pattern Antenna (Integral)
13. Antenna Gain : 1.54 dBi
14. Category : Spread Spectrum Transmitter(FHSS)
15. EUT Authorization : Certification
16. Received Date of EUT : February 6, 2017

### 17. Channel Plan

The carrier spacing is 1 MHz.

The carrier frequency is designated by the absolute frequency channel number (ARFCN).

The carrier frequency is expressed in the equation shown as follows:

Normal Mode:

Transmitting Frequency (in MHz) = 2402.0 + n

Receiving Frequency (in MHz) = 2402.0 + n

where, n : channel number ( $0 \leq n \leq 78$ )

## 2 Summary of Test Results

Applied Standard : CFR 47 FCC Rules and Regulations Part 15  
Subpart C – Intentional Radiators

The EUT described in clause 1 was tested according to the applied standard shown above.  
Details of the test configuration is shown in clause 6.

The conclusion for the test items of which are required by the applied standard is indicated under the test result.

- The test result was **passed** for the test requirements of the applied standard.
- The test result was **failed** for the test requirements of the applied standard.
- The test result was **not judged** the test requirements of the applied standard.

In the approval of test results,

- Determining compliance with the limits in this report was based on the results of the compliance measurement, not taking into account measurement instrumentation uncertainty.
- No deviations were employed from the applied standard.
- No modifications were conducted by JQA to achieve compliance to the limitations.

Reviewed by:

Tested by:



---

Shigeru Osawa  
Deputy Manager  
JQA KITA-KANSAI Testing Center  
SAITO EMC Branch



---

Takeshi Choda  
Assistant Manager  
JQA KITA-KANSAI Testing Center  
SAITO EMC Branch

### 3 Test Procedure

Test Requirements : §15.247, §15.207 and §15.209

Test Procedure : ANSI C63.10–2013  
Testing unlicensed wireless devices.

FCC Public Notice DA 00-705, released March 30, 2000.

KDB937606 (Publication Date: October 10, 2014)  
Test Site Requirements for Part 15 and 18 Devices Operating Below 30MHz.

KDB 447498  
RF exposure and equipment authorization requirements

### 4 Test Location

Japan Quality Assurance Organization (JQA)  
KITA-KANSAI Testing Center  
7-7, Ishimaru, 1-chome, Minoh-shi, Osaka, 562-0027, Japan  
SAITO EMC Branch  
7-3-10, Saito-asagi, Ibaraki-shi, Osaka 567-0085, Japan

### 5 Recognition of Test Laboratory

JQA KITA-KANSAI Testing Center SAITO EMC Branch is accredited under ISO/IEC 17025 by following accreditation bodies and the test facility is registered by the following bodies.

VLAC Accreditation No. : VLAC-001-2 (Expiry date : March 30, 2018)  
VCCI Registration No. : A-0002 (Expiry date : March 30, 2018)  
BSMI Registration No. : SL2-IS-E-6006, SL2-IN-E-6006, SL2-R1/R2-E-6006, SL2-A1-E-6006  
(Expiry date : September 14, 2019)  
IC Registration No. : 2079E-3, 2079E-4 (Expiry date : July 16, 2017)

Accredited as conformity assessment body for Japan electrical appliances and material law by METI.  
(Expiry date : February 22, 2019)

## 6 Description of Test Setup

### 6.1 Test Configuration

The equipment under test (EUT) consists of :

	Item	Manufacturer	Model No.	Serial No.	FCC ID
A	Network CD Receiver	TEAC	NR-7CD	No.6 *1) ES07 *2)	XEG-NR7CD
B	Remote Controller	TEAC	RC-1328	--	--

\*1) Used for AC Powerline Conducted Emission and Field Strength of Spurious Emission

\*2) Used for Antenna Conducted Emission

The auxiliary equipment used for testing :

	Item	Manufacturer	Model No.	Serial No.	FCC ID
C	CD Player	TASCAM	CD-6010	--	N/A
D	USB Flash Drive	TEAC	UF-408M2	TM2G925607160376	DoC
E	Access Point	NEC	PA-WR8170N-ST	81S1183812677A11	None
F	AC Adaptor	NEC	AL1-002568-001	01117A526792	N/A
G	USB Flash Drive	Buffalo	RUF3-K16G	I50901	DoC
H	Dummy Load	--	--	--	N/A
I	Head Phone	--	--	--	N/A
J	Mobile Phone	Apple	A1586	--	BCG-E281 6A

Type of Cable:

No.	Description	Identification (Manu. etc.)	Connector Shielded	Cable Shielded	Ferrite Core	Length (m)
1	AC Power Cable 1 (3Pin)	--	--	No	No	2.0
2	Coaxial Cable	--	YES	YES	No	1.0
3	RCA Audio Cable	--	YES	YES	No	2.0
4	Speaker Cable 1	--	--	No	No	1.0
5	Speaker Cable 2	--	--	No	No	2.0
6	LAN Cable	--	--	No	No	2.0
7	AC Power Cable 2 (3Pin)	--	--	No	No	2.0
8	DC Power Cable	--	--	No	No	1.3
9	AC Power Cable 3 (3Pin)	--	--	No	No	0.6
10	Head Phone Cable	--	--	No	No	0.6

**6.2 Test Arrangement (Drawings)**

a) Single Unit

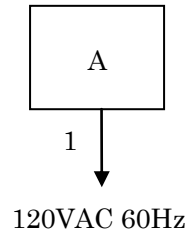

b) Headphone used

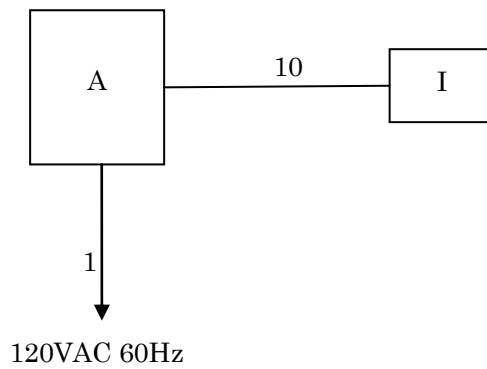

c) Full Setup

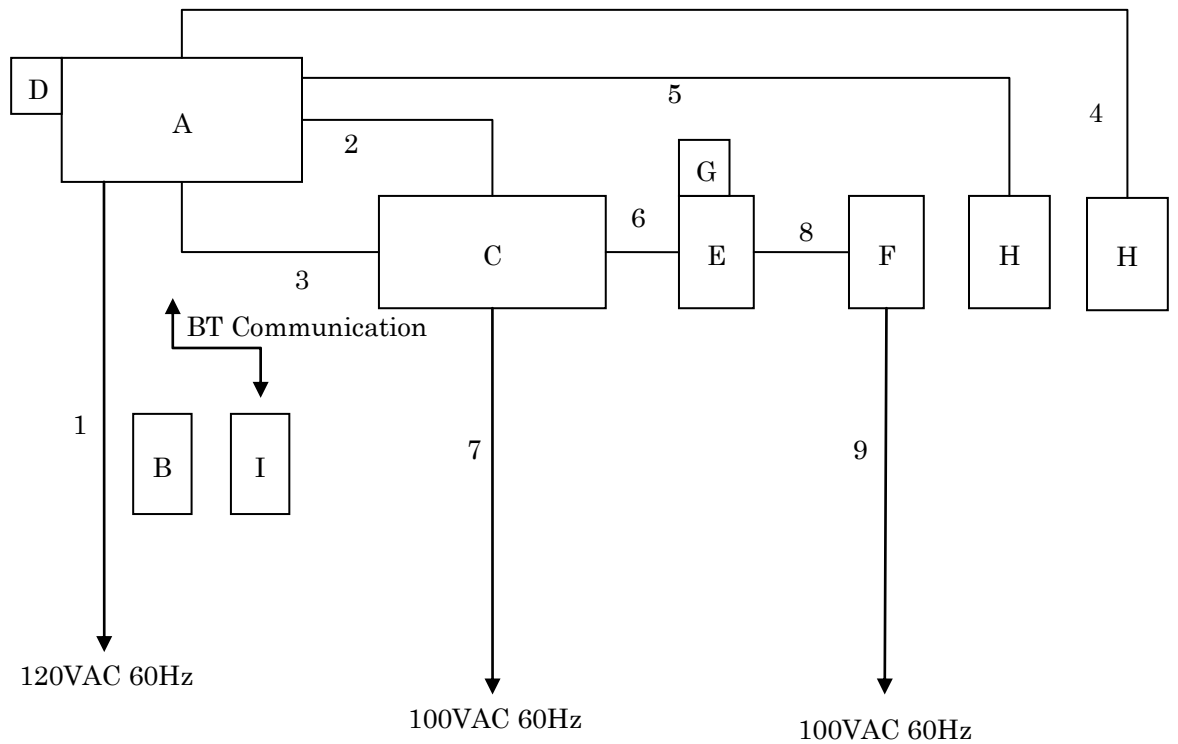

### 6.3 Operating Condition

Power Supply Voltage : 120 VAC, 60 Hz

Transmitting/Receiving

Bluetooth 4.0 + EDR

Transmitting frequency : 2402.0 MHz(0CH) – 2480.0 MHz(78CH)

Receiver frequency : 2402.0 MHz(0CH) – 2480.0 MHz(78CH)

The test were carried under 2 mode shown as follows:

- 1) BDR
- 2) EDR

In Spurious Emissions(Conducted) and Radiated Emissions, the worst case is BDR mode.

Modulation Type

1. DH1/ DH3/ DH5 Packet (Modulation Type : GFSK)
2. 2DH1/ 2DH3/ 2DH5 Packet (Modulation Type : pi/4-DQPSK)
3. 3DH1/ 3DH3/ 3DH5 Packet (Modulation Type : 8DPSK)

Other Clock Frequency

480MHz(USB2.0)

The EUT with temporary antenna port was used in conducted measurement.

The test were carried out using the following test program supplied by applicant;

- Software Name: CSR Bluetest3.0
- Software Version: Version 2.5.8.667
- Storage Location: Controller PC



## 7 Test Requirements

### 7.0 Summary of the Test Results

Test Item	FCC Specification	Reference of the Test Report	Results	Remarks
Antenna Requirement	Section 15.203	Section 1.12	Passed	-
Channel Separation	Section 15.247(a)(1)	Section 7.1	Passed	-
Minimum Hopping Channel	Section 15.247(a)(1)(iii)	Section 7.2	Passed	-
Occupied Bandwidth	Section 15.247(a)(1)	Section 7.3	Passed	-
Dwell Time	Section 15.247(a)(1)(iii)	Section 7.4	Passed	-
Peak Output Power (Conduction)	Section 15.247(b)(1)	Section 7.5	Passed	-
Peak Power Density (Conduction)	Section 15.247(e)	-	-	-
Spurious Emissions (Conduction)	Section 15.247(d)	Section 7.7	Passed	-
AC Powerline Conducted Emission	Section 15.207	Section 7.8	Passed	-
Radiated Emission	Section 15.247(d)	Section 7.9	Passed	-
SAR Test Exclusion	Section 15.247(i)	Section 7.10	Passed	-

### 7.1 Channel Separation

For the requirements,  - Applicable [  - Tested.  - Not tested by applicant request. ]  
 - Not Applicable

#### 7.1.1 Test Results

For the standard,  - Passed  - Failed  - Not judged

Channel Separation is 1.000 MHz  
 Channel Separation (Inquiry) is 2.000 MHz

Uncertainty of Measurement Results ± 0.9 %(2σ)

Remarks : \_\_\_\_\_

#### 7.1.2 Test Instruments

Shielded Room S4				
Type	Model	Serial No. (ID)	Manufacturer	Cal. Due
Spectrum Analyzer	E4446A	US44300388 (A-39)	Agilent	2017/08/02
Attenuator	54A-10	W5675 (D-28)	Weinschel	2017/08/02
RF Cable	SUCOFLEX102	14253/2 (C-52)	HUBER+SUHNER	2017/08/02

NOTE : The calibration interval of the above test instruments is 12 months.

#### 7.1.3 Test Method and Test Setup (Diagrammatic illustration)

The test system is shown as follows:

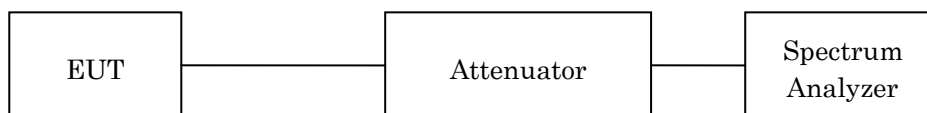

The setting of the spectrum analyzer are shown as follows:

Res. Bandwidth	100 kHz
Video Bandwidth	300 kHz
Span	3 MHz / 5 MHz
Sweep Time	AUTO
Trace	Maxhold

### 7.1.4 Test Data

Test Date : February 13, 2017

Temp.: 22°C, Humi: 29%

Mode of EUT	Channel Separation (MHz)	Limit* (MHz)
Hopping	1.000	0.846
Inquiry	2.000	0.510

Note: Two-thirds of the maximum 20 dB bandwidth of the hopping channel or 25 kHz (whichever is greater). Refer to the section 7.3.

Mode of EUT : Hopping

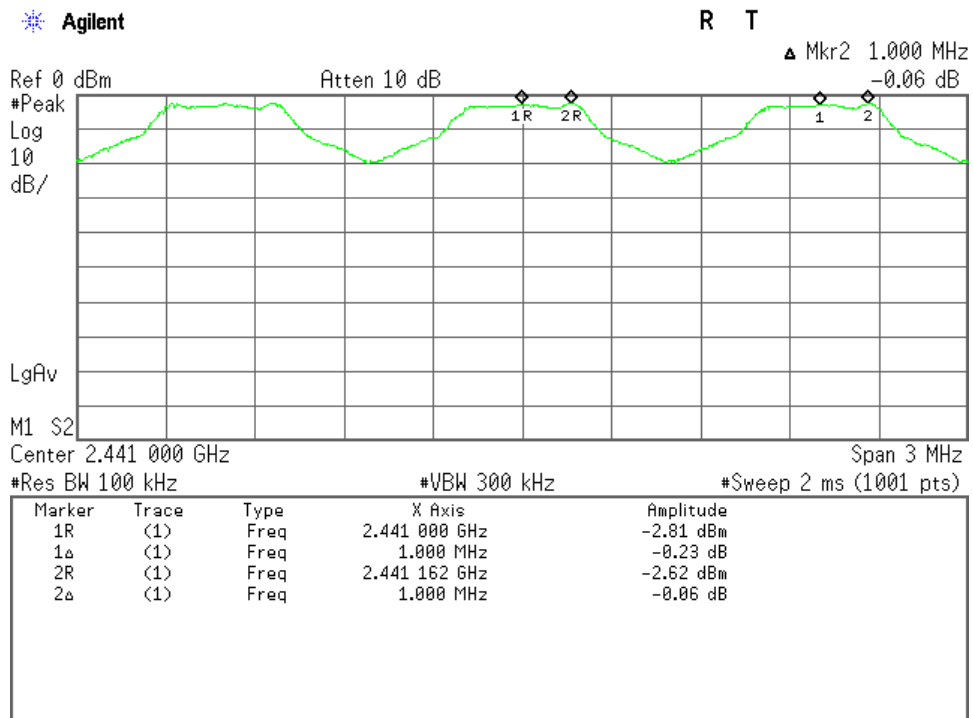

Mode of EUT : Inquiry

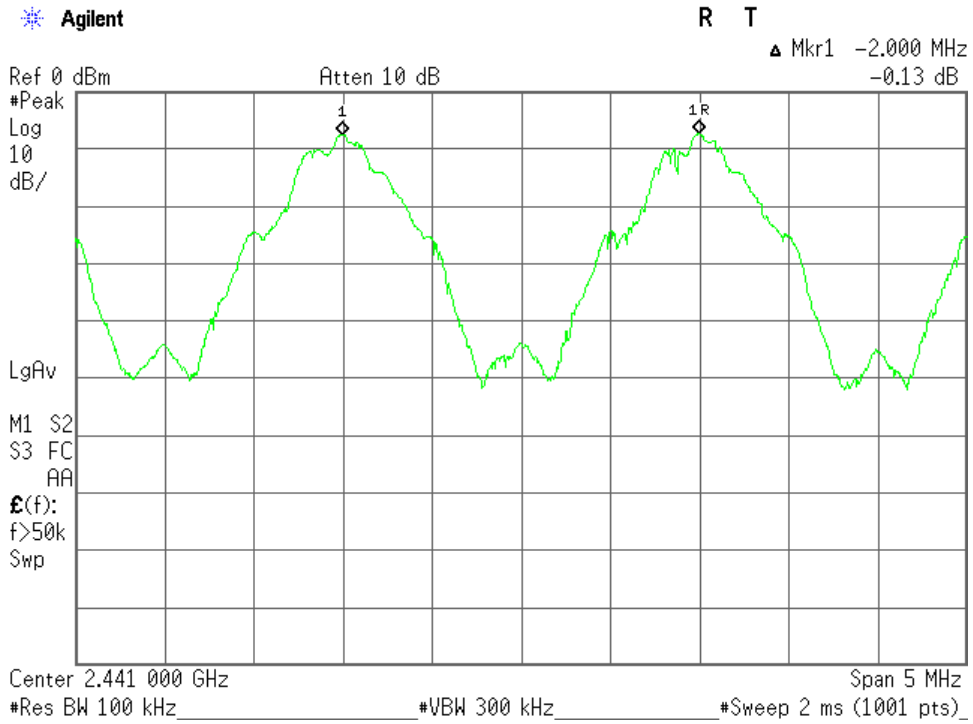

**7.2 Minimum Hopping Channel**

For the requirements,  - Applicable [  - Tested.  - Not tested by applicant request. ]  
 - Not Applicable

**7.2.1 Test Results**

For the standard,  - Passed  - Failed  - Not judged

Number of Channel is	<u>79</u>
Number of Channel (Inquiry) is	<u>32</u>
Number of Channel (AFH) is	<u>20</u>

Remarks : \_\_\_\_\_

**7.2.2 Test Instruments**

Shielded Room S4				
Type	Model	Serial No. (ID)	Manufacturer	Cal. Due
Spectrum Analyzer	E4446A	US44300388 (A-39)	Agilent	2017/08/02
Attenuator	54A-10	W5675 (D-28)	Weinschel	2017/08/02
RF Cable	SUCOFLEX102	14253/2 (C-52)	HUBER+SUHNER	2017/08/02

NOTE : The calibration interval of the above test instruments is 12 months.

**7.2.3 Test Method and Test Setup (Diagrammatic illustration)**

The test system is shown as follows:

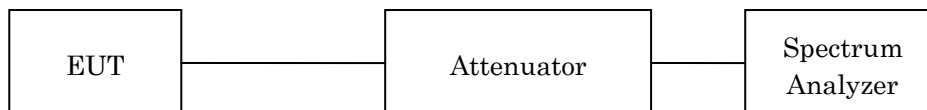

The setting of the spectrum analyzer are shown as follows:

Res. Bandwidth	300 kHz
Video Bandwidth	300 kHz
Span	30 MHz
Sweep Time	AUTO
Trace	Maxhold

**7.2.4 Test Data**

Test Date : February 13, 2017

Temp.:22°C, Humi:29%

Mode of EUT	Minimum Hopping Channel	Limit
Hopping	79	15
Inquiry	32	15
AFH(minimum)	20	15

Mode of EUT : Hopping(1/3)

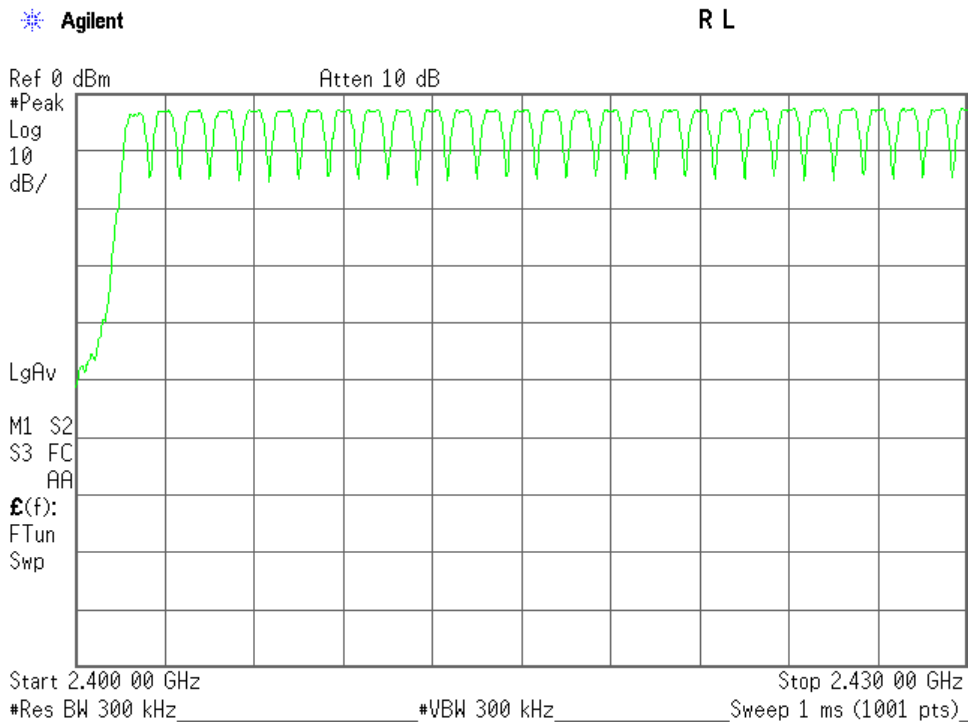

Mode of EUT : Hopping(2/3)

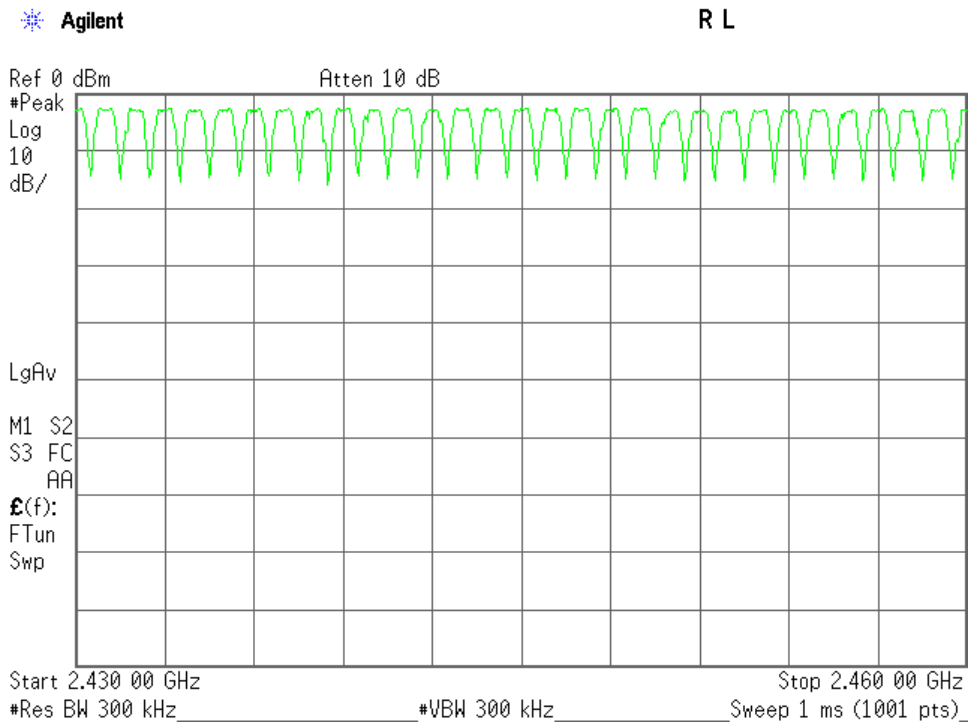

Mode of EUT : Hopping(3/3)

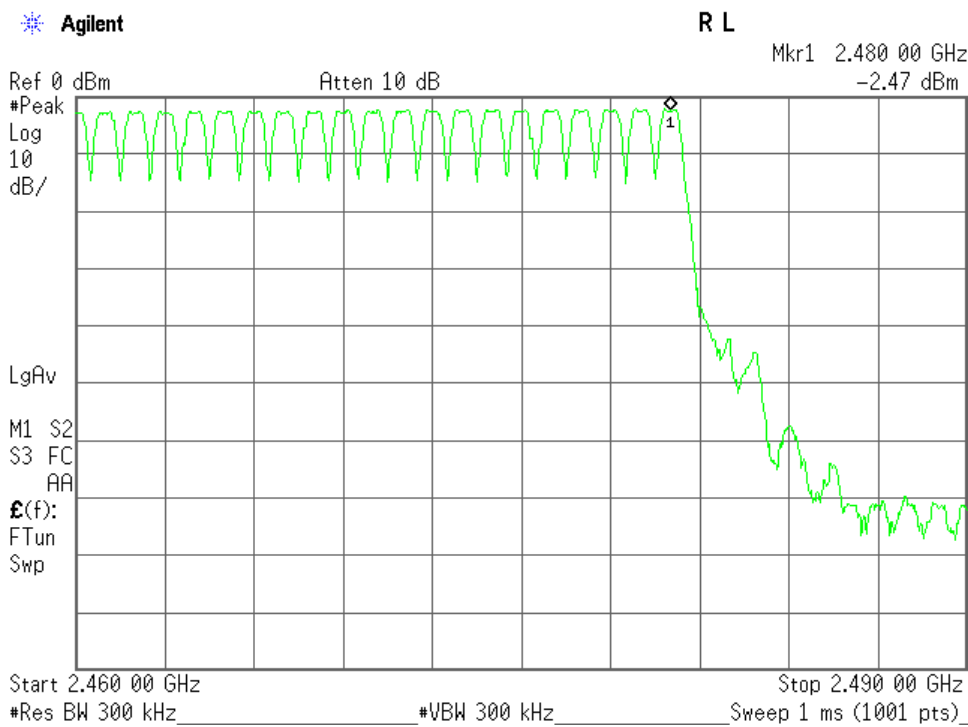

Mode of EUT : Inquiry(1/3)

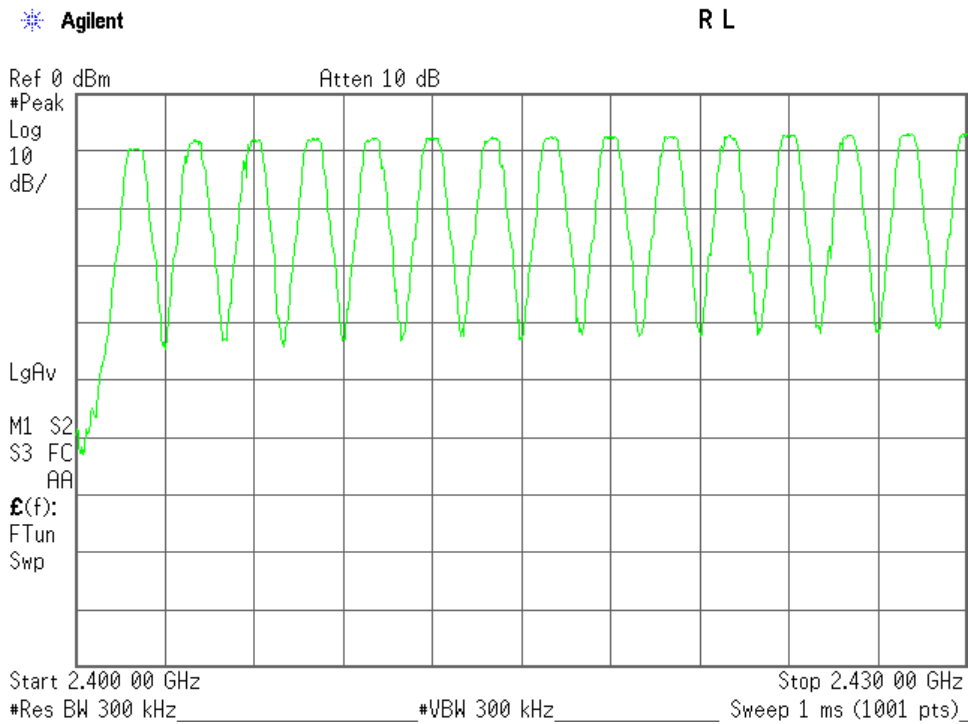

Mode of EUT : Inquiry(2/3)

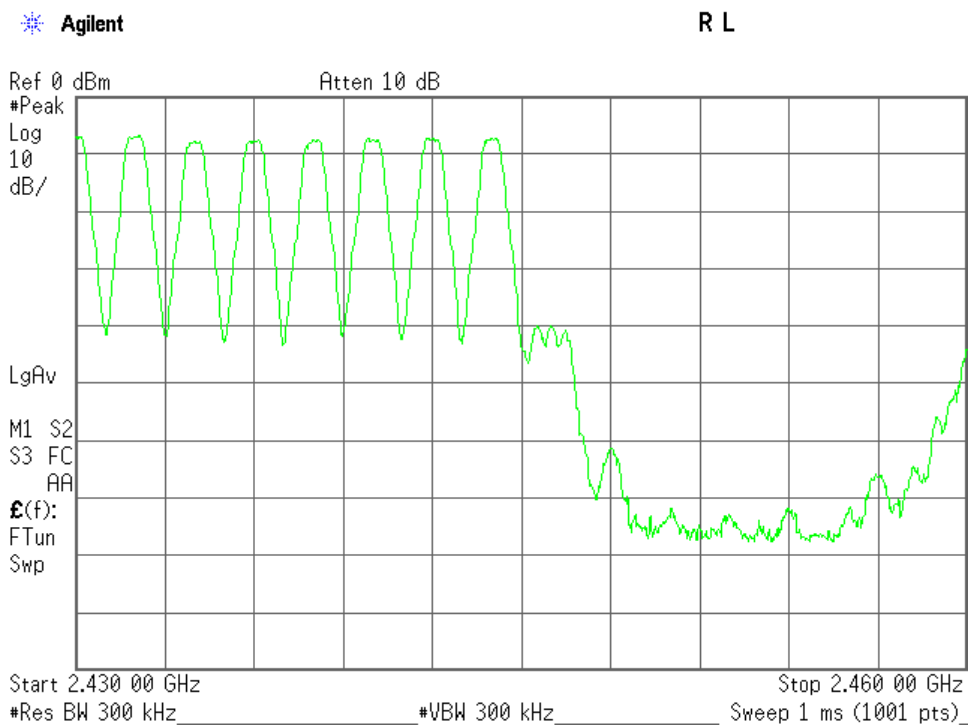



Mode of EUT : Inquiry(3/3)

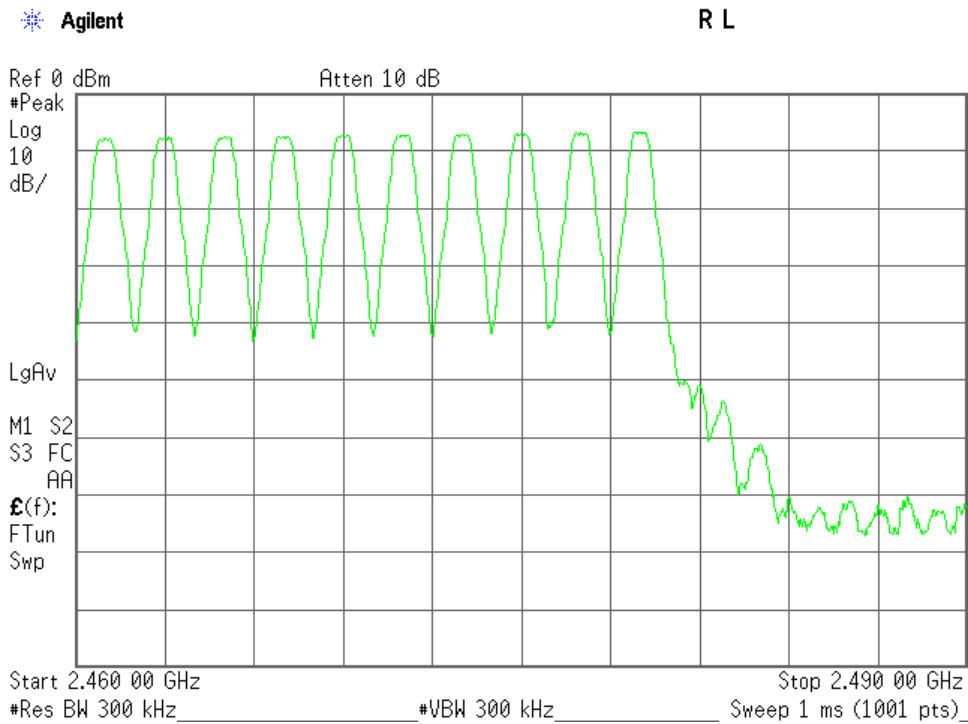

Mode of EUT : AFH(minimum)(1/3)

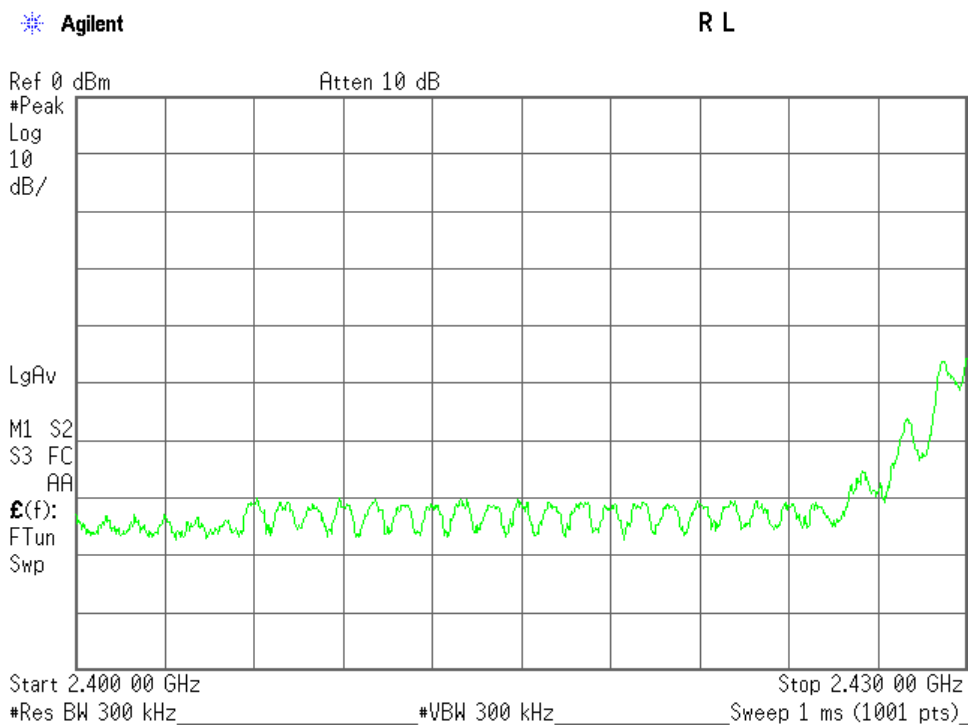

Mode of EUT : AFH(minimum) (2/3)

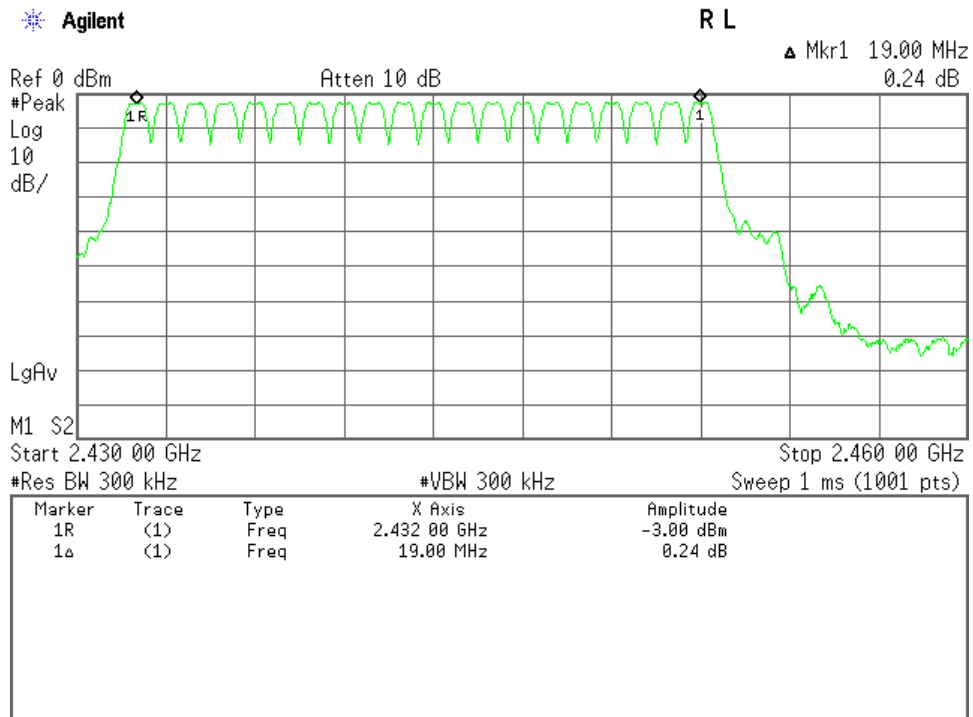

Mode of EUT : AFH(minimum) (3/3)

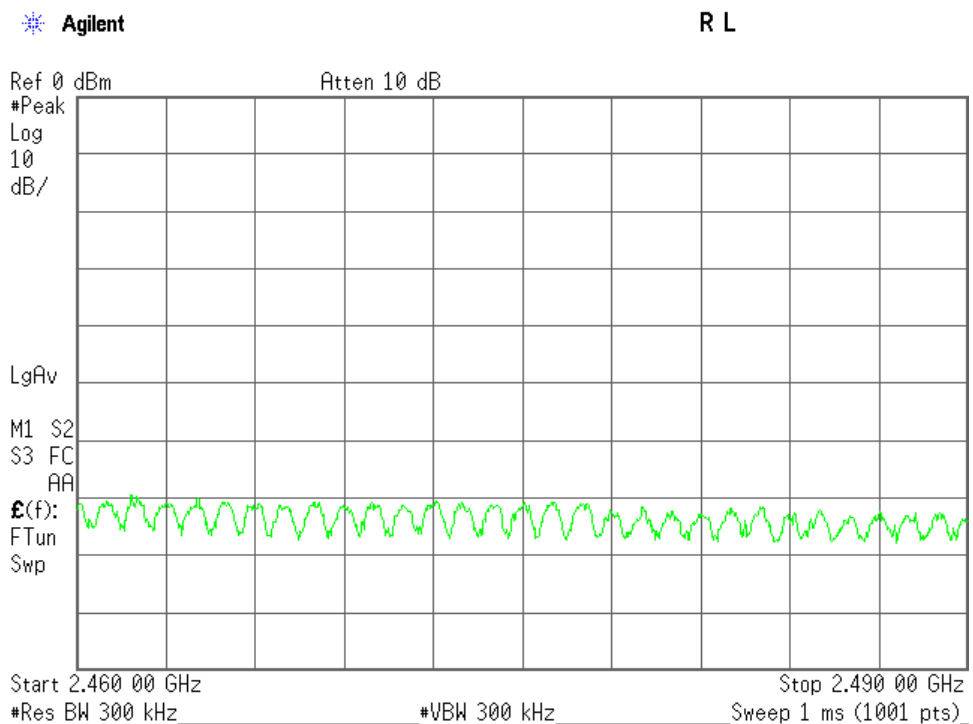

### 7.3 Occupied Bandwidth

For the requirements,  - Applicable [  - Tested.  - Not tested by applicant request. ]  
 - Not Applicable

#### 7.3.1 Test Results

For the standard,  - Passed  - Failed  - Not judged

The 99% Bandwidth is 1165.6 kHz at 2402.0 MHz  
 The 20dB Bandwidth is 1269.0 kHz at 2480 MHz

Uncertainty of Measurement Results ± 0.9 %(2σ)

Remarks : \_\_\_\_\_

#### 7.3.2 Test Instruments

Shielded Room S4				
Type	Model	Serial No. (ID)	Manufacturer	Cal. Due
Spectrum Analyzer	E4446A	US44300388 (A-39)	Agilent	2017/08/02
Attenuator	54A-10	W5675 (D-28)	Weinschel	2017/08/02
RF Cable	SUCOFLEX102	14253/2 (C-52)	HUBER+SUHNER	2017/08/02

NOTE : The calibration interval of the above test instruments is 12 months.

#### 7.3.3 Test Method and Test Setup (Diagrammatic illustration)

The test system is shown as follows:

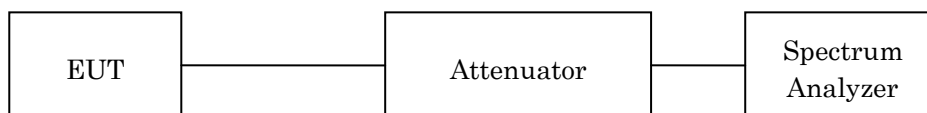

The setting of the spectrum analyzer are shown as follows:

Res. Bandwidth	30 kHz
Video Bandwidth	91 kHz
Span	2 MHz / 3 MHz
Sweep Time	AUTO
Trace	Maxhold

### 7.3.4 Test Data

Mode of EUT : BDR+EDR

Test Date : February 13, 2017

Temp.:22°C, Humi:29%

The resolution bandwidth was set to about 1% of emission bandwidth, -20dBc display line was placed on the screen (or 99% bandwidth), the occupied bandwidth is the delta frequency between the two points where the display line intersects the signal trace.

1)Packet Setting : DH5(Modulation type : GFSK)

Channel	Frequency (MHz)	99% Bandwidth (kHz)	-20dBc Bandwidth (kHz)	Two-thirds of the 20 dB bandwidth (kHz)
00	2402.0	873.2	946.6	631.1
39	2441.0	862.0	940.9	627.3
78	2480.0	858.6	942.6	628.4

2)Packet Setting : 2DH5(Modulation type : pi/4-DQPSK)

Channel	Frequency (MHz)	99% Bandwidth (kHz)	-20dBc Bandwidth (kHz)	Two-thirds of the 20 dB bandwidth (kHz)
00	2402.0	1165.6	1236.0	824.0
39	2441.0	1163.3	1236.0	824.0
78	2480.0	1107.3	1188.0	792.0

3)Packet Setting : 3DH5(Modulation type : 8DPSK)

Channel	Frequency (MHz)	99% Bandwidth (kHz)	-20dBc Bandwidth (kHz)	Two-thirds of the 20 dB bandwidth (kHz)
00	2402.0	1153.5	1260.0	840.0
39	2441.0	1152.2	1262.0	841.3
78	2480.0	1154.6	1269.0	846.0

1) Packet Setting : DH5 (Modulation type : GFSK)  
Low Channel

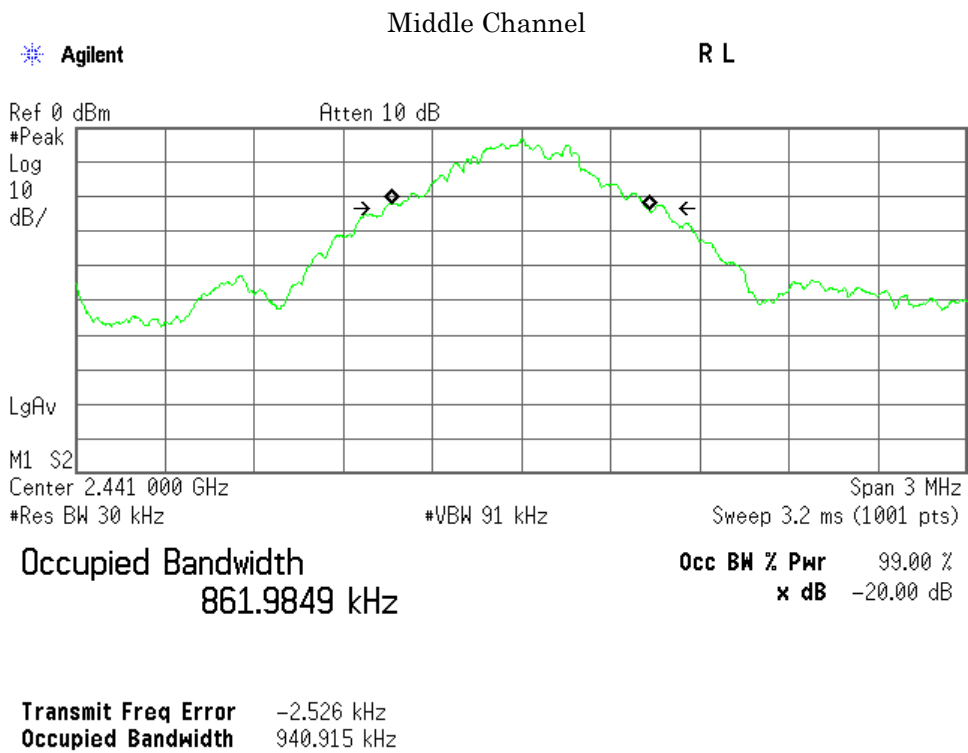
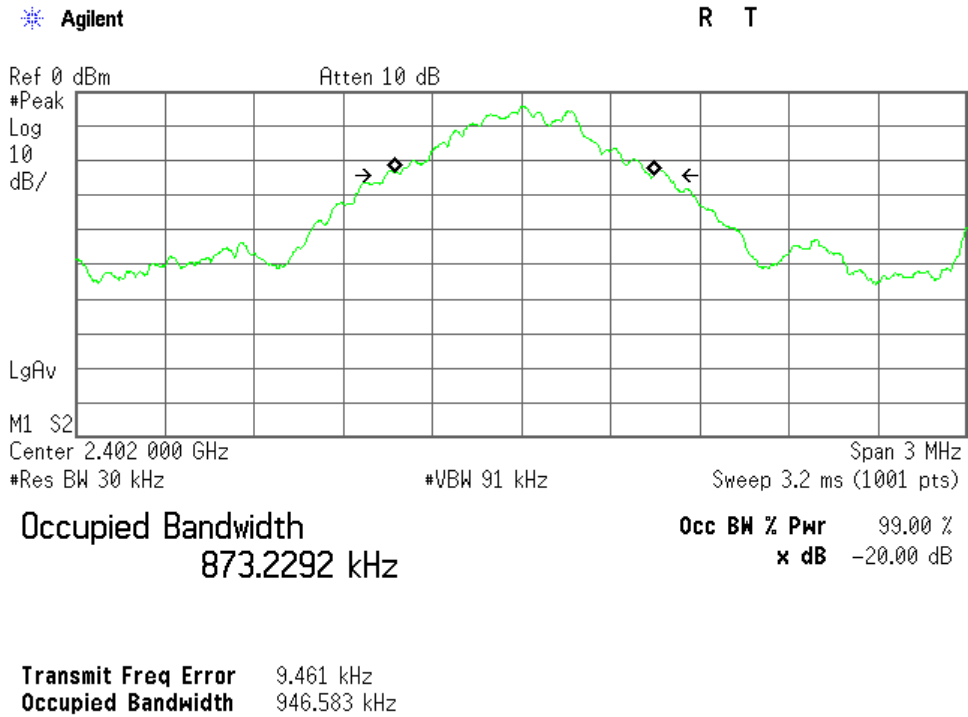

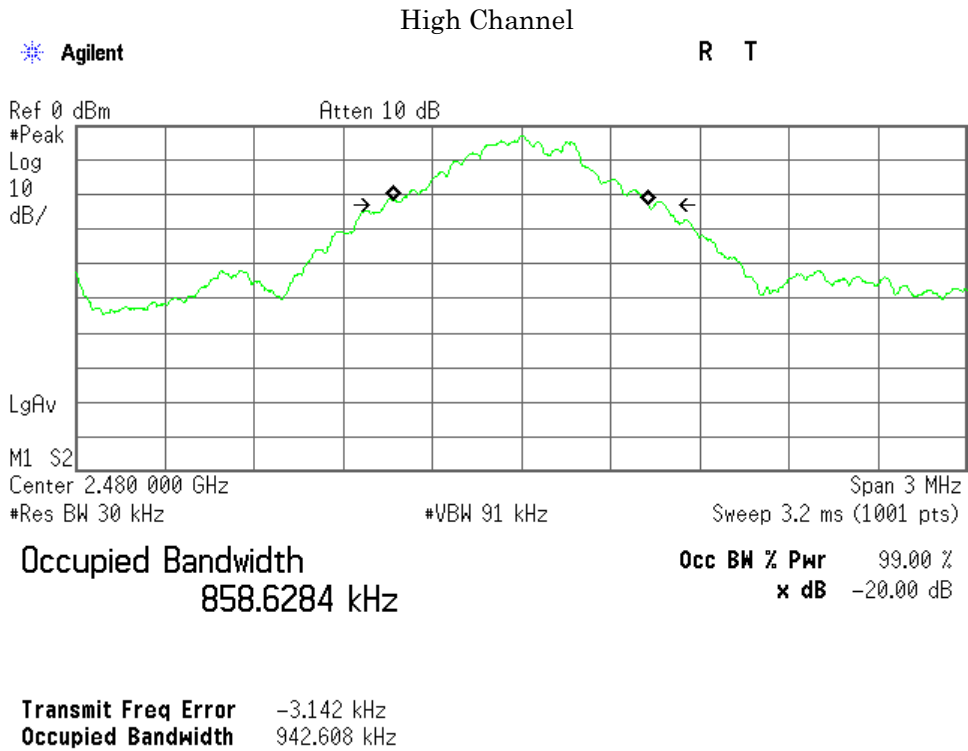

2)Packet Setting : 2DH5(Modulation type : pi/4-DQPSK)  
 Low Channel

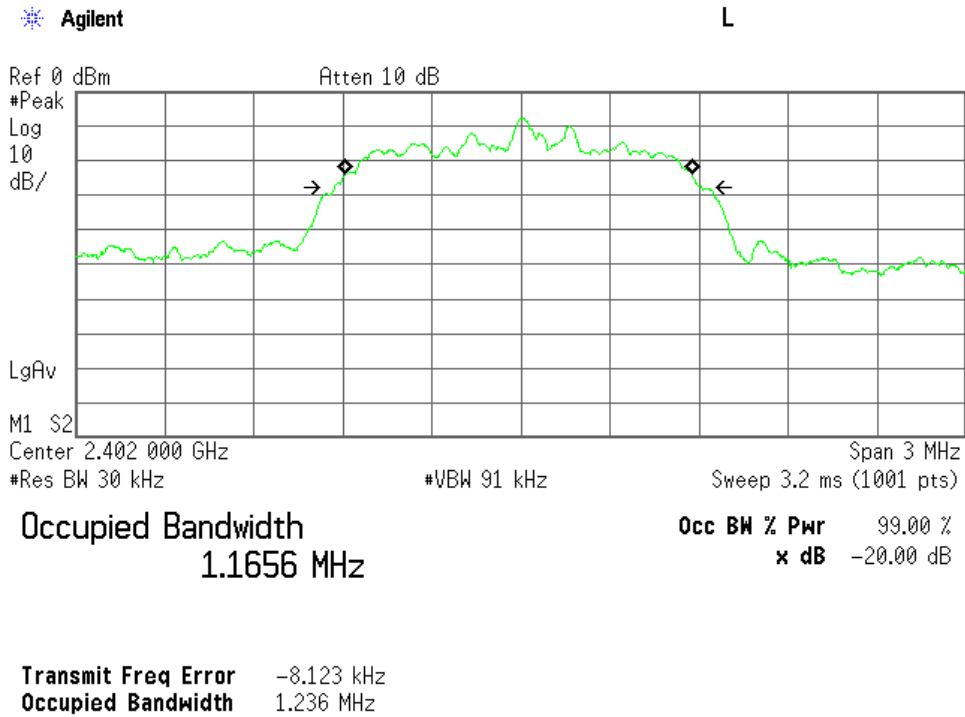

Middle Channel

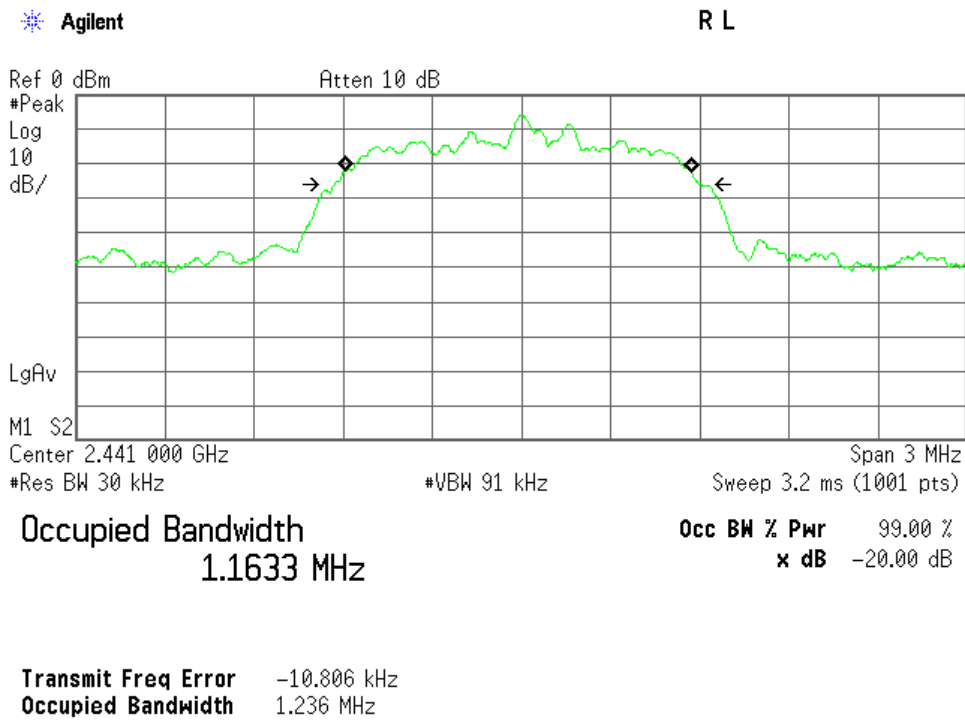

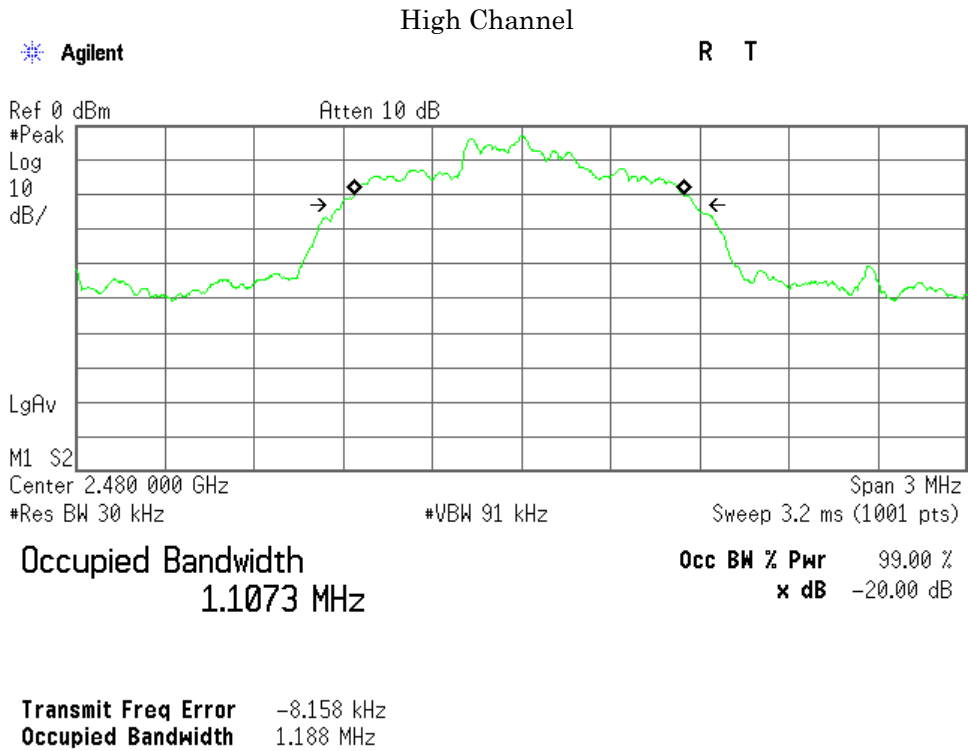



3)Packet Setting : 3 DH5(Modulation type : 8DPSK)  
Low Channel

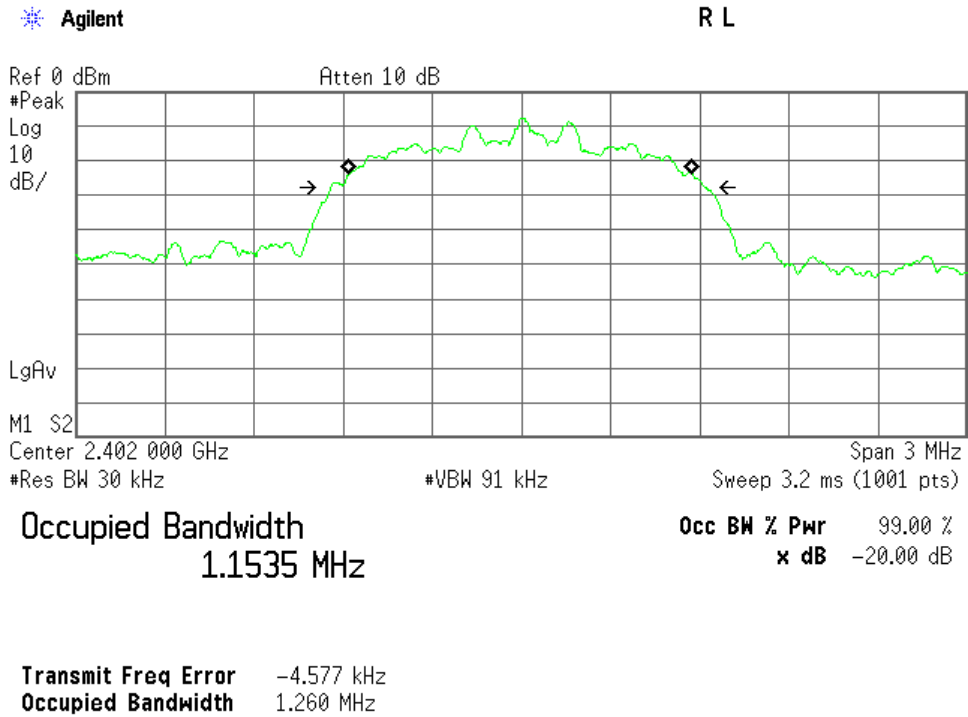

Middle Channel

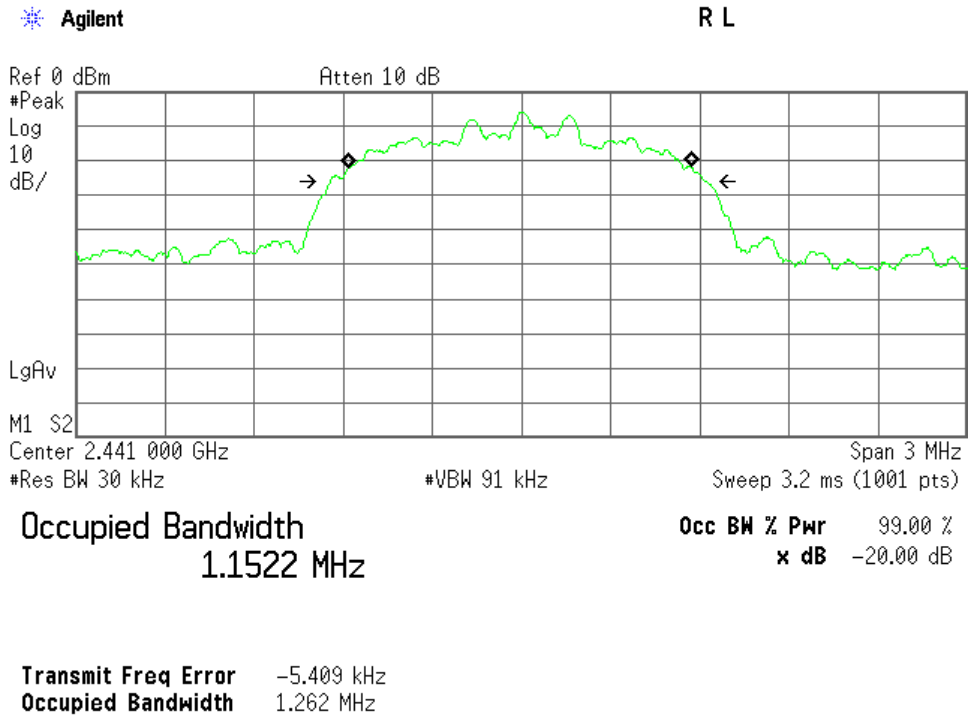

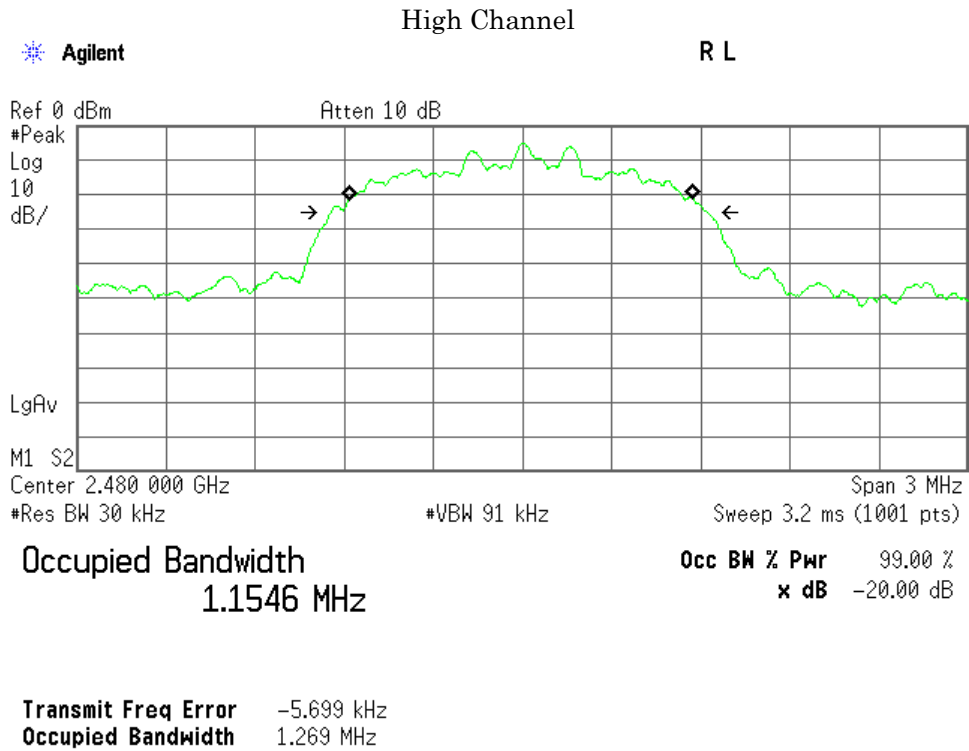

Mode of EUT : Inquiry

Test Date : February 13, 2017

Temp.:22°C, Humi:29%

The resolution bandwidth was set to about 1% of emission bandwidth, -20dBc display line was placed on the screen (or 99% bandwidth), the occupied bandwidth is the delta frequency between the two points where the display line intersects the signal trace.

Frequency (MHz)	99% Bandwidth (kHz)	-20dBc Bandwidth (kHz)	Two-thirds of the 20 dB bandwidth (kHz)
2441.0	825.9	764.4	509.6

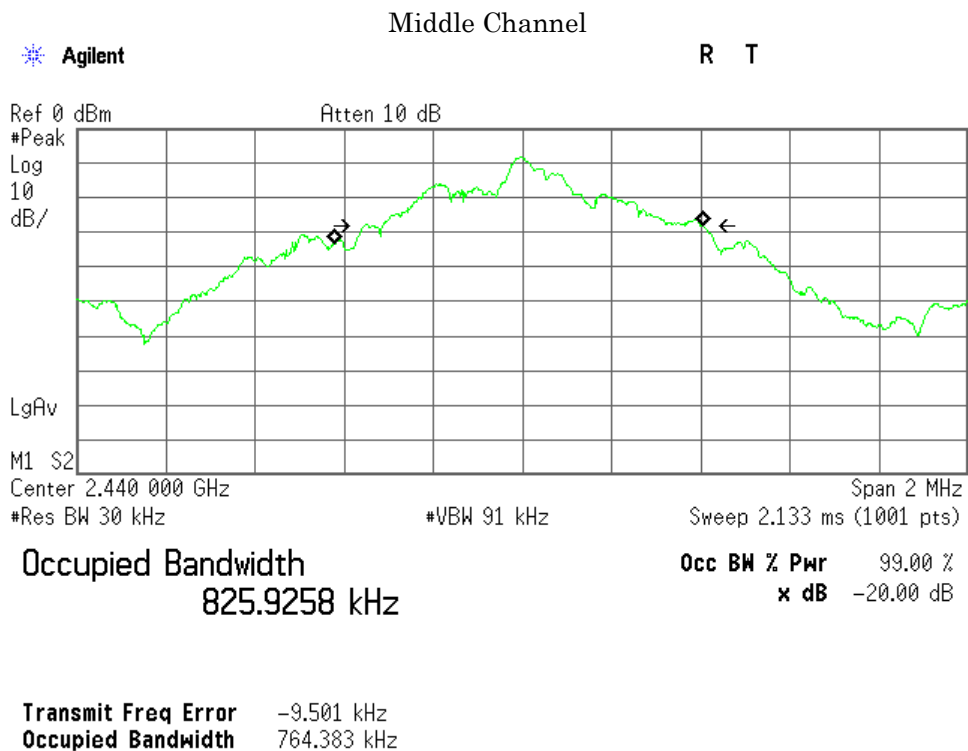

#### 7.4 Dwell Time

For the requirements,  - Applicable [  - Tested.  - Not tested by applicant request. ]  
 - Not Applicable

##### 7.4.1 Test Results

For the standard,  - Passed  - Failed  - Not judged

Dwell Time is 311.6 msec  
 Dwell Time (Inquiry) is 82.3 msec  
 Dwell Time (AFH) is 311.6 msec

Uncertainty of Measurement Results ± 0.6 %(2σ)

Remarks : \_\_\_\_\_

##### 7.4.2 Test Instruments

Shielded Room S4				
Type	Model	Serial No. (ID)	Manufacturer	Cal. Due
Spectrum Analyzer	E4446A	US44300388 (A-39)	Agilent	2017/08/02
Attenuator	54A-10	W5675 (D-28)	Weinschel	2017/08/02
RF Cable	SUCOFLEX102	14253/2 (C-52)	HUBER+SUHNER	2017/08/02

NOTE : The calibration interval of the above test instruments is 12 months.

##### 7.4.3 Test Method and Test Setup (Diagrammatic illustration)

The test system is shown as follows:

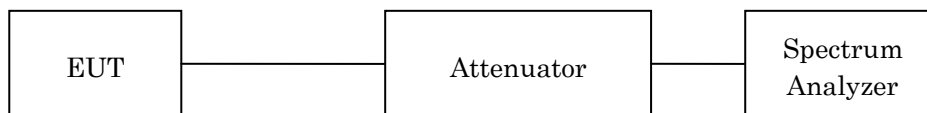

The setting of the spectrum analyzer are shown as follows:

Res. Bandwidth	1 MHz
Video Bandwidth	1 MHz
Span	Zero Span

**7.4.4 Test Data**

Test Date :April 25, 2016  
Temp.:23°C, Humi:52%

Mode of EUT	Dwell Time (msec)	Limit (msec)
DH1	133.1	400
DH3	267.8	400
DH5	311.6	400
Inquiry	82.3	400

DH1(Modulation type : GFSK)

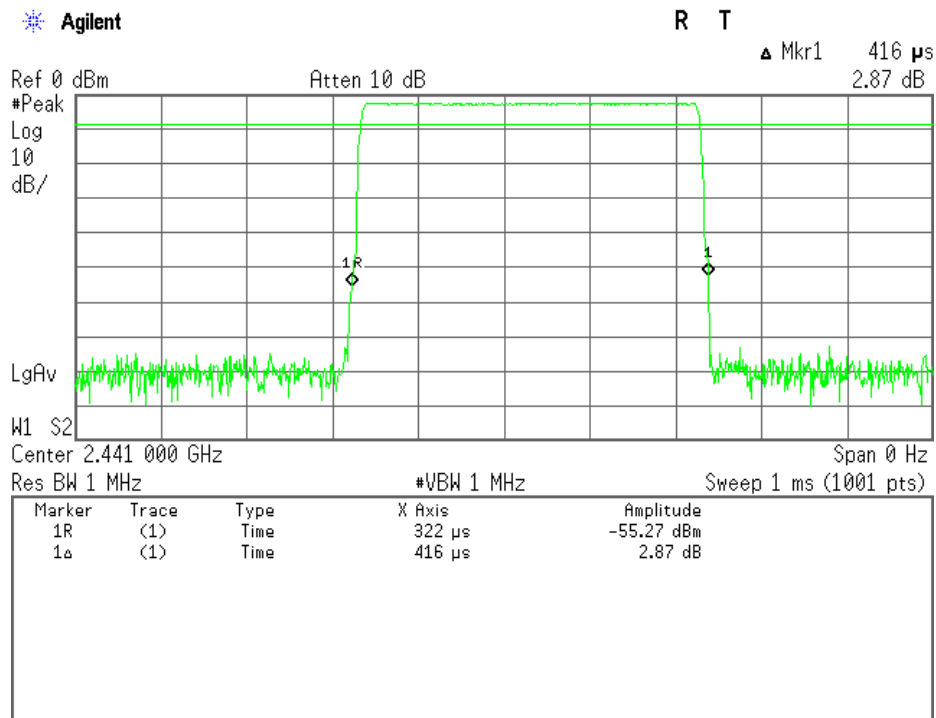

Note : The system makes worst case 1600 hops per second or 1 time slot has a length of 625 μs with 79 channels. A DH1 Packet need 1 time slot for transmitting and 1 time slot for receiving. Then the system makes worst case 800 hops per second with 79 channels. So the system has each channel 10.1266 times per second and so for 31.6 seconds the system have 320.0 times of appearance.

Each tx-time per appearance is 0.416 ms.

Dwell time = 320.0 \* 0.416 = 133.1 ms

DH3(Modulation type : GFSK)

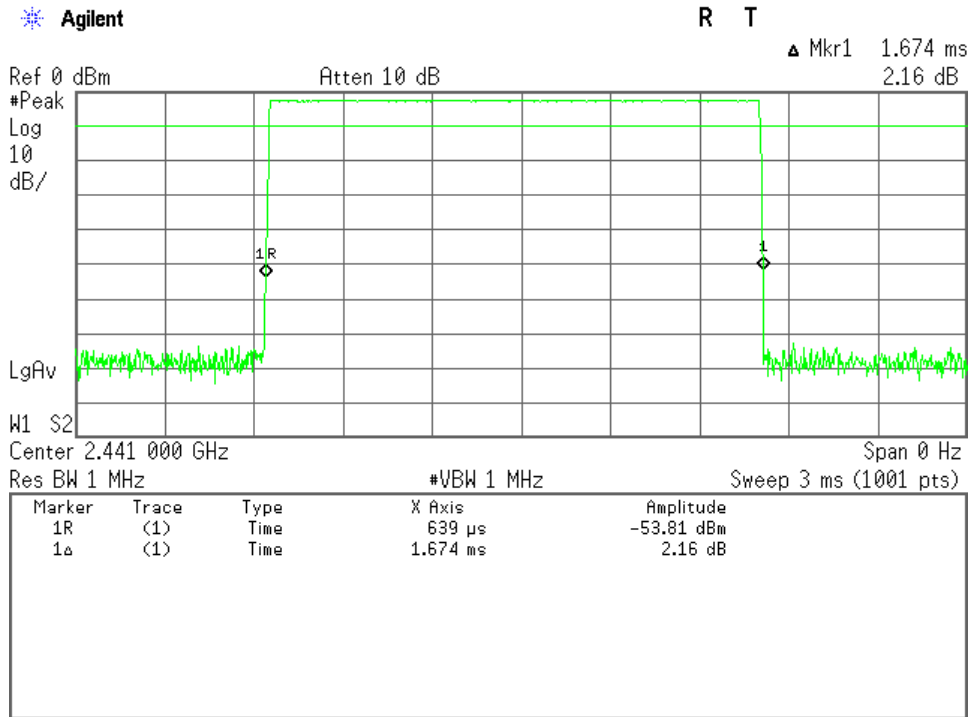

Note : A DH3 Packet need 3 time slot for transmitting and 1 time slot for receiving. Then the system makes worst case 400 hops per second with 79 channels. So the system have each channel 5.063 times per second and so for 31.6 seconds the system have 160.0 times of appearance. Each tx-time per appearance is 1.674 ms.  
Dwell time = 160.0 \* 1.674 = 267.84 ms

DH5(Modulation type : GFSK)

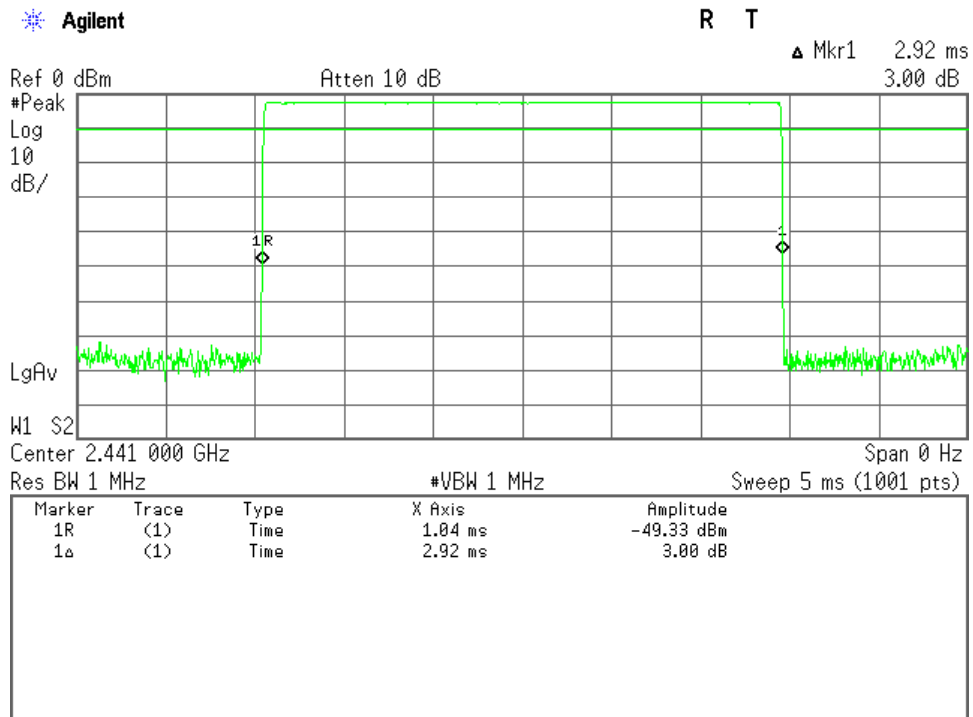

Note : A DH5 Packet need 5 time slot for transmitting and 1 time slot for receiving. Then the system makes worst case 266.667 hops per second with 79 channels. So the system have each channel 3.3755 times per second and so for 31.6 seconds the system have 106.7 times of appearance. Each tx-time per appearance is 2.92 ms.  
 Dwell time = 106.7 \* 2.92 = 311.6 ms

Inquiry

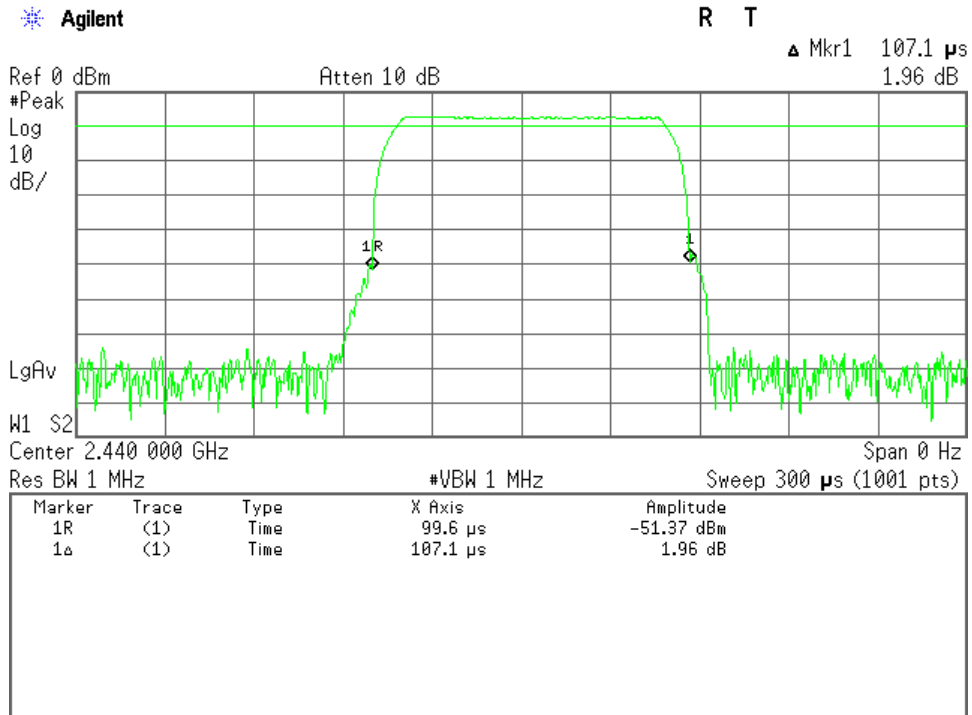

Note : The system have 32 hopping channel in Inquiry mode.

The time period =  $32 * 0.4 = 12.8$  seconds

In maximum case the Bluetooth system have three blocks of 2560 ms in 12.8 s period. One block has 256 burst at each hopping channel.

Each tx-time per appearance is 0.1071 ms.

Dwell time =  $0.1071 * 256 * 3 = 82.3$  ms



Mode of EUT	Dwell Time (msec)	Limit (msec)
DH1(AFH)	131.8	400
DH3(AFH)	267.4	400
DH5(AFH)	311.6	400

DH1(AFH mode, Modulation type : GFSK)

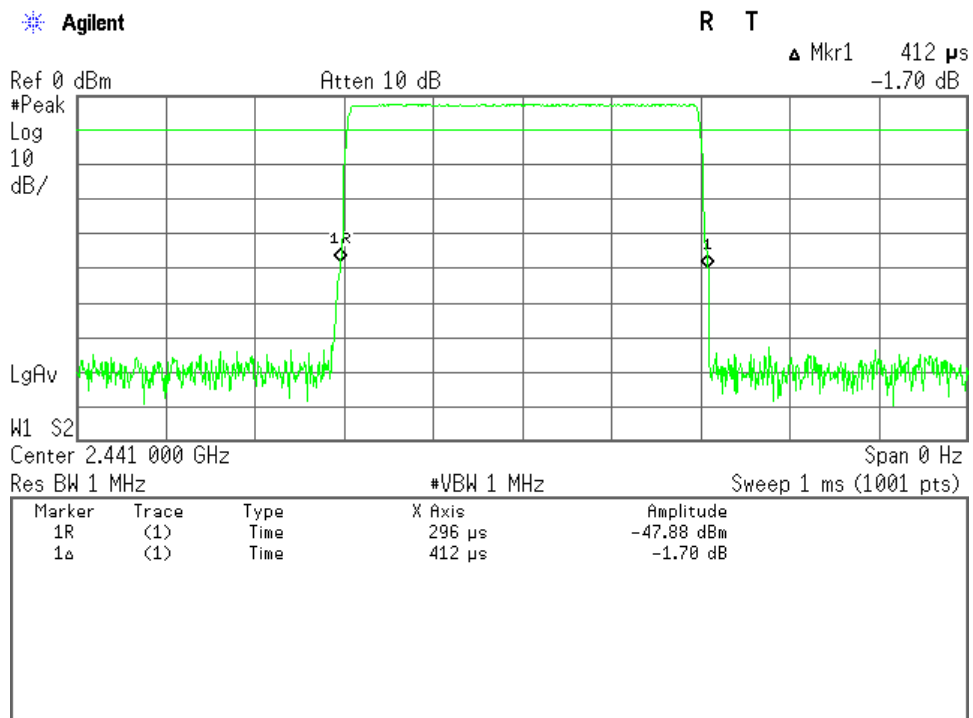

Note : The system makes worst case 1600 hops per second or 1 time slot has a length of 625 μs with 79 channels. A DH1 Packet need 1 time slot for transmitting and 1 time slot for receiving. Then the system makes worst case 800 hops per second with 20 channels. So the system has each channel 40 times per second and so for 8 seconds the system have 320.0 times of appearance. Each tx-time per appearance is 0.412 ms.  
Dwell time = 320.0 \* 0.412 = 131.8 ms

DH3(AFH mode, Modulation type : GFSK)

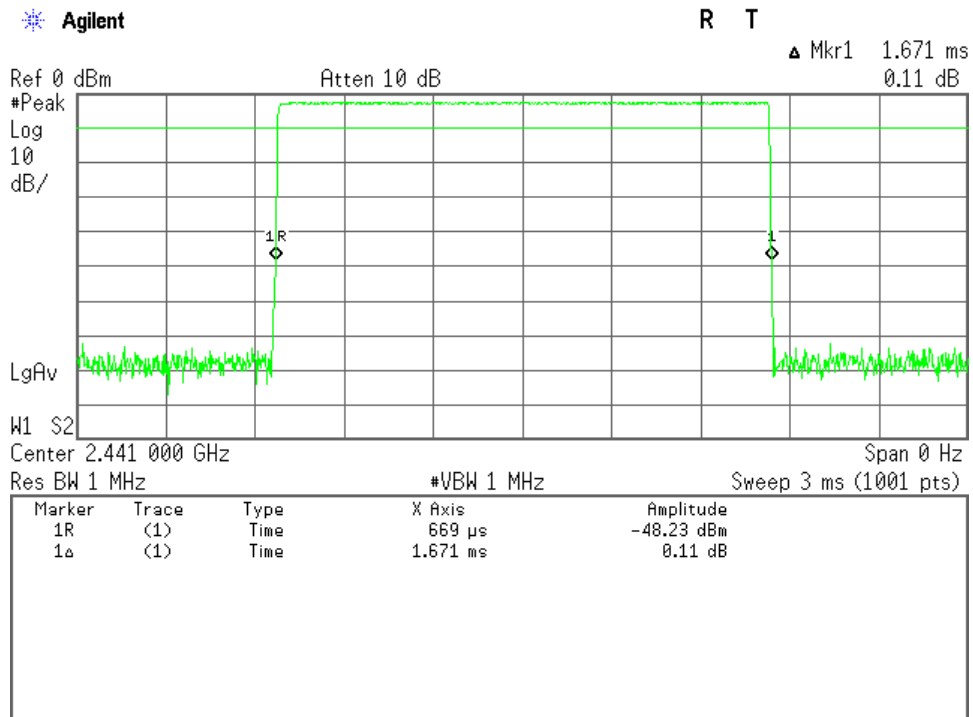

Note : A DH3 Packet need 3 time slot for transmitting and 1 time slot for receiving. Then the system makes worst case 400 hops per second with 20 channels. So the system have each channel 20 times per second and so for 8 seconds the system have 160.0 times of appearance. Each tx-time per appearance is 1.671 ms.  
 Dwell time = 160.0 \* 1.671 = 267.4 ms

DH5(AFH mode, Modulation type : GFSK)

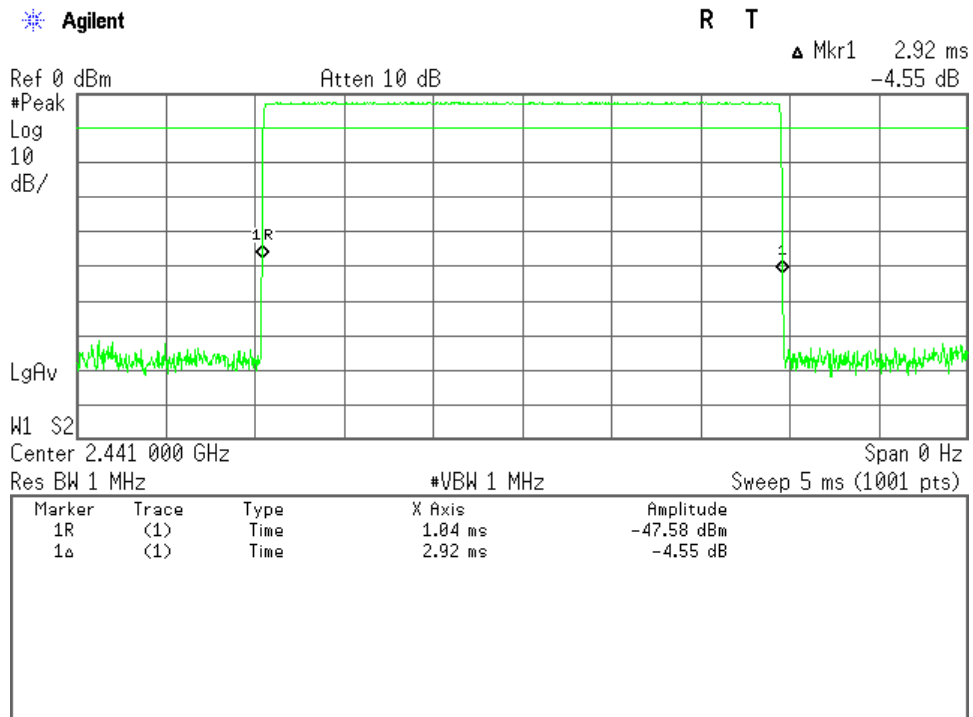

Note : A DH5 Packet need 5 time slot for transmitting and 1 time slot for receiving. Then the system makes worst case 266.667 hops per second with 20 channels. So the system have each channel 13.33335 times per second and so for 8 seconds the system have 106.7 times of appearance. Each tx-time per appearance is 2.920 ms.  
 Dwell time = 106.7 \* 2.920 = 311.6 ms

**7.5 Peak Output Power(Conduction)**

For the requirements,  - Applicable [  - Tested.  - Not tested by applicant request. ]  
 - Not Applicable

**7.5.1 Test Results**

For the standard,  - Passed  - Failed  - Not judged

Peak Output Power is 8.27 dBm at 2480.0 MHz

Uncertainty of Measurement Results ± 0.9 dB(2σ)

Remarks : \_\_\_\_\_

**7.5.2 Test Instruments**

Shielded Room S4				
Type	Model	Serial No. (ID)	Manufacturer	Cal. Due
Power Meter	ML2495A	1423001 (B-16)	Anritsu	2017/07/10
Power Sensor	MA2411B	1339136 (B-18)	Anritsu	2017/07/10
Attenuator	54A-10	W5675 (D-28)	Weinschel	2017/08/02
RF Cable	SUCOFLEX102	14253/2 (C-52)	HUBER+SUHNER	2017/08/02

NOTE : The calibration interval of the above test instruments is 12 months.

**7.5.3 Test Method and Test Setup (Diagrammatic illustration)**

The Conducted RF Power Output was measured with a power meter, one attenuator and a short, low loss cable.

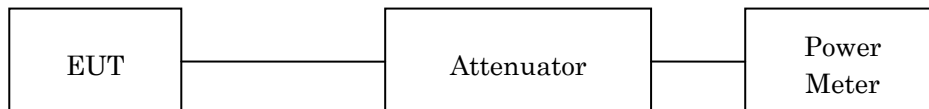

### 7.5.4 Test Data

1)DH5(Modulation type : GFSK)

Test Date: February 13, 2017  
Temp.: 22 °C, Humi: 29 %

CH	Transmitting Frequency	Correction Factor	Meter Reading	Conducted		Limits	Margin
	[MHz]			Peak Output Power	[mW]		
		[dB]	[dBm]	[dBm]		[dBm]	[dB]
00	2402	10.37	-3.49	6.88	4.88	20.97	+14.09
39	2441	10.37	-2.57	7.80	6.03	20.97	+13.17
78	2480	10.37	-2.10	8.27	6.71	20.97	+12.70

Calculated result at 2480.000 MHz, as the worst point shown on underline:

Correction Factor	=	10.37 dB
+ ) Meter Reading	=	-2.10 dBm
Result	=	8.27 dBm = 6.71 mW

Minimum Margin: 20.97 - 8.27 = 12.70 (dB)

#### NOTES

- The correction factor shows the attenuation pad loss including the short, low loss cable or adapter.
- Setting of measuring instrument(s) :

Detector Function	Video B.W.
Peak	Off

\*\*Although AC power supply voltage was changed from 102VAC to 138VAC, the Peak Output Power did not change.

2) 2DH5(Modulation type : pi/4-DQPSK)

Test Date: February 13, 2017

Temp.: 22 °C, Humi: 29 %

CH	Transmitting Frequency	Correction Factor	Meter Reading	Conducted		Limits	Margin
	[MHz]			[dBm]	Peak Output Power		
00	2402	10.37	-5.45	4.92	3.10	20.97	+16.05
39	2441	10.37	-3.84	6.53	4.50	20.97	+14.44
78	2480	10.37	-3.31	7.06	5.08	20.97	+13.91

Calculated result at 2480.000 MHz, as the worst point shown on underline:

Correction Factor	=	10.37 dB
+ ) Meter Reading	=	-3.31 dBm
Result	=	7.06 dBm = 5.08 mW

Minimum Margin: 20.97 - 7.06 = 13.91 (dB)

NOTES

- The correction factor shows the attenuation pad loss including the short, low loss cable or adapter.
- Setting of measuring instrument(s) :

Detector Function	Video B.W.
Peak	Off

\*\*Although AC power supply voltage was changed from 102VAC to 138VAC, the Peak Output Power did not change.

3) 3DH5(Modulation type : 8DPSK)

Test Date: February 13, 2017

Temp.: 22 °C, Humi: 29 %

CH	Transmitting Frequency [MHz]	Correction Factor [dB]	Meter Reading [dBm]	Conducted		Limits [dBm]	Margin [dB]
				Peak Output Power [dBm]	[mW]		
00	2402	10.37	-5.13	5.24	3.34	20.97	+15.73
39	2441	10.37	-3.59	6.78	4.76	20.97	+14.19
78	2480	10.37	-3.13	7.24	5.30	20.97	+13.73

Calculated result at 2480.000 MHz, as the worst point shown on underline:

Correction Factor	=	10.37 dB
+ ) Meter Reading	=	-3.13 dBm
Result	=	7.24 dBm = 5.30 mW

Minimum Margin: 20.97 - 7.24 = 13.73 (dB)

NOTES

- The correction factor shows the attenuation pad loss including the short, low loss cable or adapter.
- Setting of measuring instrument(s) :

Detector Function	Video B.W.
Peak	Off

\*\*Although AC power supply voltage was changed from 102VAC to 138VAC, the Peak Output Power did not change.

**7.6 Peak Power Density(Conduction)**

For the requirements,  - Applicable [  - Tested.  - Not tested by applicant request. ]  
 - Not Applicable

Remarks : \_\_\_\_\_

**7.7 Spurious Emissions(Conduction)**

For the requirements,  - Applicable [  - Tested.  - Not tested by applicant request. ]  
 - Not Applicable

**7.7.1 Test Results**

For the standard,  - **Passed**  - **Failed**  - **Not judged**

Uncertainty of Measurement Results	9 kHz – 1 GHz	<u>± 1.4</u>	dB(2 $\sigma$ )
	1 GHz – 18 GHz	<u>± 1.7</u>	dB(2 $\sigma$ )
	18 GHz – 40 GHz	<u>± 2.3</u>	dB(2 $\sigma$ )

Remarks : \_\_\_\_\_



**7.7.2 Test Instruments**

Shielded Room S4				
Type	Model	Serial No. (ID)	Manufacturer	Cal. Due
Spectrum Analyzer	E4446A	US44300388 (A-39)	Agilent	2017/08/02
Attenuator	54A-10	W5675 (D-28)	Weinschel	2017/08/02
RF Cable	SUCOFLEX102	14253/2 (C-52)	HUBER+SUHNER	2017/08/02

NOTE : The calibration interval of the above test instruments is 12 months.

**7.7.3 Test Method and Test Setup (Diagrammatic illustration)**

The test system is shown as follows:

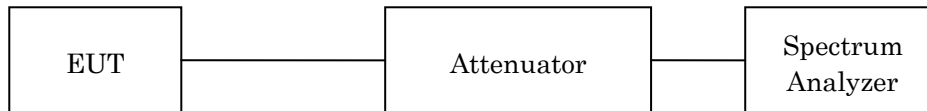

The setting of the spectrum analyzer are shown as follows:

Frequency Range	30 MHz - 25 GHz	Band-Edge
Res. Bandwidth	100 kHz	100 kHz
Video Bandwidth	300 kHz	300 kHz
Sweep Time	AUTO	AUTO
Trace	Maxhold	Maxhold

## 7.7.4 Test Data

Test Date : February 13, 2017

Temp.: 22°C, Humi: 29%

Mode of EUT : BDR (worst case)

### Low Channel

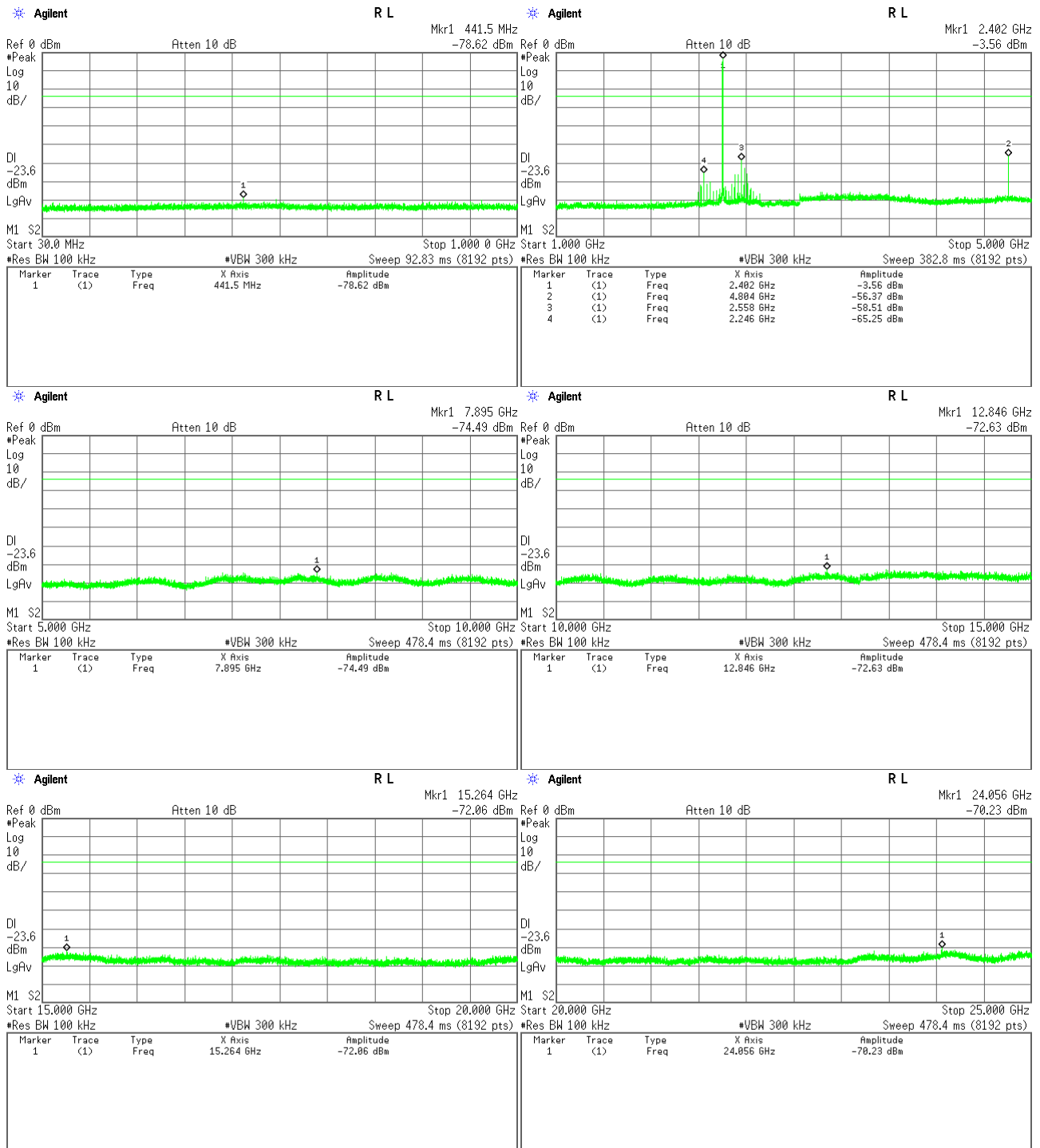

## Middle Channel

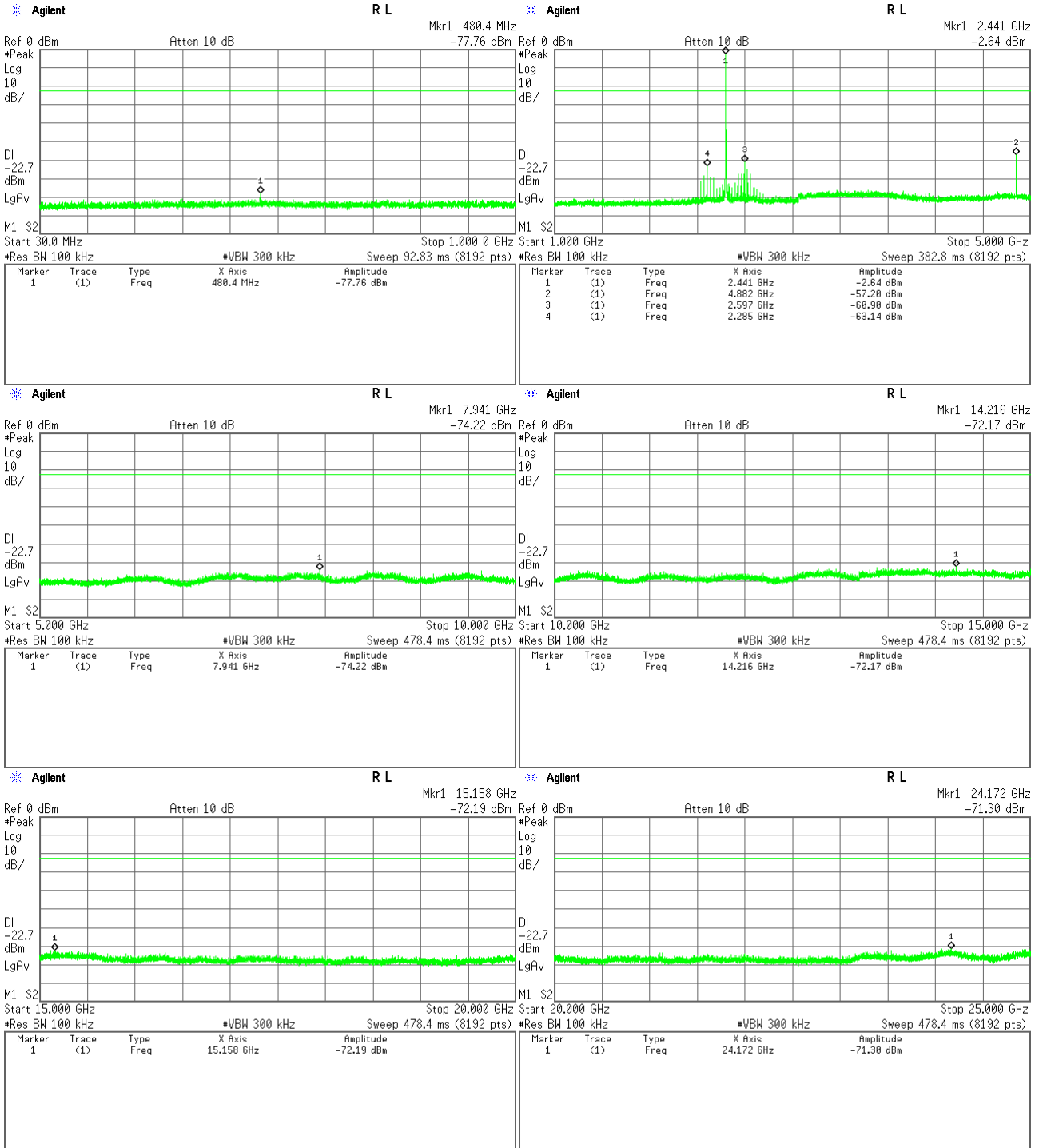

## High Channel

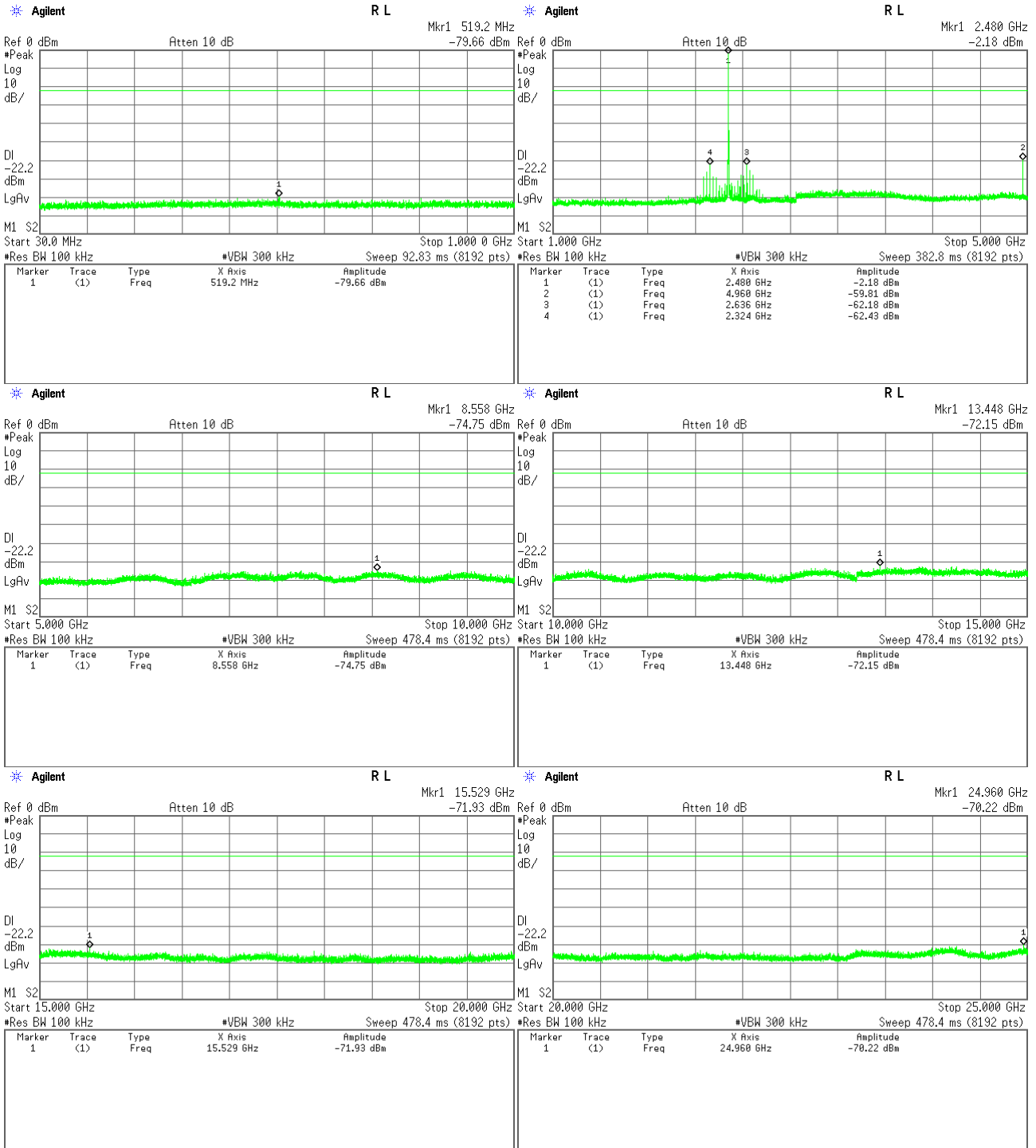

**Band-Edge Emission**

Low Channel(Hopping off), Band-Edge Emission

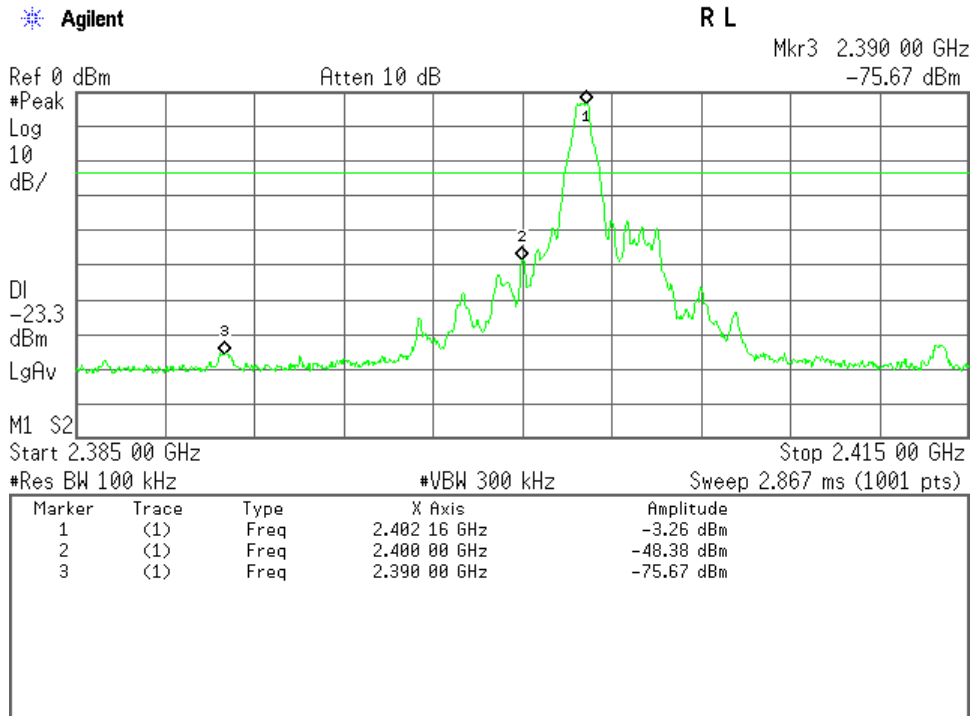

High Channel(Hopping off), Band-Edge Emission

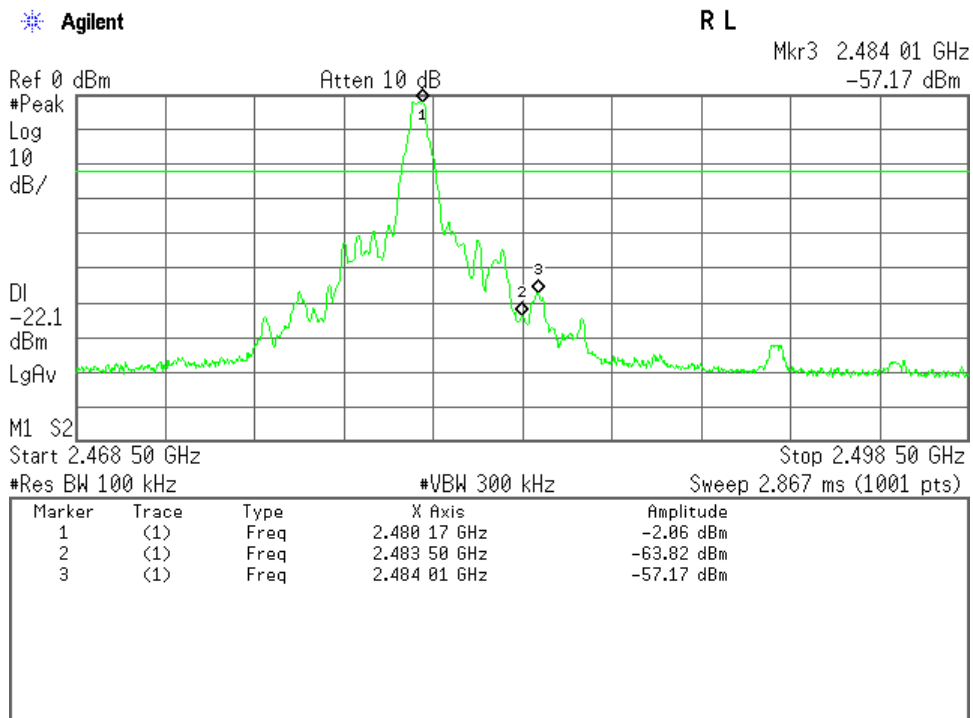

Low Channel(Hopping on), Band-Edge Emission

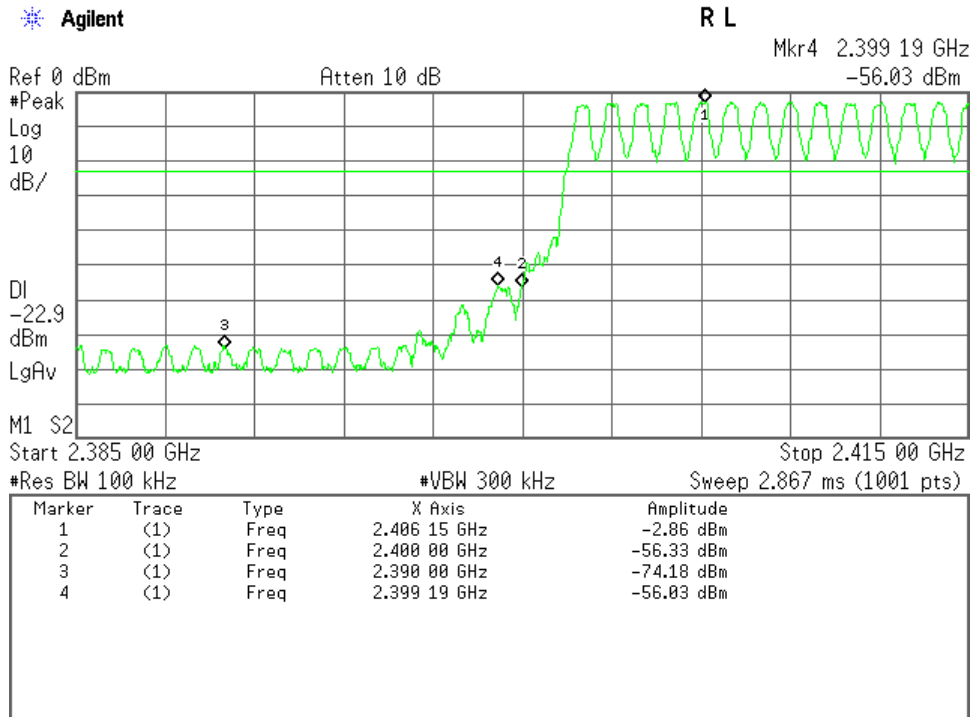

High Channel(Hopping on), Band-Edge Emission

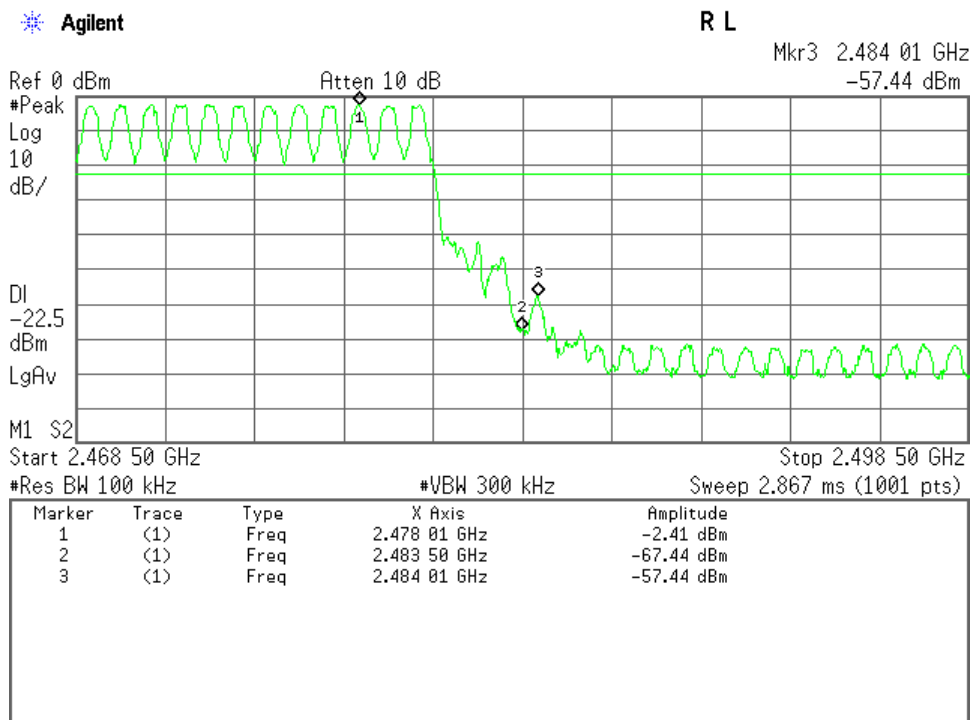

**7.8 AC Powerline Conducted Emission**

For the requirements,  - Applicable [  - Tested.  - Not tested by applicant request. ]  
 - Not Applicable

**7.8.1 Test Results**

For the standard,  - Passed  - Failed  - Not judged

Min. Limit Margin (Quasi-Peak) 5.5 dB at 7.310 MHz

Uncertainty of Measurement Results ± 2.6 dB(2σ)

Remarks : \_\_\_\_\_

**7.8.2 Test Instruments**

Shielded Room S2				
Type	Model	Serial No. (ID)	Manufacturer	Cal. Due
Test Receiver	ESCS 30	835418/005 (A-1)	Rohde & Schwarz	2017/04/10
AMN (main)	ESH3-Z5	893045/007 (D-12)	Rohde & Schwarz	2017/08/31
AMN (sub)	KNW-242	8-431-14 (D-7)	Kyoritsu	2017/11/03
Terminator	65 BNC-50-0-1	--- (H-25)	HUBER+SUHNER	2017/11/13
RF Cable	RG223/U	--- (H-7)	HUBER+SUHNER	2017/11/21

NOTE : The calibration interval of the above test instruments is 12 months.

**7.8.3 Test Method and Test Setup (Diagrammatic illustration)**

The preliminary tests were performed using the scan mode of test receiver or spectrum analyzer to observe the emissions characteristics of the EUT.

The EUT configuration, cable configuration and mode of operation were determined for producing the maximum level of emissions.

This configurations was used for final tests.

– Side View –

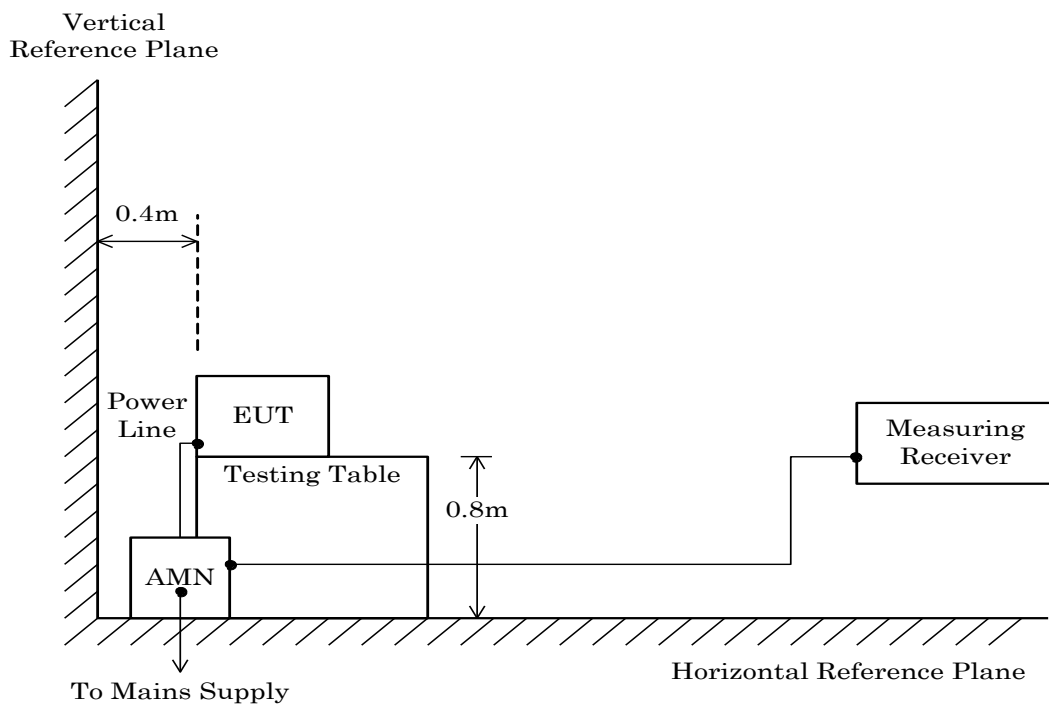

NOTE

AMN : Artificial Mains Network



### 7.8.4 Test Data

Mode of EUT : All modes have been investigated and the worst case mode for channel (39ch: 2480MHz) has been listed.

Test voltage : 120VAC 60Hz

Test Date: February 7, 2017  
Temp.: 23 °C, Humi.: 38 %

Measured phase : L1

Frequency [MHz]	Corr. Factor [dB]	Meter Readings [dB(μV)]		Limits [dB(μV)]		Results [dB(μV)]		Margin [dB]		Remarks
		QP	AVE	QP	AVE	QP	AVE	QP	AVE	
0.150	10.1	43.4	16.6	66.0	56.0	53.5	26.7	+12.5	+29.3	-
0.396	10.1	37.8	30.0	57.9	47.9	47.9	40.1	+10.0	+ 7.8	-
0.470	10.1	34.9	24.2	56.5	46.5	45.0	34.3	+11.5	+12.2	-
1.052	10.2	38.0	25.6	56.0	46.0	48.2	35.8	+ 7.8	+10.2	-
3.834	10.3	34.3	24.2	56.0	46.0	44.6	34.5	+11.4	+11.5	-
7.310	10.5	37.8	33.6	60.0	50.0	48.3	44.1	+11.7	+ 5.9	-

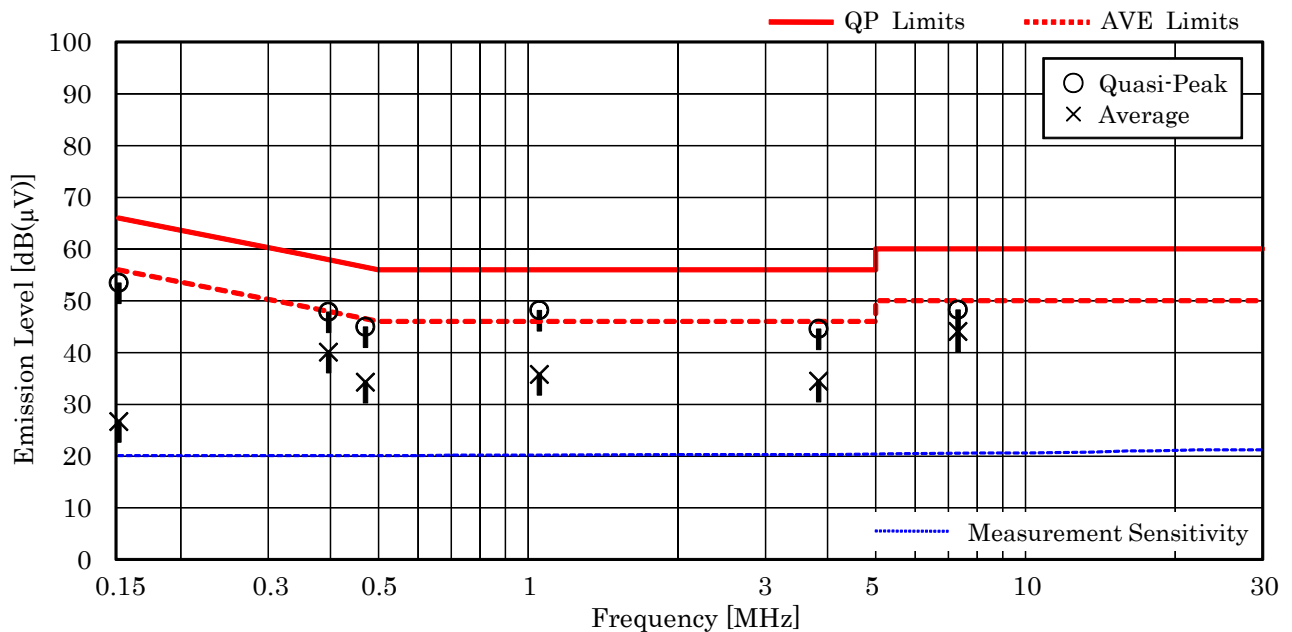

#### NOTES

1. The spectrum was checked from 150 kHz to 30 MHz.
2. The correction factor includes the AMN insertion loss and the cable loss.
3. The symbol of "<" means "or less".
4. The symbol of ">" means "more than".
5. The symbol of "--" means "not applicable".
6. Calculated result at 7.310 MHz, as the worst point shown on underline:  
 Correction Factor + Meter Reading (AVE) = 10.5 + 33.6 = 44.1 dB(μV)
7. QP : Quasi-Peak Detector / AVE : Average Detector
8. Test receiver setting(s) : CISPR QP 9 kHz / Average 9 kHz

Test voltage : 120VAC 60Hz

Test Date: February 7, 2017  
Temp.: 23 °C, Humi.: 38 %

Measured phase : L2

Frequency [MHz]	Corr. Factor [dB]	Meter Readings [dB(μV)]		Limits [dB(μV)]		Results [dB(μV)]		Margin [dB]		Remarks
		QP	AVE	QP	AVE	QP	AVE	QP	AVE	
0.150	10.1	43.6	16.9	66.0	56.0	53.7	27.0	+12.3	+29.0	-
0.396	10.1	36.4	28.8	57.9	47.9	46.5	38.9	+11.4	+ 9.0	-
0.470	10.1	31.8	21.6	56.5	46.5	41.9	31.7	+14.6	+14.8	-
1.052	10.3	37.8	25.8	56.0	46.0	48.1	36.1	+ 7.9	+ 9.9	-
3.834	10.3	33.5	23.6	56.0	46.0	43.8	33.9	+12.2	+12.1	-
7.310	10.6	38.0	33.9	60.0	50.0	48.6	44.5	+11.4	+ 5.5	-

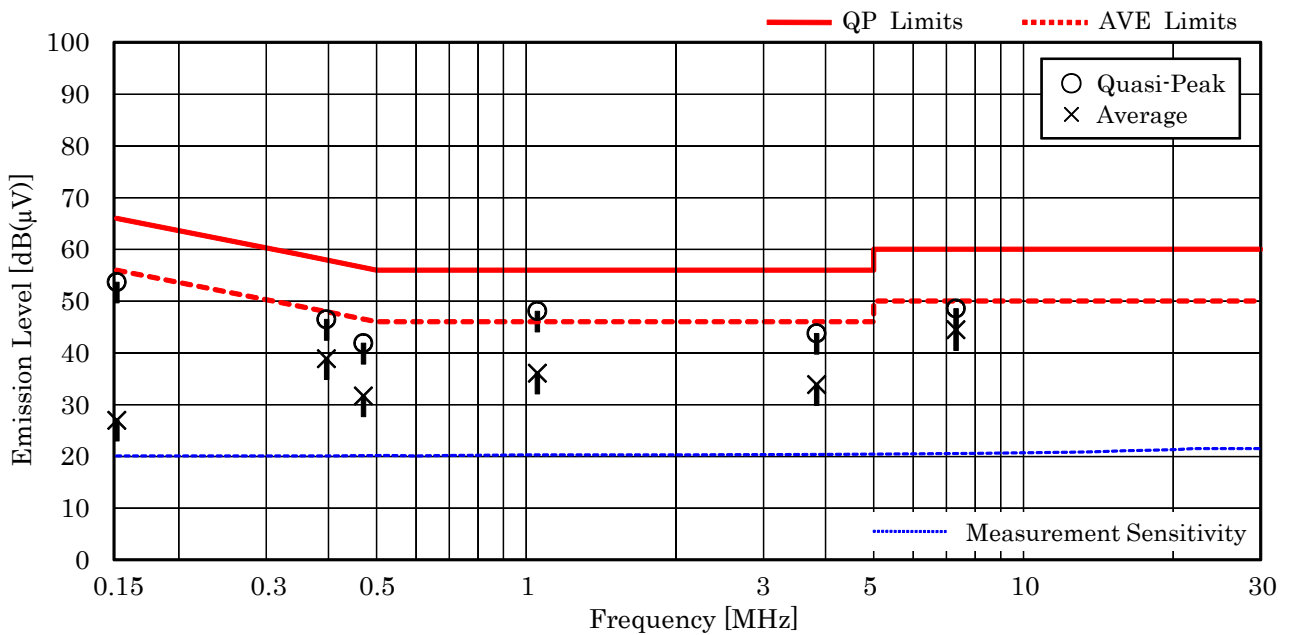

**NOTES**

1. The spectrum was checked from 150 kHz to 30 MHz.
2. The correction factor includes the AMN insertion loss and the cable loss.
3. The symbol of “<” means “or less”.
4. The symbol of “>” means “more than”.
5. The symbol of “-” means “not applicable”.
6. Calculated result at 7.310 MHz, as the worst point shown on underline:  
 Correction Factor + Meter Reading (AVE) = 10.6 + 33.9 = 44.5 dB(μV)
7. QP : Quasi-Peak Detector / AVE : Average Detector
8. Test receiver setting(s) : CISPR QP 9 kHz / Average 9 kHz

## 7.9 Radiated Emission

For the requirements,  - Applicable [  - Tested.  - Not tested by applicant request. ]  
 - Not Applicable

### 7.9.1 Test Results

For the standard,  - Passed  - Failed  - Not judged

Min. Limit Margin (Quasi-Peak) 1.7 dB at 30.92 MHz

Uncertainty of Measurement Results	9 kHz – 30 MHz	<u>± 3.0</u>	dB(2σ)
	30 MHz – 300 MHz	<u>± 3.8</u>	dB(2σ)
	300 MHz – 1000 MHz	<u>± 4.8</u>	dB(2σ)
	1 GHz – 6 GHz	<u>± 4.7</u>	dB(2σ)
	6 GHz – 18 GHz	<u>± 4.6</u>	dB(2σ)
	18 GHz – 40 GHz	<u>± 5.5</u>	dB(2σ)

Remarks : The measurement results are within the range of measurement uncertainty.

### 7.9.2 Test Instruments

Anechoic Chamber A2				
Type	Model	Serial No. (ID)	Manufacturer	Cal. Due
Test Receiver	ESU 26	100070 (--)	Rohde & Schwarz	2018/01/11
Loop Antenna	HFH2-Z2	872096/25 (C-2)	Rohde & Schwarz	2017/07/21
RF Cable	RG213/U	--- (H-28)	HUBER+SUHNER	2017/07/21
Pre-Amplifier	310N	304573 (A-17)	SONOMA	2017/04/03
Biconical Antenna	VHA9103/BBA9106	2355 (C-30)	Schwarzbeck	2017/05/18
Log-periodic Antenna	UHALP9108-A1	0694 (C-31)	Schwarzbeck	2017/05/18
RF Cable	S 10162 B-11 etc.	--- (H-4)	HUBER+SUHNER	2017/04/03
Pre-Amplifier	TPA0118-36	1010 (A-37)	TOYO	2017/05/17
Double-Ridge Guide Horn Antenna	TR17206	73370006 (C-29)	ADVANTEST	2017/06/13
Horn Antenna	91888-2	562 (C-41-1)	EATON	2017/06/12
Horn Antenna	91889-2	568 (C-41-2)	EATON	2017/06/12
Horn Antenna	3160-04	9903-1053 (C-55)	EMCO	2017/06/13
Horn Antenna	3160-05	9902-1061 (C-56)	EMCO	2017/06/13
Horn Antenna	3160-06	9712-1045 (C-57)	EMCO	2017/06/13
Horn Antenna	3160-07	9902-1113 (C-58)	EMCO	2017/06/13
Horn Antenna	3160-08	9904-1099 (C-59)	EMCO	2017/06/13
Horn Antenna	3160-09	9808-1117 (C-48)	EMCO	2017/06/15
Attenuator	54A-10	W5713 (D-29)	Weinschel	2017/08/02
Attenuator	2-10	BA6214 (D-79)	Weinschel	2017/11/21
RF Cable	SUCOFLEX104	267479/4 (C-66)	HUBER+SUHNER	2018/01/10
RF Cable	SUCOFLEX104	267414/4 (C-67)	HUBER+SUHNER	2018/01/10
RF Cable	SUCOFLEX102EA	3041/2EA (C-69)	HUBER+SUHNER	2018/01/10
Band Rejection Filter	BRM50701	029 (D-93)	MICRO-TRONICS	2017/02/17

NOTE : The calibration interval of the above test instruments is 12 months.

**7.9.3 Test Method and Test Setup (Diagrammatic illustration)**

**7.9.3.1 Radiated Emission 9 kHz – 30 MHz**

The preliminary tests were performed at the measurement distance that specified for compliance to determine the emission characteristics of the EUT.

The EUT configuration, cable configuration and mode of operation were determined for producing the maximum level of emissions.

The measurement were performed about three antenna orientations (parallel, perpendicular, and ground-parallel).

According to KDB 937606, a used anechoic chamber were equivalent to those on an open fields site based on comparison measurements.

This configurations was used for the final tests.

– Side View –

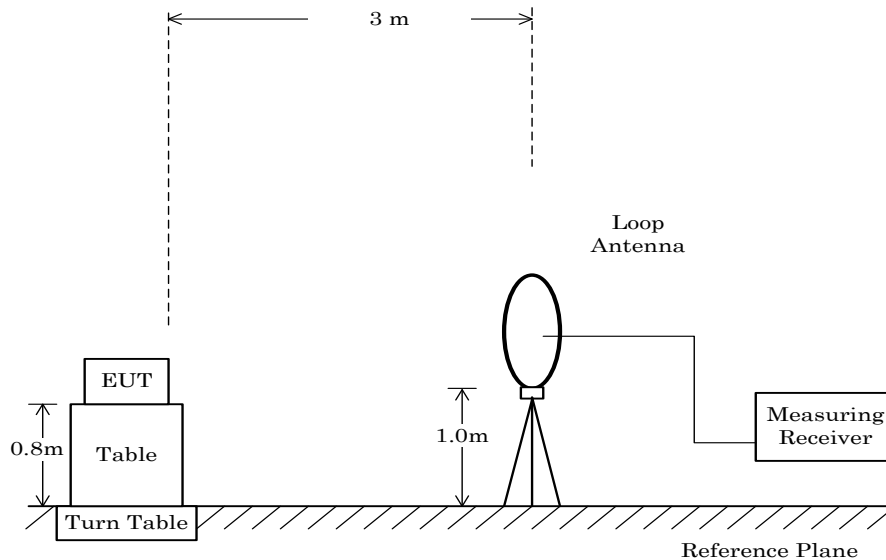

**7.9.3.2 Radiated Emission 30 MHz – 1000 MHz**

The preliminary tests were performed at the measurement distance that specified for compliance to determine the emission characteristics of the EUT.

The EUT configuration, cable configuration and mode of operation were determined for producing the maximum level of emissions.

This configurations was used for the final tests.

– Side View –

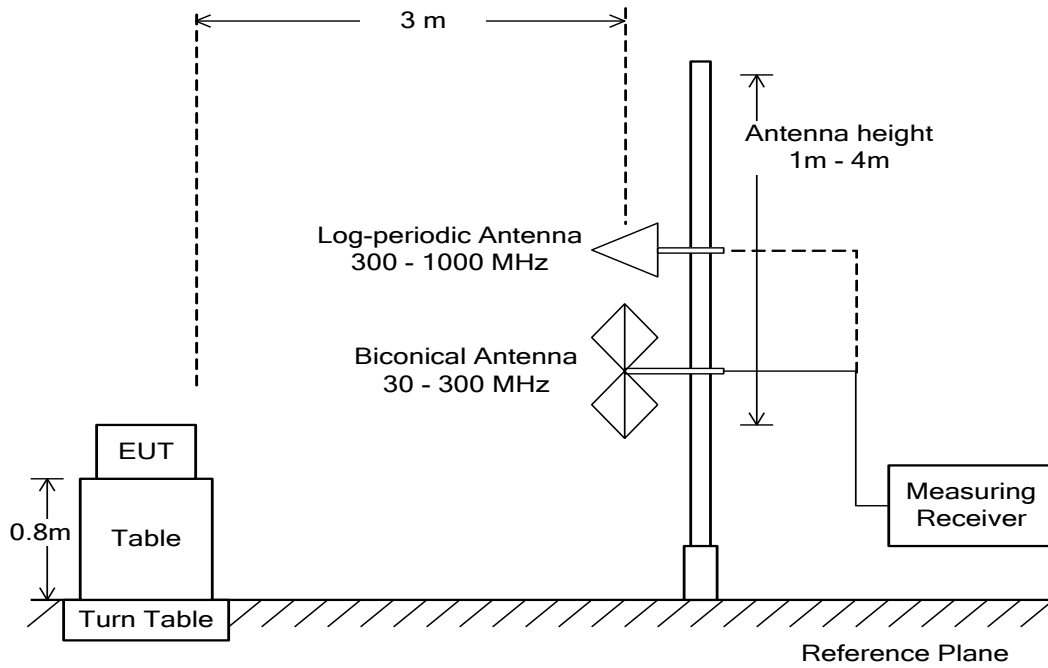

### 7.9.3.3 Radiated Emission above 1 GHz

The preliminary tests were performed at the measurement distance that specified for compliance to determine the emission characteristics of the EUT.

The EUT configuration, cable configuration and mode of operation were determined for producing the maximum level of emissions.

This configurations was used for the final tests.

The setting of the measuring instruments are shown as follows:

Type	Peak	Average
Detector Function	Peak	Peak
Res. Bandwidth	1 MHz	1 MHz
Video Bandwidth	3 MHz	$\geq 1/T *1)$
Video Filtering	Linear Voltage	Linear Voltage
Sweep Time	AUTO	AUTO
Trace	Max Hold	Max Hold

Note: 1. T: Minimum transmission duration

Average (VBW) Setting:

Mode	Interval	Cycle	Duty cycle	Burst on period(T)	Min. VBW(1/T)	VBW Setting
	(msec)	(msec)	(%)	(msec)	(kHz)	(kHz)
BDR(DH5)	0.86	3.75	77.2%	2.90	0.35	0.50

– Side View –

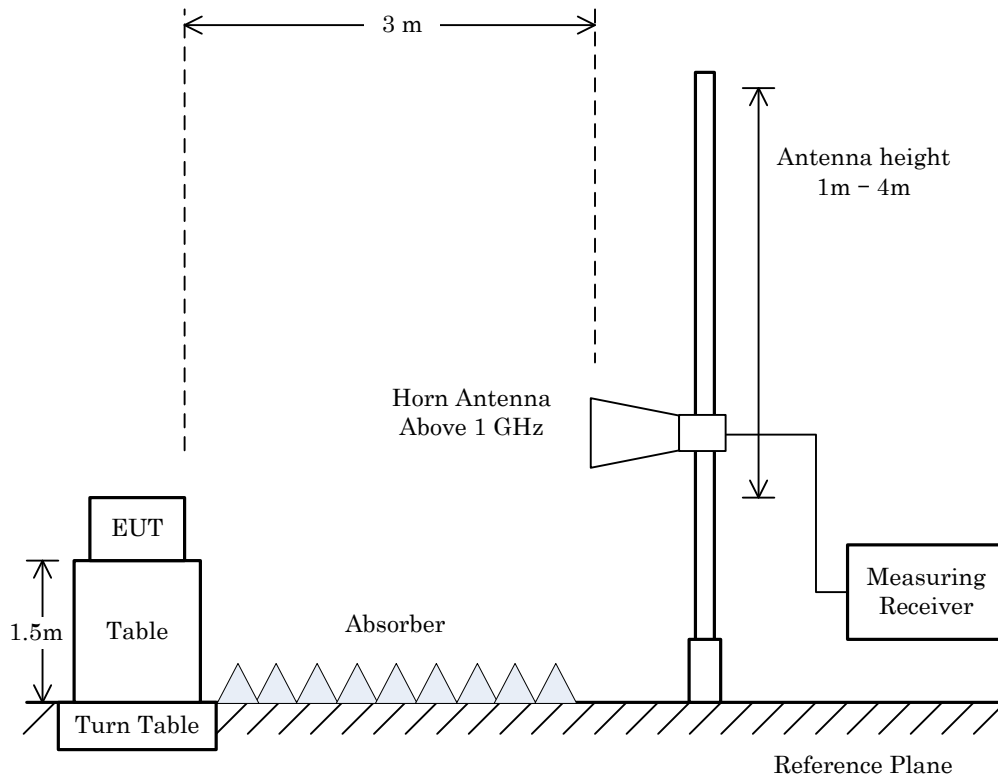

**NOTE**

When the EUT is manipulated through three different orientations, the scan height upper range for the measurement antenna is limited to 2.5 m or 0.5 m above the top of the EUT.



**7.9.4 Test Data**

**7.9.4.1 Band-edge Compliance**

Test Date : February 15, 2017  
 Temp.: 20°C, Humi: 39%

Mode of EUT : BDR, Hopping off (0ch: 2402 MHz) (worst case)

Antenna Polarization : Horizontal

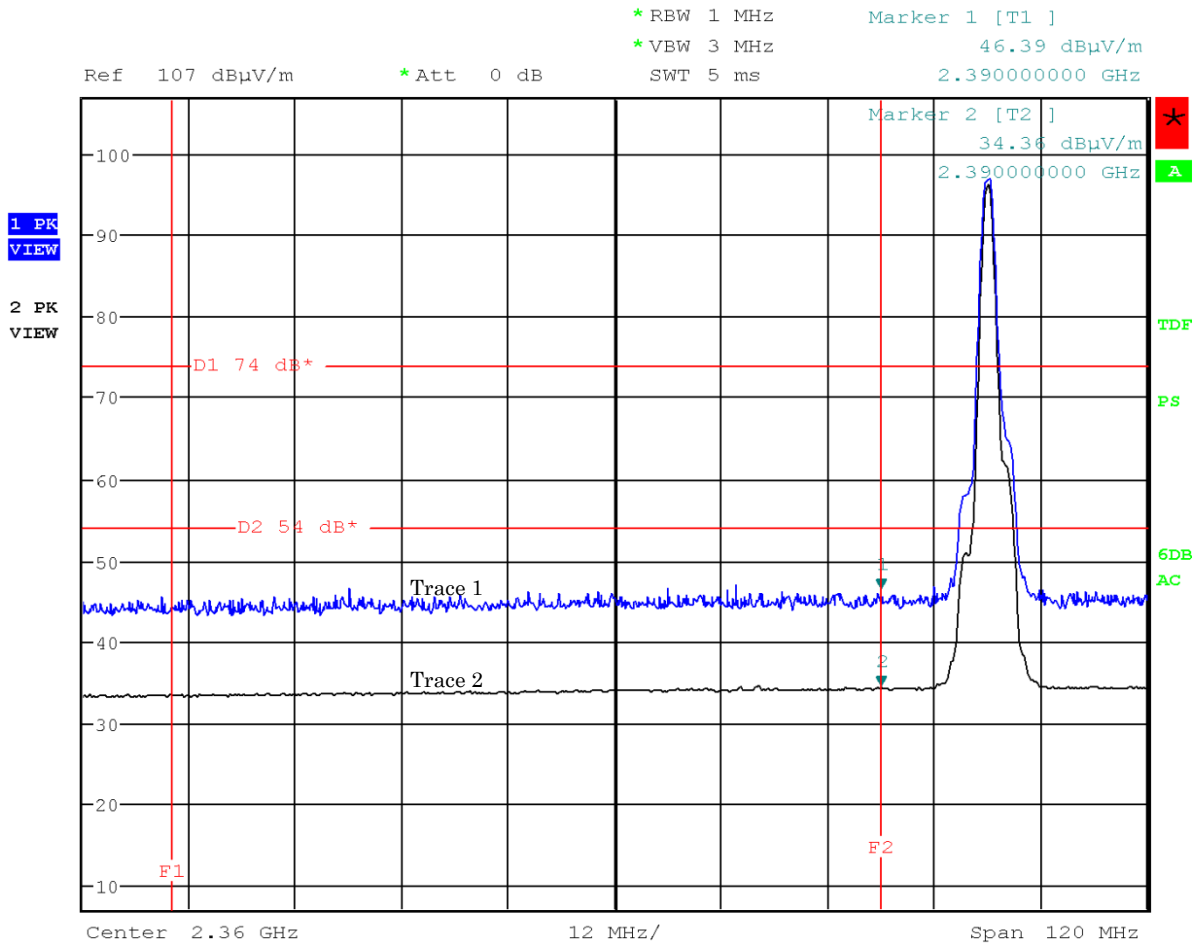

Note: The trace 1 is Peak . The trace 2 is Average.

Mode of EUT : BDR, Hopping off (0ch: 2402 MHz) (worst case)  
 Antenna Polarization : Vertical

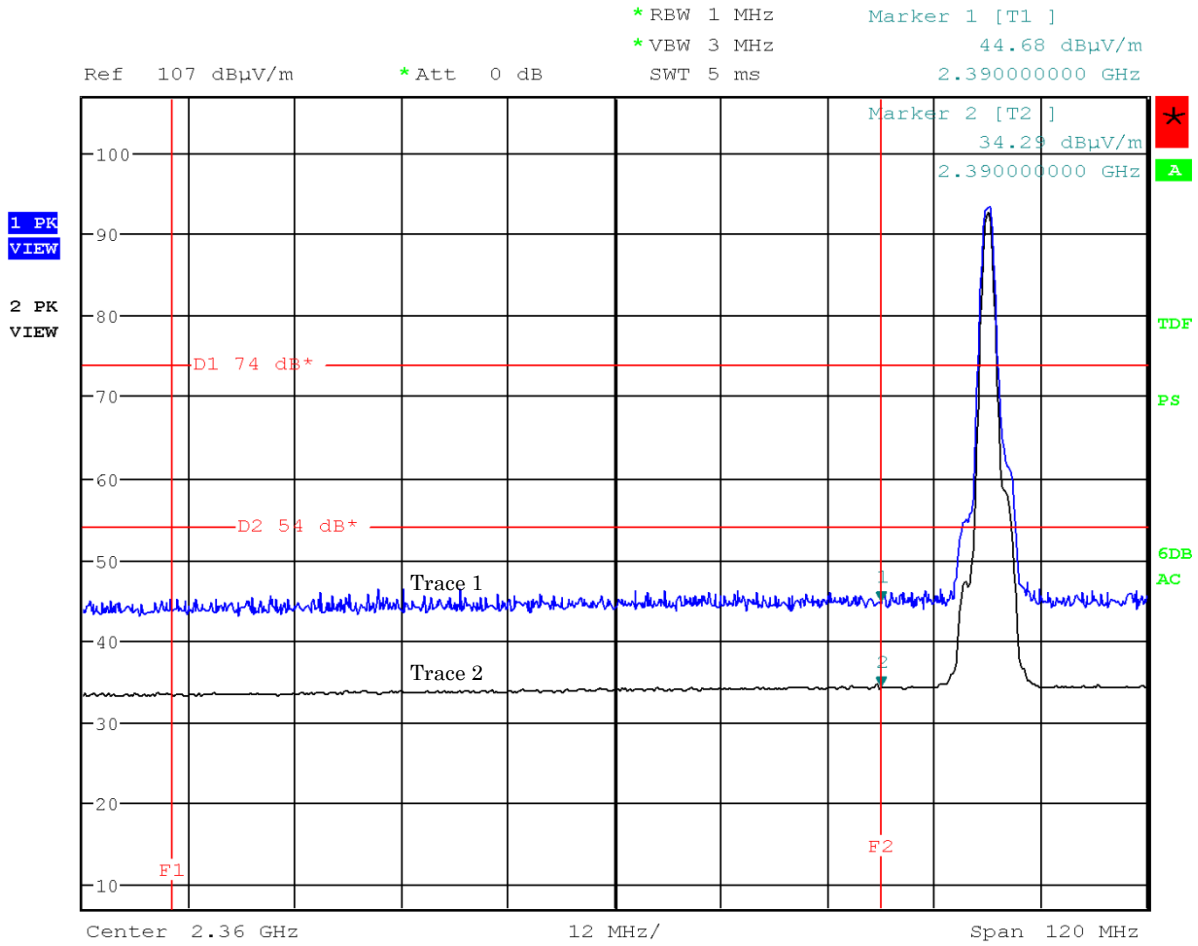

Note: The trace 1 is Peak . The trace 2 is Average.

Mode of EUT : BDR, Hopping off (78ch: 2480 MHz) (worst case)  
 Antenna Polarization : Horizontal

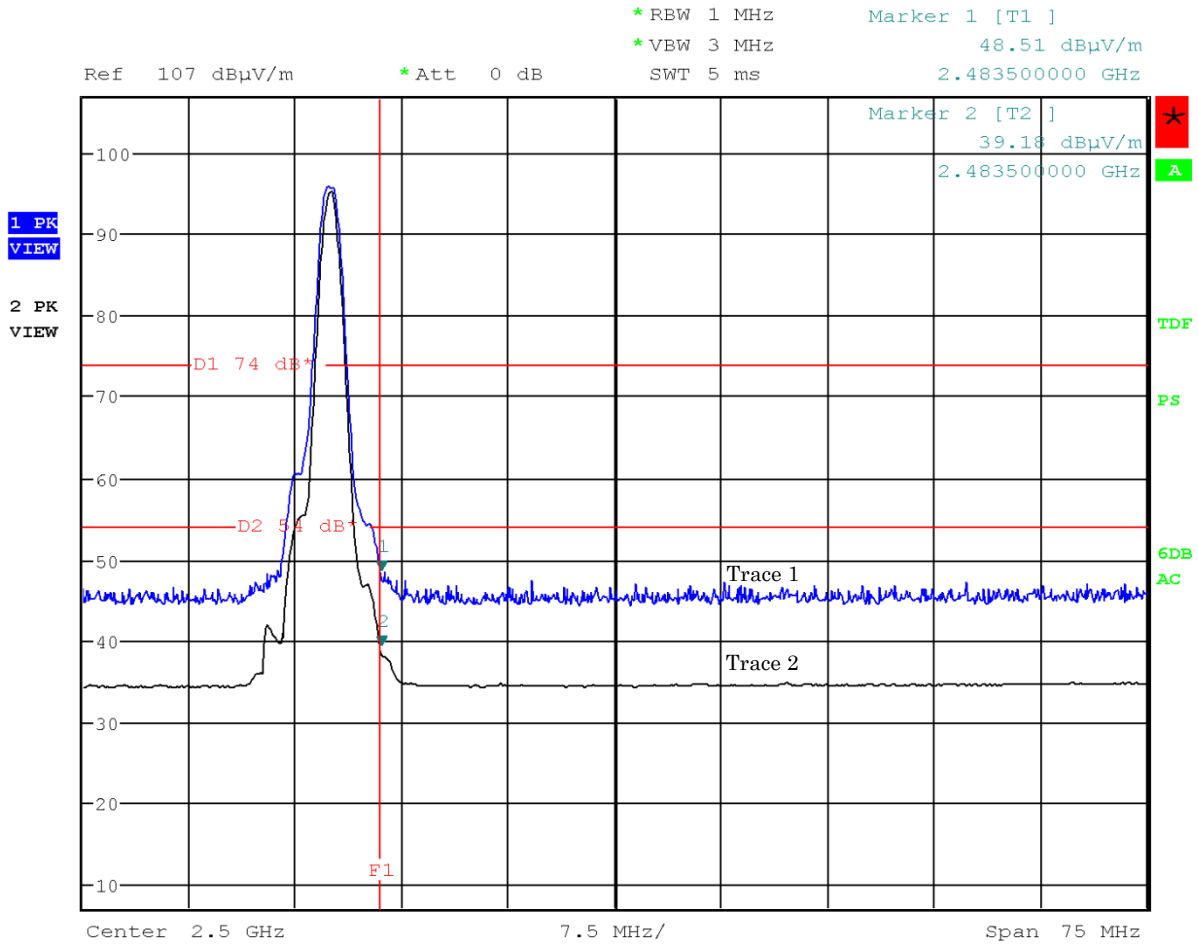

Note: The trace 1 is Peak . The trace 2 is Average.



### 7.9.4.2 Other Spurious Emission (9kHz – 30MHz)

Test Date : February 8, 2017

Temp.:26°C, Humi:27%

Mode of EUT : All modes have been investigated and the worst case mode has been listed.

Results : No spurious emissions in the range 20dB below the limit.

### 7.9.4.3 Other Spurious Emission (30MHz – 1000MHz)

Mode of EUT : All modes have been investigated and the worst case mode has been listed.

Test voltage : 120VAC 60Hz

Test Date: February 8, 2017

Temp.: 26 °C, Humi: 27 %

Antenna pole : Horizontal

Frequency [MHz]	Antenna Factor [dB(1/m)]	Corr. Factor [dB]	Meter Readings [dB(μV)]	Limits [dB(μV/m)]	Results [dB(μV/m)]	Margin [dB]	Remarks
30.98	18.4	0.9	7.0	40.0	26.3	+13.7	-
203.20	16.6	2.4	11.7	43.5	30.7	+12.8	-
293.53	18.7	2.9	11.1	46.0	32.7	+13.3	-
327.52	14.2	3.1	15.0	46.0	32.3	+13.7	-
398.24	16.5	3.5	10.8	46.0	30.8	+15.2	-
880.44	22.3	5.2	< 0.0	46.0	< 27.5	> +18.5	-

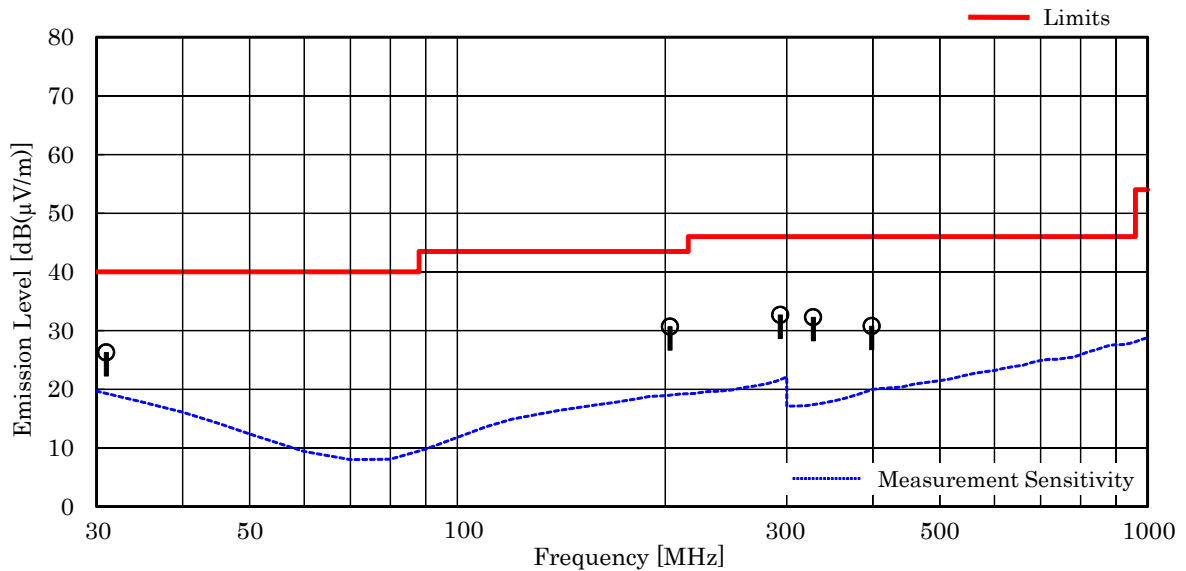

#### NOTES

1. Test Distance : 3 m
2. The spectrum was checked from 30 MHz to 1000 MHz.
3. The correction factor is composed of cable loss, pad attenuation and/or amplifier gain.
4. The symbol of "<" means "or less".
5. The symbol of ">" means "more than".
6. Calculated result at 203.20 MHz, as the worst point shown on underline:  
 Antenna Factor + Correction Factor + Meter Reading = 16.6 + 2.4 + 11.7 = 30.7 dB(μV/m)  
 Antenna Height : 166 cm, Turntable Angle : 110 °
7. Test receiver setting(s) : CISPR QP 120 kHz [QP : Quasi-Peak]

**Test voltage : 120VAC 60Hz**

Test Date: February 8, 2017  
Temp.: 26 °C, Humi: 27 %

**Antenna pole : Vertical**

Frequency [MHz]	Antenna Factor [dB(1/m)]	Corr. Factor [dB]	Meter Readings [dB(μV)]	Limits [dB(μV/m)]	Results [dB(μV/m)]	Margin [dB]	Remarks
<u>30.92</u>	18.4	0.9	19.0	40.0	38.3	+ 1.7	-
203.22	16.6	2.4	7.7	43.5	26.7	+16.8	-
293.52	18.7	2.9	5.0	46.0	26.6	+19.4	-
327.54	14.2	3.1	8.2	46.0	25.5	+20.5	-
398.23	16.5	3.5	10.6	46.0	30.6	+15.4	-
880.61	22.3	5.2	6.8	46.0	34.3	+11.7	-

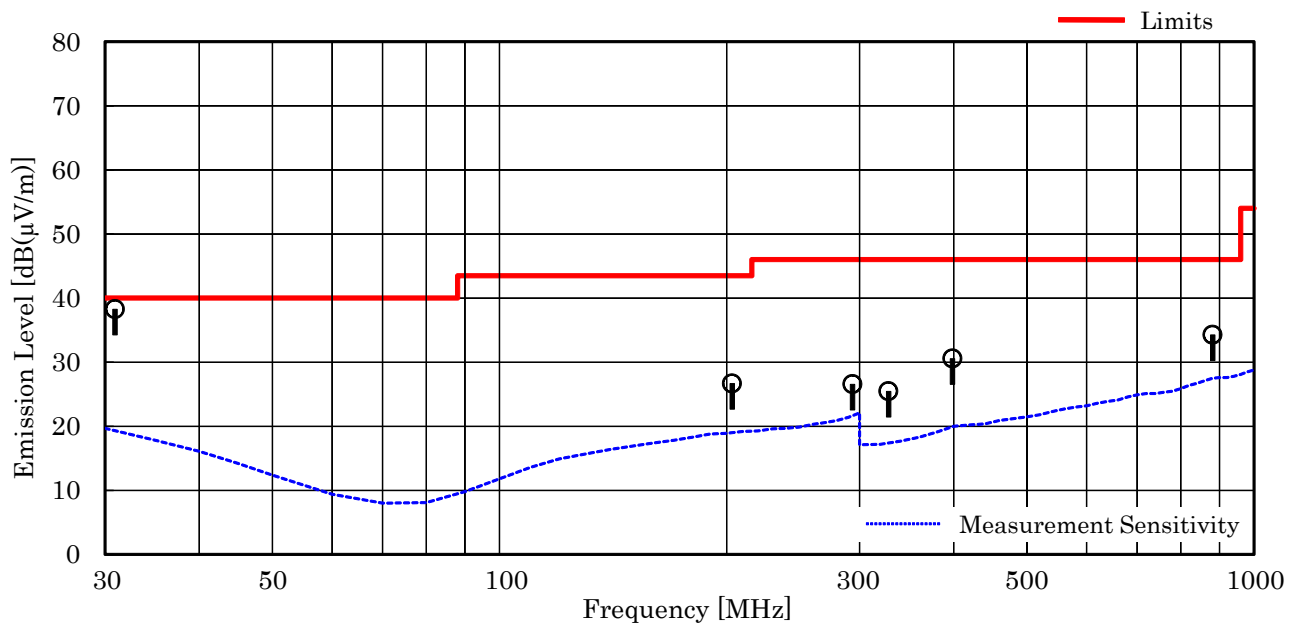

**NOTES**

1. Test Distance : 3 m
2. The spectrum was checked from 30 MHz to 1000 MHz.
3. The correction factor is composed of cable loss, pad attenuation and/or amplifier gain.
4. The symbol of “<” means “or less”.
5. The symbol of “>” means “more than”.
6. Calculated result at 30.92 MHz, as the worst point shown on underline:  
 Antenna Factor + Correction Factor + Meter Reading = 18.4 + 0.9 + 19.0 = 38.3 dB(μV/m)  
 Antenna Height : 100 cm, Turntable Angle : 349 °
7. Test receiver setting(s) : CISPR QP 120 kHz [QP : Quasi-Peak]

### 7.9.4.4 Other Spurious Emission (Above 1000MHz)

Mode of EUT : BDR (worst case)

Test Date: February 13, 2017  
 Temp.: 19 °C, Humi: 32 %

Frequency [MHz]	Antenna Factor [dB(1/m)]	Corr. Factor [dB]	D.C.F. [dB]	Meter Readings [dB(μV)]				Limits [dB(μV/m)]		Results [dB(μV/m)]		Margin [dB]	Remarks
				Horizontal		Vertical		PK	AVE	PK	AVE		
				PK	AVE	PK	AVE						
<b>Test condition : Tx Low Ch</b>													
4804.0	32.9	-35.6	0.0	51.3	42.8	54.2	50.3	74.0	54.0	51.5	47.6	+ 6.4	
12010.0	38.9	-34.7	0.0	< 48.0	< 38.0	< 48.0	< 38.0	74.0	54.0	< 52.2	< 42.2	> +11.8	
19216.0	40.5	-43.1	0.0	< 50.0	< 40.0	< 50.0	< 40.0	74.0	54.0	< 47.4	< 37.4	> +16.6	
<b>Test condition : TX Middle Ch</b>													
4882.0	32.8	-35.5	0.0	51.5	42.6	53.4	49.1	74.0	54.0	50.7	46.4	+ 7.6	
7323.0	36.4	-36.1	0.0	< 48.0	< 38.0	< 48.0	< 38.0	74.0	54.0	< 48.3	< 38.3	> +15.7	
12205.0	38.6	-35.6	0.0	< 48.0	< 38.0	< 48.0	< 38.0	74.0	54.0	< 51.0	< 41.0	> +13.0	
19528.0	40.4	-42.6	0.0	< 50.0	< 40.0	< 50.0	< 40.0	74.0	54.0	< 47.8	< 37.8	> +16.2	
<b>Test condition : TX High Ch</b>													
4960.0	33.0	-35.4	0.0	51.1	42.7	53.1	48.2	74.0	54.0	50.7	45.8	+ 8.2	
7440.0	36.4	-36.2	0.0	< 48.0	< 38.0	< 48.0	< 38.0	74.0	54.0	< 48.2	< 38.2	> +15.8	
12400.0	38.5	-36.0	0.0	< 48.0	< 38.0	< 48.0	< 38.0	74.0	54.0	< 50.5	< 40.5	> +13.5	
19840.0	40.4	-42.8	0.0	< 50.0	< 40.0	< 50.0	< 40.0	74.0	54.0	< 47.6	< 37.6	> +16.4	
22320.0	40.6	-43.2	0.0	< 50.0	< 40.0	< 50.0	< 40.0	74.0	54.0	< 47.4	< 37.4	> +16.6	

Calculated result at 4804.0 MHz, as the worst point shown on underline:

Antenna Factor	=	32.9 dB(1/m)
Corr. Factor	=	-35.6 dB
D.C.F.(For AVE only)	=	0.0 dB
+ ) Meter Reading	=	50.3 dB(μV)
Result	=	47.6 dB(μV/m)

Minimum Margin: 54.0 - 47.6 = 6.4 (dB)

#### NOTES

- Test Distance : 3 m
- The spectrum was checked from 1 GHz to 25 GHz (10th harmonic of the highest fundamental frequency).
- The correction factor is shown as follows:
  - Corr. Factor [dB] = Cable Loss + 20dB Pad Att. - Pre-Amp. Gain [dB] (1.0 - 7.6GHz)
  - Corr. Factor [dB] = Cable Loss + 10dB Pad Att. - Pre-Amp. Gain [dB] (7.6 - 18.0GHz)
  - Corr. Factor [dB] = Cable Loss - Pre-Amp. Gain [dB] (over 18 GHz)
- The symbol of "<" means "or less".
- The symbol of ">" means "more than".
- PK : Peak / AVE : Average
- D.C.F. Calculation. (D.C.F. ; Duty Cycle Correction Factor)
  - Time to cycle through all channels =  $t = T \text{ [ms]} \times 20$  (AFH minimum hopping channels), where T = burst on duration
  - $100 \text{ ms} / t = h \rightarrow$  Round up to next highest integer, to account for worst case, H
  - The Worst Case Dwell Time [ms] =  $T \times H$
  - D.C.F. [dB] =  $20 \times \log(\text{The Worst Case Dwell Time} / 100 \text{ [ms]})$

TX Low/Middle/High ch (Horizontal)

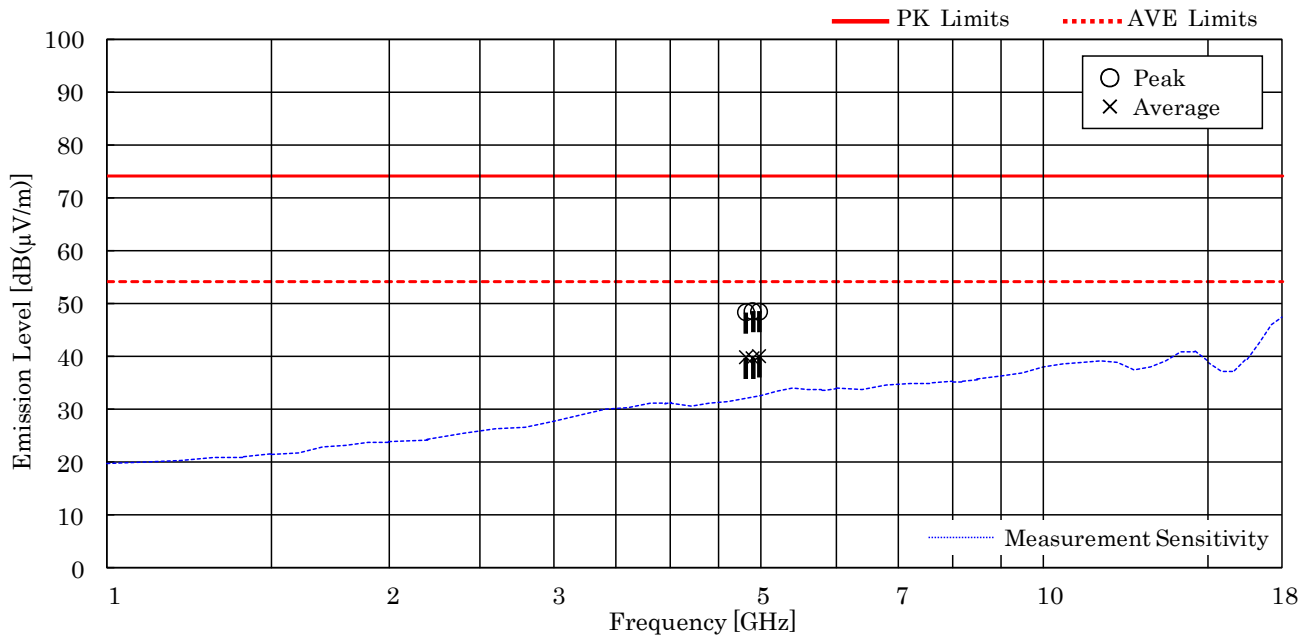

TX Low/Middle/High ch (Vertical)

