

MODEL
CLJ
x 1
x
x
x
x
x
x

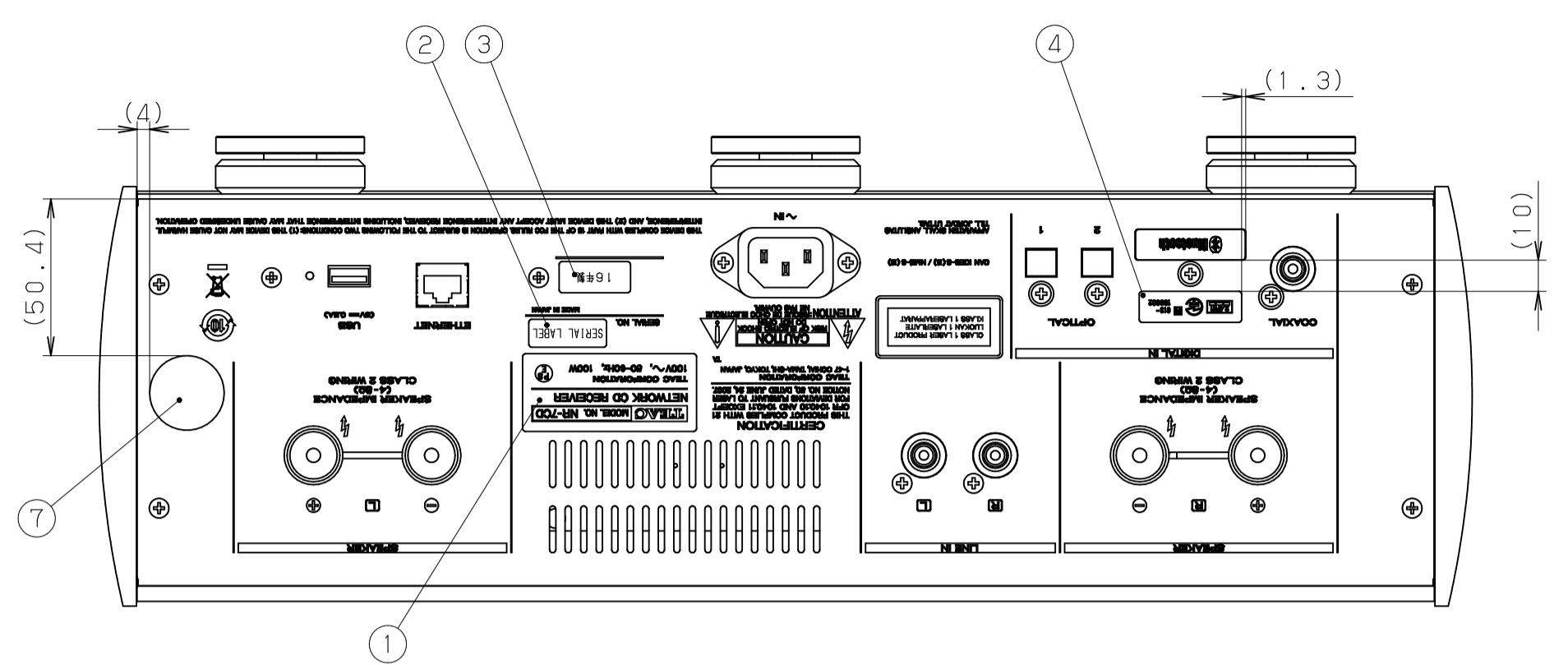

各社別のNAMEPLATE

M03925701# NAMEPLATE, NR-7CD JPN	M03925721# NAMEPLATE, NR-7CD T/C-E
M03925704# NAMEPLATE, NR-7CD KOR	M03925750# NAMEPLATE, NR-7CD EUR

REF NO	PART NO	DWG NO	DESCRIPTION	JPNT/C-EUR	QTY	REMARKS
①	M03925701A		NAMEPLATE, NR-7CD JPN	○		NAMEPLATE部使用
	M03925721A		NAMEPLATE, NR-7CD T/C-E	○		
	M03925750A		NAMEPLATE, NR-7CD EUR	○		
②	M03925701A		NAMEPLATE, NR-7CD JPN	○		SRIAL No部使用
	M03925721A		NAMEPLATE, NR-7CD T/C-E	○		
	M03925750A		NAMEPLATE, NR-7CD EUR	○		
③	M03925701A		NAMEPLATE, NR-7CD JPN	○		製造年表示部使用
④	M03925701A		NAMEPLATE, NR-7CD JPN	○		MIC No部使用
	M03925721A		NAMEPLATE, NR-7CD T/C-E	○		FCC No部使用
⑤	M03922600A		LABEL, TYPE NR-7CD ALL	○		EU IMPOTER部使用
⑥	M03929400A		LABEL, CAUTION T/C	○		
⑦	5026521000		LAマーク	○		
⑧	M03739600A		LABEL, HI-RES 15x15 G	○		
	M03922601A		LABEL, TYPE NR-7CD DM	○		備装L LABEL部使用
	M03922621A		LABEL, TYPE NR-7CD T/C-E	○		
	M03922650A		LABEL, TYPE NR-7CD EUR-Y	○		

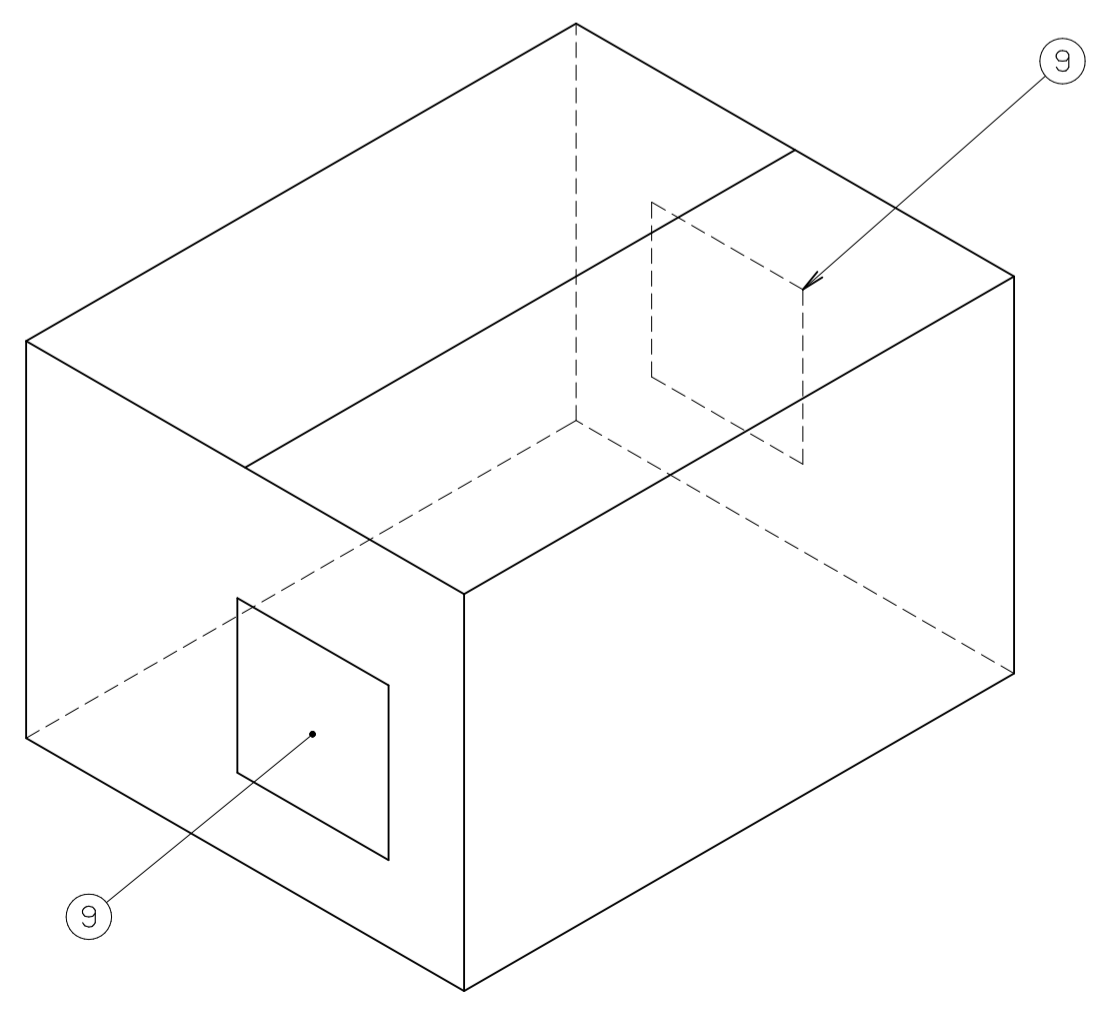
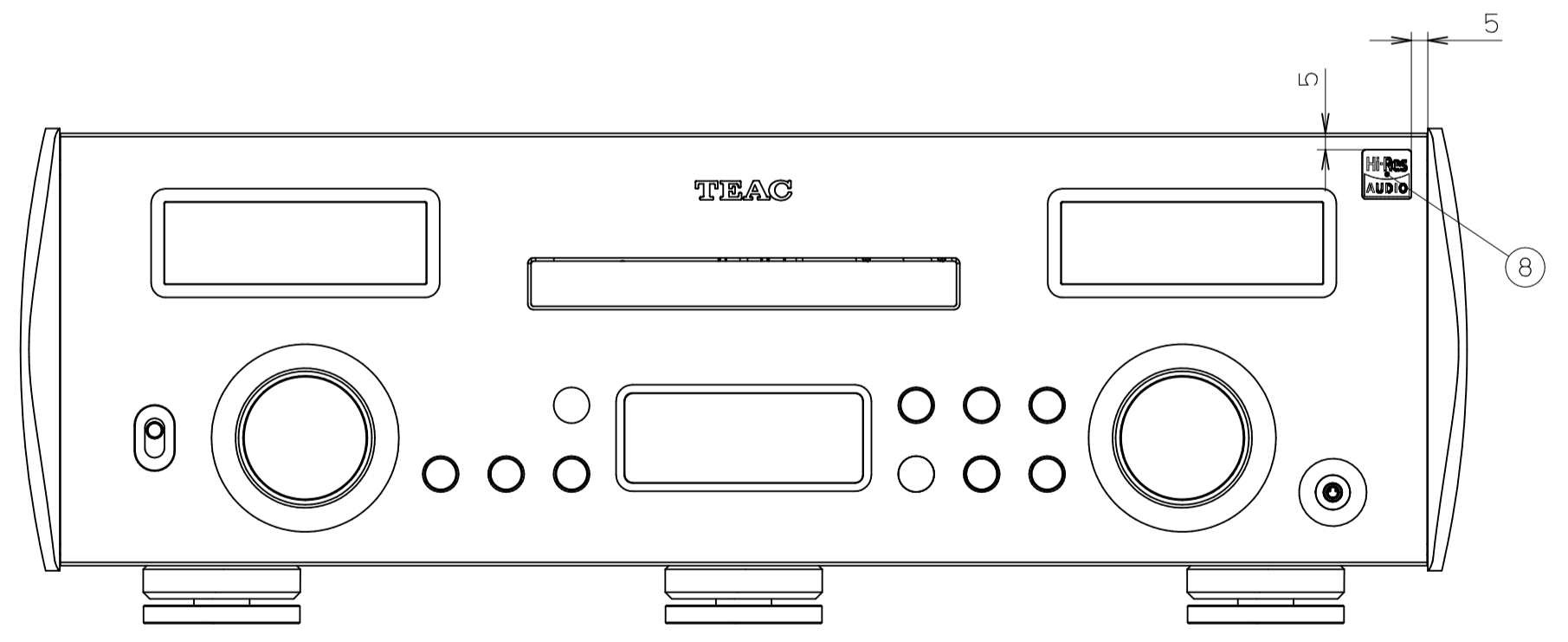
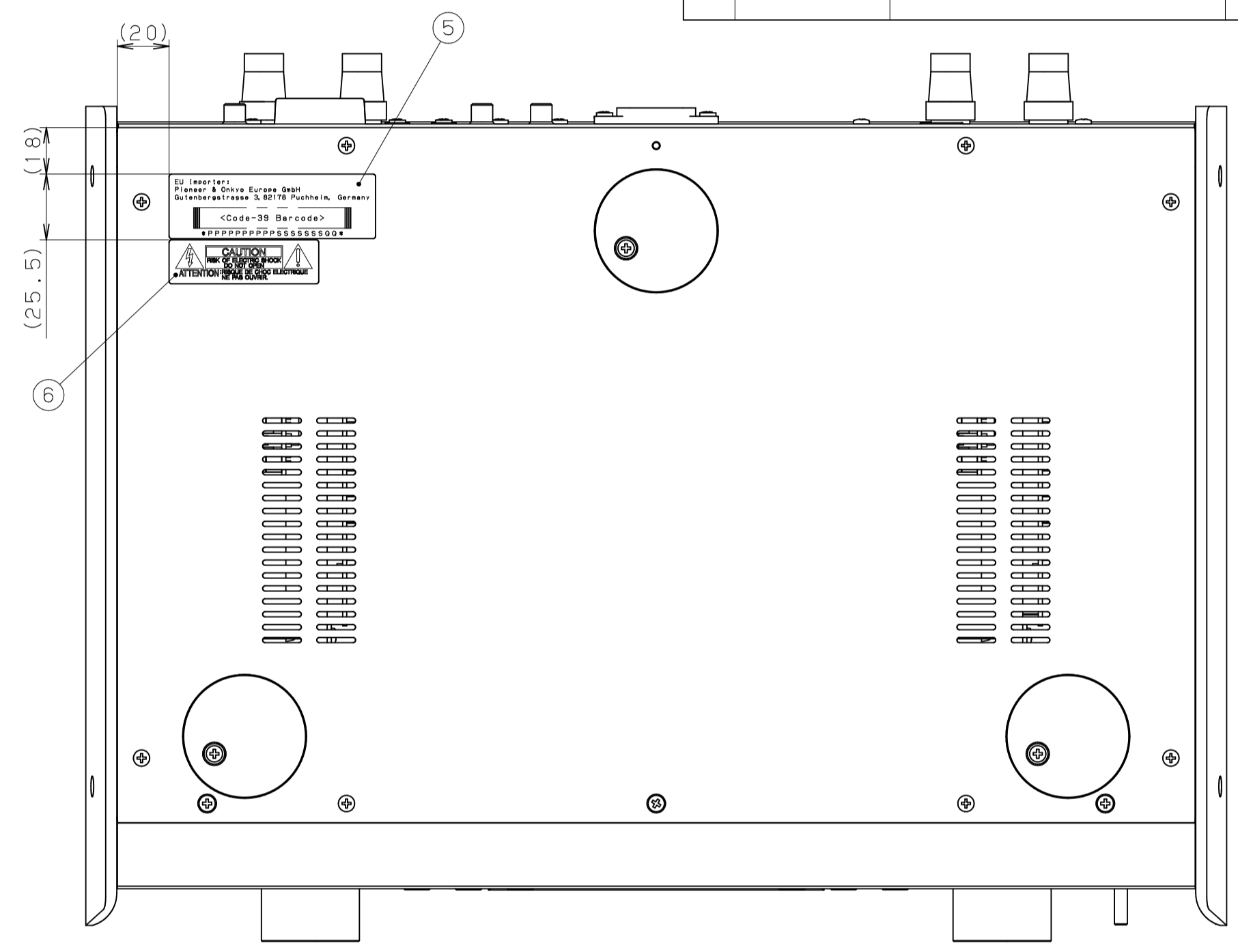
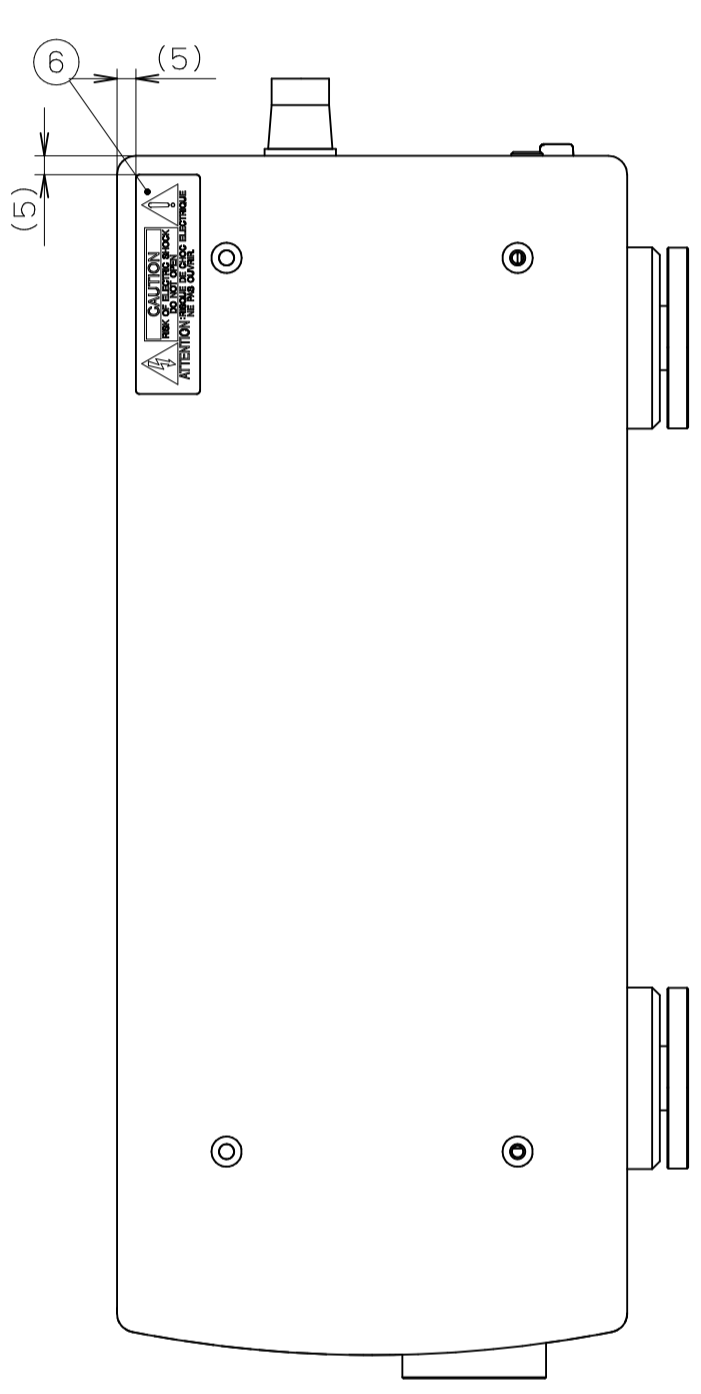
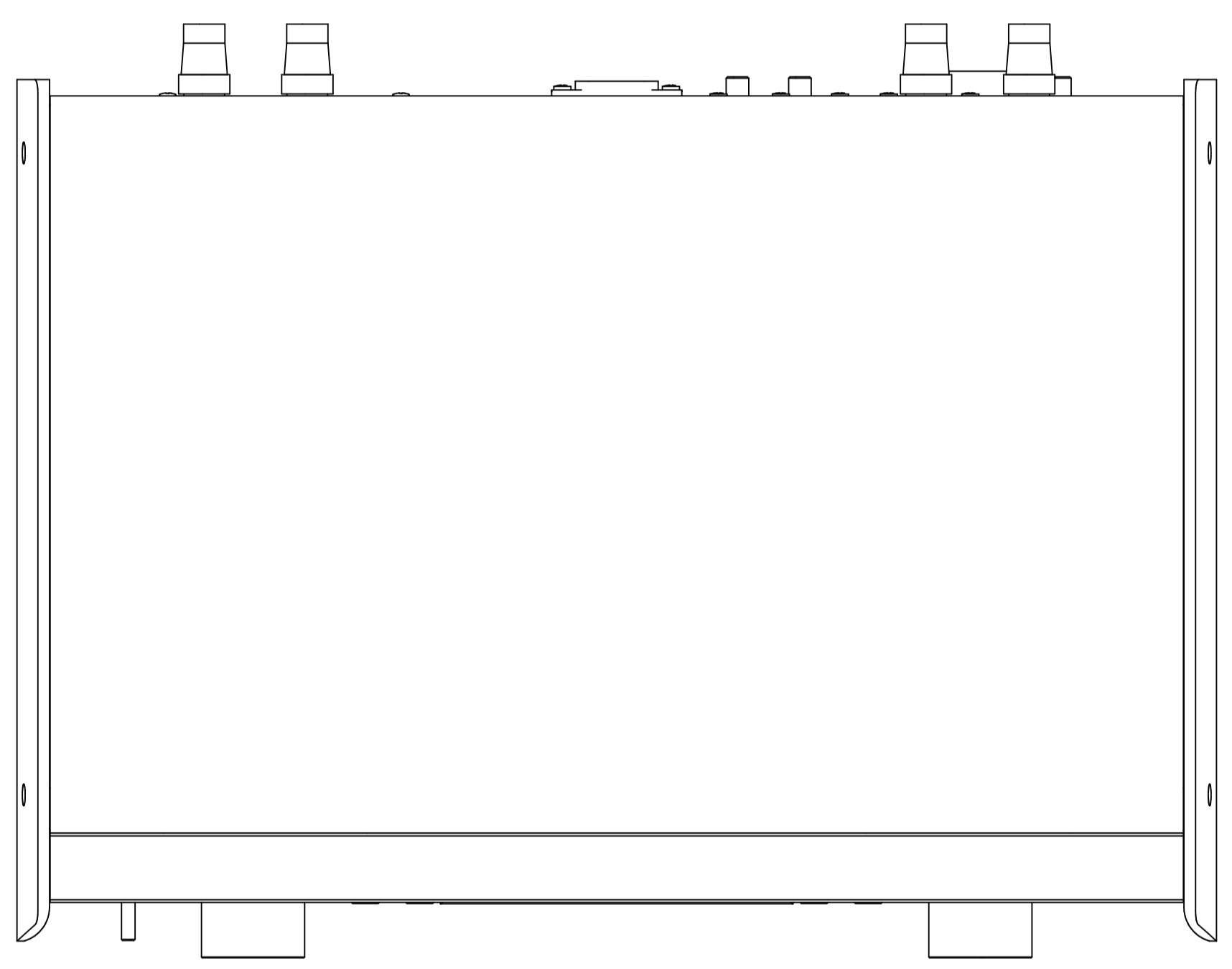
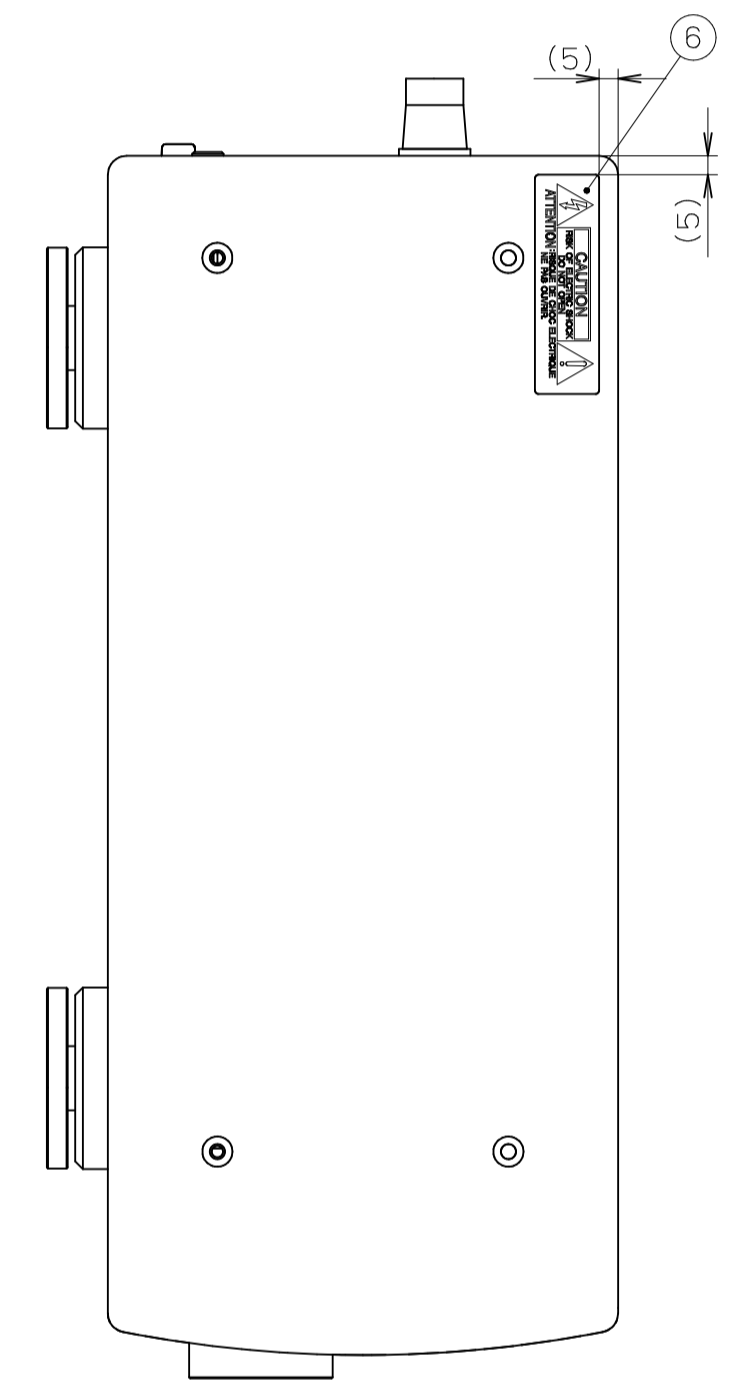

CARTON BOXへのLABEL貼付図
(NOT SCALE)

安規承認
2017.02.02
客戶

書き直し変更 №EA4882

MATERIAL 材料	別記	D01313700B
FINISH 仕上		
REV E.C.N NO DATE PLANNED/APPROVED	TREATMENT 処理	PART NO 品番 APPLICATION 適用
APPROVED 新妻 17-02-02 UNIT mm TOLERANCE 公差	TS-E 10232 (D載)	DWG TITLE 部品図
CHECKED 藤村 17-02-02 ANGLE		DWG NO 部品番 D01313700
PLANNED (藤村) 16-10-24 SCALE 1:2	TEAC ディアック株式会社	DRW 藤村
DRAWN 藤村 17-02-01	REDUCED 縮小	SHEET 1 OF 1