

FCC 47 CFR PART 15 SUBPART C AND ANSI C63.10: 2013**TEST REPORT**

For

CD PLAYER/TUNER**Model: CD-400U****Brand: TEAC**

Issued for

TEAC CORPORATION**1-47 Ochiai, Tama-shi, Tokyo 206-8530, Japan**

Issued by

Compliance Certification Services Inc.**Tainan Lab.**

No.8, Jiucengling, Xinhua Dist., Tainan City 712, Taiwan (R.O.C.)

TEL: 886-6-580-2201**FAX: 886-6-580-2202****Issued Date: November 21, 2017**

Note: This report shall not be reproduced except in full, without the written approval of Compliance Certification Services Inc. Ltd. This document may be altered or revised by Compliance Certification Services Inc. personnel only, and shall be noted in the revision section of the document

Attention is drawn to the limitation of liability, indemnification and jurisdiction issues defined therein. Any holder of this document is advised that information contained hereon reflects the Company's findings at the time of its intervention only and within the limits of Client's instructions, if any. The Company's sole responsibility is to its Client and this document does not exonerate parties to a transaction from exercising all their rights and obligations under the transaction documents. This document cannot be reproduced except in full, without prior written approval of the Company. Any unauthorized alteration, forgery or falsification of the content or appearance of this document is unlawful and offenders may be prosecuted to the fullest extent of the law.

Compliance Certification Services Inc. No.8, Jiucengling, Xinhua Dist., Tainan City 712, Taiwan (R.O.C.)

t (886) 6-580-2201 f (886) 6-580-2202

www.ccsrf.com

Member of SGS Group

REVISION HISTORY

Rev.	Issue Date	Revisions	Effect Page	Revised By
00	November 21, 2017	Initial Issue	ALL	Sunny Chang

TABLE OF CONTENTS

1. TEST REPORT CERTIFICATION	4
2. EUT DESCRIPTION	5
2.1 DESCRIPTION OF EUT & POWER.....	5
3. DESCRIPTION OF TEST MODES	6
4. TEST METHODOLOGY	7
5. FACILITIES AND ACCREDITATIONS.....	7
5.1 FACILITIES	7
5.2 EQUIPMENT	7
5.3 LABORATORY ACCREDITATIONS LISTINGS.....	7
5.4 TABLE OF ACCREDITATIONS AND LISTINGS	8
6. CALIBRATION AND UNCERTAINTY.....	9
6.1 MEASURING INSTRUMENT CALIBRATION	9
6.2 MEASUREMENT UNCERTAINTY	9
7. SETUP OF EQUIPMENT UNDER TEST.....	10
7.1 SETUP CONFIGURATION OF EUT	10
7.2 SUPPORT EQUIPMENT	11
7.3 EUT OPERATING CONDITION	13
8. APPLICABLE LIMITS AND TEST RESULTS.....	14
8.1 6DB BANDWIDTH.....	14
8.2 MAXIMUM PEAK OUTPUT POWER	18
8.3 DUTY CYCLE.....	24
8.4 POWER SPECTRAL DENSITY	29
8.6 CONDUCTED SPURIOUS EMISSION	33
8.7 RADIATED EMISSIONS	38
8.8 POWERLINE CONDUCTED EMISSIONS	51
9. ANTENNA REQUIREMENT	67
9.1 STANDARD APPLICABLE.....	67
9.2 ANTENNA CONNECTED CONSTRUCTION.....	67
APPENDIX I SETUP PHOTOS	68
APPENDIX II PHOTOGRAPHS OF EUT.....	A1

1. TEST REPORT CERTIFICATION

Applicant : **TEAC CORPORATION**
 1-47 Ochiai, Tama-shi, Tokyo 206-8530, Japan

Manufacturer : **1) Ya Horng Electronic Co., Ltd.**
 No. 35, Shalun, Jon Sha Village, Anding Dist., Tainan City
 745, Taiwan (R.O.C.)
2) Atten Electronic (Dongguan) Co., Ltd.
 No.34 Gao Yu Nan Road.188 Industrial District, Ping Shan
 Administrative District, Tang Xia Town, Dong Guan,
 Guangdong, 523728, China.

Equipment Under Test : CD PLAYER/TUNER

Model Number : CD-400U

Brand Name : TEAC

Date of Test : September 22, 2017~ November 06, 2017

APPLICABLE STANDARD	
STANDARD	TEST RESULT
FCC Part 15 Subpart C AND ANSI C63.10: 2013	No non-compliance noted

Approved by:



Jeter Wu
Assistant Manager

Reviewed by:

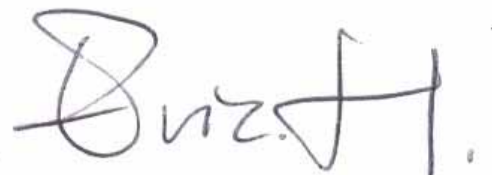

Eric Huang
Section Manager

2. EUT DESCRIPTION

2.1 DESCRIPTION OF EUT & POWER

Product Name	CD PLAYER/TUNER
Model Number	CD-400U
Brand Name	TEAC
Received Date	September 13, 2017
Operating Frequency Range	DSSS Mode : 2402MHz~2480MHz
Transmit Power	DSSS Mode : 7.93dBm (6.2044mW)
Channel Spacing	DSSS Mode : 2 MHz
Channel Number	DSSS Mode : 40 Channels
Transmit Data Rate	DSSS Mode : 1 Mbps
Type of Modulation	DSSS
Frequency Selection	By software / firmware
Antenna Type	Manufacturer: BRITO TECHNOLOGY Type: Dipole antenna Model: WF-EM-1708-0131-B Gain: 2.0dBi
Power Source	AC100-240V, 50/60Hz, 20W
Hardware Version	CD400U MAIN PCB 2
Software Version	N/A

- REMARK:**
1. The sample selected for test was engineering sample that approximated to production product and was provided by manufacturer.
 2. This submittal(s) (test report) is intended for FCC ID: **XEG-CD400U** filing to comply with Section 15.207, 15.209 and 15.247 of the FCC Part 15, Subpart C Rules.
 3. For more details, please refer to the user manual.

3. DESCRIPTION OF TEST MODES

The EUT is a CD PLAYER/TUNER.

The RF Chip is manufactured by Elinketone.

The antenna peak gain 2.0 dBi (highest gain) were chosen for full testing.

DSSS mode

The EUT had been tested under operating condition.

There are three channels have been tested as following:

Channel	Frequency (MHz)
Low	2402
Middle	2442
High	2480

DSSS mode: 1Mbps long data rates (worst case) were chosen for full testing.

4. TEST METHODOLOGY

The tests documented in this report were performed in accordance with ANSI C63.10 and FCC CFR 47 15.207, 15.209 and 15.247 and KDB 558074.

5. FACILITIES AND ACCREDITATIONS

5.1 FACILITIES

All measurement facilities used to collect the measurement data are located at No.8, Jiucengling, Xinhua Dist., Tainan City 712, Taiwan (R.O.C.)

The sites are constructed in conformance with the requirements of ANSI C63.7:1992, ANSI C63.10: 2013 and CISPR Publication 22.

5.2 EQUIPMENT

Radiated emissions are measured with one or more of the following types of linearly polarized antennas: tuned dipole, biconical, log periodic, bi-log, and/or ridged waveguide, horn. Spectrum analyzers with preselectors and quasi-peak detectors are used to perform radiated measurements.

Conducted emissions are measured with Line Impedance Stabilization Networks and EMI Test Receivers.

Calibrated wideband preamplifiers, coaxial cables, and coaxial attenuators are also used for making measurements.

All receiving equipment conforms to CISPR Publication 16-1, "Radio Interference Measuring Apparatus and Measurement Methods."

5.3 LABORATORY ACCREDITATIONS LISTINGS

The test facilities used to perform radiated and conducted emissions tests are accredited by Taiwan Accreditation Foundation for the specific scope of accreditation under Lab Code: 1109 to perform Electromagnetic Interference tests according to FCC PART 15 AND CISPR 22 requirements. No part of this report may be used to claim or imply product endorsement by TAF or any agency of the Government. In addition, the test facilities are listed with Federal Communications Commission (registration no: TW1109).

5.4 TABLE OF ACCREDITATIONS AND LISTINGS

Our laboratories are accredited and approved by the following accreditation body according to ISO/IEC 17025.

Taiwan	TAF
---------------	-----

The measuring facility of laboratories has been authorized or registered by the following approval agencies.

Canada	Industry Canada
Germany	TUV NORD
Taiwan	BSMI
USA	FCC

Copies of granted accreditation certificates are available for downloading from our web site, <http://www.ccsrf.com>

6. CALIBRATION AND UNCERTAINTY

6.1 MEASURING INSTRUMENT CALIBRATION

The measuring equipment utilized to perform the tests documented in this report has been calibrated in accordance with the manufacturer’s recommendations, and is traceable to recognized national standards.

6.2 MEASUREMENT UNCERTAINTY

Where relevant, the following measurement uncertainty levels have been estimated for tests performed on the apparatus:

PARAMETER	UNCERTAINTY
Radiated Emission, 30 to 200 MHz Test Site : OATS-6	±3.21dB
Radiated Emission, 200 to 1000 MHz Test Site : OATS-6	±3.09dB
Radiated Emission, 1 to 8 GHz	± 2.65dB
Radiated Emission, 8 to 18 GHz	± 2.66dB
Radiated Emission, 18 to 26.5 GHz	± 2.65dB
Radiated Emission, 26 to 40 GHz	± 3.03dB
Power Line Conducted Emission	±1.91dB
Band Width	136.49kHz
Peak Output Power MU	±1.34dB
Band Edge MU	±0.30dBuV
Channel Separation MU	361.69Hz
Duty Cycle MU	0.064ms
Frequency Stability MU	0.223kHz

This measurement uncertainty is confidence of approximately 95%, k=2

7. SETUP OF EQUIPMENT UNDER TEST

7.1 SETUP CONFIGURATION OF EUT

EMI

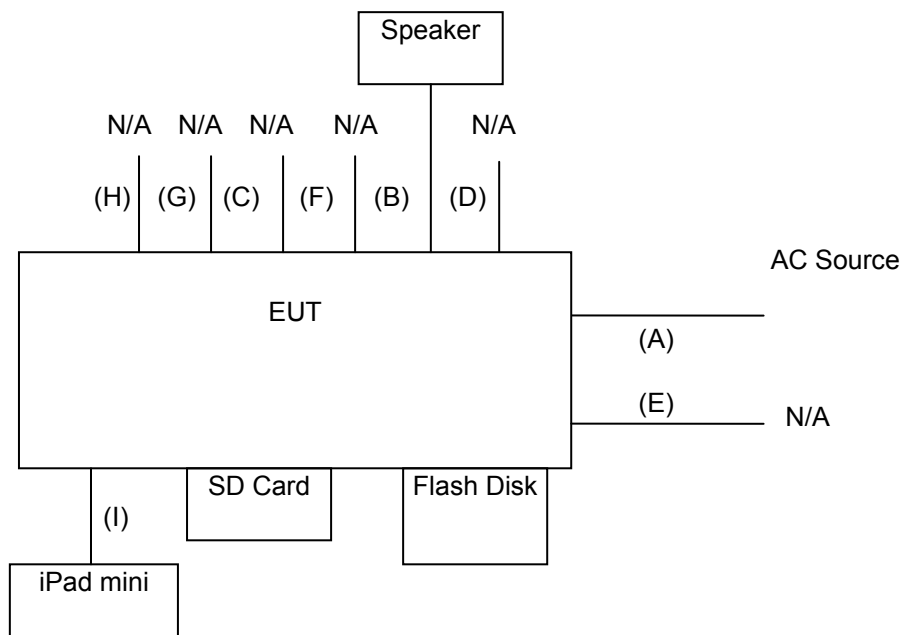

RF

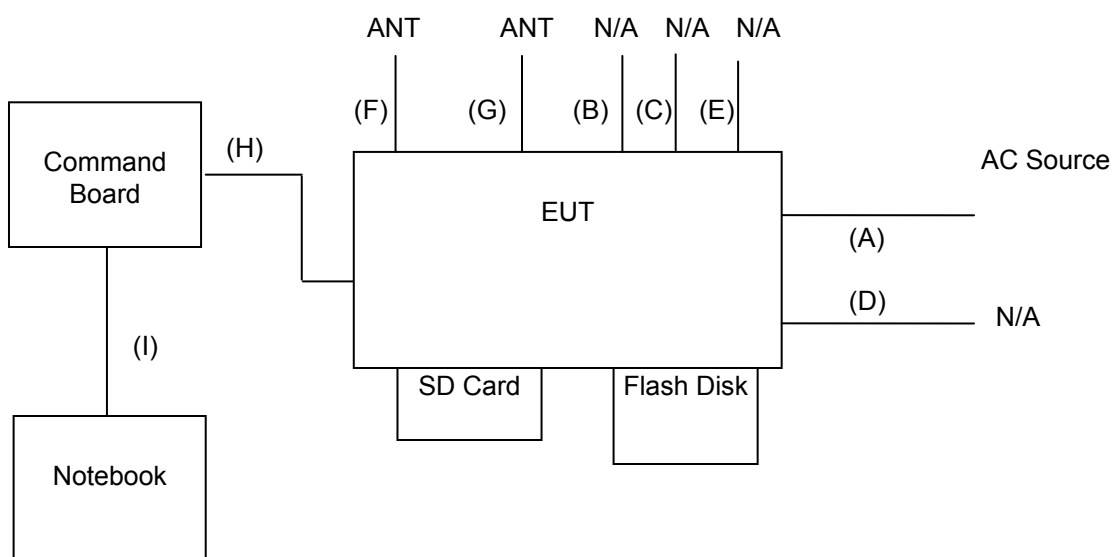

7.2 SUPPORT EQUIPMENT

For EMI test

No.	Product	Manufacturer	Model No.	Certify No.	Signal cable
1	iPad nano	Apple	MA477TA/A	DoC	USB cable, shd, 1.8m
2	Speaker System	ECHO	LA-227	DoC	Audio cable, unshd, 1.6m
3	SD Card	TOSHIBA	2GB	DoC	N/A
4	Flash Disk	San Disk	Dltra Fit USB	3.0 32GB	N/A

No.	Signal cable description	
A	AC Power Cable	Unshielded, 2.0m 1 pcs
B	Audio Cable	Shielded, 1.0m 1 pcs
C	Audio Cable	Shielded, 1.0m 1 pcs
D	Audio Cable	Shielded, 0.8m 2 pcs
E	Audio Cable	Shielded, 0.6m 1 pcs
F	RS-232 Cable	Shielded, 1.6m 1 pcs
G	ANT Cable	Shielded, 1.3m 1 pcs
H	ANT Cable	Shielded, 1.5m 1 pcs
I	Audio Cable	Shielded, 1.0m 1 pcs

For RF test

No.	Product	Manufacturer	Model No.	Certify No.	Signal cable
1	Notebook	Acer	AS 3830TG	DOC	Power cable, unshd, 1.6m
2	Flash Disk	Transcend	Jet flash790	N/A	N/A
3	SD Card	TOSHIBA	2GB	DoC	N/A

No.	Signal cable description	
A	AC Power Cable	Unshielded, 2.0m, 1 pcs
B	Audio Cable	Shielded, 1.0m, 3 pcs
C	MIC Cable	Shielded, 0.8 m, 2 pcs
D	PHONES Cable	Shielded, 0.6m, 1 pcs
E	RS232 Cable	Shielded, 1.6m, 1 pcs
F	ANT Cable	Shielded, 1.3m, 1 pcs
G	ANT Cable	Shielded, 1.5m, 1 pcs
H	Command Cable	Unshielded, 0.2m, 1 pcs
I	USB Cable	Shielded, 1.6m, 1 pcs with one core

Note:

- 1) All the equipment/cables were placed in the worst-case configuration to maximize the emission during the test.
- 2) Grounding was established in accordance with the manufacturer's requirements and conditions for the intended use.
- 3) shd. = shielded; unshd. = unshielded

7.3 EUT OPERATING CONDITION

RF Setup

1. Set up all computers like the setup diagram.
2. The “CSR BlueSuite 2.4.8”, “Blue Test 3” software was used for testing.
3. Choose Transport “SPI” and Port “USB SPI (10003)” .

TX Mode:

GFSK(DH1):

CFG PKT > Packet Type : 4 , Packet Type : 27

TXDATA1 > LO Freq : 2402 (2402,2441,2480) , Power : 255,50

GFSK(DH3):

CFG PKT > Packet Type : 11 , Packet Type : 183

TXDATA1 > LO Freq : 2402 (2402,2441,2480) , Power : 255,50

GFSK(DH5):

CFG PKT > Packet Type : 15 , Packet Type : 339

TXDATA1 > LO Freq : 2402 (2402,2441,2480) , Power : 255,50

8-DPSK(3DH1):

CFG PKT > Packet Type : 24 , Packet Type : 83

TXDATA1 > LO Freq : 2402 (2402,2441,2480) , Power : 255,50

8-DPSK(3DH3):

CFG PKT > Packet Type : 27 , Packet Type : 552

TXDATA1 > LO Freq : 2402 (2402,2441,2480) , Power : 255,50

8-DPSK(3DH5):

CFG PKT > Packet Type : 31 , Packet Type : 1021

TXDATA1 > LO Freq : 2402 (2402,2441,2480) , Power : 255,50

DSSS:

BLE TEST TX > Channel :0 (0,20,39)

Length : 37

Bit pattern : 0

RX Mode:

GFSK , 8-DPSK:

RXDATA1

DSSS:

BLE TEST RX

4. All of the function are under run.
- 5 .Start test.

8. APPLICABLE LIMITS AND TEST RESULTS

8.1 6DB BANDWIDTH

LIMIT

§ 15.207(a) (2) For direct sequence systems, the minimum 6dB bandwidth shall be at least 500kHz

TEST EQUIPMENTS

Name of Equipment	Manufacturer	Model	Serial Number	Calibration Due
EXA Spectrum Analyzer	KEYSIGHT	N9010A	MY54430216	05/08/2018

TEST SETUP

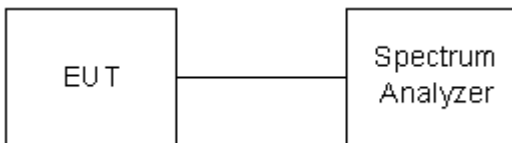

TEST PROCEDURE

- a) Set RBW = 100 kHz.
- b) Set the video bandwidth (VBW) ≥ 3 RBW.
- c) Detector = Peak.
- d) Trace mode = max hold.
- e) Sweep = auto couple.
- f) Allow the trace to stabilize.
- g) Measure the maximum width of the emission that is constrained by the frequencies associated with the two outermost amplitude points (upper and lower frequencies) that are attenuated by 6 dB relative to the maximum level measured in the fundamental emission.

TEST RESULTS

No non-compliance noted.

Model Name	CD-400U	Test By	Ted Huang
Temp & Humidity	26.8°C, 53%	Test Date	2017/09/22

DSSS mode

Channel	Channel Frequency (MHz)	6dB Bandwidth (kHz)	Minimum Limit (kHz)	Pass / Fail
Low	2402	701.00	500	PASS
Middle	2442	693.00	500	PASS
High	2480	694.00	500	PASS

- NOTE :**
1. At final test to get the worst-case emission at 1Mbps long.
 2. The cable assembly insertion loss of 11.1dB (including 10 dB pad and 1.1 dB cable) was entered as an offset in the spectrum analyzer to allow for direct reading of power.

6dB BANDWIDTH (DSSS MODE)

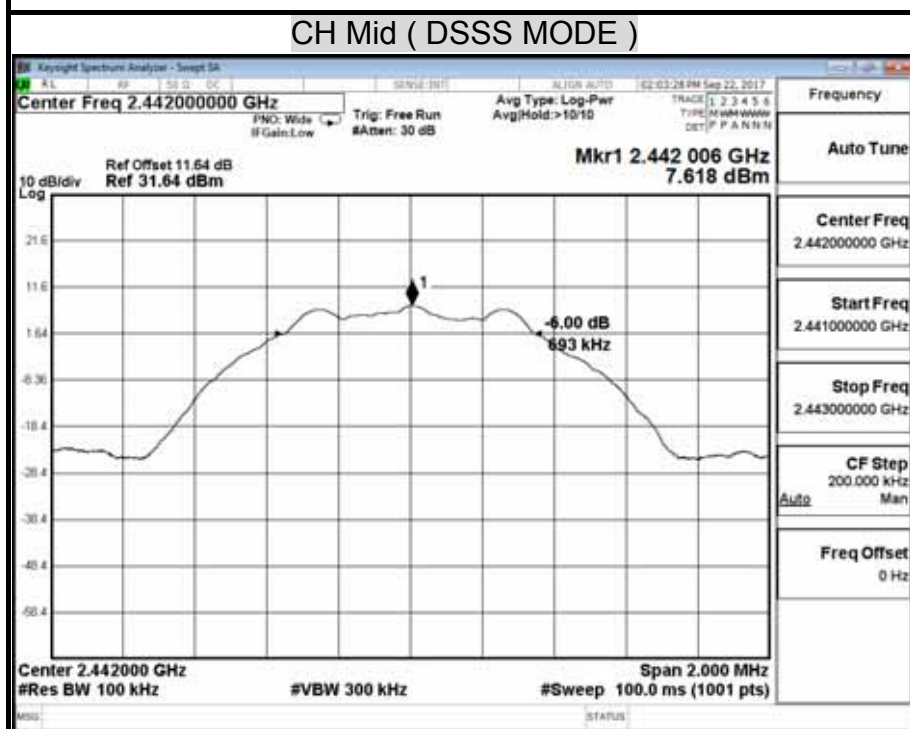
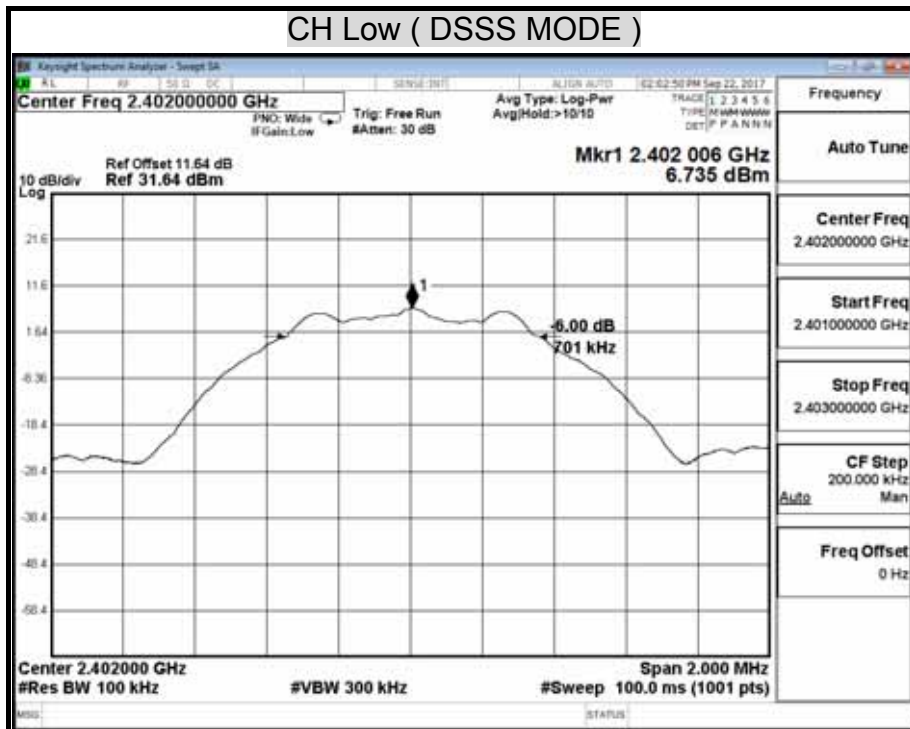

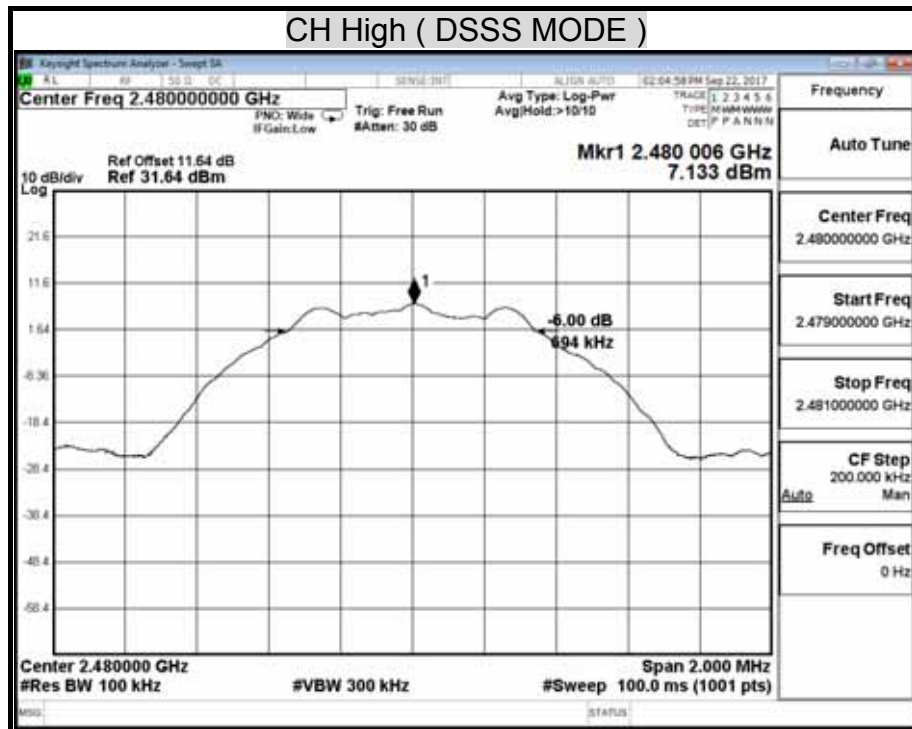

8.2 MAXIMUM PEAK OUTPUT POWER

LIMIT

§ 15.247(b) The maximum peak output power of the intentional radiator shall not exceed the following :

§ 15.247(b) (3) For systems using digital modulation in the 902-928 MHz, 2400-2483.5 MHz, and 5725-5850 MHz bands : 1 watt.

§ 15.247(b) (4) Except as shown in paragraphs (c) of this section , if transmitting antennas of directional gain greater than 6 dBi are used the peak output power from the intentional radiator shall be reduced below the stated values in paragraphs (b)(1) or (b)(2), and (b)(3) of this section , as appropriate, by the amount in dB that the directional gain of the antenna exceeds 6 dBi.

TEST EQUIPMENTS

Name of Equipment	Manufacturer	Model	Serial Number	Calibration Due
EXA Spectrum Analyzer	KEYSIGHT	N9010A	MY54430216	05/08/2018
Power Meter	Anritsu	ML2487A	6K00003888	04/06/2018

Remark: Each piece of equipment is scheduled for calibration once a year.

TEST SETUP

For Peak Power

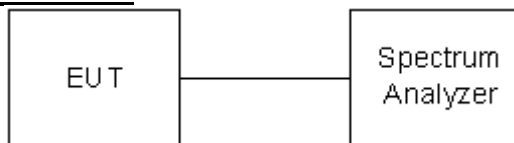

For Average Power

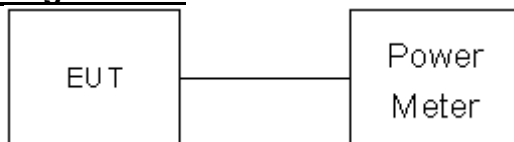

TEST PROCEDURE

The tests were performed in accordance with KDB 558074 9.1.1

9.1.1 Measurement Procedure PK2:

- a) Set the RBW \geq DTS bandwidth.
- b) Set VBW \geq 3 RBW.
- c) Set span \geq 3 x RBW
- d) Sweep time = auto couple.
- e) Detector = peak.
- f) Trace mode = max hold.
- g) Allow trace to fully stabilize.
- h) Use peak marker function to determine the peak amplitude level.

Average Power

Connect the EUT to power meter, set the center frequency of the power meter to the channel center frequency.

TEST RESULTS

No non-compliance noted.

Model Name	CD-400U	Test By	Ted Huang
Temp & Humidity	26.8°C, 53%	Test Date	2017/09/22

DSSS mode

Channel	Channel Frequency (MHz)	Peak Power (dBm)	Peak Power Limit (dBm)	Pass / Fail
Low	2402	7.07	30.00	PASS
Middle	2442	7.93	30.00	PASS
High	2480	7.41	30.00	PASS

NOTE : 1. At final test to get the worst-case emission at 1Mbps long.
2. The cable assembly insertion loss of 11.1dB (including 10 dB pad and 1.1 dB cable) was entered as an offset in the power meter to allow for direct reading of power.

Average Power Data

Model Name	CD-400U	Test By	Ted Huang
Temp & Humidity	26.8°C, 53%	Test Date	2017/09/22

DSSS mode

Channel	Channel Frequency (MHz)	Average Power (dBm)
Low	2402	4.56
Middle	2442	5.46
High	2480	4.98

MAXIMUM PEAK OUTPUT POWER (DSSS MODE)

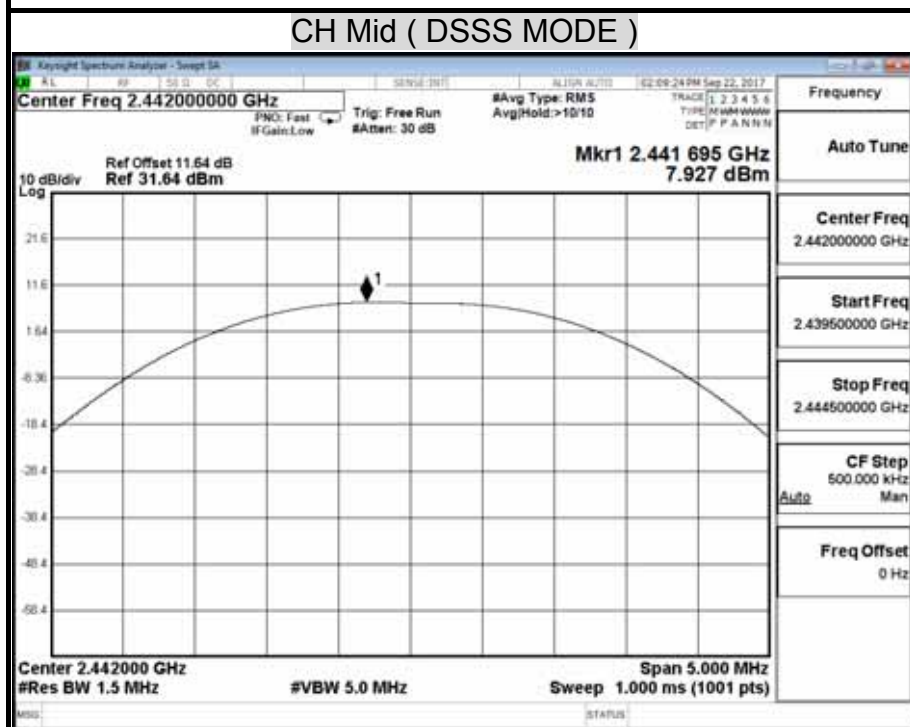
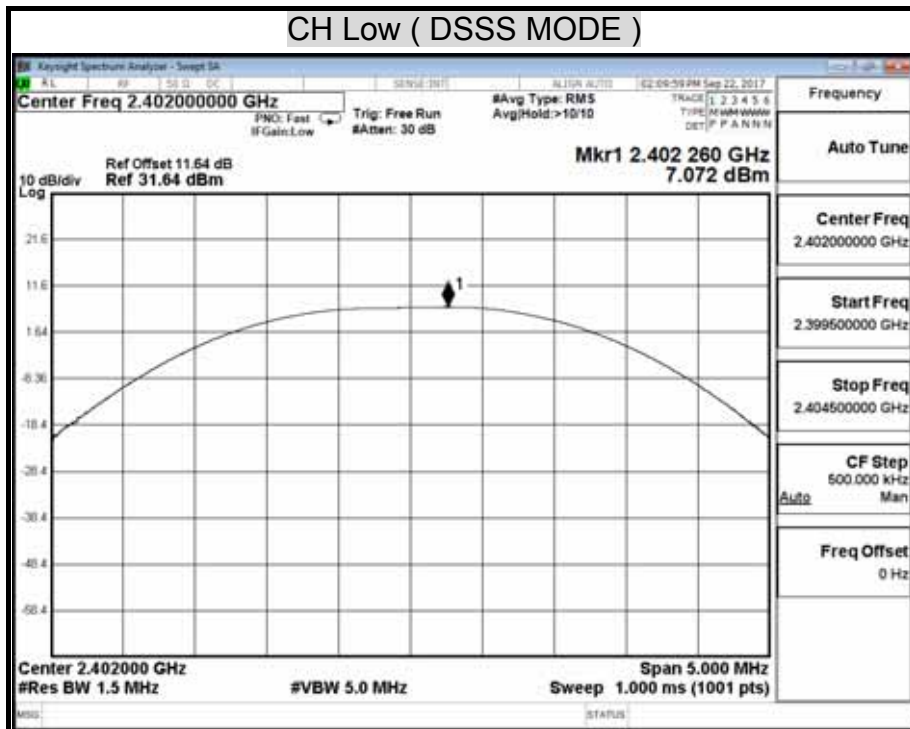

8.3 DUTY CYCLE

LIMIT

Nil (No dedicated limit specified in the Rules)

TEST EQUIPMENT

Name of Equipment	Manufacturer	Model	Serial Number	Calibration Due
EXA Spectrum Analyzer	KEYSIGHT	N9010A	MY54430216	05/08/2018

Remark: Each piece of equipment is scheduled for calibration once a year.

TEST SETUP



TEST PROCEDURE

1. Place the EUT on the table and set it in transmitting mode.
2. Remove the antenna from the EUT and then connect a low loss RF cable from the antenna port to the spectrum analyzer.
3. The zero-span mode on a spectrum analyzer or EMI receiver if the response time and spacing between bins on the sweep are sufficient to permit accurate measurements of the on and off times of the transmitted signal. Set the center frequency of the instrument to the center frequency of the transmission. Set $RBW \geq OBW$ if possible; otherwise, set RBW to the largest available value. Set $VBW \geq RBW$. Set detector = peak or average. The zero-span measurement method shall not be used unless both RBW and VBW are $> 50/T$ and the number of sweep points across duration T exceeds 100. (For example, if VBW and/or RBW are limited to 3 MHz, then the zero-span method of measuring duty cycle shall not be used if $T \leq 16.7$ microseconds.)

TEST RESULTS

No non-compliance noted.

Model Name	CD-400U	Test By	Ted Huang
Temp & Humidity	26.8°C, 53%	Test Date	2017/09/22

DSSS Mode

	us	Times	Ton	Total Ton time(ms)
Ton1	2920.000	1	2920	
Ton2		0	0	
Ton3			0	2.92
Tp				3.76

Ton	2.92
Tp(Ton+Toff)	3.76
Duty Cycle	0.776595745
Duty Factor	1.098049935

TEST PLOT

Duty Cycle

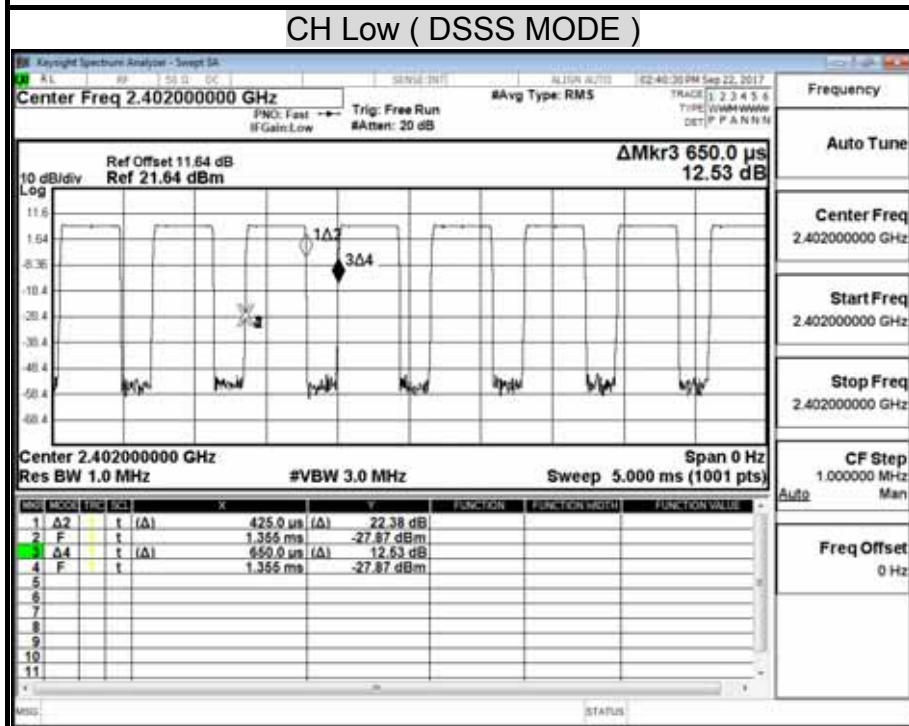
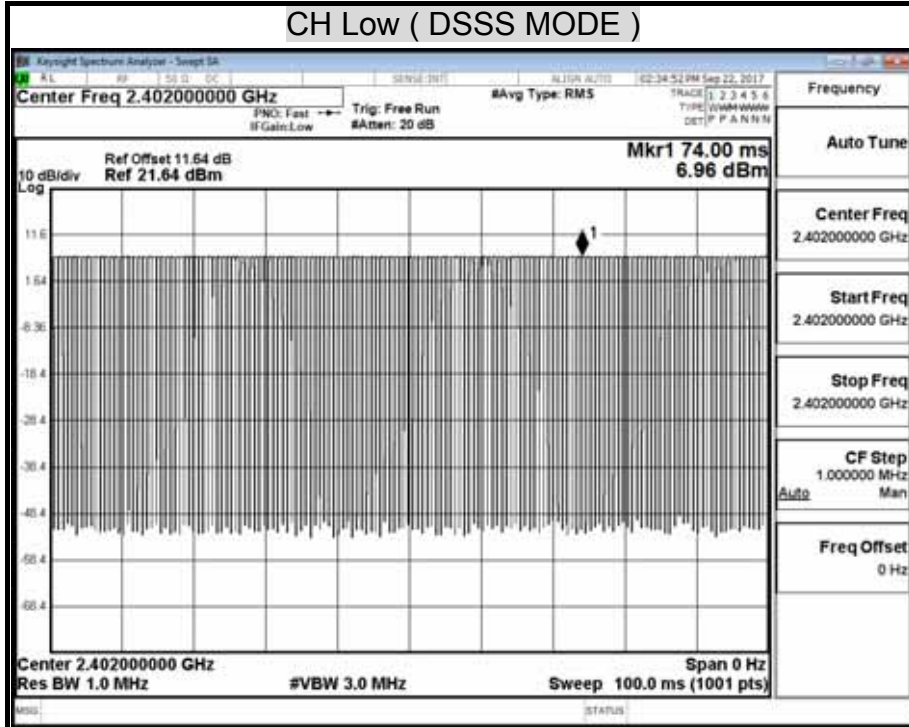

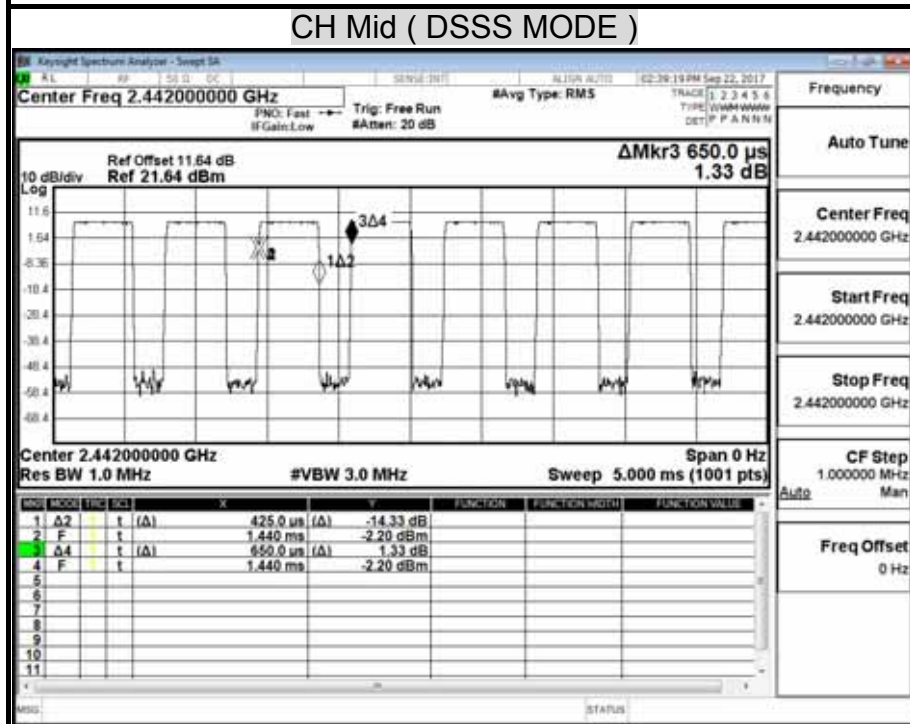
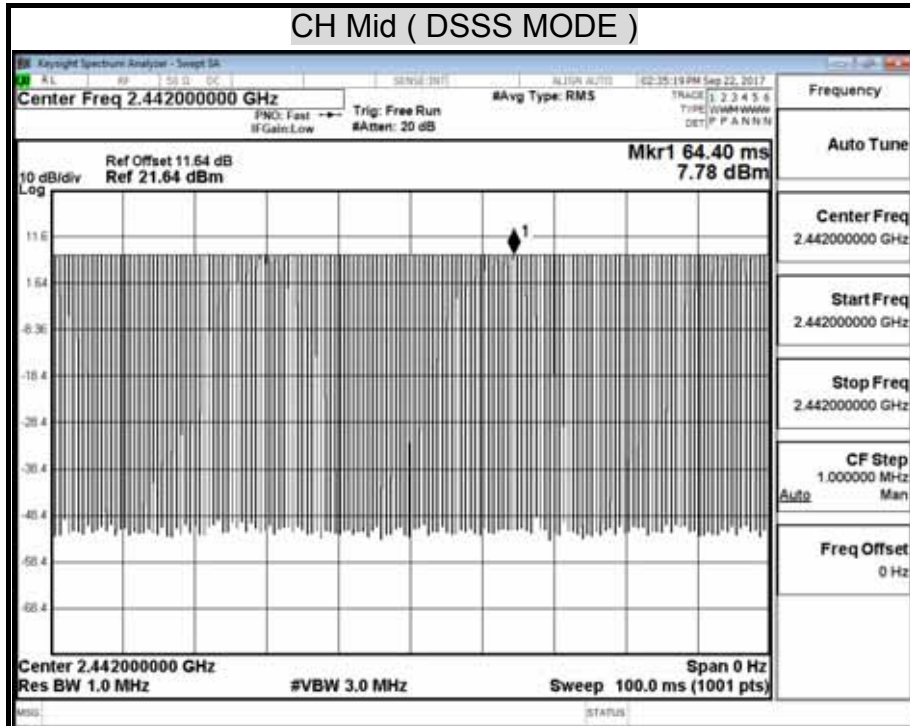

CH High (DSSS MODE)

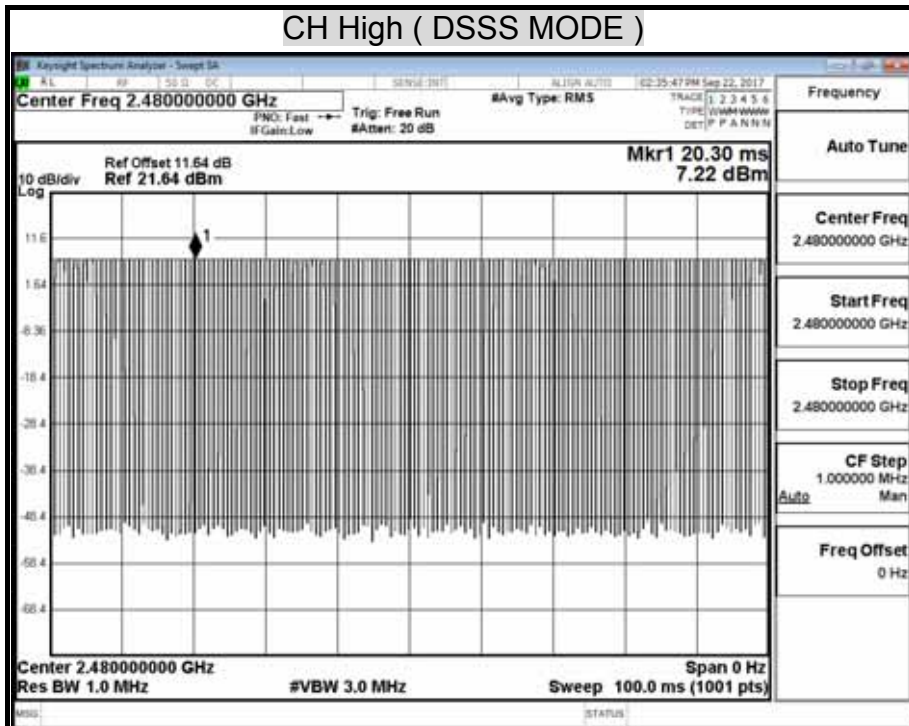

CH High (DSSS MODE)

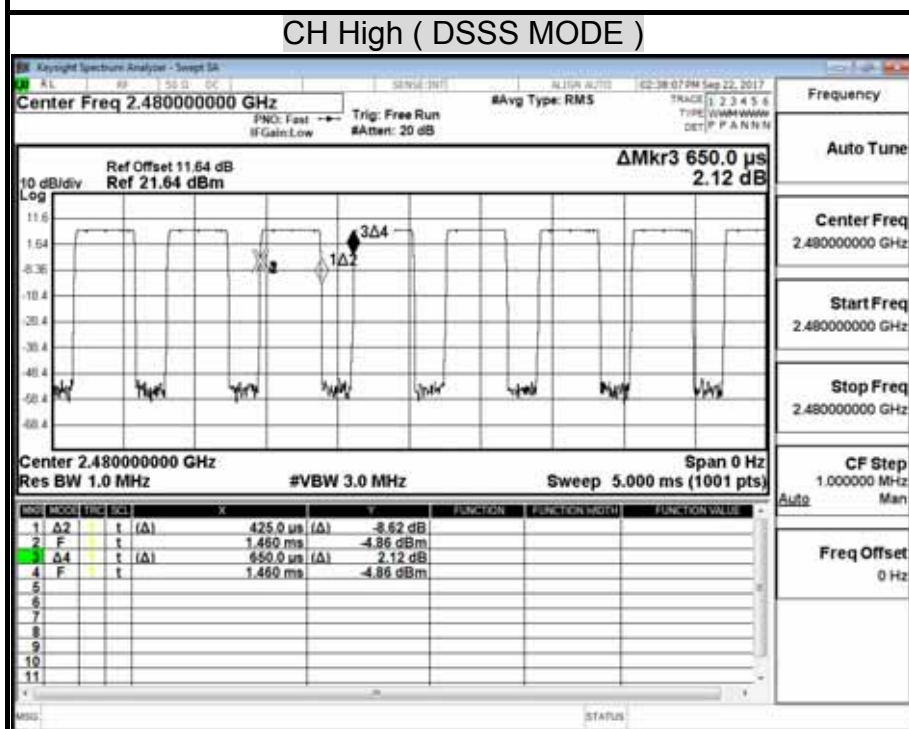

8.4 POWER SPECTRAL DENSITY

LIMIT

§ 15.247(e) For digitally modulated systems, the power spectral density conducted from the intentional radiator to the antenna shall not greater than 8 dBm in any 3 kHz band during any time interval of continuous transmission.

TEST EQUIPMENTS

Name of Equipment	Manufacturer	Model	Serial Number	Calibration Due
EXA Spectrum Analyzer	KEYSIGHT	N9010A	MY54430216	05/08/2018

TEST SETUP

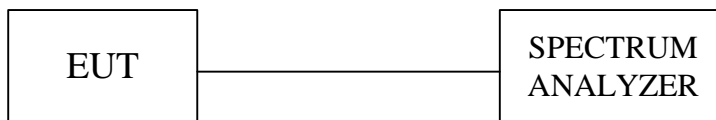

TEST PROCEDURE

The tests were performed in accordance with 558074 D01 DTS Meas Guidance v03r03.

10.2 Method PKPSD (peak PSD):

1. Set analyzer center frequency to DTS channel center frequency.
2. Set the span to 1.5 times the DTS bandwidth.
3. Set the RBW to: $3 \text{ kHz} \leq \text{RBW} \leq 100 \text{ kHz}$.
4. Set the VBW $\geq 3 \text{ RBW}$.
5. Detector = peak.
6. Sweep time = auto couple.
7. Trace mode = max hold.
8. Allow trace to fully stabilize.
9. Use the peak marker function to determine the maximum amplitude level within the RBW.
10. If measured value exceeds limit, reduce RBW (no less than 3 kHz) and repeat.

TEST RESULTS

No non-compliance noted.

Model Name	CD-400U	Test By	Ted Huang
Temp & Humidity	26.8°C, 53%	Test Date	2017/09/22

DSSS mode

Channel	Frequency (MHz)	PPSD (dBm)	Limit (dBm)	Margin (dB)	Result
Low	2402	6.74	8.00	-1.27	PASS
Middle	2442	7.62	8.00	-0.38	PASS
High	2480	7.13	8.00	-0.87	PASS

NOTE : 1. At final test to get the worst-case emission at 1Mbps long.
 2. The cable assembly insertion loss of 11.1dB (including 10 dB pad and 1.1 dB cable) was Entered as an offset in the spectrum analyzer to allow for direct reading of power.

POWER SPECTRAL DENSITY (DSSS MODE)

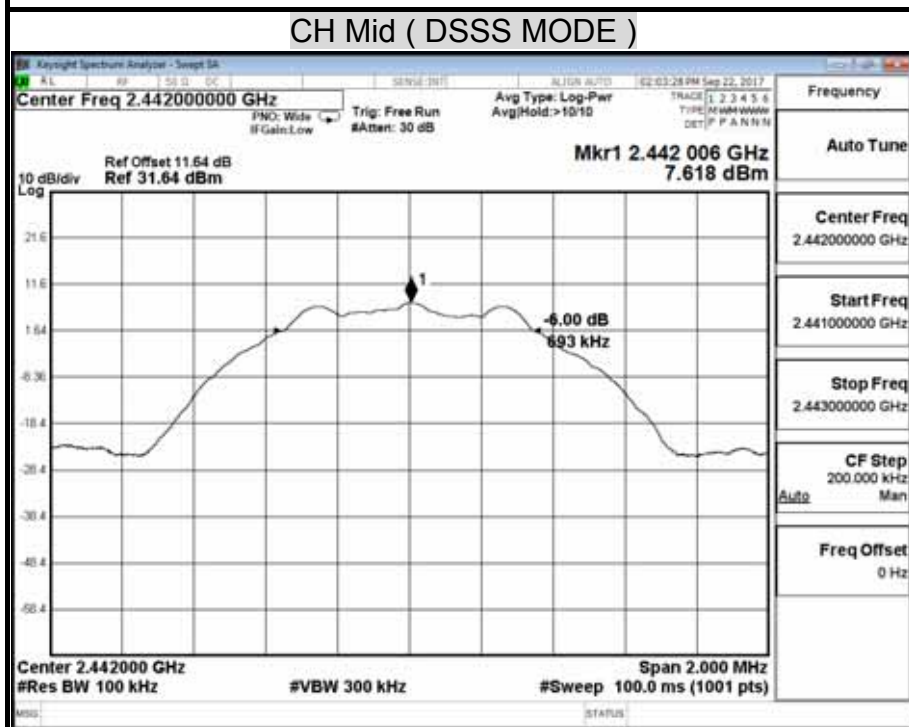
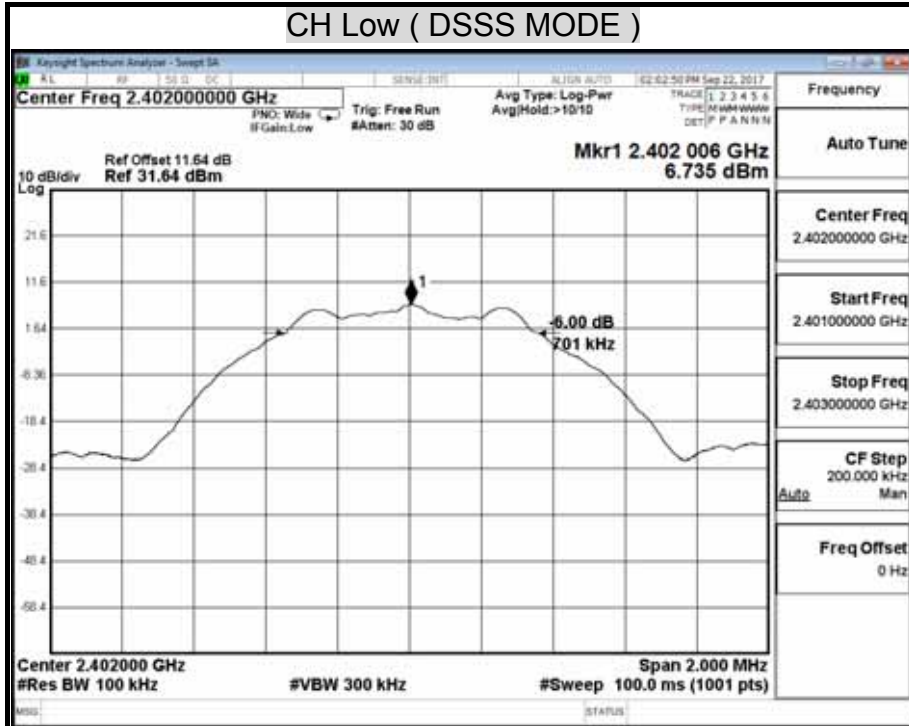

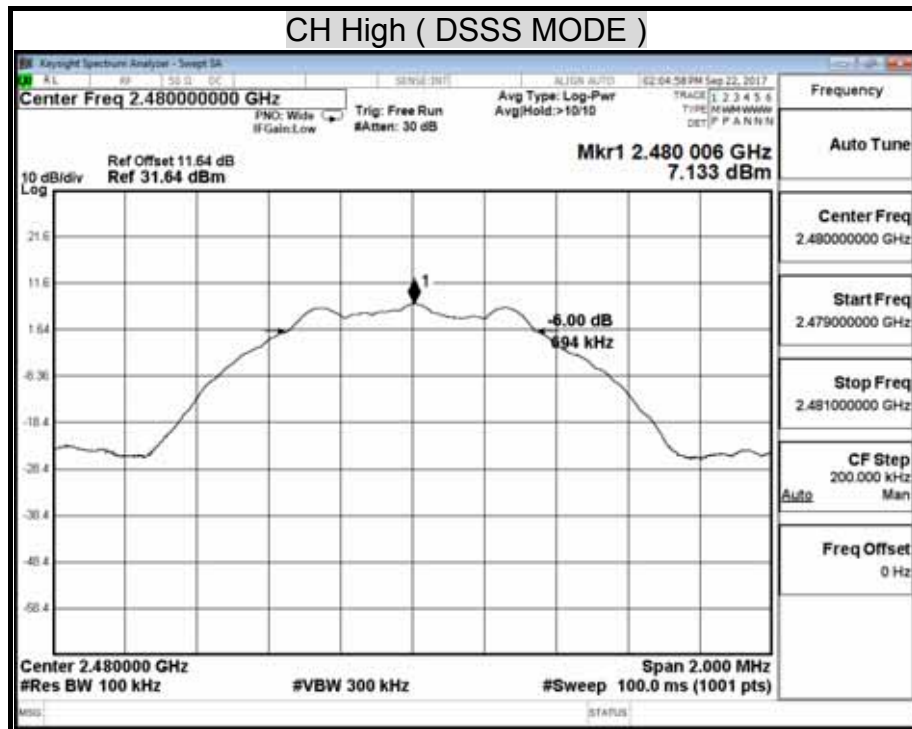

8.6 CONDUCTED SPURIOUS EMISSION

LIMITS

§ 15.247(d) In any 100 kHz bandwidth outside the frequency band in which the spread spectrum intentional radiator is operating, the radio frequency power that is produced by the intentional radiator shall be at least 20 dB below that in the 100 kHz bandwidth within the and that contains the highest level of the desired power, based on either an RF conducted or a radiated measurement. Attenuation below the general limits specified in § 15.209(a) is not required. In addition, radiated emissions which fall in the restricted bands, as defined in § 15.205(a), must also comply with the radiated emission limits specified in § 15.209(a) (see § 15.205(c)).

TEST EQUIPMENT

Name of Equipment	Manufacturer	Model	Serial Number	Calibration Due
EXA Spectrum Analyzer	KEYSIGHT	N9010A	MY54430216	05/08/2018

Remark: Each piece of equipment is scheduled for calibration once a year.

TEST SETUP



TEST PROCEDURE

The transmitter output is connected to a spectrum analyzer. The resolution bandwidth is set to 1 MHz. The video bandwidth is set to 1 MHz.

The spectrum from 30 MHz to 26 GHz is investigated with the transmitter set to the lowest, middle, and highest channels in the 2.4 GHz band.

TEST RESULTS

No non-compliance noted.

TEST DATA

Model Name	CD-400U	Test By	Ted Huang
Temp & Humidity	26.8°C, 53%	Test Date	2017/09/22

OUT-OF-BAND SPURIOUS EMISSIONS-CONDUCTED MEASUREMENT

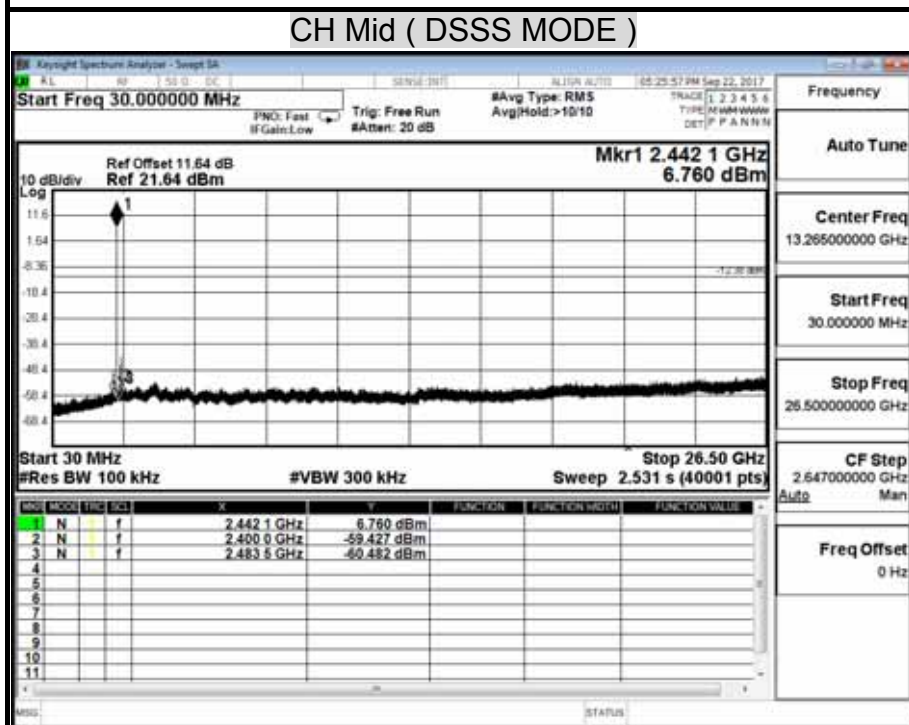
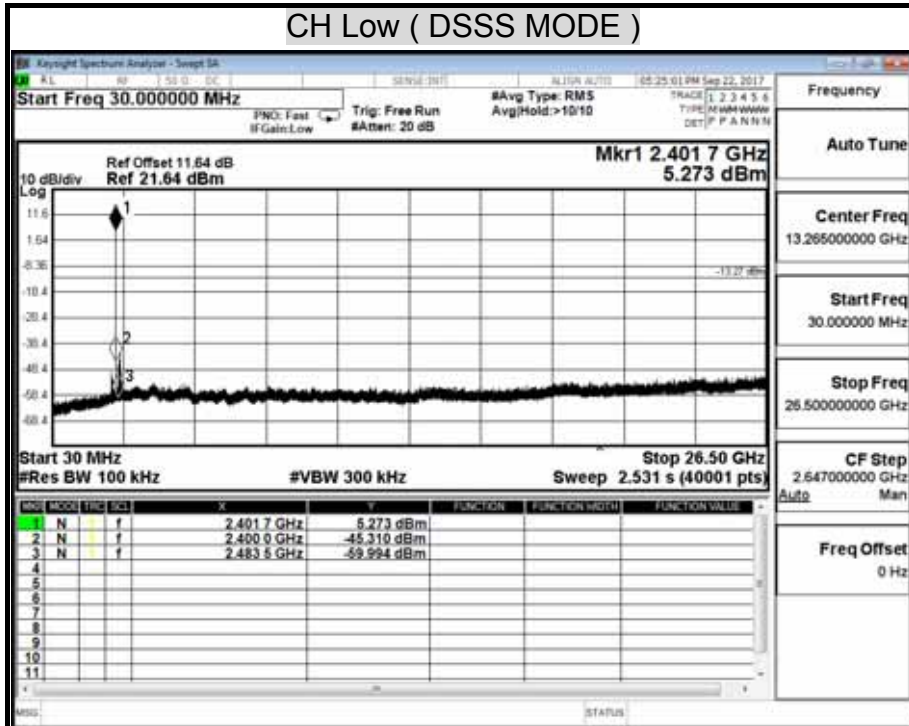

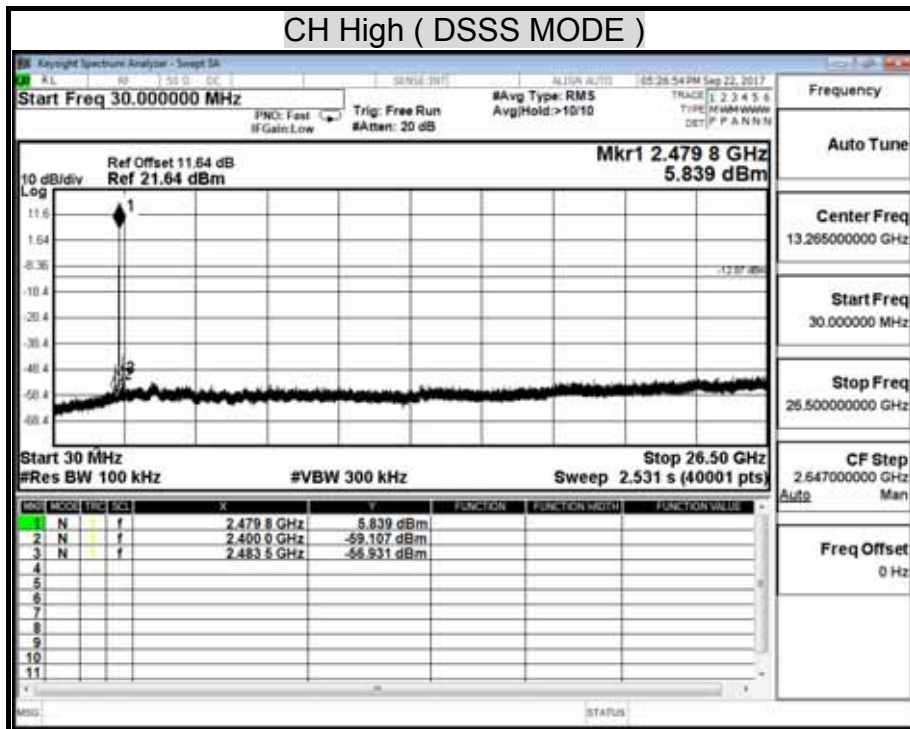

(REFERENCE LEVEL)
CH Low (DSSS MODE)

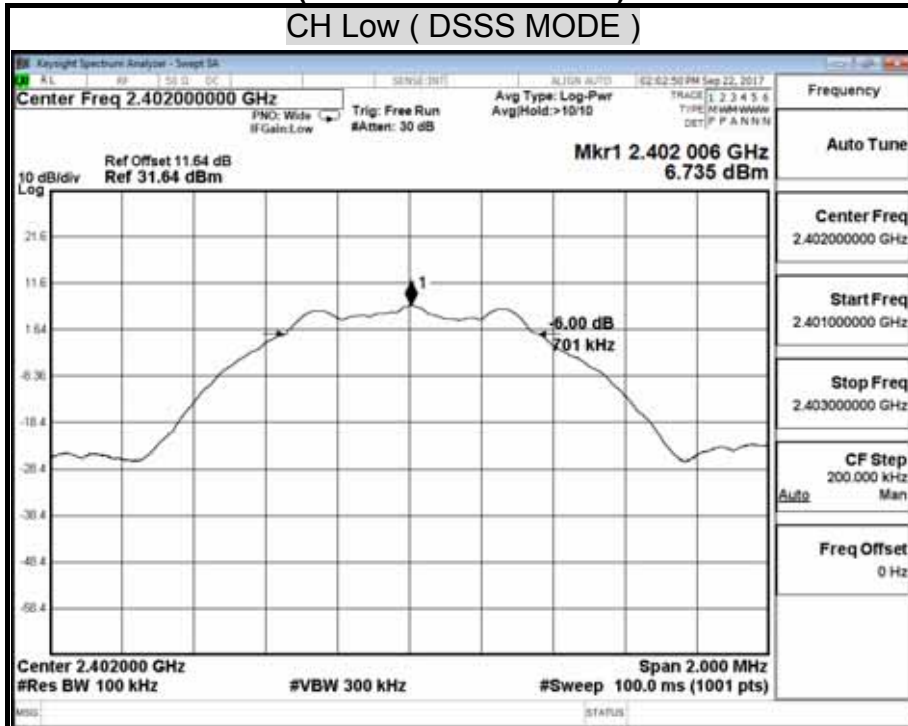

CH Mid (DSSS MODE)

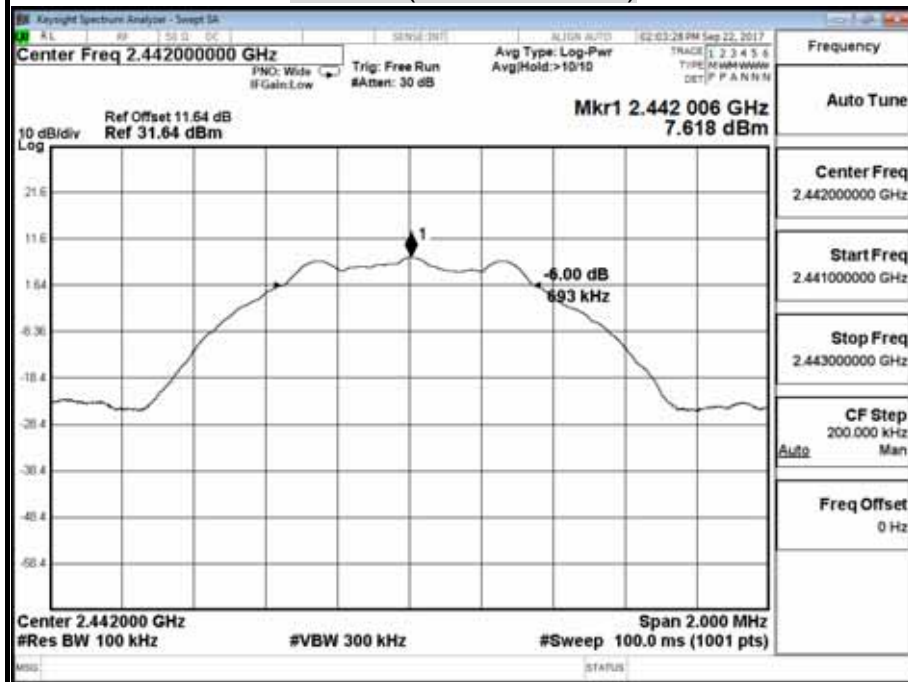

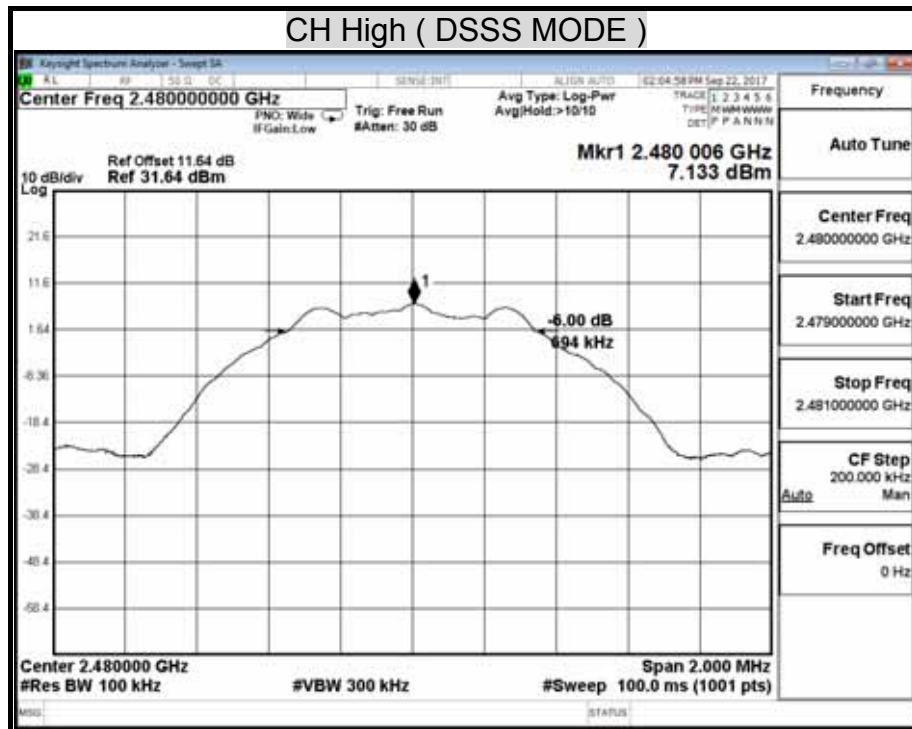

8.7 RADIATED EMISSIONS

8.7.1 TRANSMITTER RADIATED SUPURIOUS EMISSIONS LIMITS

§ 15.205 (a) Except as shown in paragraph (d) of this section, only spurious emissions are permitted in any of the frequency bands listed below:

MHz	MHz	MHz	GHz
0.090 - 0.110	16.42 - 16.423	399.9 - 410	4.5 - 5.15
¹ 0.495 - 0.505	16.69475 - 16.69525	608 - 614	5.35 - 5.46
2.1735 - 2.1905	16.80425 - 16.80475	960 - 1240	7.25 - 7.75
4.125 - 4.128	25.5 - 25.67	1300 - 1427	8.025 - 8.5
4.17725 - 4.17775	37.5 - 38.25	1435 - 1626.5	9.0 - 9.2
4.20725 - 4.20775	73 - 74.6	1645.5 - 1646.5	9.3 - 9.5
6.215 - 6.218	74.8 - 75.2	1660 - 1710	10.6 - 12.7
6.26775 - 6.26825	108 - 121.94	1718.8 - 1722.2	13.25 - 13.4
6.31175 - 6.31225	123 - 138	2200 - 2300	14.47 - 14.5
8.291 - 8.294	149.9 - 150.05	2310 - 2390	15.35 - 16.2
8.362 - 8.366	156.52475 - 156.52525	2483.5 - 2500	17.7 - 21.4
8.37625 - 8.38675	156.7 - 156.9	2655 - 2900	22.01 - 23.12
8.41425 - 8.41475	162.0125 - 167.17	3260 - 3267	23.6 - 24.0
12.29 - 12.293	167.72 - 173.2	3332 - 3339	31.2 - 31.8
12.51975 - 12.52025	240 - 285	3345.8 - 3338	36.43 - 36.5
12.57675 - 12.57725	322 - 335.4	3600 - 4400	(²)
13.36 - 13.41			

¹ Until February 1, 1999, this restricted band shall be 0.490-0.510 MHz.

² Above 38.6

§ 15.205 (b) Except as provided in paragraphs (d) and (e), the field strength of emissions appearing within these frequency bands shall not exceed the limits shown in Section 15.209. At frequencies equal to or less than 1000 MHz, compliance with the limits in Section 15.209 shall be demonstrated using measurement instrumentation employing a CISPR quasi-peak detector. Above 1000 MHz, compliance with the emission limits in Section 15.209 shall be demonstrated based on the average value of the measured emissions. The provisions in Section 15.35 apply to these measurements.

§ 15.209 (a) Except as provided elsewhere in this Subpart, the emissions from an intentional radiator shall not exceed the field strength levels specified in the following table :

Frequency (MHz)	Field Strength (microvolts/meter)	Measurement Distance (meters)
30 - 88	100 **	3
88 - 216	150 **	3
216 - 960	200 **	3
Above 960	500	3

** Except as provided in paragraph (g), fundamental emissions from intentional radiators operating under this Section shall not be located in the frequency bands 54-72 MHz, 76-88 MHz, 174-216 MHz or 470-806 MHz, However, operation within these frequency bands is permitted under other sections of this Part, e-g, Sections 15.231 and 15.241.

§ 15.209 (b) In the emission table above, the tighter limit applies at the band edges.

TEST EQUIPMENTS

The following test equipments are utilized in making the measurements contained in this report.

Chamber Room # 966				
Name of Equipment	Manufacturer	Model	Serial Number	Calibration Due
Amplifier	HP	8447F	2443A01671	01/17/2018
Bi-Log Antenna	Sunol	JB1	A070506-2	07/22/2018
Cable	HUBER+SUHNER	SUCOFLEX 104PEA	SN25737 /4PEA	01/17/2018
Double Ridged Guide Horn Antenna	ETS-LINDGREN	3116	00078900	03/19/2019
EXA Spectrum Analyzer	KEYSIGHT	N9010A	MY54430216	05/08/2018
Horn Antenna	Com-Power	AH-118	071032	02/08/2018
Power Meter	Anritsu	ML2487A	6K00003888	04/06/2018
Power Sensor	Anritsu	MA2491A	033265	04/06/2018
Pre-Amplifier	EMCI	EMC012645	980098	01/16/2018
Tem/Hum Chamber	K.SON	THS-M1	242	09/12/2018
Vector signal generator	ROHDE&SCHWARZ	SMU 200A	103565	12/06/2017

Remark: 1. Each piece of equipment is scheduled for calibration once a year.

TEST SETUP

The diagram below shows the test setup that is utilized to make the measurements for emission from 30 to 1GHz.

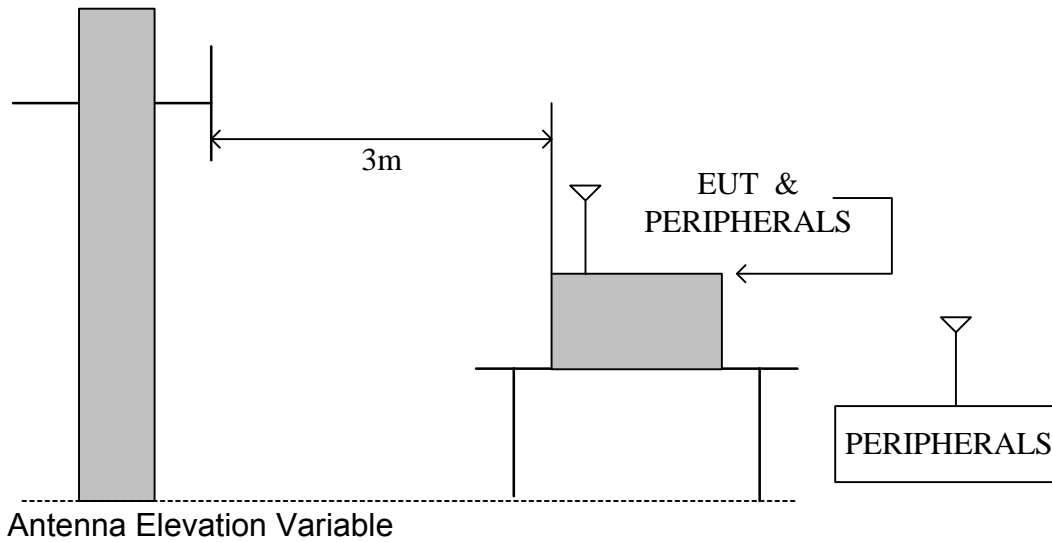

The diagram below shows the test setup that is utilized to make the measurements for emission above 1GHz.

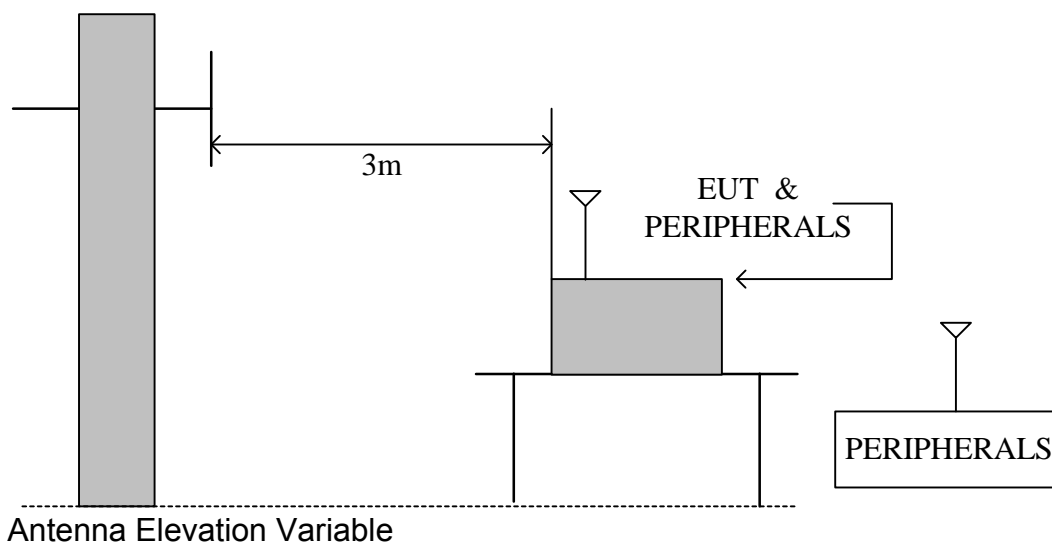

TEST PROCEDURE

- a. The EUT was placed on the top of a rotating table 0.8/1.5 meters above the ground at a 10 meter open area test site. The table was rotated 360 degrees to determine the position of the highest radiation.
- b. While measuring the radiated emission below 1GHz, the EUT was set 3 meters away from the interference-receiving antenna, which was mounted on the top of a variable-height antenna tower. While measuring the radiated emission above 1GHz, the EUT was set 3 meters away from the interference-receiving antenna
- c. The antenna is a broadband antenna, and its height is varied from one meter to four meters above the ground to determine the maximum value of the field strength. Both horizontal and vertical polarization of the antenna are set to make the measurement.
- d. For each suspected emission, the EUT was arranged to its worst case and then the antenna was tuned to heights from 1 meter to 4 meters and the table was turned from 0 degrees to 360 degrees to find the maximum reading.
- e. The test-receiver system was set to Peak Detect Function and Specified Bandwidth with Maximum Hold Mode.
- f. If the emission level of the EUT in peak mode was 10 dB lower than the limit specified, then testing could be stopped and the peak values of the EUT would be reported. Otherwise the emissions that did not have 10 dB margin would be re-tested one by one using peak, quasi-peak or average method as specified and then reported in a data sheet.
- g. The tests were performed in accordance with 558074 D01 DTS Meas Guidance v03r03.

NOTE :

1. The resolution bandwidth and video bandwidth of test receiver/spectrum analyzer is 120 KHz for Peak detection (PK) and Quasi-peak detection (QP) at frequency below 1GHz.
2. The resolution bandwidth and video bandwidth of test receiver/spectrum analyzer is 1 MHz for Peak detection and frequency above 1GHz.
3. The resolution bandwidth of test receiver/spectrum analyzer is 1 MHz and the video bandwidth is 10 Hz for Average detection (AV) at frequency above 1GHz.
4. **No emission is found between lowest internal used/generated frequency to 30MHz (9kHz~30MHz)**

TEST RESULTS

No non-compliance noted.

8.7.2 WORST-CASE RADIATED EMISSION BELOW 1 GHz

Product Name	CD PLAYER/TUNER	Test Date	2017/10/13
Model Name	CD-400U	Test By	Ted Huang
Test Mode	TX	Temp & Humidity	27.8°C, 54%

Vertical

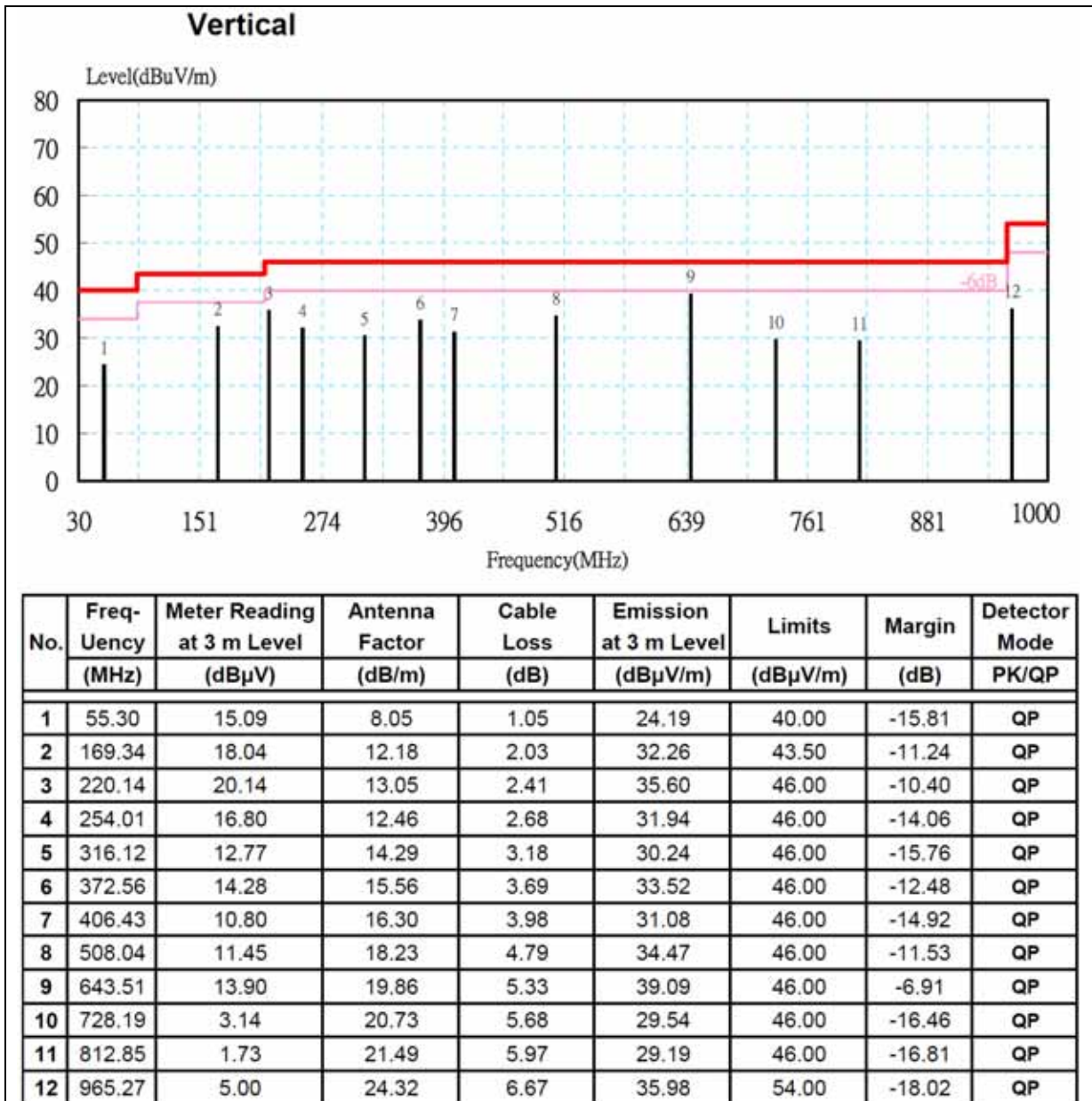

Remark:

- No emission found between lowest internal used/generated frequency to 30MHz (9kHz~30MHz).
- Radiated emissions measured were made with an instrument using peak/quasi-peak detector mode.
- Quasi-peak test would be performed if the peak result were greater than the quasi-peak limit or as required by the applicant.
- Margin (dB) = Remark result (dBuV/m) – Quasi-peak limit (dBuV/m).

Product Name	CD PLAYER/TUNER	Test Date	2017/10/13
Model Name	CD-400U	Test By	Ted Huang
Test Mode	TX	Temp & Humidity	27.8°C, 54%

Horizontal

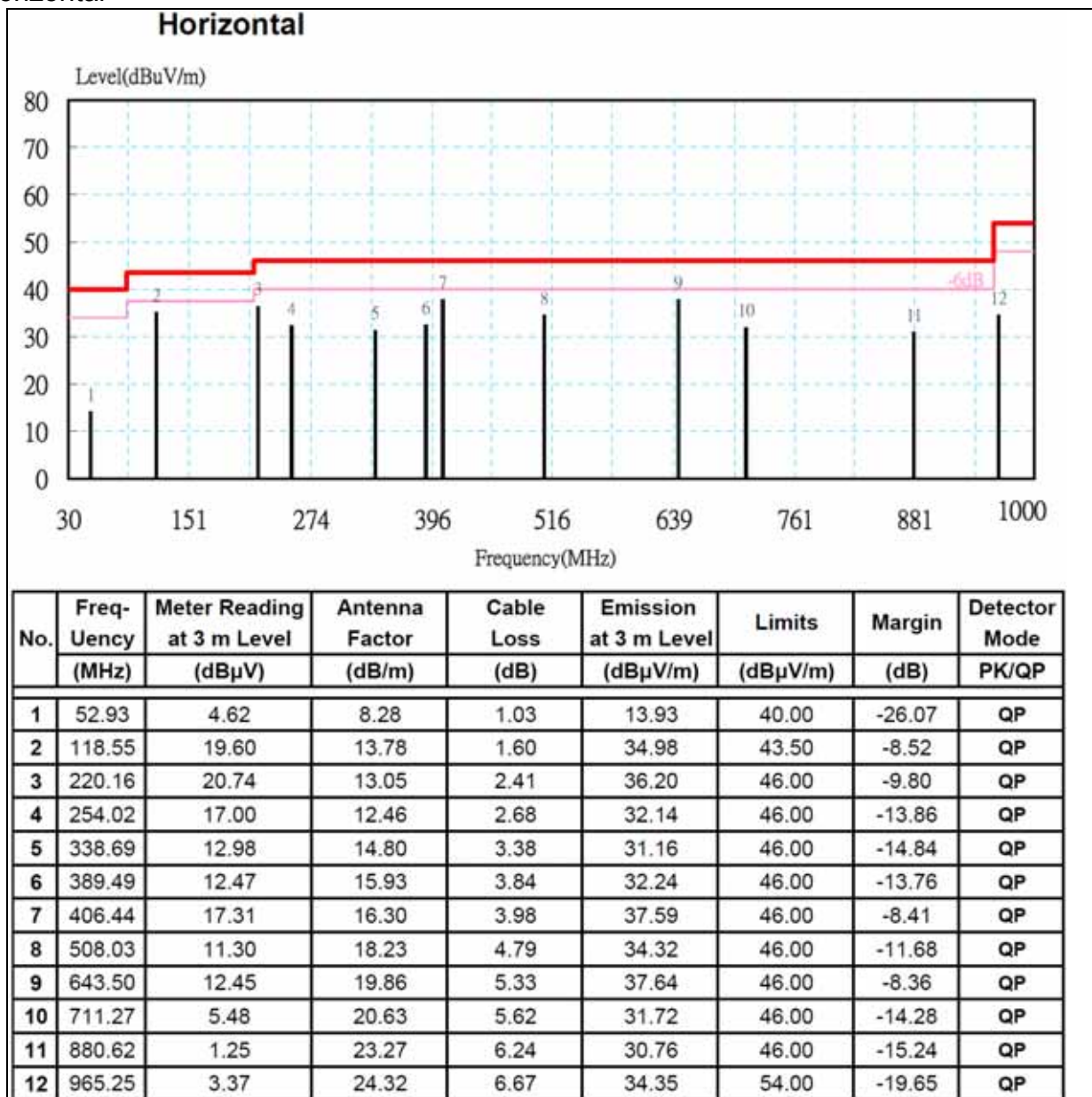
Remark:

1. No emission found between lowest internal used/generated frequency to 30MHz (9kHz~30MHz).
2. Radiated emissions measured were made with an instrument using peak/quasi-peak detector mode.
3. Quasi-peak test would be performed if the peak result were greater than the quasi-peak limit or as required by the applicant.
4. Margin (dB) = Remark result (dBuV/m) – Quasi-peak limit (dBuV/m).

8.7.3 TRANSMITTER RADIATED EMISSION ABOVE 1 GHz

Product Name	CD PLAYER/TUNER	Test Date	2017/09/22
Model	CD-400U	Test By	Ted Huang
Test Mode	DSSS TX (CH Low)	TEMP& Humidity	26.8 , 53%

Horizontal

TX / DSSS mode / CH Low				Measurement Distance at 3m				Horizontal polarity		
Freq.	Reading	AF	Cable Loss	Pre-amp	Filter	Level	Limit	Margin	Mark	
(MHz)	(dBμV)	(dB/m)	(dB)	(dB)	(dB)	(dBμV/m)	(dBμV/m)	(dB)	(P/Q/A)	
* 1174.65	59.85	25.30	1.85	44.44	0.42	42.98	74.00	-31.02	P	
* 1174.65	48.75	25.30	1.85	44.44	0.42	31.88	54.00	-22.12	A	
3103.21	61.52	30.32	3.19	44.17	0.66	51.52	90.30	-38.78	P	
3103.21	57.73	30.32	3.19	44.17	0.66	47.73	89.62	-41.89	A	
* 4804.14	59.14	33.79	4.06	43.87	0.22	53.35	74.00	-20.65	P	
* 4804.14	50.24	33.79	4.06	43.87	0.22	44.45	54.00	-9.55	A	
7206.50	57.35	38.73	5.08	42.87	0.27	58.56	90.30	-31.75	P	
7206.50	47.40	38.73	5.08	42.87	0.27	48.60	89.62	-41.01	A	

Product Name	CD PLAYER/TUNER	Test Date	2017/09/22
Model	CD-400U	Test By	Ted Huang
Test Mode	DSSS TX (CH Low)	TEMP& Humidity	26.8 , 53%

Vertical

TX / DSSS mode / CH Low				Measurement Distance at 3m				Vertical polarity		
Freq.	Reading	AF	Cable Loss	Pre-amp	Filter	Level	Limit	Margin	Mark	
(MHz)	(dBμV)	(dB/m)	(dB)	(dB)	(dB)	(dBμV/m)	(dBμV/m)	(dB)	(P/Q/A)	
* 1329.23	62.65	25.92	1.99	44.62	0.44	46.38	74.00	-27.62	P	
* 1329.23	52.34	25.92	1.99	44.62	0.44	36.07	54.00	-17.93	A	
3103.13	69.29	30.32	3.19	44.17	0.66	59.29	81.10	-21.81	P	
3103.13	67.69	30.32	3.19	44.17	0.66	57.69	80.35	-22.66	A	
* 4803.72	58.95	33.79	4.06	43.87	0.22	53.16	74.00	-20.84	P	
* 4803.72	51.34	33.79	4.06	43.87	0.22	45.55	54.00	-8.45	A	
7205.48	57.06	38.72	5.08	42.87	0.27	58.26	81.10	-22.84	P	
7205.48	47.82	38.72	5.08	42.87	0.27	49.02	80.35	-31.33	A	

REMARK:

1. AF: Antenna Factor, Cable: Cable Loss, Pre-Amp: Preamplifier gain, Filter: 2.4GHz~2.5GHz Filter Insertion Loss
2. Spectrum analyzer setting P(Peak): RBW=1MHz, VBW=1MHz, A(Average): RBW=1MHz, VBW=10Hz
3. The result basic equation calculation is as follow:

$$\text{Level} = \text{Reading} + \text{AF} + \text{Cable} - \text{Preamp} + \text{Filter} - \text{Dist, Margin} = \text{Level-Limit}$$
4. The other emission levels were 20dB below the limit
5. The test limit distance is 3M limit.

Product Name	CD PLAYER/TUNER	Test Date	2017/09/22
Model	CD-400U	Test By	Ted Huang
Test Mode	DSSS TX (CH Middle)	TEMP& Humidity	26.8 , 53%

Horizontal

TX / DSSS mode / CH Middle				Measurement Distance at 3m				Horizontal polarity		
Freq.	Reading	AF	Cable Loss	Pre-amp	Filter	Level	Limit	Margin	Mark	
(MHz)	(dBμV)	(dB/m)	(dB)	(dB)	(dB)	(dBμV/m)	(dBμV/m)	(dB)	(P/Q/A)	
* 1173.65	59.82	25.29	1.85	44.44	0.42	42.95	74.00	-31.05	P	
* 1173.65	48.69	25.29	1.85	44.44	0.42	31.81	54.00	-22.19	A	
3103.17	61.83	30.32	3.19	44.17	0.66	51.83	89.09	-37.27	P	
3103.17	58.07	30.32	3.19	44.17	0.66	48.07	88.43	-40.36	A	
* 4883.65	58.02	34.08	4.11	43.91	0.23	52.53	74.00	-21.47	P	
* 4883.65	50.84	34.08	4.11	43.91	0.23	45.35	54.00	-8.65	A	
7325.52	56.83	39.20	5.13	42.91	0.27	58.52	89.09	-30.57	P	
* 7325.52	46.98	39.20	5.13	42.91	0.27	48.68	54.00	-5.32	A	

Product Name	CD PLAYER/TUNER	Test Date	2017/09/22
Model	CD-400U	Test By	Ted Huang
Test Mode	DSSS TX (CH Middle)	TEMP& Humidity	26.8 , 53%

Vertical

TX / DSSS mode / CH Middle				Measurement Distance at 3m				Vertical polarity		
Freq.	Reading	AF	Cable Loss	Pre-amp	Filter	Level	Limit	Margin	Mark	
(MHz)	(dBμV)	(dB/m)	(dB)	(dB)	(dB)	(dBμV/m)	(dBμV/m)	(dB)	(P/Q/A)	
* 1330.26	61.90	25.92	1.99	44.62	0.44	45.63	74.00	-28.37	P	
* 1330.26	51.55	25.92	1.99	44.62	0.44	35.29	54.00	-18.71	A	
3103.14	69.34	30.32	3.19	44.17	0.66	59.34	81.06	-21.71	P	
3103.14	68.13	30.32	3.19	44.17	0.66	58.13	80.41	-22.28	A	
* 4883.75	58.70	34.08	4.11	43.91	0.23	53.21	74.00	-20.79	P	
* 4883.75	51.37	34.08	4.11	43.91	0.23	45.88	54.00	-8.12	A	
* 7325.43	56.41	39.20	5.13	42.91	0.27	58.10	74.00	-15.90	P	
* 7325.43	47.07	39.20	5.13	42.91	0.27	48.77	54.00	-5.23	A	

REMARK:

1. AF: Antenna Factor, Cable: Cable Loss, Pre-Amp: Preamplifier gain, Filter: 2.4GHz~2.5GHz Filter Insertion Loss
2. Spectrum analyzer setting P(Peak): RBW=1MHz, VBW=1MHz, A(Average): RBW=1MHz, VBW=10Hz
3. The result basic equation calculation is as follow:
 $Level = Reading + AF + Cable - Preamp + Filter - Dist, Margin = Level - Limit$
4. The other emission levels were 20dB below the limit
5. The test limit distance is 3M limit.

Product Name	CD PLAYER/TUNER	Test Date	2017/09/22
Model	CD-400U	Test By	Ted Huang
Test Mode	DSSS TX (CH High)	TEMP& Humidity	26.8 , 53%

Horizontal

TX / DSSS mode / CH High				Measurement Distance at 3m				Horizontal polarity		
Freq.	Reading	AF	Cable Loss	Pre-amp	Filter	Level	Limit	Margin	Mark	
(MHz)	(dBμV)	(dB/m)	(dB)	(dB)	(dB)	(dBμV/m)	(dBμV/m)	(dB)	(P/Q/A)	
*	1175.25	60.65	25.30	1.85	44.44	0.42	43.79	74.00	-30.21	P
*	1175.25	49.29	25.30	1.85	44.44	0.42	32.42	54.00	-21.58	A
	3103.20	61.97	30.32	3.19	44.17	0.66	51.97	87.77	-35.80	P
	3103.20	58.33	30.32	3.19	44.17	0.66	48.33	87.12	-38.78	A
*	4959.85	59.60	34.36	4.16	43.95	0.24	54.40	74.00	-19.60	P
*	4959.85	52.81	34.36	4.16	43.95	0.24	47.60	54.00	-6.40	A
*	7439.48	56.68	39.66	5.18	42.94	0.27	58.85	74.00	-15.15	P
*	7439.48	47.17	39.66	5.18	42.94	0.27	49.34	54.00	-4.66	A

Product Name	CD PLAYER/TUNER	Test Date	2017/09/22
Model	CD-400U	Test By	Ted Huang
Test Mode	DSSS TX (CH High)	TEMP& Humidity	26.8 , 53%

Vertical

TX / DSSS mode / CH High				Measurement Distance at 3m				Vertical polarity		
Freq.	Reading	AF	Cable Loss	Pre-amp	Filter	Level	Limit	Margin	Mark	
(MHz)	(dBμV)	(dB/m)	(dB)	(dB)	(dB)	(dBμV/m)	(dBμV/m)	(dB)	(P/Q/A)	
*	1326.85	62.55	25.91	1.99	44.61	0.44	46.27	74.00	-27.73	P
*	1326.85	52.23	25.91	1.99	44.61	0.44	35.95	54.00	-18.05	A
	3103.15	69.07	30.32	3.19	44.17	0.66	59.07	80.69	-21.63	P
	3103.15	67.57	30.32	3.19	44.17	0.66	57.58	80.04	-22.46	A
*	4959.79	60.93	34.36	4.16	43.95	0.24	55.73	74.00	-18.27	P
*	4959.79	54.98	34.36	4.16	43.95	0.24	49.77	54.00	-4.23	A
*	7439.34	56.01	39.66	5.18	42.94	0.27	58.18	74.00	-15.82	P
*	7439.34	46.41	39.66	5.18	42.94	0.27	48.58	54.00	-5.42	A

REMARK:

1. AF: Antenna Factor, Cable: Cable Loss, Pre-Amp: Preamplifier gain, Filter: 2.4GHz~2.5GHz Filter Insertion Loss
2. Spectrum analyzer setting P(Peak): RBW=1MHz, VBW=1MHz, A(Average): RBW=1MHz, VBW=10Hz
3. The result basic equation calculation is as follow:
 $Level = Reading + AF + Cable - Preamp + Filter - Dist$, $Margin = Level - Limit$
4. The other emission levels were 20dB below the limit
5. The test limit distance is 3M limit.

Detector mode : Peak Polarity : Vertical

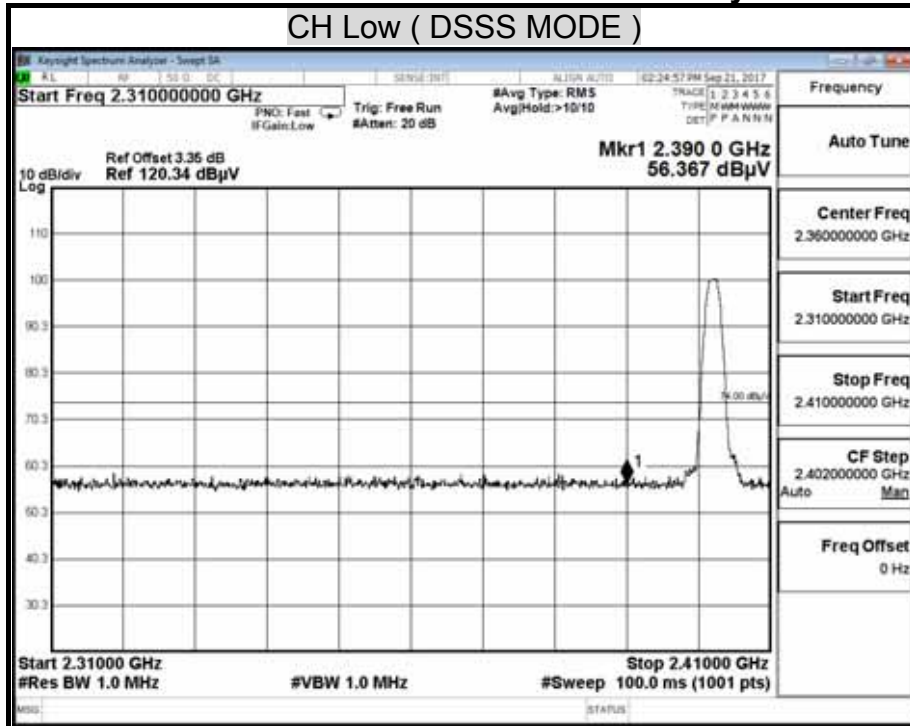

Detector mode : Average Polarity : Vertical

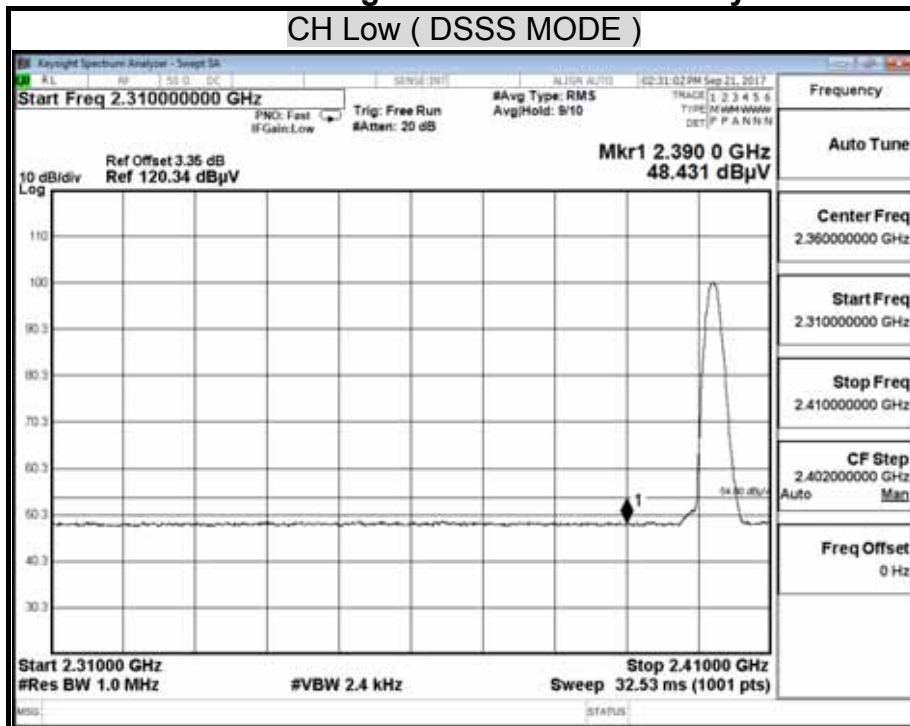

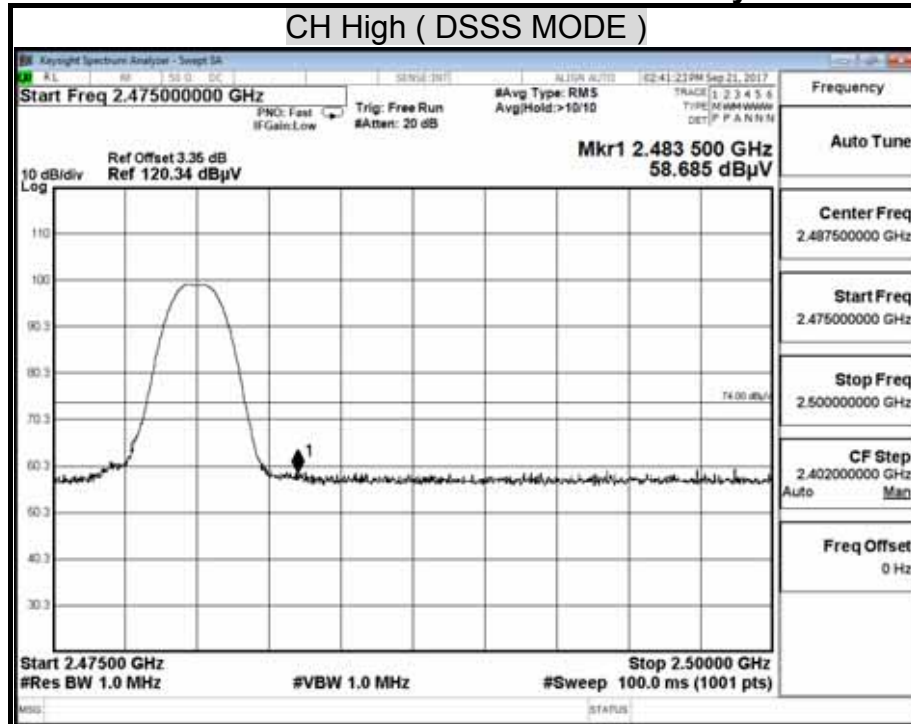
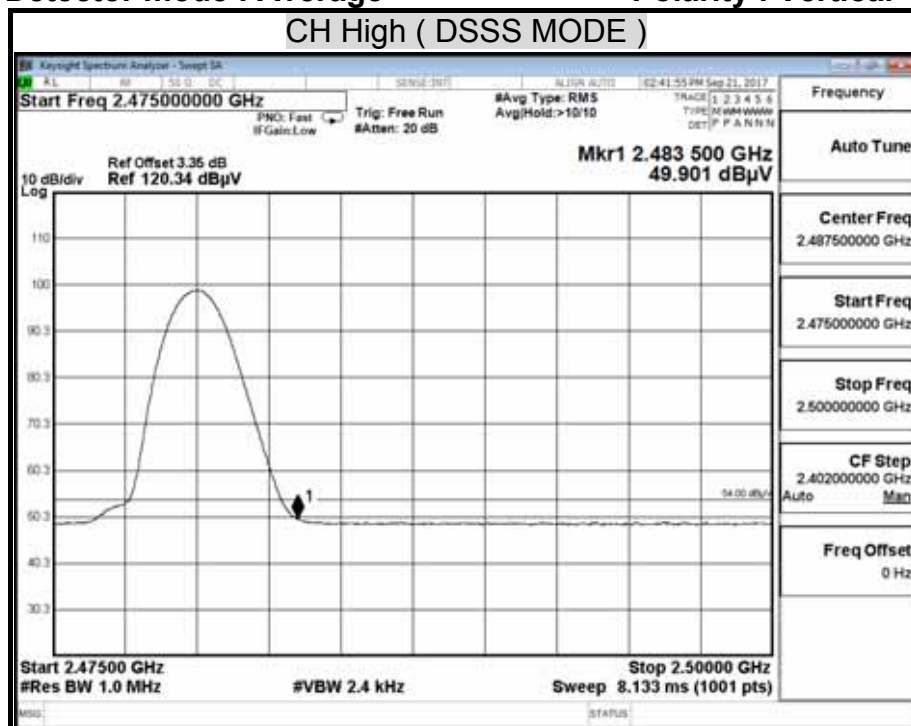
Detector mode : Peak
Polarity : Vertical

Detector mode : Average
Polarity : Vertical

8.8 POWERLINE CONDUCTED EMISSIONS

LIMITS

§ 15.207 (a) Except as shown in paragraph (b) and (c) this section, for an intentional radiator that is designed to be connected to the public utility (AC) power line, the radio frequency voltage that is conducted back onto the AC power line on any frequency or frequencies within the band 150 kHz to 30 MHz shall not exceed the limits in the following table, as measured using a 50 μ H/50 ohms line impedance stabilization network (LISN). Compliance with the provisions of this paragraph shall be based on the measurement of the radio frequency voltage between each power line and ground at the power terminal.

The lower limit applies at the boundary between the frequency ranges.

Frequency of Emission (MHz)	Conducted limit (dB μ v)	
	Quasi-peak	Average
0.15 - 0.5	66 to 56	56 to 46
0.5 - 5	56	46
5 - 30	60	50

TEST EQUIPMENTS

The following test equipments are used during the conducted power line tests :

Conducted Emission room #1				
Name of Equipment	Manufacturer	Model	Serial Number	Calibration Due
BNC Coaxial Cable	CCS	BNC50	11	01/12/2018
EMI Test Receiver	R&S	ESCS 30	100348	12/11/2017
LISN	SCHWARZBECK	NNLK8130	8130124	11/07/2018
LISN	FCC	FCC-LISN-50 -32-2	08009	05/07/2018
Pulse Limiter	R&S	ESH3-Z2	100116	01/12/2018
Software	e-3 (5.04211j)			

TEST SETUP

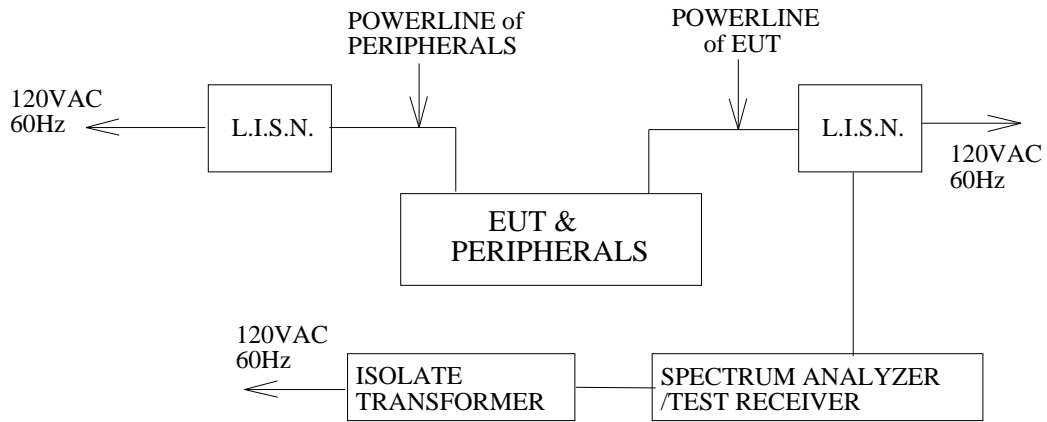

TEST PROCEDURE

The EUT is placed on a non-conducting table 40 cm from the vertical ground plane and 80cm above the horizontal ground plane. The EUT IS CONFIGURED IN ACCORDANCE WITH ANSI C63.10.

The resolution bandwidth is set to 9 kHz for both quasi-peak detection and average detection measurements.

Line conducted data is recorded for both NEUTRAL and LINE.

TEST RESULTS

No non-compliance noted.

Model No.	CD-400U	Test Mode	AM
Environmental Conditions	25 , 60% RH	Resolution Bandwidth	9 kHz
Tested by	Event Cheng		

LINE

(The chart below shows the highest readings taken from the final data.)

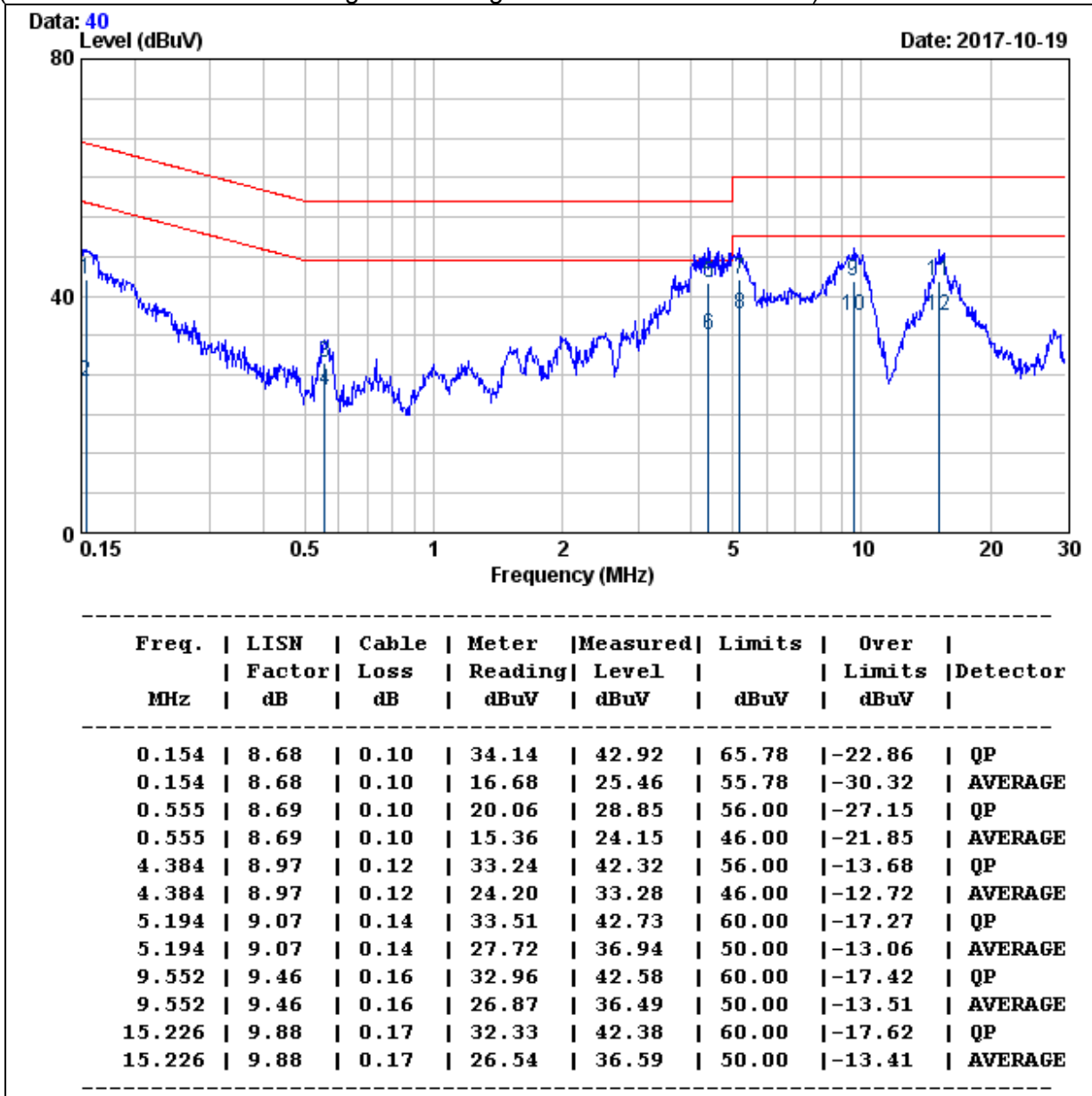

- REMARKS :
- Level (dBUV) = Read Level (dBUV) + LISN Factor (dB) + Cable Loss (dB)
 - Over Limit (dBUV) = Measured Level (dBUV) – Limits (dBUV)

Model No.	CD-400U	Test Mode	AM
Environmental Conditions	25 , 60% RH	Resolution Bandwidth	9 kHz
Tested by	Event Cheng		

NEUTRAL

(The chart below shows the highest readings taken from the final data.)

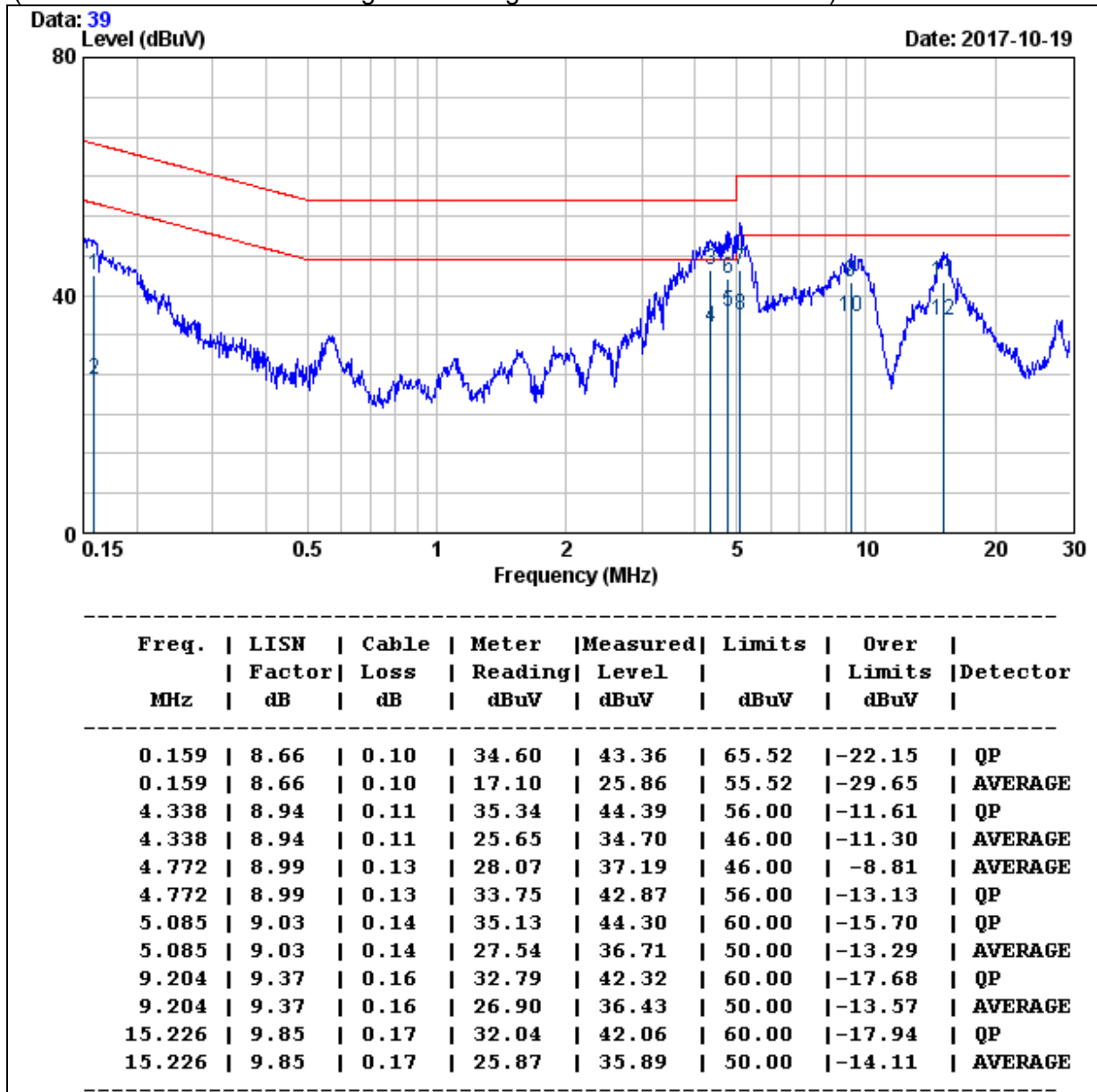

REMARKS : 1. Level (dBuV) = Read Level (dBuV) + LISN Factor (dB) + Cable Loss (dB)

2. Over Limit (dBuV) = Measured Level (dBuV) – Limits (dBuV)

Model No.	CD-400U	Test Mode	AUX
Environmental Conditions	25 , 60% RH	Resolution Bandwidth	9 kHz
Tested by	Event Cheng		

LINE

(The chart below shows the highest readings taken from the final data.)

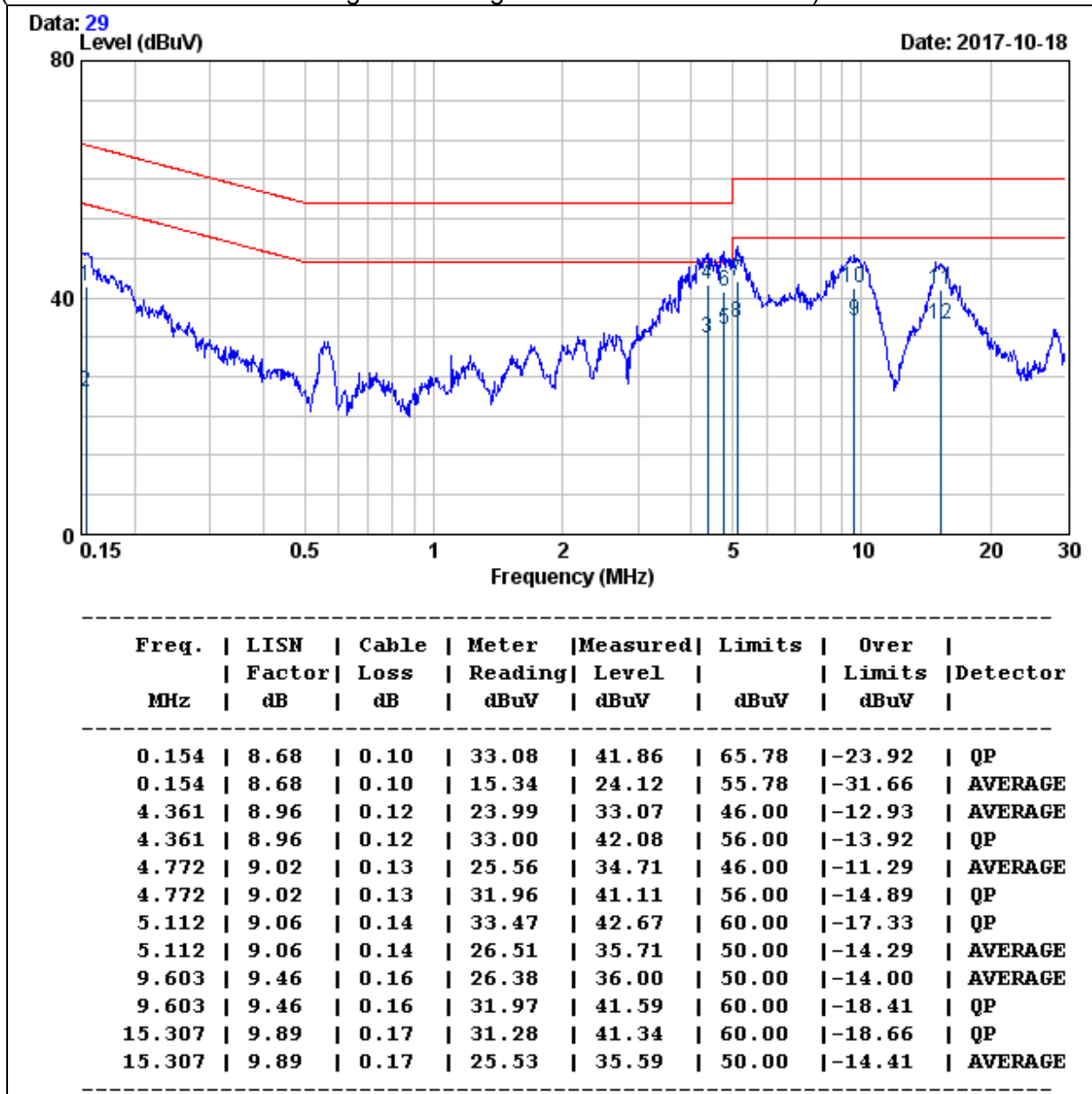

REMARKS : 1. Level (dBuV) = Read Level (dBuV) + LISN Factor (dB) + Cable Loss (dB)
 2. Over Limit (dBuV) = Measured Level (dBuV) – Limits (dBuV)

Model No.	CD-400U	Test Mode	AUX
Environmental Conditions	25 , 60% RH	Resolution Bandwidth	9 kHz
Tested by	Event Cheng		

NEUTRAL

(The chart below shows the highest readings taken from the final data.)

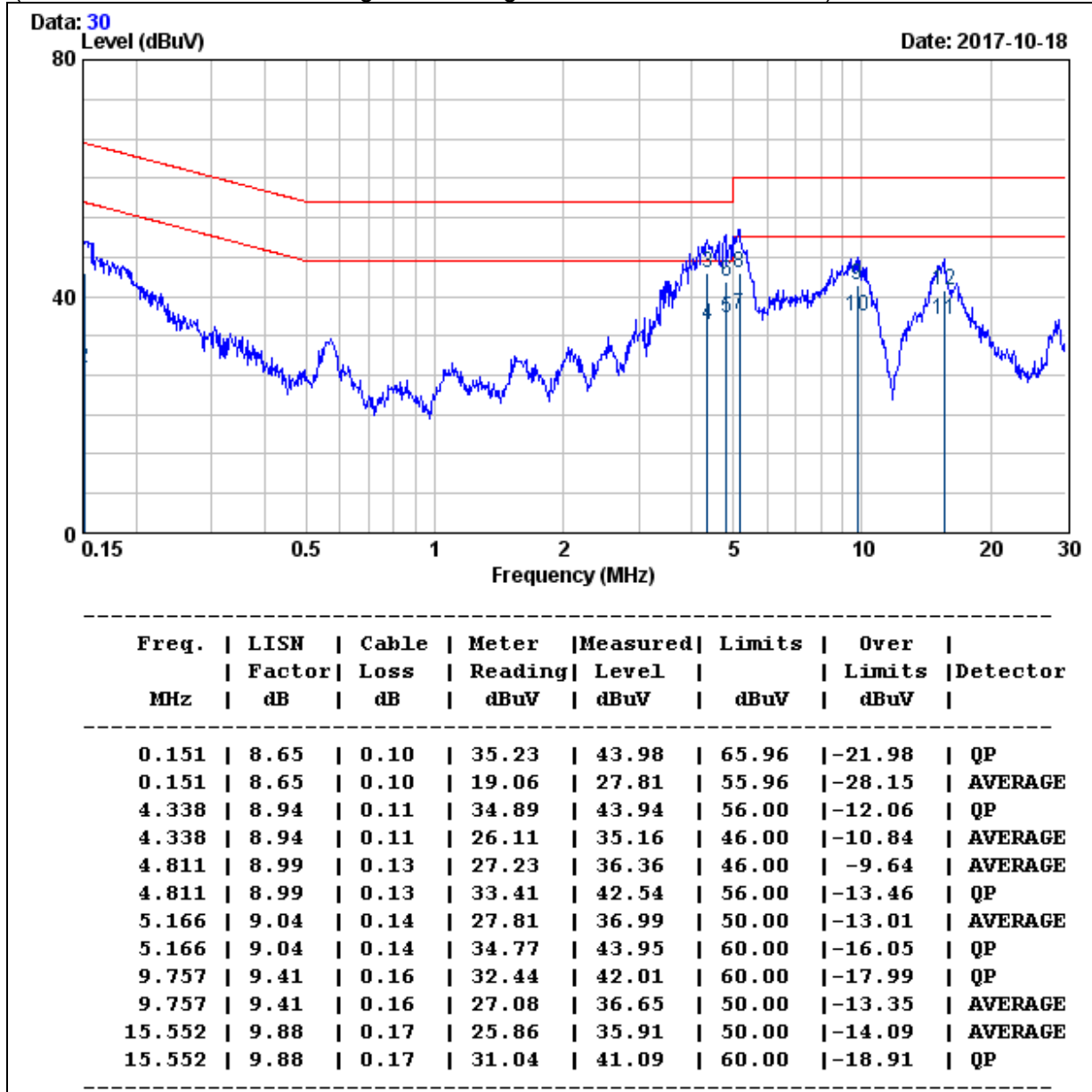

- REMARKS :
1. Level (dBuV) = Read Level (dBuV) + LISN Factor (dB) + Cable Loss (dB)
 2. Over Limit (dBuV) = Measured Level (dBuV) – Limits (dBuV)

Model No.	CD-400U	Test Mode	Bluetooth
Environmental Conditions	24 , 66% RH	Resolution Bandwidth	9 kHz
Tested by	Event Cheng		

LINE

(The chart below shows the highest readings taken from the final data.)

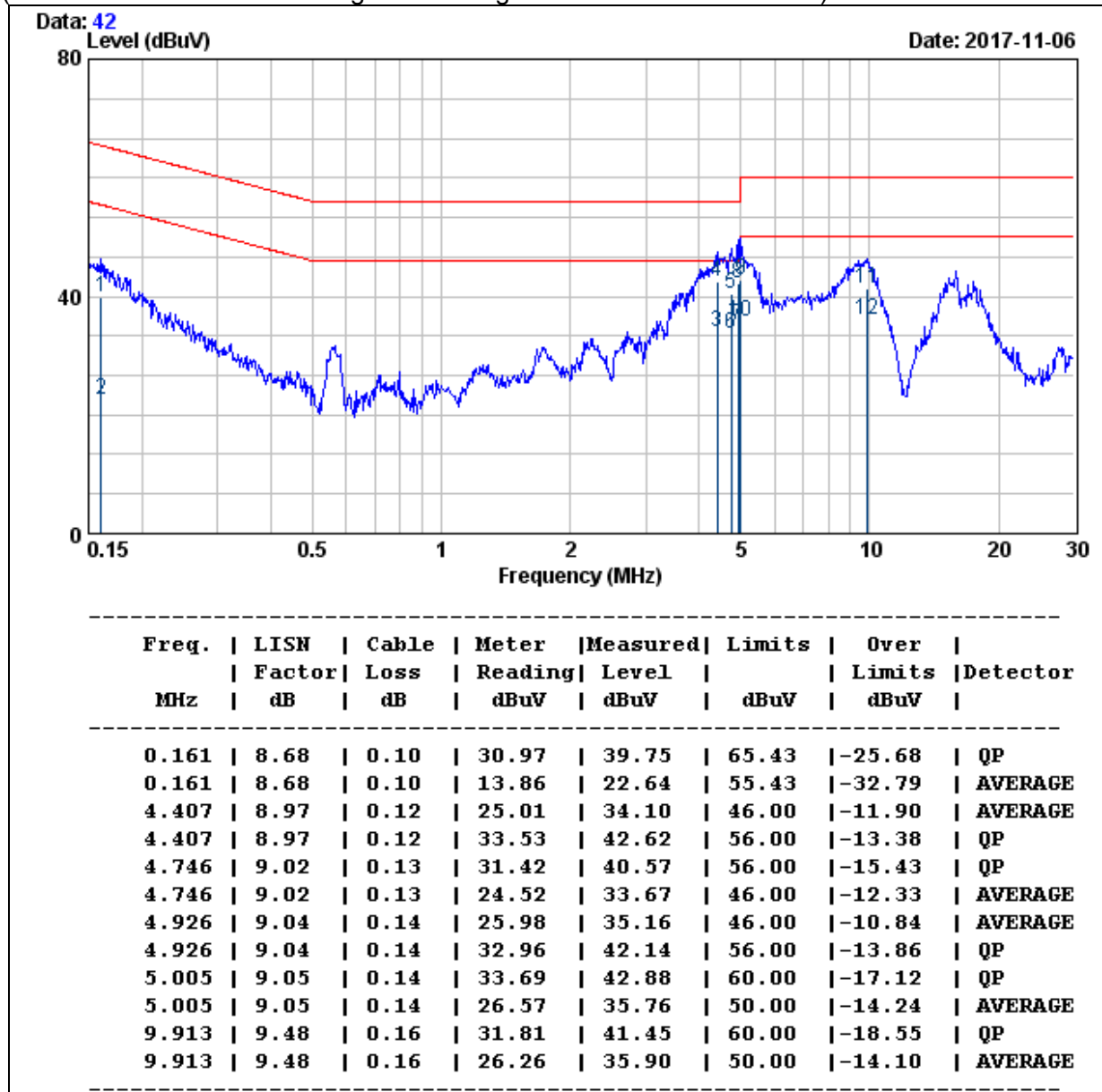

REMARKS : 1. Level (dBuV) = Read Level (dBuV) + LISN Factor (dB) + Cable Loss (dB)

2. Over Limit (dBuV) = Measured Level (dBuV) – Limits (dBuV)

Model No.	CD-400U	Test Mode	Bluetooth
Environmental Conditions	24 , 66% RH	Resolution Bandwidth	9 kHz
Tested by	Event Cheng		

NEUTRAL

(The chart below shows the highest readings taken from the final data.)

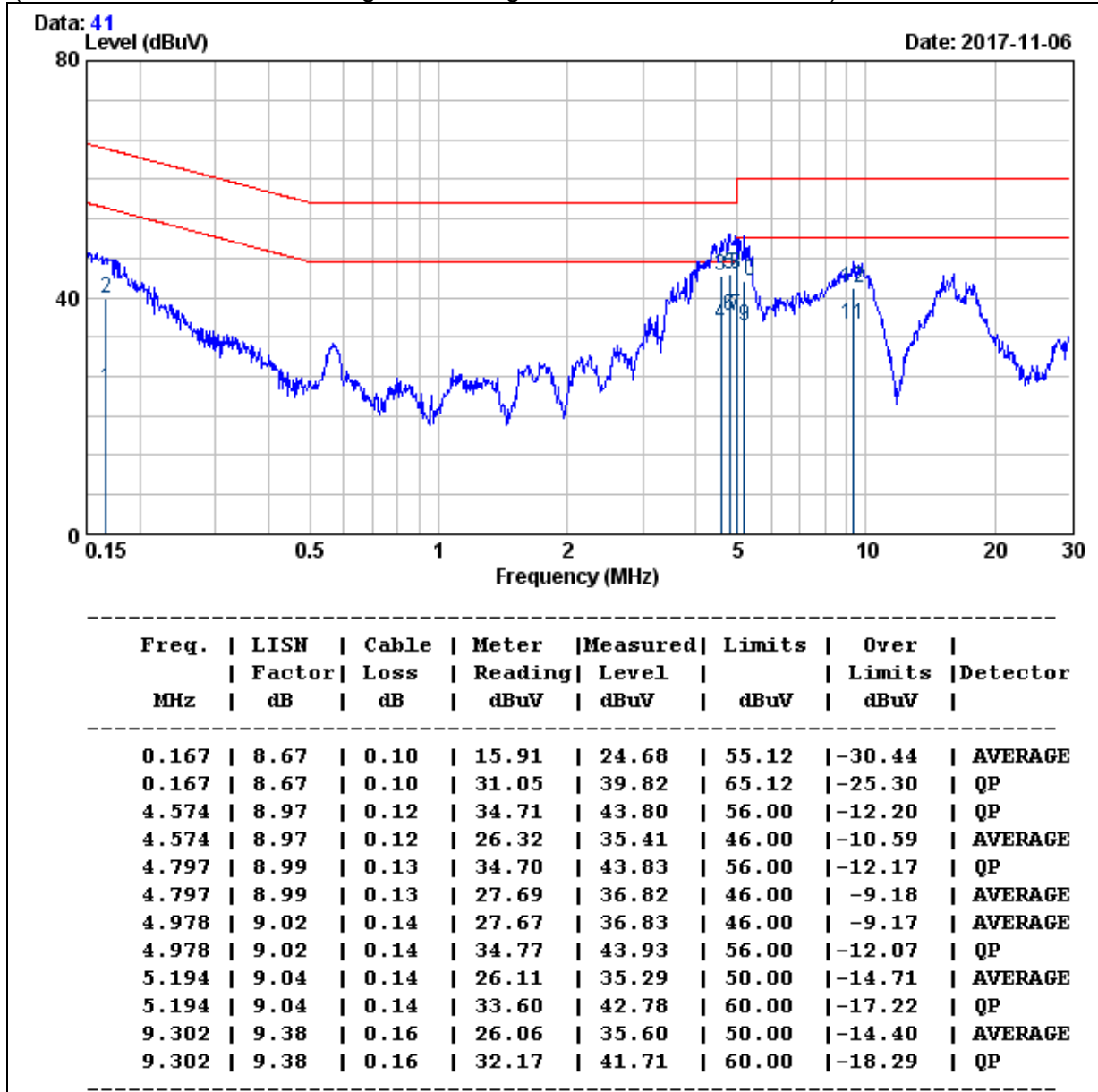

REMARKS : 1. Level (dBuV) = Read Level (dBuV) + LISN Factor (dB) + Cable Loss (dB)

2. Over Limit (dBuV) = Measured Level (dBuV) – Limits (dBuV)

Model No.	CD-400U	Test Mode	CD
Environmental Conditions	25 , 60% RH	Resolution Bandwidth	9 kHz
Tested by	Event Cheng		

LINE

(The chart below shows the highest readings taken from the final data.)

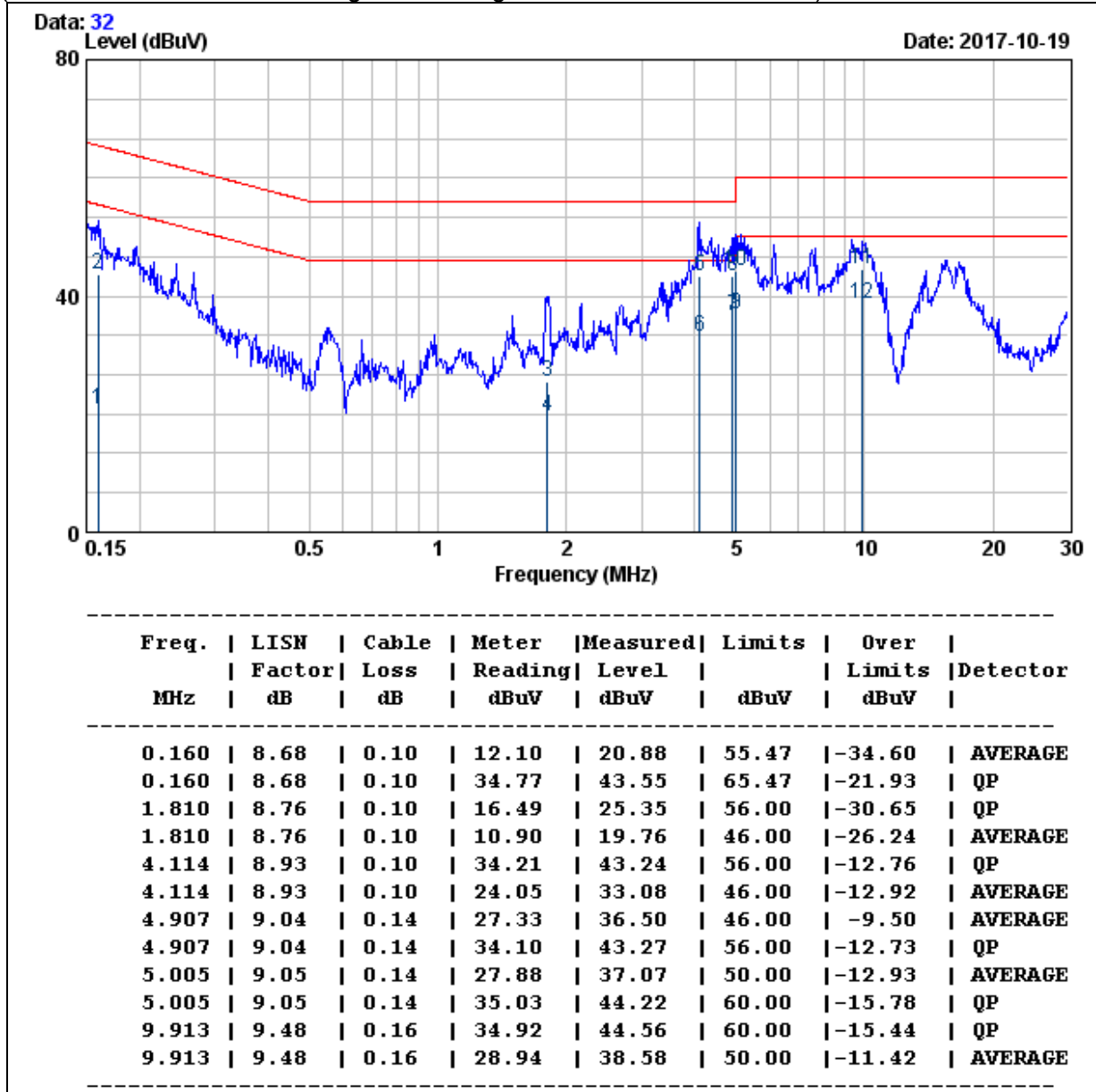

- REMARKS :
- Level (dBuV) = Read Level (dBuV) + LISN Factor (dB) + Cable Loss (dB)
 - Over Limit (dBuV) = Measured Level (dBuV) – Limits (dBuV)

Model No.	CD-400U	Test Mode	CD
Environmental Conditions	25 , 60% RH	Resolution Bandwidth	9 kHz
Tested by	Event Cheng		

NEUTRAL

(The chart below shows the highest readings taken from the final data.)

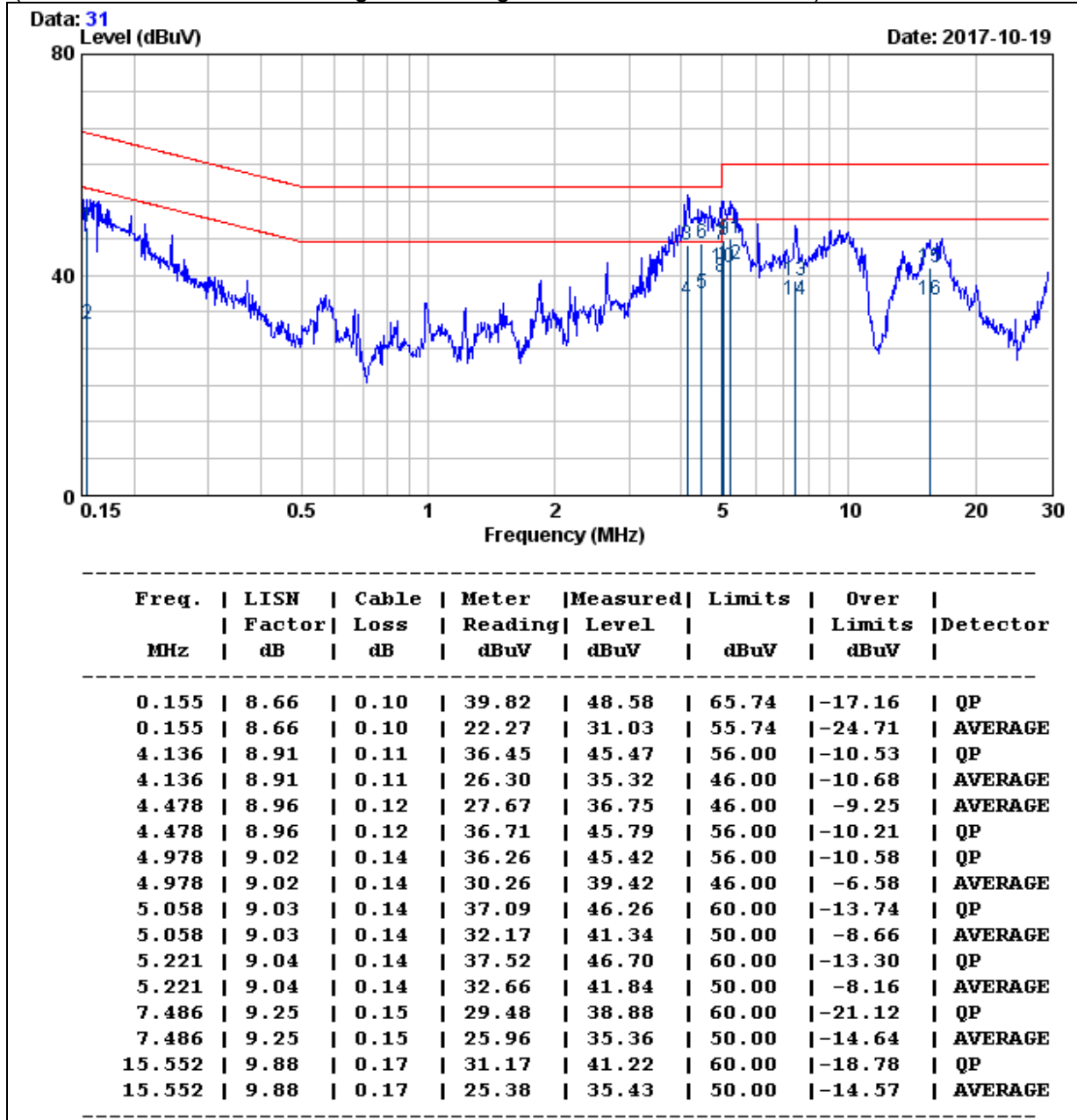

REMARKS : 1. Level (dBuV) = Read Level (dBuV) + LISN Factor (dB) + Cable Loss (dB)
 2. Over Limit (dBuV) = Measured Level (dBuV) – Limits (dBuV)

Model No.	CD-400U	Test Mode	FM
Environmental Conditions	25 , 60% RH	Resolution Bandwidth	9 kHz
Tested by	Event Cheng		

LINE

(The chart below shows the highest readings taken from the final data.)

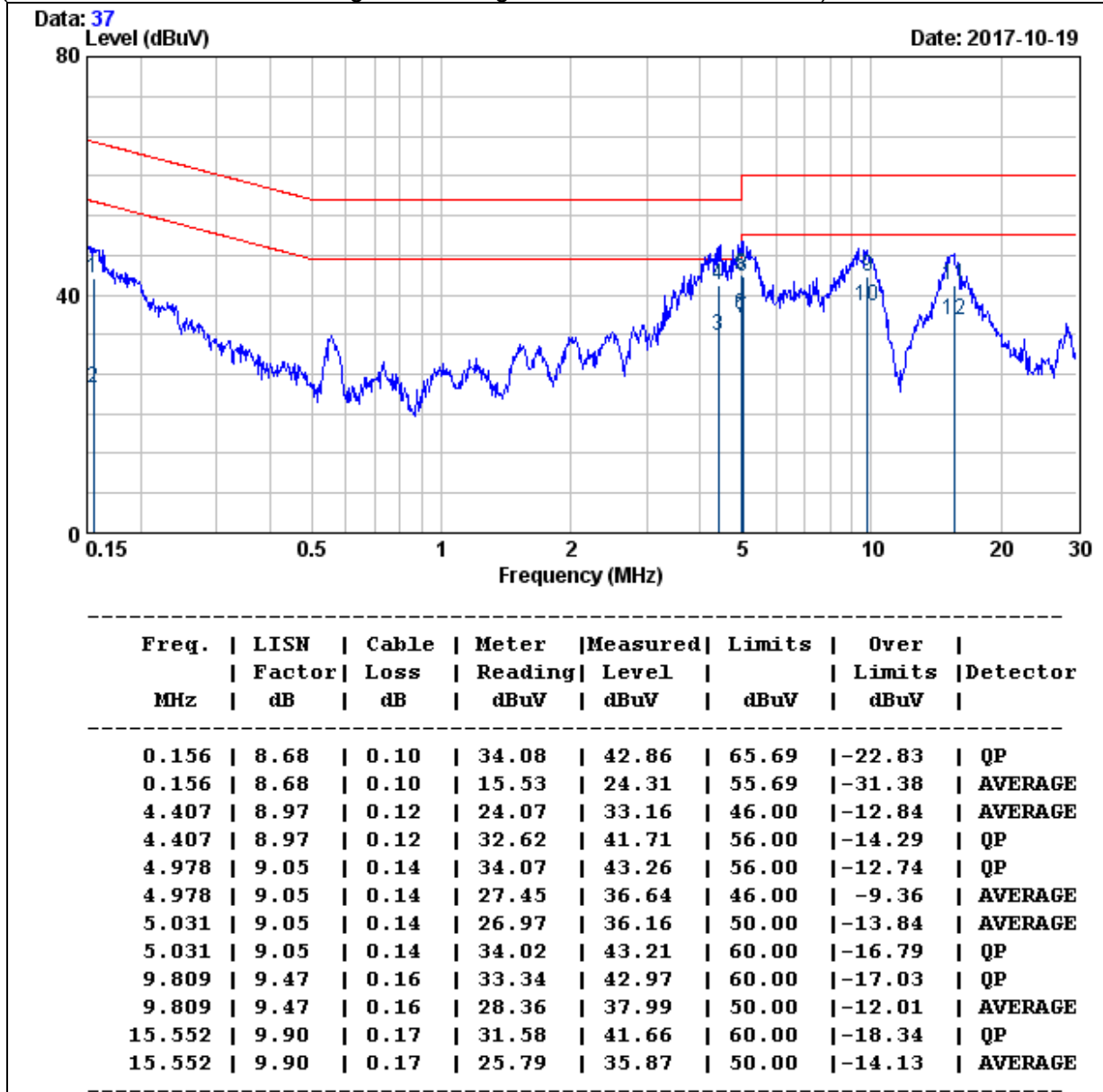

REMARKS : 1. Level (dBuV) = Read Level (dBuV) + LISN Factor (dB) + Cable Loss (dB)

2. Over Limit (dBuV) = Measured Level (dBuV) – Limits (dBuV)

Model No.	CD-400U	Test Mode	FM
Environmental Conditions	25 , 60% RH	Resolution Bandwidth	9 kHz
Tested by	Event Cheng		

NEUTRAL

(The chart below shows the highest readings taken from the final data.)

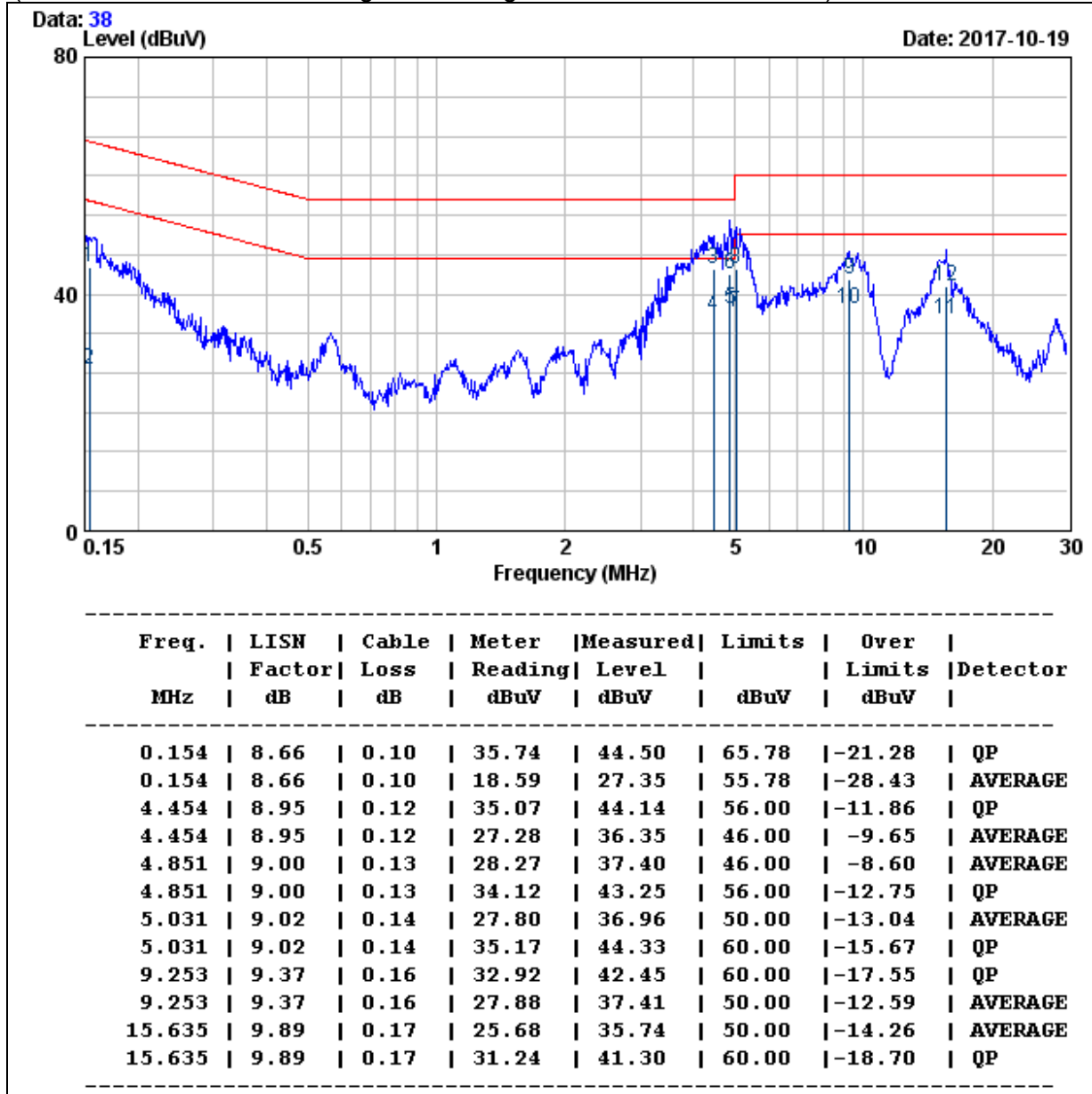

- REMARKS :
- Level (dBuV) = Read Level (dBuV) + LISN Factor (dB) + Cable Loss (dB)
 - Over Limit (dBuV) = Measured Level (dBuV) – Limits (dBuV)

Model No.	CD-400U	Test Mode	SD
Environmental Conditions	25 , 60% RH	Resolution Bandwidth	9 kHz
Tested by	Event Cheng		

LINE

(The chart below shows the highest readings taken from the final data.)

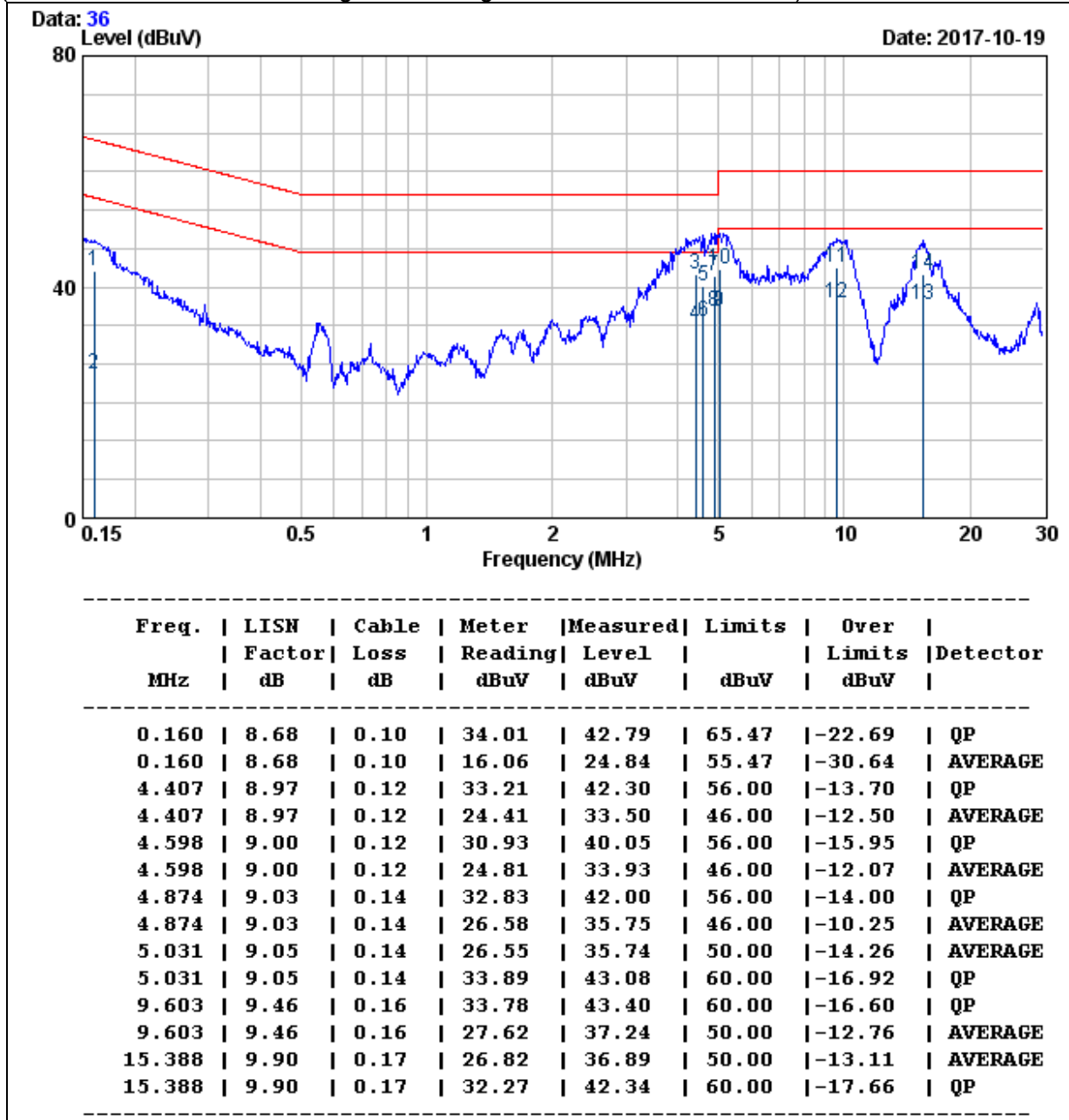

REMARKS : 1. Level (dBuV) = Read Level (dBuV) + LISN Factor (dB) + Cable Loss (dB)
 2. Over Limit (dBuV) = Measured Level (dBuV) – Limits (dBuV)

Model No.	CD-400U	Test Mode	SD
Environmental Conditions	25 , 60% RH	Resolution Bandwidth	9 kHz
Tested by	Event Cheng		

NEUTRAL

(The chart below shows the highest readings taken from the final data.)

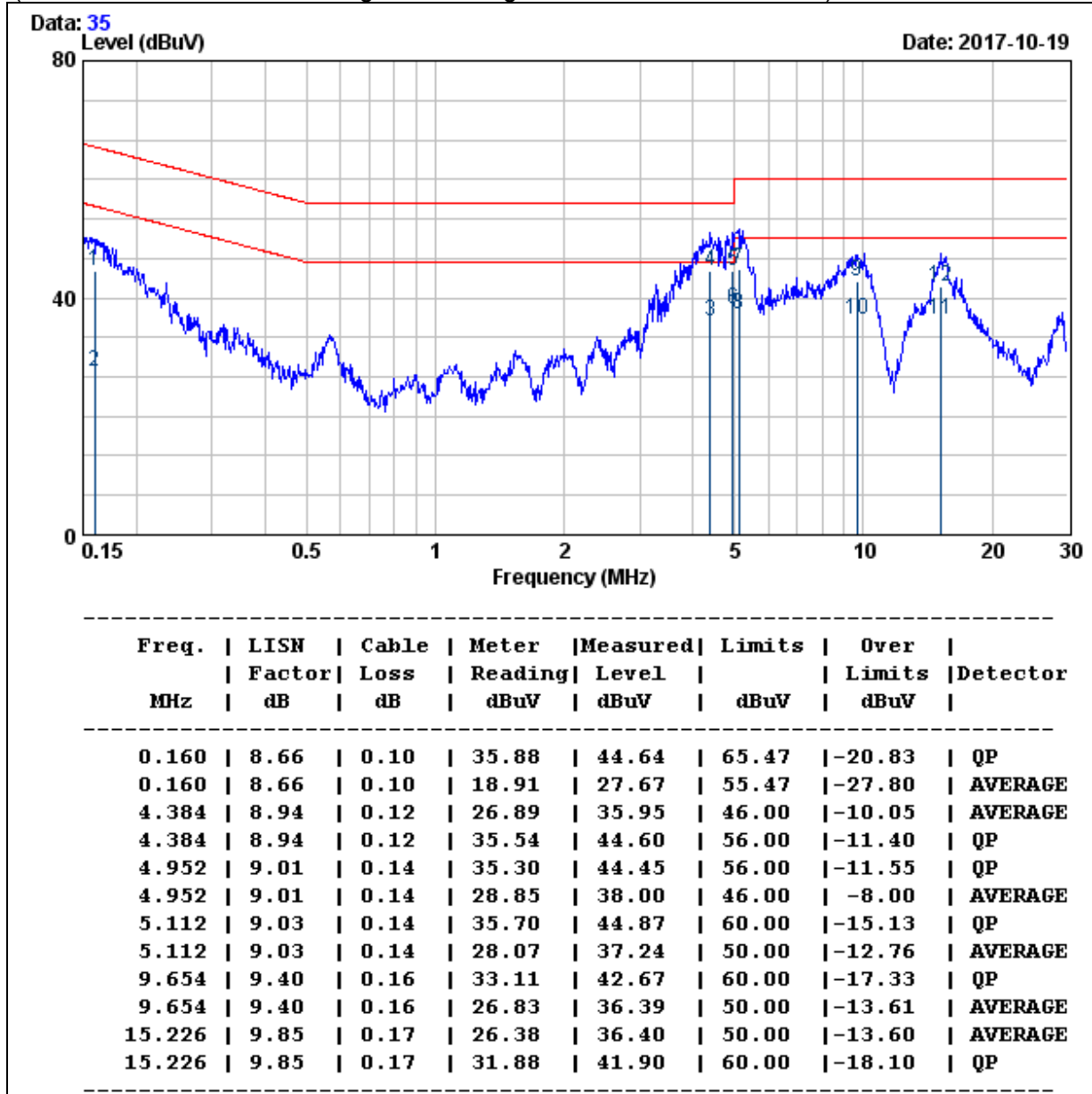

REMARKS : 1. Level (dBuV) = Read Level (dBuV) + LISN Factor (dB) + Cable Loss (dB)
 2. Over Limit (dBuV) = Measured Level (dBuV) – Limits (dBuV)

Model No.	CD-400U	Test Mode	USB
Environmental Conditions	25 , 60% RH	Resolution Bandwidth	9 kHz
Tested by	Event Cheng		

LINE

(The chart below shows the highest readings taken from the final data.)

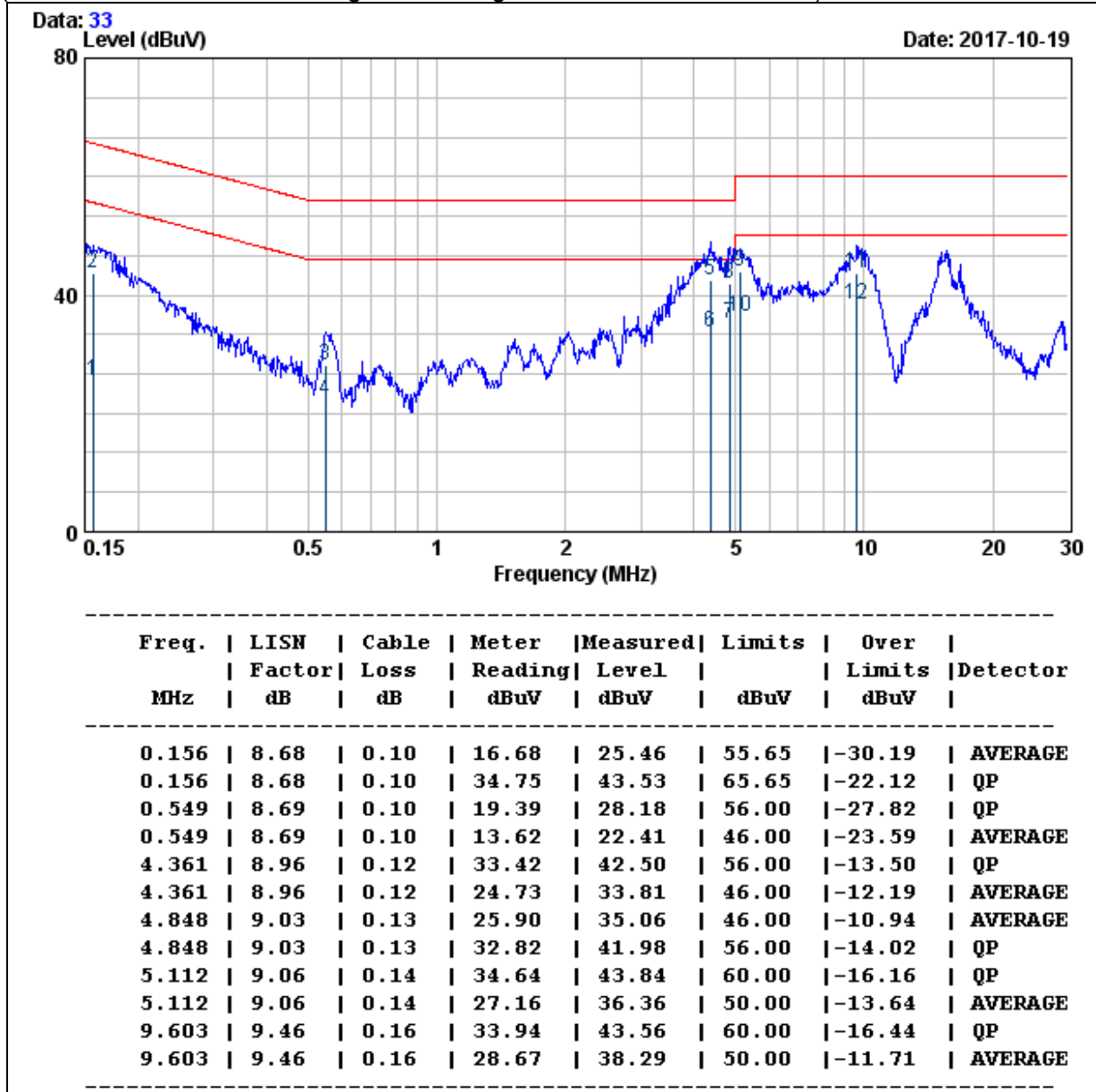

- REMARKS :
1. Level (dBuV) = Read Level (dBuV) + LISN Factor (dB) + Cable Loss (dB)
 2. Over Limit (dBuV) = Measured Level (dBuV) – Limits (dBuV)

Model No.	CD-400U	Test Mode	USB
Environmental Conditions	25 , 60% RH	Resolution Bandwidth	9 kHz
Tested by	Event Cheng		

NEUTRAL

(The chart below shows the highest readings taken from the final data.)

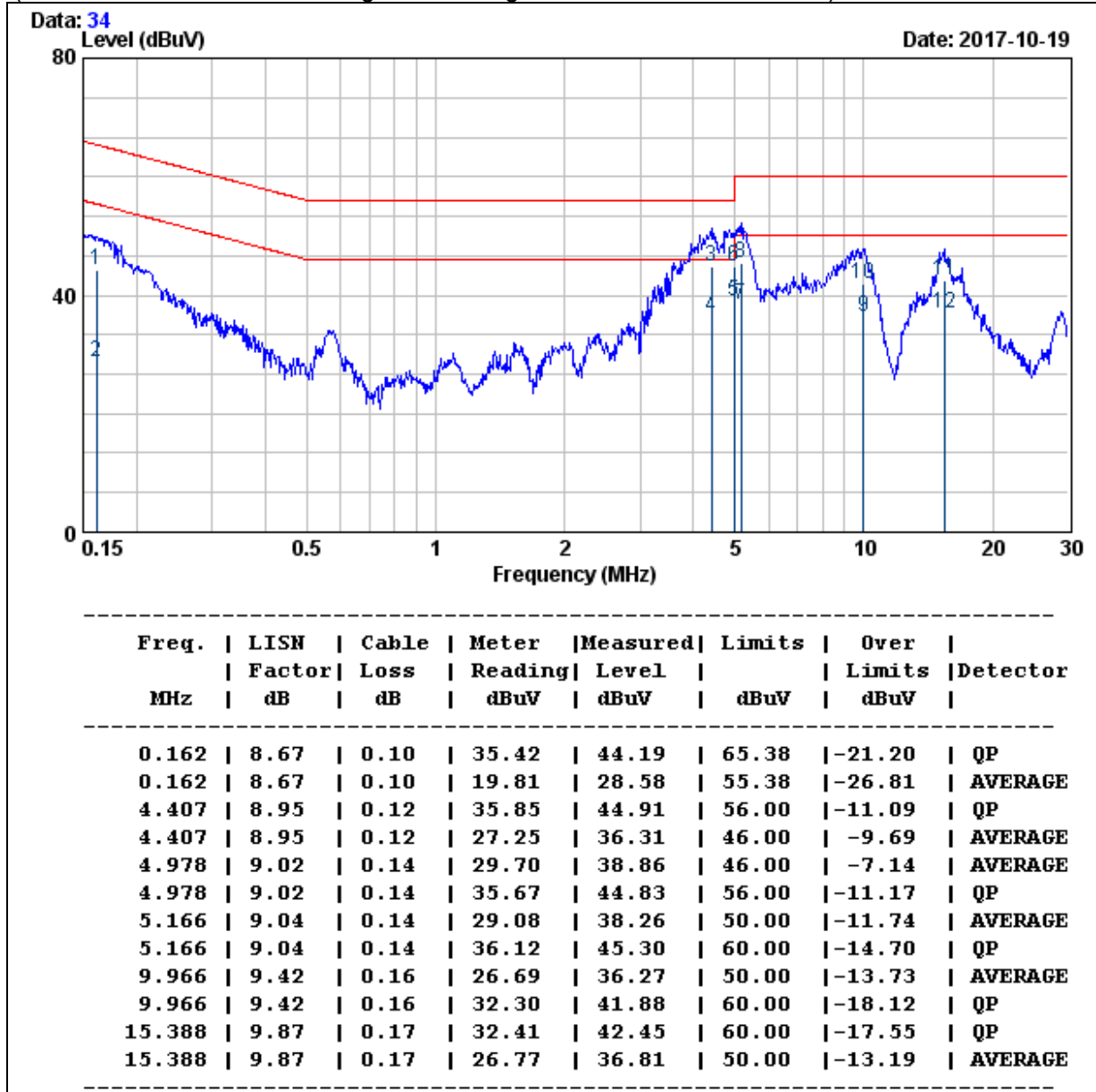

REMARKS : 1. Level (dBuV) = Read Level (dBuV) + LISN Factor (dB) + Cable Loss (dB)

2. Over Limit (dBuV) = Measured Level (dBuV) – Limits (dBuV)

9. ANTENNA REQUIREMENT

9.1 STANDARD APPLICABLE

For intentional device, according to FCC 47 CFR Section 15.203, an intentional radiator shall be designed to ensure that no antenna other than that furnished by the responsible party shall be used with the device.

And according to FCC 47 CFR Section 15.247 (b), if transmitting antennas of directional gain greater than 6dBi are used, the power shall be reduced by the amount in dB that the directional gain of the antenna exceeds 6dBi.

9.2 ANTENNA CONNECTED CONSTRUCTION

Manufacturer: BRITO TECHNOLOGY
Type: Dipole antenna
Model: WF-EM-1708-0131-B
Gain: 2.0dBi