

TEAC

AI-303

USB DAC AMPLIFIER

ENGLISH

FRANÇAIS

ESPAÑOL

OWNER'S MANUAL

MODE D'EMPLOI

MANUAL DEL USUARIO

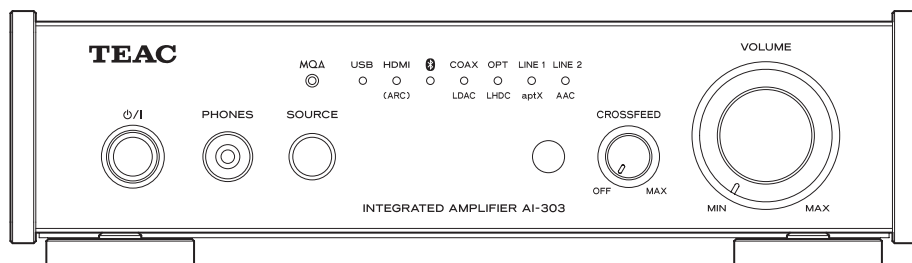

DSD
Direct Stream Digital

MQA

HDMI
HIGH-DEFINITION MULTIMEDIA INTERFACE

Bluetooth

LDAC

LHDC

Qualcomm
aptX™ HD

IMPORTANT SAFETY INSTRUCTIONS



CAUTION: TO REDUCE THE RISK OF ELECTRIC SHOCK, DO NOT REMOVE COVER (OR BACK). NO USER-SERVICEABLE PARTS INSIDE. REFER SERVICING TO QUALIFIED SERVICE PERSONNEL.



The lightning flash with arrowhead symbol, within an equilateral triangle, is intended to alert the user to the presence of un-insulated "dangerous voltage" within the product's enclosure that may be of sufficient magnitude to constitute a risk of electric shock to persons.



The exclamation point within an equilateral triangle is intended to alert the user to the presence of important operating and maintenance (servicing) instructions in the literature accompanying the appliance.

WARNING: TO PREVENT FIRE OR SHOCK HAZARD, DO NOT EXPOSE THIS APPLIANCE TO RAIN OR MOISTURE.

CAUTION

- DO NOT REMOVE THE EXTERNAL CASES OR CABINETS TO EXPOSE THE ELECTRONICS. NO USER SERVICEABLE PARTS ARE INSIDE.
- IF YOU ARE EXPERIENCING PROBLEMS WITH THIS PRODUCT, CONTACT THE STORE WHERE YOU PURCHASED THE UNIT FOR A SERVICE REFERRAL. DO NOT USE THE PRODUCT UNTIL IT HAS BEEN REPAIRED.
- USE OF CONTROLS OR ADJUSTMENTS OR PERFORMANCE OF PROCEDURES OTHER THAN THOSE SPECIFIED HEREIN MAY RESULT IN HAZARDOUS RADIATION EXPOSURE.

IN USA/CANADA, USE ONLY ON 120V SUPPLY.

- 1) Read these instructions.
- 2) Keep these instructions.
- 3) Heed all warnings.
- 4) Follow all instructions.
- 5) Do not use this apparatus near water.
- 6) Clean only with dry cloth.

- 7) Do not block any ventilation openings. Install in accordance with the manufacturer's instructions.
- 8) Do not install near any heat sources such as radiators, heat registers, stoves, or other apparatus (including amplifiers) that produce heat.
- 9) Do not defeat the safety purpose of the polarized or grounding-type plug. A polarized plug has two blades with one wider than the other. A grounding type plug has two blades and a third grounding prong. The wide blade or the third prong are provided for your safety. If the provided plug does not fit into your outlet, consult an electrician for replacement of the obsolete outlet.
- 10) Protect the power cord from being walked on or pinched particularly at plugs, convenience receptacles, and the point where they exit from the apparatus.
- 11) Only use attachments/accessories specified by the manufacturer.
- 12) Use only with the cart, stand, tripod, bracket, or table specified by the manufacturer, or sold with the apparatus. When a cart is used, use caution when moving the cart/apparatus combination to avoid injury from tip-over.
- 13) Unplug this apparatus during lightning storms or when unused for long periods of time.
- 14) Refer all servicing to qualified service personnel. Servicing is required when the apparatus has been damaged in any way, such as power-supply cord or plug is damaged, liquid has been spilled or objects have fallen into the apparatus, the apparatus has been exposed to rain or moisture, does not operate normally, or has been dropped.
- The apparatus draws nominal non-operating power from the AC outlet with its POWER or STANDBY/ON switch not in the ON position.
- The mains plug is used as the disconnect device, the disconnect device shall remain readily operable.
- Caution should be taken when using earphones or headphones with the product because excessive sound pressure (volume) from earphones or headphones can cause hearing loss.



WARNING

Products with Class I construction are equipped with a power supply cord that has a grounding plug. The cord of such a product must be plugged into an AC outlet that has a protective grounding connection.

CAUTION

- Do not expose this apparatus to drips or splashes.
- Do not place any objects filled with liquids, such as vases, on the apparatus.
- Do not install this apparatus in a confined space such as a book case or similar unit.
- The apparatus should be located close enough to the AC outlet so that you can easily reach the power cord plug at any time.
- If the product uses batteries (including a battery pack or installed batteries), they should not be exposed to sunshine, fire or excessive heat.
- CAUTION for products that use replaceable lithium batteries: there is danger of explosion if a battery is replaced with an incorrect type of battery. Replace only with the same or equivalent type.



Precautions concerning batteries

Misuse of batteries could cause them to rupture or leak leading to fire, injury or the staining of nearby things. Please read and observe the following precautions carefully.

- Be sure to insert the batteries with correct positive (+) and negative (-) orientations.
- Use batteries of the same type. Never use different types of batteries together.
- If the remote control is not used for a long time (more than a month), remove the batteries to prevent them from leaking.
- If the batteries leak, wipe away the leakage inside the battery compartment and replace the batteries with new ones.
- Do not use batteries of types other than those specified. Do not mix new batteries with old ones or use different types of batteries together.
- Do not heat or disassemble batteries. Never throw batteries into fire or water.
- Do not carry or store batteries with other metallic objects. The batteries could short circuit, leak or explode.
- Never recharge a battery unless it is confirmed to be a rechargeable type.
- Do not expose batteries to extremely low air pressure as it could result in an explosion or leakage of flammable liquids or gases.

Declaration of Conformity



Model number: AI-303

Trade name: TEAC

Responsible party: 11 Trading Company, LLC

Address: 3502 Woodview Trace #200 Indianapolis, IN 46268 U.S.A.

URL: <https://11tradingcompany.com/contact-us/>

This device complies with Part.15 of FCC Rules.

Operation is subject to the following two conditions:

- 1) This device may not cause harmful interference
- 2) This device must accept any interference received, including interference that may cause undesired operation.

Information

This equipment has been tested and found to comply with the limits for a Class B digital device, pursuant to Part 15 of the FCC Rules. These limits are designed to provide reasonable protection against harmful interference in a residential installation. This equipment generates, uses, and can radiate radio frequency energy and, if not installed and used in accordance with the instructions, may cause harmful interference to radio communications. However, there is no guarantee that interference will not occur in a particular installation. If this equipment does cause harmful interference to radio or television reception, which can be determined by turning the equipment off and on, the user is encouraged to try to correct the interference by one or more of the following measures:

- Reorient or relocate the equipment and/or the receiving antenna.
- Increase the separation between the equipment and receiver.
- Connect the equipment into an outlet on a circuit different from that to which the receiver is connected.
- Consult the dealer or an experienced radio/TV technician for help.

CAUTION

Changes or modifications not expressly approved by the party responsible for compliance could void the user's authority to operate the equipment.

IMPORTANT SAFETY INSTRUCTIONS (continued)

Model for Canada

Innovation, Science and Economic Development
Canada's Compliance Statement:
This Class B digital apparatus complies with Canadian
ICES-003.

For European Customers

Disposal of electrical and electronic equipment and batteries and/or accumulators

- All electrical/electronic equipment and waste batteries/accumulators should be disposed of separately from the municipal waste stream via collection facilities designated by the government or local authorities.
- By disposing of electrical/electronic equipment and waste batteries/accumulators correctly, you will help save valuable resources and prevent any potential negative effects on human health and the environment.
- Improper disposal of waste electrical/electronic equipment and batteries/accumulators can have serious effects on the environment and human health because of the presence of hazardous substances in the equipment.
- The Waste Electrical and Electronic Equipment (WEEE) symbols, which show wheeled bins that have been crossed out, indicate that electrical/electronic equipment and batteries/accumulators must be collected and disposed of separately from household waste.

If a battery or accumulator contains more than the specified values of lead (Pb), mercury (Hg), and/or cadmium (Cd) as defined in the Battery Directive (2006/66/EC, 2013/56/EU), then the chemical symbols for those elements will be indicated beneath the WEEE symbol.

- Return and collection systems are available to end users. For more detailed information about the disposal of old electrical/electronic equipment and waste batteries/accumulators, please contact your city office, waste disposal service or the shop where you purchased the equipment.

The nameplate is located on the bottom of the unit as shown below.

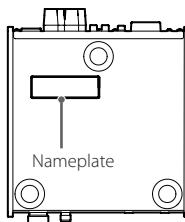

MQA and the Sound Wave Device are registered trademarks of MQA Limited © 2016

"DSD" is a registered trademark.

The Bluetooth® word mark and logos are registered trademarks owned by Bluetooth SIG, Inc. and any use of such marks by TEAC CORPORATION is under license.

Qualcomm aptX is a product of Qualcomm Technologies, Inc. and/or its subsidiaries.

Qualcomm is a trademark of Qualcomm Incorporated, registered in the United States and other countries. aptX is a trademark of Qualcomm Technologies International, Ltd., registered in the United States and other countries.

The LHDC logo is a registered trademark of Savitech Corporation.

Apple, Mac, OS X and macOS are trademarks of Apple Inc., registered in the U.S. and other countries.

Microsoft and Windows are either registered trademarks or trademarks of Microsoft Corporation in the United States and/or other countries.

Bulk Pet is a registered trademark of INTERFACE CO., LTD.

LDAC™ and LDAC logo are trademarks of Sony Corporation.

The terms HDMI and HDMI High-Definition Multimedia Interface, and the HDMI Logo are trademarks or registered trademarks of HDMI Licensing Administrator, Inc. in the United States and other countries.

Other company names, product names and logos in this document are the trademarks or registered trademarks of their respective owners.

Compliance of radio transmitter and interference

This product has the function of broadband transmitter using 2.4GHz Band.

Use frequency range: 2402 MHz – 2480 MHz

Maximum output power: Bluetooth® Class 2 (less than 2.5 mW)

Please use only in the country where you purchased the product.

Depending on the country, restrictions on the use of Bluetooth wireless technology might exist.

Model for USA

Labeling of authorization
FCC ID: XEG-AI303

Model for Canada

Compliance of radio transmitter

This device contains licence-exempt transmitter(s)/receiver(s) that comply with Innovation, Science and Economic Development Canada's licence-exempt RSS(s). Operation is subject to the following two conditions:

- 1) This device may not cause interference.
- 2) This device must accept any interference, including interference that may cause undesired operation of the device.

Labeling of authorization
IC: 1559C-AI303

Model for EEA (European Economic Area)



Hereby, TEAC Corporation declares that the radio equipment type is in compliance with Directive 2014/53/EU, and the other Directives, and Commission Regulations.

Model for UK

Hereby, TEAC CORPORATION declares that the radio equipment type is in compliance with UK Radio Equipment Regulations.



The full text of the EU and UK declaration of conformity is available at the following internet address. Please contact us by e-mail.

<https://teacsupport.aqjpa.com/>

Radiation Exposure requirements

This equipment meets the regulation, which is recognized internationally, for the case of human exposure to radio waves generated by the transmitter.

Statement of compliance

Model for USA/Canada

This equipment complies with FCC/IC radiation exposure limits set forth for an uncontrolled environment and meets the FCC radio frequency (RF) Exposure Guidelines and RSS-102 of the IC radio frequency (RF) Exposure rules. This equipment has very low levels of RF energy that it deemed to comply without maximum permissive exposure evaluation (MPE). But it is desirable that it should be installed and operated keeping the radiator at least 20 cm or more away from person's body (excluding extremities: hands, wrists, feet and ankles).

Model for EEA and UK

This equipment complies with EN.62479; Assessment of electronic and electrical equipment related to human exposure restrictions for electromagnetic fields.

Table of contents

Thank you for choosing TEAC.

Read this manual carefully to get the best performance from this unit.

After reading it, keep it in a safe place for future reference.

IMPORTANT SAFETY INSTRUCTIONS	2
Table of contents	6
Included accessories	6
Using the TEAC International Site	6
Before use	7
Using the remote control	7
Connections	8
Connecting speakers	10
Main unit parts and functions	11
Remote control parts and functions	12
Basic operation	13
MQA (Master Quality Authenticated)	14
Crossfeed function	14
HDMI (eARC)	14
Bluetooth® wireless technology	15
Energy-saving functions	18
Playing back music on a computer	19
Playback operations	21
Troubleshooting	23
Specifications	25

Included accessories

Check to be sure the box includes all the supplied accessories shown below.

Please contact the store where you purchased this unit if any of these accessories are missing or have been damaged during transportation.

Power cord × 1

Foot pads × 3

Remote control (RC-1337) × 1

Batteries for remote control (AAA) × 2

Owner's manual (this document, including warranty) × 1

- For information about the warranty, see pages 26–27.

Using the TEAC International Site

You can download updates for this unit from the TEAC International Site:

<https://teac.jp/int/>

Click Language at the top right of the page and select the desired country or region to access a page in the corresponding language.

Before use

Placement precautions

- Do not install this unit in a location that could become hot. This includes places that are exposed to direct sunlight or near a radiator, heater, stove or other heating equipment. Moreover, do not place it on top of an amplifier or other equipment that generates heat. Doing so could cause discoloration, deformation or malfunction.
- You may stack this unit with a PD-301 or UD-301. However, place this unit on top in order to improve heat dissipation.
- When installing this unit, leave a little space (at least 5 cm or 2") between it and walls and other devices in order to allow good heat dissipation. If you put it in a rack, for example, leave at least 5 cm (2") open above and 10 cm (4") open behind it. Failure to provide these gaps could cause heat to build up inside and result in fire.

Maintenance

Wipe dirt from the top cover and other panel surfaces using a soft cloth that has been slightly dampened with a diluted neutral cleanser.

Do not wipe with chemical cleaning cloths, thinner or other chemical agents. Doing so could damage the surface.

-  **For your safety, disconnect the power cord from the outlet before cleaning.**

Using the remote control

Precautions for use

-  **Misuse of batteries could cause them to rupture or leak, which might result in fire, injury or the staining of nearby materials. Please carefully read and observe the precautions on page 3.**

- When using the remote control, point it toward the remote control signal receiver on the main unit from a distance of 5 m (16 ft) or less. Do not place obstructions between the main unit and the remote control.
- When not using the remote control for an extended period of time, remove the batteries to prevent leakage.

Installing batteries

Remove the cover from the back of the remote control and insert two AAA batteries with their \oplus/\ominus oriented as shown in the case. Replace the cover.

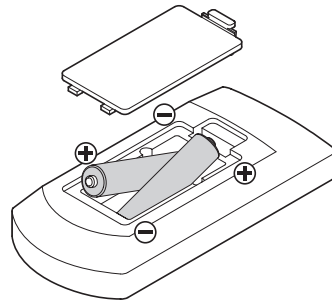

When to replace batteries

If the distance required between the remote and the main unit decreases or if the unit stops responding to the remote buttons, replace both batteries with new ones.

Dispose of the used batteries according to the instructions on them or requirements set by your local municipality.

Connections

⚠ Complete all other connections before turning the unit on

- Carefully read the manuals of the devices that you are connecting and follow their instructions when making connections.
- Do not bundle connecting cables with power cords. Doing so could cause noise.
- Connect all plugs completely.

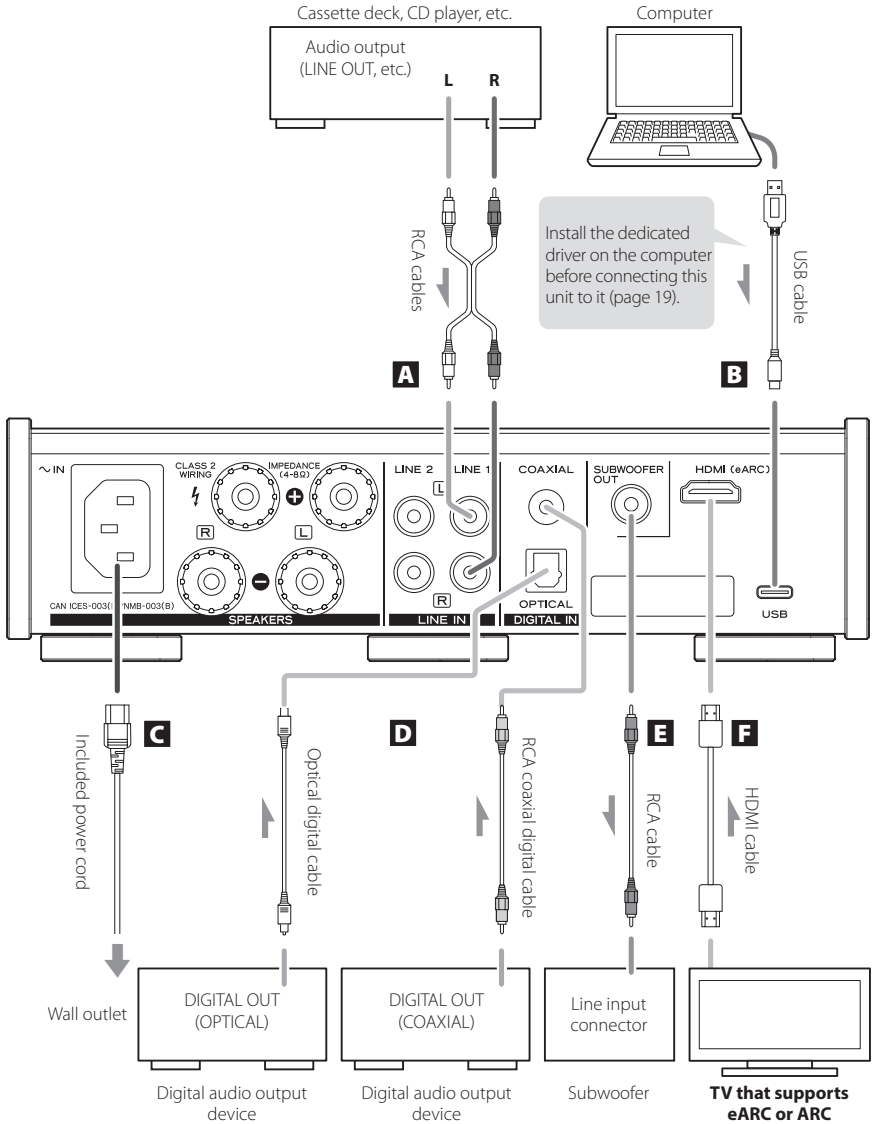

A Analog audio input (LINE 1, LINE 2) connectors

Use these to input 2-channel analog audio signals. Connect an audio output device such as a cassette deck or CD player to these connectors using commercially-available RCA cables.

Connect this unit's R input connector to the R output connector of the audio output device, and this unit's L input connector to the L output connector of the other device.



B USB input port

Use this to input digital audio from a computer. Connect it to a computer's USB port. Use a commercially-available USB cable.

- Install the dedicated driver on the computer before connecting this unit to it (page 19).

C Power inlet (~IN)

Connect the supplied power cord here. After all other connections are complete, connect the power cord's plug to a wall outlet.

⚠ Do not use any power cord other than the one included with this unit. Use of other power cords could result in fire or electric shock.

⚠ Disconnect the power plug from the outlet if you will not use the unit for a long time.

D DIGITAL IN (COAXIAL, OPTICAL) audio input connectors

Use these to input digital audio. Connect digital audio output connectors of digital audio devices here.

COAXIAL: RCA digital coaxial cable

OPTICAL: Optical digital cable (TOS)

E SUBWOOFER OUT connector

If you want to use a subwoofer, connect it to this connector.

- The VOLUME knob on the unit front controls the output level.

F HDMI (eARC) audio input connector

Connecting speakers

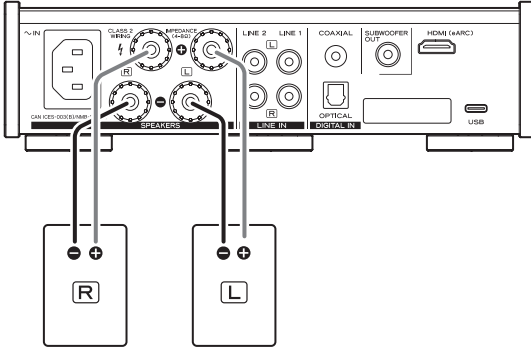

Notice about the European model

In accordance with European safety regulations, connecting banana plugs to speaker terminals is not allowed on European models.

The holes into which banana plugs could be inserted have been covered with black caps.

Connect speakers using bare wires or spade lugs. Connect speakers using bare wires or spade lugs. If a black cap should become separated from its terminal, return it to its original position.

⚠ Precautions when making connections

- After all other connections are complete, connect the power cord's plug to a wall outlet.
- Carefully read the manuals of the devices that you are connecting and follow their instructions when making connections.

ATTENTION

- Check the impedance of your speakers. Connect speakers with an impedance of between 4 Ω and 8 Ω . If speakers with different impedance ratings are used, the protection circuit could operate, causing sound output to stop.
- The red speaker terminals are positive (+) and the black speaker terminals are negative (-). Generally, the + wire of the speaker cable is marked to distinguish it from the - wire of the cable. Connect the marked wire to the red + terminal and the unmarked wire to the black - terminal.
- If the exposed core wires at the tips of the speaker cables should touch other cables or terminals, an electrical short might occur. Never allow speaker cables to cause a short.
- To prevent hum and noise, avoid bundling the cables together with the AC power cord or other cables.

How to connect speakers

- 1 Turn the terminal cap counterclockwise to loosen it.**

- The speaker terminal caps cannot be fully removed from the unit.

- 2 Insert the wire into the hole in the terminal post and turn the terminal cap clockwise to securely connect it.**

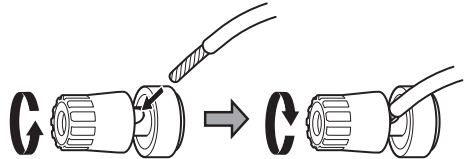

- Make sure none of the wire insulation is under the terminal and only the bare, stripped wire is touching the terminal.

- 3 Confirm that the cable is fastened securely by gently pulling the cable.**

Connecting with banana plugs

You can also make connections using commercially-available banana plugs. First, connect the banana plugs to the speaker cables and then connect the plugs to the terminals.

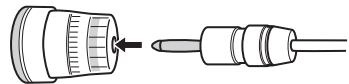

- Keep the caps tightened when in use.
- Carefully read the instructions for the banana plugs that you are using.

Main unit parts and functions

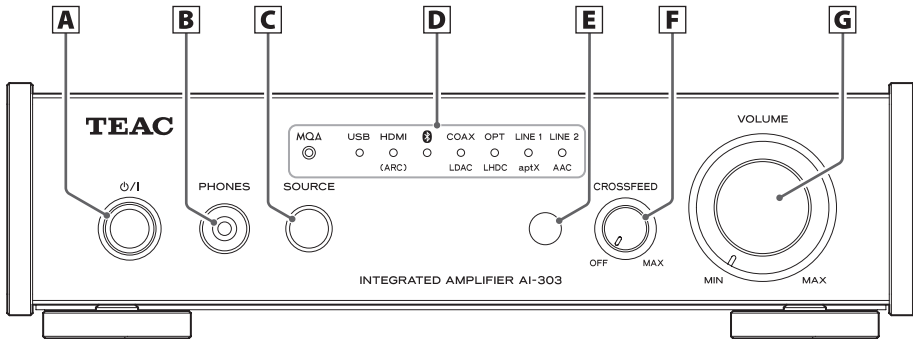

A Standby/on (⏻/I) button

Press this to turn the unit on and put it in standby. When the unit is turned on, the ring around the button lights blue.

- When this unit is in standby mode, it consumes standby power. For this reason, we use the term “standby” rather than “off”.

B PHONES jack

Connect a 3.5mm (1/8”) stereo mini plug for headphones here.

C SOURCE button

Use this button to select the input source.

D Input source indicators

The indicator for the source that is selected lights. These indicators blink when an input signal is not input properly. This unit can play back linear PCM signals. It cannot play back Dolby Digital, DTS, AAC and other formats. Set the source device to linear PCM output.

E Remote control signal receiver

This receives signals from the remote control. When operating the remote control, point it at the remote control signal receiver.

F CROSSFEED knob

Turning this right will increase the amount that the left and right sound signals are each mixed into the other channel, making the overall sound more centralized in the stereo field. Turning this all the way to the right will make the sound mono. Turning this all the way to the left will turn this function off (page 14).

G VOLUME knob

Use this to adjust the volume. Turn it right to increase and left to decrease the volume.

Remote control parts and functions

a MUTE button

Press this to mute the sound temporarily. To restore the sound, press it again.

b Standby/on (⏻/⏻) button

Press this to turn the unit on and put it in standby.

c Input source selection buttons

Use these to select the audio output source.

d VOLUME (-/+) buttons

Use these to adjust the volume.

e UP CONVERT button

Press this to change the upconversion setting (page 21).

f FILTER button

This changes the digital filter type (page 21).

g DISPLAY button

This shows the playback sampling frequency (Fs) (page 21).

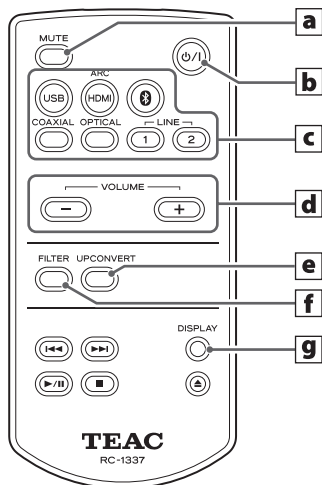

You can control both this AI-303 and a PD-301 using the RC-1337 remote control. Only the buttons used for the AI-303 are explained in this document.

Basic operation

1 Press the standby/on (⏻/⏻) button to turn the unit on.

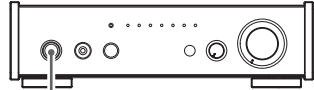

2 Press the SOURCE button to select the input source.

Each time the SOURCE button is pressed, the source changes as follows:

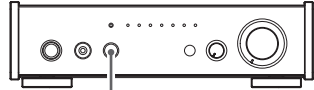
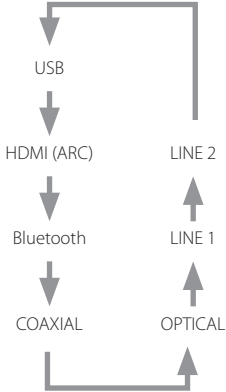

SOURCE



The indicator lights for the selected source.

- The input source indicators blink when the input signal is a digital audio format (such as Dolby Digital, DTS or AAC).
If this is the case, check to see if the connected digital audio output device has a “PCM” setting for the digital output format. Refer to the operation manual for that device to make this setting.
- When using this unit with a Windows computer, before setting this unit to USB and playing back audio files on the computer, you must install the dedicated driver on that computer (page 19).

3 Operate the audio output device.

Refer to the operation manual of the audio output device that you are using.

4 Adjust the volume.

Turn the VOLUME knob or use the VOLUME buttons on the remote control to adjust the volume to the appropriate level.

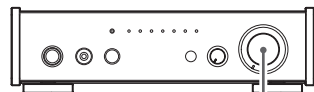

VOLUME

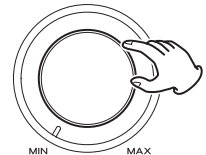

MQA (Master Quality Authenticated)

MQA is an award-winning British technology that delivers the sound of the original master recording. The master MQA file is fully authenticated and is small enough to stream or download.

Visit mqa.co.uk for more information.

The AI-303 includes MQA technology, which enables you to play back MQA audio files and streams, delivering the sound of the original master recording.

The state of the MQA indicator shows whether the unit is decoding and playing an MQA stream or file, guaranteeing that the sound is identical to that of the source material. When the MQA indicator lights blue, this shows that the file playing is an MQA studio file that has either been approved in the studio by the artist/producer or has been verified by the copyright owner.

- This unit can decode MQA streams and files only when the playback source is USB, HDMI (ARC), COAXIAL or OPTICAL.

Indicator during MQA playback

Type	MQA indicator
MQA	Green
MQA Studio	Blue
MQA Core	Magenta

Crossfeed function

- By using the crossfeed function when listening through headphones, a sound that is closer to the sound heard from speakers can be re-created. **In particular, when listening for extended periods, this can improve appreciation of the music recorded with extreme left and right channel separation, which was common in the early days of stereo recording.**
- When using speakers, the sound image will be focused toward the center of the stereo field. This has the effect of making vocals and narration clearer and easier to understand.
- Turn the CROSSFEED knob all the way to the left to turn off the crossfeed function and use ordinary stereo playback. Turning this all the way to the right will focus all the sound to the center and make it mono.

HDMI (eARC)

By using a single HDMI cable to connect the HDMI connector of this unit to the ARC connector of a TV that supports ARC (Audio Return Channel) or eARC (Enhanced Audio Return Channel), digital audio (up to 192kHz/24-bit) from the TV or player connected to the TV can be output from the speaker and headphone jacks of the AI-303.

Since HDMI CEC is supported, the TV remote control can be used to adjust the volume of this unit and mute it. In addition, the power of this unit can be linked to turning the TV power on/off (standby).

- HDMI CEC support commands differ according to the TV, so synchronized operation with all TVs is not guaranteed.
- This unit complies with the eARC (Enhanced Audio Return Channel) specification, but it does not support the decoding of Dolby Atmos®, Dolby TrueHD, DTS:X™, DTS-HD and other formats. Set the audio output of the TV to linear PCM before connecting.
- The digital audio signals that can be output varies by TV. Even if a Blu-Ray Player or other playback device outputs high-resolution audio signals, the TV might restrict resolution to 48kHz/16-bit. For details, check with the manufacturer of the TV that you are using.

Bluetooth® notes

When using this unit with a mobile phone or other Bluetooth devices, they should be no more than about 10 m (33 ft) apart.

Depending on the circumstances of use, however, the effective transmission distance might be shorter.

Wireless communication with every device that supports Bluetooth wireless technology is not guaranteed.

To determine the compatibility between this unit and another device that supports Bluetooth wireless technology, refer to that device's operation manual or contact the shop where you purchased it.

Content protection

This unit supports SCMS-T as a form of content protection when transmitting audio, so it can play protected audio.

Transmission security

This unit supports security functions during Bluetooth wireless transmission in accordance with the Bluetooth standard specifications, but it does not guarantee the privacy of such transmissions.

TEAC CORPORATION will bear no responsibility should an information leak occur during Bluetooth wireless transmission.

Profiles

This unit supports the following Bluetooth profiles.

- A2DP (Advanced Audio Distribution Profile)
- AVRCP (Audio/Video Remote Control Profile)

In order to transfer audio using Bluetooth wireless transmission, the Bluetooth device must support A2DP.

In order to control playback on the Bluetooth device, it must support AVRCP.

Even if a Bluetooth device supports the same profiles, though, its functions might differ according to its specifications.

Codecs

This unit supports the following codecs. It will automatically select one that is appropriate for the other Bluetooth device during audio transfer.

- LDAC
- LHDC
- Qualcomm® aptX™ HD audio,
- Qualcomm® aptX™ audio
- AAC
- SBC

Bluetooth® wireless technology (continued)

1 Press the standby/on (⏻/⏻) button to turn the unit on.

2 Press the SOURCE button one or more times to select Bluetooth (📶).

This puts the unit into Bluetooth mode.

3 Pair or connect with another Bluetooth device.

Pairing with another Bluetooth device

The first time another Bluetooth device is used with this unit, they must be paired.

To prepare this unit to pair, put it into Bluetooth mode and press the SOURCE button or remote control 📶 button for at least three seconds. When this unit is ready to pair, its 📶 indicator flashes rapidly.

After this unit enters pairing mode, pair with it (shown as AI-303) on the other Bluetooth device. The indicator stops flashing and stays lit when pairing completes and they are connected.

For details, refer to the operation manual of that Bluetooth device.

To connect with a Bluetooth device that has already been paired, follow the connection procedures for that device.

- When pairing or connecting, devices should be within a few meters of each other. If they are too far apart, pairing and connection afterwards might become impossible.
- If you want to delete pairing data and initialize the Bluetooth circuit, press the SOURCE button or remote control 📶 button for at least 10 seconds. At this time, all input indicators will flash twice.

⚠ ATTENTION

Regardless of the connection standby states of this unit and the other Bluetooth device, if the Bluetooth indicator continues blinking for a long time, turn off both this unit and the other device. Then, restart them and conduct connection procedures again.

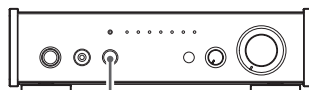
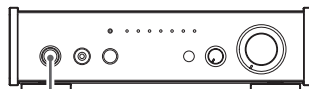

4 Start audio output on the other Bluetooth device.

- Confirm that the volume is turned up on the other Bluetooth device. If the volume of the audio being output is not turned up, no sound might be output from this unit.

5 Adjust the volume.

- The volumes of this unit and the other Bluetooth device are not linked. This unit cannot control the volume of the other Bluetooth device, and that device cannot control the volume of this unit.

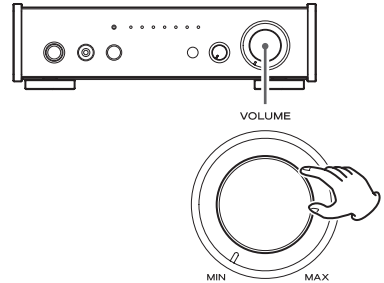

NOTE

- You cannot select the codec to be used by pressing a button, for example.
- Due to the characteristics of Bluetooth wireless technology, compared to the playback on the Bluetooth device, audio output through this unit will be slightly delayed.

Checking the Bluetooth audio codec

The audio codec being used for Bluetooth playback is shown by the green indicator.

Support for multipoint connection

Connecting with 2 Bluetooth devices at the same time is possible. Audio can only be output from one at a time when connected. Output from the device that most recently started playback will be prioritized. **Playback will be stopped on the previously playing device.**

LDAC is an audio coding technology developed by Sony that enables the transmission of High-Resolution (Hi-Res) Audio content, even over a Bluetooth connection.

Unlike other Bluetooth compatible coding technologies such as SBC, it operates without any down-conversion of the Hi-Res Audio content*, and allows approximately three times more data** than those other technologies to be transmitted over a Bluetooth wireless network with unprecedented sound quality, by means of efficient coding and optimized packetization.

* excluding DSD format contents

** in comparison with SBC (Subband Coding) when the bitrate of 990 kbps (96/48 kHz) or 909 kbps (88.2/44.1 kHz) is selected

Energy-saving functions

This product has energy-saving sleep and standby states.

The operation of these functions depend on the automatic standby setting and the selected input source.

Sleep overview

Only when the input source is USB, HDMI (ARC), Bluetooth, COAXIAL or OPTICAL

If there is no digital input signal from the selected source and no operation occurs for about three minutes, the unit will enter sleep mode.

Inputting the selected digital signal will wake the unit (automatic power on function).

- When in sleep mode, the input indicators will light dimly.

When the automatic standby function is on

The unit will enter standby mode after about 30 minutes if it remains in sleep mode or if there is no sound when the input source is LINE. When in standby mode, inputting the selected digital signal will not turn the unit on again.

Press the standby/on (⏻/I) button on the main unit or the remote control to turn the unit on again.

- Power consumption in standby mode is 0.5 W or less.

Checking procedure

If the automatic standby function is off, all the input indicators will light temporarily when the unit is turned on.

Setting the automatic standby function

When the unit is in a standby state, press and hold the standby/on (⏻/I) button. After about 3 seconds the input indicators will change as shown below and the automatic standby setting will change.

From all lit to 2 flashes: automatic standby function on

From input indicator to all lit: automatic standby function off

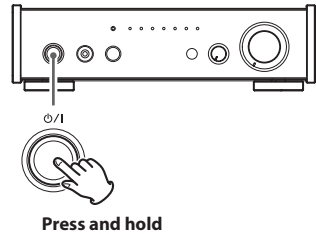

Operating systems that have been confirmed for use

We provide information about operating systems that have been confirmed for use on the product web page at the following URL.

<https://teac.jp/int/product/ai-303/>

Installing the driver

When using Mac

This unit can be operated with the standard OS driver, so there is no need to install a driver.

A dedicated driver must be installed on the computer, however, to use Bulk Pet.

When using Windows

The dedicated driver must be installed on the computer.

Installing the driver on a computer

Install the dedicated driver on the computer after downloading it from the following URL.

For details about installation and OS setting procedures, see the installation guide included with the driver.

<https://teac.jp/int/product/ai-303/download>

The sampling frequencies that can be transmitted are 44.1 kHz, 48 kHz, 88.2 kHz, 96 kHz, 176.4 kHz, 192 kHz, 352.8 kHz and 384 kHz.

2.8MHz, 5.6MHz and 11.2MHz DSD are also supported.

When properly connected, you will be able to select "TEAC USB AUDIO DEVICE" as the audio output for the operating system.

Downloading playback application TEAC HR Audio Player

You can download Mac and Windows versions of our free TEAC HR Audio Player application that supports playback of DSD files.

<https://teac.jp/int/product/ai-303/download>

Playing back music on a computer (continued)

Playing back audio files on a computer

1 Connect this unit to the computer using a USB cable.

- When a dedicated driver is necessary for connection, it must be installed on the computer beforehand (page 19).
- Use a cable that has a USB Type-C connector for connecting to this unit.

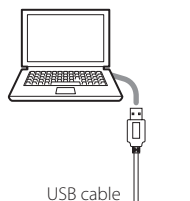

2 Turn the computer on.

- Confirm that the computer has started up correctly.

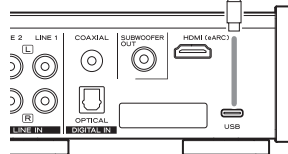

3 Press the standby/on (⏻/⏻) button to turn the unit on.

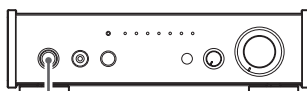

4 Press the SOURCE button repeatedly to select USB.

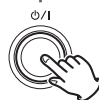

5 Start playback of an audio file on the computer.

If you can adjust the volume from the computer, set it to its maximum level and use this unit's VOLUME knob to adjust the level for the best audio quality.

- If you are using the TEAC HR Audio Player application, the volume cannot be adjusted from the computer.

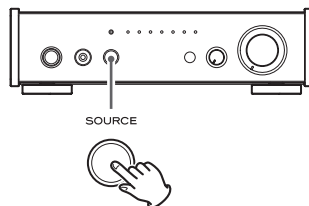

- The computer and this unit cannot control each other.

• Do not do any of the following when playing back audio files over the USB connection. Doing so could cause the computer to malfunction. Always quit the audio playback software before conducting any of these operations.

- Unplugging the USB cable
- Putting the unit into standby mode.
- Changing the current input selection

- To avoid outputting computer operation sounds, change the settings on the computer.

• Connect the computer and this unit and wait until the driver has loaded properly before starting the audio playback software. When connecting for the first time or using a different USB port, driver loading could take some time.

Sampling frequency display during playback

Press the remote control DISPLAY button to show for a few seconds the sampling frequency (Fs) of the sound source playing back.

Digital filters

Press the remote control FILTER button to change the digital filter type.

- This setting has no effect when the input is DSD.

RDOT filter

RDOT is an analogous interpolation method, that uses fluency logic. This filter features re-creation of natural tones and sound space. With upconversion, 4 settings are available.

FIR filter

This FIR filter features short delay with slow roll-off. Compared to RDOT, **the edges of sounds are gentler**. Upconversion is disabled.

Upconversion

The upconversion function can be used with input sources other than analog audio.

Press the remote control UPCONVERT button to change this setting.

- This setting only functions when the RDOT digital filter is selected.

The relationships between input sampling frequencies and sampling frequencies after upconversion are shown on the table below.

Input source		Upconversion setting			
Digital audio input	USB	OFF	2x Fs	4x Fs	8x Fs
Input sampling frequency		Sampling frequency after upconversion			
[kHz]		[kHz]			
32	–	32	64	128	256
44.1	44.1	44.1	88.2	176.4	352.8
88.2	88.2	88.2	88.2	176.4	352.8
176.4	176.4	176.4	176.4	176.4	352.8
–	352.8	352.8	352.8	352.8	352.8
48	48	48	96	192	384
96	96	96	96	192	384
192	192	192	192	192	384
–	384	384	384	384	384

 These values are not converted.

- The maximum upconversion is 8x Fs.
- Upconversion is not possible when the input is DSD.

Playback operations (continued)

Input indicator lighting

Pressing the DISPLAY, FILTER or UPCONVERT button on the remote control will cause the input indicator lighting to change, showing the state, as follows.

Item	State	Input source indicators						
		USB	HDMI (ARC)		COAX LDAC	OPT LHDC	LINE 1 aptX	LINE 2 AAC
Sampling frequency of playing audio*	48 kHz	Blue	–	–	–	–	–	–
	44.1 kHz	–	Blue	–	–	–	–	–
	32 kHz	–	–	Blue	–	–	–	–
Sampling frequency of playing audio (PCM)*	1x	–	–	–	–	–	–	Green
	2x	–	–	–	–	–	Green	–
	4x	–	–	–	–	Green	–	–
	8x	–	–	–	Green	–	–	–
Sampling frequency of playing audio (DSD)*	DSD64	–	–	–	–	–	–	Magenta
	DSD128	–	–	–	–	–	Magenta	–
	DSD256	–	–	–	–	Magenta	–	–
Digital filter	RDOT	–	Blue	Blue	–	–	–	Green
	FIR	–	Blue	Blue	–	–	Green	–
Upconversion setting	OFF	Blue	Blue	–	–	–	–	Green
	2× Fs	Blue	Blue	–	–	–	Green	–
	4× Fs	Blue	Blue	–	–	Green	–	–
	8× Fs	Blue	Blue	–	Green	–	–	–

*This is shown at the same time.

Troubleshooting

If you experience a problem with the unit, please take a moment to review the following information before requesting service. If it still does not operate correctly, contact the retailer where you purchased the unit.

General	The unit does not turn on.	<p>Check that the power cord is completely plugged into the power outlet. If the outlet is switched, confirm that the switch is in the ON position.</p> <p>Connect a different electrical device to the outlet to confirm that it is supplying power.</p>
	All the indicators on the front are blinking.	<p>The protection circuit is operating because excessive electrical current flowed to a speaker output connector.</p> <p>Turn the unit off and check if anything is wrong with the speaker output connectors. In addition, confirm that nothing is wrong with the speaker cables and speakers themselves.</p>
Connections with a computer	Computer does not recognize this unit.	<p>If the connection requires a driver, confirm that the latest driver has been installed properly and restart the computer. The latest driver can be downloaded from the website for this product, which is shown on page 19.</p> <p>Even if a computer operating system has been confirmed to work with this unit, proper connection still might not be possible depending on the composition of the computer hardware and software.</p>
	Noise occurs.	<p>Starting other applications during playback of an audio file may interrupt playback or cause noise. Do not start other applications during playback.</p>
	Audio files cannot be played back.	<p>Connect this unit to the computer, and set this unit's input to USB before starting audio playback software and audio file playback.</p> <p>Proper playback might not be possible if you connect this unit to the computer or change its input to USB after starting the audio playback software.</p>
Volume	Volume is low when connected to a computer or Bluetooth device	<p>Confirm that the volume setting is not low on the computer or other Bluetooth device. Better sound quality can be achieved by maximizing the volume of the source device and adjusting the volume with this unit.</p>

Since this unit uses a microcontroller, external noise and other interference can cause the unit to malfunction. If this occurs, unplug the power cord, wait for a while, and then turn the unit on again and restart operations.

Troubleshooting (continued)

Connections with a TV

Sound from a TV connected by HDMI is not output

Connect the cable to an HDMI connector labeled ARC or eARC on the TV.

Set the TV audio output to use an external sound system.

Select PCM for the digital audio output of the TV.

Specifications

Amplifier

Rated output	
25 W + 25 W0.03% (LINE IN, 1 kHz, 8 Ω, JEITA)
50 W + 50 W0.03% (LINE IN, 1 kHz, 4 Ω, JEITA)
THD+N 0.008%
	(LINE IN, 20 Hz – 20 kHz, 4 Ω, 6.25 W, JEITA)
THD+N 0.004%
	(LINE IN, 1 kHz, 4 Ω, 6.25 W, JEITA)
S/N ratio100 dB (LINE IN, JEITA)
Frequency response 2 Hz – 70 kHz
	(LINE IN, –5 dB, JEITA)

Digital audio inputs

Coaxial digital connector 1
Optical digital connector 1
Supported sampling frequencies	
Linear PCM	
32 kHz, 44.1 kHz, 48 kHz, 88.2 kHz, 96 kHz, 176.4 kHz,	
192 kHz (16/24-bit)	
DSD 2.8 MHz
(supported using 176.4kHz/24-bit DoP transmission)	
USB Type C port USB 2.0 standard
Supported sampling frequencies	
Linear PCM	
44.1 kHz, 48 kHz, 88.2 kHz, 96 kHz, 176.4 kHz, 192 kHz,	
352.8 kHz, 384 kHz (16/24/32-bit)	
DSD 2.8 MHz, 5.6 MHz, 11.2 MHz
HDMI ARC/eARC 192 kHz/24-bit (PCM)

Analog audio inputs

RCA connectors 2
Input impedance 10 kΩ

Bluetooth wireless technology

Bluetooth version 4.2
Output class Class 2
(transmission distance without obstructions*	10 m)
Supported profiles A2DP, AVRCP
Supported A2DP codecs LDAC, LHDC,
	Qualcomm aptX™ HD audio,
	Qualcomm aptX™ audio, AAC, SBC
Supported A2DP content protection SCMS-T
Maximum number of stored pairings 8

Maximum number of multipoint connections 2

*The transmission distance is approximate. The transmission distance could vary depending on the surrounding environment and electromagnetic waves.

Headphones output

Rated output 220 mW + 220 mW
	(LINE IN, 32 Ω, 1 kHz, 1%, JEITA)
THD+N 0.006%
	(LINE IN, 32 Ω, 1 kHz, 50 mW, JEITA)

General

Power supply	
Model for Europe AC 230 V, 50 Hz
Model for USA/Canada AC 120 V, 60 Hz
Power consumption 63 W
	33 W
External dimensions (W × H × D, including protrusions)	
	215 × 61 × 257 mm (8 1/2" × 2 1/2" × 10 1/8")
Weight 3.3 kg (7 3/8 lb)
Operating temperature range +5°C to +35°C
Operating humidity range 5% to 85% (no condensation)
Storage temperature range –20°C to +55°C

Included accessories

- Power cord × 1
- Foot pads × 3
- Remote control (RC-1337) × 1
- Batteries for remote control (AAA) × 2
- Owner's manual (this document, including warranty) × 1
- For information about the warranty, see pages 26–27.

- Specifications and appearance are subject to change without notice.
- Weight and dimensions are approximate.
- Illustrations in this owner's manual might differ slightly from production models.

WARRANTY/GARANTIE/GARANTÍA

In the United States/Canada/Aux États-Unis/Canada

Model/Modèle: **AI-303**

Serial No./N° de série

Date of purchase/Date de l'achat

Owner's name/Nom du propriétaire

Owner's address/Adresse du propriétaire

Dealer's name/Nom du revendeur

Dealer's address/Adresse du revendeur

Length of Warranty

The parts and labor warranty will be effective for one (1) year from the date of the original purchase for products not used for commercial purposes. For products used commercially, the warranty is ninety (90) days for magnetic heads and optical pickups, one (1) year for all other parts and ninety (90) days for labor.

Who Is Covered Under This Warranty

This warranty is valid only in the United States or Canada, dependent upon the country in which original purchase was made, and enforceable only by the original purchaser within the country in which the purchase was made.

What Is Not Covered Under This Warranty

- Damage to or deterioration of the external cabinet.
- Damage resulting from accident, misuse, abuse, or neglect.
- Damage resulting from failure to follow instructions contained in the products owners' manual or otherwise provided with the product.
- Damage occurring during shipment of the product (Claims must be presented to the carrier).
- Damage resulting from the repair or attempted repair by anyone other than TEAC or an authorized TEAC service station.
- Damage resulting from modification or attempted modification of product not authorized by TEAC.
- Damage resulting from causes other than product defects, including lack of technical skills, competence, or experience of the user.
- Damage to any unit that has been altered or which the serial number has been defaced, modified or removed.

What TEAC Will Pay For

TEAC will pay all labor and material expenses for items covered by the warranty. Payment of shipping charges is covered in the next section.

How To Obtain Warranty Service

Your unit must be serviced by an authorized TEAC service station within the country in which the product was purchased. If you are unable to locate an authorized service station in your area, please contact TEAC at the applicable address shown at the end of this warranty statement. PLEASE DO NOT RETURN YOUR UNIT TO TEAC WITHOUT OUR PRIOR AUTHORIZATION. You must pay shipping charges if it is necessary to ship the product for service. However, if the necessary repairs are covered by warranty, we will pay the return shipping charges to any destination within the country in which the product was purchased. Whenever warranty service is required, you must present the original dated sales receipt, or other proof indicating the purchase place and date, as proof of warranty coverage.

LIMITATION OF IMPLIED WARRANTIES

ALL IMPLIED WARRANTIES, INCLUDING WARRANTIES OF MERCHANTABILITY AND FITNESS FOR A PARTICULAR PURPOSE, ARE LIMITED IN DURATION TO THE LENGTH OF THIS WARRANTY.

EXCLUSION OF DAMAGES

TEAC'S LIABILITY FOR ANY DEFECTIVE PRODUCT IS LIMITED TO REPAIR OR REPLACEMENT OF THE PRODUCT, AT TEAC'S OPTION. TEAC SHALL NOT BE LIABLE FOR DAMAGE BASED UPON INCONVENIENCE, LOSS OF USE OF THE PRODUCT, INTERRUPTED OPERATION, COMMERCIAL LOSS OR LOST PROFITS, OR ANY OTHER DAMAGES, WHETHER INCIDENTAL, CONSEQUENTIAL, PUNITIVE OR OTHERWISE.

SOME STATES OR PROVINCES DO NOT ALLOW LIMITATIONS ON HOW LONG AN IMPLIED WARRANTY LASTS AND/OR DO NOT ALLOW THE EXCLUSION OR LIMITATION OF INCIDENTAL OR CONSEQUENTIAL DAMAGES, SO THE ABOVE LIMITATIONS AND EXCLUSIONS MAY NOT APPLY TO YOU.

THIS WARRANTY GIVES YOU SPECIFIC RIGHTS, AND MAY VARY FROM SOME OF THE RIGHTS PROVIDED BY LAW. THESE RIGHTS MAY VARY FROM STATE TO STATE OR PROVINCE TO PROVINCE.

Durée de la garantie

La garantie pièces et main d'œuvre sera valable un (1) an à compter de la date d'achat initial des produits non utilisés dans un but commercial. Pour les produits à utilisation commerciale, la garantie des têtes magnétiques et capteurs optiques est de quatre-vingt dix (90) jours, elle est d'un (1) an pour les autres pièces et quatre-vingt dix (90) jours pour la main d'œuvre.

Bénéficiaire de la garantie

Cette garantie n'est valable qu'aux États-Unis et au Canada, selon le pays d'achat initial, et ne s'applique qu'à l'acquéreur initial dans le pays d'achat.

Ce qui n'est pas couvert par cette garantie

- Les dommages ou détériorations du boîtier externe.
- Les dommages résultant d'un accident, d'une mauvaise utilisation, d'un abus ou d'une négligence.
- Les dommages résultant du non-respect des instructions contenues dans le mode d'emploi du produit ou fournies avec le produit.
- Les dommages survenus durant le transport du produit (les réclamations doivent être adressées au transporteur).
- Les dommages résultant d'une réparation ou tentative de réparation effectuée par toute personne extérieure au service après-vente TEAC ou agréé par TEAC.
- Les dommages résultant d'une modification ou tentative de modification de produit non autorisée par TEAC.
- Les dommages résultant de causes autres que des défauts de produit, y compris le manque d'aptitude technique, de compétence ou d'expérience de l'utilisateur.
- Les dommages de toute unité ayant été modifiée ou dont le numéro de série a été effacé, modifié ou retiré.

Frais pris en charge par TEAC

TEAC prendra en charge tous les frais de pièces et main d'œuvre pour les articles couverts par la garantie. Les frais d'expédition sont évoqués dans la section suivante.

Comment obtenir une intervention sous garantie

Votre unité doit être réparée par un service après-vente agréé par TEAC dans le pays d'achat du produit. Si vous ne trouvez pas de service après-vente agréé dans votre région, veuillez contacter TEAC à l'adresse appropriée donnée à la fin de cette garantie. VEUILLER NE PAS RENVOYER VOTRE UNITÉ CHEZ TEAC SANS NOTRE AUTORISATION PRÉALABLE. Si le produit doit être renvoyé pour réparation, les frais d'expédition sont à votre charge. Toutefois, si les réparations nécessaires sont couvertes par la garantie, nous prendrons à notre charge les frais de retour vers toute destination dans le pays d'achat du produit. Lorsqu'une réparation sous garantie est requise, vous devez présenter comme preuve de couverture par la garantie la facture d'achat originale datée ou une autre preuve d'achat mentionnant le lieu et la date d'achat.

LIMITATION DES GARANTIES IMPLICITES

TOUTES LES GARANTIES IMPLICITES, Y COMPRIS LES GARANTIES DE QUALITÉ MARCHANDE ET D'ADÉQUATION À UN USAGE PARTICULIER, SONT LIMITÉES À LA DURÉE DE CETTE GARANTIE.

EXCLUSION DE DOMMAGES

LA RESPONSABILITÉ DE TEAC VIS-À-VIS DE TOUT PRODUIT DÉFECTUEUX EST LIMITÉE À LA RÉPARATION OU AU REMPLACEMENT DU PRODUIT, AU GRÉ DE TEAC. TEAC NE POURRA ÊTRE TENU POUR RESPONSABLE DE QUELCONQUES DOMMAGES SE RAPPORTANT AU DÉRANGEMENT, À LA PERTE D'USAGE DU PRODUIT, À L'INTERRUPTION DE L'UTILISATION, AUX PERTES COMMERCIALES OU DE PROFITS, NI D'AUCUN AUTRE DOMMAGE, QU'IL SOIT ACCESSOIRE, INDIRECT, PUNITIF OU AUTRE.

CERTAINS ÉTATS OU PROVINCES N'AUTORISENT PAS DE LIMITATIONS DE DURÉE D'UNE GARANTIE IMPLICITE ET/OU N'AUTORISENT PAS L'EXCLUSION OU LA LIMITATION DES DOMMAGES ACCESSOIRES OU INDIRECTS, AUQUEL CAS LES LIMITATIONS ET EXCLUSIONS CI-DESSUS PEUVENT NE PAS VOUS ÊTRE APPLICABLES.

CETTE GARANTIE VOUS DONNE DES DROITS SPÉCIFIQUES QUI PEUVENT ÊTRE DIFFÉRENTS DE CERTAINS DROITS OCTROYÉS PAR LA LOI. CES DROITS PEUVENT VARIER D'UN ÉTAT À L'AUTRE OU D'UNE PROVINCE À L'AUTRE.

TEAC

TEAC CORPORATION

1-47 Ochiai, Tama-shi, Tokyo 206-8530, Japan
<https://teac.jp/int/>

The serial number for this product is printed on the nameplate on the bottom of the unit.
Please write it here and retain this for your records.

Model name: AI-303

Serial number

0922 MA-3553A
