



中认信通
CHINA CERTIFICATION ICT CO., LTD (DONGGUAN)



TEST REPORT

Applicant: Shenzhen Xinguodu Technology Co.,Ltd.

Address: 17B JinSong Mansion, Terra Industrial & Trade Park Chegongmiao, Futian District, Shenzhen,Guangdong, China.

FCC ID: XDQK300PM-01

Product Name: POS Terminal

**Standard(s): 47 CFR Part 15, Subpart C(15.225)
ANSI C63.10-2013**

The above equipment has been tested and found compliant with the requirement of the relative standards by China Certification ICT Co., Ltd (Dongguan)

Report Number: CR230743871-00C

Date Of Issue: 2023/9/5

Reviewed By: Julie Tan
Title: RF Engineer

Julie Tan

Approved By: Sun Zhong
Title: Manager

Sun Zhong

Test Laboratory: China Certification ICT Co., Ltd (Dongguan)
No. 113, Pingkang Road, Dalang Town, Dongguan,
Guangdong, China
Tel: +86-769-82016888

Test Facility

The Test site used by China Certification ICT Co., Ltd (Dongguan) to collect test data is located on the No. 113, Pingkang Road, Dalang Town, Dongguan, Guangdong, China.

The lab has been recognized as the FCC accredited lab under the KDB 974614 D01 and is listed in the FCC Public Access Link (PAL) database, FCC Registration No. : 442868, the FCC Designation No. : CN1314.

The lab has been recognized by Innovation, Science and Economic Development Canada to test to Canadian radio equipment requirements, the CAB identifier: CN0123.

Declarations

China Certification ICT Co., Ltd (Dongguan) is not responsible for the authenticity of any test data provided by the applicant. Data included from the applicant that may affect test results are marked with a triangle symbol “▲”. Customer model name, addresses, names, trademarks etc. are not considered data.

Unless otherwise stated the results shown in this test report refer only to the sample(s) tested.

This report cannot be reproduced except in full, without prior written approval of the Company.

This report is valid only with a valid digital signature. The digital signature may be available only under the Adobe software above version 7.0.

This report may contain data that are not covered by the accreditation scope and shall be marked with an asterisk “★”.

CONTENTS

TEST FACILITY	2
DECLARATIONS.....	2
DOCUMENT REVISION HISTORY	5
1. GENERAL INFORMATION	6
1.1 PRODUCT DESCRIPTION FOR EQUIPMENT UNDER TEST (EUT)	6
1.2 DESCRIPTION OF TEST CONFIGURATION.....	7
1.2.1 EUT Operation Condition:	7
1.2.2 Support Equipment List and Details	7
1.2.3 Support Cable List and Details	7
1.2.4 Block Diagram of Test Setup.....	8
1.3 MEASUREMENT UNCERTAINTY	9
2. SUMMARY OF TEST RESULTS	10
3. REQUIREMENTS AND TEST PROCEDURES	11
3.1 AC LINE CONDUCTED EMISSIONS.....	11
3.1.1 Applicable Standard.....	11
3.1.2 EUT Setup.....	12
3.1.3 EMI Test Receiver Setup	12
3.1.4 Test Procedure	13
3.1.5 Corrected Amplitude & Margin Calculation.....	13
3.2 RADIATED EMISSIONS	14
3.2.1 Applicable Standard.....	14
3.2.2 EUT Setup.....	14
3.2.3 EMI Test Receiver & Spectrum Analyzer Setup	14
3.2.4 Corrected Amplitude & Margin Calculation.....	15
3.3 20 DB EMISSION BANDWIDTH	16
3.3.1 Applicable Standard.....	16
3.3.2 EUT Setup.....	16
3.3.3 Test Procedure	16
3.4 FREQUENCY STABILITY.....	18
3.4.1 Applicable Standard.....	18
3.4.2 EUT Setup.....	18
3.4.3 Test Procedure	18
3.5 ANTENNA REQUIREMENT.....	20
3.5.1 Applicable Standard.....	20
3.5.2 Judgment.....	20
4. TEST DATA AND RESULTS	21
4.1 AC LINE CONDUCTED EMISSIONS.....	21
4.2 RADIATION SPURIOUS EMISSIONS	24
4.3 20 DB EMISSION BANDWIDTH	36

4.4 FREQUENCY STABILITY.....	38
5. RF EXPOSURE EVALUATION	39
 APPLICABLE STANDARD.....	39
6. EUT PHOTOGRAPHS	40
7. TEST SETUP PHOTOGRAPHS	41

DOCUMENT REVISION HISTORY

Revision Number	Report Number	Description of Revision	Date of Revision
1.0	CR230743871-00C	Original Report	2023/9/5

1. GENERAL INFORMATION

1.1 Product Description for Equipment under Test (EUT)

EUT Name:	POS Terminal
EUT Model:	K300
Operation Frequency:	13.56 MHz
Modulation Type:	ASK
Rated Input Voltage:	DC 5V from adapter or charging base or DC 3.8V from battery
Serial Number:	291M-1
EUT Received Date:	2023/8/1
EUT Received Status:	Good

Antenna Information Detail ▲ :

Antenna Type	input impedance (Ohm)	Frequency Range	Antenna Gain
Loop	50	13.56MHz	Unknown

The Method of §15.203 Compliance:

- Antenna must be permanently attached to the unit.
- Antenna must use a unique type of connector to attach to the EUT.
- Unit must be professionally installed, and installer shall be responsible for verifying that the correct antenna is employed with the unit.

Accessory Information:

Accessory Description	Manufacturer	Model	Parameters
Adapter 1#	Jiangxi Jian Aohal Technology Co.,Ltd.	A187-050100U-US1	Input: 100-240V~50/60Hz,200mA Output: DC5.0V,1A
Adapter 2#	SHENZHEN HONOR ELECTRONIC CO.,LTD	ADS-6MA-06 05050EPCU	Input: 100-240V~50/60Hz,Max 0.3A Output: DC5.0V,1A

1.2 Description of Test Configuration

1.2.1 EUT Operation Condition:

EUT Operation Mode:	The system was configured for testing in Engineering Mode, which was provided by the manufacturer. Per 15B emission for all adapters and charger base operation, the worst was adapter 2#+Charger base, which was performed with the final test and report.
Equipment Modifications:	No
EUT Exercise Software:	No
Engineering Mode was provided by manufacturer ▲. The maximum power was configured default setting.	

1.2.2 Support Equipment List and Details

Manufacturer	Description	Model	Serial Number
NEXGO	Charger Base	Unknown	291M-6

1.2.3 Support Cable List and Details

Cable Description	Shielding Type	Ferrite Core	Length (m)	From Port	To
USB Cable	No	No	1.2	Adapter	EUT

1.2.4 Block Diagram of Test Setup

AC line conducted emissions:

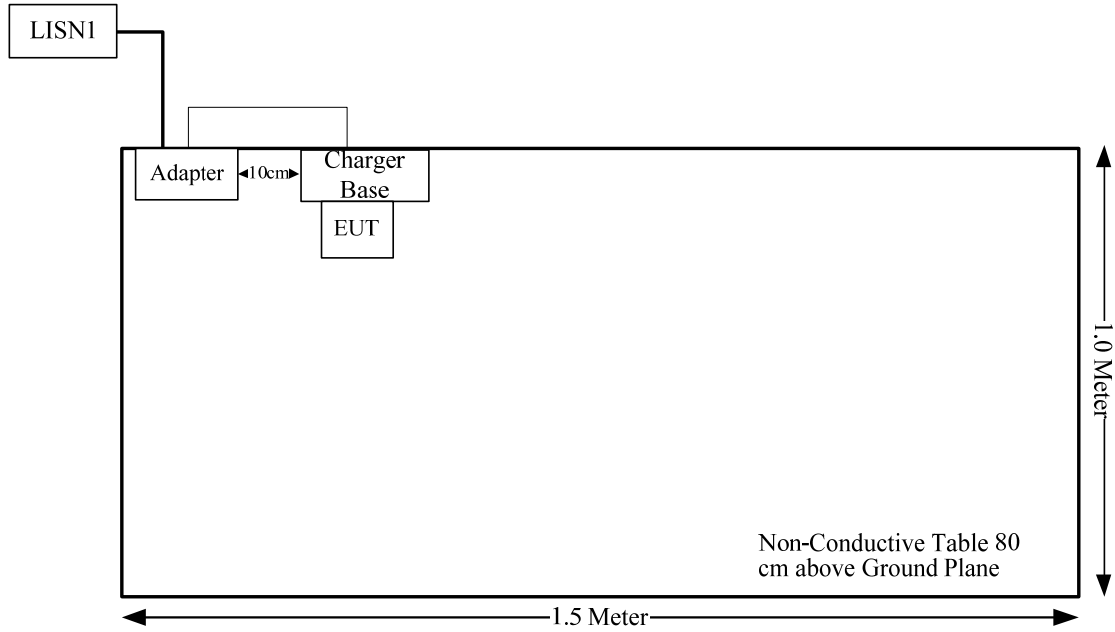

Spurious Emissions:

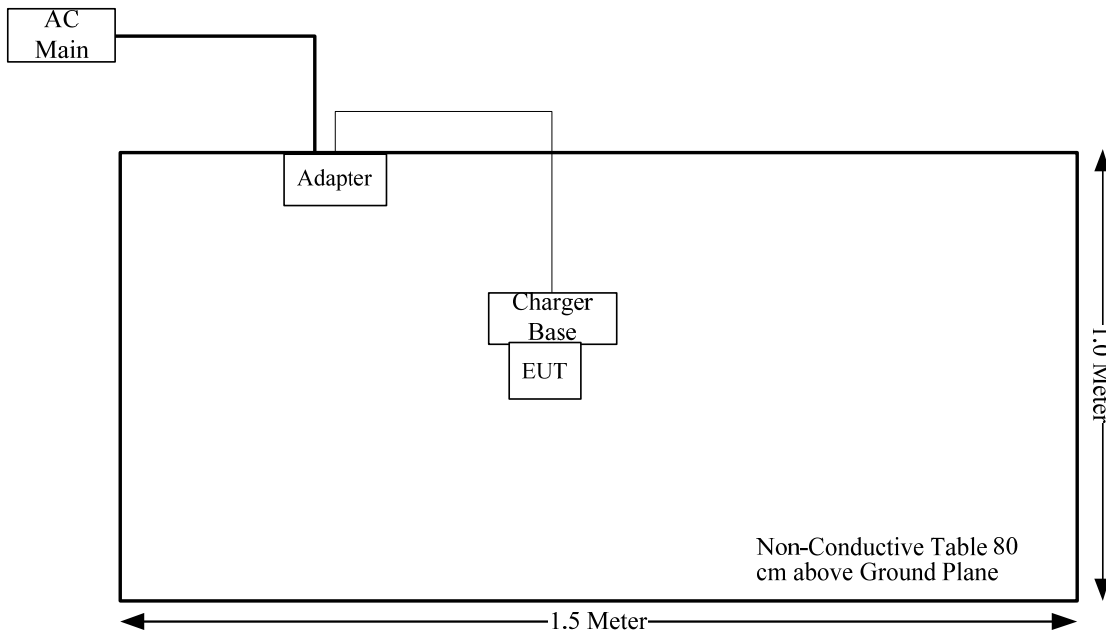

1.3 Measurement Uncertainty

Otherwise required by the applicant or Product Regulations, Decision Rule in this report did not consider the uncertainty. The extended uncertainty given in this report is obtained by combining the standard uncertainty times the coverage factor K with the 95% confidence interval.

Parameter	Measurement Uncertainty
Occupied Channel Bandwidth	±5 %
Unwanted Emissions, radiated	30M~200MHz: 4.15 dB, 200M~1GHz: 5.61 dB, 1G~6GHz: 5.14 dB, 6G~18GHz: 5.93 dB, 18G~26.5G: 5.47 dB, 26.5G~40G: 5.63 dB
Temperature	±1 °C
Humidity	±5%
DC and low frequency voltages	±0.4%
Duty Cycle	1%
AC Power Lines Conducted Emission	2.8 dB (150 kHz to 30 MHz)

2. SUMMARY OF TEST RESULTS

FCC Rules	Description of Test	Result
FCC§15.203	Antenna Requirement	Compliant
FCC§15.207 (a)	Conducted Emissions	Compliant
§15.225 §15.209 §15.205	Radiated Emission Test	Compliant
§15.225(e)	Frequency Stability	Compliant
§15.215(c)	20 dB Bandwidth	Compliant
§1.1310 & §2.1093	RF Exposure	Compliant

3. REQUIREMENTS AND TEST PROCEDURES

3.1 AC Line Conducted Emissions

3.1.1 Applicable Standard

FCC§15.207(a).

(a) Except as shown in paragraphs (b) and (c) of this section, for an intentional radiator that is designed to be connected to the public utility (AC) power line, the radio frequency voltage that is conducted back onto the AC power line on any frequency or frequencies, within the band 150 kHz to 30 MHz, shall not exceed the limits in the following table, as measured using a 50 μ H/50 ohms line impedance stabilization network (LISN). Compliance with the provisions of this paragraph shall be based on the measurement of the radio frequency voltage between each power line and ground at the power terminal. The lower limit applies at the boundary between the frequency ranges.

Frequency of emission (MHz)	Conducted limit (dB μ V)	
	Quasi-peak	Average
0.15-0.5	66 to 56*	56 to 46*
0.5-5	56	46
5-30	60	50

*Decreases with the logarithm of the frequency.

(b) The limit shown in paragraph (a) of this section shall not apply to carrier current systems operating as intentional radiators on frequencies below 30 MHz. In lieu thereof, these carrier current systems shall be subject to the following standards:

(1) For carrier current system containing their fundamental emission within the frequency band 535-1705 kHz and intended to be received using a standard AM broadcast receiver: no limit on conducted emissions.

(2) For all other carrier current systems: 1000 μ V within the frequency band 535-1705 kHz, as measured using a 50 μ H/50 ohms LISN.

(3) Carrier current systems operating below 30 MHz are also subject to the radiated emission limits in §15.205, §15.209, §15.221, §15.223, or §15.227, as appropriate.

(c) Measurements to demonstrate compliance with the conducted limits are not required for devices which only employ battery power for operation and which do not operate from the AC power lines or contain provisions for operation while connected to the AC power lines. Devices that include, or make provisions for, the use of battery chargers which permit operating while charging, AC adapters or battery eliminators or that connect to the AC power lines indirectly, obtaining their power through another device which is connected to the AC power lines, shall be tested to demonstrate compliance with the conducted limits.

3.1.2 EUT Setup

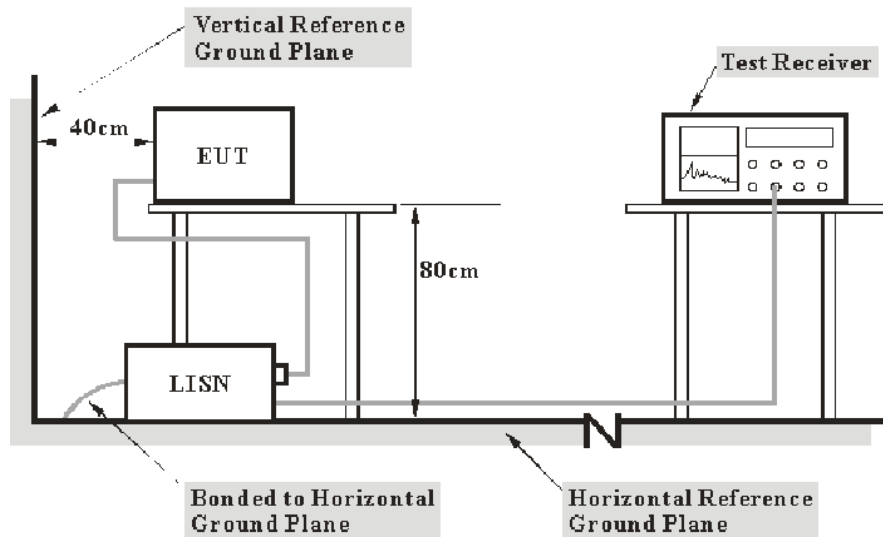

- Note: 1. Support units were connected to second LISN.
 2. Both of LISNs (AMN) 80 cm from EUT and at the least 80 cm from other units and other metal planes support units.

The setup of EUT is according with per ANSI C63.10-2013 measurement procedure. The specification used was with the FCC Part 15.207 limits.

The spacing between the peripherals was 10 cm.

The adapter or EUT was connected to the main LISN with a 120 V/60 Hz AC power source.

3.1.3 EMI Test Receiver Setup

The EMI test receiver was set to investigate the spectrum from 150 kHz to 30 MHz.

During the conducted emission test, the EMI test receiver was set with the following configurations:

Frequency Range	IF B/W
150 kHz – 30 MHz	9 kHz

3.1.4 Test Procedure

During the conducted emission test, the adapter was connected to the outlet of the LISN.

The frequency and amplitude of the six highest ac power-line conducted emissions relative to the limit, measured over all the current-carrying conductors of the EUT power cords, and the operating frequency or frequency to which the EUT is tuned (if appropriate), should be reported, unless such emissions are more than 20 dB below the limit. AC power-line conducted emissions measurements are to be separately carried out only on each of the phase (“hot”) line(s) and (if used) on the neutral line(s), but not on the ground [protective earth] line(s). If less than six emission frequencies are within 20 dB of the limit, then the noise level of the measuring instrument at representative frequencies should be reported. The specific conductor of the power-line cord for each of the reported emissions should be identified. Measure the six highest emissions with respect to the limit on each current-carrying conductor of each power cord associated with the EUT (but not the power cords of associated or peripheral equipment that are part of the test configuration). Then, report the six highest emissions with respect to the limit from among all the measurements identifying the frequency and specific current-carrying conductor identified with the emission. The six highest emissions should be reported for each of the current-carrying conductors, or the six highest emissions may be reported over all the current-carrying conductors.

According FCC publication number 174176, for a device with a permanent antenna operating at or below 30 MHz, the measurements done with a suitable dummy load, in lieu of the permanent antenna under the following conditions: (1) perform the AC line conducted tests with the permanent antenna to determine compliance with the Section 15.207 limits outside the transmitter's fundamental emission band; (2) retest with a dummy load in lieu of the permanent antenna to determine compliance with the Section 15.207 limits within the transmitter's fundamental emission band.

3.1.5 Corrected Amplitude & Margin Calculation

The basic equation is as follows:

Result = Reading + Factor

Factor = attenuation caused by cable loss + voltage division factor of AMN

The “**Margin**” column of the following data tables indicates the degree of compliance within the applicable limit. The equation for margin calculation is as follows:

Margin = Limit – Result

3.2 Radiated Emissions

3.2.1 Applicable Standard

As per FCC Part 15.225

- (a) The field strength of any emissions within the band 13.553–13.567 MHz shall not exceed 15,848 microvolts/meter at 30 meters.
- (b) Within the bands 13.410–13.553 MHz and 13.567–13.710 MHz, the field strength of any emissions shall not exceed 334 microvolts/meter at 30 meters.
- (c) Within the bands 13.110–13.410 MHz and 13.710–14.010 MHz the field strength of any emissions shall not exceed 106 microvolts/meter at 30 meters.
- (d) The field strength of any emissions appearing outside of the 13.110–14.010 MHz band shall not exceed the general radiated emission limits in §15.209.

3.2.2 EUT Setup

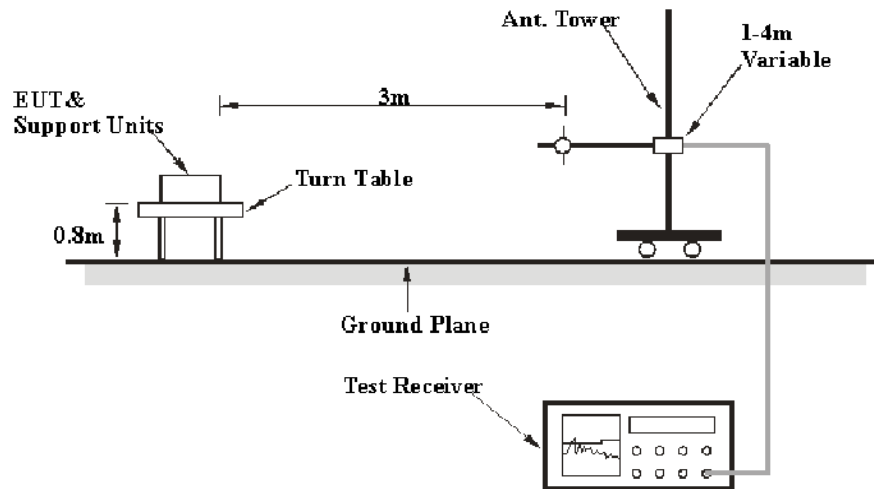

The radiated emission tests were performed in the 3-meter chamber test site, using the setup accordance with the ANSI C63.10-2013.

The spacing between the peripherals was 10 cm.

3.2.3 EMI Test Receiver & Spectrum Analyzer Setup

The system was investigated from 9 kHz to 1 GHz.

During the radiated emission test, the EMI test Receiver was set with the following configurations:

Frequency Range	RBW	Video B/W	Detector
9 kHz – 150 kHz	200 Hz	1 kHz	QP
150 kHz – 30 MHz	9 kHz	30 kHz	QP
30 MHz – 1000 MHz	120 kHz	300 kHz	QP

If the maximized peak measured value complies with the limit, then it is unnecessary to perform an QP measurement

3.2.4 Corrected Amplitude & Margin Calculation

The basic equation is as follows:

Result = Reading + Factor

Factor = Antenna Factor + Cable Loss- Amplifier Gain

The “**Margin**” column of the following data tables indicates the degree of compliance within the applicable limit. The equation for margin calculation is as follows:

Margin = Limit – Result

3.3 20 dB Emission Bandwidth

3.3.1 Applicable Standard

FCC §15.215

Intentional radiators operating under the alternative provisions to the general emission limits, as contained in §15.217 through § 15.257 and in Subpart E of this part, must be designed to ensure that the 20 dB bandwidth of the emission, or whatever bandwidth may otherwise be specified in the specific rule section under which the equipment operates, is contained within the frequency band designated in the rule section under which the equipment is operated. The requirement to contain the designated bandwidth of the emission within the specified frequency band includes the effects from frequency sweeping, frequency hopping and other modulation techniques that may be employed as well as the frequency stability of the transmitter over expected variations in temperature and supply voltage. If a frequency stability is not specified in the regulations, it is recommended that the fundamental emission be kept within at least the central 80% of the permitted band in order to minimize the possibility of out-of band operation.

3.3.2 EUT Setup

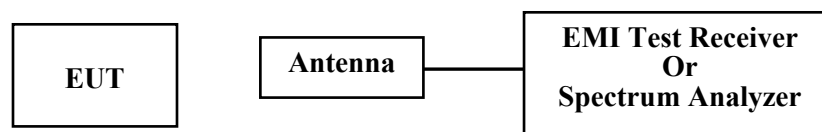

3.3.3 Test Procedure

According to ANSI C63.10-2013 Section 6.9.2

- a) The spectrum analyzer center frequency is set to the nominal EUT channel center frequency. The span range for the EMI receiver or spectrum analyzer shall be between two times and five times the OBW.
- b) The nominal IF filter bandwidth (3 dB RBW) shall be in the range of 1% to 5% of the OBW and video bandwidth (VBW) shall be approximately three times RBW, unless otherwise specified by the applicable requirement.
- c) Set the reference level of the instrument as required, keeping the signal from exceeding the maximum input mixer level for linear operation. In general, the peak of the spectral envelope shall be more than $[10 \log (OBW/RBW)]$ below the reference level. Specific guidance is given in 4.1.5.2
- d) Steps a) through c) might require iteration to adjust within the specified tolerances.
- e) The dynamic range of the instrument at the selected RBW shall be more than 10 dB below the target “-xx dB down” requirement; that is, if the requirement calls for measuring the -20 dB OBW, the instrument noise floor at the selected RBW shall be at least 30 dB below the reference value.
- f) Set detection mode to peak and trace mode to max hold.
- g) Determine the reference value: Set the EUT to transmit an unmodulated carrier or modulated signal, as applicable. Allow the trace to stabilize. Set the spectrum analyzer marker to the highest level of the displayed trace (this is the reference value).
- h) Determine the “-xx dB down amplitude” using $[(\text{reference value}) - xx]$. Alternatively, this calculation may be made by using the marker-delta function of the instrument.
- i) If the reference value is determined by an unmodulated carrier, then turn the EUT modulation ON, and either clear the existing trace or start a new trace on the spectrum analyzer and allow the new trace to stabilize. Otherwise, the trace from step g) shall be used for step j).

- j) Place two markers, one at the lowest frequency and the other at the highest frequency of the envelope of the spectral display, such that each marker is at or slightly below the “-xx dB down amplitude” determined in step h). If a marker is below this “-xx dB down amplitude” value, then it shall be as close as possible to this value. The occupied bandwidth is the frequency difference between the two markers. Alternatively, set a marker at the lowest frequency of the envelope of the spectral display, such that the marker is at or slightly below the “-xx dB down amplitude” determined in step h). Reset the marker-delta function and move the marker to the other side of the emission until the delta marker amplitude is at the same level as the reference marker amplitude. The marker-delta frequency reading at this point is the specified emission bandwidth.
- k) The occupied bandwidth shall be reported by providing plot(s) of the measuring instrument display; the plot axes and the scale units per division shall be clearly labeled. Tabular data may be reported in addition to the plot(s).

3.4 Frequency Stability

3.4.1 Applicable Standard

As per FCC Part 15.225:

The frequency tolerance of the carrier signal shall be maintained within $\pm 0.01\%$ of the operating frequency over a temperature variation of -20 degrees to $+50$ degrees C at normal supply voltage, and for a variation in the primary supply voltage from 85% to 115% of the rated supply voltage at a temperature of 20 degrees C. For battery operated equipment, the equipment tests shall be performed using a new battery.

3.4.2 EUT Setup

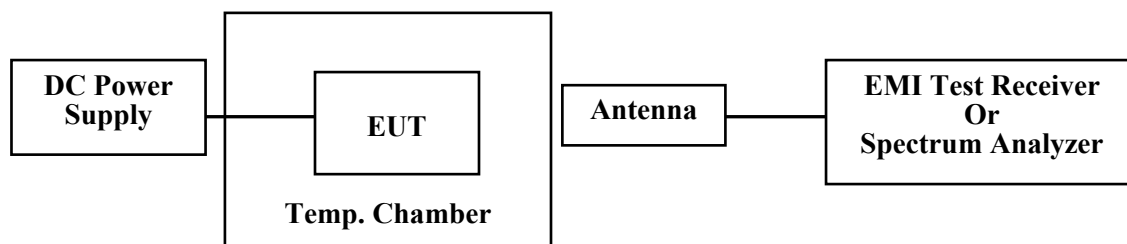

3.4.3 Test Procedure

According to ANSI C63.10-2013 Section 6.8

Frequency stability with respect to ambient temperature

- a) Supply the EUT with a nominal ac voltage or install a new or fully charged battery in the EUT. If possible, a dummy load shall be connected to the EUT because an antenna near the metallic walls of an environmental test chamber could affect the output frequency of the EUT. If the EUT is equipped with a permanently attached, adjustable-length antenna, then the EUT shall be placed in the center of the chamber with the antenna adjusted to the shortest length possible. Turn ON the EUT and tune it to one of the number of frequencies shown in 5.6.
- b) Couple the unlicensed wireless device output to the measuring instrument by connecting an antenna to the measuring instrument with a suitable length of coaxial cable and placing the measuring antenna near the EUT (e.g., 15 cm away), or by connecting a dummy load to the measuring instrument, through an attenuator if necessary.

NOTE—An instrument that has an adequate level of accuracy as specified by the procuring or regulatory agency is the recommended measuring instrument.

- c) Adjust the location of the measurement antenna and the controls on the measurement instrument to obtain a suitable signal level (i.e., a level that will not overload the measurement instrument but is strong enough to allow measurement of the operating or fundamental frequency of the EUT).
- d) Turn the EUT OFF and place it inside the environmental temperature chamber. For devices that have oscillator heaters, energize only the heater circuit.

- e) Set the temperature control on the chamber to the highest specified in the regulatory requirements for the type of device and allow the oscillator heater and the chamber temperature to stabilize.
- f) While maintaining a constant temperature inside the environmental chamber, turn the EUT ON and record the operating frequency at startup, and at 2 minutes, 5 minutes, and 10 minutes after the EUT is energized. Four measurements in total are made.
- g) Measure the frequency at each of frequencies specified in 5.6.
- h) Switch OFF the EUT but do not switch OFF the oscillator heater.
- i) Lower the chamber temperature by not more than 10 °C, and allow the temperature inside the chamber to stabilize.
- j) Repeat step f) through step i) down to the lowest specified temperature.

Frequency stability when varying supply voltage

Unless otherwise specified, these tests shall be made at ambient room temperature (+15 °C to +25 °C). An antenna shall be connected to the antenna output terminals of the EUT if possible. If the EUT is equipped with or uses an adjustable-length antenna, then it shall be fully extended.

- a) Supply the EUT with nominal voltage or install a new or fully charged battery in the EUT. Turn ON the EUT and couple its output to a frequency counter or other frequency-measuring instrument.
NOTE—An instrument that has an adequate level of accuracy as specified by the procuring or regulatory agency is the recommended measuring instrument.
- b) Tune the EUT to one of the number of frequencies required in 5.6. Adjust the location of the measurement antenna and the controls on the measurement instrument to obtain a suitable signal level (i.e., a level that will not overload the measurement instrument but is strong enough to allow measurement of the operating or fundamental frequency of the EUT).
- c) Measure the frequency at each of the frequencies specified in 5.6.
- d) Repeat the above procedure at 85% and 115% of the nominal supply voltage as described in 5.13.

3.5 Antenna Requirement

3.5.1 Applicable Standard

FCC §15.203

An intentional radiator shall be designed to ensure that no antenna other than that furnished by the responsible party shall be used with the device. The use of a permanently attached antenna or of an antenna that uses a unique coupling to the intentional radiator shall be considered sufficient to comply with the provisions of this section. The manufacturer may design the unit so that a broken antenna can be replaced by the user, but the user of a standard antenna jack or electrical connector is prohibited. The structure and application of the EUT were analyzed to determine compliance with section §15.203 of the rules. §15.203 state that the subject device must meet the following criteria:

- a. Antenna must be permanently attached to the unit.
- b. Antenna must use a unique type of connector to attach to the EUT.
- c. Unit must be professionally installed, and installer shall be responsible for verifying that the correct antenna is employed with the unit.

3.5.2 Judgment

Please refer to the Antenna Information detail in Section 1.

4. TEST DATA AND RESULTS

4.1 AC Line Conducted Emissions

Serial Number:	291M-1	Test Date:	2023/08/09
Test Site:	CE	Test Mode:	Transmitting
Tester:	David Huang	Test Result:	Pass

Environmental Conditions:

Temperature: (°C)	26.1	Relative Humidity: (%)	57	ATM Pressure: (kPa)	100.6
----------------------	------	---------------------------	----	---------------------------	-------

Test Equipment List and Details:

Manufacturer	Description	Model	Serial Number	Calibration Date	Calibration Due Date
R&S	LISN	ENV216	101134	2023/03/31	2024/03/30
R&S	EMI Test Receiver	ESR3	102726	2023/03/31	2024/03/30
MICRO-COAX	Coaxial Cable	UTIFLEX	C-0200-01	2023/08/06	2024/08/05
Audix	Test Software	E3	190306 (V9)	N/A	N/A

* Statement of Traceability: China Certification ICT Co., Ltd (Dongguan) attests that all calibrations have been performed, traceable to National Primary Standards and International System of Units (SI).

Test Mode: Transmitting
 Port: Line
 Note:

Date: 2023-08-09

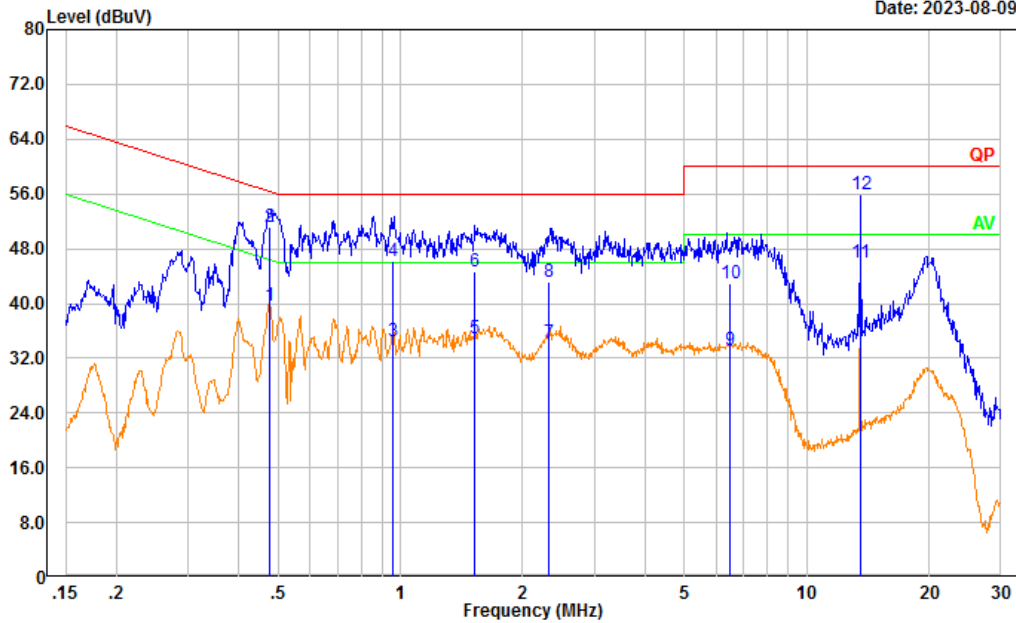

No.	Frequency (MHz)	Reading (dBμV)	Factor (dB)	Result (dBμV)	Limit (dBμV)	Margin (dB)	Detector
1	0.478	30.03	9.61	39.64	46.38	6.74	Average
2	0.478	41.56	9.61	51.17	56.38	5.21	QP
3	0.956	24.76	9.62	34.38	46.00	11.62	Average
4	0.956	36.60	9.62	46.22	56.00	9.78	QP
5	1.517	25.36	9.63	34.99	46.00	11.01	Average
6	1.517	35.12	9.63	44.75	56.00	11.25	QP
7	2.314	24.58	9.64	34.22	46.00	11.78	Average
8	2.314	33.51	9.64	43.15	56.00	12.85	QP
9	6.457	23.59	9.66	33.25	50.00	16.75	Average
10	6.457	33.16	9.66	42.82	60.00	17.18	QP
11	13.560	36.35	9.68	46.03	50.00	3.97	Average
12	13.560	46.23	9.68	55.91	60.00	4.09	QP

Test Mode: Transmitting
 Port: neutral
 Note:

Date: 2023-08-09

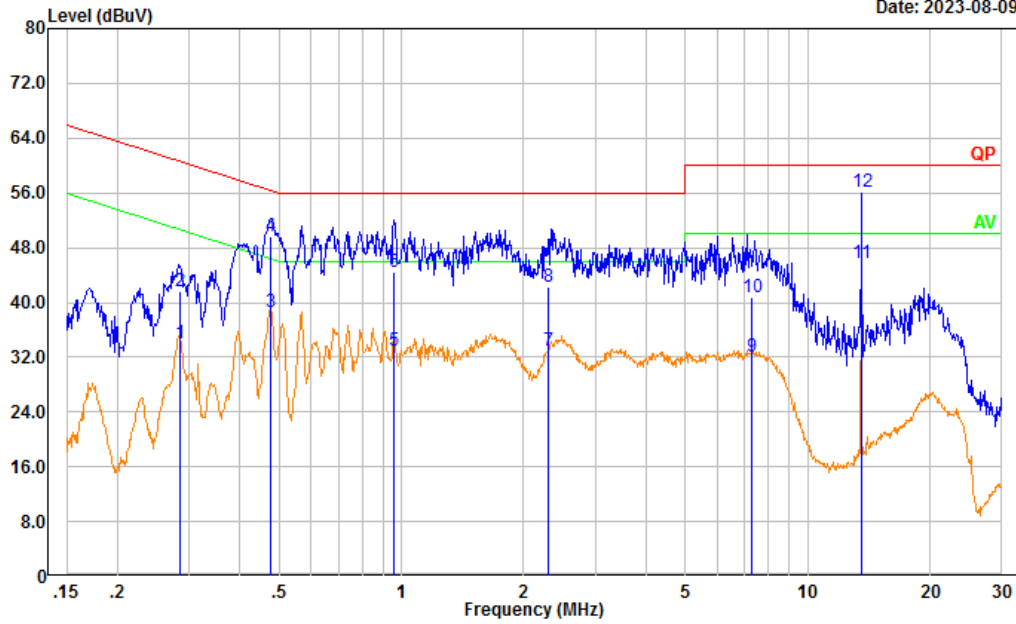

No.	Frequency (MHz)	Reading (dBμV)	Factor (dB)	Result (dBμV)	Limit (dBμV)	Margin (dB)	Detector
1	0.286	24.42	9.61	34.03	50.65	16.62	Average
2	0.286	32.00	9.61	41.61	60.65	19.04	QP
3	0.478	28.92	9.61	38.53	46.38	7.85	Average
4	0.478	40.13	9.61	49.74	56.38	6.64	QP
5	0.954	23.43	9.62	33.05	46.00	12.95	Average
6	0.954	34.81	9.62	44.43	56.00	11.57	QP
7	2.302	23.31	9.64	32.95	46.00	13.05	Average
8	2.302	32.54	9.64	42.18	56.00	13.82	QP
9	7.277	22.44	9.66	32.10	50.00	17.90	Average
10	7.277	31.17	9.66	40.83	60.00	19.17	QP
11	13.560	36.10	9.68	45.78	50.00	4.22	Average
12	13.560	46.44	9.68	56.12	60.00	3.88	QP

4.2 Radiation Spurious Emissions

Serial Number:	291M-1	Test Date:	2023/08/24
Test Site:	966-2	Test Mode:	Transmitting
Tester:	Carl Xue	Test Result:	Pass

Environmental Conditions:					
Temperature: (°C)	26.9	Relative Humidity: (%)	61	ATM Pressure: (kPa)	100.1

Test Equipment List and Details:

Manufacturer	Description	Model	Serial Number	Calibration Date	Calibration Due Date
EMCO	Passive Loop Antenna	6512	9706-1209	2023/02/15	2026/02/14
Sunol Sciences	Antenna	JB6	A082520-5	2020/10/19	2023/10/18
R&S	EMI Test Receiver	ESR3	102724	2023/03/31	2024/03/30
TIMES MICROWAVE	Coaxial Cable	LMR-600- UltraFlex	C-0470-02	2023/07/16	2024/07/15
TIMES MICROWAVE	Coaxial Cable	LMR-600- UltraFlex	C-0780-01	2023/07/16	2024/07/15
Sonoma	Amplifier	310N	186165	2023/07/16	2024/07/15
Audix	Test Software	E3	201021 (V9)	N/A	N/A

* Statement of Traceability: China Certification ICT Co., Ltd (Dongguan) attests that all calibrations have been performed, traceable to National Primary Standards and International System of Units (SI).

Test Data:

Please refer to the below table and plots.

After pre-scan in the X, Y and Z axes of orientation, the worst case is below:

9kHz~30MHz:

Parallel:

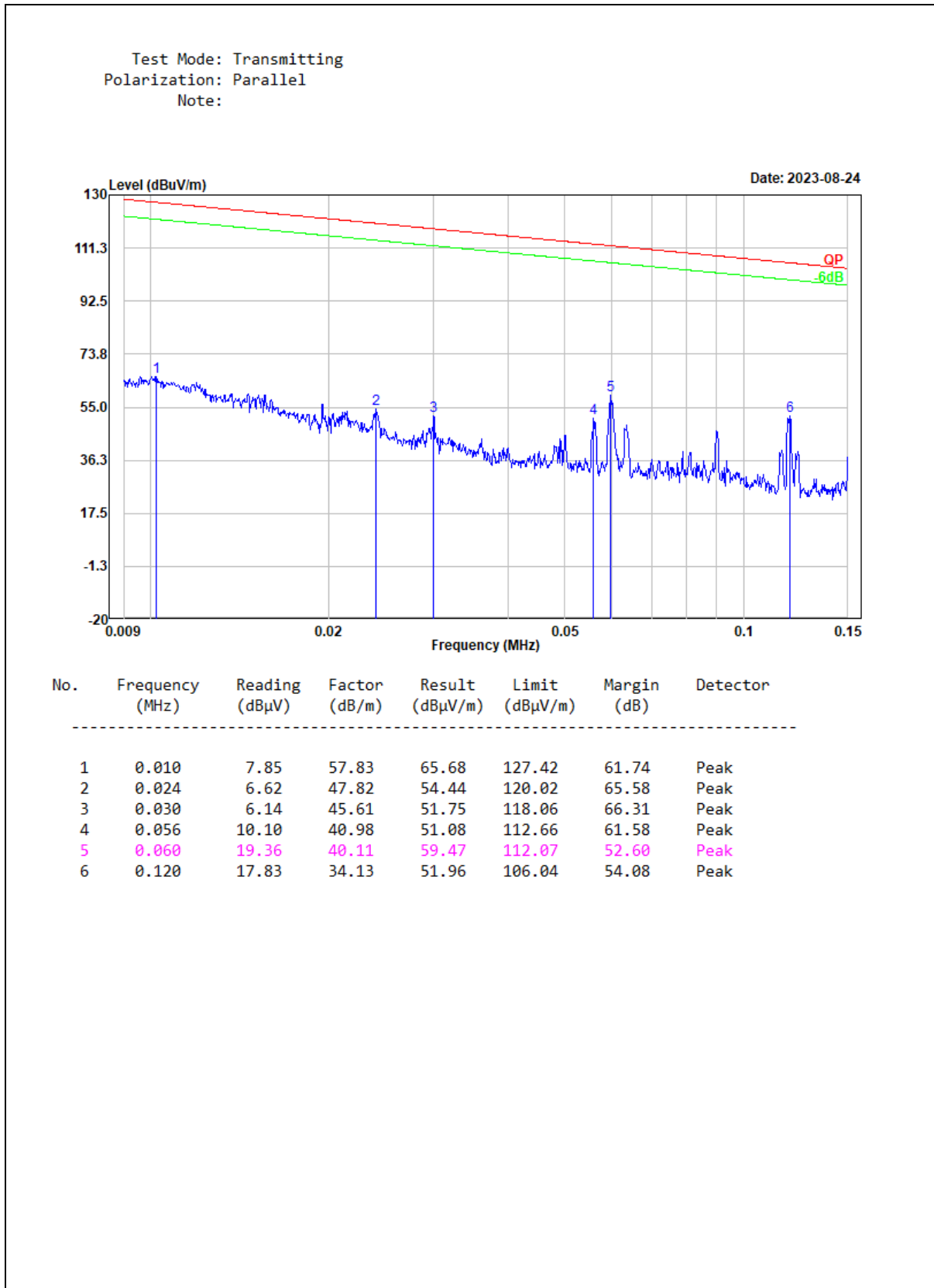

Test Mode: Transmitting
 Polarization: Parallel
 Note:

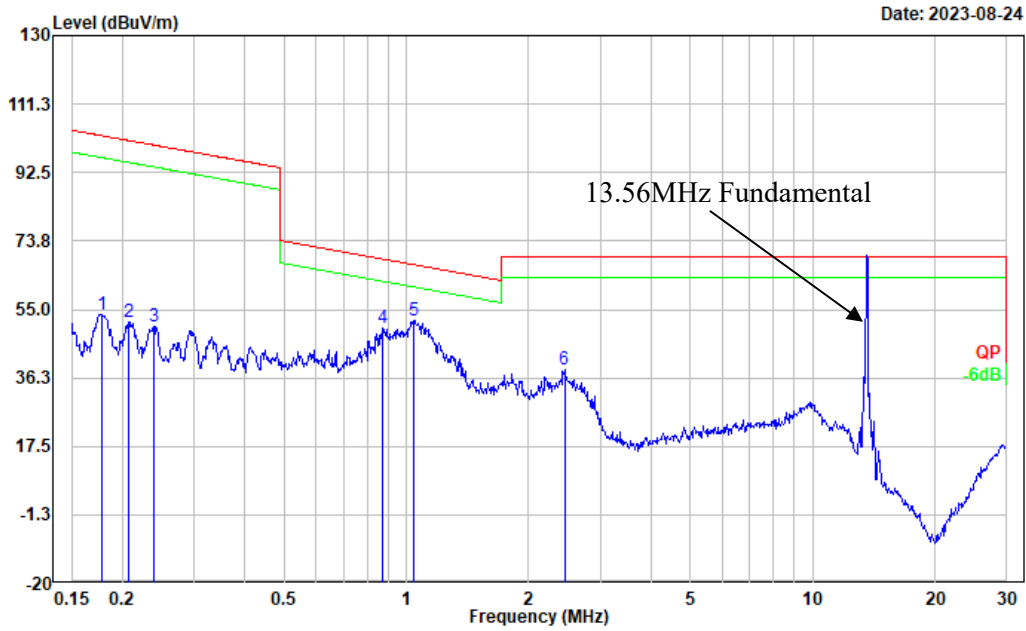

No.	Frequency (MHz)	Reading (dBμV)	Factor (dB/m)	Result (dBμV/m)	Limit (dBμV/m)	Margin (dB)	Detector
1	0.178	22.83	30.84	53.67	102.61	48.94	Peak
2	0.207	22.29	29.32	51.61	101.28	49.67	Peak
3	0.239	22.01	28.17	50.18	100.03	49.85	Peak
4	0.876	32.14	17.91	50.05	68.65	18.60	Peak
5	1.043	35.50	16.61	52.11	67.10	14.99	Peak
6	2.448	28.70	9.92	38.62	69.54	30.92	Peak

Test Mode: Transmitting
 Polarization: Parallel
 Note:

Date: 2023-08-24

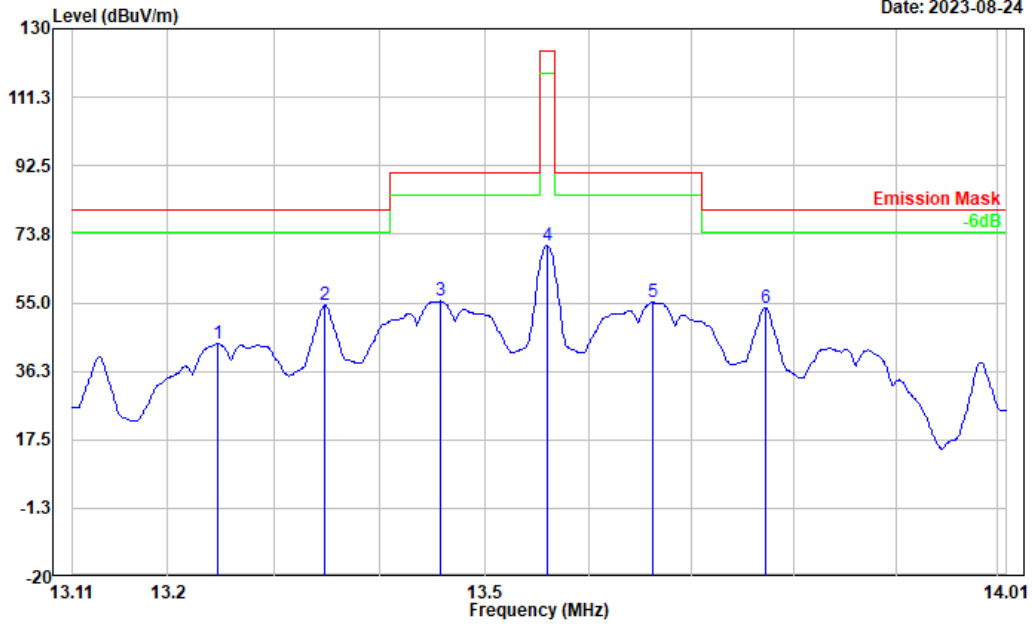

No.	Frequency (MHz)	Reading (dBμV)	Factor (dB/m)	Result (dBμV/m)	Limit (dBμV/m)	Margin (dB)	Detector
1	13.247	49.27	-5.45	43.82	80.51	36.69	Peak
2	13.348	60.01	-5.75	54.26	80.51	26.25	Peak
3	13.458	61.53	-6.09	55.44	90.47	35.03	Peak
4	13.560	77.18	-6.38	70.80	124.00	53.20	Peak
5	13.662	61.80	-6.69	55.11	90.47	35.36	Peak
6	13.772	60.77	-7.03	53.74	80.51	26.77	Peak

Perpendicular:

Test Mode: Transmitting
 Polarization: Perpendicular
 Note:

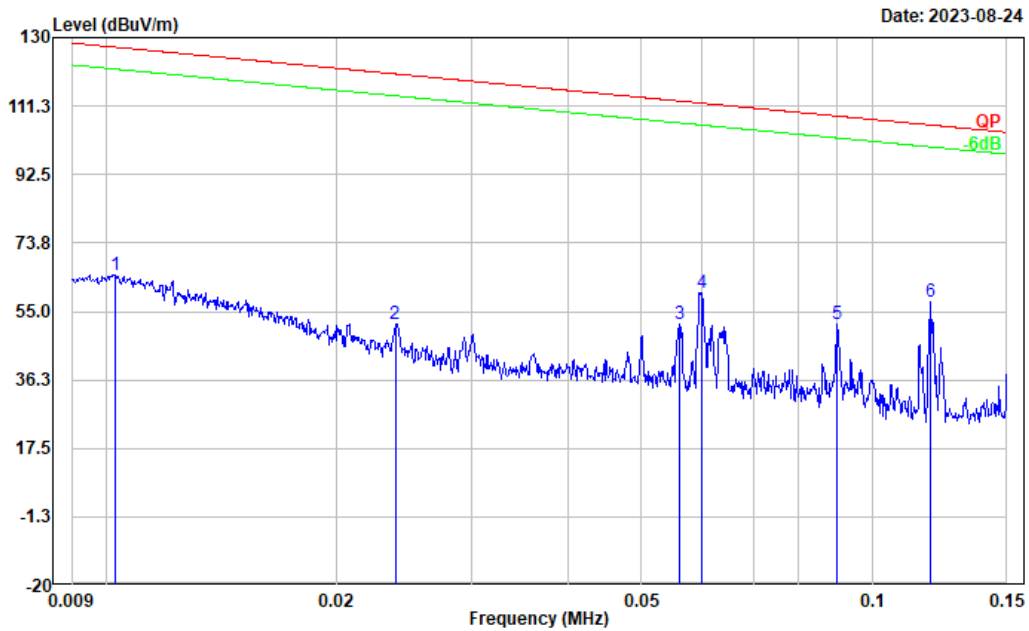

No.	Frequency (MHz)	Reading (dBμV)	Factor (dB/m)	Result (dBμV/m)	Limit (dBμV/m)	Margin (dB)	Detector
1	0.010	7.21	57.79	65.00	127.37	62.37	Peak
2	0.024	3.80	47.87	51.67	120.06	68.39	Peak
3	0.056	10.56	40.94	51.50	112.64	61.14	Peak
4	0.060	20.03	40.07	60.10	112.05	51.95	Peak
5	0.090	15.65	35.74	51.39	108.51	57.12	Peak
6	0.119	23.42	34.17	57.59	106.09	48.50	Peak

Test Mode: Transmitting
 Polarization: Perpendicular
 Note:

Date: 2023-08-24

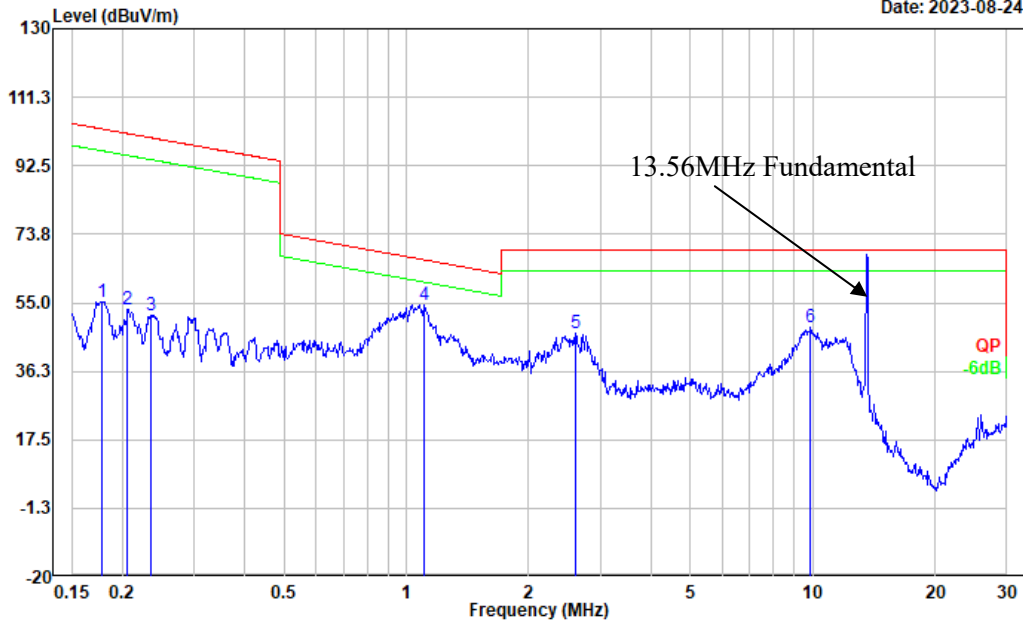

No.	Frequency (MHz)	Reading (dBμV)	Factor (dB/m)	Result (dBμV/m)	Limit (dBμV/m)	Margin (dB)	Detector
1	0.178	24.47	30.84	55.31	102.61	47.30	Peak
2	0.206	23.85	29.36	53.21	101.32	48.11	Peak
3	0.235	23.25	28.31	51.56	100.17	48.61	Peak
4	1.106	38.10	16.27	54.37	66.58	12.21	Peak
5	2.608	37.05	9.46	46.51	69.54	23.03	Peak
6	9.861	44.01	4.46	48.47	69.54	21.07	Peak

Test Mode: Transmitting
 Polarization: Perpendicular
 Note:

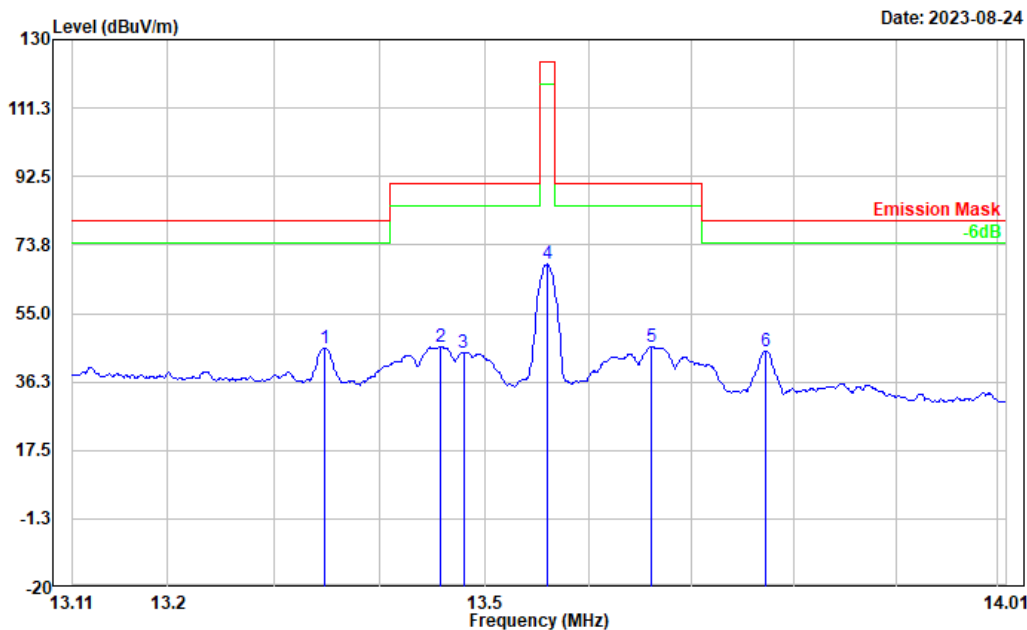

No.	Frequency (MHz)	Reading (dBμV)	Factor (dB/m)	Result (dBμV/m)	Limit (dBμV/m)	Margin (dB)	Detector
1	13.348	51.37	-5.75	45.62	80.51	34.89	Peak
2	13.458	51.81	-6.09	45.72	90.47	44.75	Peak
3	13.480	50.52	-6.16	44.36	90.47	46.11	Peak
4	13.560	74.85	-6.38	68.47	124.00	55.53	Peak
5	13.661	52.72	-6.69	46.03	90.47	44.44	Peak
6	13.772	51.86	-7.03	44.83	80.51	35.68	Peak

Ground-parallel:

Test Mode: Transmitting
 Polarization: Ground-parallel
 Note:

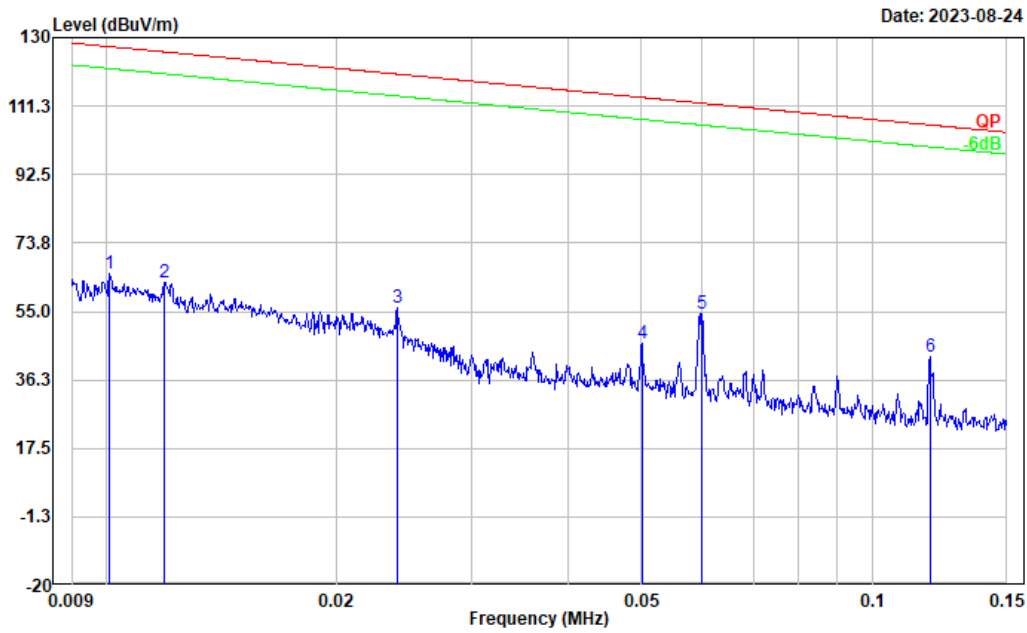

No.	Frequency (MHz)	Reading (dBμV)	Factor (dB/m)	Result (dBμV/m)	Limit (dBμV/m)	Margin (dB)	Detector
1	0.010	7.30	57.94	65.24	127.52	62.28	Peak
2	0.012	6.50	56.37	62.87	126.10	63.23	Peak
3	0.024	8.03	47.82	55.85	120.02	64.17	Peak
4	0.050	4.02	42.26	46.28	113.61	67.33	Peak
5	0.060	14.34	40.07	54.41	112.05	57.64	Peak
6	0.119	8.48	34.17	42.65	106.09	63.44	Peak

Test Mode: Transmitting
 Polarization: Ground-parallel
 Note:

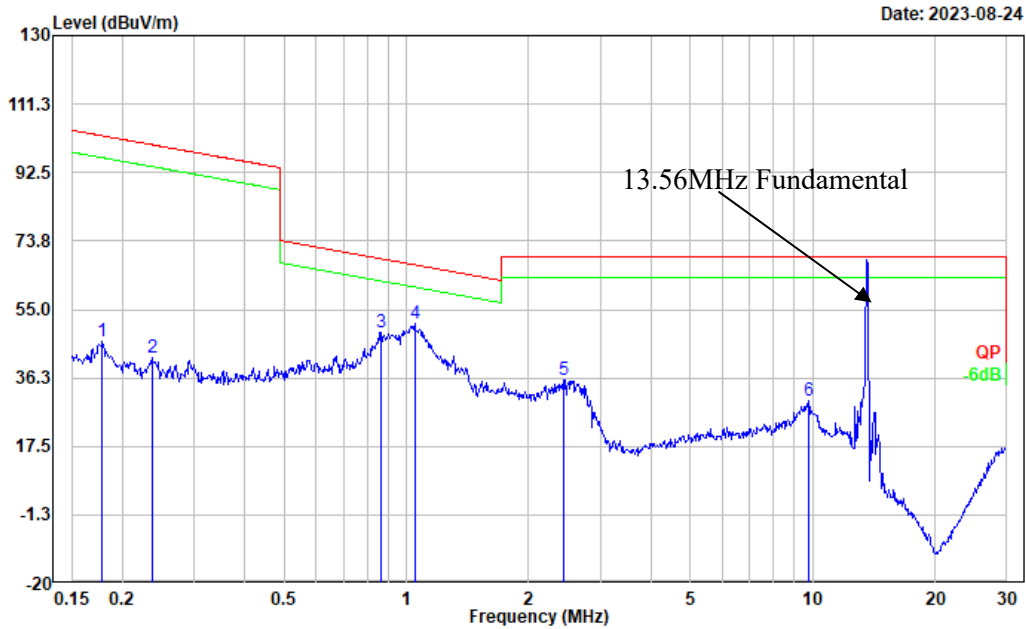

No.	Frequency (MHz)	Reading (dBμV)	Factor (dB/m)	Result (dBμV/m)	Limit (dBμV/m)	Margin (dB)	Detector
1	0.179	15.41	30.79	46.20	102.56	56.36	Peak
2	0.237	13.35	28.26	41.61	100.12	58.51	Peak
3	0.866	30.86	17.96	48.82	68.74	19.92	Peak
4	1.049	34.44	16.58	51.02	67.05	16.03	Peak
5	2.435	25.58	9.96	35.54	69.54	34.00	Peak

Test Mode: Transmitting
 Polarization: Ground-parallel
 Note:

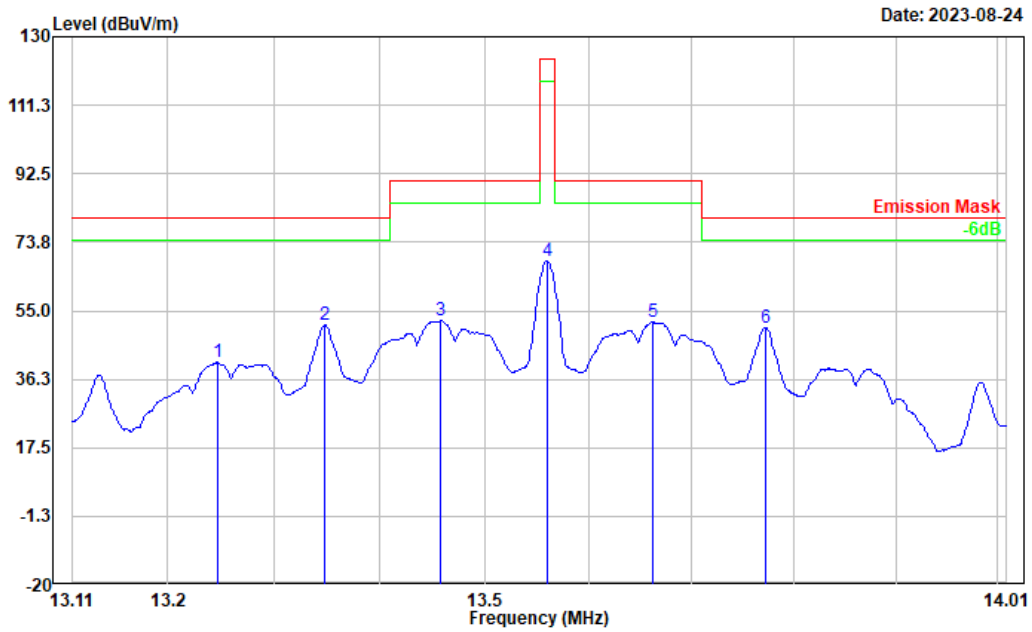

No.	Frequency (MHz)	Reading (dB μ V)	Factor (dB/m)	Result (dB μ V/m)	Limit (dB μ V/m)	Margin (dB)	Detector
1	13.247	46.25	-5.45	40.80	80.51	39.71	Peak
2	13.348	56.79	-5.75	51.04	80.51	29.47	Peak
3	13.458	58.27	-6.09	52.18	90.47	38.29	Peak
4	13.560	74.97	-6.38	68.59	124.00	55.41	Peak
5	13.662	58.53	-6.69	51.84	90.47	38.63	Peak
6	13.772	57.55	-7.03	50.52	80.51	29.99	Peak

1) 30MHz-1GHz:

Test Mode: Transmitting
 Polarization: horizontal
 Note:

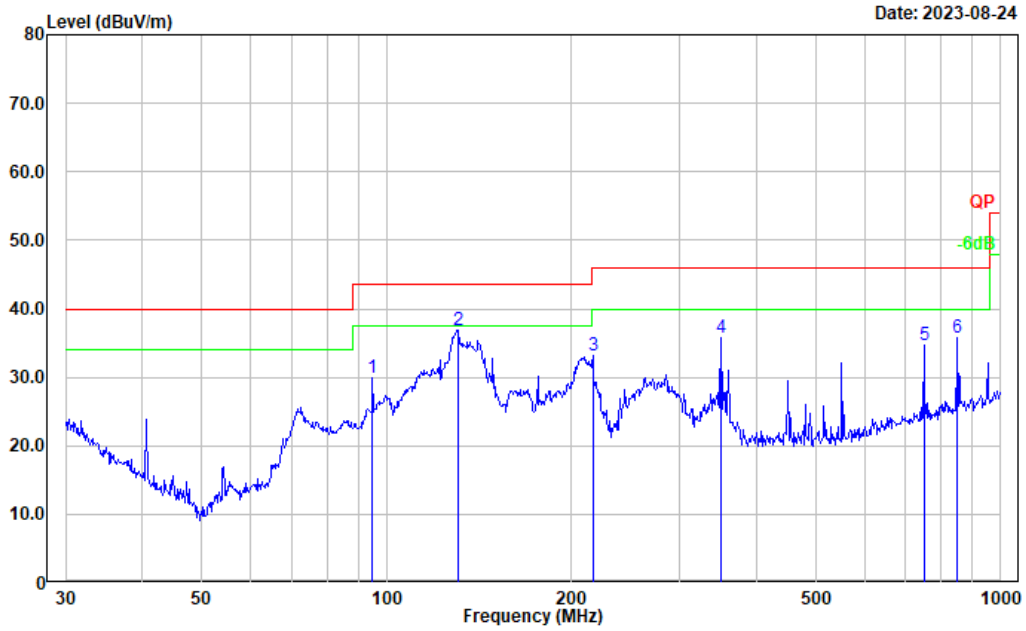

No.	Frequency (MHz)	Reading (dB μ V)	Factor (dB/m)	Result (dB μ V/m)	Limit (dB μ V/m)	Margin (dB)	Detector
1	94.760	45.70	-15.69	30.01	43.50	13.49	Peak
2	130.837	48.29	-11.33	36.96	43.50	6.54	Peak
3	216.783	45.76	-12.68	33.08	46.00	12.92	Peak
4	350.477	45.73	-10.03	35.70	46.00	10.30	Peak
5	750.108	37.64	-3.00	34.64	46.00	11.36	Peak
6	851.035	37.28	-1.47	35.81	46.00	10.19	Peak

Test Mode: Transmitting
 Polarization: vertical
 Note:

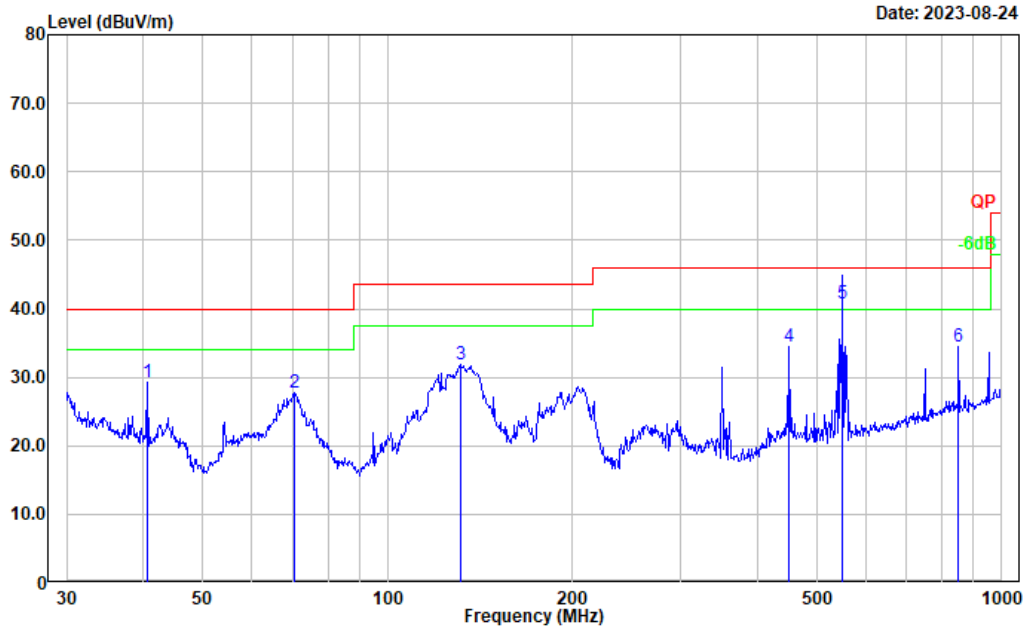

No.	Frequency (MHz)	Reading (dBμV)	Factor (dB/m)	Result (dBμV/m)	Limit (dBμV/m)	Margin (dB)	Detector
1	40.559	40.92	-11.65	29.27	40.00	10.73	Peak
2	70.337	44.15	-16.50	27.65	40.00	12.35	Peak
3	131.758	43.35	-11.39	31.96	43.50	11.54	Peak
4	451.135	41.42	-6.91	34.51	46.00	11.49	Peak
5	549.957	46.61	-5.75	40.86	46.00	5.14	QP
6	851.035	36.03	-1.47	34.56	46.00	11.44	Peak

4.3 20 dB Emission Bandwidth

Serial Number:	291M-1	Test Date:	2023/08/24
Test Site:	966-2	Test Mode:	Transmitting
Tester:	Carl Xue	Test Result:	Pass

Environmental Conditions:

Temperature: (°C)	26.9	Relative Humidity: (%)	61	ATM Pressure: (kPa)	100.1
----------------------	------	---------------------------	----	---------------------------	-------

Test Equipment List and Details:

Manufacturer	Description	Model	Serial Number	Calibration Date	Calibration Due Date
EMCO	Passive Loop Antenna	6512	9706-1209	2023/02/15	2026/02/14
R&S	EMI Test Receiver	ESR3	102724	2023/03/31	2024/03/30
TIMES MICROWAVE	Coaxial Cable	LMR-600-UltraFlex	C-0470-02	2023/07/16	2024/07/15
TIMES MICROWAVE	Coaxial Cable	LMR-600-UltraFlex	C-0780-01	2023/07/16	2024/07/15

** Statement of Traceability: China Certification ICT Co., Ltd (Dongguan) attests that all calibrations have been performed, traceable to National Primary Standards and International System of Units (SI).*

Test Data:

Test Frequency (MHz)	20 dB Emission Bandwidth (Hz)
13.56	769

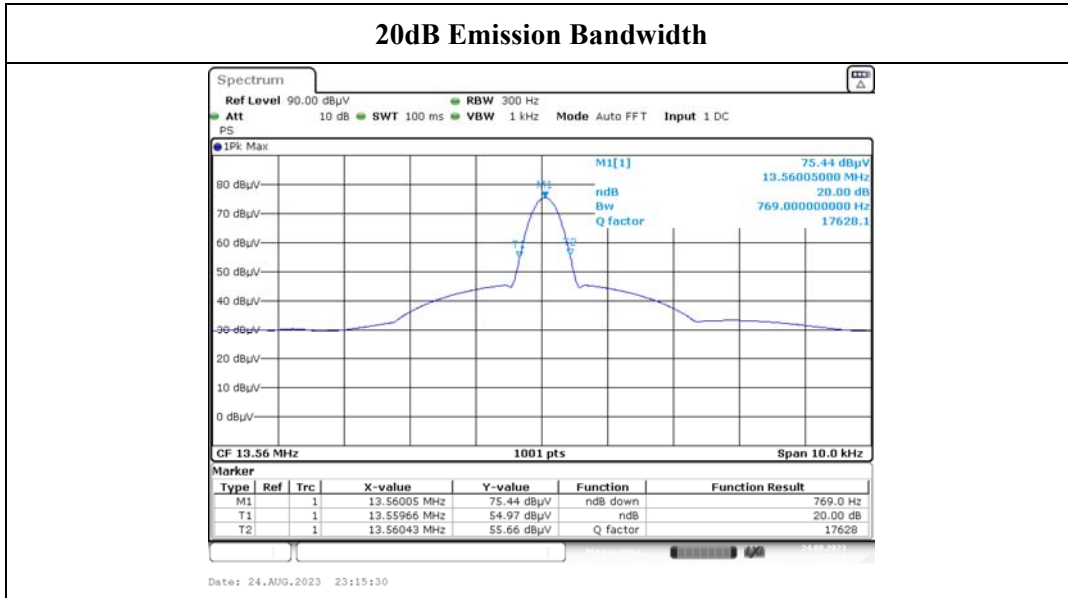

4.4 Frequency Stability

Serial Number:	291M-1	Test Date:	2023/08/24
Test Site:	RF	Test Mode:	Transmitting
Tester:	Carl Xue	Test Result:	Pass

Environmental Conditions:

Temperature: (°C)	26.9	Relative Humidity: (%)	61	ATM Pressure: (kPa)	100.1
----------------------	------	---------------------------	----	---------------------------	-------

Test Equipment List and Details:

Manufacturer	Description	Model	Serial Number	Calibration Date	Calibration Due Date
EMCO	Passive Loop Antenna	6512	9706-1209	2023/02/15	2026/02/14
R&S	EMI Test Receiver	ESR3	102724	2023/03/31	2024/03/30
BACL	TEMP&HUMI Test Chamber	BTH-150-40	30174	2023/03/31	2024/03/30
YINSAIGE	Coaxial Cable	SS402	SJ0300001	Each time	N/A
UNI-T	Multimeter	UT39A+	C210582554	2022/09/29	2023/09/28
ZHAOXIN	DC Power Supply	RXN-6010D	21R6010D0912386	N/A	N/A

* **Statement of Traceability:** China Certification ICT Co., Ltd (Dongguan) attests that all calibrations have been performed, traceable to National Primary Standards and International System of Units (SI).

Test Data:

$f_0 = 13.56$ MHz				
Temperature	Voltage	Measured frequency	Frequency Error	Limit
°C	V _{DC}	MHz	Hz	Hz
-20	3.8	13.560152	152	±1356
-10		13.560073	73	±1356
0		13.560126	126	±1356
10		13.560082	82	±1356
20		13.560050	50	±1356
25		13.560097	97	±1356
30		13.560110	110	±1356
40		13.560016	16	±1356
50		13.560172	172	±1356
20		3.55	13.560108	108
20	4.35	13.560143	143	±1356

5. RF EXPOSURE EVALUATION

Applicable Standard

According to KDB447498 D01 General RF Exposure Guidance v06: 4.3. General SAR test exclusion guidance

c) For frequencies below 100 MHz, the following may be considered for SAR test exclusion (also illustrated in Appendix C):

- 1) For *test separation distances* > 50 mm and < 200 mm, the power threshold at the corresponding test separation distance at 100 MHz in step b) is multiplied by $[1 + \log(100/f_{\text{(MHz)}})]$
- 2) For *test separation distances* ≤ 50 mm, the power threshold determined by the equation in c) 1) for 50 mm and 100 MHz is multiplied by $\frac{1}{2}$
- 3) SAR measurement procedures are not established below 100 MHz

Measurement Result:

For NFC, the power of EUT: E Field@3m is 70.8dBuV/m = -24.4 dBm(0.004mW)

Note: $E[\text{dB}\mu\text{V}/\text{m}] = \text{EIRP}[\text{dBm}] + 95.2$ for $d = 3$ m.

SAR test exclusion threshold for NFC(13.56MHz) separation distance < 50 mm

$$=[474*(1 + \log(100/f_{\text{(MHz)}}))]/2$$

$$= 443\text{mW}$$

$$> 0.004\text{mW}$$

Result: Compliant.

6. EUT PHOTOGRAPHS

Please refer to the attachment CR230743871-EXP EUT EXTERNAL PHOTOGRAPHS and
CR230743871-INP EUT INTERNAL PHOTOGRAPHS

7. TEST SETUP PHOTOGRAPHS

Please refer to the attachment CR230743871-00C-TSP TEST SETUP PHOTOGRAPHS.

===== END OF REPORT =====