

TEST REPORT

Applicant: Shenzhen Tinno Mobile Technology Corp
Address: 27-001, South side of Tianlong mobile HQ Building,
Tongfa South Road, Xili Street, Nanshan District,
Shenzhen, Guangdong Province, 518000, China
Equipment Type: onn. 8" Tablet
Model Name: TBVAN100135923 (refer to section 2.3)
Brand Name: onn.
FCC ID: XD6WM2308T
Test Standard: 47 CFR Part 15 Subpart C (refer to section 3.1)
Sample Arrival Date: Jan. 03, 2024
Test Date: Jan. 05, 2024 - Jan. 16, 2024
Date of Issue: Jan. 24, 2024

ISSUED BY:

Shenzhen BALUN Technology Co., Ltd.

Tested by: Si Xiao

Checked by: Ye Hongji

Approved by: Liao Jianming
(Technical Director)

Si Xiao

Ye Hongji

Liao Jianming

Revision History		
Version	Issue Date	Revisions
<u>Rev. 01</u>	<u>Jan. 24, 2024</u>	<u>Initial Issue</u>

TABLE OF CONTENTS

1	GENERAL INFORMATION	4
1.1	Test Laboratory	4
1.2	Test Location	4
2	PRODUCT INFORMATION	5
2.1	Applicant Information	5
2.2	Manufacturer Information	5
2.3	General Description for Equipment under Test (EUT)	5
2.4	Technical Information	6
3	SUMMARY OF TEST RESULTS	8
3.1	Test Standards	8
3.2	Test Verdict	9
4	GENERAL TEST CONFIGURATIONS	10
4.1	Test Environments	10
4.2	Test Equipment List	10
4.3	Test Software List	11
4.4	Measurement Uncertainty	12
4.5	Description of Test Setup	12
4.6	Measurement Results Explanation Example	15
5	TEST ITEMS	16
5.1	Antenna Requirements	16
5.2	Frequency Hopping Systems	17
5.3	Number of Hopping Frequencies	19
5.4	Peak Output Power	20
5.5	Occupied Bandwidth	21

5.6	Carrier Frequency Separation	22
5.7	Time of Occupancy (Dwell time)	23
5.8	Conducted Spurious Emission & Authorized-band band-edge	25
5.9	Conducted Emission	26
5.10	Radiated Spurious Emission	27
5.11	Band Edge (Restricted-band band-edge).....	29
ANNEX A	TEST RESULT	30
A.1	Number of Hopping Frequency	30
A.2	Peak Output Power	31
A.3	20 dB and 99% bandwidth	34
A.4	Hopping Frequency Separation.....	39
A.5	Average Time of Occupancy	40
A.6	Conducted Spurious Emissions & Authorized-band band-edge	43
A.7	Conducted Emissions.....	50
A.8	Radiated Spurious Emission	52
A.9	Band Edge (Restricted-band band-edge).....	66
ANNEX B	TEST SETUP PHOTOS	70
ANNEX C	EUT EXTERNAL PHOTOS	70
ANNEX D	EUT INTERNAL PHOTOS	70

1 GENERAL INFORMATION

1.1 Test Laboratory

Name	Shenzhen BALUN Technology Co., Ltd.
Address	Block B, 1/F, Baisha Science and Technology Park, Shahe Xi Road, Nanshan District, Shenzhen, Guangdong Province, P. R. China
Phone Number	+86 755 6685 0100

1.2 Test Location

Name	Shenzhen BALUN Technology Co., Ltd.
Location	<input checked="" type="checkbox"/> Block B, 1/F, Baisha Science and Technology Park, Shahe Xi Road, Nanshan District, Shenzhen, Guangdong Province, P. R. China
	<input type="checkbox"/> 1/F, Building B, Ganghongji High-tech Intelligent Industrial Park, No. 1008, Songbai Road, Yangguang Community, Xili Sub-district, Nanshan District, Shenzhen, Guangdong Province, P. R. China
Accreditation Certificate	The laboratory is a testing organization accredited by FCC as a accredited testing laboratory. The designation number is CN1196.

2 PRODUCT INFORMATION

2.1 Applicant Information

Applicant	Shenzhen Tinno Mobile Technology Corp
Address	27-001, South side of Tianlong mobile HQ Building, Tongfa South Road, Xili Street, Nanshan District, Shenzhen, Guangdong Province, 518000, China

2.2 Manufacturer Information

Manufacturer	Shenzhen Tinno Mobile Technology Corp
Address	27-001, South side of Tianlong mobile HQ Building, Tongfa South Road, Xili Street, Nanshan District, Shenzhen, Guangdong Province, 518000, China

2.3 General Description for Equipment under Test (EUT)

EUT Name	onn. 8" Tablet
Model Name Under Test	TBVAN100135923
Series Model Name	TBPPY100135923, TBLVD100135923, TBIND100135923
Description of Model name differentiation	All models are same with electrical parameters and internal circuit structure, but only differ in model name and color. (this information provided by the applicant)
Hardware Version	V1.0
Software Version	T302AA_DVT_14.0_64B_FTM_07.00_00
Dimensions (Approx.)	N/A
Weight (Approx.)	N/A

2.4 Technical Information

Network and Wireless connectivity	Bluetooth (BR+EDR+BLE) 2.4G WIFI 802.11b, 802.11g, 802.11n(HT20) 5G WIFI 802.11a, 802.11n(HT20/40), 802.11ac (VHT20/40/80) U-NII-1/2A/2C/3, GPS
-----------------------------------	--

The requirement for the following technical information of the EUT was tested in this report:

Modulation Technology	FHSS
Modulation Type	GFSK, $\pi/4$ -DQPSK, 8-DPSK
Product Type	<input type="checkbox"/> Mobile <input checked="" type="checkbox"/> Portable <input type="checkbox"/> Fix Location
Transfer Rate	DH5: 1 Mbps 2DH5: 2 Mbps 3DH5: 3 Mbps
Frequency Range	The frequency range used is 2400 MHz to 2483.5 MHz.
Number of Channel	79 (at intervals of 1 MHz)
Tested Channel	0 (2402 MHz), 39 (2441 MHz), 78 (2480 MHz)
Antenna Type	IFA Antenna
Antenna Gain	-2.6 dBi
Antenna Impedance	50 Ω
Antenna System (MIMO Smart Antenna)	N/A

All channel was listed on the following table:

Channel number	Freq. (MHz)	Channel number	Freq. (MHz)	Channel number	Freq. (MHz)	Channel number	Freq. (MHz)
0	2402	21	2423	42	2444	63	2465
1	2403	22	2424	43	2445	64	2466
2	2404	23	2425	44	2446	65	2467
3	2405	24	2426	45	2447	66	2468
4	2406	25	2427	46	2448	67	2469
5	2407	26	2428	47	2449	68	2470
6	2408	27	2429	48	2450	69	2471
7	2409	28	2430	49	2451	70	2472
8	2410	29	2431	50	2452	71	2473
9	2411	30	2432	51	2453	72	2474
10	2412	31	2433	52	2454	73	2475
11	2413	32	2434	53	2455	74	2476
12	2414	33	2435	54	2456	75	2477
13	2415	34	2436	55	2457	76	2478
14	2416	35	2437	56	2458	77	2479
15	2417	36	2438	57	2459	78	2480
16	2418	37	2439	58	2460	-	-
17	2419	38	2440	59	2461	-	-
18	2420	39	2441	60	2462	-	-
19	2421	40	2442	61	2463	-	-
20	2422	41	2443	62	2464	-	-

3 SUMMARY OF TEST RESULTS

3.1 Test Standards

No.	Identity	Document Title
1	47 CFR Part 15, Subpart C	Intentional radiators of radio frequency equipment
2	ANSI C63.10-2013	American National Standard for Testing Unlicensed Wireless Devices
3	KDB 558074 D01 15.247 Meas Guidance v05r02	Guidance for compliance measurements on digital transmission system, frequency hopping spread spectrum system, and hybrid system devices operating under section 15.247 of the FCC rules

3.2 Test Verdict

No.	Description	FCC Part No.	Channel	Test Result	Verdict	Remark
1	Antenna Requirement	15.203	N/A	--	Pass	Note ¹
2	Number of Hopping Frequencies	15.247(a)	Hopping Mode	ANNEX A.1	Pass	Note ²
3	Peak Output Power	15.247(b)	Low/Middle/High	ANNEX A.2	Pass	--
4	Occupied Bandwidth	15.247(a)	Low/Middle/High	ANNEX A.3	Pass	--
5	Carrier Frequency Separation	15.247(a)	Hopping Mode	ANNEX A.4	Pass	Note ²
6	Time of Occupancy (Dwell time)	15.247(a)	Hopping Mode	ANNEX A.5	Pass	Note ²
7	Conducted Spurious Emission & Authorized-band band-edge	15.247(d)	Hopping Mode; Low/Middle/High	ANNEX A.6	Pass	Note ²
8	Conducted Emission	15.207	Low/Middle/High	ANNEX A.7	Pass	Note ²
9	Radiated Spurious Emission	15.209 15.247(d)	Low/Middle/High	ANNEX A.8	Pass	Note ²
10	Band Edge(Restricted-band band-edge)	15.209 15.247(d)	Low/High	ANNEX A.9	Pass	Note ²

Note ¹: The EUT has a permanently and irreplaceable attached antenna, which complies with the requirement FCC 15.203.

Note ²: $\pi/4$ -DQPSK is the EDR 2M rate mode, 8-DPSK is the EDR 3M rate mode. The consistency of test results in $\pi/4$ -DQPSK and 8-DPSK is very high. So we chose 8-DPSK as a typical representative to appear on the report. Another we will show all the modes on the RF output power test item.

4 GENERAL TEST CONFIGURATIONS

4.1 Test Environments

During the measurement, the normal environmental conditions were within the listed ranges:

Relative Humidity	48% to 64%	
Atmospheric Pressure	100 kPa to 102 kPa	
Temperature	NT (Normal Temperature)	+20.8°C to +24.3°C
Working Voltage of the EUT	NV (Normal Voltage)	3.8 V

4.2 Test Equipment List

Description	Manufacturer	Model	Serial No.	Cal. Date	Cal. Due
Spectrum Analyzer	KEYSIGHT	N9020A	MY46471071	2023.07.25	2024.07.24
Signaling Unit	ROHDE&SCHWARZ	CMW500	142028	2023.05.16	2024.05.15
Spectrum Analyzer	KEYSIGHT	N9020A	MY50531259	2023.09.05	2024.09.04
Signaling Unit	ROHDE&SCHWARZ	CMW500	171150	2023.06.19	2024.06.18
Test Antenna-Horn	SCHWARZBECK	BBHA 9120D	02460	2021.05.20	2024.05.19
Test Antenna-Horn	A-INFO	LB- 180400KF	J211060273	2021.07.02	2024.07.01
Anechoic Chamber	RAINFORD	9m*6m*6m	140	2022.02.19	2024.08.15
Amplifier	COM-MV	LSCX_LNA 1-12G-01	7210214	2023.09.05	2024.09.04
Amplifier	COM-MV	XKu_LNA7- 18G-01	7210209	2023.09.05	2024.09.04
Amplifier	COM-MV	KA LNA18 40G-01	18050001	2023.12.06	2024.12.05
EMI Receiver	Agilent	N9038A	MY55330120	2023.09.05	2024.09.04
Test Antenna-Bi-Log	SCHWARZBECK	VULB 9168	9168-00867	2022.04.12	2025.04.11
Amplifier	COM-MV	ZT30- 1000M	B2017119081	2023.12.05	2024.12.04
Anechoic Chamber	YiHeng	9m*6m*6m	142	2021.08.19	2024.08.18
EMI Receiver	KEYSIGHT	N9010B	MY57110309	2023.09.05	2024.09.04
LISN	SCHWARZBECK	NSLK 8127	8127-687	2023.05.16	2024.05.15
Shielded Enclosure	YiHeng Electronic Co., Ltd	3.5m*3.1m* 2.8m	112	2022.02.19	2025.02.18
EMI Receiver	ROHDE&SCHWARZ	ESRP	101036	2023.09.05	2024.09.04
Test Antenna-Bi-Log	SCHWARZBECK	VULB 9168	9168-01162	2023.08.04	2024.08.03
Test Antenna-Loop	SCHWARZBECK	FMZB 1519	1519-037	2021.04.16	2024.04.15
Amplifier	COM-MV	ZT30- 1000M	B2018054558	2023.12.05	2024.12.04
Anechoic Chamber	EMC Electronic Co., Ltd	20.10*11.60 *7.35m	130	2021.08.15	2024.08.14

4.3 Test Software List

Description	Manufacturer	Software Version	Serial No.	Applicable test Setup
BL410R	BALUN	V2.1.1.488	N/A	The section 4.5.1
BL410E	BALUN	V22.930	N/A	The section 4.5.2&4.5.3&4.5.4&4.5.5

4.4 Measurement Uncertainty

The following measurement uncertainty levels have been estimated for tests performed on the EUT as specified in CISPR 16-4-2.

This uncertainty represents an expanded uncertainty expressed at approximately the 95% confidence level using a coverage factor of k=2.

Parameters	Uncertainty
Occupied Channel Bandwidth	2.8%
RF output power, conducted	1.28 dB
Power Spectral Density, conducted	1.30 dB
Unwanted Emissions, conducted	1.84 dB
All emissions, radiated	5.36 dB
Temperature	0.8°C
Humidity	4%

4.5 Description of Test Setup

4.5.1 For Antenna Port Test

$$\text{Conducted value (dBm)} = \text{Measurement value (dBm)} + \text{cable loss (dB)}$$

For example: the measurement value is 10 dBm and the cable 0.5dBm used, then the final result of EUT:

$$\text{Conducted value (dBm)} = 10 \text{ dBm} + 0.5 \text{ dB} = 10.5 \text{ dBm}$$

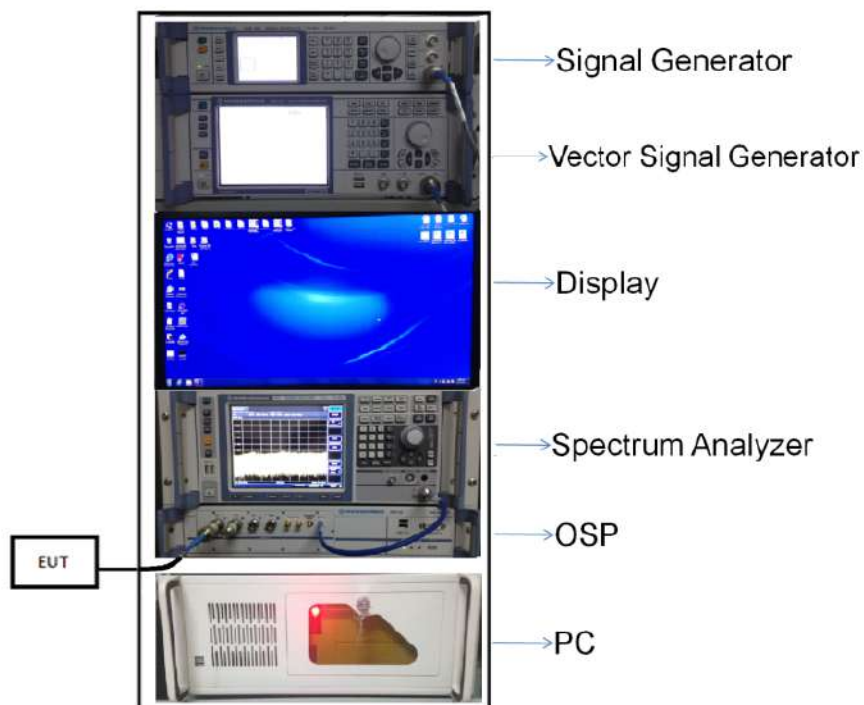

(Diagram 1)

4.5.2 For AC Power Supply Port Test

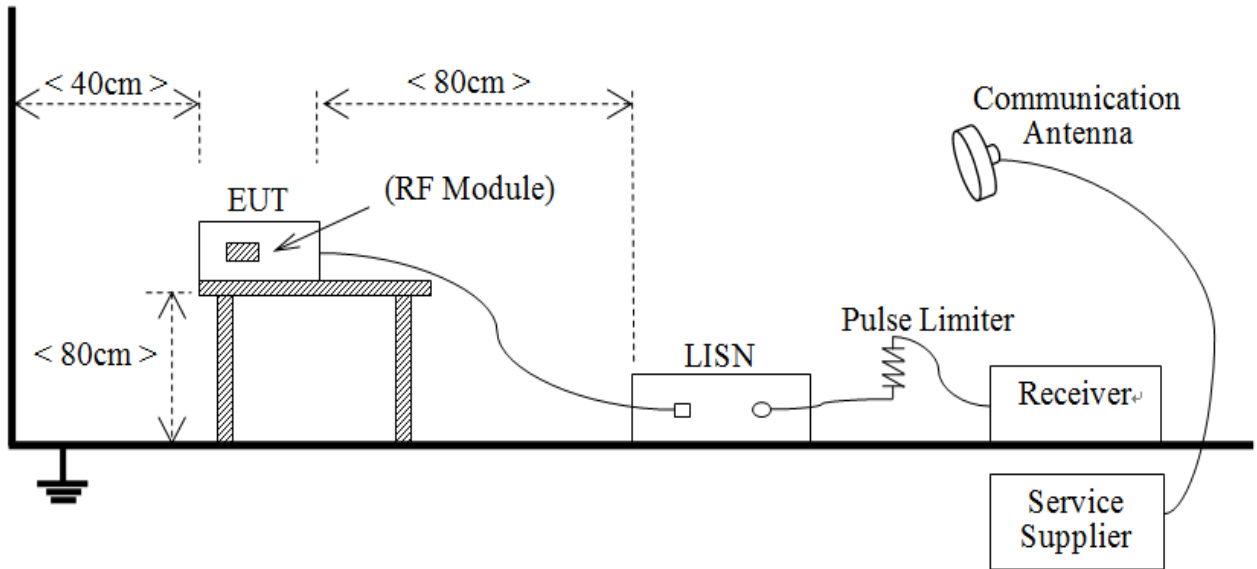

(Diagram 2)

4.5.3 For Radiated Test (Below 30 MHz)

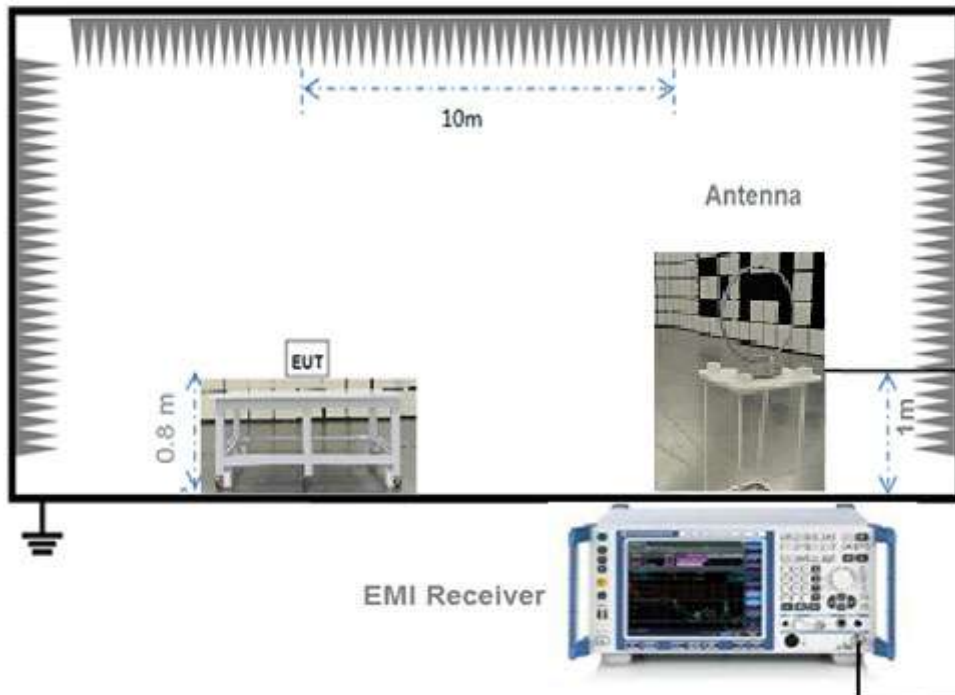

(Diagram 3)

4.5.4 For Radiated Test (30 MHz-1 GHz)

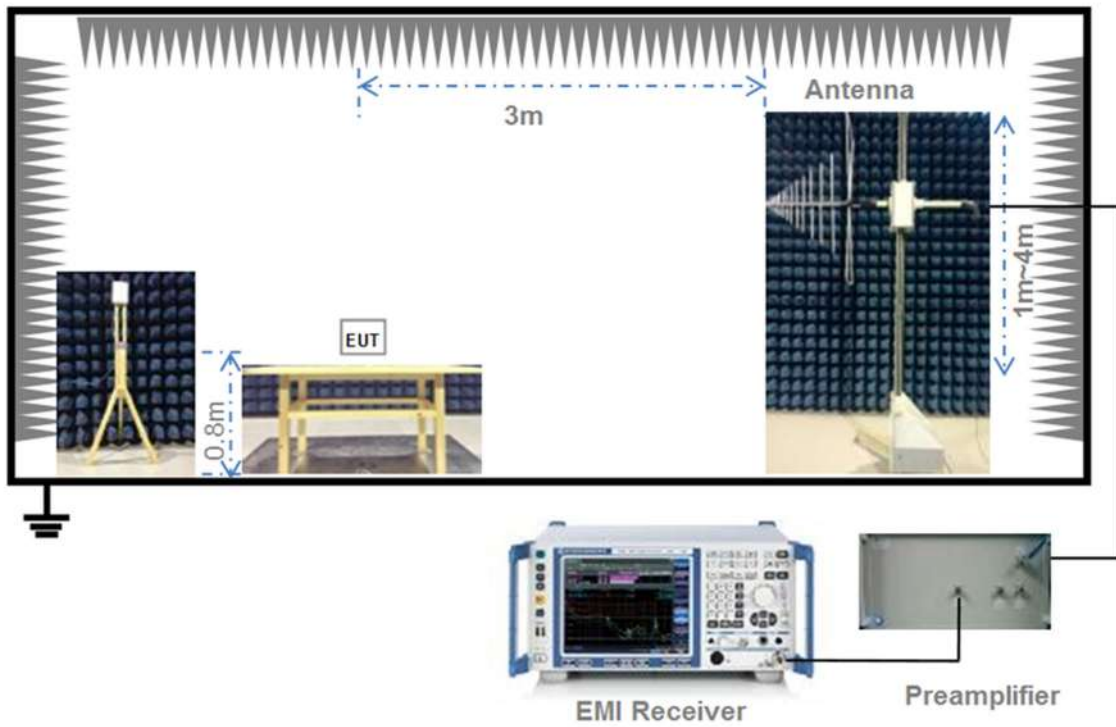

(Diagram 4)

4.5.5 For Radiated Test (Above 1 GHz)

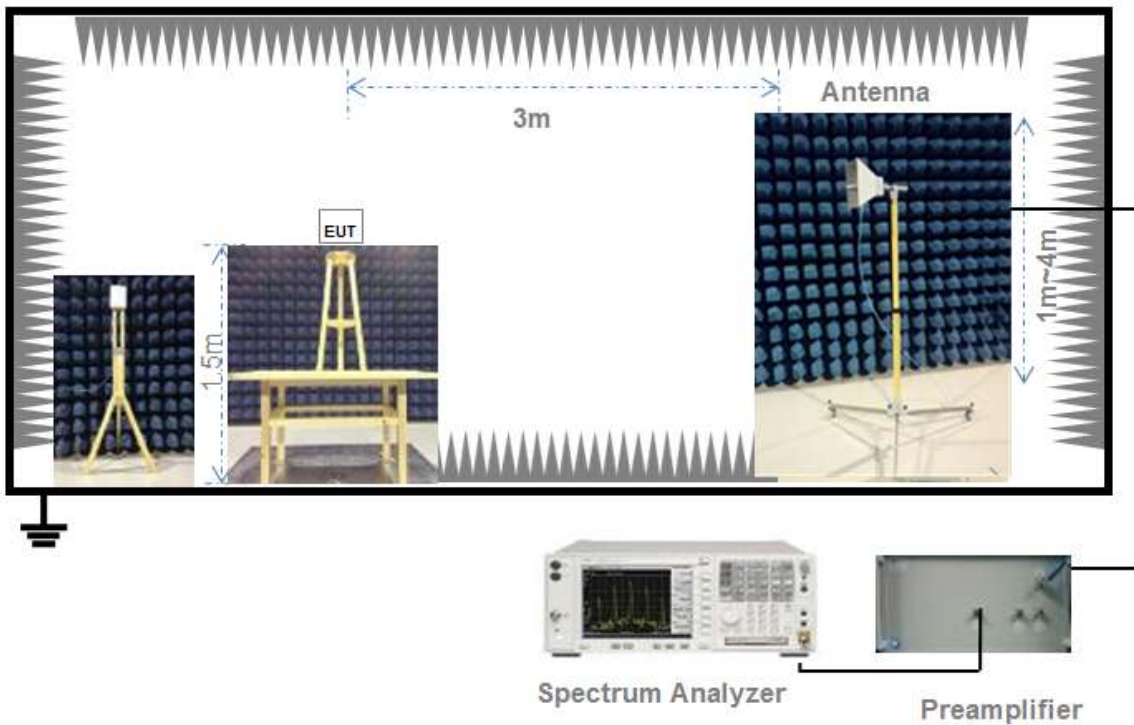

(Diagram 5)

4.6 Measurement Results Explanation Example

4.6.1 For conducted test items:

The offset level is set in the spectrum analyzer to compensate the RF cable loss and attenuator between EUT conducted output port and spectrum analyzer. With the offset compensation, the spectrum analyzer reading level is exactly the EUT RF output level.

The spectrum analyzer offset is derived from RF cable loss and attenuator factor.

Offset = RF cable loss + attenuator factor.

5 TEST ITEMS

5.1 Antenna Requirements

5.1.1 Relevant Standards

FCC §15.203 & 15.247(b)

An intentional radiator shall be designed to ensure that no antenna other than that furnished by the responsible party shall be used with the device. The use of a permanently attached antenna or of an antenna that uses a unique coupling to the intentional radiator shall be considered sufficient to comply with the provisions of this section. The manufacturer may design the unit so that a broken antenna can be replaced by the user, but the use of a standard antenna jack or electrical connector is prohibited. This requirement does not apply to carrier current devices or to devices operated under the provisions of § 15.211, § 15.213, § 15.217, § 15.219, or § 15.221. Further, this requirement does not apply to intentional radiators that must be professionally installed, such as perimeter protection systems and some field disturbance sensors, or to other intentional radiators which, in accordance with § 15.31(d), must be measured at the installation site. However, the installer shall be responsible for ensuring that the proper antenna is employed so that the limits in this part are not exceeded.

If directional gain of transmitting antennas is greater than 6 dBi, the power shall be reduced by the same level in dB comparing to gain minus 6 dBi. For the fixed point-to-point operation, the power shall be reduced by one dB for every 3 dB that the directional gain of the antenna exceeds 6 dBi. The use of a permanently attached antenna or of an antenna that uses a unique coupling to the intentional radiator shall be considered sufficient to comply with the FCC rule.

5.1.2 Antenna Anti-Replacement Construction

The Antenna Anti-Replacement as following method:

Protected Method	Description
The antenna is embedded in the product.	An embedded-in antenna design is used.

Reference Documents	Item
Photo	Please refer to the EUT Photo documents.

5.1.3 Antenna Gain

The antenna peak gain of EUT is less than 6 dBi. Therefore, it is not necessary to reduce maximum peak output power limit.

5.2 Frequency Hopping Systems

5.2.1 Relevant Standards

FCC §15.247(a) (1) (i) (ii) (iii) (iv); FCC §15.247(g); FCC §15.247(h)

Describe how the hopping sequence is generated. Provide an example of the hopping sequence channels, to demonstrate that the sequence meets the requirement specified in the definition of an FHSS system. Per the definition in Section 2.1(c), the hop set shall appear as random in the near term, shall appear as evenly distributed in the long term, and sequential hops shall be randomly distributed in both direction and magnitude of change.

Describe how each individual EUT meets the requirement that each of its hopping channels is used equally on average (e.g., that each new transmission event begins on the next channel in the hopping sequence after the final channel used in the previous transmission event).

Describe how the associated receiver(s) complies with the requirement that the input bandwidth (either RF or IF) matches the bandwidth of the transmitted signal.

Describe how the associated receiver(s) has the ability to shift frequencies in synchronization with the transmitted signals.

For short burst systems, describe how the EUT complies with the requirement that it be designed to be capable of operating as a true frequency hopping system. Specifically, the device shall comply with the equal frequency use and pseudorandom hopping sequence requirement when transmitting in short bursts, and shall be designed to comply when presented with continuous data (or information) stream.

Describe how the EUT complies with the requirement that it not have the ability to be coordinated with other FHSS systems in an effort to avoid the simultaneous occupancy of individual hopping frequencies by multiple transmitters.

5.2.2 Description of the systems

1. According to the preset procedure of the whole network, all the stations in the automatic control network synchronously change the frequency multiple times within one second, and temporarily stay on each frequency hopping channel. Periodic synchronization signaling is sent from the primary station, instructing all slaves to simultaneously change the operating frequency, then the hopping sequence is generated.
2. The hop set shall appear as random in the near term, shall appear as evenly distributed in the long term, and sequential hops shall be randomly distributed in both direction and magnitude of change.

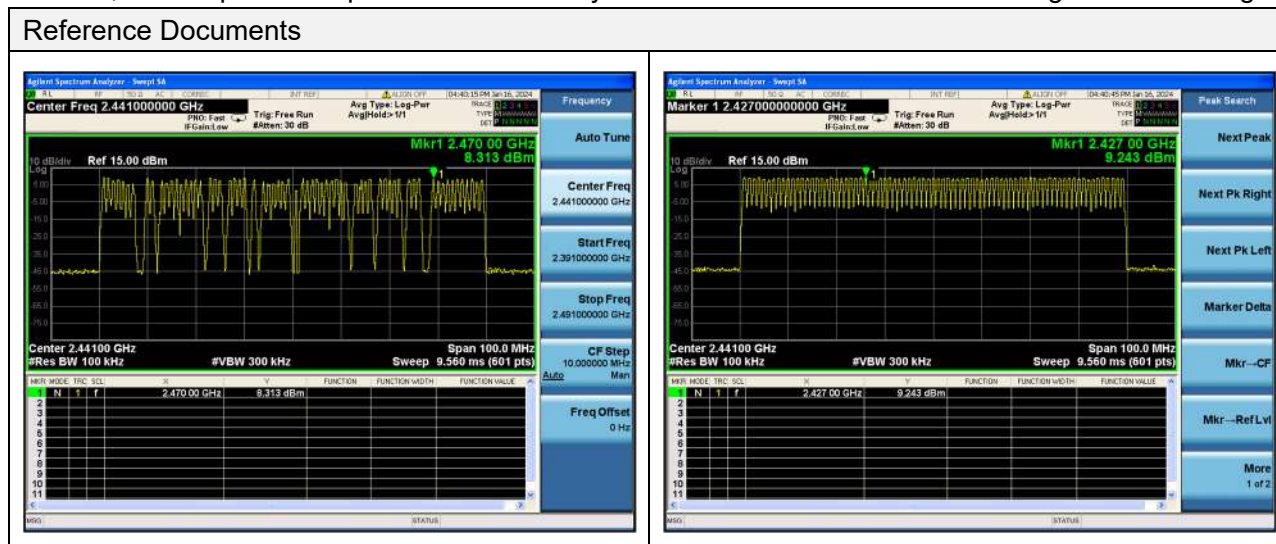

3. Channels are classified into two categories, used and unused, where used channels are part of the hopping sequence and unused channels are replaced in the hopping sequence by used channels in a pseudo-random way. Make each individual EUT meets the requirement that each of its hopping channels is used equally on average.
4. The input bandwidth and transmitted bandwidth are both 1MHz, the associated receiver(s) complies with the requirement that the input bandwidth matches the bandwidth of the transmitted signal.
5. Connected devices communicate on the same physical channel by synchronizing with a common clock and hopping sequence.
6. EUT isn't short burst systems.
7. EUT can't have the ability to be coordinated with other FHSS systems in an effort.

5.3 Number of Hopping Frequencies

5.3.1 Limit

FCC §15.247(a) (1) (iii)

Frequency hopping systems operating in the 2400 MHz to 2483.5 MHz bands shall use at least 15 hopping frequencies.

5.3.2 Test Setup

See section 4.5.1 for test setup description for the antenna port. The photo of test setup please refer to ANNEX B.

5.3.3 Test Procedure

The EUT must have its hopping function enabled. Use the following spectrum analyzer settings:

Span = The frequency band of operation

RBW = To identify clearly the individual channels, set the RBW to less than 30% of the channel spacing or the 20 dB bandwidth, whichever is smaller.

VBW \geq RBW

Sweep = auto

Detector function = peak

Trace = max hold

Allow the trace to stabilize

5.3.4 Test Result

Please refer to ANNEX A.1.

5.4 Peak Output Power

5.4.1 Test Limit

FCC § 15.247(b)

For frequency hopping systems operating in the 2400-2483.5 MHz band employing at least 75 non-overlapping hopping channels band: 1 watt. For all other frequency hopping systems in the 2400-2483.5 MHz band: 0.125 watts.

5.4.2 Test Setup

See section 4.5.1 for test setup description for the antenna port. The photo of test setup please refer to ANNEX B.

5.4.3 Test Procedure

The Module operates at hopping-off test mode. The lowest, middle and highest channels are selected to perform testing to verify the conducted RF output peak power of the Module.

Use the following spectrum analyzer settings:

Span = approximately 5 times the 20 dB bandwidth, centered on a hopping channel

RBW > the 20 dB bandwidth of the emission being measured

VBW \geq RBW

Sweep = auto

Detector function = peak

Trace = max hold

Allow the trace to stabilize.

5.4.4 Test Result

Please refer to ANNEX A.2.

5.5 Occupied Bandwidth

5.5.1 Limit

FCC §15.247(a)

Measurement of the 20dB bandwidth of the modulated signal.

5.5.2 Test Setup

See section 4.5.1 for test setup description for the antenna port. The photo of test setup please refer to ANNEX B.

5.5.3 Test Procedure

Use the following spectrum analyzer settings:

Span = approximately 2 to 5 times the 20 dB bandwidth, centered on a hopping channel

RBW = in the range of 1% to 5% of the OBW

VBW \geq RBW

Sweep = auto

Detector function = peak

Trace = max hold

The EUT should be transmitting at its maximum data rate, Allow the trace to stabilize.

5.5.4 Test Result

Please refer to ANNEX A.3.

5.6 Carrier Frequency Separation

5.6.1 Limit

FCC §15.247(a)

Frequency hopping systems shall have hopping channel carrier frequencies separated by a minimum of 25 kHz or the 2/3 of the 20 dB bandwidth of the hopping channel, whichever is greater.

5.6.2 Test Setup

See section 4.5.1 for test setup description for the antenna port. The photo of test setup please refer to ANNEX B.

5.6.3 Test Procedure

The EUT must have its hopping function enabled. Use the following spectrum analyzer settings:

Span = wide enough to capture the peaks of two adjacent channels

Resolution (or IF) Bandwidth (RBW) \geq 1% of the span

Video (or Average) Bandwidth (VBW) \geq RBW

Sweep = auto

Detector function = peak

Trace = max hold

Allow the trace to stabilize. Use the marker-delta function to determine the separation between the peaks of the adjacent channels.

5.6.4 Test Result

Please refer to ANNEX A.4.

5.7 Time of Occupancy (Dwell time)

5.7.1 Limit

FCC §15.247(a)

Frequency hopping systems in the 2400 MHz - 2483.5 MHz band shall use at least 15 non-overlapping channels. The average time of occupancy on any channel shall not be greater than 0.4 seconds within a period of 0.4 seconds multiplied by the number of hopping channels employed. Frequency hopping systems may avoid or suppress transmissions on a particular hopping frequency provided that a minimum of 15 channels are used.

5.7.2 Test Setup

See section 4.5.1 for test setup description for the antenna port. The photo of test setup please refer to ANNEX B.

5.7.3 Test Procedure

The EUT shall have its hopping function enabled. Use the following spectrum analyzer settings:

Span: Zero span, centered on a hopping channel

RBW shall be \leq channel spacing and where possible RBW should be set $\gg 1/T$, where T is the expected dwell time per channel

Sweep: As necessary to capture the entire dwell time per hopping channel; where possible use a video trigger and trigger delay so that the transmitted signal starts a little to the right of the start of the plot. The trigger level might need slight adjustment to prevent triggering when the system hops on an adjacent channel; a second plot might be needed with a longer sweep time to show two successive hops on a channel

Detector function: Peak

Trace: Max hold

Use the marker-delta function to determine the transmit time per hop. If this value varies with different modes of operation (data rate, modulation format, number of hopping channels, etc.), then repeat this test for each variation in transmit time.

The average time of occupancy on any channel within the Period can be calculated with formulas:

For GFSK and 8-DPSK:

For DH1 package type

$$\{\text{Total of Dwell}\} = \{\text{Pulse Time}\} * (1600 / 2) / \{\text{Number of Hopping Frequency}\} * \{\text{Period}\}$$

$$\{\text{Period}\} = 0.4 \text{ s} * \{\text{Number of Hopping Frequency}\}$$

For DH3 package type

$$\{\text{Total of Dwell}\} = \{\text{Pulse Time}\} * (1600 / 4) / \{\text{Number of Hopping Frequency}\} * \{\text{Period}\}$$

$$\{\text{Period}\} = 0.4 \text{ s} * \{\text{Number of Hopping Frequency}\}$$

For DH5 package type

$$\{\text{Total of Dwell}\} = \{\text{Pulse Time}\} * (1600 / 6) / \{\text{Number of Hopping Frequency}\} * \{\text{Period}\}$$

$$\{\text{Period}\} = 0.4 \text{ s} * \{\text{Number of Hopping Frequency}\}$$

For AFH Mode:

For DH1 package type

$$\{\text{Total of Dwell}\} = \{\text{Pulse Time}\} * (800 / 2) / \{\text{Number of Hopping Frequency}\} * \{\text{Period}\}$$

{Period} = 0.4 s * {Number of Hopping Frequency}

For DH3 package type

{Total of Dwell} = {Pulse Time} * (800 / 4) / {Number of Hopping Frequency} * {Period}

{Period} = 0.4 s * {Number of Hopping Frequency}

For DH5 package type

{Total of Dwell} = {Pulse Time} * (800 / 6) / {Number of Hopping Frequency} * {Period}

{Period} = 0.4 s * {Number of Hopping Frequency}

The lowest, middle and highest channels are selected to perform testing to record the dwell time of each occupation measured in this channel, which is called Pulse Time here.

5.7.4 Test Result

Please refer to ANNEX A.5.

5.8 Conducted Spurious Emission & Authorized-band band-edge

5.8.1 Limit

FCC §15.247(d)

In any 100 kHz bandwidth outside the frequency band in which the spread spectrum or digitally modulated intentional radiator is operating, the radio frequency power that is produced by the intentional radiator shall be at least 20 dB below that in the 100 kHz bandwidth within the band that contains the highest level of the desired power, based on either an RF conducted or a radiated measurement.

5.8.2 Test Setup

See section 4.5.1 for test setup description for the antenna port. The photo of test setup please refer to ANNEX B.

5.8.3 Test Procedure

Use the following spectrum analyzer settings:

Span = wide enough to capture the peak level of the in-band emission and all spurious emissions (e.g., harmonics) from the lowest frequency generated in the EUT up through the 10th harmonic. Typically, several plots are required to cover this entire span.

RBW = 100 kHz

VBW = 300 kHz

Sweep = auto

Detector function = peak

Trace = max hold

Allow the trace to stabilize

5.8.4 Test Result

Please refer to ANNEX A.6.

5.9 Conducted Emission

5.9.1 Limit

FCC §15.207

For an intentional radiator that is designed to be connected to the public utility (AC) power line, the radio frequency voltage that is conducted back onto the AC power line on any frequency within the band 150 kHz to 30 MHz shall not exceed the limits in the following table, as measured using a 50 μ H/50 Ω line impedance stabilization network (LISN).

Frequency range (MHz)	Conducted Limit (dB μ V)	
	Quai-peak	Average
0.15 - 0.50	66 to 56	56 to 46
0.50 - 5	56	46
0.50 - 30	60	50

5.9.2 Test Setup

See section 4.5.2 for test setup description for the AC power supply port. The photo of test setup please refer to ANNEX B.

5.9.3 Test Procedure

The maximum conducted interference is searched using Peak (PK), if the emission levels more than the AV and QP limits, and that have narrow margins from the AV and QP limits will be re-measured with AV and QP detectors. Tests for both L phase and N phase lines of the power mains connected to the EUT are performed. Refer to recorded points and plots below.

Devices subject to Part 15 must be tested for all available U.S. voltages and frequencies (such as a nominal 120 VAC, 50/60 Hz and 240 VAC, 50/60 Hz) for which the device is capable of operation. A device rated for 50/60 Hz operation need not be tested at both frequencies provided the radiated and line conducted emissions are the same at both frequencies.

5.9.4 Test Result

Please refer to ANNEX A.7.

5.10 Radiated Spurious Emission

5.10.1 Limit

FCC §15.209&15.247(d)

Radiated emission outside the frequency band attenuation below the general limits specified in FCC section 15.209(a) is not required. In addition, radiated emissions which fall in the restricted bands, as defined in FCC section 15.205(a), must also comply with the radiated emission limits specified in FCC section 15.209(a).

According to FCC section 15.209 (a), except as provided elsewhere in this subpart, the emissions from an intentional radiator shall not exceed the field strength levels specified in the following table:

Frequency (MHz)	Field Strength ($\mu\text{V}/\text{m}$)	Measurement Distance (m)
0.009 - 0.490	2400/F(kHz)	300
0.490 - 1.705	24000/F(kHz)	30
1.705 - 30.0	30	30
30 - 88	100	3
88 - 216	150	3
216 - 960	200	3
Above 960	500	3

Note:

1. Field Strength (dB $\mu\text{V}/\text{m}$) = 20*log[Field Strength ($\mu\text{V}/\text{m}$)].
2. In the emission tables above, the tighter limit applies at the band edges.
3. For Above 1000 MHz, the emission limit in this paragraph is based on measurement instrumentation employing an average detector, measurement using instrumentation with a peak detector function, corresponding to 20dB above the maximum permitted average limit.
4. For above 1000 MHz, limit field strength of harmonics: 54dBuV/m@3m (AV) and 74dBuV/m@3m (PK).

5.10.2 Test Setup

See section 4.5.3 to 4.5.5 for test setup description for the antenna port. The photo of test setup please refer to ANNEX B.

5.10.3 Test Procedure

The measurement frequency range is from 9 kHz to the 10th harmonic of the fundamental frequency. The Turn Table is actuated to turn from 0° to 360°, and both horizontal and vertical polarizations of the Test Antenna are used to find the maximum radiated power. Mid channels on all channel bandwidth verified. Only the worst RB size/offset presented.

The power of the EUT transmitting frequency should be ignored.

All Spurious Emission tests were performed in X, Y, Z axis direction. And only the worst axis test condition was recorded in this test report.

Use the following spectrum analyzer settings:

Span = wide enough to fully capture the emission being measured

RBW = 1 MHz for $f \geq 1$ GHz, 100 kHz for $f < 1$ GHz

VBW \geq RBW

Sweep = auto

Detector function = peak

Trace = max hold

For measurement below 1GHz, If the emission level of the EUT measured by the peak detector is 3 dB lower than the applicable limit, the peak emission level will be reported, Otherwise, the emission measurement will be repeated using the quasi-peak detector and reported.

5.10.4 Test Result

Please refer to ANNEX A.8.

5.11 Band Edge (Restricted-band band-edge)

5.11.1 Limit

FCC §15.209&15.247(d)

Radiated emission outside the frequency band attenuation below the general limits specified in FCC section 15.209(a) is not required. In addition, radiated emissions which fall in the restricted bands, as defined in FCC section 15.205(a), must also comply with the radiated emission limits specified in FCC section 15.209(a).

5.11.2 Test Setup

See section 4.5.3 to 4.5.5 for test setup description for the antenna port. The photo of test setup please refer to ANNEX B.

5.11.3 Test Procedure

The measurement frequency range is from 9 kHz to the 10th harmonic of the fundamental frequency. The Turn Table is actuated to turn from 0° to 360°, and both horizontal and vertical polarizations of the Test Antenna are used to find the maximum radiated power. Mid channels on all channel bandwidth verified. Only the worst RB size/offset presented.

The power of the EUT transmitting frequency should be ignored.

All Spurious Emission tests were performed in X, Y, Z axis direction. And only the worst axis test condition was recorded in this test report.

Use the following spectrum analyzer settings:

Span = wide enough to fully capture the emission being measured

RBW = 1 MHz for $f \geq 1$ GHz, 100 kHz for $f < 1$ GHz

VBW \geq RBW

Sweep = auto

Detector function = peak

Trace = max hold

For measurement below 1GHz, If the emission level of the EUT measured by the peak detector is 3 dB lower than the applicable limit, the peak emission level will be reported, Otherwise, the emission measurement will be repeated using the quasi-peak detector and reported.

5.11.4 Test Result

Please refer to ANNEX A.9.

ANNEX A TEST RESULT

A.1 Number of Hopping Frequency

Test Data

Test Mode	Frequency Block (MHz)	Measured Channel Numbers	Min. Limit	Verdict
GFSK	2400 - 2483.5	79	15	Pass
8-DPSK	2400 - 2483.5	79	15	Pass

Test Plots

GFSK 2.4 GHz ~ 2.4415 GHz

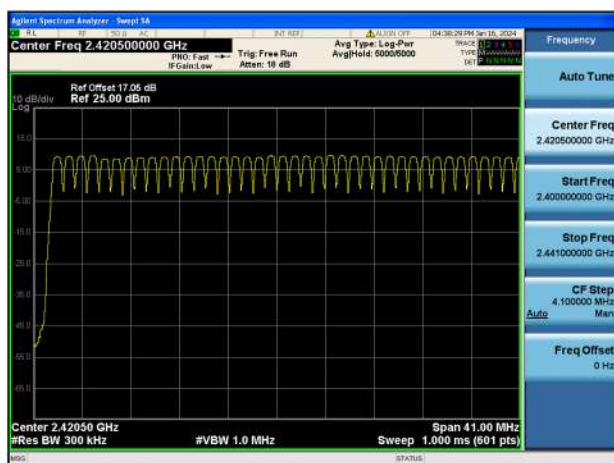

GFSK 2.4415 GHz ~ 2.4835 GHz

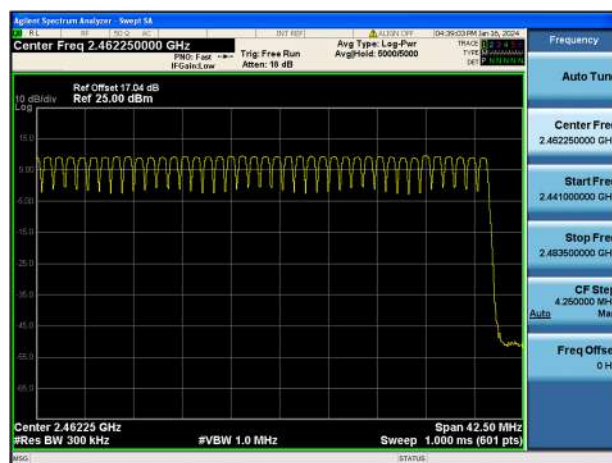

8-DPSK 2.4 GHz ~ 2.4415 GHz

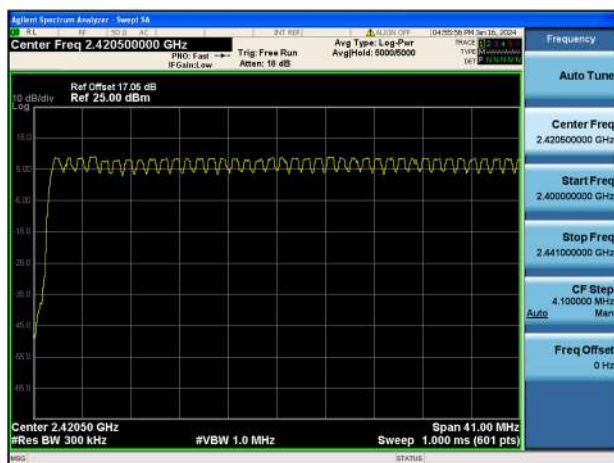

8-DPSK 2.4415 GHz ~ 2.4835 GHz



A.2 Peak Output Power

Peak Power Test Data

Channel	Measured Output Peak Power						Limit		Verdict
	GFSK		$\pi/4$ -DQPSK		8-DPSK		dBm	mW	
	dBm	mW	dBm	mW	dBm	mW			
Low	9.11	8.15	8.90	7.76	8.98	7.90	21	125	Pass
Middle	9.36	8.64	8.50	7.08	8.59	7.22			Pass
High	9.61	9.15	9.28	8.46	9.35	8.60			Pass

Test Plots

GFSK LOW CHANNEL



GFSK MIDDLE CHANNEL



GFSK HIGH CHANNEL



$\pi/4$ -DQPSK LOW CHANNEL



$\pi/4$ -DQPSK MIDDLE CHANNEL



$\pi/4$ -DQPSK HIGH CHANNEL



8-DPSK LOW CHANNEL



8-DPSK MIDDLE CHANNEL



8-DPSK HIGH CHANNEL



A.3 20 dB and 99% bandwidth

Test Data

GFSK		
Channel	20 dB Bandwidth (MHz)	99% Bandwidth (MHz)
Low	0.870000	0.759130
Middle	0.870000	0.758400
High	0.870000	0.759860
$\pi/4$ -DQPSK		
Channel	20 dB Bandwidth (MHz)	99% Bandwidth (MHz)
Low	1.265000	1.143900
Middle	1.265000	1.142300
High	1.260000	1.145800
8-DPSK		
Channel	20 dB Bandwidth (MHz)	99% Bandwidth (MHz)
Low	1.270000	1.147600
Middle	1.265000	1.146000
High	1.265000	1.147000

Test Plots

20 dB Bandwidth

GFSK LOW CHANNEL



GFSK MIDDLE CHANNEL



GFSK HIGH CHANNEL



π/4-DQPSK LOW CHANNEL



π/4-DQPSK MIDDLE CHANNEL



$\pi/4$ -DQPSK HIGH CHANNEL



8-DPSK LOW CHANNEL



8-DPSK MIDDLE CHANNEL



8-DPSK HIGH CHANNEL



99% Bandwidth

GFSK LOW CHANNEL



GFSK MIDDLE CHANNEL



GFSK HIGH CHANNEL



$\pi/4$ -DQPSK LOW CHANNEL



$\pi/4$ -DQPSK MIDDLE CHANNEL



$\pi/4$ -DQPSK HIGH CHANNEL



8-DPSK LOW CHANNEL



8-DPSK MIDDLE CHANNEL



8-DPSK HIGH CHANNEL



A.4 Hopping Frequency Separation

Test Data

Mode	Frequency separation (MHz)	2/3 of the 20 dB Bandwidth (MHz)	Verdict
GFSK	1.000	0.580	Pass
8-DPSK	1.000	0.847	Pass

Test Plots

GFSK

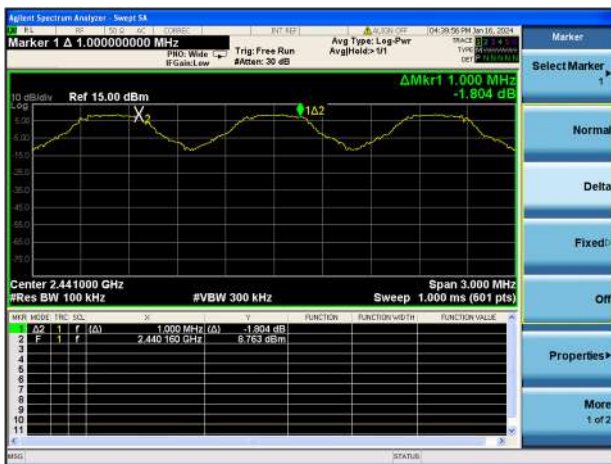

8-DPSK

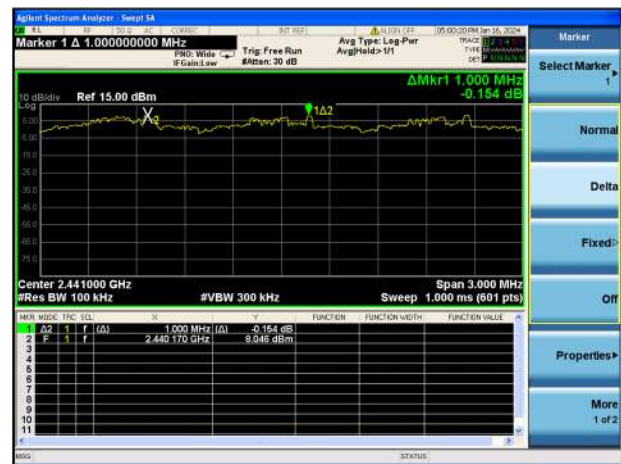

A.5 Average Time of Occupancy

Test Data

GFSK				
DH Packet	Pulse Width (ms)	Total of Dwell (ms)	Limit (sec)	Verdict
DH 1	0.37600	120.320	0.4	Pass
DH 3	1.63400	261.440	0.4	Pass
DH 5	2.87600	306.773	0.4	Pass
8-DPSK				
DH Packet	Pulse Width (ms)	Total of Dwell (ms)	Limit (sec)	Verdict
DH 1	0.38400	122.880	0.4	Pass
DH 3	1.63400	261.440	0.4	Pass
DH 5	2.88800	308.053	0.4	Pass
AFH Mode				
DH Packet	Pulse Width (ms)	Total of Dwell (ms)	Limit (sec)	Verdict
DH 1	0.37440	59.904	0.4	Pass
DH 3	1.63400	130.720	0.4	Pass
DH 5	2.87600	153.387	0.4	Pass

Test Plots

GFSK DH1

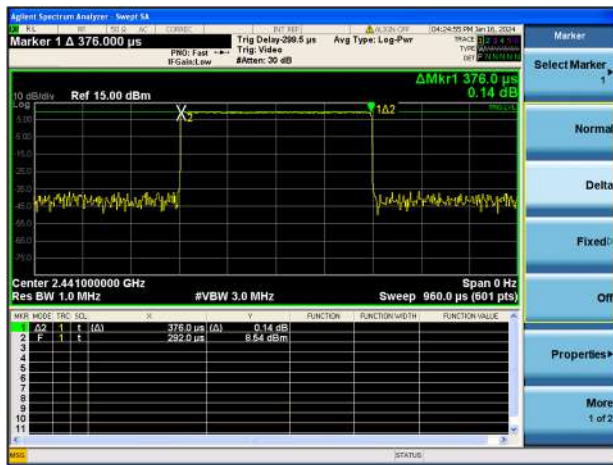

GFSK DH3

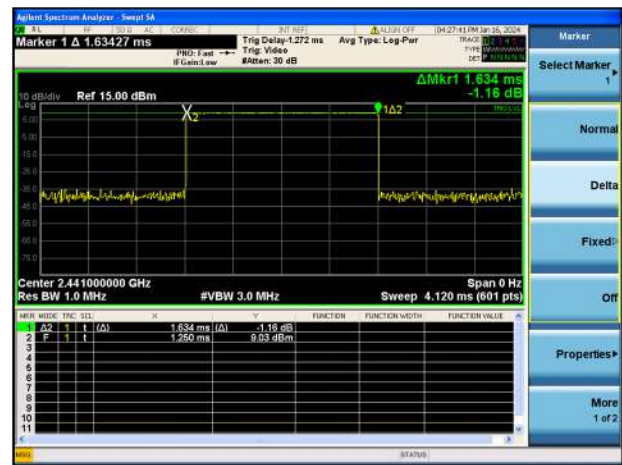

GFSK DH5

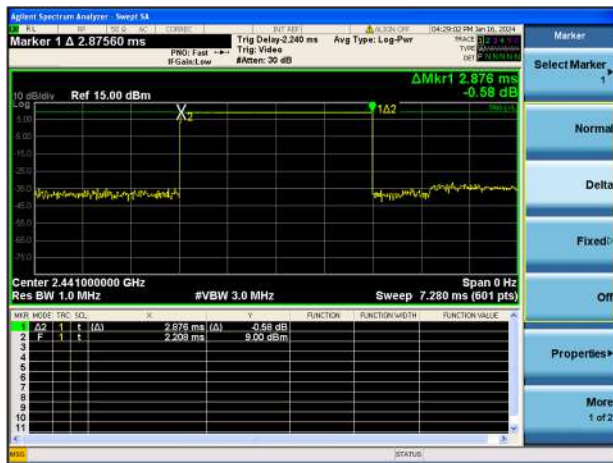

8-DPSK DH1

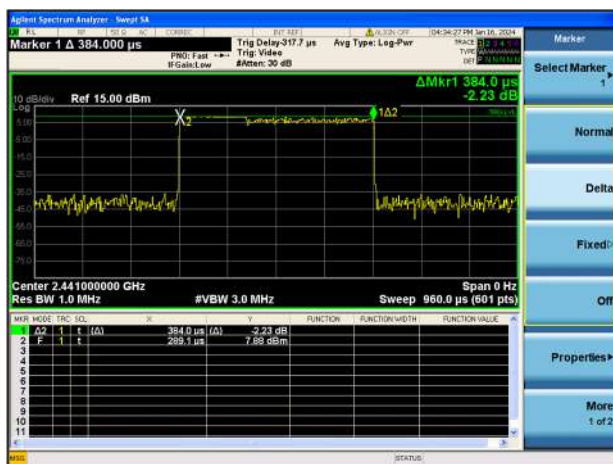

8-DPSK DH3

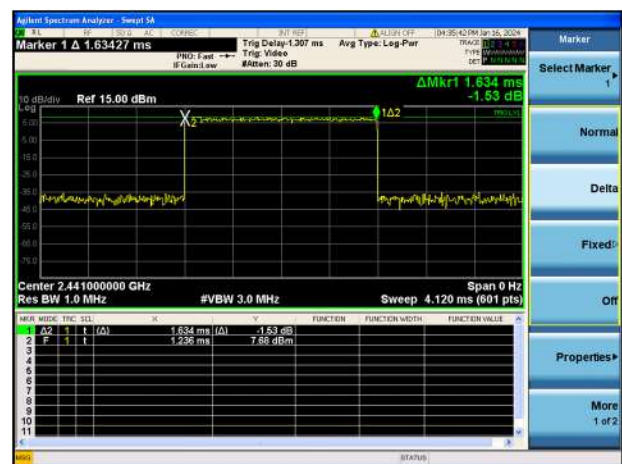

8-DPSK DH5

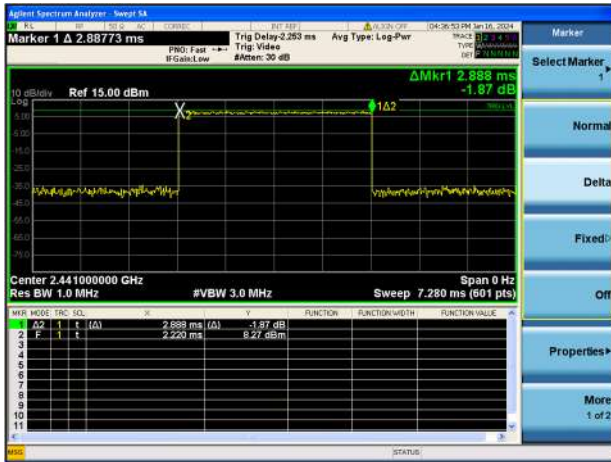

AFH Mode DH1

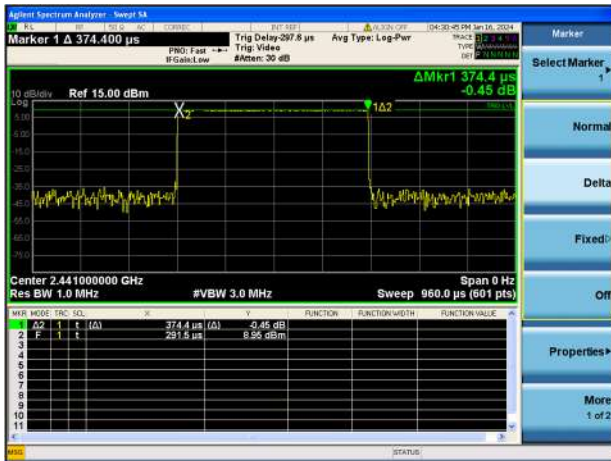

AFH Mode DH3

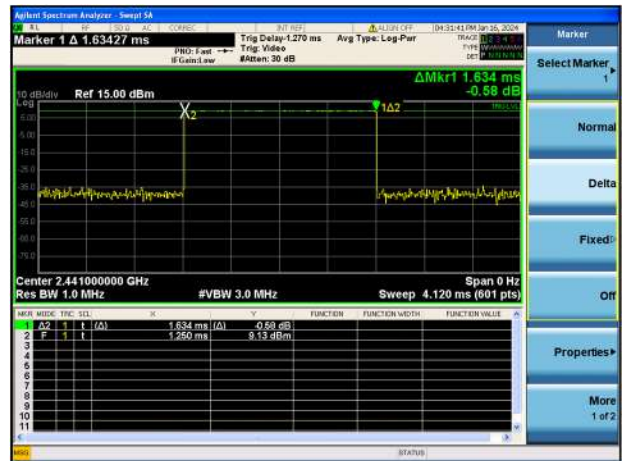

AFH Mode DH5

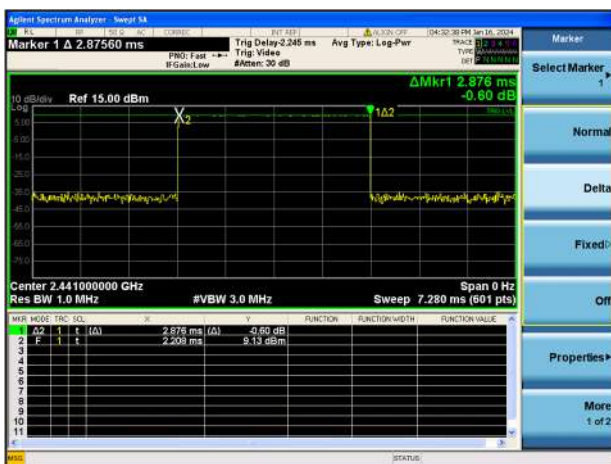

A.6 Conducted Spurious Emissions & Authorized-band band-edge

Test Data

GFSK				
Channel	Measured Max. Out of Band Emission (dBm)	Limit (dBm)		Verdict
		Carrier Level	Calculated 20 dBc Limit	
Low	-29.77	8.81	-11.19	Pass
Middle	-29.08	8.71	-11.29	Pass
High	-30.33	8.66	-11.34	Pass
8-DPSK				
Channel	Measured Max. Out of Band Emission (dBm)	Limit (dBm)		Verdict
		Carrier Level	Calculated 20 dBc Limit	
Low	-29.37	8.58	-11.42	Pass
Middle	-29.15	8.56	-11.44	Pass
High	-29.67	8.77	-11.23	Pass
Hopping Mode				
Mode	Measured Max. Out of Band Emission (dBm)	Limit (dBm)		Verdict
		Carrier Level	Calculated 20 dBc Limit	
GFSK	-28.70	9.24	-10.76	Pass
8-DPSK	-28.56	8.91	-11.09	Pass

Test Plots

GFSK LOW CHANNEL, CARRIER LEVEL



GFSK LOW CHANNEL, BAND EDGE

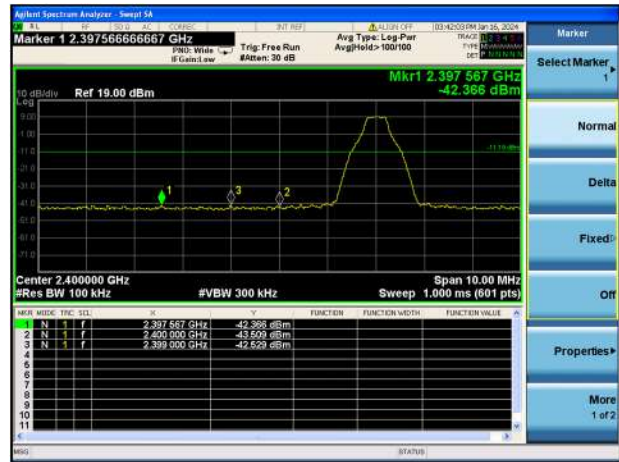

GFSK LOW CHANNEL, SPURIOUS
30 MHz ~ 3 GHz

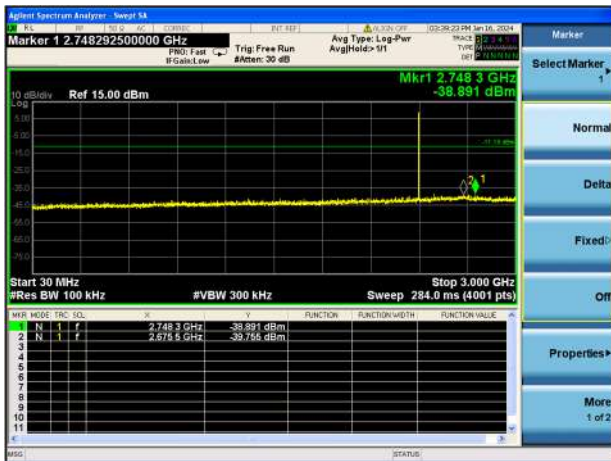

GFSK LOW CHANNEL, SPURIOUS
3 GHz ~ 25 GHz

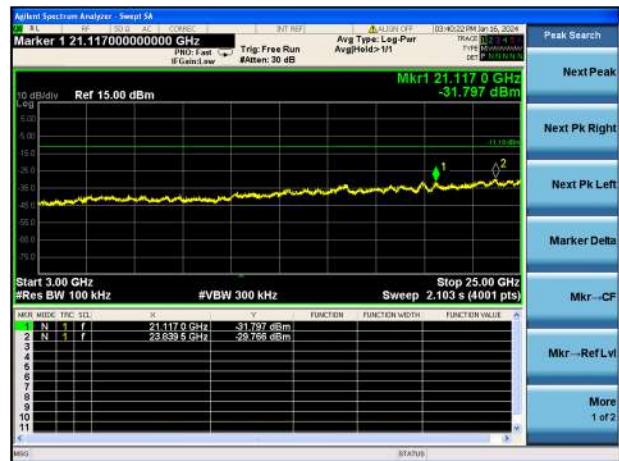

GFSK MIDDLE CHANNEL, CARRIER LEVEL



GFSK MIDDLE CHANNEL, SPURIOUS
30 MHz ~ 3 GHz

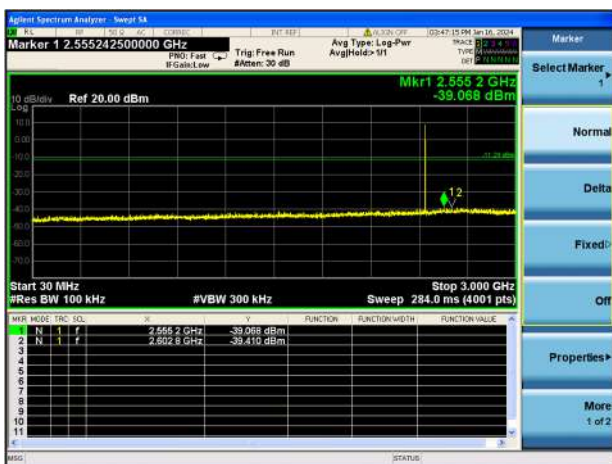

GFSK MIDDLE CHANNEL, SPURIOUS
3 GHz ~ 25 GHz

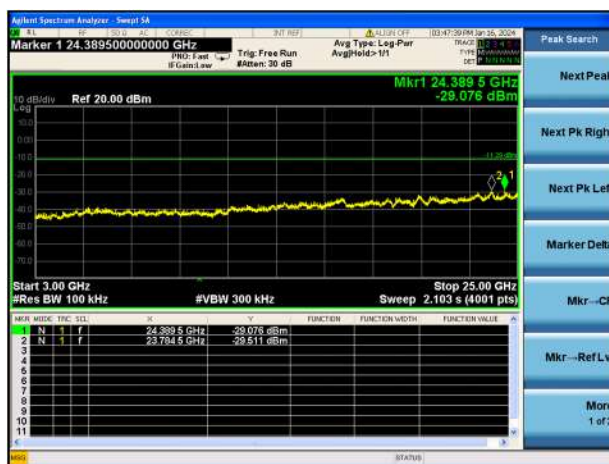

GFSK HIGH CHANNEL, CARRIER LEVEL



GFSK HIGH CHANNEL, BAND EDGE

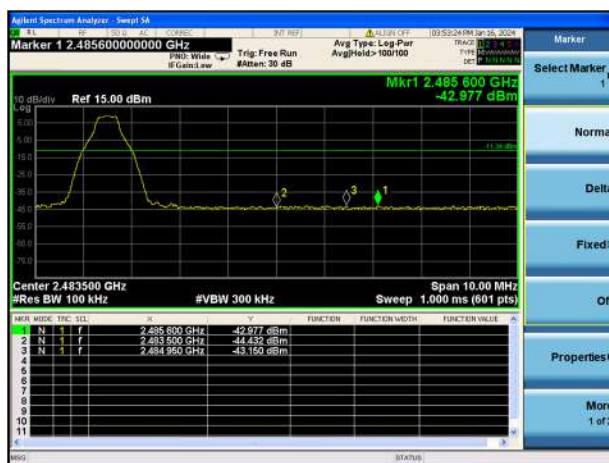

GFSK HIGH CHANNEL, SPURIOUS
30 MHz ~ 3 GHz

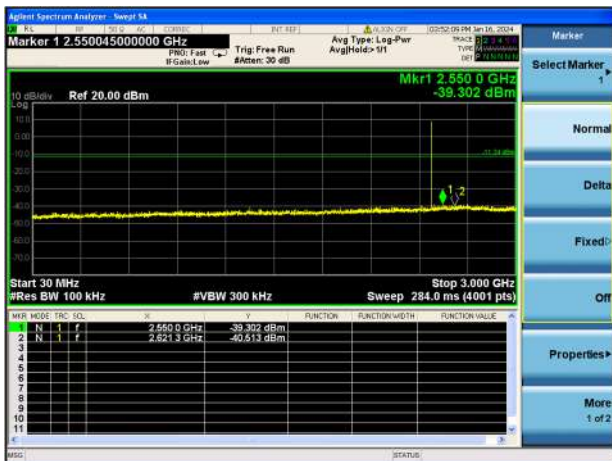

GFSK HIGH CHANNEL, SPURIOUS
3 GHz ~ 25 GHz

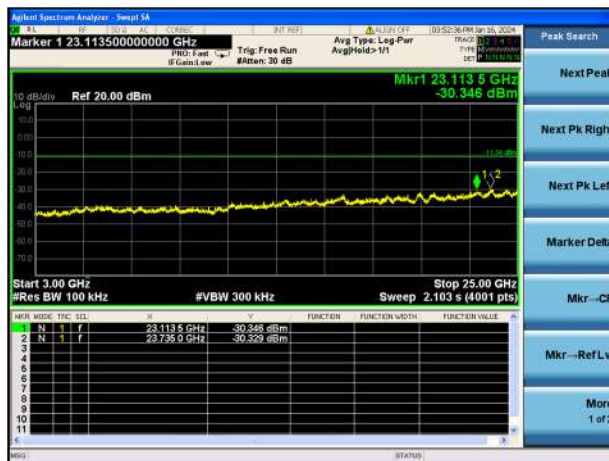

8-DPSK LOW CHANNEL, CARRIER LEVEL



8-DPSK LOW CHANNEL, BAND EDGE



8-DPSK LOW CHANNEL, SPURIOUS

30 MHz ~ 3 GHz



8-DPSK LOW CHANNEL, SPURIOUS

3 GHz ~ 25 GHz

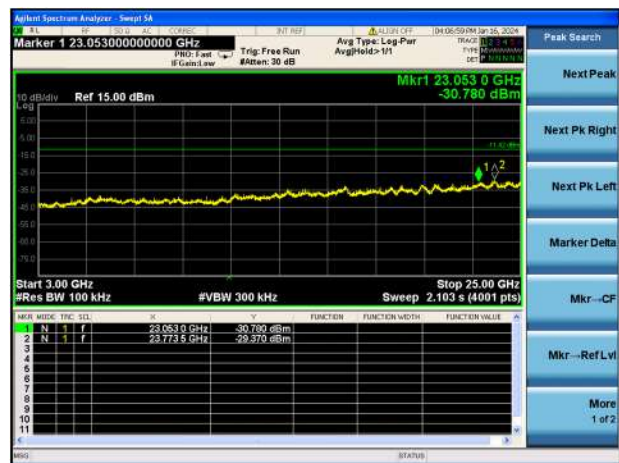

8-DPSK MIDDLE CHANNEL, CARRIER LEVEL

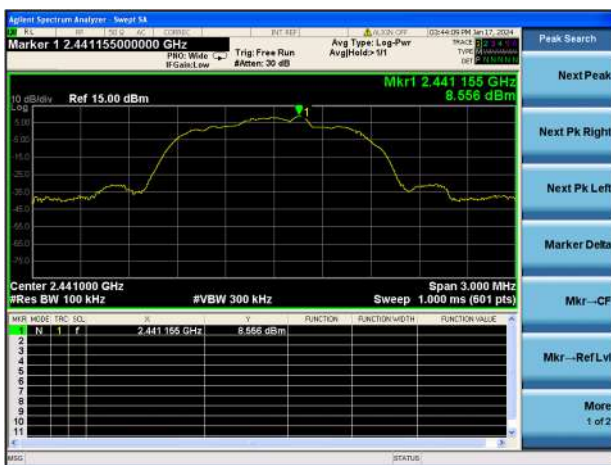

8-DPSK MIDDLE CHANNEL, SPURIOUS
30 MHz ~ 3 GHz



8-DPSK MIDDLE CHANNEL, SPURIOUS
3 GHz ~ 25 GHz

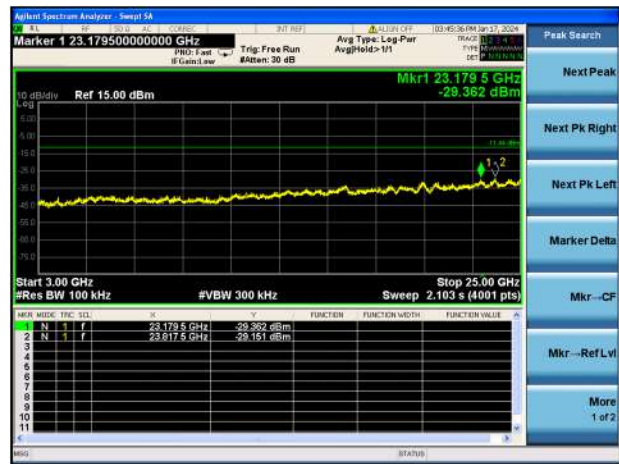

8-DPSK HIGH CHANNEL, CARRIER LEVEL

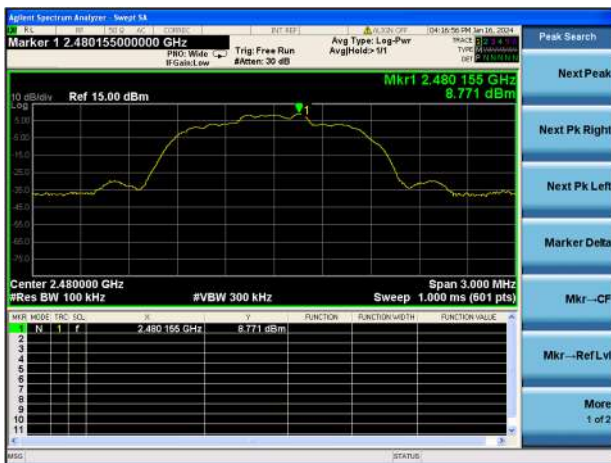

8-DPSK HIGH CHANNEL, BAND EDGE



8-DPSK HIGH CHANNEL, SPURIOUS
30 MHz ~ 3 GHz

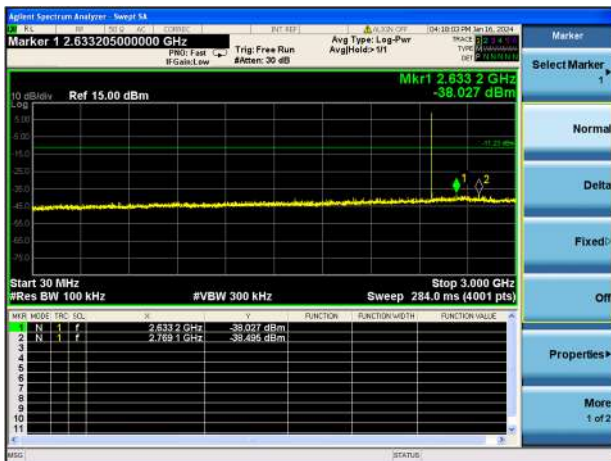

8-DPSK HIGH CHANNEL, SPURIOUS
3 GHz ~ 25 GHz

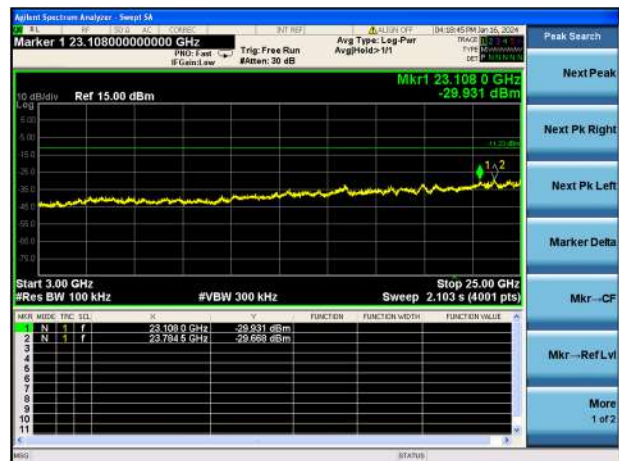

GFSK HOPPING, CARRIER LEVEL

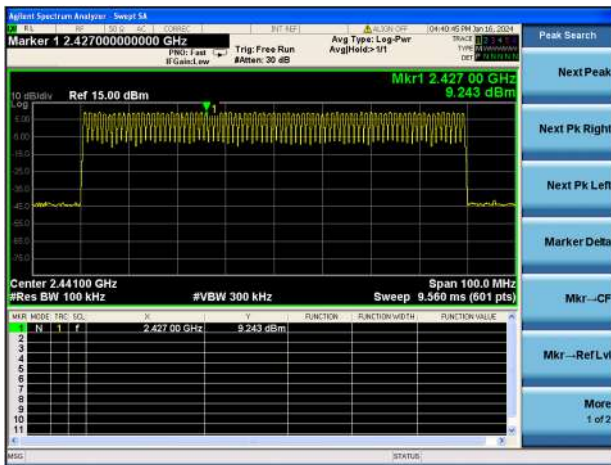

GFSK HOPPING BAND EDGE (LOW)



GFSK HOPPING BAND EDGE (HIGH)

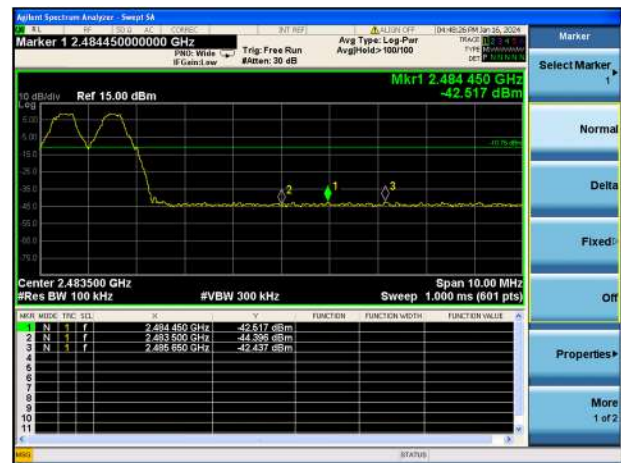

GFSK Hopping Mode, SPURIOUS
30 MHz ~ 3 GHz

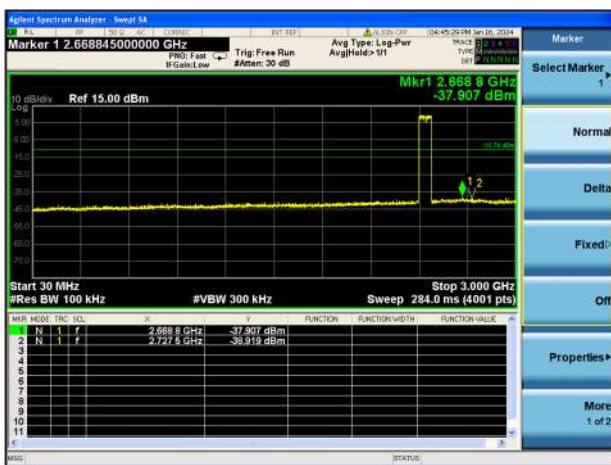

GFSK Hopping Mode, SPURIOUS
3GHz ~ 25 GHz

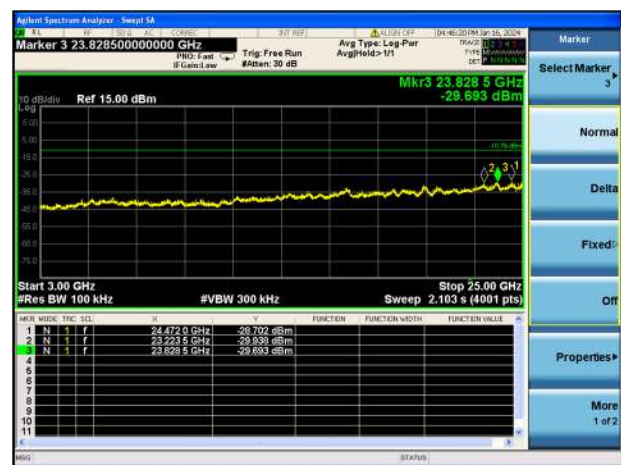

8-DPSK HOPPING, CARRIER LEVEL

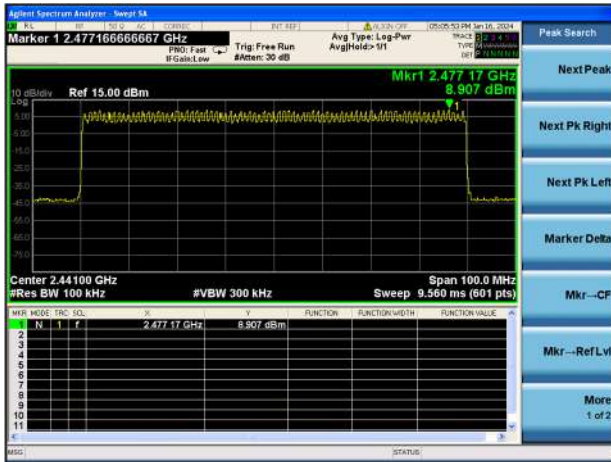

8-DPSK Hopping BAND EDGE (LOW)



8-DPSK Hopping BAND EDGE (HIGH)



8-DPSK Hopping Mode, SPURIOUS
30 MHz ~ 3 GHz

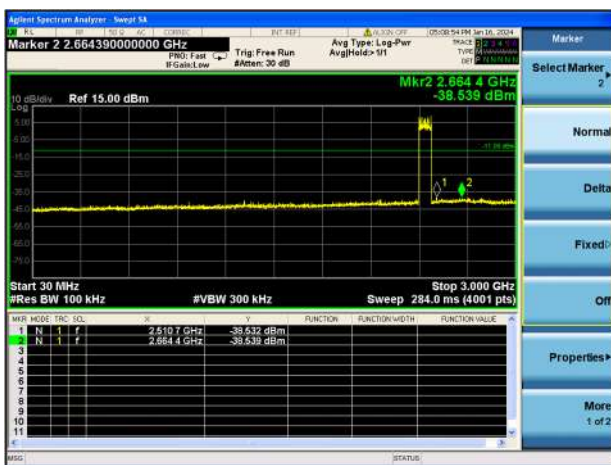

8-DPSK Hopping Mode, SPURIOUS
3GHz ~ 25 GHz

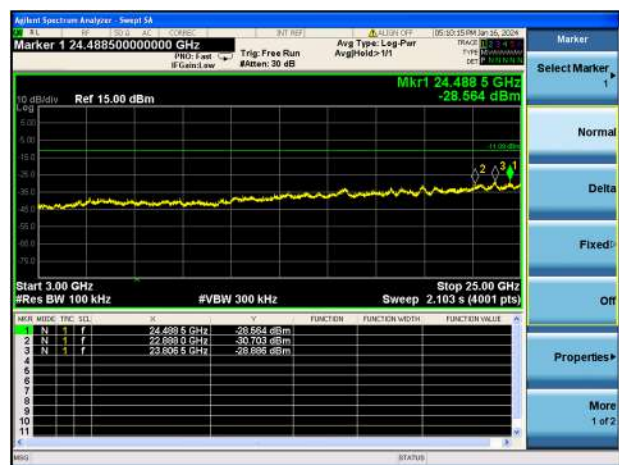

A.7 Conducted Emissions

Note ¹: The EUT is working in the Normal link mode. All modes have been tested and normal link mode is worst.

Note ²: Devices subject to Part 15 must be tested for all available U.S. voltages and frequencies (such as a nominal 120 VAC, 60 Hz and 240 VAC, 50 Hz) for which the device is capable of operation. So, The configuration 120 VAC, 60 Hz and 240 VAC, 50 Hz were tested respectively, but only the worst configuration (120 VAC, 60 Hz) shown here.

Note ³: Results (dBuV) = Original reading level of Spectrum Analyzer (dBuV) + Factor (dB)

Test Data and Plots

PHASE L

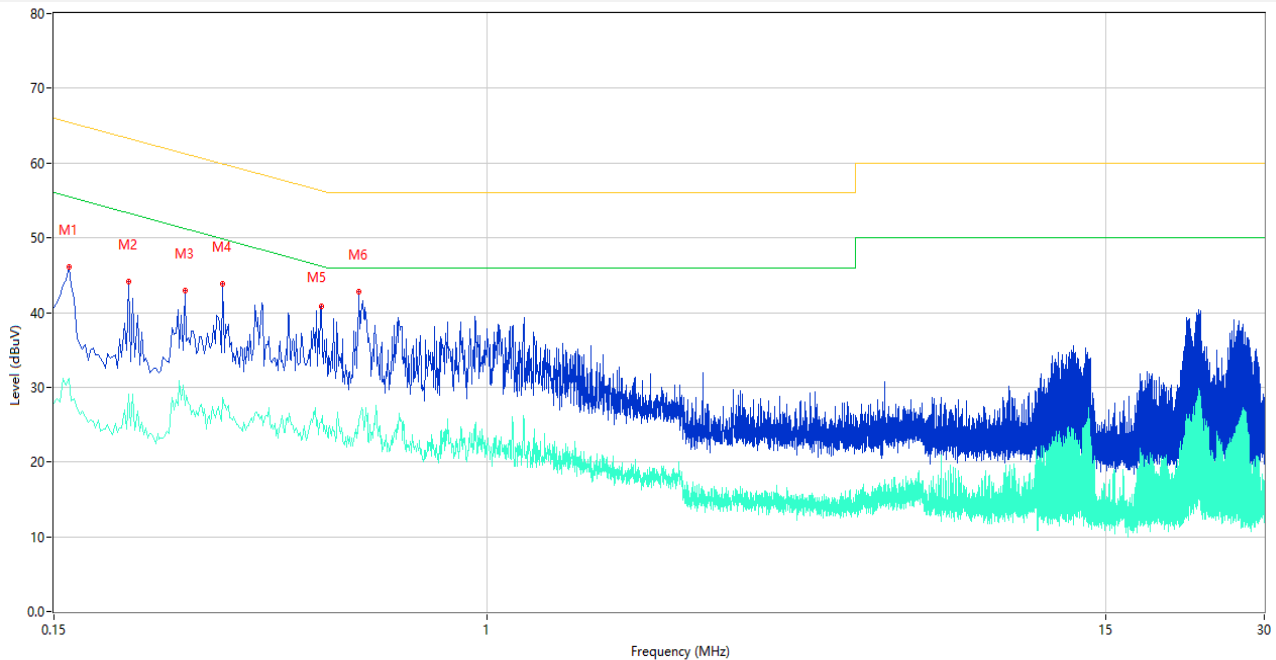

No.	Frequency (MHz)	Results (dBuV)	Factor (dB)	Limit (dBuV)	Margin (dB)	Detector	Line	Verdict
1	0.160	46.12	9.46	65.46	19.34	Peak	L	Pass
1**	0.160	31.13	9.46	55.46	24.33	AV	L	Pass
2	0.208	44.10	9.42	63.28	19.18	Peak	L	Pass
2**	0.208	29.04	9.42	53.28	24.24	AV	L	Pass
3	0.266	42.90	9.43	61.24	18.34	Peak	L	Pass
3**	0.266	27.50	9.43	51.24	23.74	AV	L	Pass
4	0.314	43.84	9.40	59.86	16.02	Peak	L	Pass
4**	0.314	28.56	9.40	49.86	21.30	AV	L	Pass
5	0.484	40.83	9.76	56.27	15.44	Peak	L	Pass
5**	0.484	25.28	9.76	46.27	20.99	AV	L	Pass
6	0.570	42.78	9.89	56.00	13.22	Peak	L	Pass
6**	0.570	25.59	9.89	46.00	20.41	AV	L	Pass

PHASE N

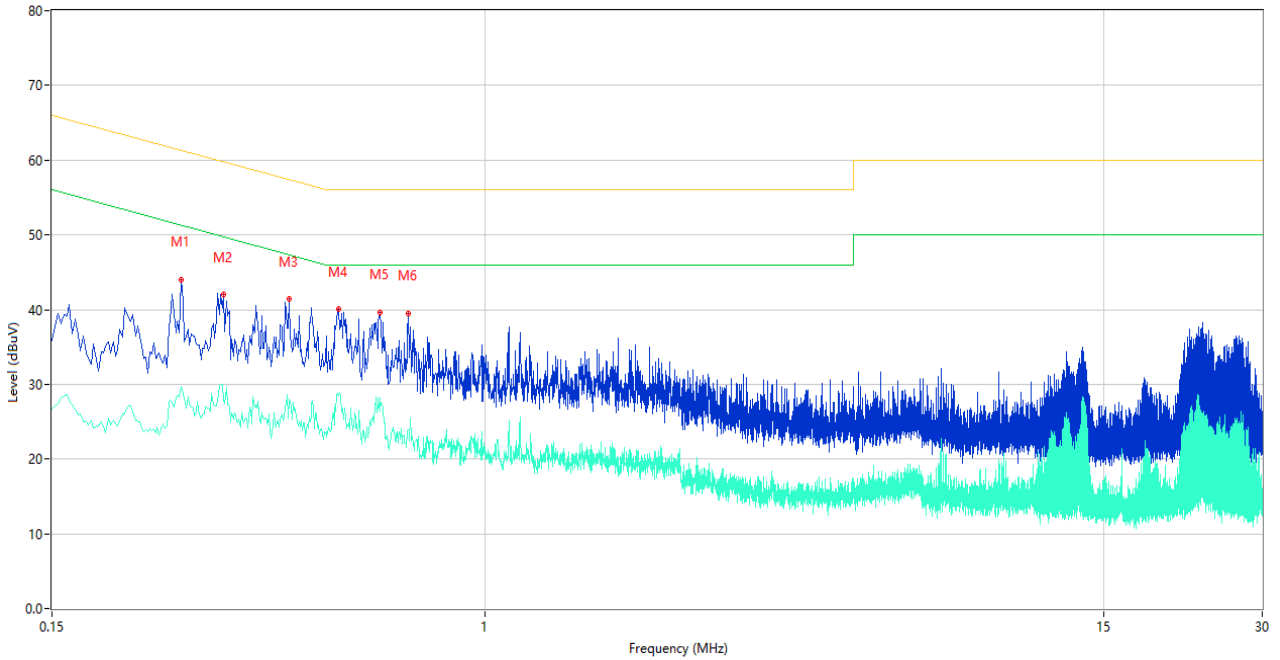

No.	Frequency (MHz)	Results (dBuV)	Factor (dB)	Limit (dBuV)	Margin (dB)	Detector	Line	Verdict
1	0.264	44.06	9.43	61.30	17.24	Peak	N	Pass
1**	0.264	29.66	9.43	51.30	21.64	AV	N	Pass
2	0.318	42.09	9.39	59.76	17.67	Peak	N	Pass
2**	0.318	27.91	9.39	49.76	21.85	AV	N	Pass
3	0.424	41.47	9.97	57.37	15.90	Peak	N	Pass
3**	0.424	28.06	9.97	47.37	19.31	AV	N	Pass
4	0.526	40.05	9.75	56.00	15.95	Peak	N	Pass
4**	0.526	28.50	9.75	46.00	17.50	AV	N	Pass
5	0.630	39.68	9.78	56.00	16.32	Peak	N	Pass
5**	0.630	26.32	9.78	46.00	19.68	AV	N	Pass
6	0.714	39.49	9.87	56.00	16.51	Peak	N	Pass
6**	0.714	24.00	9.87	46.00	22.00	AV	N	Pass

A.8 Radiated Spurious Emission

Note ¹: The symbol of "--" in the table which means not application.

Note ²: For the test data above 1 GHz, according the ANSI C63.10-2013, where limits are specified for both average and peak (or quasi-peak) detector functions, if the peak (or quasi-peak) measured value complies with the average limit, it is unnecessary to perform an average measurement.

Note ³: The EUT is working in the Normal link mode below 1 GHz. All modes have been tested and DH5-Hopping mode is the worst.

Note ⁴: Results (dBuV/m) = Original reading level of Spectrum Analyzer (dBuV/m) + Factor (dB)

The low frequency, which started from 9 kHz to 30 MHz, was pre-scanned and the result which was 20 dB lower than the limit line per 15.31(o) was not reported.

Test Data and Plots

30 MHz to 1 GHz, ANT H

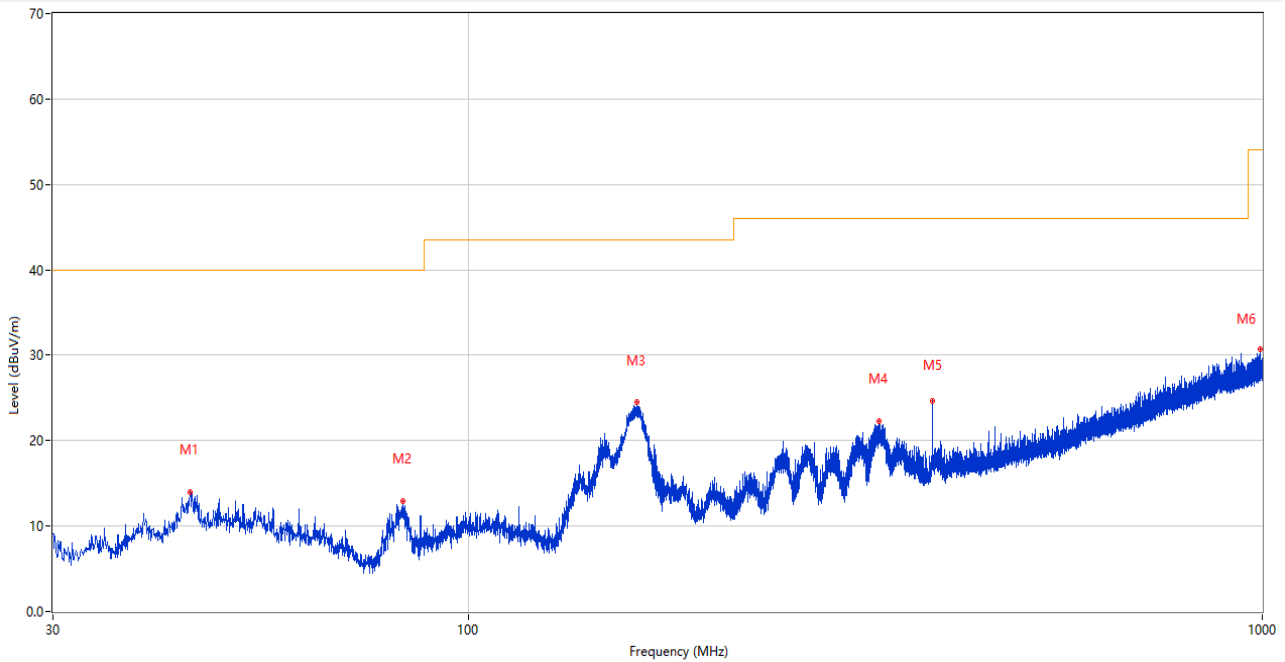

No.	Frequency (MHz)	Results (dBuV/m)	Factor (dB)	Limit (dBuV/m)	Margin (dB)	Detector	Table (Degree)	Height (cm)	Antenna	Verdict
1	44.599	13.98	-25.66	40.0	26.02	Peak	294.00	200	Horizontal	Pass
2	82.671	12.88	-30.53	40.0	27.12	Peak	303.00	200	Horizontal	Pass
3	163.327	24.46	-29.48	43.5	19.04	Peak	155.00	200	Horizontal	Pass
4	329.197	22.26	-22.82	46.0	23.74	Peak	68.00	100	Horizontal	Pass
5	384.002	24.64	-21.41	46.0	21.36	Peak	78.00	100	Horizontal	Pass
6	994.471	30.66	-8.44	54.0	23.34	Peak	140.00	100	Horizontal	Pass

30 MHz to 1 GHz, ANT V

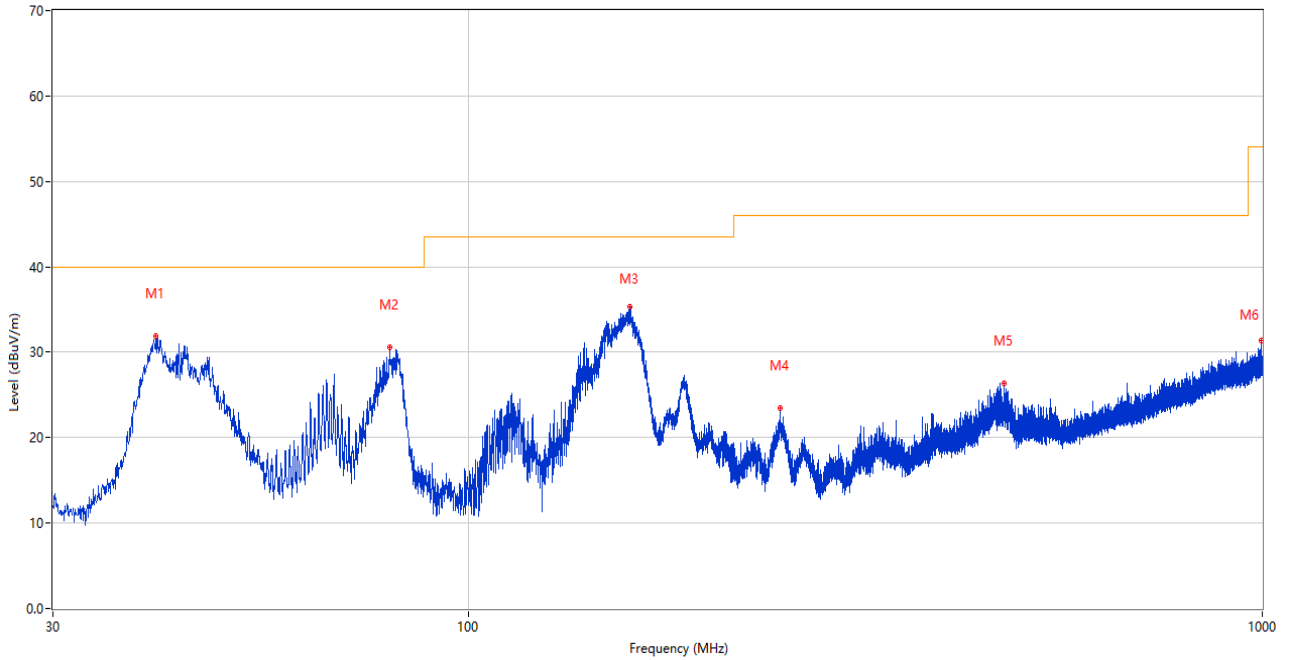

No.	Frequency (MHz)	Results (dBuV/m)	Factor (dB)	Limit (dBuV/m)	Margin (dB)	Detector	Table (Degree)	Height (cm)	Antenna	Verdict
1	40.476	31.86	-26.56	40.0	8.14	Peak	129.00	100	Vertical	Pass
2	79.664	30.53	-31.00	40.0	9.47	Peak	251.00	200	Vertical	Pass
3	159.932	35.28	-29.58	43.5	8.22	Peak	10.00	100	Vertical	Pass
4	247.086	23.45	-24.94	46.0	22.55	Peak	337.00	100	Vertical	Pass
5	473.047	26.43	-19.37	46.0	19.57	Peak	78.00	100	Vertical	Pass
6	998.109	31.39	-8.43	54.0	22.61	Peak	208.00	200	Vertical	Pass

Note 1: The marked spikes near 2400 MHz with circle should be ignored because they are Fundamental signal.

Note 2: The spurious from 18GHz-25GHz is noise only, do not show on the report.

GFSK LOW CHANNEL 1 GHz to 18 GHz, ANT H

RE Test case_FCC Part 15C_FCC 15.247(2.4G)_1GHz-18GHz

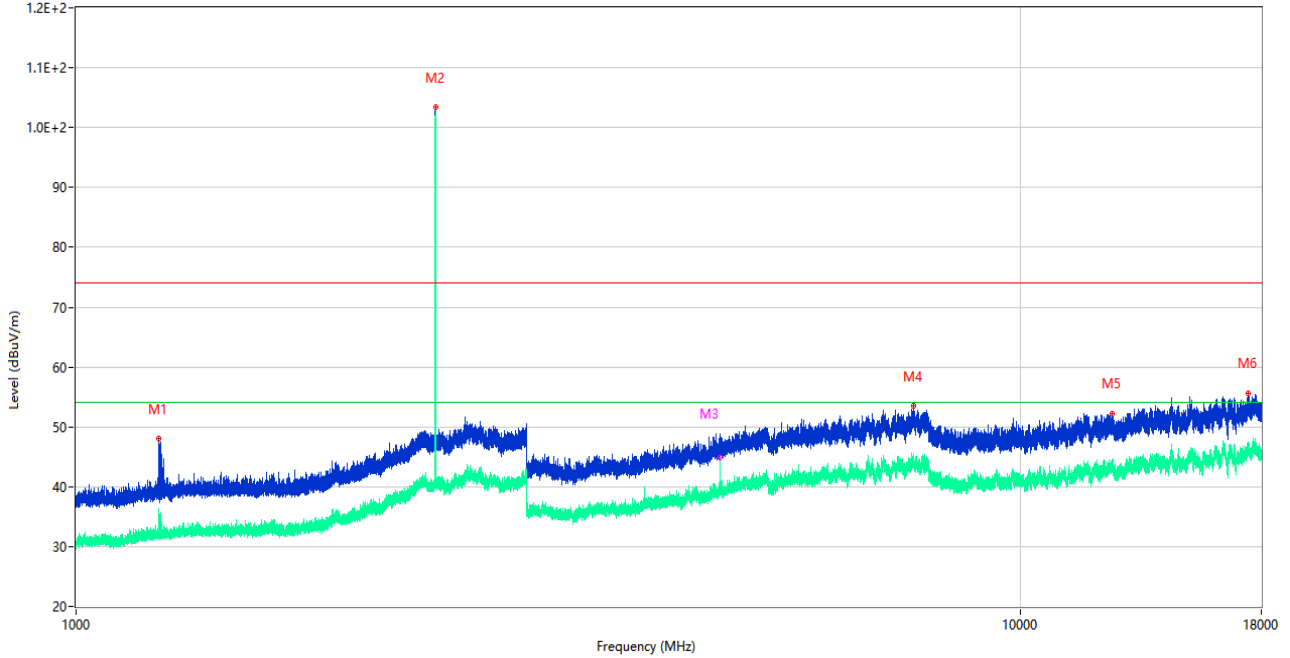

No.	Frequency (MHz)	Results (dBuV/m)	Factor (dB)	Limit (dBuV/m)	Margin (dB)	Detector	Table (Degree)	Height (cm)	Antenna	Verdict
1	1223.900	47.99	-17.68	74.0	26.01	Peak	322.00	400	Horizontal	Pass
1**	1223.900	31.57	-17.68	54.0	22.43	AV	322.00	400	Horizontal	Pass
2	2402.000	103.41	-10.61	74.0	-29.41	Peak	115.00	200	Horizontal	N/A
2**	2402.000	102.90	-10.61	54.0	-48.90	AV	115.00	200	Horizontal	N/A
3	4804.000	47.97	-3.32	74.0	26.03	Peak	163.00	100	Horizontal	Pass
3**	4804.000	44.80	-3.32	54.0	9.20	AV	163.00	100	Horizontal	Pass
4	7703.000	53.44	1.14	74.0	20.56	Peak	256.00	400	Horizontal	Pass
4**	7703.000	43.78	1.14	54.0	10.22	AV	256.00	400	Horizontal	Pass
5	12497.299	52.27	1.42	74.0	21.73	Peak	165.00	400	Horizontal	Pass
5**	12497.299	42.85	1.42	54.0	11.15	AV	165.00	400	Horizontal	Pass
6	17433.526	55.68	5.52	74.0	18.32	Peak	273.00	300	Horizontal	Pass
6**	17433.526	46.59	5.52	54.0	7.41	AV	273.00	300	Horizontal	Pass

GFSK LOW CHANNEL 1 GHz to 18 GHz, ANT V

RE Test case_FCC Part 15C_FCC 15.247(2.4G)_1GHz-18GHz

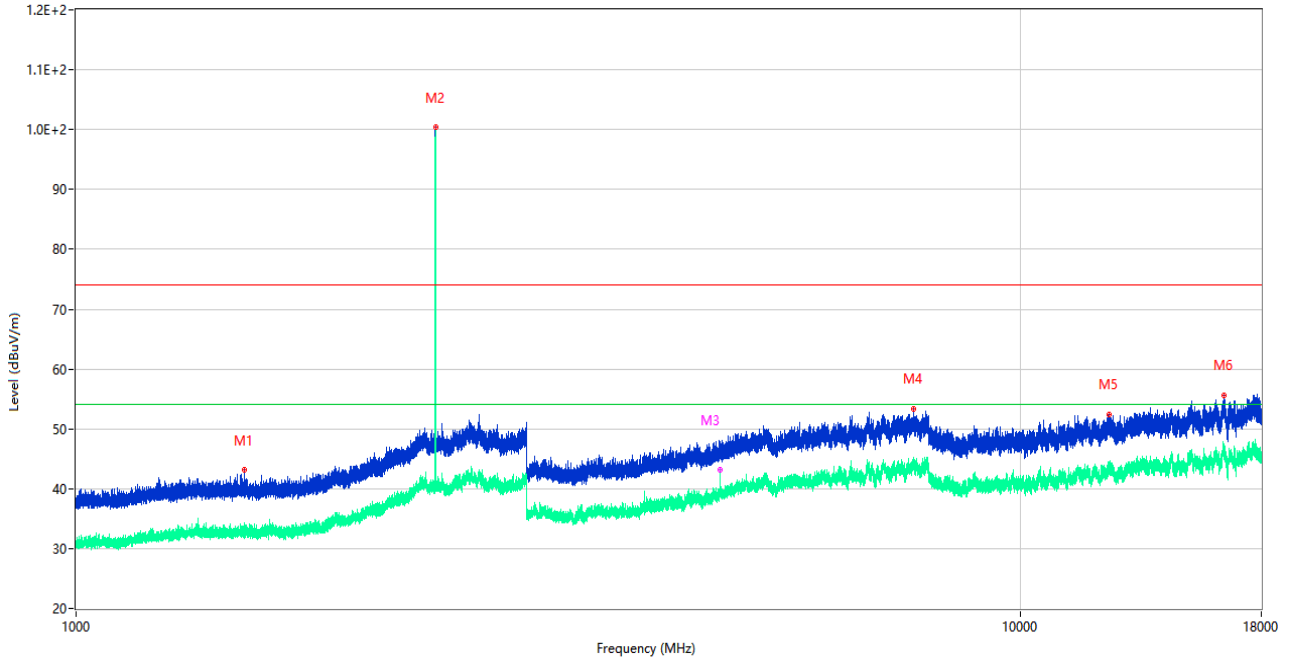

No.	Frequency (MHz)	Results (dBuV/m)	Factor (dB)	Limit (dBuV/m)	Margin (dB)	Detector	Table (Degree)	Height (cm)	Antenna	Verdict
1	1508.600	43.11	-17.07	74.0	30.89	Peak	115.00	300	Vertical	Pass
1**	1508.600	33.00	-17.07	54.0	21.00	AV	115.00	300	Vertical	Pass
2	2401.900	100.36	-10.62	74.0	-26.36	Peak	274.00	100	Vertical	N/A
2**	2401.900	99.93	-10.62	54.0	-45.93	AV	274.00	100	Vertical	N/A
3	4804.250	47.38	-3.21	74.0	26.62	Peak	136.00	100	Vertical	Pass
3**	4804.250	43.11	-3.21	54.0	10.89	AV	136.00	100	Vertical	Pass
4	7707.500	53.34	1.49	74.0	20.66	Peak	295.00	300	Vertical	Pass
4**	7707.500	44.90	1.49	54.0	9.10	AV	295.00	300	Vertical	Pass
5	12421.300	52.46	1.08	74.0	21.54	Peak	41.00	100	Vertical	Pass
5**	12421.300	42.97	1.08	54.0	11.03	AV	41.00	100	Vertical	Pass
6	16442.063	55.60	2.60	74.0	18.40	Peak	232.00	200	Vertical	Pass
6**	16442.063	45.51	2.60	54.0	8.49	AV	232.00	200	Vertical	Pass

GFSK MIDDLE CHANNEL 1 GHz to 18 GHz, ANT H

RE Test case_FCC Part 15C_FCC 15.247(2.4G)_1GHz-18GHz

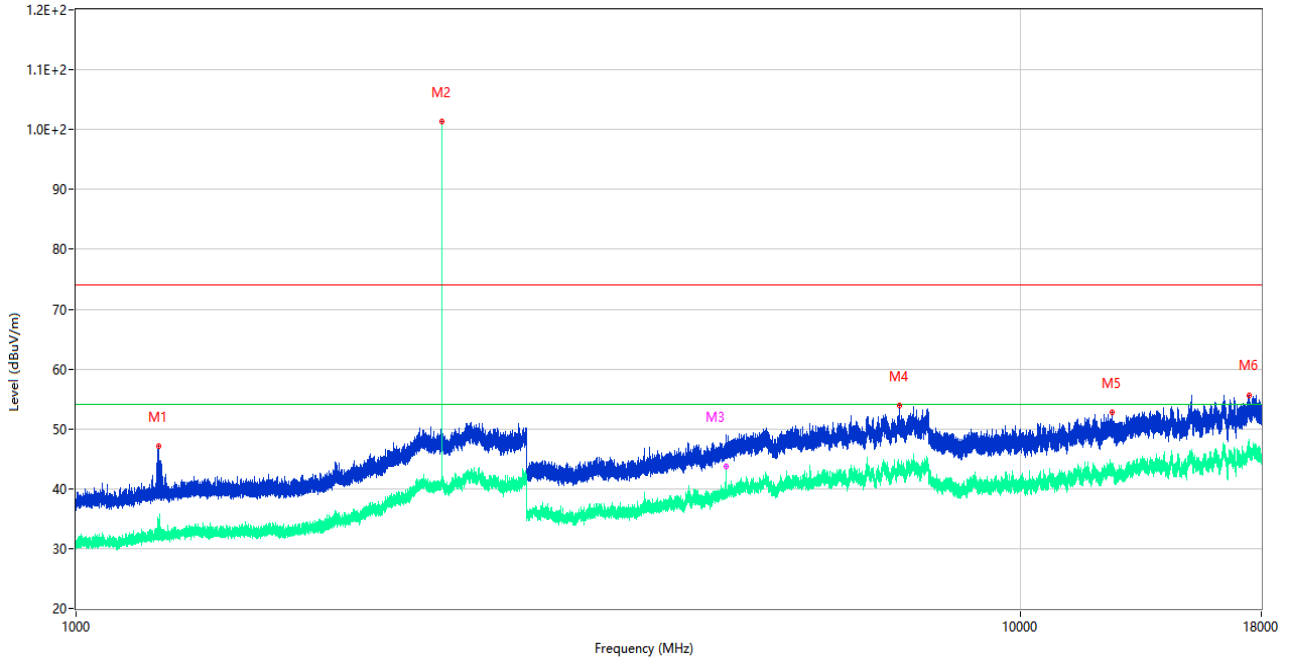

No.	Frequency (MHz)	Results (dBuV/m)	Factor (dB)	Limit (dBuV/m)	Margin (dB)	Detector	Table (Degree)	Height (cm)	Antenna	Verdict
1	1224.700	47.09	-17.51	74.0	26.91	Peak	86.00	300	Horizontal	Pass
1**	1224.700	31.74	-17.51	54.0	22.26	AV	86.00	300	Horizontal	Pass
2	2441.100	101.28	-9.79	74.0	-27.28	Peak	106.00	100	Horizontal	N/A
2**	2441.100	100.89	-9.79	54.0	-46.89	AV	106.00	100	Horizontal	N/A
3	4882.250	49.03	-3.72	74.0	24.97	Peak	205.00	100	Horizontal	Pass
3**	4882.250	43.77	-3.72	54.0	10.23	AV	205.00	100	Horizontal	Pass
4	7446.750	53.83	0.47	74.0	20.17	Peak	327.00	300	Horizontal	Pass
4**	7446.750	43.46	0.47	54.0	10.54	AV	327.00	300	Horizontal	Pass
5	12507.513	52.76	1.40	74.0	21.24	Peak	188.00	100	Horizontal	Pass
5**	12507.513	42.85	1.40	54.0	11.15	AV	188.00	100	Horizontal	Pass
6	17456.099	55.62	5.45	74.0	18.38	Peak	57.00	200	Horizontal	Pass
6**	17456.099	46.62	5.45	54.0	7.38	AV	57.00	200	Horizontal	Pass

GFSK MIDDLE CHANNEL 1 GHz to 18 GHz, ANT V

RE Test case_FCC Part 15C_FCC 15.247(2.4G)_1GHz-18GHz

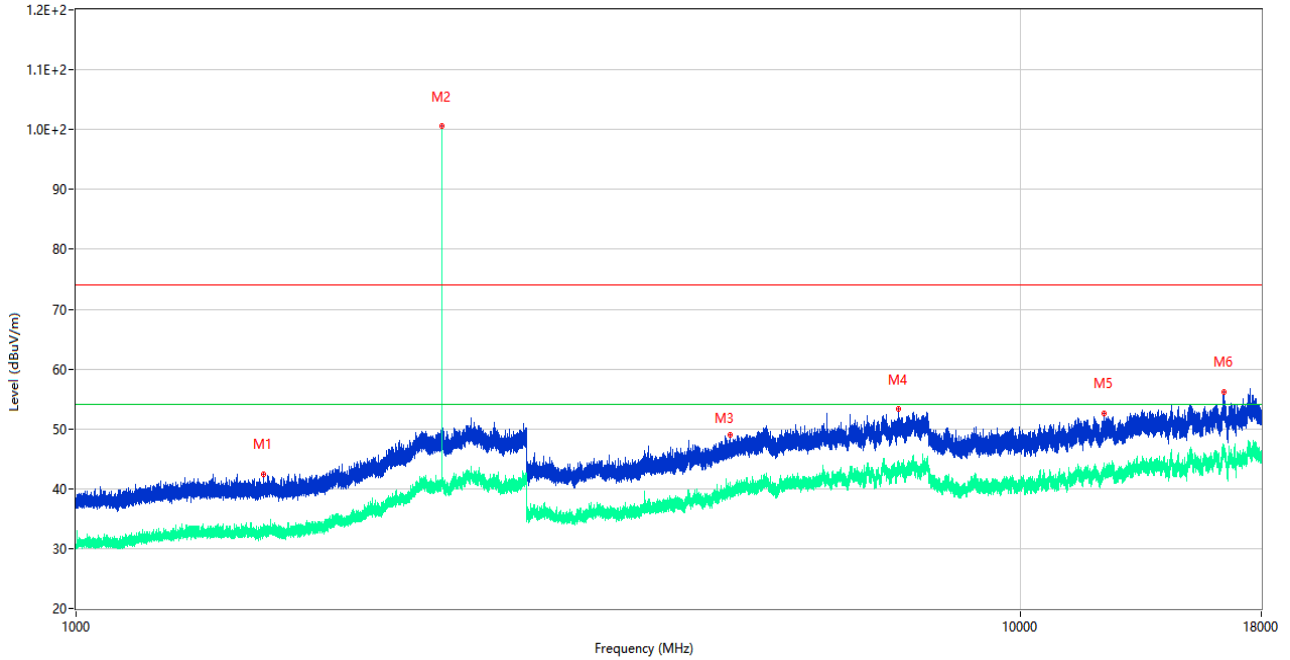

No.	Frequency (MHz)	Results (dBuV/m)	Factor (dB)	Limit (dBuV/m)	Margin (dB)	Detector	Table (Degree)	Height (cm)	Antenna	Verdict
1	1581.300	42.45	-16.95	74.0	31.55	Peak	152.00	300	Vertical	Pass
1**	1581.300	32.77	-16.95	54.0	21.23	AV	152.00	300	Vertical	Pass
2	2441.000	100.54	-9.79	74.0	-26.54	Peak	269.00	100	Vertical	N/A
2**	2441.000	100.22	-9.79	54.0	-46.22	AV	269.00	100	Vertical	N/A
3	4928.750	48.96	-3.66	74.0	25.04	Peak	123.00	100	Vertical	Pass
3**	4928.750	38.33	-3.66	54.0	15.67	AV	123.00	100	Vertical	Pass
4	7422.750	53.31	1.46	74.0	20.69	Peak	327.00	200	Vertical	Pass
4**	7422.750	43.79	1.46	54.0	10.21	AV	327.00	200	Vertical	Pass
5	12277.613	52.62	0.80	74.0	21.38	Peak	140.00	100	Vertical	Pass
5**	12277.613	43.48	0.80	54.0	10.52	AV	140.00	100	Vertical	Pass
6	16432.874	56.24	2.73	74.0	17.76	Peak	305.00	300	Vertical	Pass
6**	16432.874	45.63	2.73	54.0	8.37	AV	305.00	300	Vertical	Pass

GFSK HIGH CHANNEL 1 GHz to 18 GHz, ANT H

RE Test case_FCC Part 15C_FCC 15.247(2.4G)_1GHz-18GHz

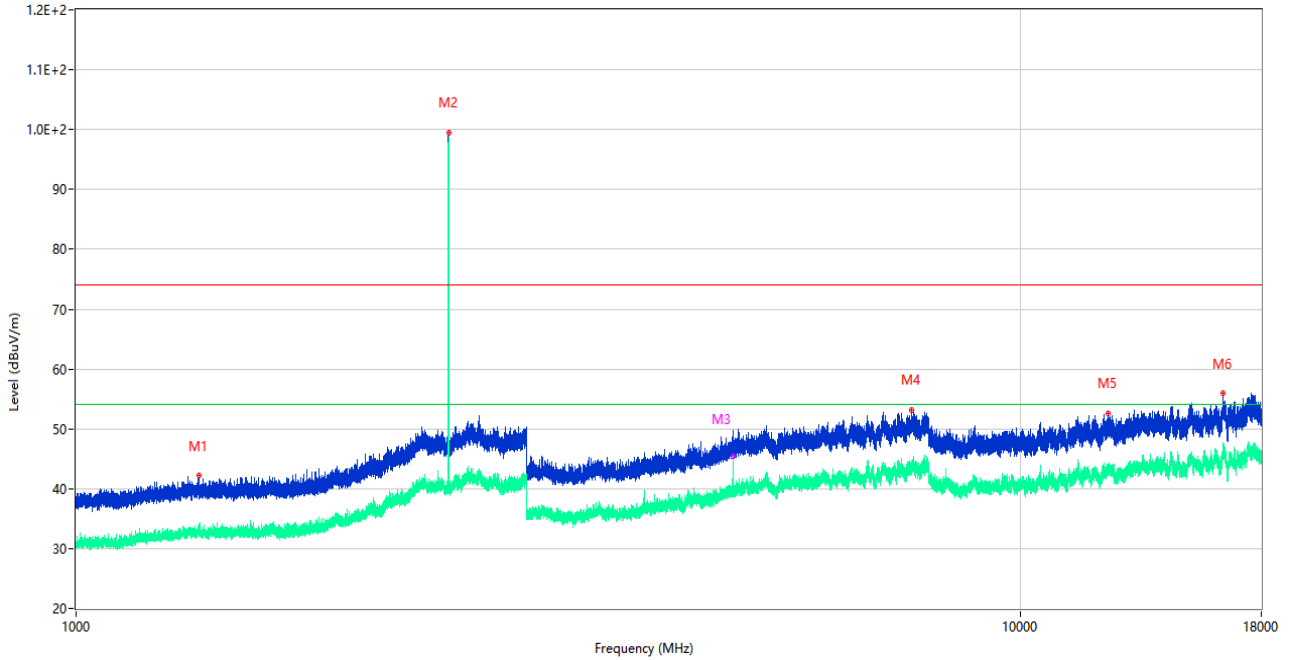

No.	Frequency (MHz)	Results (dBuV/m)	Factor (dB)	Limit (dBuV/m)	Margin (dB)	Detector	Table (Degree)	Height (cm)	Antenna	Verdict
1	1348.900	42.20	-16.78	74.0	31.80	Peak	68.00	200	Horizontal	Pass
1**	1348.900	33.17	-16.78	54.0	20.83	AV	68.00	200	Horizontal	Pass
2	2480.000	99.53	-11.11	74.0	-25.53	Peak	95.00	150	Horizontal	N/A
2**	2480.000	99.00	-11.11	54.0	-45.00	AV	95.00	150	Horizontal	N/A
3	4960.000	49.38	-3.53	74.0	24.62	Peak	221.00	150	Horizontal	Pass
3**	4960.000	45.50	-3.53	54.0	8.50	AV	221.00	150	Horizontal	Pass
4	7678.000	53.14	1.17	74.0	20.86	Peak	1.00	200	Horizontal	Pass
4**	7678.000	44.41	1.17	54.0	9.59	AV	1.00	200	Horizontal	Pass
5	12386.388	52.66	1.04	74.0	21.34	Peak	300.00	300	Horizontal	Pass
5**	12386.388	42.84	1.04	54.0	11.16	AV	300.00	300	Horizontal	Pass
6	16412.136	55.91	3.00	74.0	18.09	Peak	344.00	400	Horizontal	Pass
6**	16412.136	46.41	3.00	54.0	7.59	AV	344.00	400	Horizontal	Pass

GFSK HIGH CHANNEL 1 GHz to 18 GHz, ANT V

RE Test case_FCC Part 15C_FCC 15.247(2.4G)_1GHz-18GHz

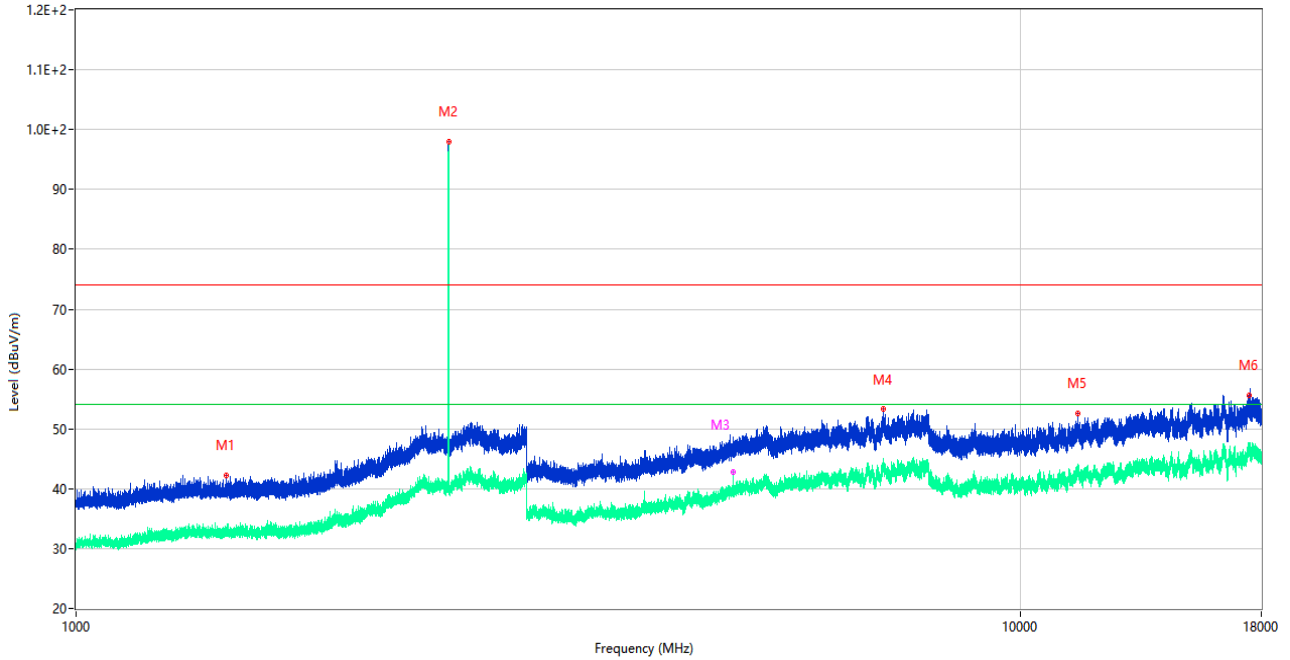

No.	Frequency (MHz)	Results (dBuV/m)	Factor (dB)	Limit (dBuV/m)	Margin (dB)	Detector	Table (Degree)	Height (cm)	Antenna	Verdict
1	1443.100	42.27	-16.86	74.0	31.73	Peak	171.00	400	Vertical	Pass
1**	1443.100	32.11	-16.86	54.0	21.89	AV	171.00	400	Vertical	Pass
2	2480.000	98.04	-11.11	74.0	-24.04	Peak	270.00	100	Vertical	N/A
2**	2480.000	97.61	-11.11	54.0	-43.61	AV	270.00	100	Vertical	N/A
3	4960.000	47.58	-3.53	74.0	26.42	Peak	161.00	150	Vertical	Pass
3**	4960.000	42.84	-3.53	54.0	11.16	AV	161.00	150	Vertical	Pass
4	7167.250	53.25	0.64	74.0	20.75	Peak	281.00	400	Vertical	Pass
4**	7167.250	44.28	0.64	54.0	9.72	AV	281.00	400	Vertical	Pass
5	11508.112	52.63	-0.70	74.0	21.37	Peak	334.00	300	Vertical	Pass
5**	11508.112	42.43	-0.70	54.0	11.57	AV	334.00	300	Vertical	Pass
6	17460.562	55.62	5.37	74.0	18.38	Peak	293.00	100	Vertical	Pass
6**	17460.562	46.89	5.37	54.0	7.11	AV	293.00	100	Vertical	Pass

8-DPSK LOW CHANNEL 1 GHz to 18 GHz, ANT H

RE Test case_FCC Part 15C_FCC 15.247(2.4G)_1GHz-18GHz

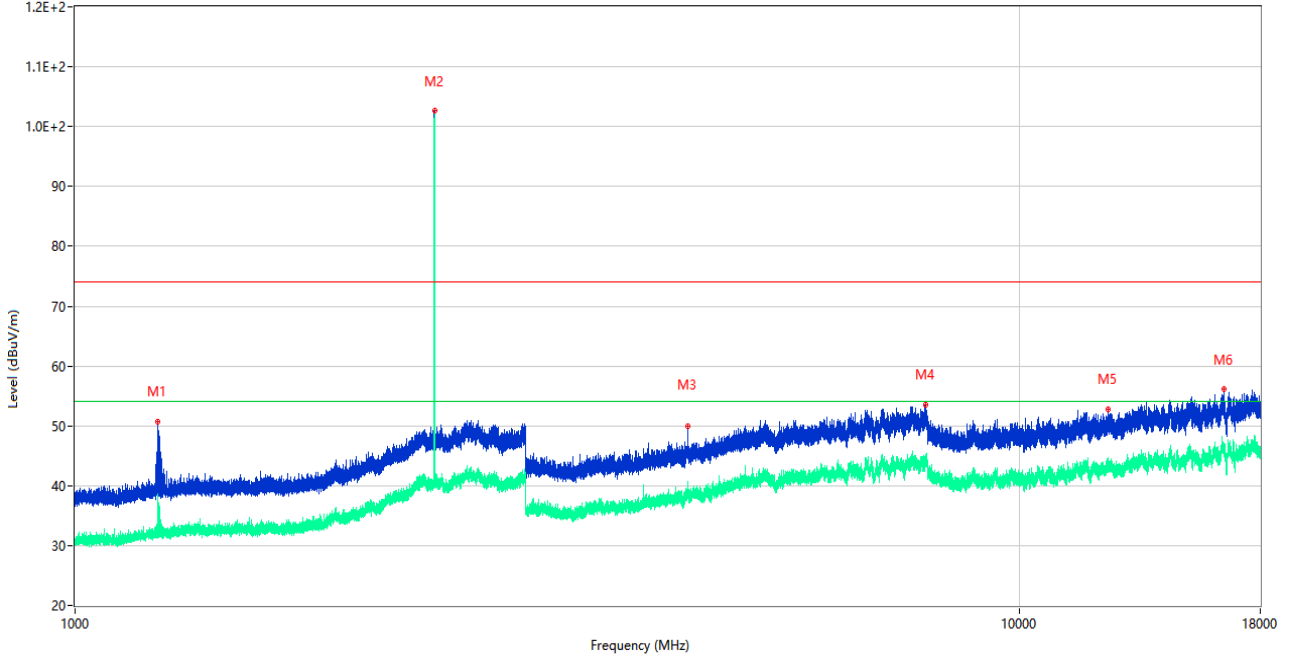

No.	Frequency (MHz)	Results (dBuV/m)	Factor (dB)	Limit (dBuV/m)	Margin (dB)	Detector	Table (Degree)	Height (cm)	Antenna	Verdict
1	1223.100	50.79	-17.46	74.0	23.21	Peak	101.00	200	Horizontal	Pass
1**	1223.100	32.00	-17.46	54.0	22.00	AV	101.00	200	Horizontal	Pass
2	2402.200	102.58	-10.59	74.0	-28.58	Peak	128.00	200	Horizontal	N/A
2**	2402.200	101.99	-10.59	54.0	-47.99	AV	128.00	200	Horizontal	N/A
3	4454.250	50.03	-3.86	74.0	23.97	Peak	80.00	200	Horizontal	Pass
3**	4454.250	39.87	-3.86	54.0	14.13	AV	80.00	200	Horizontal	Pass
4	7966.000	53.60	2.09	74.0	20.40	Peak	19.00	400	Horizontal	Pass
4**	7966.000	44.95	2.09	54.0	9.05	AV	19.00	400	Horizontal	Pass
5	12410.138	52.82	1.09	74.0	21.18	Peak	18.00	400	Horizontal	Pass
5**	12410.138	43.25	1.09	54.0	10.75	AV	18.00	400	Horizontal	Pass
6	16456.500	56.09	2.28	74.0	17.91	Peak	359.00	300	Horizontal	Pass
6**	16456.500	45.90	2.28	54.0	8.10	AV	359.00	300	Horizontal	Pass

8-DPSK LOW CHANNEL 1 GHz to 18 GHz, ANT V

RE Test case_FCC Part 15C_FCC 15.247(2.4G)_1GHz-18GHz

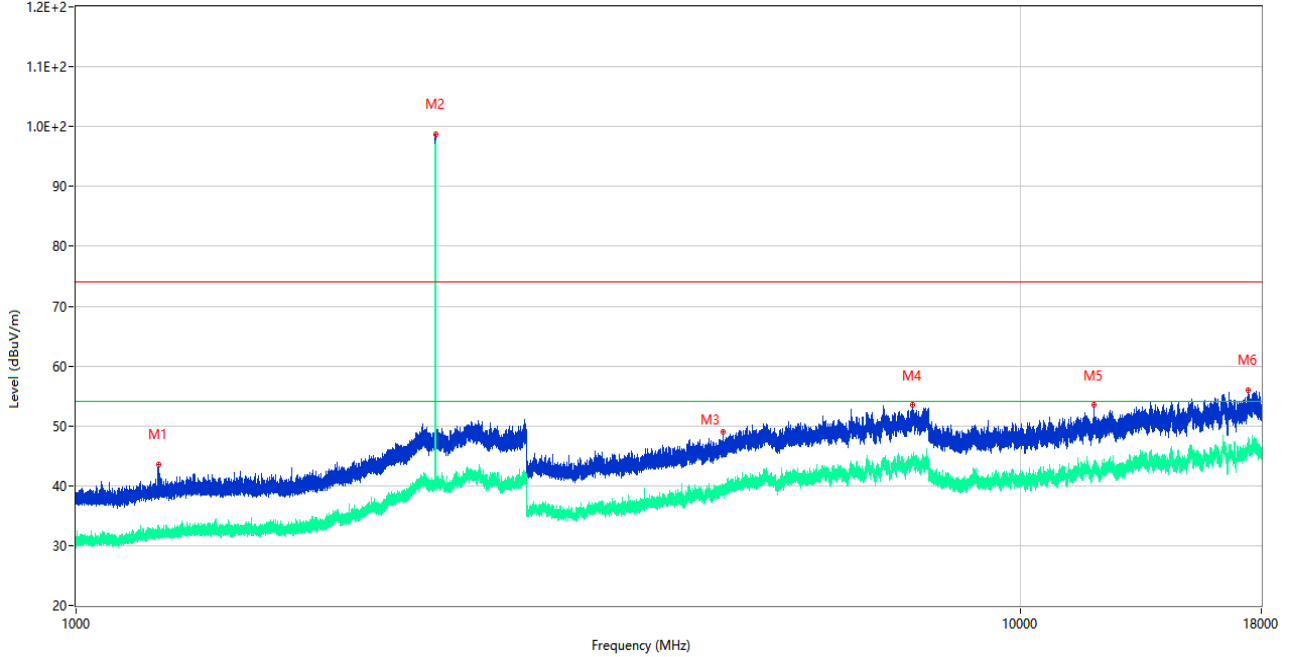

No.	Frequency (MHz)	Results (dBuV/m)	Factor (dB)	Limit (dBuV/m)	Margin (dB)	Detector	Table (Degree)	Height (cm)	Antenna	Verdict
1	1224.100	43.60	-17.75	74.0	30.40	Peak	190.00	400	Vertical	Pass
1**	1224.100	31.95	-17.75	54.0	22.05	AV	190.00	400	Vertical	Pass
2	2401.800	98.74	-10.63	74.0	-24.74	Peak	281.00	150	Vertical	N/A
2**	2401.800	97.64	-10.63	54.0	-43.64	AV	281.00	150	Vertical	N/A
3	4847.250	48.99	-3.53	74.0	25.01	Peak	0.00	100	Vertical	Pass
3**	4847.250	39.49	-3.53	54.0	14.51	AV	0.00	100	Vertical	Pass
4	7699.750	53.45	1.14	74.0	20.55	Peak	299.00	100	Vertical	Pass
4**	7699.750	44.48	1.14	54.0	9.52	AV	299.00	100	Vertical	Pass
5	11970.288	53.45	-0.18	74.0	20.55	Peak	113.00	200	Vertical	Pass
5**	11970.288	42.80	-0.18	54.0	11.20	AV	113.00	200	Vertical	Pass
6	17431.949	56.05	5.52	74.0	17.95	Peak	71.00	300	Vertical	Pass
6**	17431.949	46.34	5.52	54.0	7.66	AV	71.00	300	Vertical	Pass

8-DPSK MIDDLE CHANNEL 1 GHz to 18 GHz, ANT H

RE Test case_FCC Part 15C_FCC 15.247(2.4G)_1GHz-18GHz

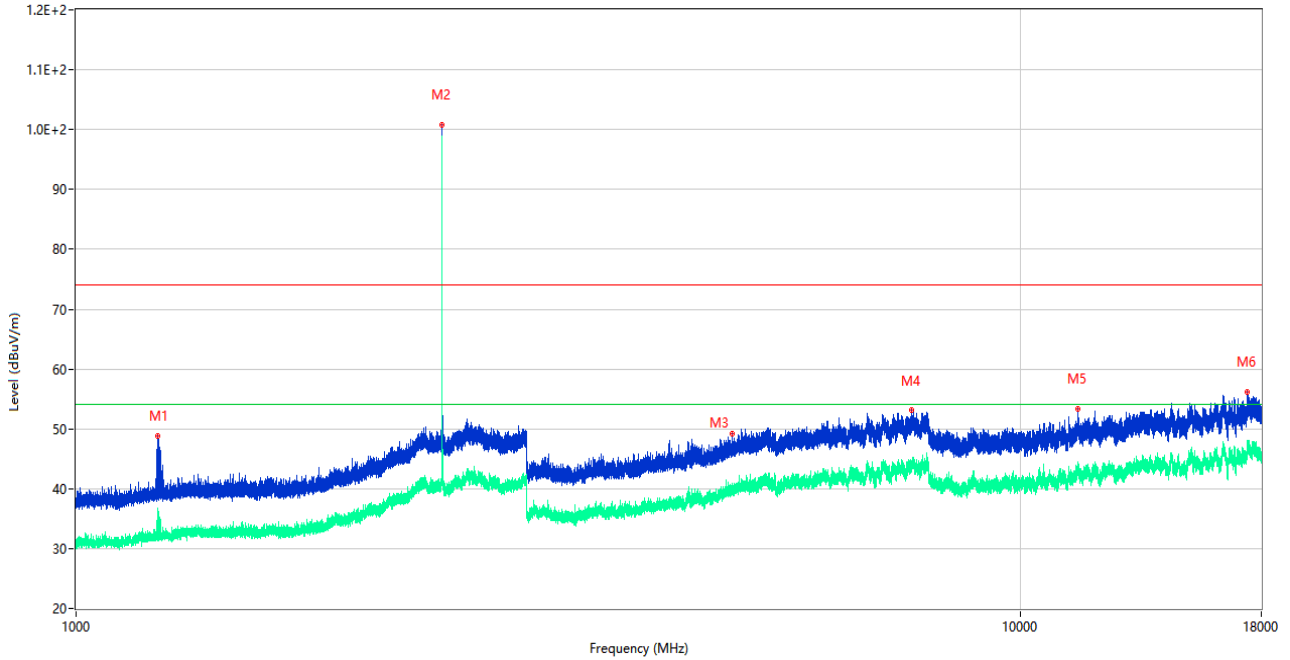

No.	Frequency (MHz)	Results (dBuV/m)	Factor (dB)	Limit (dBuV/m)	Margin (dB)	Detector	Table (Degree)	Height (cm)	Antenna	Verdict
1	1221.000	48.89	-17.30	74.0	25.11	Peak	67.00	400	Horizontal	Pass
1**	1221.000	32.17	-17.30	54.0	21.83	AV	67.00	400	Horizontal	Pass
2	2440.900	100.88	-9.79	74.0	-26.88	Peak	103.00	200	Horizontal	N/A
2**	2440.900	97.94	-9.79	54.0	-43.94	AV	103.00	200	Horizontal	N/A
3	4951.750	49.23	-3.65	74.0	24.77	Peak	313.00	100	Horizontal	Pass
3**	4951.750	39.71	-3.65	54.0	14.29	AV	313.00	100	Horizontal	Pass
4	7674.500	53.13	0.73	74.0	20.87	Peak	70.00	200	Horizontal	Pass
4**	7674.500	44.39	0.73	54.0	9.61	AV	70.00	200	Horizontal	Pass
5	11499.563	53.40	-0.60	74.0	20.60	Peak	217.00	100	Horizontal	Pass
5**	11499.563	43.42	-0.60	54.0	10.58	AV	217.00	100	Horizontal	Pass
6	17394.412	56.17	5.17	74.0	17.83	Peak	119.00	300	Horizontal	Pass
6**	17394.412	45.32	5.17	54.0	8.68	AV	119.00	300	Horizontal	Pass

8-DPSK MIDDLE CHANNEL 1 GHz to 18 GHz, ANT V

RE Test case_FCC Part 15C_FCC 15.247(2.4G)_1GHz-18GHz

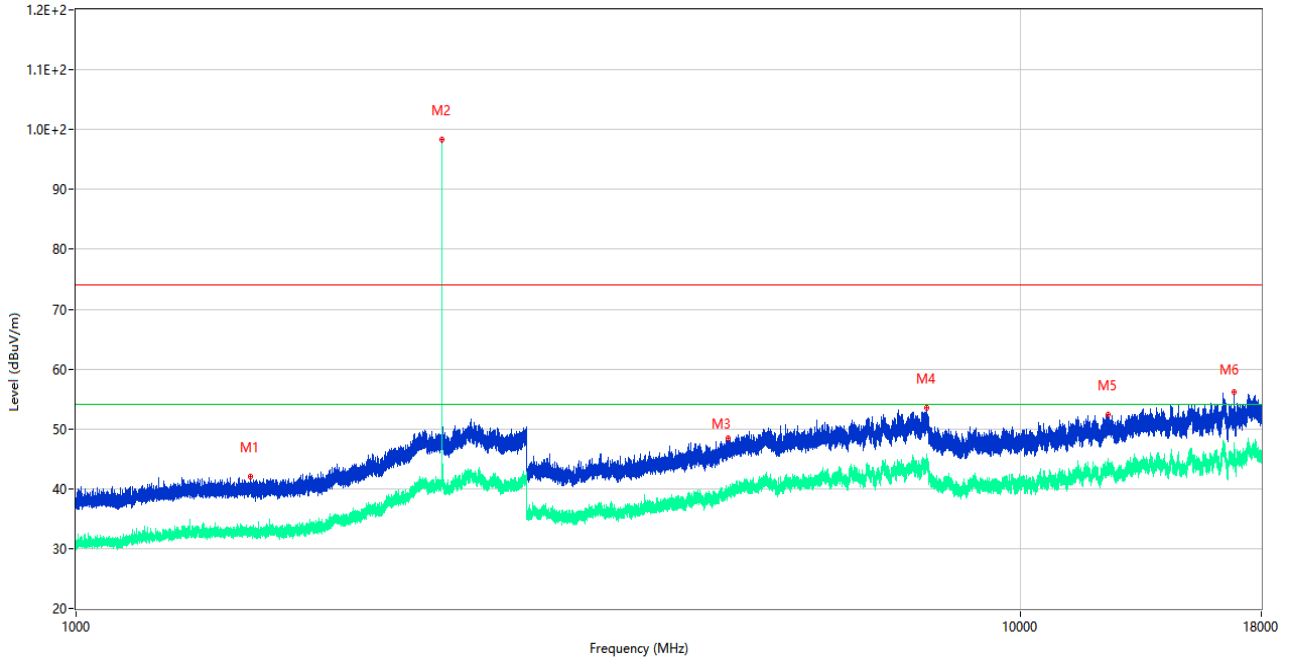

No.	Frequency (MHz)	Results (dBuV/m)	Factor (dB)	Limit (dBuV/m)	Margin (dB)	Detector	Table (Degree)	Height (cm)	Antenna	Verdict
1	1528.700	41.96	-17.22	74.0	32.04	Peak	360.00	200	Vertical	Pass
1**	1528.700	32.62	-17.22	54.0	21.38	AV	360.00	200	Vertical	Pass
2	2440.800	98.25	-9.79	74.0	-24.25	Peak	271.00	100	Vertical	N/A
2**	2440.800	97.07	-9.79	54.0	-43.07	AV	271.00	100	Vertical	N/A
3	4905.500	48.44	-3.31	74.0	25.56	Peak	323.00	150	Vertical	Pass
3**	4905.500	39.67	-3.31	54.0	14.33	AV	323.00	150	Vertical	Pass
4	7964.000	53.50	1.96	74.0	20.50	Peak	62.00	300	Vertical	Pass
4**	7964.000	45.07	1.96	54.0	8.93	AV	62.00	300	Vertical	Pass
5	12386.388	52.32	1.04	74.0	21.68	Peak	202.00	200	Vertical	Pass
5**	12386.388	43.14	1.04	54.0	10.86	AV	202.00	200	Vertical	Pass
6	16843.949	56.13	3.31	74.0	17.87	Peak	33.00	100	Vertical	Pass
6**	16843.949	45.40	3.31	54.0	8.60	AV	33.00	100	Vertical	Pass

8-DPSK HIGH CHANNEL 1 GHz to 18 GHz, ANT H

RE Test case_FCC Part 15C_FCC 15.247(2.4G)_1GHz-18GHz

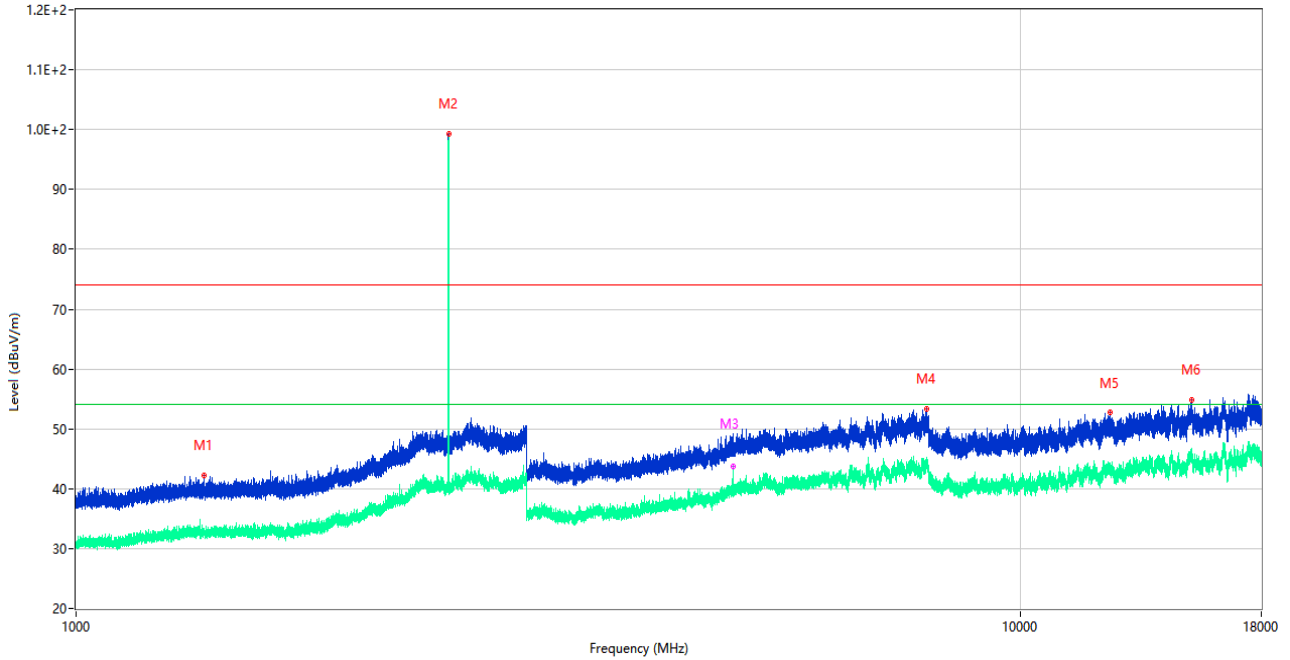

No.	Frequency (MHz)	Results (dBuV/m)	Factor (dB)	Limit (dBuV/m)	Margin (dB)	Detector	Table (Degree)	Height (cm)	Antenna	Verdict
1	1364.900	42.29	-17.13	74.0	31.71	Peak	225.00	400	Horizontal	Pass
1**	1364.900	32.31	-17.13	54.0	21.69	AV	225.00	400	Horizontal	Pass
2	2480.100	99.36	-11.10	74.0	-25.36	Peak	101.00	100	Horizontal	N/A
2**	2480.100	98.98	-11.10	54.0	-44.98	AV	101.00	100	Horizontal	N/A
3	4960.250	48.58	-3.64	74.0	25.42	Peak	199.00	100	Horizontal	Pass
3**	4960.250	43.75	-3.64	54.0	10.25	AV	199.00	100	Horizontal	Pass
4	7964.500	53.34	2.22	74.0	20.66	Peak	360.00	300	Horizontal	Pass
4**	7964.500	45.15	2.22	54.0	8.85	AV	360.00	300	Horizontal	Pass
5	12443.388	52.69	1.05	74.0	21.31	Peak	287.00	200	Horizontal	Pass
5**	12443.388	43.45	1.05	54.0	10.55	AV	287.00	200	Horizontal	Pass
6	15183.638	54.87	2.94	74.0	19.13	Peak	1.00	400	Horizontal	Pass
6**	15183.638	44.64	2.94	54.0	9.36	AV	1.00	400	Horizontal	Pass

8-DPSK HIGH CHANNEL 1 GHz to 18 GHz, ANT V

RE Test case_FCC Part 15C_FCC 15.247(2.4G)_1GHz-18GHz

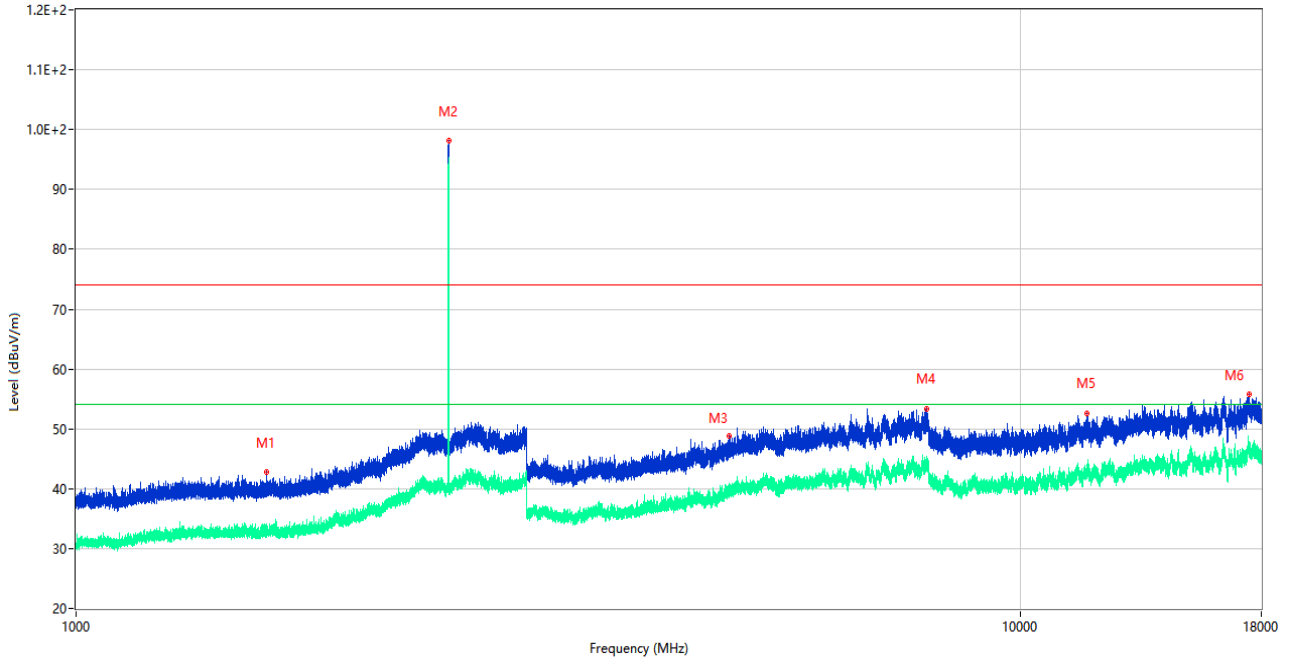

No.	Frequency (MHz)	Results (dBuV/m)	Factor (dB)	Limit (dBuV/m)	Margin (dB)	Detector	Table (Degree)	Height (cm)	Antenna	Verdict
1	1592.700	42.70	-16.50	74.0	31.30	Peak	294.00	100	Vertical	Pass
1**	1592.700	33.40	-16.50	54.0	20.60	AV	294.00	100	Vertical	Pass
2	2480.000	98.11	-11.11	74.0	-24.11	Peak	272.00	150	Vertical	N/A
2**	2480.000	95.28	-11.11	54.0	-41.28	AV	272.00	150	Vertical	N/A
3	4910.750	48.86	-3.44	74.0	25.14	Peak	109.00	100	Vertical	Pass
3**	4910.750	39.53	-3.44	54.0	14.47	AV	109.00	100	Vertical	Pass
4	7964.250	53.35	2.13	74.0	20.65	Peak	330.00	200	Vertical	Pass
4**	7964.250	44.49	2.13	54.0	9.51	AV	330.00	200	Vertical	Pass
5	11751.075	52.58	-0.19	74.0	21.42	Peak	268.00	400	Vertical	Pass
5**	11751.075	42.69	-0.19	54.0	11.31	AV	268.00	400	Vertical	Pass
6	17491.800	55.77	4.79	74.0	18.23	Peak	21.00	400	Vertical	Pass
6**	17491.800	46.69	4.79	54.0	7.31	AV	21.00	400	Vertical	Pass

A.9 Band Edge (Restricted-band band-edge)

Note ¹: The lowest and highest channels are tested to verify the band edge emissions. Please refer to the following the plots for emissions values.

Note ²: The test data all are tested in the vertical and horizontal antenna which the trace is max hold. So these plots have shown the worst case.

Note ³: According the ANSI C63.10-2013, where limits are specified for both average and peak (or quasi-peak) detector functions, if the peak (or quasi-peak) measured value complies with the average limit, it is unnecessary to perform an average measurement.

Note ⁴: The Level (dBuV/m) has been corrected by factor.

Test Data and Plots

GFSK LOW CHANNEL

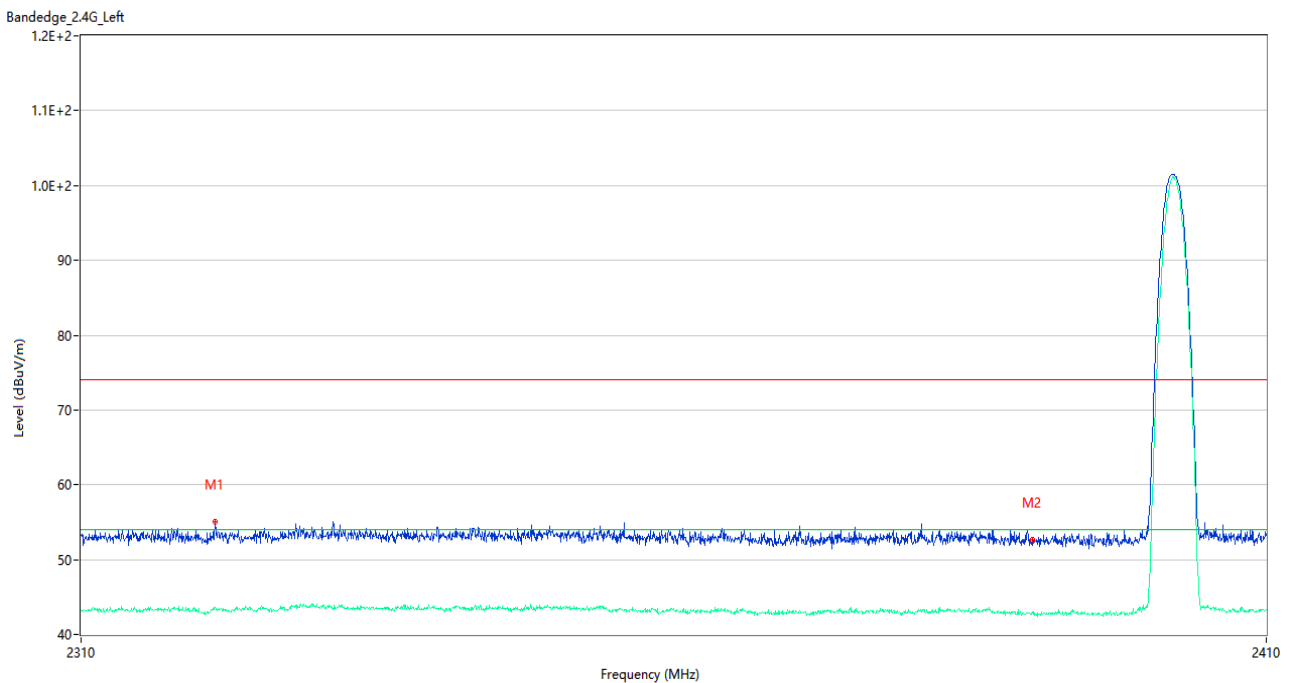

No.	Frequency (MHz)	Results (dBuV/m)	Factor (dB)	Limit (dBuV/m)	Margin (dB)	Detector	Table (Degree)	Height (cm)	Antenna	Verdict
1	2321.100	55.11	-1.16	74.0	18.89	Peak	307.00	150	Horizontal	Pass
1**	2321.100	43.56	-1.16	54.0	10.44	AV	307.00	150	Horizontal	Pass
2	2389.950	52.63	-1.82	74.0	21.37	Peak	348.00	150	Horizontal	Pass
2**	2389.950	42.81	-1.82	54.0	11.19	AV	348.00	150	Horizontal	Pass

GFSK HIGH CHANNEL

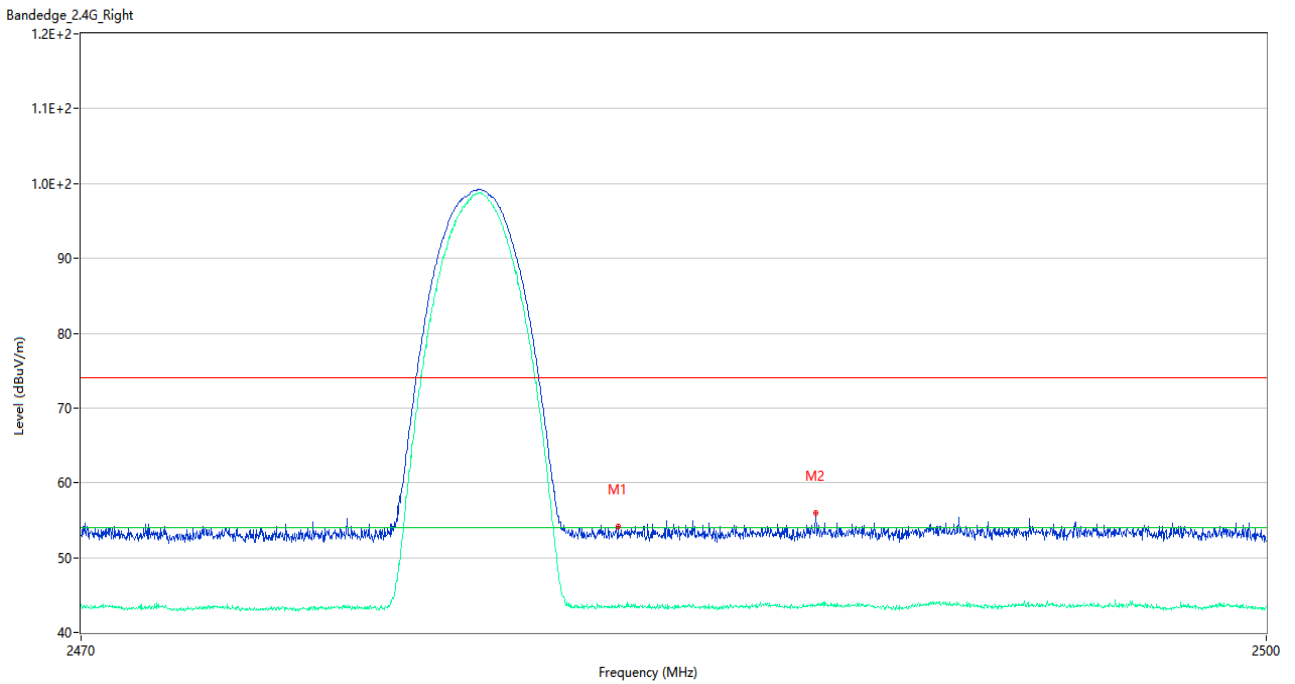

No.	Frequency (MHz)	Results (dBuV/m)	Factor (dB)	Limit (dBuV/m)	Margin (dB)	Detector	Table (Degree)	Height (cm)	Antenna	Verdict
1	2483.545	54.12	-1.09	74.0	19.88	Peak	271.00	100	Horizontal	Pass
1**	2483.545	43.43	-1.09	54.0	10.57	AV	271.00	100	Horizontal	Pass
2	2488.555	55.90	-0.85	74.0	18.10	Peak	109.00	100	Horizontal	Pass
2**	2488.555	43.60	-0.85	54.0	10.40	AV	109.00	100	Horizontal	Pass

8-DPSK LOW CHANNEL

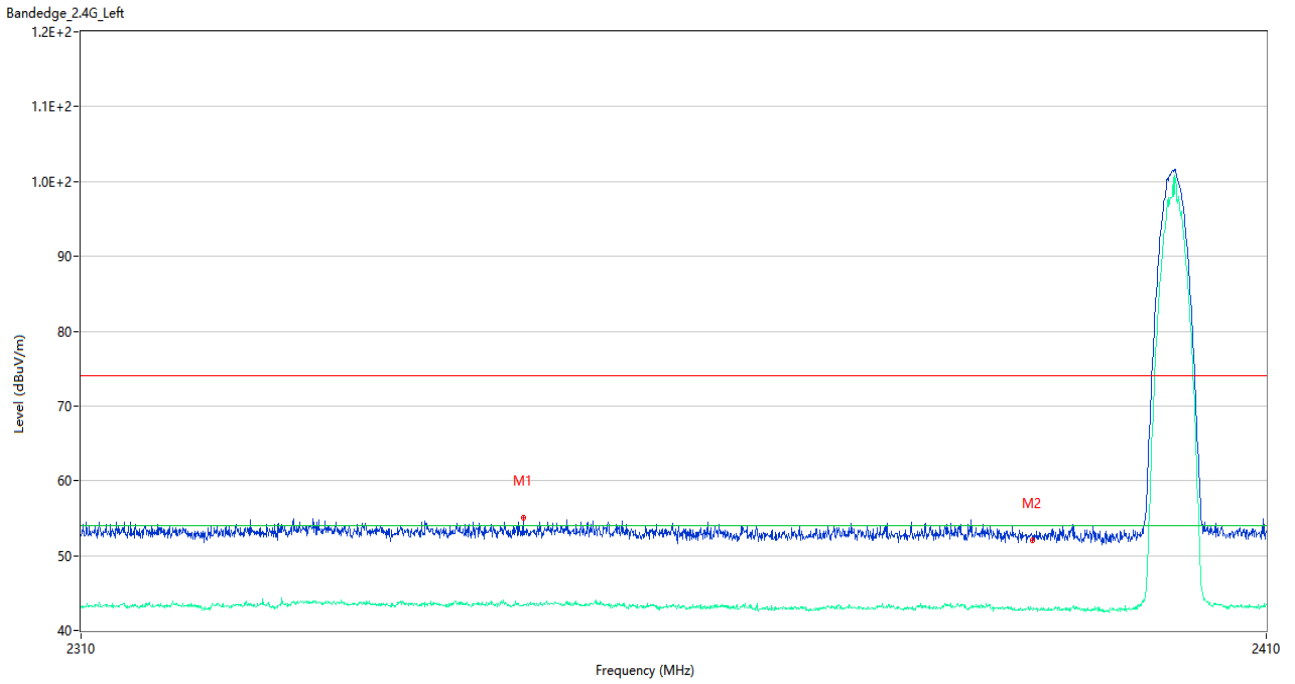

No.	Frequency (MHz)	Results (dBuV/m)	Factor (dB)	Limit (dBuV/m)	Margin (dB)	Detector	Table (Degree)	Height (cm)	Antenna	Verdict
1	2346.800	55.01	-1.10	74.0	18.99	Peak	35.00	100	Horizontal	Pass
1**	2346.800	43.40	-1.10	54.0	10.60	AV	35.00	100	Horizontal	Pass
2	2389.950	52.10	-1.82	74.0	21.90	Peak	105.00	150	Horizontal	Pass
2**	2389.950	42.67	-1.82	54.0	11.33	AV	105.00	150	Horizontal	Pass

8-DPSK HIGH CHANNEL

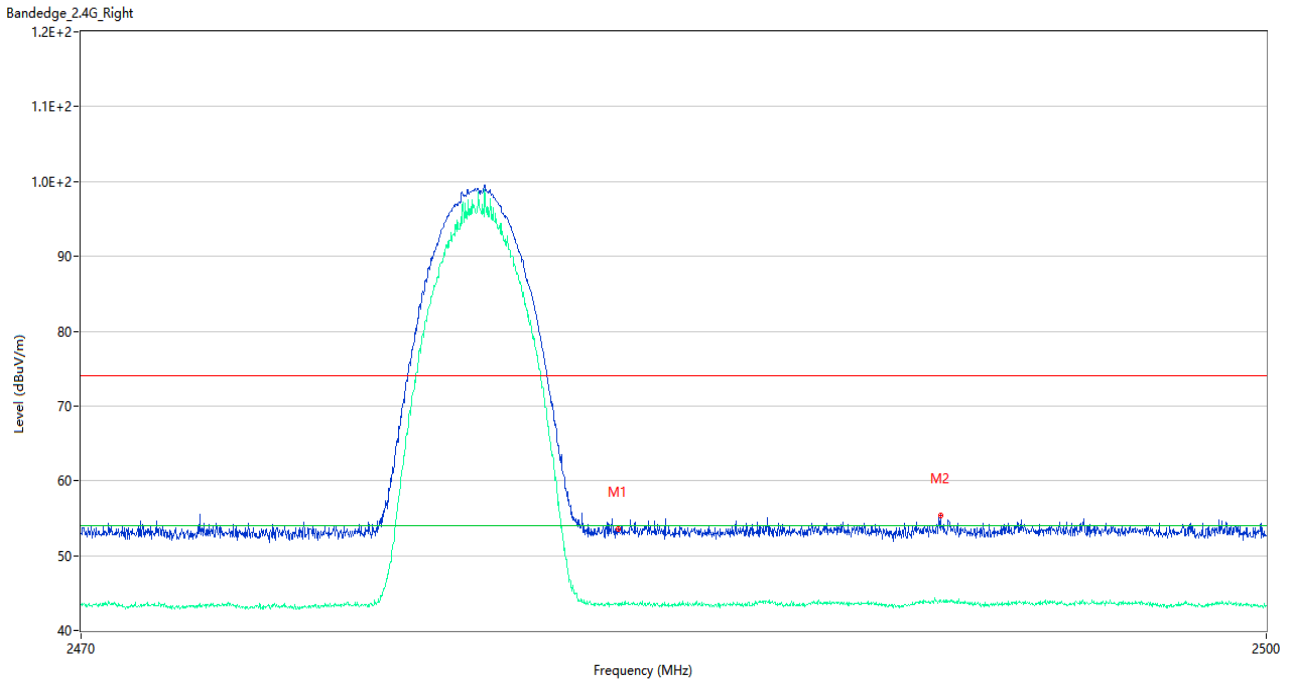

No.	Frequency (MHz)	Results (dBuV/m)	Factor (dB)	Limit (dBuV/m)	Margin (dB)	Detector	Table (Degree)	Height (cm)	Antenna	Verdict
1	2483.545	53.60	-1.09	74.0	20.40	Peak	176.00	200	Horizontal	Pass
1**	2483.545	43.55	-1.09	54.0	10.45	AV	176.00	200	Horizontal	Pass
2	2491.720	55.30	-0.67	74.0	18.70	Peak	159.00	150	Horizontal	Pass
2**	2491.720	44.09	-0.67	54.0	9.91	AV	159.00	150	Horizontal	Pass

ANNEX B TEST SETUP PHOTOS

Please refer the document “BL-SZ23C0902-AR.PDF”.

ANNEX C EUT EXTERNAL PHOTOS

Please refer the document “BL-SZ23C0902-AW.PDF”.

ANNEX D EUT INTERNAL PHOTOS

Please refer the document “BL-SZ23C0902-AI.PDF”.

Statement

1. The laboratory guarantees the scientificity, accuracy and impartiality of the test, and is responsible for all the information in the report, except the information provided by the customer. The customer is responsible for the impact of the information provided on the validity of the results.
2. The report without China inspection body and laboratory Mandatory Approval (CMA) mark has no effect of proving to the society.
3. For the report with CNAS mark or A2LA mark, the items marked with "☆" are not within the accredited scope.
4. This report is invalid if it is altered, without the signature of the testing and approval personnel, or without the "inspection and testing dedicated stamp" or test report stamp.
5. The test data and results are only valid for the tested samples provided by the customer.
6. This report shall not be partially reproduced without the written permission of the laboratory.
7. Any objection shall be raised to the laboratory within 30 days after receiving the report.

--END OF REPORT--