

TEST REPORT

Applicant: Shenzhen Tinno Mobile Technology Corp
Address: 27-001, South side of Tianlong mobile HQ Building, Tongfa South Road, Xili Street, Nanshan District, Shenzhen, Guangdong Province, 518000, China
Equipment Type: onn. 8" Tablet
Model Name: TBVAN100135923 (refer to section 2.3)
Brand Name: onn.
FCC ID: XD6WM2308T
Test Standard: 47 CFR Part 15 Subpart C (refer to section 3.1)
Sample Arrival Date: Jan. 03, 2024
Test Date: Jan. 05, 2024 - Jan. 19, 2024
Date of Issue: Jan. 24, 2024

ISSUED BY:

Shenzhen BALUN Technology Co., Ltd.

Tested by: Si Xiao

Checked by: Ye Hongji

Approved by: Liao Jianming
(Technical Director)

Si Xiao

Ye Hongji

Liao Jianming

| Revision History | | |
|-------------------------|----------------------|----------------------|
| Version | Issue Date | Revisions |
| <u>Rev. 01</u> | <u>Jan. 24, 2024</u> | <u>Initial Issue</u> |

TABLE OF CONTENTS

| | | |
|-----|--|----|
| 1 | GENERAL INFORMATION | 4 |
| 1.1 | Test Laboratory | 4 |
| 1.2 | Test Location | 4 |
| 2 | PRODUCT INFORMATION | 5 |
| 2.1 | Applicant Information | 5 |
| 2.2 | Manufacturer Information | 5 |
| 2.3 | General Description for Equipment under Test (EUT) | 5 |
| 2.4 | Technical Information | 6 |
| 3 | SUMMARY OF TEST RESULTS | 8 |
| 3.1 | Test Standards | 8 |
| 3.2 | Test Verdict | 8 |
| 4 | GENERAL TEST CONFIGURATIONS | 9 |
| 4.1 | Test Environments | 9 |
| 4.2 | Test Equipment List | 9 |
| 4.3 | Test Software List | 10 |
| 4.4 | Measurement Uncertainty | 11 |
| 4.5 | Description of Test Setup | 11 |
| 4.6 | Measurement Results Explanation Example | 14 |
| 5 | TEST ITEMS | 15 |
| 5.1 | Antenna Requirements | 15 |
| 5.2 | Output Power | 17 |
| 5.3 | Occupied Bandwidth | 19 |
| 5.4 | Conducted Spurious Emission | 20 |
| 5.5 | Band Edge (Authorized-band band-edge) | 22 |

| | | |
|---------|--|----|
| 5.6 | Conducted Emission | 24 |
| 5.7 | Radiated Spurious Emission | 25 |
| 5.8 | Band Edge (Restricted-band band-edge)..... | 30 |
| 5.9 | Power Spectral density (PSD)..... | 31 |
| ANNEX A | TEST RESULT | 32 |
| A.1 | Output Power | 32 |
| A.2 | Occupied Bandwidth | 34 |
| A.3 | Conducted Spurious Emissions | 39 |
| A.4 | Band Edge (Authorized-band band-edge)..... | 46 |
| A.5 | Conducted Emissions..... | 50 |
| A.6 | Radiated Emission | 52 |
| A.7 | Band Edge (Restricted-band band-edge)..... | 63 |
| A.8 | Power Spectral Density (PSD) | 69 |
| ANNEX B | TEST SETUP PHOTOS | 72 |
| ANNEX C | EUT EXTERNAL PHOTOS | 72 |
| ANNEX D | EUT INTERNAL PHOTOS | 72 |

1 GENERAL INFORMATION

1.1 Test Laboratory

| | |
|--------------|--|
| Name | Shenzhen BALUN Technology Co., Ltd. |
| Address | Block B, 1/F, Baisha Science and Technology Park, Shahe Xi Road, Nanshan District, Shenzhen, Guangdong Province, P. R. China |
| Phone Number | +86 755 6685 0100 |

1.2 Test Location

| | |
|---------------------------|---|
| Name | Shenzhen BALUN Technology Co., Ltd. |
| Location | <input checked="" type="checkbox"/> Block B, 1/F, Baisha Science and Technology Park, Shahe Xi Road, Nanshan District, Shenzhen, Guangdong Province, P. R. China |
| | <input type="checkbox"/> 1/F, Building B, Ganghongji High-tech Intelligent Industrial Park, No. 1008, Songbai Road, Yangguang Community, Xili Sub-district, Nanshan District, Shenzhen, Guangdong Province, P. R. China |
| Accreditation Certificate | The laboratory is a testing organization accredited by FCC as a accredited testing laboratory. The designation number is CN1196. |

2 PRODUCT INFORMATION

2.1 Applicant Information

| | |
|-----------|--|
| Applicant | Shenzhen Tinno Mobile Technology Corp |
| Address | 27-001, South side of Tianlong mobile HQ Building, Tongfa South Road, Xili Street, Nanshan District, Shenzhen, Guangdong Province, 518000, China |

2.2 Manufacturer Information

| | |
|--------------|--|
| Manufacturer | Shenzhen Tinno Mobile Technology Corp |
| Address | 27-001, South side of Tianlong mobile HQ Building, Tongfa South Road, Xili Street, Nanshan District, Shenzhen, Guangdong Province, 518000, China |

2.3 General Description for Equipment under Test (EUT)

| | |
|---|--|
| EUT Name | onn. 8" Tablet |
| Model Name Under Test | TBVAN100135923 |
| Series Model Name | TBPPY100135923, TBLVD100135923, TBIND100135923 |
| Description of Model name differentiation | All models are same with electrical parameters and internal circuit structure, but only differ in model name and color. (this information provided by the applicant) |
| Hardware Version | V1.0 |
| Software Version | T302AA_DVT_14.0_64B_FTM_07.00_00 |
| Dimensions (Approx.) | N/A |
| Weight (Approx.) | N/A |

2.4 Technical Information

| | |
|-----------------------------------|--|
| Network and Wireless connectivity | Bluetooth (BR+EDR+BLE) 2.4G WIFI 802.11b, 802.11g, 802.11n(HT20) 5G WIFI 802.11a, 802.11n(HT20/40), 802.11ac (VHT20/40/80) U-NII-1/2A/2C/3, GPS |
|-----------------------------------|--|

The requirement for the following technical information of the EUT was tested in this report:

| | |
|---|--|
| Frequency Range | 802.11b/g/n20 MHz): 2.412 GHz - 2.462 GHz $f_c = 2412 \text{ MHz} + (N-1)*5 \text{ MHz}$, where - f_c = "Operating Frequency" in MHz, - N = "Channel Number" with the range from 1 to 11. 802.11n(40 MHz): 2.422 GHz - 2.452 GHz $f_c = 2412 \text{ MHz} + (N-1)*5 \text{ MHz}$, where - f_c = "Operating Frequency" in MHz, - N = "Channel Number" with the range from 3 to 9. |
| Modulation Type | DSSS, OFDM |
| Product Type | <input type="checkbox"/> Mobile <input checked="" type="checkbox"/> Portable <input type="checkbox"/> Fix Location |
| Antenna System (eg., MIMO, Smart Antenna) | N/A |
| Categorization as Correlated or Completely Uncorrelated | N/A |
| Antenna Type | IFA Antenna |
| Antenna Gain | -2.6 dBi |
| About the Product | Only the WIFI 802.11b, 802.11g, 802.11n (HT20), was tested in this report. |

| Modulation technology | Modulation Type | Transfer Rate (Mbps)(Single RF path) |
|--------------------------|-----------------|--------------------------------------|
| DSSS (802.11b) | DBPSK | 1 |
| | DQPSK | 2 |
| | CCK | 5.5/11 |
| OFDM (802.11g) | BPSK | 6/9 |
| | QPSK | 12/18 |
| | 16QAM | 24/36 |
| | 64QAM | 48/54 |
| OFDM (802.11n-20 MHz) | BPSK | 6.5/7.2 |
| | QPSK | 13/19.5/14.4/21.7 |
| | 16QAM | 26/39/28.9/43.3 |
| | 64QAM | 52/58.5/65/57.8/65/72.2 |

Note: Preliminary tests were performed in different data rate in above table to find the worst radiated emission. The data rate shown in the table below is the worst-case rate with respect to the specific test item. Investigation has been done on all the possible configurations for searching the worst cases. The following table is a list of the test modes shown in this test report.

| Test Items | Mode | Data Rate | Channel | |
|------------------------------|---------------|--------------|---------|-------|
| Output Power | 11b/11g/11n20 | 1/6/6.5 Mbps | 1/6/11 | 3/6/9 |
| Occupied Bandwidth | 11b/11g/11n20 | 1/6/6.5 Mbps | 1/6/11 | 3/6/9 |
| Conducted Spurious Emission | 11b/11g/11n20 | 1/6/6.5 Mbps | 1/6/11 | 3/6/9 |
| Conducted Emission | 11b/11g/11n20 | 1/6/6.5 Mbps | 1/6/11 | 3/6/9 |
| Radiated Spurious Emission | 11b/11g/11n20 | 1/6/6.5 Mbps | 1/6/11 | 3/6/9 |
| Band Edge | 11b/11g/11n20 | 1/6/6.5 Mbps | 1/6/11 | 3/6/9 |
| Power spectral density (PSD) | 11b/11g/11n20 | 1/6/6.5 Mbps | 1/6/11 | 3/6/9 |

Note: The above EUT information in section 2.4 was declared by manufacturer and for more detailed features description, please refer to the manufacturer's specifications or user's manual.

3 SUMMARY OF TEST RESULTS

3.1 Test Standards

| No. | Identity | Document Title |
|-----|-------------------------------------|--|
| 1 | 47 CFR Part 15, Subpart C | Intentional radiators of radio frequency equipment |
| 2 | ANSI C63.10-2013 | American National Standard of Procedures for Compliance Testing of Unlicensed Wireless Devices |
| 3 | KDB Publication 558074 D01v05r02 | GUIDANCE FOR COMPLIANCE MEASUREMENTS ON DIGITAL TRANSMISSION SYSTEM, FREQUENCY HOPPING SPREAD SPECTRUM SYSTEM, AND HYBRID SYSTEM DEVICES OPERATING UNDER SECTION 15.247 OF THE FCC RULES |

3.2 Test Verdict

| No. | Description | FCC PART No. | Test Result | Verdict |
|-----|--------------------------------------|--------------------|-------------|------------------------|
| 1 | Antenna Requirement | 15.203 | N/A | Pass ^{Note 1} |
| 2 | Output Power | 15.247 (b) | ANNEX A.1 | Pass |
| 3 | Occupied Bandwidth | 15.247 (a) | ANNEX A.2 | Pass |
| 4 | Conducted Spurious Emission | 15.247 (d) | ANNEX A.3 | Pass |
| 5 | Band Edge(Authorized-band band-edge) | 15.247 (d) | ANNEX A.4 | Pass |
| 6 | Conducted Emission | 15.207 | ANNEX A.5 | Pass |
| 7 | Radiated Spurious Emission | 15.209; 15.247 (d) | ANNEX A.6 | Pass |
| 8 | Band Edge(Restricted-band band-edge) | 15.209; 15.247 (d) | ANNEX A.7 | Pass |
| 9 | Power spectral density (PSD) | 15.247 (e) | ANNEX A.8 | Pass |

Note ¹: The EUT has a permanently and irreplaceable attached antenna, which complies with the requirement FCC 15.203.

4 GENERAL TEST CONFIGURATIONS

4.1 Test Environments

During the measurement, the normal environmental conditions were within the listed ranges:

| | | |
|----------------------------|-------------------------|--------------------|
| Relative Humidity | 47% to 64% | |
| Atmospheric Pressure | 100 kPa to 102 kPa | |
| Temperature | NT (Normal Temperature) | +20.8°C to +24.3°C |
| Working Voltage of the EUT | NV (Normal Voltage) | 3.8 V |

4.2 Test Equipment List

| Description | Manufacturer | Model | Serial No. | Cal. Date | Cal. Due |
|---------------------|-------------------------------|-----------------------|-------------|------------|------------|
| Spectrum Analyzer | KEYSIGHT | N9020A | MY46471071 | 2023.07.25 | 2024.07.24 |
| Power Sensor | KEYSIGHT | U2063XA | MY58000251 | 2023.07.12 | 2024.07.11 |
| Spectrum Analyzer | KEYSIGHT | N9020A | MY50531259 | 2023.09.05 | 2024.09.04 |
| Signaling Unit | ROHDE&SCHWARZ | CMW500 | 171150 | 2023.06.19 | 2024.06.18 |
| Test Antenna-Horn | SCHWARZBECK | BBHA 9120D | 02460 | 2021.05.20 | 2024.05.19 |
| Test Antenna-Horn | A-INFO | LB- 180400KF | J211060273 | 2021.07.02 | 2024.07.01 |
| Anechoic Chamber | RAINFORD | 9m*6m*6m | 140 | 2022.02.19 | 2024.08.15 |
| Amplifier | COM-MV | LSCX_LNA 1-12G-01 | 7210214 | 2023.09.05 | 2024.09.04 |
| Amplifier | COM-MV | XKu_LNA7- 18G-01 | 7210209 | 2023.09.05 | 2024.09.04 |
| Amplifier | COM-MV | KA LNA18 40G-01 | 18050001 | 2023.12.06 | 2024.12.05 |
| EMI Receiver | Agilent | N9038A | MY55330120 | 2023.09.05 | 2024.09.04 |
| Test Antenna-Bi-Log | SCHWARZBECK | VULB 9168 | 9168-00867 | 2022.04.12 | 2025.04.11 |
| Amplifier | COM-MV | ZT30- 1000M | B2017119081 | 2023.12.05 | 2024.12.04 |
| Anechoic Chamber | YiHeng | 9m*6m*6m | 142 | 2021.08.19 | 2024.08.18 |
| EMI Receiver | KEYSIGHT | N9010B | MY57110309 | 2023.09.05 | 2024.09.04 |
| LISN | SCHWARZBECK | NSLK 8127 | 8127-687 | 2023.05.16 | 2024.05.15 |
| Shielded Enclosure | YiHeng Electronic Co., Ltd | 3.5m*3.1m* 2.8m | 112 | 2022.02.19 | 2025.02.18 |
| EMI Receiver | ROHDE&SCHWARZ | ESRP | 101036 | 2023.09.05 | 2024.09.04 |
| Test Antenna-Bi-Log | SCHWARZBECK | VULB 9168 | 9168-01162 | 2023.08.04 | 2024.08.03 |
| Test Antenna-Loop | SCHWARZBECK | FMZB 1519 | 1519-037 | 2021.04.16 | 2024.04.15 |
| Amplifier | COM-MV | ZT30- 1000M | B2018054558 | 2023.12.05 | 2024.12.04 |
| Anechoic Chamber | EMC Electronic Co., Ltd | 20.10*11.60 *7.35m | 130 | 2021.08.15 | 2024.08.14 |

4.3 Test Software List

| Description | Manufacturer | Software Version | Serial No. | Applicable test Setup |
|-------------|--------------|------------------|------------|-------------------------------------|
| BL410R | BALUN | V2.1.1.488 | N/A | The section 4.5.1 |
| BL410E | BALUN | V22.930 | N/A | The section 4.5.2&4.5.3&4.5.4&4.5.5 |

4.4 Measurement Uncertainty

The following measurement uncertainty levels have been estimated for tests performed on the EUT as specified in CISPR 16-4-2.

This uncertainty represents an expanded uncertainty expressed at approximately the 95% confidence level using a coverage factor of k=2.

| Parameters | Uncertainty |
|-----------------------------------|-------------|
| Occupied Channel Bandwidth | 2.8% |
| RF output power, conducted | 1.28 dB |
| Power Spectral Density, conducted | 1.30 dB |
| Unwanted Emissions, conducted | 1.84 dB |
| All emissions, radiated | 5.36 dB |
| Temperature | 0.8°C |
| Humidity | 4% |

4.5 Description of Test Setup

4.5.1 For Antenna Port Test

$$\text{Conducted value (dBm)} = \text{Measurement value (dBm)} + \text{cable loss (dB)}$$

For example: the measurement value is 10 dBm and the cable 0.5dBm used, then the final result of EUT:

$$\text{Conducted value (dBm)} = 10 \text{ dBm} + 0.5 \text{ dB} = 10.5 \text{ dBm}$$

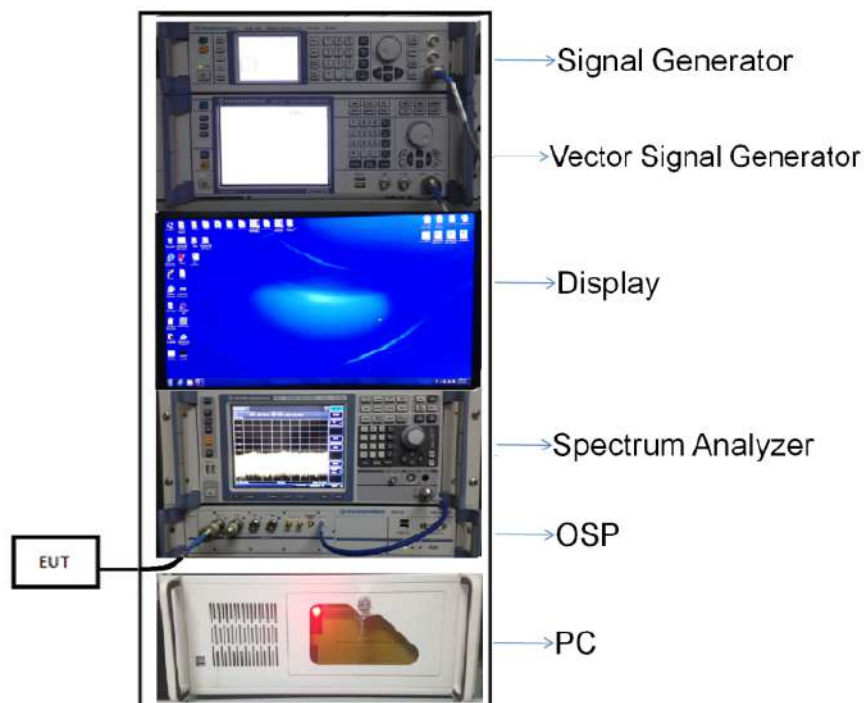

(Diagram 1)

4.5.2 For AC Power Supply Port Test

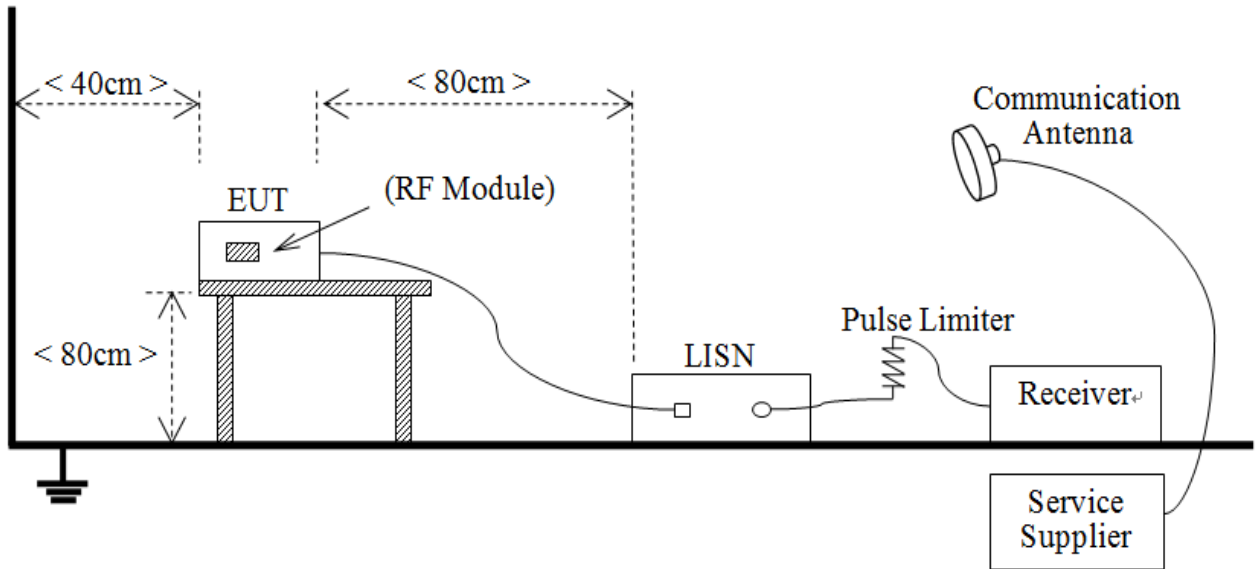

(Diagram 2)

4.5.3 For Radiated Test (Below 30 MHz)

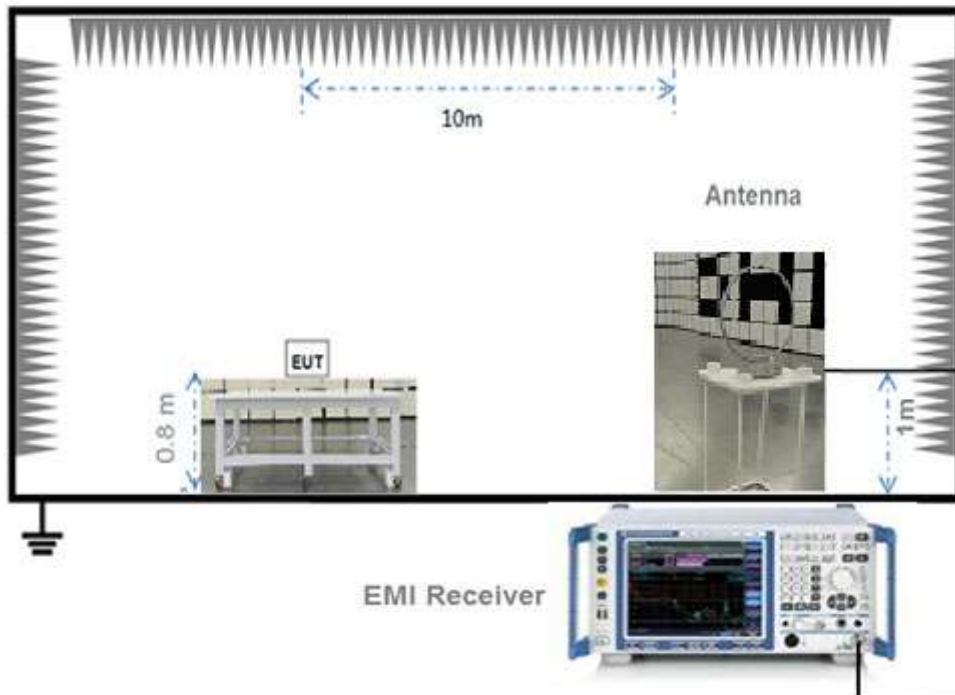

(Diagram 3)

4.5.4 For Radiated Test (30 MHz-1 GHz)

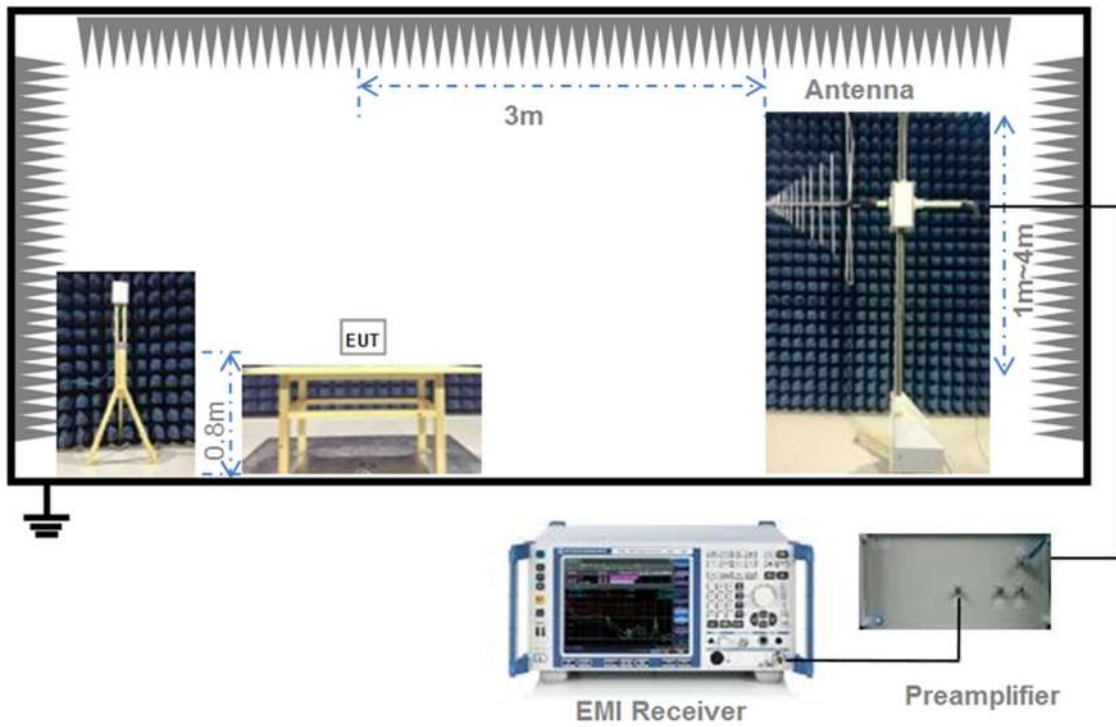

(Diagram 4)

4.5.5 For Radiated Test (Above 1 GHz)

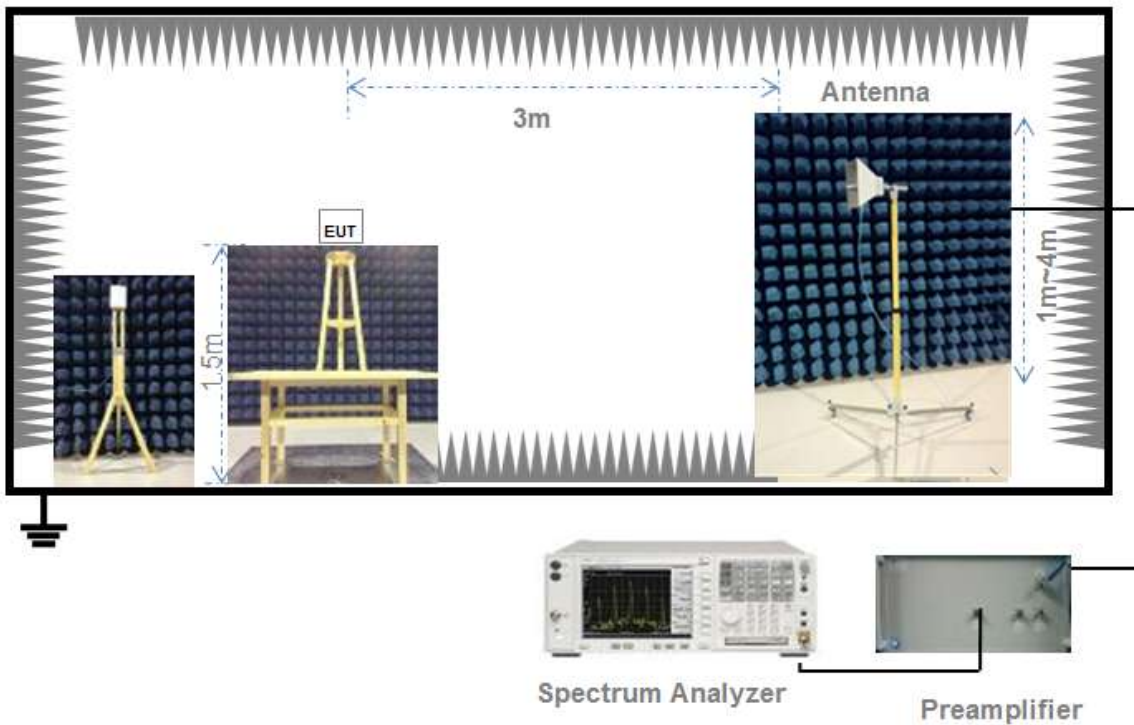

(Diagram 5)

4.6 Measurement Results Explanation Example

4.6.1 For conducted test items:

The offset level is set in the spectrum analyzer to compensate the RF cable loss and attenuator between EUT conducted output port and spectrum analyzer. With the offset compensation, the spectrum analyzer reading level is exactly the EUT RF output level.

The spectrum analyzer offset is derived from RF cable loss and attenuator factor.

Offset = RF cable loss + attenuator factor.

4.6.2 For radiated band edges and spurious emission test:

$$E = \text{EIRP} - 20 \log D + 104.8$$

where:

E = electric field strength in dB μ V/m,

EIRP = equivalent isotropic radiated power in dBm

D = specified measurement distance in meters.

EIRP = Measure Conducted output power Value (dBm) + Maximum transmit antenna gain (dBi) + the appropriate maximum ground reflection factor (dB)

5 TEST ITEMS

5.1 Antenna Requirements

5.1.1 Relevant Standards

FCC §15.203

An intentional radiator shall be designed to ensure that no antenna other than that furnished by the responsible party shall be used with the device. The use of a permanently attached antenna or of an antenna that uses a unique coupling to the intentional radiator shall be considered sufficient to comply with the provisions of this section. The manufacturer may design the unit so that a broken antenna can be replaced by the user, but the use of a standard antenna jack or electrical connector is prohibited. This requirement does not apply to carrier current devices or to devices operated under the provisions of § 15.211, § 15.213, § 15.217, § 15.219, or § 15.221. Further, this requirement does not apply to intentional radiators that must be professionally installed, such as perimeter protection systems and some field disturbance sensors, or to other intentional radiators which, in accordance with § 15.31(d), must be measured at the installation site. However, the installer shall be responsible for ensuring that the proper antenna is employed so that the limits in this part are not exceeded.

If directional gain of transmitting antennas is greater than 6 dBi, the power shall be reduced by the same level in dB comparing to gain minus 6 dBi. For the fixed point-to-point operation, the power shall be reduced by one dB for every 3 dB that the directional gain of the antenna exceeds 6 dBi. The use of a permanently attached antenna or of an antenna that uses a unique coupling to the intentional radiator shall be considered sufficient to comply with the FCC rule.

5.1.2 Antenna Anti-Replacement Construction

The Antenna Anti-Replacement as following method:

| Protected Method | Description |
|---|--|
| Compliance with 15.203, use of a standard antenna jack or electrical connector is prohibited. | The antenna is the unique connector with a wire antenna. |

| Reference Documents | Item |
|---------------------|--|
| Photo | Please refer to the EUT Photo documents. |

| Protected Method | Description |
|---|--|
| The antenna is embedded in the product. | An embedded-in antenna design is used. |

| Reference Documents | Item |
|---------------------|--|
| Photo | Please refer to the EUT Photo documents. |

5.1.3 Antenna Gain

The antenna peak gain of EUT is less than 6 dBi. Therefore, it is not necessary to reduce maximum peak

output power limit.

5.2 Output Power

5.2.1 Test Limit

FCC § 15.247(b)

For systems using digital modulation in the 902-928 MHz, 2400-2483.5 MHz, and 5725-5850 MHz bands: 1 Watt. As an alternative to a peak power measurement, compliance with the one Watt limit can be based on a measurement of the maximum conducted output power. Maximum Conducted Output Power is defined as the total transmit power delivered to all antennas and antenna elements averaged across all symbols in the signaling alphabet when the transmitter is operating at its maximum power control level. Power must be summed across all antennas and antenna elements.

5.2.2 Test Setup

See section 4.5.1 for test setup description for the antenna port. The photo of test setup please refer to ANNEX B.

5.2.3 Test Procedure

Maximum peak conducted output power

The maximum peak conducted output power may be measured using a broadband peak RF power meter. The power meter shall have a video bandwidth that is greater than or equal to the DTS bandwidth and shall utilize a fast-responding diode detector.

Maximum conducted (average) output power (Reporting Only)

a) As an alternative to spectrum analyzer or EMI receiver measurements, measurements may be performed

using a wideband RF power meter with a thermocouple detector or equivalent if all of the conditions listed below are satisfied.

- 1) The EUT is configured to transmit continuously, or to transmit with a constant duty factor.
- 2) At all times when the EUT is transmitting, it shall be transmitting at its maximum power control level.
- 3) The integration period of the power meter exceeds the repetition period of the transmitted signal by at least a factor of five.

b) If the transmitter does not transmit continuously, measure the duty cycle (x) of the transmitter output signal as

described in Section 6.0.

c) Measure the average power of the transmitter. This measurement is an average over both the on and off periods of the transmitter.

d) Adjust the measurement in dBm by adding $10\log(1/x)$, where x is the duty cycle to the measurement result.

Measurements of duty cycle

The zero-span mode on a spectrum analyzer or EMI receiver if the response time and spacing between bins on the sweep are sufficient to permit accurate measurements of the on and off times of the transmitted signal.

Set the center frequency of the instrument to the center frequency of the transmission.

Set $RBW \geq OBW$ if possible; otherwise, set RBW to the largest available value.

Set $VBW \geq RBW$. Set detector = peak or average.

The zero-span measurement method shall not be used unless both RBW and VBW are $> 50/T$ and the number of sweep points across duration T exceeds 100. (For example, if VBW and/or RBW are limited to 3 MHz, then the zero-span method of measuring duty cycle shall not be used if $T \leq 16.7$ microseconds.)

5.2.4 Test Result

Please refer to ANNEX A.1.

5.3 Occupied Bandwidth

5.3.1 Limit

FCC §15.247(a)

Make the measurement with the spectrum analyzer's resolution bandwidth (RBW) = 100 kHz. In order to make an accurate measurement, set the span greater than RBW. The 6 dB bandwidth must be greater than 500 kHz.

5.3.2 Test Setup

See section 4.5.1 for test setup description for the antenna port. The photo of test setup please refer to ANNEX B.

5.3.3 Test Procedure

Use the following spectrum analyzer settings:

Set RBW = 100 kHz.

Set the video bandwidth (VBW) \geq 3 RBW.

Detector = Peak.

Trace mode = max hold.

Sweep = auto couple.

Allow the trace to stabilize.

Measure the maximum width of the emission that is constrained by the frequencies associated with the two outermost amplitude points (upper and lower frequencies) that are attenuated by 6 dB relative to the maximum level measured in the fundamental emission.

5.3.4 Test Result

Please refer to ANNEX A.2.

5.4 Conducted Spurious Emission

5.4.1 Limit

FCC §15.247(d)

In any 100 kHz bandwidth outside the frequency band in which the spread spectrum or digitally modulated intentional radiator is operating, the radio frequency power that is produced by the intentional radiator shall be at least 20 dB below that in the 100 kHz bandwidth within the band that contains the highest level of the desired power, based on either an RF conducted or a radiated measurement.

5.4.2 Test Setup

See section 4.5.1 for test setup description for the antenna port. The photo of test setup please refer to ANNEX B.

5.4.3 Test Procedure

The DTS rules specify that in any 100 kHz bandwidth outside of the authorized frequency band, the power shall be attenuated according to the following conditions:

- a) If the maximum peak conducted output power procedure was used to demonstrate compliance as described in 9.1, then the peak output power measured in any 100 kHz bandwidth outside of the authorized frequency band shall be attenuated by at least 20 dB relative to the maximum in-band peak PSD level in 100 kHz (i.e., 20 dBc).
- b) If maximum conducted (average) output power was used to demonstrate compliance as described in 9.2, then the peak power in any 100 kHz bandwidth outside of the authorized frequency band shall be attenuated by at least 30 dB relative to the maximum in-band peak PSD level in 100 kHz (i.e., 30 dBc).
- c) In either case, attenuation to levels below the 15.209 general radiated emissions limits is not required.

The following procedures shall be used to demonstrate compliance to these limits. Note that these procedures can be used in either an antenna-port conducted or radiated test set-up. Radiated tests must conform to the test site requirements and utilize maximization procedures defined herein.

Reference level measurement

Establish a reference level by using the following procedure:

Set instrument center frequency to DTS channel center frequency.

Set the span to ≥ 1.5 times the DTS bandwidth.

Set the RBW = 100 kHz.

Set the VBW $\geq 3 \times$ RBW.

Detector = peak.

Sweep time = auto couple.

Trace mode = max hold.

Allow trace to fully stabilize.

Use the peak marker function to determine the maximum PSD level.

Emission level measurement

Use the following spectrum analyzer settings:

Span = wide enough to capture the peak level of the in-band emission and all spurious emissions (e.g., harmonics) from the lowest frequency generated in the EUT up through the 10th harmonic. Typically, several plots are required to cover this entire span.

Set the RBW = 100 kHz.

Set the VBW $\geq 3 \times$ RBW.

Detector = peak.

Sweep time = auto couple.

Trace mode = max hold.

Allow trace to fully stabilize.

Use the peak marker function to determine the maximum amplitude level.

Ensure that the amplitude of all unwanted emissions outside of the authorized frequency band (excluding restricted frequency bands) are attenuated by at least the minimum requirements specified in 11.1 a) or 11.1 b). Report the three highest emissions relative to the limit.

5.4.4 Test Result

Please refer to ANNEX A.3.

5.5 Band Edge (Authorized-band band-edge)

5.5.1 Limit

FCC §15.247(d)

In any 100 kHz bandwidth outside the frequency band in which the spread spectrum or digitally modulated intentional radiator is operating, the radio frequency power that is produced by the intentional radiator shall be at least 20 dB below that in the 100 kHz bandwidth within the band that contains the highest level of the desired power, based on either an RF conducted or a radiated measurement.

5.5.2 Test Setup

See section 4.5.1 for test setup description for the antenna port. The photo of test setup please refer to ANNEX B.

5.5.3 Test Procedure

The following procedures may be used to determine the peak or average field strength or power of an unwanted emission that is within 2 MHz of the authorized band edge. If a peak detector is utilized, use the procedure described in 13.2.1. Use the procedure described in 13.2.2 when using an average detector and the EUT can be configured to transmit continuously (i.e., duty cycle $\geq 98\%$). Use the procedure described in 13.2.3 when using an average detector and the EUT cannot be configured to transmit continuously but the duty cycle is constant (i.e., duty cycle variations are less than ± 2 percent). Use the procedure described in 13.2.4 when using an average detector for those cases where the EUT cannot be configured to transmit continuously and the duty cycle is not constant (duty cycle variations equal or exceed 2 percent).

When using a peak detector to measure unwanted emissions at or near the band edge (within 2 MHz of the authorized band), the following integration procedure can be used.

Set instrument center frequency to the frequency of the emission to be measured (must be within 2 MHz of the authorized band edge).

Set span to 2 MHz

RBW = 100 kHz.

VBW $\geq 3 \times$ RBW.

Detector = peak.

Sweep time = auto.

Trace mode = max hold.

Allow sweep to continue until the trace stabilizes (required measurement time may increase for low duty cycle applications)

Compute the power by integrating the spectrum over 1 MHz using the analyzer's band power measurement function with band limits set equal to the emission frequency (femission) ± 0.5 MHz. If the instrument does not have a band power function, then sum the amplitude levels (in power units) at 100 kHz intervals extending across the 1 MHz spectrum defined by femission ± 0.5 MHz.

Standard method(The 99% OBW of the fundamental emission is without 2 MHz of the authorized band):

Span: Wide enough to capture the peak level of the emission operating on the channel closest to the band edge, as well as any modulation products that fall outside of the authorized band of operation.

Reference level: As required to keep the signal from exceeding the maximum instrument input mixer level for linear operation. In general, the peak of the spectral envelope shall be more than [10 log (OBW/RBW)] below the reference level. Specific guidance is given in 4.1.5.2.

Attenuation: Auto (at least 10 dB preferred).

Sweep time: Coupled.

Resolution bandwidth: 100 kHz.

Video bandwidth: 300 kHz.

Detector: Peak.

Trace: Max hold.

5.5.4 Test Result

Please refer to ANNEX A.4.

5.6 Conducted Emission

5.6.1 Limit

FCC §15.207

For an intentional radiator that is designed to be connected to the public utility (AC) power line, the radio frequency voltage that is conducted back onto the AC power line on any frequency within the band 150 kHz to 30 MHz shall not exceed the limits in the following table, as measured using a 50 μ H/50 Ω line impedance stabilization network (LISN).

| Frequency range (MHz) | Conducted Limit (dB μ V) | |
|--------------------------|------------------------------|----------|
| | Quai-peak | Average |
| 0.15 - 0.50 | 66 to 56 | 56 to 46 |
| 0.50 - 5 | 56 | 46 |
| 0.50 - 30 | 60 | 50 |

5.6.2 Test Setup

See section 4.5.2 for test setup description for the AC power supply port. The photo of test setup please refer to ANNEX B.

5.6.3 Test Procedure

The maximum conducted interference is searched using Peak (PK), if the emission levels more than the AV and QP limits, and that have narrow margins from the AV and QP limits will be re-measured with AV and QP detectors. Tests for both L phase and N phase lines of the power mains connected to the EUT are performed. Refer to recorded points and plots below.

Devices subject to Part 15 must be tested for all available U.S. voltages and frequencies (such as a nominal 120 VAC, 50/60 Hz and 240 VAC, 50/60 Hz) for which the device is capable of operation. A device rated for 50/60 Hz operation need not be tested at both frequencies provided the radiated and line conducted emissions are the same at both frequencies.

5.6.4 Test Result

Please refer to ANNEX A.5.

5.7 Radiated Spurious Emission

5.7.1 Limit

FCC §15.209&15.247(d)

Radiated emission outside the frequency band attenuation below the general limits specified in FCC section 15.209(a) is not required. In addition, radiated emissions which fall in the restricted bands, as defined in FCC section 15.205(a), must also comply with the radiated emission limits specified in FCC section 15.209(a).

According to FCC section 15.209 (a), except as provided elsewhere in this subpart, the emissions from an intentional radiator shall not exceed the field strength levels specified in the following table:

| Frequency (MHz) | Field Strength ($\mu\text{V}/\text{m}$) | Measurement Distance (m) |
|-----------------|---|--------------------------|
| 0.009 - 0.490 | 2400/F(kHz) | 300 |
| 0.490 - 1.705 | 24000/F(kHz) | 30 |
| 1.705 - 30.0 | 30 | 30 |
| 30 - 88 | 100 | 3 |
| 88 - 216 | 150 | 3 |
| 216 - 960 | 200 | 3 |
| Above 960 | 500 | 3 |

Note:

- For Above 1000 MHz, the emission limit in this paragraph is based on measurement instrumentation employing an average detector, measurement using instrumentation with a peak detector function, corresponding to 20dB above the maximum permitted average limit.
- For above 1000 MHz, limit field strength of harmonics: 54dBuV/m@3m (AV) and 74dBuV/m@3m (PK).

5.7.2 Test Setup

See section 4.5.3 to 4.5.5 for test setup description for the antenna port. The photo of test setup please refer to ANNEX B.

5.7.3 Test Procedure

Since the emission limits are specified in terms of radiated field strength levels, measurements performed to demonstrate compliance have traditionally relied on a radiated test configuration. Radiated measurements remain the principal method for demonstrating compliance to the specified limits; however antenna-port conducted measurements are also now acceptable to demonstrate compliance (see below for details). When radiated measurements are utilized, test site requirements and procedures for maximizing and measuring radiated emissions that are described in ANSI C63.10 shall be followed.

Antenna-port conducted measurements may also be used as an alternative to radiated measurements for demonstrating compliance in the restricted frequency bands. If conducted measurements are performed, then proper impedance matching must be ensured and an additional radiated test for cabinet/case spurious emissions is required.

General Procedure for conducted measurements in restricted bands

- a) Measure the conducted output power (in dBm) using the detector specified (see guidance regarding measurement procedures for determining quasi-peak, peak, and average conducted output power, respectively).
- b) Add the maximum transmit antenna gain (in dBi) to the measured output power level to determine the EIRP level (see guidance on determining the applicable antenna gain)
- c) Add the appropriate maximum ground reflection factor to the EIRP level (6 dB for frequencies ≤ 30 MHz, 4.7 dB for frequencies between 30 MHz and 1000 MHz, inclusive and 0 dB for frequencies > 1000 MHz).
- d) For devices with multiple antenna-ports, measure the power of each individual chain and sum the EIRP of all chains in linear terms (e.g., Watts, mW).
- e) Convert the resultant EIRP level to an equivalent electric field strength using the following relationship:

$$E = \text{EIRP} - 20\log D + 104.8$$

where:

E = electric field strength in dB μ V/m,

EIRP = equivalent isotropic radiated power in dBm

D = specified measurement distance in meters.

- f) Compare the resultant electric field strength level to the applicable limit.
- g) Perform radiated spurious emission test.

Quasi-Peak measurement procedure

The specifications for measurements using the CISPR quasi-peak detector can be found in Publication 16 of the International Special Committee on Radio Frequency Interference (CISPR) of the International Electrotechnical Commission.

As an alternative to CISPR quasi-peak measurement, compliance can be demonstrated to the applicable emission limits using a peak detector.

Peak power measurement procedure

Peak emission levels are measured by setting the instrument as follows:

- a) RBW = as specified in Table 1.
- b) VBW $\geq 3 \times$ RBW.
- c) Detector = Peak.
- d) Sweep time = auto.
- e) Trace mode = max hold.
- f) Allow sweeps to continue until the trace stabilizes. (Note that the required measurement time may be

longer for low duty cycle applications).

Table 1—RBW as a function of frequency

| Frequency | RBW |
|-------------|-------------|
| 9-150 kHz | 200-300 Hz |
| 0.15-30 MHz | 9-10 kHz |
| 30-1000 MHz | 100-120 kHz |
| > 1000 MHz | 1 MHz |

If the peak-detected amplitude can be shown to comply with the average limit, then it is not necessary to perform a separate average measurement.

Trace averaging across on and off times of the EUT transmissions followed by duty cycle correction

If continuous transmission of the EUT (i.e., duty cycle ≥ 98 percent) cannot be achieved and the duty cycle is constant (i.e., duty cycle variations are less than ± 2 percent), then the following procedure shall be used:

- a) The EUT shall be configured to operate at the maximum achievable duty cycle.
- b) Measure the duty cycle, x , of the transmitter output signal as described in section 6.0.
- c) RBW = 1 MHz (unless otherwise specified).
- d) VBW $\geq 3 \times$ RBW.
- e) Detector = RMS, if $\text{span}/(\# \text{ of points in sweep}) \leq (\text{RBW}/2)$. Satisfying this condition may require increasing the number of points in the sweep or reducing the span. If this condition cannot be satisfied, then the detector mode shall be set to peak.
- f) Averaging type = power (i.e., RMS).
 - 1) As an alternative, the detector and averaging type may be set for linear voltage averaging.
 - 2) Some instruments require linear display mode in order to use linear voltage averaging. Log or dB averaging shall not be used.
- g) Sweep time = auto.
- h) Perform a trace average of at least 100 traces.
- i) A correction factor shall be added to the measurement results prior to comparing to the emission limit in order to compute the emission level that would have been measured had the test been performed at 100 percent duty cycle. The correction factor is computed as follows:
 - 1) If power averaging (RMS) mode was used in step f), then the applicable correction factor is $10 \log(1/x)$, where x is the duty cycle.
 - 2) If linear voltage averaging mode was used in step f), then the applicable correction factor is $20 \log(1/x)$, where x is the duty cycle.
 - 3) If a specific emission is demonstrated to be continuous (≥ 98 percent duty cycle) rather than turning on and off with the transmit cycle, then no duty cycle correction is required for that emission.

NOTE: Reduction of the measured emission amplitude levels to account for operational duty factor is not permitted. Compliance is based on emission levels occurring during transmission - not on an average across on and off times of the transmitter.

Determining the applicable transmit antenna gain

A conducted power measurement will determine the maximum output power associated with a restricted band emission; however, in order to determine the associated EIRP level, the gain of the transmitting antenna (in dBi) must be added to the measured output power (in dBm).

Since the out-of-band characteristics of the EUT transmit antenna will often be unknown, the use of a conservative antenna gain value is necessary. Thus, when determining the EIRP based on the measured conducted power, the upper bound on antenna gain for a device with a single RF output shall be selected as the maximum in-band gain of the antenna across all operating bands, or 2 dBi, whichever is greater. However, for devices that operate in multiple frequency bands while using the same transmit antenna, the highest gain of the antenna within the operating band nearest in frequency to the restricted band emission being measured may be used in lieu of the overall highest gain when the emission is at a frequency that is within 20 percent of the nearest band edge frequency, but in no case shall a value less than 2 dBi be used.

See KDB 662911 for guidance on calculating the additional array gain term when determining the effective antenna gain for a EUT with multiple outputs occupying the same or overlapping frequency ranges in the same band.

Radiated spurious emission test

An additional consideration when performing conducted measurements of restricted band emissions is that unwanted emissions radiating from the EUT cabinet, control circuits, power leads, or intermediate circuit elements will likely go undetected in a conducted measurement configuration. To address this concern, a radiated test shall be performed to ensure that emissions emanating from the EUT cabinet (rather than the antenna port) also comply with the applicable limits.

For these cabinet radiated spurious emission measurements the EUT transmit antenna may be replaced with a termination matching the nominal impedance of the antenna. Procedures for performing radiated measurements are specified in ANSI C63.10. All detected emissions shall comply with the applicable limits.

The measurement frequency range is from 30 MHz to the 10th harmonic of the fundamental frequency. The Turn Table is actuated to turn from 0° to 360°, and both horizontal and vertical polarizations of the Test Antenna are used to find the maximum radiated power. Mid channels on all channel bandwidth verified. Only the worst RB size/offset presented.

The power of the EUT transmitting frequency should be ignored.

All Spurious Emission tests were performed in X, Y, Z axis direction. And only the worst axis test condition was recorded in this test report.

Use the following spectrum analyzer settings:

Span = wide enough to fully capture the emission being measured

RBW = 1 MHz for $f \geq 1$ GHz, 100 kHz for $f < 1$ GHz

VBW \geq RBW

Sweep = auto

Detector function = peak

Trace = max hold

5.7.4 Test Result

Please refer to ANNEX A.6.

5.8 Band Edge (Restricted-band band-edge)

5.8.1 Limit

FCC §15.209&15.247(d)

Radiated emission outside the frequency band attenuation below the general limits specified in FCC section 15.209(a) is not required. In addition, radiated emissions which fall in the restricted bands, as defined in FCC section 15.205(a), must also comply with the radiated emission limits specified in FCC section 15.209(a).

5.8.2 Test Setup

See section 4.5.1 for test setup description for the antenna port. The photo of test setup please refer to ANNEX B.

5.8.3 Test Procedure

The measurement frequency range is from 9 kHz to the 10th harmonic of the fundamental frequency. The Turn Table is actuated to turn from 0° to 360°, and both horizontal and vertical polarizations of the Test Antenna are used to find the maximum radiated power. Mid channels on all channel bandwidth verified. Only the worst RB size/offset presented.

The power of the EUT transmitting frequency should be ignored.

All Spurious Emission tests were performed in X, Y, Z axis direction. And only the worst axis test condition was recorded in this test report.

Use the following spectrum analyzer settings:

Span = wide enough to fully capture the emission being measured

RBW = 1 MHz for $f \geq 1$ GHz, 100 kHz for $f < 1$ GHz

VBW \geq RBW

Sweep = auto

Detector function = peak

Trace = max hold

For measurement below 1GHz, If the emission level of the EUT measured by the peak detector is 3 dB lower than the applicable limit, the peak emission level will be reported, Otherwise, the emission measurement will be repeated using the quasi-peak detector and reported.

For transmitters operating above 1 GHz repeat the measurement with an average detector.

5.8.4 Test Result

Please refer to ANNEX A.7.

5.9 Power Spectral density (PSD)

5.9.1 Limit

FCC §15.247(e)

The same method of determining the conducted output power shall be used to determine the power spectral density. If a peak output power is measured, then a peak power spectral density measurement is required. If an average output power is measured, then an average power spectral density measurement should be used.

5.9.2 Test Setup

See section 4.5.1 for test setup description for the antenna port. The photo of test setup please refer to ANNEX B.

5.9.3 Test Procedure

Set analyzer center frequency to DTS channel center frequency.

Set the span to 1.5 times the DTS bandwidth.

Set the RBW to: $3 \text{ kHz} \leq \text{RBW} \leq 100 \text{ kHz}$.

Set the VBW $\geq 3 \text{ RBW}$.

Detector = peak.

Sweep time = auto couple.

Trace mode = max hold.

Allow trace to fully stabilize.

Use the peak marker function to determine the maximum amplitude level within the RBW.

If measured value exceeds limit, reduce RBW (no less than 3 kHz) and repeat.

5.9.4 Test Result

Please refer to ANNEX A.8.

ANNEX A TEST RESULT

A.1 Output Power

Note: The Average Power has considered the Duty Factor.

Duty Cycle

| Test Mode | On Time (ms) | On+Off time (ms) | Duty Cycle | Duty Factor |
|----------------|--------------|------------------|------------|-------------|
| 802.11b | 8.379 | 8.425 | 99.45% | 0.02 |
| 802.11g | 1.386 | 1.436 | 96.52% | 0.15 |
| 802.11n-20 MHz | 1.297 | 1.345 | 96.43% | 0.16 |

Peak Power Test Data

802.11b Mode:

| Channel | Measured Output Peak Power | | Limit | | Verdict |
|---------|----------------------------|-------|-------|------|---------|
| | dBm | mW | dBm | mW | |
| Low | 18.11 | 64.71 | 30 | 1000 | Pass |
| Middle | 18.06 | 63.97 | | | Pass |
| High | 18.26 | 66.99 | | | Pass |

802.11g Mode:

| Channel | Measured Output Peak Power | | Limit | | Verdict |
|---------|----------------------------|--------|-------|------|---------|
| | dBm | mW | dBm | mW | |
| Low | 24.10 | 257.04 | 30 | 1000 | Pass |
| Middle | 23.80 | 239.88 | | | Pass |
| High | 23.47 | 222.33 | | | Pass |

802.11n-20 MHz Mode:

| Channel | Measured Output Peak Power | | Limit | | Verdict |
|---------|----------------------------|--------|-------|------|---------|
| | dBm | mW | dBm | mW | |
| Low | 23.86 | 243.22 | 30 | 1000 | Pass |
| Middle | 24.00 | 251.19 | | | Pass |
| High | 23.20 | 208.93 | | | Pass |

Average Power Test Data

802.11b Mode:

| Channel | Measured Output Average Power | | Limit | | Verdict |
|---------|-------------------------------|-------|-------|------|---------|
| | dBm | mW | dBm | mW | |
| Low | 15.63 | 36.56 | 30 | 1000 | Pass |
| Middle | 15.62 | 36.48 | | | Pass |
| High | 15.46 | 35.16 | | | Pass |

802.11g Mode:

| Channel | Measured Output Average Power | | Limit | | Verdict |
|---------|-------------------------------|-------|-------|------|---------|
| | dBm | mW | dBm | mW | |
| Low | 15.47 | 35.24 | 30 | 1000 | Pass |
| Middle | 15.43 | 34.91 | | | Pass |
| High | 15.68 | 36.98 | | | Pass |

802.11n-20 MHz Mode:

| Channel | Measured Output Average Power | | Limit | | Verdict |
|---------|-------------------------------|-------|-------|------|---------|
| | dBm | mW | dBm | mW | |
| Low | 15.40 | 34.67 | 30 | 1000 | Pass |
| Middle | 15.54 | 35.81 | | | Pass |
| High | 15.41 | 34.75 | | | Pass |

A.2 Occupied Bandwidth

Test Data

802.11b Mode:

| Channel | 6 dB Bandwidth (MHz) | 99% Bandwidth (MHz) | 6 dB Bandwidth Limits (kHz) |
|---------|----------------------|---------------------|-----------------------------|
| Low | 8.100000 | 12.657000 | ≥500 |
| Middle | 8.150000 | 12.920000 | ≥500 |
| High | 8.100000 | 12.714000 | ≥500 |

802.11g Mode:

| Channel | 6 dB Bandwidth (MHz) | 99% Bandwidth (MHz) | 6 dB Bandwidth Limits (kHz) |
|---------|----------------------|---------------------|-----------------------------|
| Low | 15.400000 | 17.085000 | ≥500 |
| Middle | 15.500000 | 17.273000 | ≥500 |
| High | 15.200000 | 17.075000 | ≥500 |

802.11n-20 MHz Mode:

| Channel | 6 dB Bandwidth (MHz) | 99% Bandwidth (MHz) | 6 dB Bandwidth Limits (kHz) |
|---------|----------------------|---------------------|-----------------------------|
| Low | 15.200000 | 18.015000 | ≥500 |
| Middle | 16.350000 | 18.178000 | ≥500 |
| High | 15.200000 | 18.042000 | ≥500 |

Test Plots

6 dB Bandwidth

802.11b LOW CHANNEL



802.11b MIDDLE CHANNEL



802.11b HIGH CHANNEL



802.11g LOW CHANNEL



802.11g MIDDLE CHANNEL



802.11g HIGH CHANNEL



802.11n-20 MHz LOW CHANNEL



802.11n-20 MHz MIDDLE CHANNEL



802.11n-20 MHz HIGH CHANNEL



99% Bandwidth

802.11b LOW CHANNEL



802.11b MIDDLE CHANNEL



802.11b HIGH CHANNEL



802.11g LOW CHANNEL



802.11g MIDDLE CHANNEL



802.11g HIGH CHANNEL



802.11n-20 MHz LOW CHANNEL



802.11n-20 MHz MIDDLE CHANNEL



802.11n-20 MHz HIGH CHANNEL



A.3 Conducted Spurious Emissions

Test Data

802.11b Mode:

| Channel | Measured Max. Out of Band Emission (dBm) | Limit (dBm) | | Verdict |
|---------|--|---------------|----------------------------|---------|
| | | Carrier Level | Calculated 20 dBc Limit | |
| Low | -39.37 | 7.42 | -12.58 | Pass |
| Middle | -39.81 | 7.31 | -12.69 | Pass |
| High | -40.23 | 7.45 | -12.55 | Pass |

802.11g Mode:

| Channel | Measured Max. Out of Band Emission (dBm) | Limit (dBm) | | Verdict |
|---------|--|---------------|----------------------------|---------|
| | | Carrier Level | Calculated 20 dBc Limit | |
| Low | -39.50 | 5.42 | -14.58 | Pass |
| Middle | -40.52 | 5.00 | -15.00 | Pass |
| High | -39.61 | 5.44 | -14.56 | Pass |

802.11n-20 MHz Mode:

| Channel | Measured Max. Out of Band Emission (dBm) | Limit (dBm) | | Verdict |
|---------|--|---------------|----------------------------|---------|
| | | Carrier Level | Calculated 20 dBc Limit | |
| Low | -38.94 | 5.56 | -14.44 | Pass |
| Middle | -40.51 | 5.17 | -14.83 | Pass |
| High | -39.78 | 5.53 | -14.47 | Pass |

Test Plots

802.11b LOW CHANNEL CARRIER LEVEL



802.11b LOW CHANNEL, SPURIOUS 30 MHz ~ 3 GHz

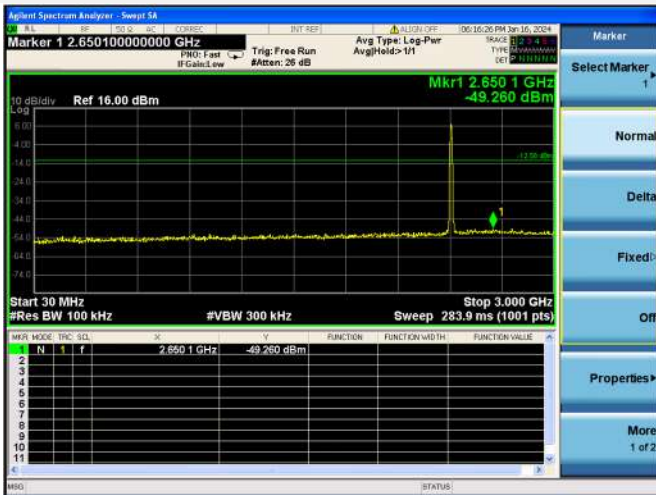

802.11b LOW CHANNEL, SPURIOUS 2 GHz ~ 25 GHz

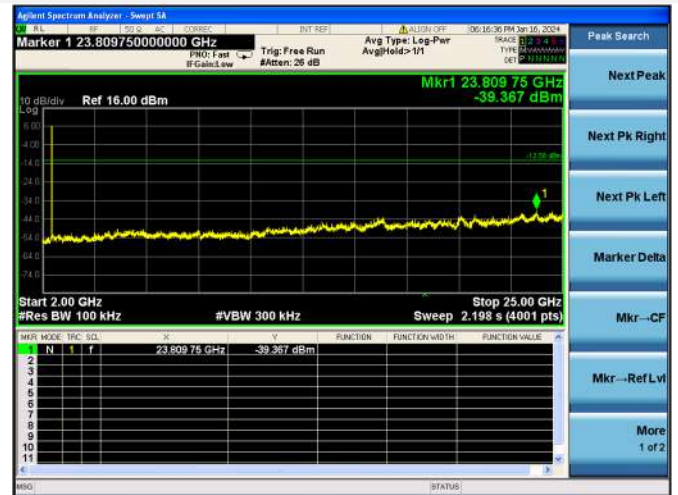

802.11b MIDDLE CHANNEL CARRIER LEVEL



802.11b MIDDLE CHANNEL, SPURIOUS
30 MHz ~ 3 GHz

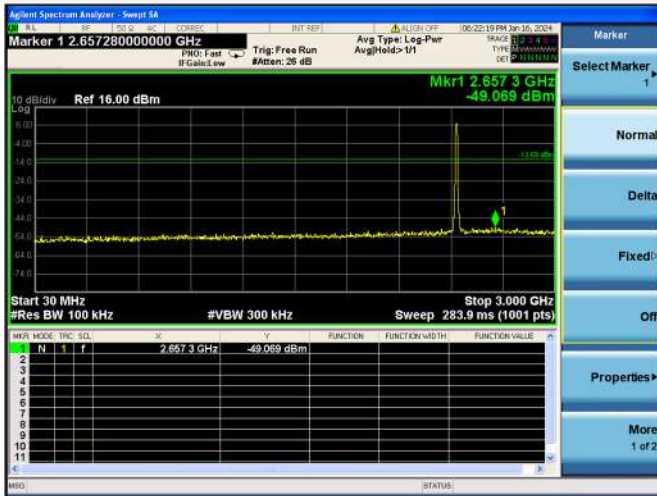

802.11b MIDDLE CHANNEL, SPURIOUS
2 GHz ~ 25 GHz

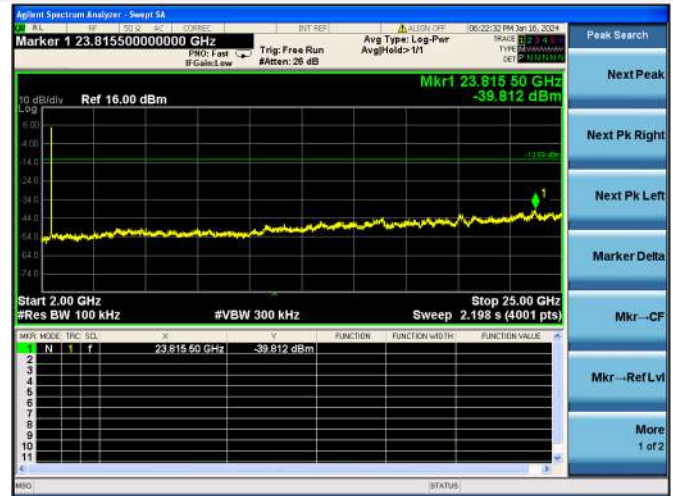

802.11b HIGH CHANNEL CARRIER LEVEL



802.11b HIGH CHANNEL, SPURIOUS
30 MHz ~ 3 GHz

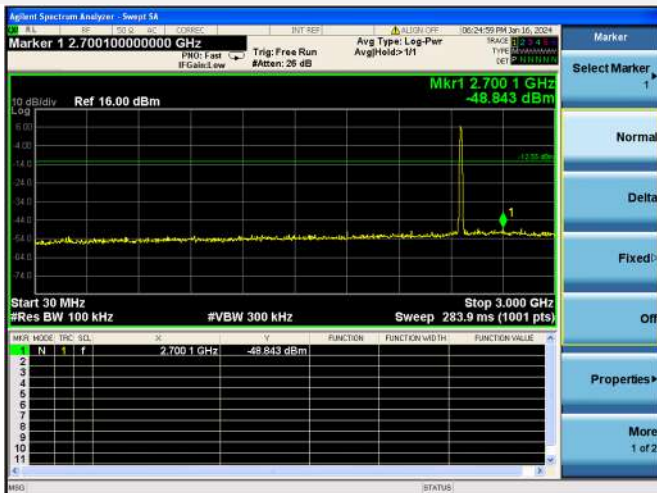

802.11b HIGH CHANNEL, SPURIOUS
2 GHz ~ 25 GHz

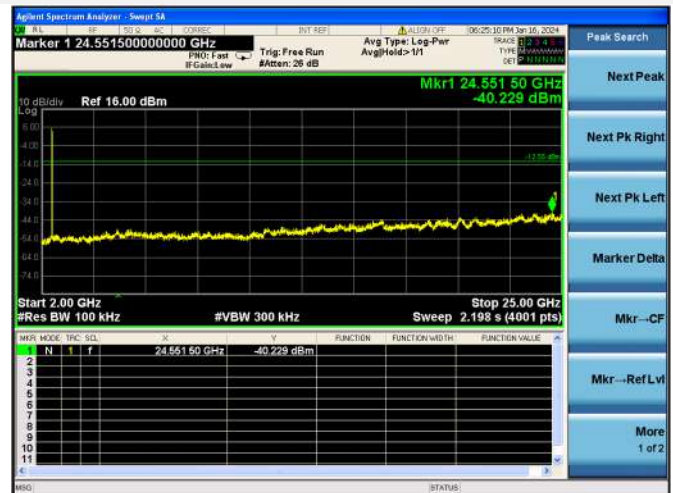

802.11g LOW CHANNEL CARRIER LEVEL



802.11g LOW CHANNEL, SPURIOUS 30 MHz ~ 3 GHz

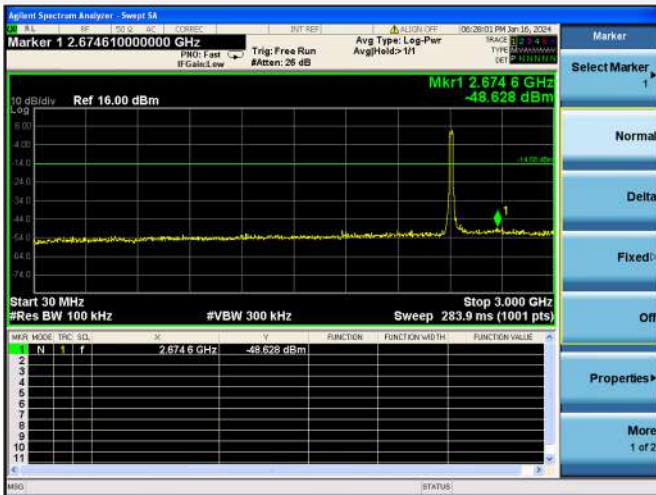

802.11g LOW CHANNEL, SPURIOUS 2 GHz ~ 25 GHz

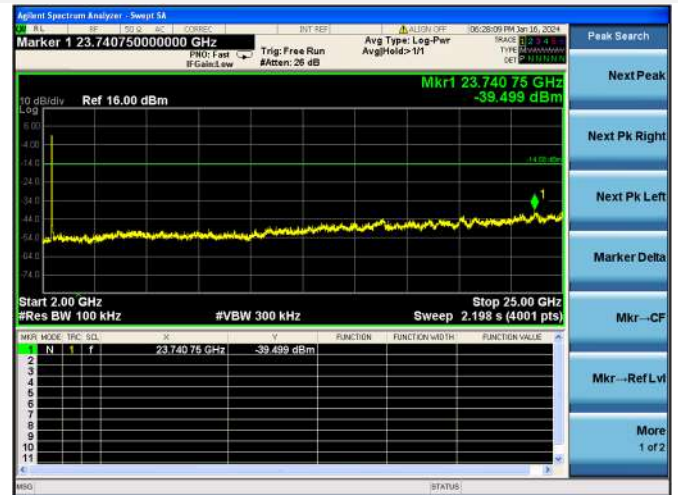

802.11g MIDDLE CHANNEL CARRIER LEVEL



802.11g MIDDLE CHANNEL, SPURIOUS
30 MHz ~ 3 GHz

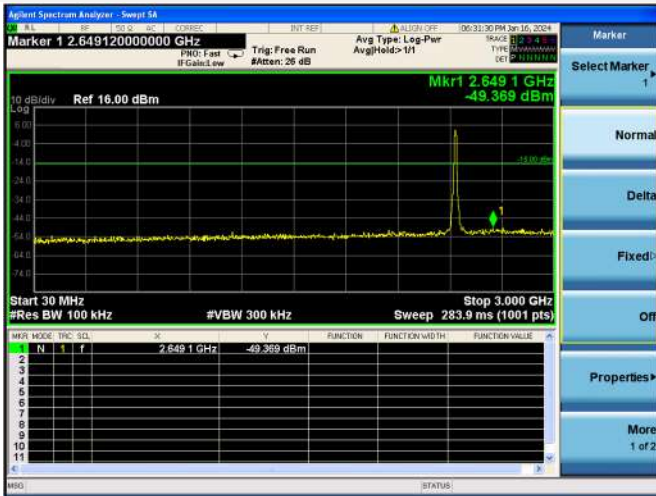

802.11g MIDDLE CHANNEL, SPURIOUS
2 GHz ~ 25 GHz

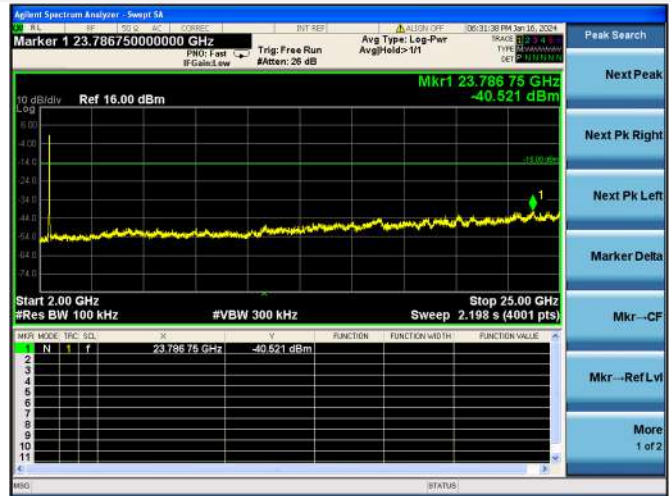

802.11g HIGH CHANNEL CARRIER LEVEL



802.11g HIGH CHANNEL, SPURIOUS
30 MHz ~ 3 GHz

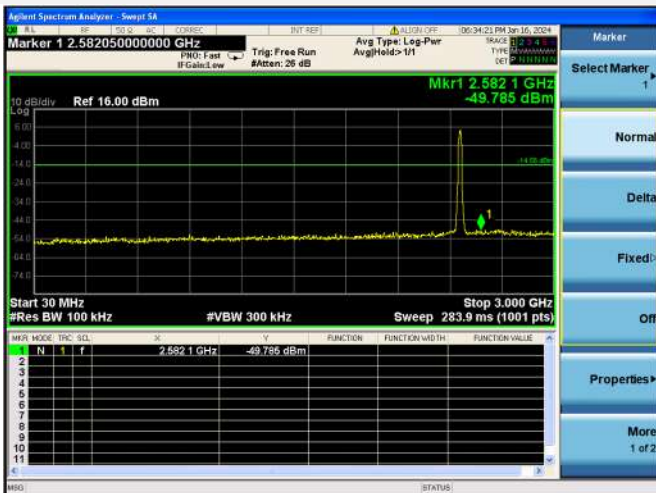

802.11g HIGH CHANNEL, SPURIOUS
2 GHz ~ 25 GHz

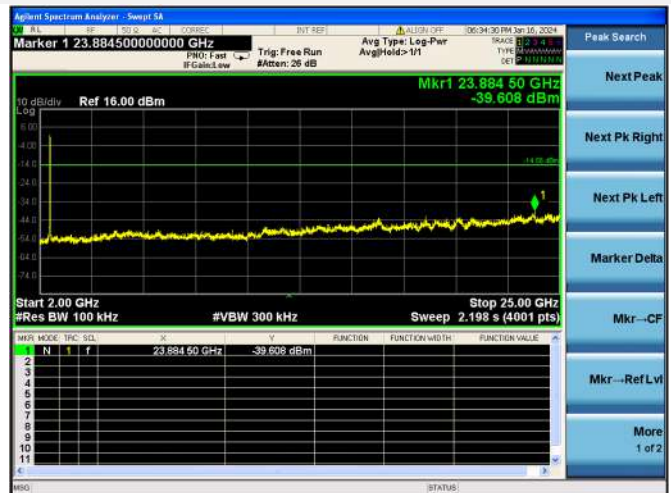

802.11n-20 MHz LOW CHANNEL CARRIER LEVEL



802.11n-20 MHz LOW CHANNEL, SPURIOUS 30 MHz ~ 3 GHz

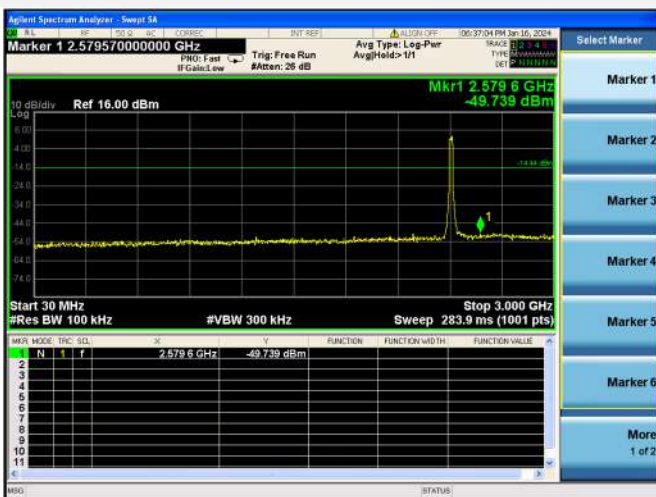

802.11n-20 MHz LOW CHANNEL, SPURIOUS 2 GHz ~ 25 GHz

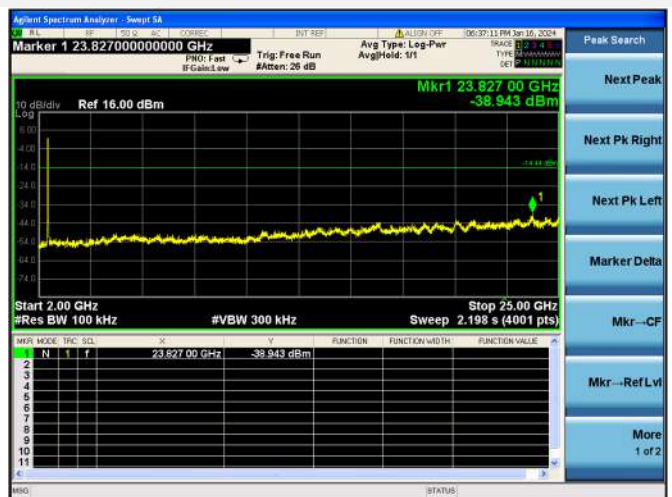

802.11n-20 MHz MIDDLE CHANNEL CARRIER LEVEL



802.11n-20 MHz MIDDLE CHANNEL, SPURIOUS
30 MHz ~ 3 GHz

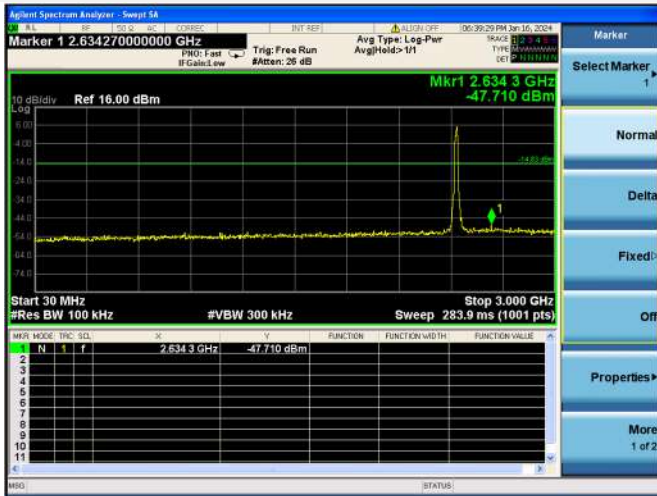

802.11n-20 MHz MIDDLE CHANNEL, SPURIOUS
2 GHz ~ 25 GHz

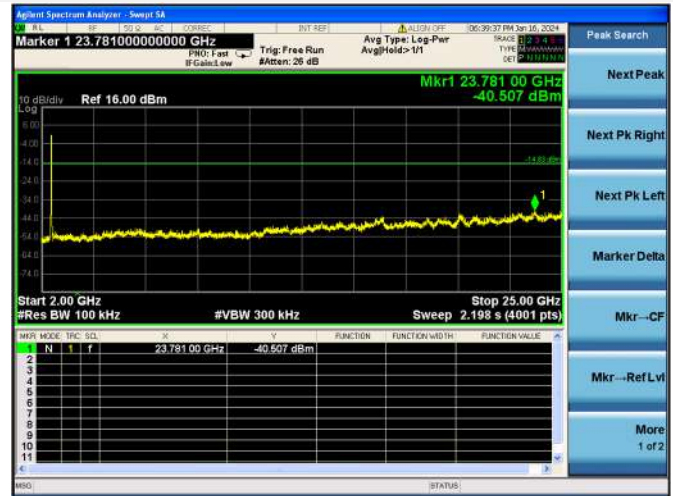

802.11n-20 MHz HIGH CHANNEL CARRIER LEVEL

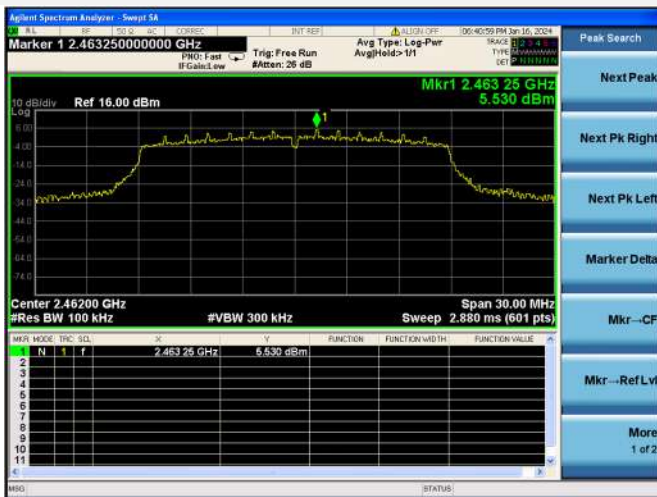

802.11n-20 MHz HIGH CHANNEL, SPURIOUS
30 MHz ~ 3 GHz

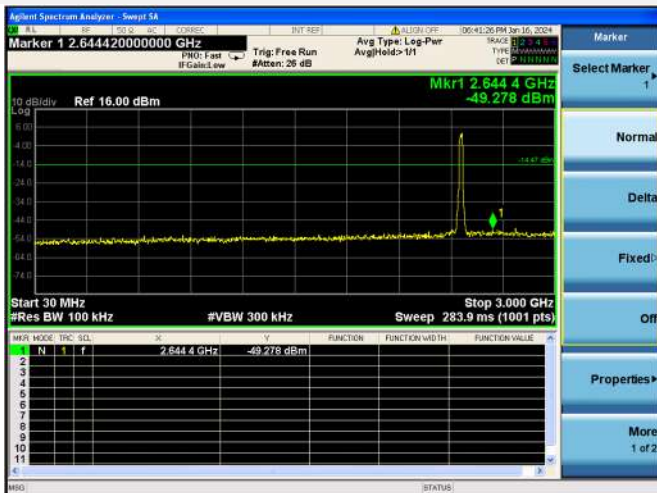

802.11n-20 MHz HIGH CHANNEL, SPURIOUS
2 GHz ~ 25 GHz

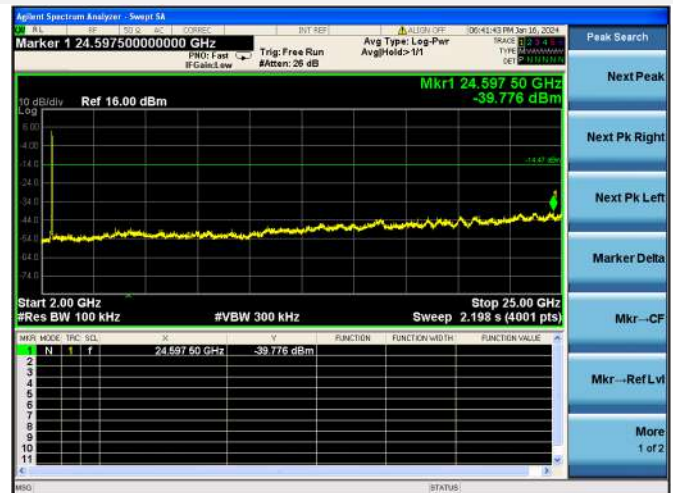

A.4 Band Edge (Authorized-band band-edge)

Test Data

802.11b Mode:

| Channel | Measured Max. Band Edge Emission (dBm) | Limit (dBm) | | Verdict |
|--------------|--|---------------|----------------------------|---------|
| | | Carrier Level | Calculated 20 dBc Limit | |
| Low Channel | -43.88 | 7.42 | -12.58 | Pass |
| High Channel | -48.22 | 7.45 | -12.55 | Pass |

802.11g Mode:

| Channel | Measured Max. Band Edge Emission (dBm) | Limit (dBm) | | Verdict |
|--------------|--|---------------|----------------------------|---------|
| | | Carrier Level | Calculated 20 dBc Limit | |
| Low Channel | -28.62 | 5.42 | -14.58 | Pass |
| High Channel | -41.02 | 5.44 | -14.56 | Pass |

802.11n-20 MHz Mode:

| Channel | Measured Max. Band Edge Emission (dBm) | Limit (dBm) | | Verdict |
|--------------|--|---------------|----------------------------|---------|
| | | Carrier Level | Calculated 20 dBc Limit | |
| Low Channel | -28.42 | 5.56 | -14.44 | Pass |
| High Channel | -38.81 | 5.53 | -14.47 | Pass |

Test Plots

802.11b LOW CHANNEL, CARRIER LEVEL



802.11b LOW CHANNEL, BAND EDGE



802.11b HIGH CHANNEL, CARRIER LEVEL



802.11b HIGH CHANNEL, BAND EDGE

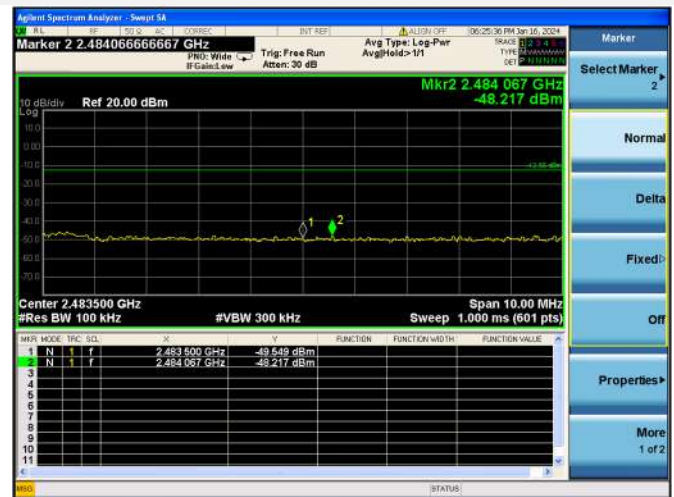

802.11g LOW CHANNEL, CARRIER LEVEL



802.11g LOW CHANNEL, BAND EDGE



802.11g HIGH CHANNEL, CARRIER LEVEL



802.11g HIGH CHANNEL, BAND EDGE

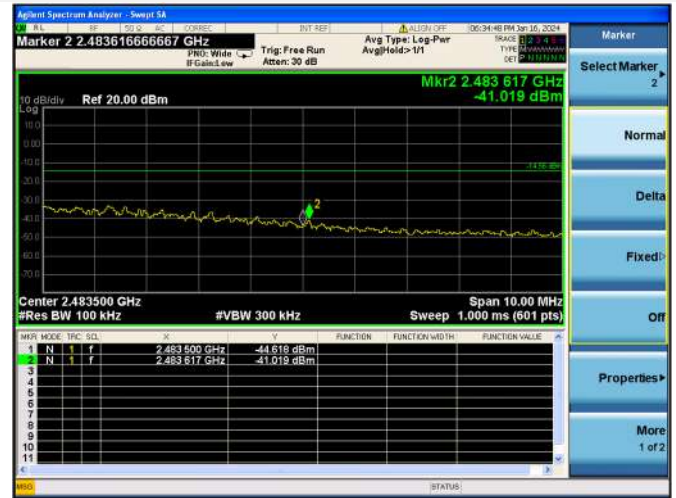

802.11n-20 MHz LOW CHANNEL, CARRIER LEVEL

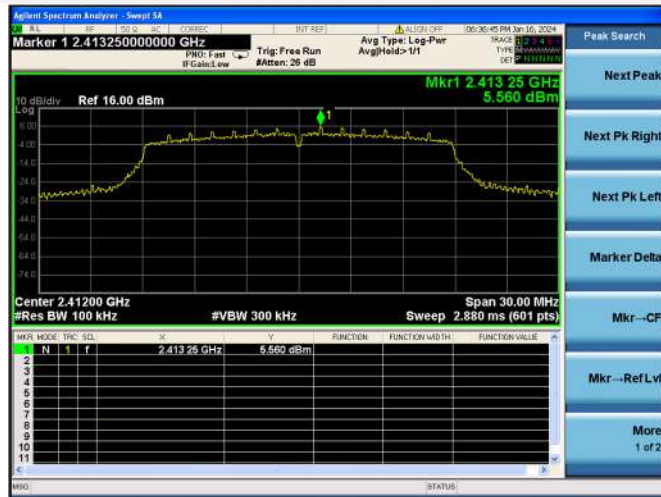

802.11n-20 MHz LOW CHANNEL, BAND EDGE



802.11n-20 MHz HIGH CHANNEL, CARRIER LEVEL

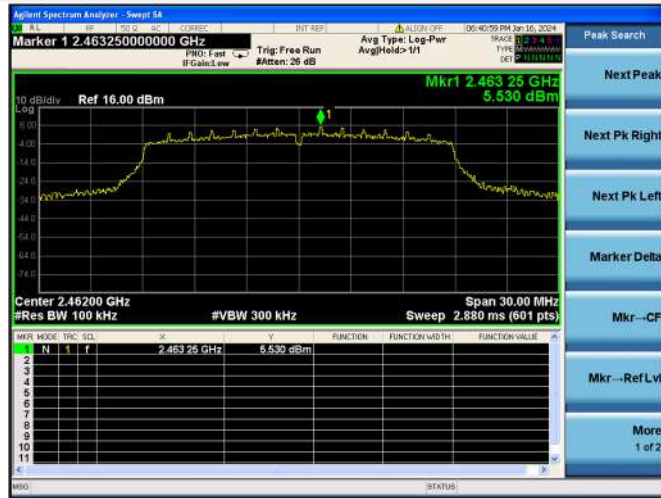

802.11n-20 MHz HIGH CHANNEL, BAND EDGE



A.5 Conducted Emissions

Note ¹: The EUT is working in the Normal link mode. All modes have been tested and normal link mode is worst.

Note ²: Devices subject to Part 15 must be tested for all available U.S. voltages and frequencies (such as a nominal 120 VAC, 60 Hz and 240 VAC, 50 Hz) for which the device is capable of operation. So, The configuration 120 VAC, 60 Hz and 240 VAC, 50 Hz were tested respectively, but only the worst configuration (120 VAC, 60 Hz) shown here.

Test Data and Plots

PHASE L

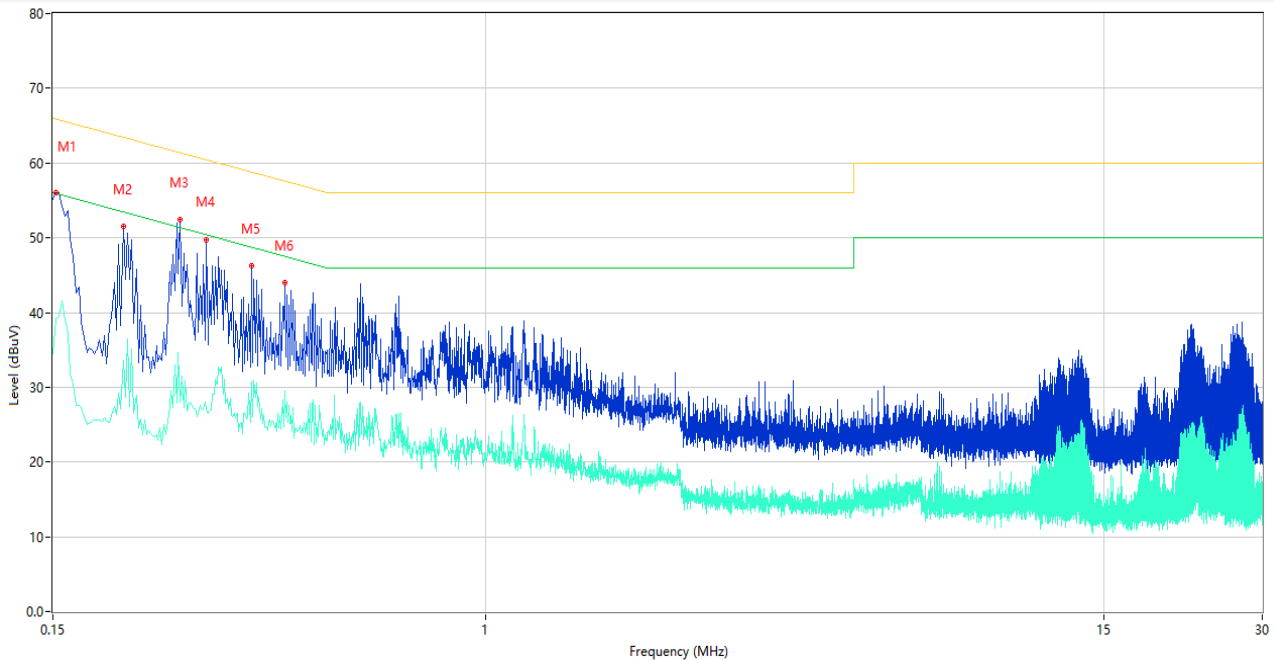

| No. | Frequency (MHz) | Results (dBuV) | Factor (dB) | Limit (dBuV) | Margin (dB) | Detector | Line | Verdict |
|-----|-----------------|----------------|-------------|--------------|-------------|----------|------|---------|
| 1 | 0.152 | 56.00 | 9.47 | 65.89 | 9.89 | Peak | L | Pass |
| 1** | 0.152 | 39.23 | 9.47 | 55.89 | 16.66 | AV | L | Pass |
| 2 | 0.204 | 51.50 | 9.42 | 63.45 | 11.95 | Peak | L | Pass |
| 2** | 0.204 | 33.57 | 9.42 | 53.45 | 19.88 | AV | L | Pass |
| 3 | 0.262 | 52.46 | 9.43 | 61.37 | 8.91 | Peak | L | Pass |
| 3** | 0.262 | 27.96 | 9.43 | 51.37 | 23.41 | AV | L | Pass |
| 4 | 0.294 | 49.73 | 9.43 | 60.41 | 10.68 | Peak | L | Pass |
| 4** | 0.294 | 26.97 | 9.43 | 50.41 | 23.44 | AV | L | Pass |
| 5 | 0.358 | 46.28 | 9.44 | 58.77 | 12.49 | Peak | L | Pass |
| 5** | 0.358 | 30.70 | 9.44 | 48.77 | 18.07 | AV | L | Pass |
| 6 | 0.414 | 43.94 | 9.99 | 57.57 | 13.63 | Peak | L | Pass |
| 6** | 0.414 | 29.57 | 9.99 | 47.57 | 18.00 | AV | L | Pass |

PHASE N

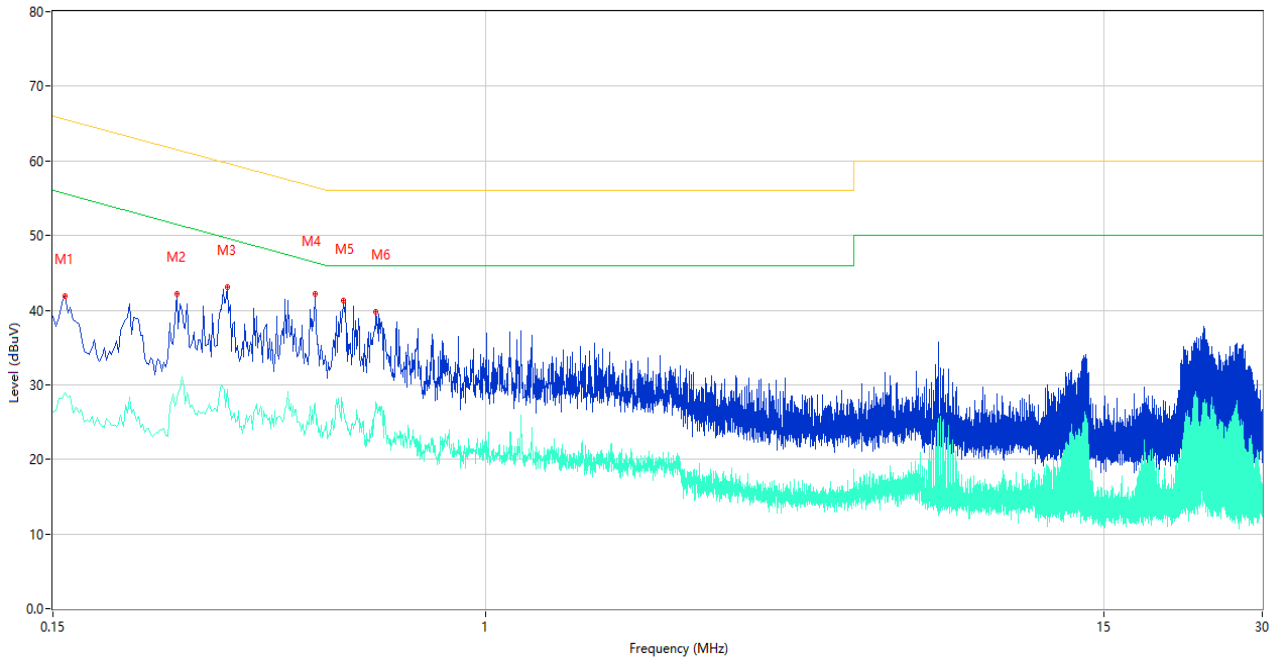

| No. | Frequency (MHz) | Results (dBuV) | Factor (dB) | Limit (dBuV) | Margin (dB) | Detector | Line | Verdict |
|-----|-----------------|----------------|-------------|--------------|-------------|----------|------|---------|
| 1 | 0.158 | 41.87 | 9.46 | 65.57 | 23.70 | Peak | N | Pass |
| 1** | 0.158 | 28.94 | 9.46 | 55.57 | 26.63 | AV | N | Pass |
| 2 | 0.258 | 42.20 | 9.43 | 61.50 | 19.30 | Peak | N | Pass |
| 2** | 0.258 | 28.08 | 9.43 | 51.50 | 23.42 | AV | N | Pass |
| 3 | 0.322 | 43.12 | 9.39 | 59.66 | 16.54 | Peak | N | Pass |
| 3** | 0.322 | 29.42 | 9.39 | 49.66 | 20.24 | AV | N | Pass |
| 4 | 0.474 | 42.25 | 9.81 | 56.44 | 14.19 | Peak | N | Pass |
| 4** | 0.474 | 27.63 | 9.81 | 46.44 | 18.81 | AV | N | Pass |
| 5 | 0.536 | 41.30 | 9.77 | 56.00 | 14.70 | Peak | N | Pass |
| 5** | 0.536 | 26.55 | 9.77 | 46.00 | 19.45 | AV | N | Pass |
| 6 | 0.618 | 39.83 | 9.87 | 56.00 | 16.17 | Peak | N | Pass |
| 6** | 0.618 | 27.68 | 9.87 | 46.00 | 18.32 | AV | N | Pass |

A.6 Radiated Emission

Note ¹: The symbol of "--" in the table which means not application.

Note ²: For the test data above 1 GHz, According the ANSI C63.10-2013, where limits are specified for both average and peak (or quasi-peak) detector functions, if the peak (or quasi-peak) measured value complies with the average limit, it is unnecessary to perform an average measurement.

Note ³: The low frequency, which started from 9 kHz to 30 MHz, was pre-scanned and the result which was 20 dB lower than the limit line per 15.31(o) was not reported.

Note ⁴: The EUT is working in the Normal link mode below 1 GHz. All modes have been tested and normal link mode is worst.

Test Data and Plots

30 MHz to 1 GHz, ANT H

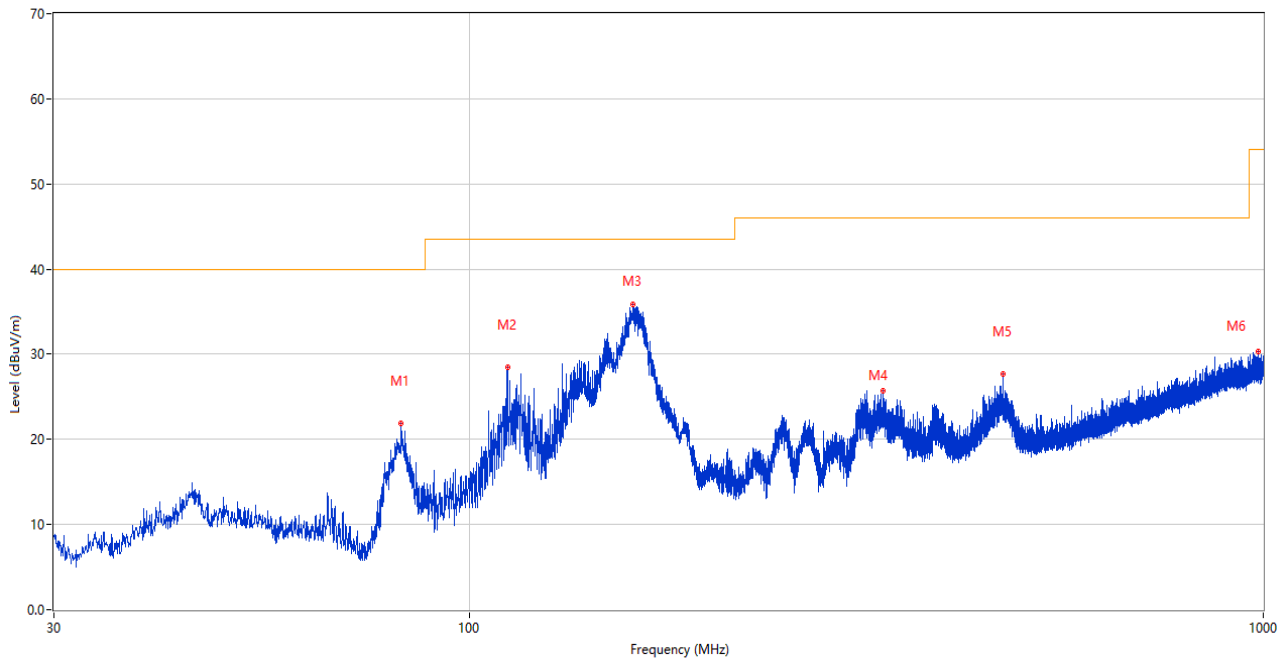

| No. | Frequency (MHz) | Results (dBuV/m) | Factor (dB) | Limit (dBuV/m) | Margin (dB) | Detector | Table (Degree) | Height (cm) | Antenna | Verdict |
|-----|-----------------|------------------|-------------|----------------|-------------|----------|----------------|-------------|------------|---------|
| 1 | 81.992 | 21.87 | -30.72 | 40.0 | 18.13 | Peak | 130.00 | 200 | Horizontal | Pass |
| 2 | 111.723 | 28.46 | -26.95 | 43.5 | 15.04 | Peak | 95.00 | 200 | Horizontal | Pass |
| 3 | 160.805 | 35.91 | -29.54 | 43.5 | 7.59 | Peak | 128.00 | 200 | Horizontal | Pass |
| 4 | 332.446 | 25.74 | -22.72 | 46.0 | 20.26 | Peak | 178.00 | 100 | Horizontal | Pass |
| 5 | 470.720 | 27.72 | -19.44 | 46.0 | 18.28 | Peak | 221.00 | 200 | Horizontal | Pass |
| 6 | 986.662 | 30.33 | -8.64 | 54.0 | 23.67 | Peak | 258.00 | 100 | Horizontal | Pass |

30 MHz to 1 GHz, ANT V

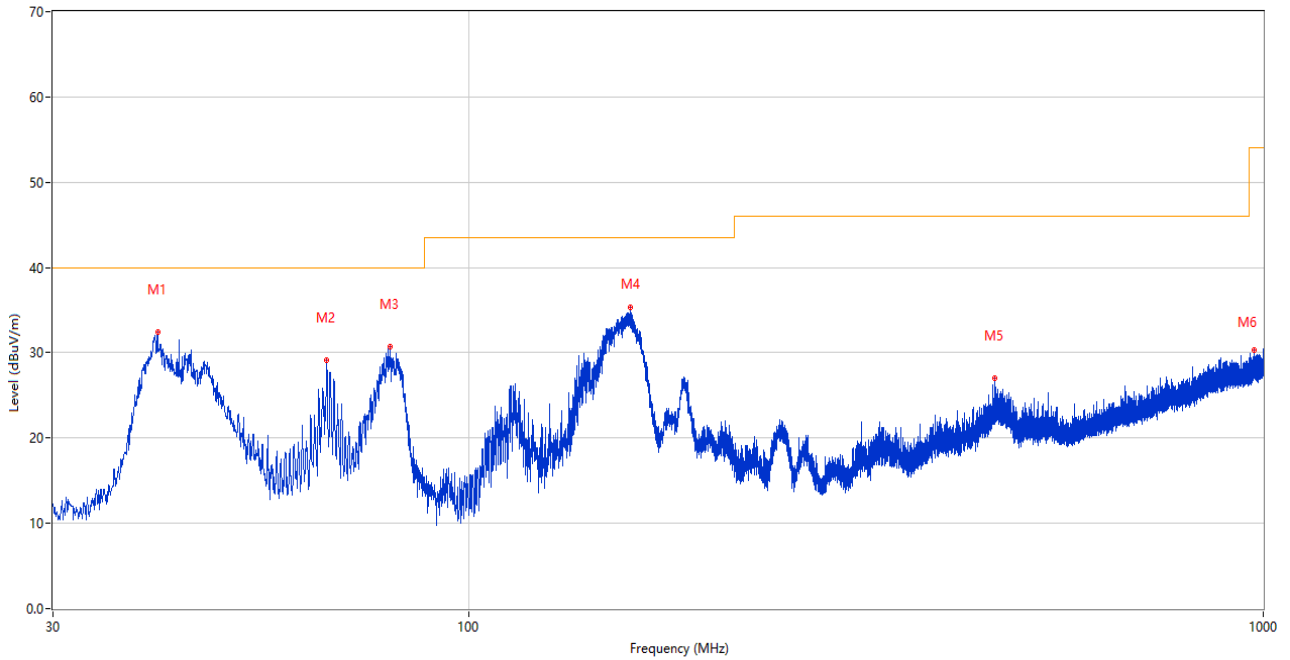

| No. | Frequency (MHz) | Results (dBuV/m) | Factor (dB) | Limit (dBuV/m) | Margin (dB) | Detector | Table (Degree) | Height (cm) | Antenna | Verdict |
|-----|-----------------|------------------|-------------|----------------|-------------|----------|----------------|-------------|----------|---------|
| 1 | 40.621 | 32.44 | -26.52 | 40.0 | 7.56 | Peak | 218.00 | 100 | Vertical | Pass |
| 2 | 66.278 | 29.10 | -27.85 | 40.0 | 10.90 | Peak | 305.00 | 100 | Vertical | Pass |
| 3 | 79.664 | 30.76 | -31.00 | 40.0 | 9.24 | Peak | 260.00 | 100 | Vertical | Pass |
| 4 | 160.028 | 35.36 | -29.57 | 43.5 | 8.14 | Peak | 359.00 | 100 | Vertical | Pass |
| 5 | 459.274 | 27.02 | -19.77 | 46.0 | 18.98 | Peak | 69.00 | 100 | Vertical | Pass |
| 6 | 973.519 | 30.32 | -8.85 | 54.0 | 23.68 | Peak | 360.00 | 100 | Vertical | Pass |

Note 1: The marked spikes near 2400 MHz with circle should be ignored because they are Fundamental signal.

Note 2: The spurious above 18G is noise only, do not show on the report.

1 GHz to 18 GHz, ANT H 802.11b Low Channel

| No. | Frequency (MHz) | Results (dBuV/m) | Factor (dB) | Limit (dBuV/m) | Margin (dB) | Detector | Table (Degree) | Height (cm) | Antenna | Verdict |
|-----|-----------------|------------------|-------------|----------------|-------------|----------|----------------|-------------|------------|---------|
| 1 | 1595.200 | 42.58 | -17.14 | 74.0 | 31.42 | Peak | 217.00 | 400 | Horizontal | Pass |
| 1** | 1595.200 | 33.66 | -17.14 | 54.0 | 20.34 | AV | 217.00 | 400 | Horizontal | Pass |
| 2 | 2410.800 | 101.97 | -10.35 | 74.0 | -27.97 | Peak | 137.00 | 200 | Horizontal | N/A |
| 2** | 2410.800 | 99.09 | -10.35 | 54.0 | -45.09 | AV | 137.00 | 200 | Horizontal | N/A |
| 3 | 4824.250 | 51.55 | -3.48 | 74.0 | 22.45 | Peak | 167.00 | 150 | Horizontal | Pass |
| 3** | 4824.250 | 48.34 | -3.48 | 54.0 | 5.66 | AV | 167.00 | 150 | Horizontal | Pass |
| 4 | 7704.750 | 54.25 | 2.00 | 74.0 | 19.75 | Peak | 143.00 | 300 | Horizontal | Pass |
| 4** | 7704.750 | 45.82 | 2.00 | 54.0 | 8.18 | AV | 143.00 | 300 | Horizontal | Pass |
| 5 | 12552.401 | 52.73 | 1.11 | 74.0 | 21.27 | Peak | 302.00 | 300 | Horizontal | Pass |
| 5** | 12552.401 | 42.84 | 1.11 | 54.0 | 11.16 | AV | 302.00 | 300 | Horizontal | Pass |
| 6 | 17452.163 | 56.21 | 5.53 | 74.0 | 17.79 | Peak | 299.00 | 200 | Horizontal | Pass |
| 6** | 17452.163 | 46.34 | 5.53 | 54.0 | 7.66 | AV | 299.00 | 200 | Horizontal | Pass |

1 GHz to 18 GHz, ANT V 802.11b Low Channel

| No. | Frequency (MHz) | Results (dBuV/m) | Factor (dB) | Limit (dBuV/m) | Margin (dB) | Detector | Table (Degree) | Height (cm) | Antenna | Verdict |
|-----|-----------------|------------------|-------------|----------------|-------------|----------|----------------|-------------|----------|---------|
| 1 | 1463.900 | 42.44 | -17.30 | 74.0 | 31.56 | Peak | 71.00 | 300 | Vertical | Pass |
| 1** | 1463.900 | 32.71 | -17.30 | 54.0 | 21.29 | AV | 71.00 | 300 | Vertical | Pass |
| 2 | 2410.900 | 99.41 | -10.34 | 74.0 | -25.41 | Peak | 269.00 | 150 | Vertical | N/A |
| 2** | 2410.900 | 96.55 | -10.34 | 54.0 | -42.55 | AV | 269.00 | 150 | Vertical | N/A |
| 3 | 4824.250 | 49.95 | -3.48 | 74.0 | 24.05 | Peak | 162.00 | 150 | Vertical | Pass |
| 3** | 4824.250 | 46.44 | -3.48 | 54.0 | 7.56 | AV | 162.00 | 150 | Vertical | Pass |
| 4 | 7709.000 | 53.15 | 1.89 | 74.0 | 20.85 | Peak | 292.00 | 100 | Vertical | Pass |
| 4** | 7709.000 | 44.58 | 1.89 | 54.0 | 9.42 | AV | 292.00 | 100 | Vertical | Pass |
| 5 | 12413.938 | 52.40 | 1.09 | 74.0 | 21.60 | Peak | 316.00 | 300 | Vertical | Pass |
| 5** | 12413.938 | 43.00 | 1.09 | 54.0 | 11.00 | AV | 316.00 | 300 | Vertical | Pass |
| 6 | 17438.251 | 55.51 | 5.53 | 74.0 | 18.49 | Peak | 233.00 | 100 | Vertical | Pass |
| 6** | 17438.251 | 47.08 | 5.53 | 54.0 | 6.92 | AV | 233.00 | 100 | Vertical | Pass |

1 GHz to 18 GHz, ANT H 802.11b Middle Channel

| No. | Frequency (MHz) | Results (dBuV/m) | Factor (dB) | Limit (dBuV/m) | Margin (dB) | Detector | Table (Degree) | Height (cm) | Antenna | Verdict |
|-----|-----------------|------------------|-------------|----------------|-------------|----------|----------------|-------------|------------|---------|
| 1 | 1285.900 | 42.87 | -16.92 | 74.0 | 31.13 | Peak | 0.00 | 400 | Horizontal | Pass |
| 1** | 1285.900 | 32.53 | -16.92 | 54.0 | 21.47 | AV | 0.00 | 400 | Horizontal | Pass |
| 2 | 2438.400 | 100.79 | -9.92 | 74.0 | -26.79 | Peak | 157.00 | 100 | Horizontal | N/A |
| 2** | 2438.400 | 97.95 | -9.92 | 54.0 | -43.95 | AV | 157.00 | 100 | Horizontal | N/A |
| 3 | 4874.250 | 50.46 | -3.45 | 74.0 | 23.54 | Peak | 178.00 | 100 | Horizontal | Pass |
| 3** | 4874.250 | 47.72 | -3.45 | 54.0 | 6.28 | AV | 178.00 | 100 | Horizontal | Pass |
| 4 | 7708.500 | 53.88 | 1.84 | 74.0 | 20.12 | Peak | 246.00 | 300 | Horizontal | Pass |
| 4** | 7708.500 | 44.35 | 1.84 | 54.0 | 9.65 | AV | 246.00 | 300 | Horizontal | Pass |
| 5 | 12973.125 | 52.27 | 1.80 | 74.0 | 21.73 | Peak | 246.00 | 400 | Horizontal | Pass |
| 5** | 12973.125 | 43.03 | 1.80 | 54.0 | 10.97 | AV | 246.00 | 400 | Horizontal | Pass |
| 6 | 17396.251 | 55.84 | 5.25 | 74.0 | 18.16 | Peak | 246.00 | 300 | Horizontal | Pass |
| 6** | 17396.251 | 46.14 | 5.25 | 54.0 | 7.86 | AV | 246.00 | 300 | Horizontal | Pass |

1 GHz to 18 GHz, ANT V 802.11b Middle Channel

| No. | Frequency (MHz) | Results (dBuV/m) | Factor (dB) | Limit (dBuV/m) | Margin (dB) | Detector | Table (Degree) | Height (cm) | Antenna | Verdict |
|-----|-----------------|------------------|-------------|----------------|-------------|----------|----------------|-------------|----------|---------|
| 1 | 1397.200 | 42.10 | -17.19 | 74.0 | 31.90 | Peak | 49.00 | 100 | Vertical | Pass |
| 1** | 1397.200 | 32.30 | -17.19 | 54.0 | 21.70 | AV | 49.00 | 100 | Vertical | Pass |
| 2 | 2438.400 | 99.10 | -9.92 | 74.0 | -25.10 | Peak | 276.00 | 100 | Vertical | N/A |
| 2** | 2438.400 | 96.28 | -9.92 | 54.0 | -42.28 | AV | 276.00 | 100 | Vertical | N/A |
| 3 | 4874.250 | 48.81 | -3.45 | 74.0 | 25.19 | Peak | 310.00 | 100 | Vertical | Pass |
| 3** | 4874.250 | 46.04 | -3.45 | 54.0 | 7.96 | AV | 310.00 | 100 | Vertical | Pass |
| 4 | 7886.000 | 53.31 | 1.78 | 74.0 | 20.69 | Peak | 56.00 | 400 | Vertical | Pass |
| 4** | 7886.000 | 43.84 | 1.78 | 54.0 | 10.16 | AV | 56.00 | 400 | Vertical | Pass |
| 5 | 12998.062 | 52.60 | 2.03 | 74.0 | 21.40 | Peak | 333.00 | 100 | Vertical | Pass |
| 5** | 12998.062 | 43.43 | 2.03 | 54.0 | 10.57 | AV | 333.00 | 100 | Vertical | Pass |
| 6 | 16420.012 | 56.13 | 2.90 | 74.0 | 17.87 | Peak | 178.00 | 300 | Vertical | Pass |
| 6** | 16420.012 | 46.37 | 2.90 | 54.0 | 7.63 | AV | 178.00 | 300 | Vertical | Pass |

1 GHz to 18 GHz, ANT H 802.11b High Channel

| No. | Frequency (MHz) | Results (dBuV/m) | Factor (dB) | Limit (dBuV/m) | Margin (dB) | Detector | Table (Degree) | Height (cm) | Antenna | Verdict |
|-----|-----------------|------------------|-------------|----------------|-------------|----------|----------------|-------------|------------|---------|
| 1 | 1350.600 | 42.49 | -17.13 | 74.0 | 31.51 | Peak | 247.00 | 200 | Horizontal | Pass |
| 1** | 1350.600 | 32.31 | -17.13 | 54.0 | 21.69 | AV | 247.00 | 200 | Horizontal | Pass |
| 2 | 2460.800 | 99.05 | -11.30 | 74.0 | -25.05 | Peak | 149.00 | 150 | Horizontal | N/A |
| 2** | 2460.800 | 96.16 | -11.30 | 54.0 | -42.16 | AV | 149.00 | 150 | Horizontal | N/A |
| 3 | 4924.250 | 49.40 | -3.53 | 74.0 | 24.60 | Peak | 158.00 | 150 | Horizontal | Pass |
| 3** | 4924.250 | 45.53 | -3.53 | 54.0 | 8.47 | AV | 158.00 | 150 | Horizontal | Pass |
| 4 | 7169.750 | 53.76 | 0.51 | 74.0 | 20.24 | Peak | 359.00 | 200 | Horizontal | Pass |
| 4** | 7169.750 | 44.31 | 0.51 | 54.0 | 9.69 | AV | 359.00 | 200 | Horizontal | Pass |
| 5 | 11788.125 | 52.65 | -0.16 | 74.0 | 21.35 | Peak | 75.00 | 100 | Horizontal | Pass |
| 5** | 11788.125 | 43.12 | -0.16 | 54.0 | 10.88 | AV | 75.00 | 100 | Horizontal | Pass |
| 6 | 17210.925 | 56.11 | 3.71 | 74.0 | 17.89 | Peak | 190.00 | 300 | Horizontal | Pass |
| 6** | 17210.925 | 45.77 | 3.71 | 54.0 | 8.23 | AV | 190.00 | 300 | Horizontal | Pass |

1 GHz to 18 GHz, ANT V 802.11b High Channel

| No. | Frequency (MHz) | Results (dBuV/m) | Factor (dB) | Limit (dBuV/m) | Margin (dB) | Detector | Table (Degree) | Height (cm) | Antenna | Verdict |
|-----|-----------------|------------------|-------------|----------------|-------------|----------|----------------|-------------|----------|---------|
| 1 | 1349.600 | 42.77 | -16.92 | 74.0 | 31.23 | Peak | 0.00 | 400 | Vertical | Pass |
| 1** | 1349.600 | 32.88 | -16.92 | 54.0 | 21.12 | AV | 0.00 | 400 | Vertical | Pass |
| 2 | 2460.800 | 98.32 | -11.30 | 74.0 | -24.32 | Peak | 277.00 | 150 | Vertical | N/A |
| 2** | 2460.800 | 95.46 | -11.30 | 54.0 | -41.46 | AV | 277.00 | 150 | Vertical | N/A |
| 3 | 4923.000 | 49.48 | -3.38 | 74.0 | 24.52 | Peak | 360.00 | 100 | Vertical | Pass |
| 3** | 4923.000 | 40.64 | -3.38 | 54.0 | 13.36 | AV | 360.00 | 100 | Vertical | Pass |
| 4 | 7765.000 | 53.33 | 1.50 | 74.0 | 20.67 | Peak | 73.00 | 200 | Vertical | Pass |
| 4** | 7765.000 | 43.64 | 1.50 | 54.0 | 10.36 | AV | 73.00 | 200 | Vertical | Pass |
| 5 | 11810.688 | 52.81 | -0.27 | 74.0 | 21.19 | Peak | 287.00 | 300 | Vertical | Pass |
| 5** | 11810.688 | 42.72 | -0.27 | 54.0 | 11.28 | AV | 287.00 | 300 | Vertical | Pass |
| 6 | 16379.588 | 56.26 | 2.39 | 74.0 | 17.74 | Peak | 341.00 | 100 | Vertical | Pass |
| 6** | 16379.588 | 46.94 | 2.39 | 54.0 | 7.06 | AV | 341.00 | 100 | Vertical | Pass |

1 GHz to 18 GHz, ANT H 802.11g Low Channel

| No. | Frequency (MHz) | Results (dBuV/m) | Factor (dB) | Limit (dBuV/m) | Margin (dB) | Detector | Table (Degree) | Height (cm) | Antenna | Verdict |
|-----|-----------------|------------------|-------------|----------------|-------------|----------|----------------|-------------|------------|---------|
| 1 | 1592.800 | 42.70 | -16.59 | 74.0 | 31.30 | Peak | 134.00 | 300 | Horizontal | Pass |
| 1** | 1592.800 | 33.15 | -16.59 | 54.0 | 20.85 | AV | 134.00 | 300 | Horizontal | Pass |
| 2 | 2410.800 | 103.29 | -10.35 | 74.0 | -29.29 | Peak | 152.00 | 200 | Horizontal | N/A |
| 2** | 2410.800 | 96.50 | -10.35 | 54.0 | -42.50 | AV | 152.00 | 200 | Horizontal | N/A |
| 3 | 4937.250 | 49.46 | -3.43 | 74.0 | 24.54 | Peak | 12.00 | 100 | Horizontal | Pass |
| 3** | 4937.250 | 39.96 | -3.43 | 54.0 | 14.04 | AV | 12.00 | 100 | Horizontal | Pass |
| 4 | 7452.750 | 53.75 | 0.34 | 74.0 | 20.25 | Peak | 12.00 | 100 | Horizontal | Pass |
| 4** | 7452.750 | 43.34 | 0.34 | 54.0 | 10.66 | AV | 12.00 | 100 | Horizontal | Pass |
| 5 | 12005.913 | 52.03 | 0.39 | 74.0 | 21.97 | Peak | 269.00 | 300 | Horizontal | Pass |
| 5** | 12005.913 | 42.30 | 0.39 | 54.0 | 11.70 | AV | 269.00 | 300 | Horizontal | Pass |
| 6 | 17452.687 | 56.05 | 5.52 | 74.0 | 17.95 | Peak | 19.00 | 300 | Horizontal | Pass |
| 6** | 17452.687 | 46.82 | 5.52 | 54.0 | 7.18 | AV | 19.00 | 300 | Horizontal | Pass |

1 GHz to 18 GHz, ANT V 802.11g Low Channel

| No. | Frequency (MHz) | Results (dBuV/m) | Factor (dB) | Limit (dBuV/m) | Margin (dB) | Detector | Table (Degree) | Height (cm) | Antenna | Verdict |
|-----|-----------------|------------------|-------------|----------------|-------------|----------|----------------|-------------|----------|---------|
| 1 | 1475.400 | 42.31 | -17.16 | 74.0 | 31.69 | Peak | 1.00 | 400 | Vertical | Pass |
| 1** | 1475.400 | 32.25 | -17.16 | 54.0 | 21.75 | AV | 1.00 | 400 | Vertical | Pass |
| 2 | 2409.600 | 101.62 | -10.56 | 74.0 | -27.62 | Peak | 281.00 | 150 | Vertical | N/A |
| 2** | 2409.600 | 94.31 | -10.56 | 54.0 | -40.31 | AV | 281.00 | 150 | Vertical | N/A |
| 3 | 4908.000 | 48.99 | -3.45 | 74.0 | 25.01 | Peak | 24.00 | 200 | Vertical | Pass |
| 3** | 4908.000 | 40.31 | -3.45 | 54.0 | 13.69 | AV | 24.00 | 200 | Vertical | Pass |
| 4 | 7420.750 | 54.02 | 1.19 | 74.0 | 19.98 | Peak | 333.00 | 300 | Vertical | Pass |
| 4** | 7420.750 | 44.91 | 1.19 | 54.0 | 9.09 | AV | 333.00 | 300 | Vertical | Pass |
| 5 | 11768.651 | 52.96 | -0.18 | 74.0 | 21.04 | Peak | 360.00 | 400 | Vertical | Pass |
| 5** | 11768.651 | 43.40 | -0.18 | 54.0 | 10.60 | AV | 360.00 | 400 | Vertical | Pass |
| 6 | 16404.525 | 55.99 | 3.11 | 74.0 | 18.01 | Peak | 185.00 | 300 | Vertical | Pass |
| 6** | 16404.525 | 46.90 | 3.11 | 54.0 | 7.10 | AV | 185.00 | 300 | Vertical | Pass |

1 GHz to 18 GHz, ANT H 802.11g Middle Channel

| No. | Frequency (MHz) | Results (dBuV/m) | Factor (dB) | Limit (dBuV/m) | Margin (dB) | Detector | Table (Degree) | Height (cm) | Antenna | Verdict |
|-----|-----------------|------------------|-------------|----------------|-------------|----------|----------------|-------------|------------|---------|
| 1 | 1463.700 | 42.21 | -17.21 | 74.0 | 31.79 | Peak | 264.00 | 400 | Horizontal | Pass |
| 1** | 1463.700 | 32.23 | -17.21 | 54.0 | 21.77 | AV | 264.00 | 400 | Horizontal | Pass |
| 2 | 2438.400 | 102.32 | -9.92 | 74.0 | -28.32 | Peak | 163.00 | 100 | Horizontal | N/A |
| 2** | 2438.400 | 95.97 | -9.92 | 54.0 | -41.97 | AV | 163.00 | 100 | Horizontal | N/A |
| 3 | 4983.000 | 49.33 | -3.44 | 74.0 | 24.67 | Peak | 266.00 | 150 | Horizontal | Pass |
| 3** | 4983.000 | 39.38 | -3.44 | 54.0 | 14.62 | AV | 266.00 | 150 | Horizontal | Pass |
| 4 | 7170.750 | 53.31 | -0.06 | 74.0 | 20.69 | Peak | 360.00 | 300 | Horizontal | Pass |
| 4** | 7170.750 | 44.23 | -0.06 | 54.0 | 9.77 | AV | 360.00 | 300 | Horizontal | Pass |
| 5 | 11255.175 | 52.61 | -0.81 | 74.0 | 21.39 | Peak | 335.00 | 400 | Horizontal | Pass |
| 5** | 11255.175 | 43.28 | -0.81 | 54.0 | 10.72 | AV | 335.00 | 400 | Horizontal | Pass |
| 6 | 16396.386 | 57.18 | 3.03 | 74.0 | 16.82 | Peak | 197.00 | 200 | Horizontal | Pass |
| 6** | 16396.386 | 46.93 | 3.03 | 54.0 | 7.07 | AV | 197.00 | 200 | Horizontal | Pass |

1 GHz to 18 GHz, ANT V 802.11g Middle Channel

| No. | Frequency (MHz) | Results (dBuV/m) | Factor (dB) | Limit (dBuV/m) | Margin (dB) | Detector | Table (Degree) | Height (cm) | Antenna | Verdict |
|-----|-----------------|------------------|-------------|----------------|-------------|----------|----------------|-------------|----------|---------|
| 1 | 1397.700 | 42.20 | -16.78 | 74.0 | 31.80 | Peak | 220.00 | 400 | Vertical | Pass |
| 1** | 1397.700 | 32.31 | -16.78 | 54.0 | 21.69 | AV | 220.00 | 400 | Vertical | Pass |
| 2 | 2438.300 | 100.97 | -10.02 | 74.0 | -26.97 | Peak | 280.00 | 150 | Vertical | N/A |
| 2** | 2438.300 | 94.01 | -10.02 | 54.0 | -40.01 | AV | 280.00 | 150 | Vertical | N/A |
| 3 | 4939.500 | 49.04 | -3.59 | 74.0 | 24.96 | Peak | 30.00 | 200 | Vertical | Pass |
| 3** | 4939.500 | 40.66 | -3.59 | 54.0 | 13.34 | AV | 30.00 | 200 | Vertical | Pass |
| 4 | 7883.250 | 53.24 | 1.80 | 74.0 | 20.76 | Peak | 214.00 | 400 | Vertical | Pass |
| 4** | 7883.250 | 43.63 | 1.80 | 54.0 | 10.37 | AV | 214.00 | 400 | Vertical | Pass |
| 5 | 11770.550 | 52.60 | -0.18 | 74.0 | 21.40 | Peak | 247.00 | 300 | Vertical | Pass |
| 5** | 11770.550 | 43.23 | -0.18 | 54.0 | 10.77 | AV | 247.00 | 300 | Vertical | Pass |
| 6 | 17434.837 | 56.11 | 5.53 | 74.0 | 17.89 | Peak | 231.00 | 100 | Vertical | Pass |
| 6** | 17434.837 | 46.74 | 5.53 | 54.0 | 7.26 | AV | 231.00 | 100 | Vertical | Pass |

1 GHz to 18 GHz, ANT H 802.11g High Channel

| No. | Frequency (MHz) | Results (dBuV/m) | Factor (dB) | Limit (dBuV/m) | Margin (dB) | Detector | Table (Degree) | Height (cm) | Antenna | Verdict |
|-----|-----------------|------------------|-------------|----------------|-------------|----------|----------------|-------------|------------|---------|
| 1 | 1347.400 | 42.33 | -16.72 | 74.0 | 31.67 | Peak | 64.00 | 300 | Horizontal | Pass |
| 1** | 1347.400 | 32.87 | -16.72 | 54.0 | 21.13 | AV | 64.00 | 300 | Horizontal | Pass |
| 2 | 2459.700 | 101.37 | -11.46 | 74.0 | -27.37 | Peak | 144.00 | 150 | Horizontal | N/A |
| 2** | 2459.700 | 93.88 | -11.46 | 54.0 | -39.88 | AV | 144.00 | 150 | Horizontal | N/A |
| 3 | 4936.750 | 49.08 | -3.57 | 74.0 | 24.92 | Peak | 334.00 | 100 | Horizontal | Pass |
| 3** | 4936.750 | 39.65 | -3.57 | 54.0 | 14.35 | AV | 334.00 | 100 | Horizontal | Pass |
| 4 | 7172.500 | 53.03 | 0.02 | 74.0 | 20.97 | Peak | 310.00 | 100 | Horizontal | Pass |
| 4** | 7172.500 | 43.08 | 0.02 | 54.0 | 10.92 | AV | 310.00 | 100 | Horizontal | Pass |
| 5 | 12995.438 | 52.59 | 2.01 | 74.0 | 21.41 | Peak | 0.00 | 100 | Horizontal | Pass |
| 5** | 12995.438 | 43.53 | 2.01 | 54.0 | 10.47 | AV | 0.00 | 100 | Horizontal | Pass |
| 6 | 16399.800 | 55.49 | 3.16 | 74.0 | 18.51 | Peak | 0.00 | 300 | Horizontal | Pass |
| 6** | 16399.800 | 46.36 | 3.16 | 54.0 | 7.64 | AV | 0.00 | 300 | Horizontal | Pass |

1 GHz to 18 GHz, ANT V 802.11g High Channel

| No. | Frequency (MHz) | Results (dBuV/m) | Factor (dB) | Limit (dBuV/m) | Margin (dB) | Detector | Table (Degree) | Height (cm) | Antenna | Verdict |
|-----|-----------------|------------------|-------------|----------------|-------------|----------|----------------|-------------|----------|---------|
| 1 | 1320.100 | 42.33 | -16.97 | 74.0 | 31.67 | Peak | 42.00 | 300 | Vertical | Pass |
| 1** | 1320.100 | 33.39 | -16.97 | 54.0 | 20.61 | AV | 42.00 | 300 | Vertical | Pass |
| 2 | 2459.700 | 100.73 | -11.46 | 74.0 | -26.73 | Peak | 279.00 | 100 | Vertical | N/A |
| 2** | 2459.700 | 93.90 | -11.46 | 54.0 | -39.90 | AV | 279.00 | 100 | Vertical | N/A |
| 3 | 4918.750 | 48.88 | -3.54 | 74.0 | 25.12 | Peak | 151.00 | 100 | Vertical | Pass |
| 3** | 4918.750 | 39.52 | -3.54 | 54.0 | 14.48 | AV | 151.00 | 100 | Vertical | Pass |
| 4 | 7759.250 | 53.80 | 1.54 | 74.0 | 20.20 | Peak | 202.00 | 400 | Vertical | Pass |
| 4** | 7759.250 | 44.40 | 1.54 | 54.0 | 9.60 | AV | 202.00 | 400 | Vertical | Pass |
| 5 | 12980.737 | 53.31 | 1.87 | 74.0 | 20.69 | Peak | 0.00 | 200 | Vertical | Pass |
| 5** | 12980.737 | 43.25 | 1.87 | 54.0 | 10.75 | AV | 0.00 | 200 | Vertical | Pass |
| 6 | 17439.824 | 55.91 | 5.54 | 74.0 | 18.09 | Peak | 63.00 | 100 | Vertical | Pass |
| 6** | 17439.824 | 47.00 | 5.54 | 54.0 | 7.00 | AV | 63.00 | 100 | Vertical | Pass |

1 GHz to 18 GHz, ANT H 802.11n20 Low Channel

| No. | Frequency (MHz) | Results (dBuV/m) | Factor (dB) | Limit (dBuV/m) | Margin (dB) | Detector | Table (Degree) | Height (cm) | Antenna | Verdict |
|-----|-----------------|------------------|-------------|----------------|-------------|----------|----------------|-------------|------------|---------|
| 1 | 1576.100 | 42.31 | -16.80 | 74.0 | 31.69 | Peak | 39.00 | 200 | Horizontal | Pass |
| 1** | 1576.100 | 33.23 | -16.80 | 54.0 | 20.77 | AV | 39.00 | 200 | Horizontal | Pass |
| 2 | 2410.500 | 103.78 | -10.41 | 74.0 | -29.78 | Peak | 146.00 | 150 | Horizontal | N/A |
| 2** | 2410.500 | 96.47 | -10.41 | 54.0 | -42.47 | AV | 146.00 | 150 | Horizontal | N/A |
| 3 | 4892.500 | 49.09 | -3.64 | 74.0 | 24.91 | Peak | 290.00 | 100 | Horizontal | Pass |
| 3** | 4892.500 | 40.07 | -3.64 | 54.0 | 13.93 | AV | 290.00 | 100 | Horizontal | Pass |
| 4 | 7868.500 | 53.30 | 1.78 | 74.0 | 20.70 | Peak | 219.00 | 200 | Horizontal | Pass |
| 4** | 7868.500 | 44.27 | 1.78 | 54.0 | 9.73 | AV | 219.00 | 200 | Horizontal | Pass |
| 5 | 11755.112 | 52.70 | -0.19 | 74.0 | 21.30 | Peak | 131.00 | 300 | Horizontal | Pass |
| 5** | 11755.112 | 43.28 | -0.19 | 54.0 | 10.72 | AV | 131.00 | 300 | Horizontal | Pass |
| 6 | 16383.000 | 55.72 | 2.52 | 74.0 | 18.28 | Peak | 120.00 | 100 | Horizontal | Pass |
| 6** | 16383.000 | 46.08 | 2.52 | 54.0 | 7.92 | AV | 120.00 | 100 | Horizontal | Pass |

1 GHz to 18 GHz, ANT V 802.11n20 Low Channel

| No. | Frequency (MHz) | Results (dBuV/m) | Factor (dB) | Limit (dBuV/m) | Margin (dB) | Detector | Table (Degree) | Height (cm) | Antenna | Verdict |
|-----|-----------------|------------------|-------------|----------------|-------------|----------|----------------|-------------|----------|---------|
| 1 | 1531.500 | 42.97 | -16.78 | 74.0 | 31.03 | Peak | 0.00 | 200 | Vertical | Pass |
| 1** | 1531.500 | 32.89 | -16.78 | 54.0 | 21.11 | AV | 0.00 | 200 | Vertical | Pass |
| 2 | 2409.900 | 101.39 | -10.41 | 74.0 | -27.39 | Peak | 283.00 | 100 | Vertical | N/A |
| 2** | 2409.900 | 94.05 | -10.41 | 54.0 | -40.05 | AV | 283.00 | 100 | Vertical | N/A |
| 3 | 4736.250 | 48.98 | -2.92 | 74.0 | 25.02 | Peak | 148.00 | 150 | Vertical | Pass |
| 3** | 4736.250 | 39.56 | -2.92 | 54.0 | 14.44 | AV | 148.00 | 150 | Vertical | Pass |
| 4 | 7409.250 | 53.30 | 0.63 | 74.0 | 20.70 | Peak | 280.00 | 300 | Vertical | Pass |
| 4** | 7409.250 | 43.23 | 0.63 | 54.0 | 10.77 | AV | 280.00 | 300 | Vertical | Pass |
| 5 | 12370.000 | 52.69 | 0.95 | 74.0 | 21.31 | Peak | 303.00 | 300 | Vertical | Pass |
| 5** | 12370.000 | 42.77 | 0.95 | 54.0 | 11.23 | AV | 303.00 | 300 | Vertical | Pass |
| 6 | 17404.125 | 56.03 | 5.44 | 74.0 | 17.97 | Peak | 343.00 | 100 | Vertical | Pass |
| 6** | 17404.125 | 46.51 | 5.44 | 54.0 | 7.49 | AV | 343.00 | 100 | Vertical | Pass |

1 GHz to 18 GHz, ANT H 802.11n20 Middle Channel

| No. | Frequency (MHz) | Results (dBuV/m) | Factor (dB) | Limit (dBuV/m) | Margin (dB) | Detector | Table (Degree) | Height (cm) | Antenna | Verdict |
|-----|-----------------|------------------|-------------|----------------|-------------|----------|----------------|-------------|------------|---------|
| 1 | 1349.200 | 43.00 | -16.90 | 74.0 | 31.00 | Peak | 300.00 | 100 | Horizontal | Pass |
| 1** | 1349.200 | 32.78 | -16.90 | 54.0 | 21.22 | AV | 300.00 | 100 | Horizontal | Pass |
| 2 | 2438.500 | 102.15 | -9.93 | 74.0 | -28.15 | Peak | 156.00 | 100 | Horizontal | N/A |
| 2** | 2438.500 | 95.24 | -9.93 | 54.0 | -41.24 | AV | 156.00 | 100 | Horizontal | N/A |
| 3 | 4877.250 | 48.78 | -3.42 | 74.0 | 25.22 | Peak | 283.00 | 150 | Horizontal | Pass |
| 3** | 4877.250 | 39.94 | -3.42 | 54.0 | 14.06 | AV | 283.00 | 150 | Horizontal | Pass |
| 4 | 7704.250 | 53.83 | 1.69 | 74.0 | 20.17 | Peak | 283.00 | 200 | Horizontal | Pass |
| 4** | 7704.250 | 44.69 | 1.69 | 54.0 | 9.31 | AV | 283.00 | 200 | Horizontal | Pass |
| 5 | 12423.912 | 52.70 | 1.07 | 74.0 | 21.30 | Peak | 128.00 | 400 | Horizontal | Pass |
| 5** | 12423.912 | 42.69 | 1.07 | 54.0 | 11.31 | AV | 128.00 | 400 | Horizontal | Pass |
| 6 | 17455.051 | 56.82 | 5.47 | 74.0 | 17.18 | Peak | 152.00 | 200 | Horizontal | Pass |
| 6** | 17455.051 | 46.52 | 5.47 | 54.0 | 7.48 | AV | 152.00 | 200 | Horizontal | Pass |

1 GHz to 18 GHz, ANT V 802.11n20 Middle Channel

| No. | Frequency (MHz) | Results (dBuV/m) | Factor (dB) | Limit (dBuV/m) | Margin (dB) | Detector | Table (Degree) | Height (cm) | Antenna | Verdict |
|-----|-----------------|------------------|-------------|----------------|-------------|----------|----------------|-------------|----------|---------|
| 1 | 1478.100 | 42.52 | -17.16 | 74.0 | 31.48 | Peak | 183.00 | 100 | Vertical | Pass |
| 1** | 1478.100 | 33.91 | -17.16 | 54.0 | 20.09 | AV | 183.00 | 100 | Vertical | Pass |
| 2 | 2438.300 | 101.49 | -10.02 | 74.0 | -27.49 | Peak | 283.00 | 100 | Vertical | N/A |
| 2** | 2438.300 | 94.22 | -10.02 | 54.0 | -40.22 | AV | 283.00 | 100 | Vertical | N/A |
| 3 | 4818.000 | 50.11 | -2.89 | 74.0 | 23.89 | Peak | 337.00 | 200 | Vertical | Pass |
| 3** | 4818.000 | 40.07 | -2.89 | 54.0 | 13.93 | AV | 337.00 | 200 | Vertical | Pass |
| 4 | 7139.750 | 53.23 | 0.23 | 74.0 | 20.77 | Peak | 337.00 | 200 | Vertical | Pass |
| 4** | 7139.750 | 43.63 | 0.23 | 54.0 | 10.37 | AV | 337.00 | 200 | Vertical | Pass |
| 5 | 11727.325 | 53.31 | -0.34 | 74.0 | 20.69 | Peak | 327.00 | 100 | Vertical | Pass |
| 5** | 11727.325 | 42.73 | -0.34 | 54.0 | 11.27 | AV | 327.00 | 100 | Vertical | Pass |
| 6 | 16375.650 | 55.61 | 2.24 | 74.0 | 18.39 | Peak | 214.00 | 100 | Vertical | Pass |
| 6** | 16375.650 | 45.41 | 2.24 | 54.0 | 8.59 | AV | 214.00 | 100 | Vertical | Pass |

1 GHz to 18 GHz, ANT H 802.11n20 High Channel

| No. | Frequency (MHz) | Results (dBuV/m) | Factor (dB) | Limit (dBuV/m) | Margin (dB) | Detector | Table (Degree) | Height (cm) | Antenna | Verdict |
|-----|-----------------|------------------|-------------|----------------|-------------|----------|----------------|-------------|------------|---------|
| 1 | 1577.000 | 42.15 | -16.98 | 74.0 | 31.85 | Peak | 360.00 | 400 | Horizontal | Pass |
| 1** | 1577.000 | 33.09 | -16.98 | 54.0 | 20.91 | AV | 360.00 | 400 | Horizontal | Pass |
| 2 | 2459.100 | 101.65 | -11.23 | 74.0 | -27.65 | Peak | 147.00 | 150 | Horizontal | N/A |
| 2** | 2459.100 | 94.66 | -11.23 | 54.0 | -40.66 | AV | 147.00 | 150 | Horizontal | N/A |
| 3 | 4959.250 | 48.90 | -3.56 | 74.0 | 25.10 | Peak | 0.00 | 150 | Horizontal | Pass |
| 3** | 4959.250 | 39.68 | -3.56 | 54.0 | 14.32 | AV | 0.00 | 150 | Horizontal | Pass |
| 4 | 7420.250 | 53.01 | 1.47 | 74.0 | 20.99 | Peak | 210.00 | 400 | Horizontal | Pass |
| 4** | 7420.250 | 44.08 | 1.47 | 54.0 | 9.92 | AV | 210.00 | 400 | Horizontal | Pass |
| 5 | 11786.463 | 52.95 | -0.16 | 74.0 | 21.05 | Peak | 45.00 | 100 | Horizontal | Pass |
| 5** | 11786.463 | 42.84 | -0.16 | 54.0 | 11.16 | AV | 45.00 | 100 | Horizontal | Pass |
| 6 | 16406.100 | 55.76 | 3.09 | 74.0 | 18.24 | Peak | 217.00 | 400 | Horizontal | Pass |
| 6** | 16406.100 | 46.84 | 3.09 | 54.0 | 7.16 | AV | 217.00 | 400 | Horizontal | Pass |

1 GHz to 18 GHz, ANT V 802.11n20 High Channel

| No. | Frequency (MHz) | Results (dBuV/m) | Factor (dB) | Limit (dBuV/m) | Margin (dB) | Detector | Table (Degree) | Height (cm) | Antenna | Verdict |
|-----|-----------------|------------------|-------------|----------------|-------------|----------|----------------|-------------|----------|---------|
| 1 | 1300.200 | 42.23 | -17.04 | 74.0 | 31.77 | Peak | 360.00 | 200 | Vertical | Pass |
| 1** | 1300.200 | 32.81 | -17.04 | 54.0 | 21.19 | AV | 360.00 | 200 | Vertical | Pass |
| 2 | 2458.300 | 101.01 | -11.21 | 74.0 | -27.01 | Peak | 283.00 | 100 | Vertical | N/A |
| 2** | 2458.300 | 93.09 | -11.21 | 54.0 | -39.09 | AV | 283.00 | 100 | Vertical | N/A |
| 3 | 4857.500 | 49.14 | -3.58 | 74.0 | 24.86 | Peak | 42.00 | 200 | Vertical | Pass |
| 3** | 4857.500 | 39.58 | -3.58 | 54.0 | 14.42 | AV | 42.00 | 200 | Vertical | Pass |
| 4 | 7164.750 | 53.90 | 0.10 | 74.0 | 20.10 | Peak | 302.00 | 300 | Vertical | Pass |
| 4** | 7164.750 | 44.08 | 0.10 | 54.0 | 9.92 | AV | 302.00 | 300 | Vertical | Pass |
| 5 | 12516.537 | 52.91 | 1.34 | 74.0 | 21.09 | Peak | 147.00 | 400 | Vertical | Pass |
| 5** | 12516.537 | 43.23 | 1.34 | 54.0 | 10.77 | AV | 147.00 | 400 | Vertical | Pass |
| 6 | 17443.238 | 56.02 | 5.55 | 74.0 | 17.98 | Peak | 7.00 | 100 | Vertical | Pass |
| 6** | 17443.238 | 46.66 | 5.55 | 54.0 | 7.34 | AV | 7.00 | 100 | Vertical | Pass |

A.7 Band Edge (Restricted-band band-edge)

Note ¹: The lowest and highest channels are tested to verify the band edge emissions. Please refer to the following the plots for emissions values.

Note ²: The test data all are tested in the vertical and horizontal antenna which the trace is max hold. So these plots have shown the worst case.

Note ³: According the ANSI C63.10-2013, where limits are specified for both average and peak (or quasi-peak) detector functions, if the peak (or quasi-peak) measured value complies with the average limit, it is unnecessary to perform an average measurement.

Test Data and Plots

802.11b LOW CHANNEL

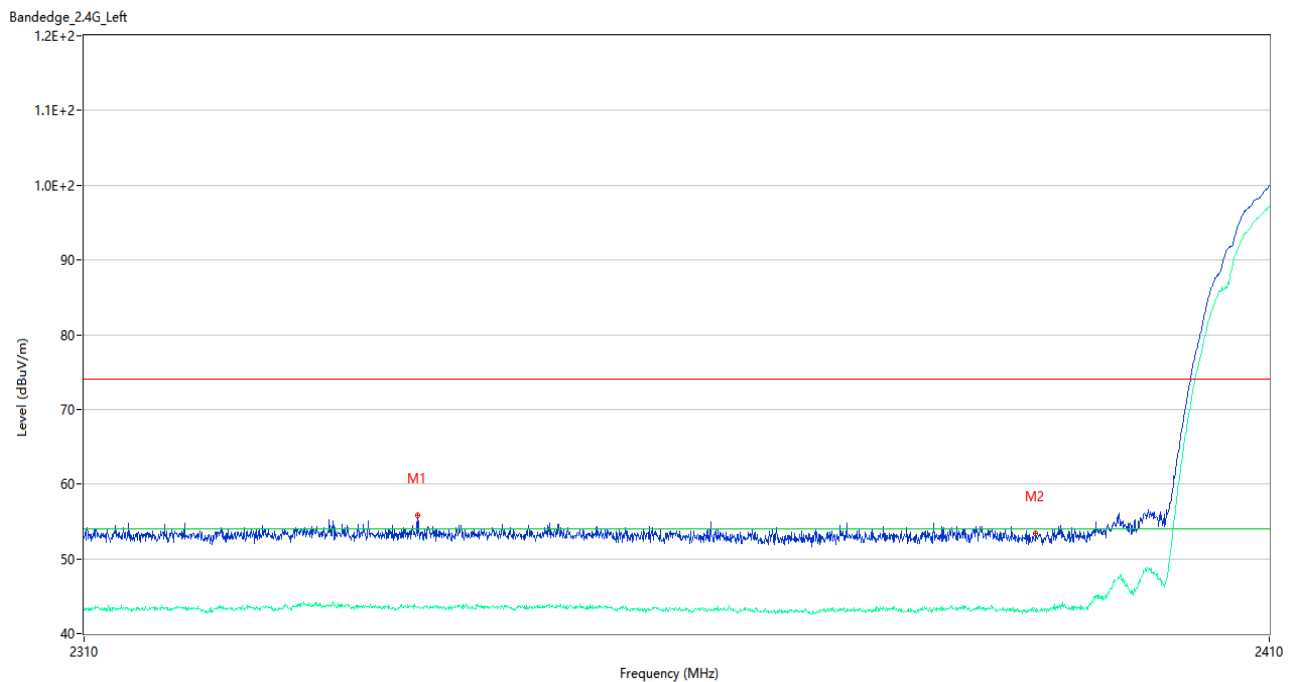

| No. | Frequency (MHz) | Results (dBuV/m) | Factor (dB) | Limit (dBuV/m) | Margin (dB) | Detector | Table (Degree) | Height (cm) | Antenna | Verdict |
|-----|-----------------|------------------|-------------|----------------|-------------|----------|----------------|-------------|------------|---------|
| 1 | 2337.750 | 55.76 | -0.98 | 74.0 | 18.24 | Peak | 27.00 | 200 | Horizontal | Pass |
| 1** | 2337.750 | 43.60 | -0.98 | 54.0 | 10.40 | AV | 27.00 | 200 | Horizontal | Pass |
| 2 | 2389.950 | 53.35 | -1.82 | 74.0 | 20.65 | Peak | 103.00 | 100 | Horizontal | Pass |
| 2** | 2389.950 | 43.02 | -1.82 | 54.0 | 10.98 | AV | 103.00 | 100 | Horizontal | Pass |

802.11b HIGH CHANNEL

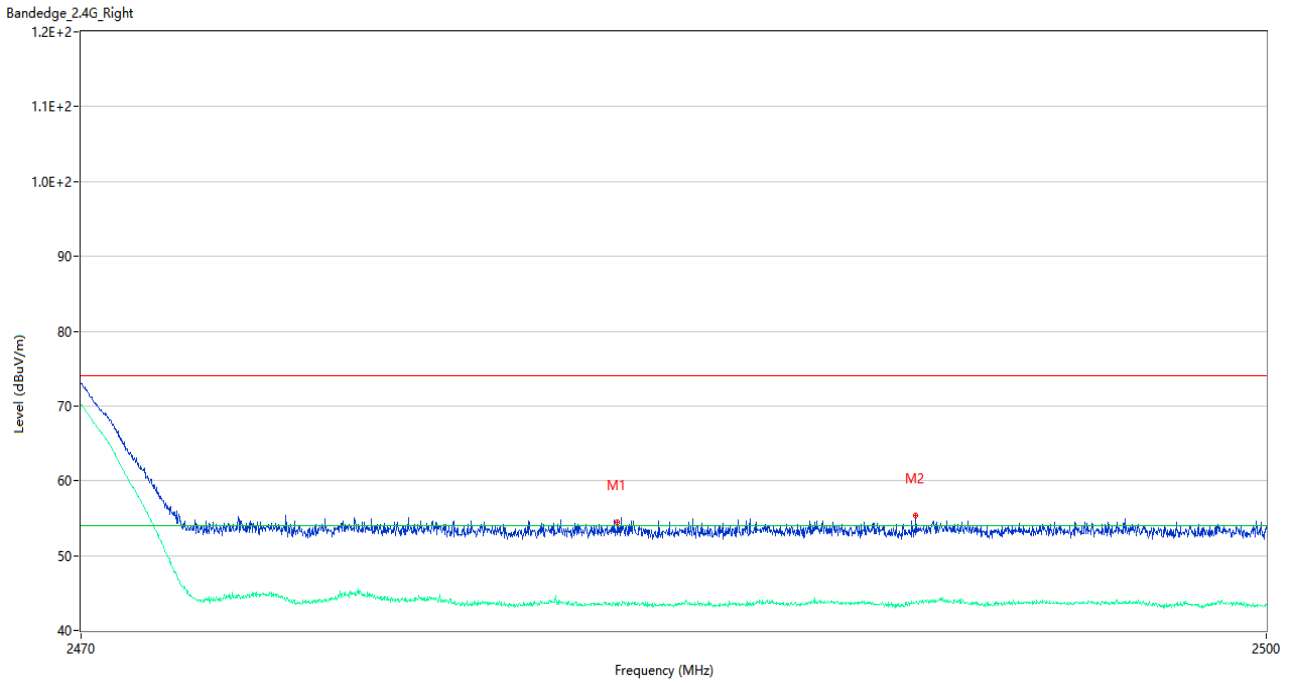

| No. | Frequency (MHz) | Results (dBuV/m) | Factor (dB) | Limit (dBuV/m) | Margin (dB) | Detector | Table (Degree) | Height (cm) | Antenna | Verdict |
|-----|-----------------|------------------|-------------|----------------|-------------|----------|----------------|-------------|------------|---------|
| 1 | 2483.530 | 54.41 | -1.10 | 74.0 | 19.59 | Peak | 360.00 | 200 | Horizontal | Pass |
| 1** | 2483.530 | 43.82 | -1.10 | 54.0 | 10.18 | AV | 360.00 | 200 | Horizontal | Pass |
| 2 | 2491.090 | 55.34 | -0.89 | 74.0 | 18.66 | Peak | 136.00 | 150 | Horizontal | Pass |
| 2** | 2491.090 | 43.75 | -0.89 | 54.0 | 10.25 | AV | 136.00 | 150 | Horizontal | Pass |

802.11g LOW CHANNEL

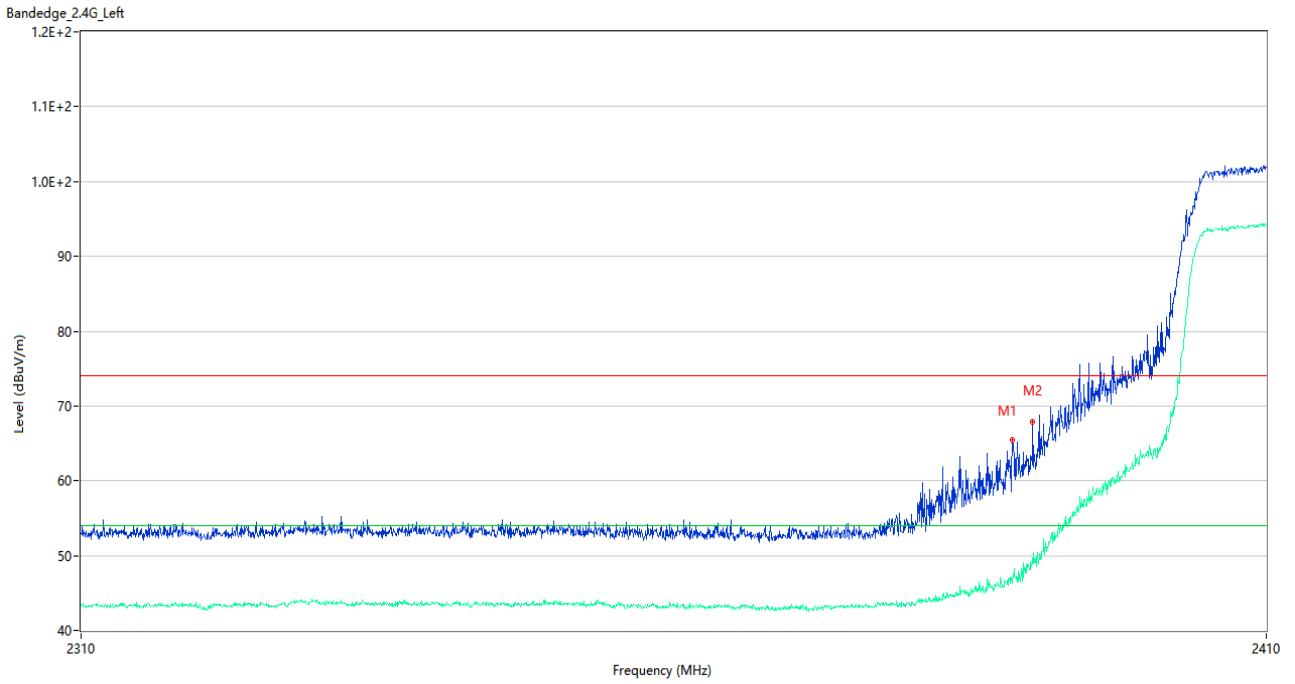

| No. | Frequency (MHz) | Results (dBuV/m) | Factor (dB) | Limit (dBuV/m) | Margin (dB) | Detector | Table (Degree) | Height (cm) | Antenna | Verdict |
|-----|-----------------|------------------|-------------|----------------|-------------|----------|----------------|-------------|------------|---------|
| 1 | 2388.200 | 65.43 | -1.77 | 74.0 | 8.57 | Peak | 55.00 | 150 | Horizontal | Pass |
| 1** | 2388.200 | 46.35 | -1.77 | 54.0 | 7.65 | AV | 55.00 | 150 | Horizontal | Pass |
| 2 | 2389.950 | 67.88 | -1.82 | 74.0 | 6.12 | Peak | 157.00 | 150 | Horizontal | Pass |
| 2** | 2389.950 | 48.93 | -1.82 | 54.0 | 5.07 | AV | 157.00 | 150 | Horizontal | Pass |

802.11g HIGH CHANNEL

Bandedge_2.4G_Right

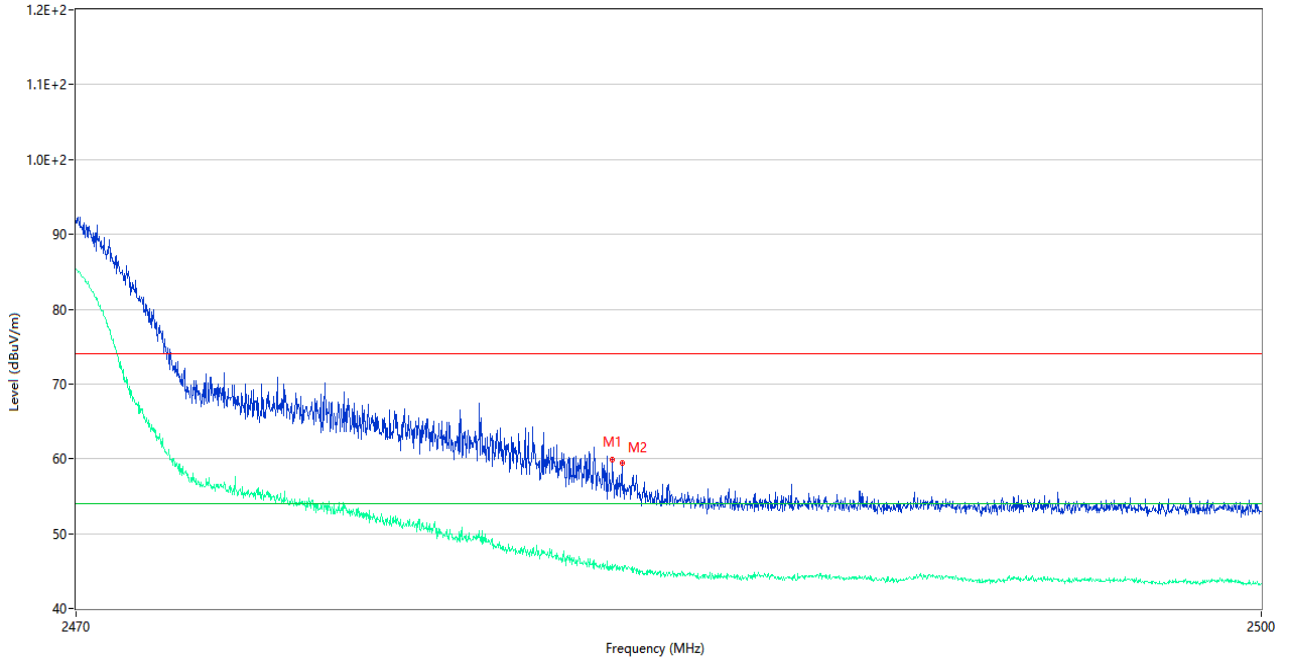

| No. | Frequency (MHz) | Results (dBuV/m) | Factor (dB) | Limit (dBuV/m) | Margin (dB) | Detector | Table (Degree) | Height (cm) | Antenna | Verdict |
|-----|-----------------|------------------|-------------|----------------|-------------|----------|----------------|-------------|------------|---------|
| 1 | 2483.530 | 59.90 | -1.10 | 74.0 | 14.10 | Peak | 147.00 | 100 | Horizontal | Pass |
| 1** | 2483.530 | 45.10 | -1.10 | 54.0 | 8.90 | AV | 147.00 | 100 | Horizontal | Pass |
| 2 | 2483.770 | 59.42 | -1.05 | 74.0 | 14.58 | Peak | 64.00 | 150 | Horizontal | Pass |
| 2** | 2483.770 | 45.59 | -1.05 | 54.0 | 8.41 | AV | 64.00 | 150 | Horizontal | Pass |

802.11n20 LOW CHANNEL

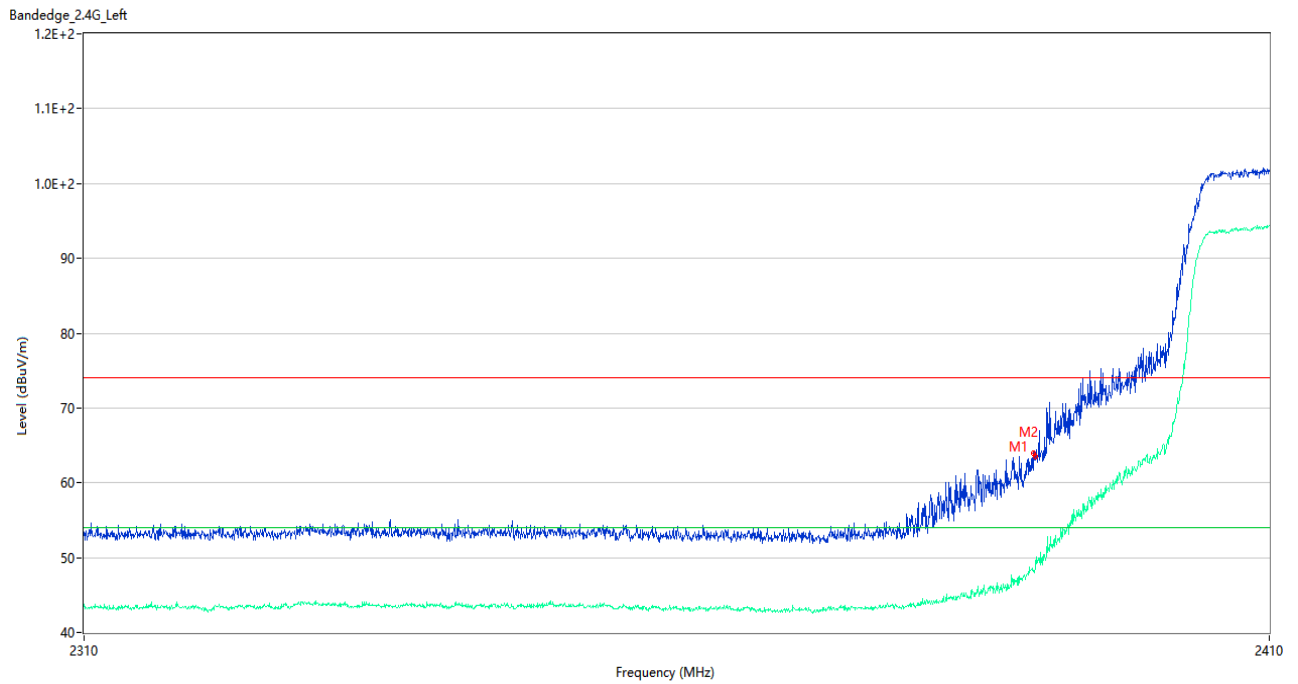

| No. | Frequency (MHz) | Results (dBuV/m) | Factor (dB) | Limit (dBuV/m) | Margin (dB) | Detector | Table (Degree) | Height (cm) | Antenna | Verdict |
|-----|-----------------|------------------|-------------|----------------|-------------|----------|----------------|-------------|------------|---------|
| 1 | 2389.750 | 63.88 | -1.77 | 74.0 | 10.12 | Peak | 130.00 | 200 | Horizontal | Pass |
| 1** | 2389.750 | 48.14 | -1.77 | 54.0 | 5.86 | AV | 130.00 | 200 | Horizontal | Pass |
| 2 | 2389.950 | 63.57 | -1.82 | 74.0 | 10.43 | Peak | 301.00 | 150 | Horizontal | Pass |
| 2** | 2389.950 | 49.15 | -1.82 | 54.0 | 4.85 | AV | 301.00 | 150 | Horizontal | Pass |

802.11n20 HIGH CHANNEL

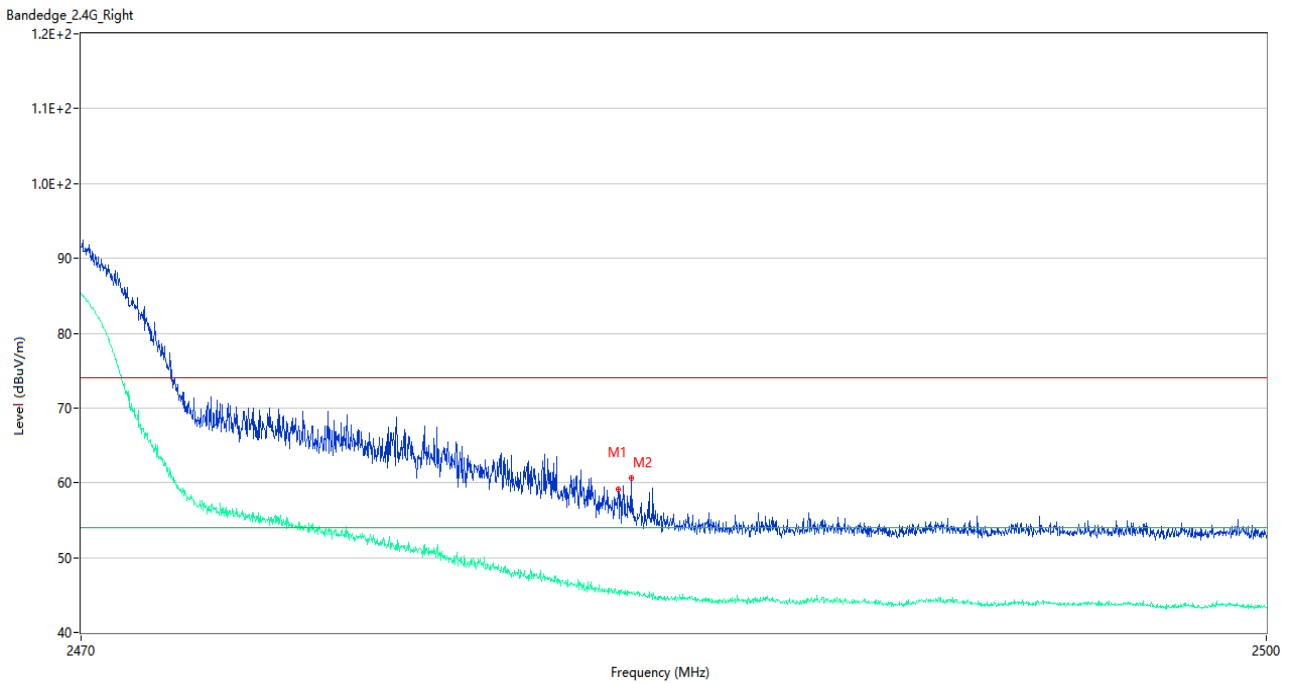

| No. | Frequency (MHz) | Results (dBuV/m) | Factor (dB) | Limit (dBuV/m) | Margin (dB) | Detector | Table (Degree) | Height (cm) | Antenna | Verdict |
|-----|-----------------|------------------|-------------|----------------|-------------|----------|----------------|-------------|------------|---------|
| 1 | 2483.560 | 59.09 | -1.09 | 74.0 | 14.91 | Peak | 130.00 | 150 | Horizontal | Pass |
| 1** | 2483.560 | 45.34 | -1.09 | 54.0 | 8.66 | AV | 130.00 | 150 | Horizontal | Pass |
| 2 | 2483.875 | 60.68 | -1.03 | 74.0 | 13.32 | Peak | 137.00 | 100 | Horizontal | Pass |
| 2** | 2483.875 | 45.48 | -1.03 | 54.0 | 8.52 | AV | 137.00 | 100 | Horizontal | Pass |

A.8 Power Spectral Density (PSD)

Test Data

802.11b Mode:

| Channel | Spectral power density (dBm/3kHz) | Limit (dBm/3kHz) |
|---------|--------------------------------------|------------------|
| Low | -7.87 | 8 |
| Middle | -7.79 | 8 |
| High | -8.30 | 8 |

802.11g Mode:

| Channel | Spectral power density (dBm/3kHz) | Limit (dBm/3kHz) |
|---------|--------------------------------------|------------------|
| Low | -9.54 | 8 |
| Middle | -10.32 | 8 |
| High | -10.18 | 8 |

802.11n-20 MHz Mode:

| Channel | Spectral power density (dBm/3kHz) | Limit (dBm/3kHz) |
|---------|--------------------------------------|------------------|
| Low | -9.36 | 8 |
| Middle | -11.10 | 8 |
| High | -8.77 | 8 |

Test Plots

802.11b LOW CHANNEL



802.11b MIDDLE CHANNEL



802.11b HIGH CHANNEL



802.11g LOW CHANNEL

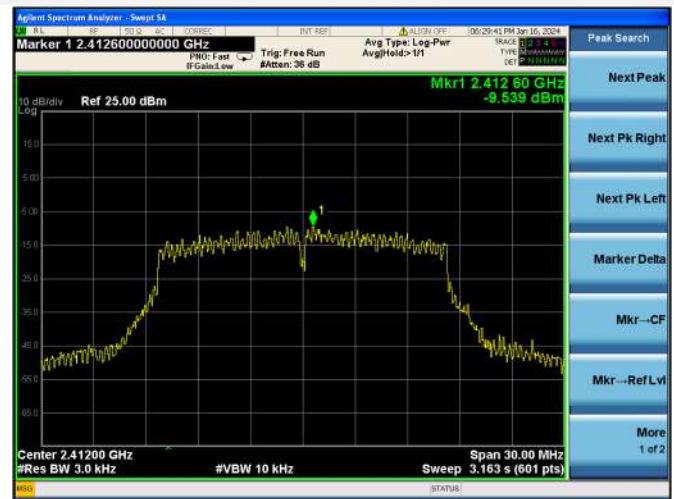

802.11g MIDDLE CHANNEL



802.11g HIGH CHANNEL



802.11n-20 MHz LOW CHANNEL



802.11n-20 MHz MIDDLE CHANNEL



802.11n-20 MHz HIGH CHANNEL



ANNEX B TEST SETUP PHOTOS

Please refer the document “BL-SZ23C0902-AR.PDF”.

ANNEX C EUT EXTERNAL PHOTOS

Please refer the document “BL-SZ23C0902-AW.PDF”.

ANNEX D EUT INTERNAL PHOTOS

Please refer the document “BL-SZ23C0902-AI.PDF”.

Statement

1. The laboratory guarantees the scientificity, accuracy and impartiality of the test, and is responsible for all the information in the report, except the information provided by the customer. The customer is responsible for the impact of the information provided on the validity of the results.
2. The report without China inspection body and laboratory Mandatory Approval (CMA) mark has no effect of proving to the society.
3. For the report with CNAS mark or A2LA mark, the items marked with "☆" are not within the accredited scope.
4. This report is invalid if it is altered, without the signature of the testing and approval personnel, or without the "inspection and testing dedicated stamp" or test report stamp.
5. The test data and results are only valid for the tested samples provided by the customer.
6. This report shall not be partially reproduced without the written permission of the laboratory.
7. Any objection shall be raised to the laboratory within 30 days after receiving the report.

--END OF REPORT--