

FCC SAR Test Report

APPLICANT : Shenzhen Tinno Mobile
Technology Corp.
EQUIPMENT : Smartphone
BRAND NAME : TINNO
MODEL NAME : U705AA, U705AC
FCC ID : XD6U705AA
STANDARD : FCC 47 CFR Part 2 (2.1093)
ANSI/IEEE C95.1-1992
IEEE 1528-2013

The product was received on Feb. 21, 2020 and testing was started from Mar. 28, 2020 and completed on Apr. 23, 2020. We, Sporton International (ShenZhen) Inc, would like to declare that the tested sample has been evaluated in accordance with the procedures and had been in compliance with the applicable technical standards.

The test results in this report apply exclusively to the tested model / sample. Without written approval of Sporton International (ShenZhen) Inc., the test report shall not be reproduced except in full.

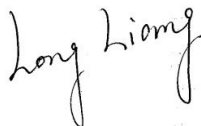

Reviewed by: Long Liang / Supervisor



Approved by: Johnny Chen / Manager



Sporton International (ShenZhen) Inc.

**1/F, 2/F, Bldg 5, Shiling Industrial Zone, Xinwei Village, Xili, Nanshan, Shenzhen, 518055
People's Republic of China**



Table of Contents

1. Statement of Compliance 4
2. Administration Data 5
3. Guidance Applied 5
4. Equipment Under Test (EUT) Information 6
4.1 General Information 6
4.2 General LTE SAR Test and Reporting Considerations 8
5. RF Exposure Limits 10
5.1 Uncontrolled Environment 10
5.2 Controlled Environment 10
6. Specific Absorption Rate (SAR) 11
6.1 Introduction 11
6.2 SAR Definition 11
7. System Description and Setup 12
7.1 E-Field Probe 13
7.2 Data Acquisition Electronics (DAE) 13
7.3 Phantom 14
7.4 Device Holder 15
8. Measurement Procedures 16
8.1 Spatial Peak SAR Evaluation 16
8.2 Power Reference Measurement 17
8.3 Area Scan 17
8.4 Zoom Scan 18
8.5 Volume Scan Procedures 18
8.6 Power Drift Monitoring 18
9. Test Equipment List 19
10. System Verification 20
10.1 Tissue Simulating Liquids 20
10.2 Tissue Verification 21
10.3 System Performance Check Results 22
11. RF Exposure Positions 23
11.1 Ear and handset reference point 23
11.2 Definition of the cheek position 24
11.3 Definition of the tilt position 25
11.4 Body Worn Accessory 26
11.5 Product Specific 10g SAR Exposure 27
11.6 Wireless Router 27
12. Conducted RF Output Power (Unit: dBm) 28
13. Antenna Location 39
14. SAR Test Results 41
14.1 Head SAR 43
14.2 Hotspot SAR 46
14.3 Body Worn Accessory SAR 50
14.4 Product specific 10g SAR 53
14.5 Repeated SAR Measurement 55
15. Simultaneous Transmission Analysis 56
15.1 Head Exposure Conditions 57
15.2 Hotspot Exposure Conditions 58
15.3 Body-Worn Accessory Exposure Conditions 60
15.4 Product specific 10g SAR Exposure Conditions 61
15.5 SPLSR Evaluation and Analysis 62
16. Uncertainty Assessment 70
17. References 71
Appendix A. Plots of System Performance Check
Appendix B. Plots of High SAR Measurement
Appendix C. DASy Calibration Certificate
Appendix D. Test Setup Photos
Appendix E. Conducted RF Output Power Table



Revision History

REPORT NO.	VERSION	DESCRIPTION	ISSUED DATE
FA022101	Rev. 01	Initial issue of report	May 08, 2020



1. Statement of Compliance

The maximum results of Specific Absorption Rate (SAR) found during testing for **Shenzhen Tinno Mobile Technology Corp., Smartphone, U705AA, U705AC**, are as follows.

Highest 1g SAR Summary						
Equipment Class	Frequency Band		Head (Separation 0mm)	Hotspot (Separation 10mm)	Body-worn (Separation 15mm)	Highest Simultaneous Transmission 1g SAR (W/kg)
			1g SAR (W/kg)			
Licensed	GSM	GSM850	0.52	0.67	0.37	1.59
		GSM1900	<0.10	1.09	1.13	
	WCDMA	Band V	0.66	0.43	0.24	
		Band IV	0.18	1.06	1.05	
		Band II	<0.10	1.30	0.94	
	LTE	Band 12	0.34	0.37	0.40	
		Band 14	0.28	0.53	0.29	
		Band 5	0.85	0.72	0.43	
		Band 4	0.26	1.04	1.17	
		Band 66	0.27	1.35	1.15	
		Band 2	0.11	1.37	1.19	
Band 30		0.30	0.99	0.50		
DTS	WLAN	2.4GHz WLAN	0.77	0.30	0.13	1.56
NII		5GHz WLAN	0.76	0.67	0.39	1.59
DSS	Bluetooth	2.4GHz Bluetooth	<0.10	<0.10	<0.10	1.59
Highest 10g SAR Summary						
Equipment Class	Frequency Band		Product Specific 10g SAR (W/kg) (Separation 0mm)		Highest Simultaneous Transmission 10g SAR (W/kg)	
Licensed	GSM	GSM1900	2.44		3.97	
	WCDMA	Band IV	2.27			
		Band II	2.51			
	LTE	Band 4	2.78			
		Band 66	2.58			
		Band 2	3.29			
NII	WLAN	5GHz WLAN	1.46		3.97	
Date of Testing:			2020/3/28~2020/4/23			

Declaration of Conformity:
The test results with all measurement uncertainty excluded are presented in accordance with the regulation limits or requirements declared by manufacturers.
Comments and Explanations:
The declared of product specification for EUT presented in the report are provided by the manufacturer, and the manufacturer takes all the responsibilities for the accuracy of product specification.

This device is in compliance with Specific Absorption Rate (SAR) for general population/uncontrolled exposure limits (1.6 W/kg for Partial-Body 1g SAR, 4.0 W/kg for Product Specific 10g SAR) specified in FCC 47 CFR part 2 (2.1093) and ANSI/IEEE C95.1-1992, and had been tested in accordance with the measurement methods and procedures specified in IEEE 1528-2013 and FCC KDB publications.



2. Administration Data

Sporton International (Shenzhen) Inc. is accredited to ISO/IEC 17025:2017 by American Association for Laboratory Accreditation with Certificate Number 5145.01.

Testing Laboratory		
Test Firm	Sporton International (Shenzhen) Inc.	
Test Site Location	1/F, 2/F, Bldg 5, Shiling Industrial Zone, Xinwei Village, Xili, Nanshan, Shenzhen, 518055 People's Republic of China TEL: +86-755-86379589 FAX: +86-755-86379595	
Test Site No.	FCC Designation No.	FCC Test Firm Registration No.
	CN1256	421272

Applicant	
Company Name	Shenzhen Tinno Mobile Technology Corp.
Address	4/F,H-3 Building,OCT Eastern Industrial Park. NO.1 XiangShan East Road,Nan Shan District,Shenzhen,P.R.China.

Manufacturer	
Company Name	Shenzhen Tinno Mobile Technology Corp.
Address	4/F,H-3 Building,OCT Eastern Industrial Park. NO.1 XiangShan East Road,Nan Shan District,Shenzhen,P.R.China.

3. Guidance Applied

The Specific Absorption Rate (SAR) testing specification, method, and procedure for this device is in accordance with the following standards:

- FCC 47 CFR Part 2 (2.1093)
- ANSI/IEEE C95.1-1992
- IEEE 1528-2013
- FCC KDB 865664 D01 SAR Measurement 100 MHz to 6 GHz v01r04
- FCC KDB 865664 D02 SAR Reporting v01r02
- FCC KDB 447498 D01 General RF Exposure Guidance v06
- FCC KDB 648474 D04 SAR Evaluation Considerations for Wireless Handsets v01r03
- FCC KDB 248227 D01 802.11 Wi-Fi SAR v02r02
- FCC KDB 941225 D01 3G SAR Procedures v03r01
- FCC KDB 941225 D05 SAR for LTE Devices v02r05
- FCC KDB 941225 D05A Rel.10 LTE SAR Test Guidance v01r02
- FCC KDB 941225 D06 Hotspot Mode SAR v02r01

4. Equipment Under Test (EUT) Information

4.1 General Information

Product Feature & Specification	
Equipment Name	Smartphone
Brand Name	TINNO
Model Name	U705AA, U705AC
FCC ID	XD6U705AA
IMEI Code	865638040005432
Wireless Technology and Frequency Range	GSM850: 824.2 MHz ~ 848.8 MHz GSM1900: 1850.2 MHz ~ 1909.8 MHz WCDMA Band II: 1852.4 MHz ~ 1907.6 MHz WCDMA Band IV: 1712.4 MHz ~ 1752.6 MHz WCDMA Band V: 826.4 MHz ~ 846.6 MHz LTE Band 2: 1850.7 MHz ~ 1909.3 MHz LTE Band 4: 1710.7 MHz ~ 1754.3 MHz LTE Band 5: 824.7 MHz ~ 848.3 MHz LTE Band 12: 699.7 MHz ~ 715.3 MHz LTE Band 14: 790.5 MHz ~ 795.5 MHz LTE Band 30: 2307.5 MHz ~ 2312.5 MHz LTE Band 66: 1710.7 MHz ~ 1779.3 MHz WLAN 2.4GHz Band: 2412 MHz ~ 2462 MHz WLAN 5.2GHz Band: 5180 MHz ~ 5240 MHz WLAN 5.3GHz Band: 5260 MHz ~ 5320 MHz WLAN 5.5GHz Band: 5500 MHz ~ 5700 MHz WLAN 5.8GHz Band: 5745 MHz ~ 5825 MHz Bluetooth: 2402 MHz ~ 2480 MHz NFC : 13.56 MHz
Mode	GSM/GPRS/EGPRS RMC/AMR 12.2Kbps HSDPA HSUPA DC-HSDPA HSPA+(16QAM uplink) LTE: QPSK, 16QAM, 64QAM WLAN 2.4GHz 802.11b/g/n HT20 WLAN 5GHz 802.11a/n HT20/HT40 WLAN 5GHz 802.11ac VHT20/VHT40/VHT80 Bluetooth BR/EDR/LE NFC:ASK
HW Version	V1.0
SW Version	U705AA SW: U705AAV01.16.11 U705AC SW: U705ACV01.43.01
GSM / (E)GPRS Transfer mode	Class B – EUT cannot support Packet Switched and Circuit Switched Network simultaneously but can automatically switch between Packet and Circuit Switched Network.
EUT Stage	Identical Prototype
Remark: 1. WLAN operation in 5600 MHz ~ 5650 MHz is notched. 2. 802.11n-HT40 is not supported in 2.4GHz WLAN. 3. This device supports VoIP in GPRS, EGPRS, WCDMA and LTE (e.g. for 3rd-party VoIP), LTE supports VoLTE operation. 4. This device 2.4GHz WLAN support hotspot operation and Bluetooth support tethering applications. 5. This device 2.4GHz WLAN/5.2GHz WLAN/5.8GHz WLAN support hotspot operation, and 5.2GHz WLAN/5.8GHz WLAN supports WiFi Direct (GC/GO), and 5.3GHz / 5.5GHz supports WiFi Direct (GC only). 6. This device does not support DTM operation and supports GRPS/EGRPS mode up to multi-slot class 12. 7. When the phone is in talking mode and receiver worked, then power reduction will be implemented immediately at WCDMA band V, LTE band 5 and WLAN5.2GHz/5.3GHz/5.5GHz/5.8GHz for head SAR. 8. When receiver not worked, then power reduction will be implemented immediately at GSM1900, WCDMA band II/IV, LTE band 2/4/66 for body-worn and product specific 10g SAR.	



9. When hotspot mode is enabled, power reduction will be activated to limit the maximum power of GSM1900, WCDMA band II/IV, LTE band 2/4/66 for hotspot SAR.
10. This device has two WWAN transmit antennas. WWAN bottom antenna is located at the bottom edge of the device, and WWAN top antenna is located at the top edge of the device which can refer to antenna location chapter. WWAN top antenna frequency bands include WCDMA Band V and LTE Band 5, WWAN bottom antenna frequency band include GSM850/1900, WCDMA Band II/IV and LTE Band 2/4/12/14/30/66.
11. There are two types of EUT sample 1(Model Name: U705AA) and sample 2(Model Name: U705AC), the change note could be referred to the product equality declaration which is exhibit separately. According to the difference, we chose the sample 1 to perform all tests.



4.2 General LTE SAR Test and Reporting Considerations

Summarized necessary items addressed in KDB 941225 D05 v02r05																																																															
FCC ID	XD6U705AA																																																														
Equipment Name	Smartphone																																																														
Operating Frequency Range of each LTE transmission band	LTE Band 2: 1850.7 MHz ~ 1909.3 MHz LTE Band 4: 1710.7 MHz ~ 1754.3 MHz LTE Band 5: 824.7 MHz ~ 848.3 MHz LTE Band 12: 699.7 MHz ~ 715.3 MHz LTE Band 14: 790.5 MHz ~ 795.5 MHz LTE Band 30: 2307.5 MHz ~ 2312.5 MHz LTE Band 66: 1710.7 MHz ~ 1779.3 MHz																																																														
Channel Bandwidth	LTE Band 2: 1.4MHz, 3MHz, 5MHz, 10MHz, 15MHz, 20MHz LTE Band 4: 1.4MHz, 3MHz, 5MHz, 10MHz, 15MHz, 20MHz LTE Band 5: 1.4MHz, 3MHz, 5MHz, 10MHz LTE Band 12: 1.4MHz, 3MHz, 5MHz, 10MHz LTE Band 14: 5MHz, 10MHz LTE Band 30: 5MHz, 10MHz LTE Band 66: 1.4MHz, 3MHz, 5MHz, 10MHz, 15MHz, 20MHz																																																														
uplink modulations used	QPSK / 16QAM / 64QAM																																																														
LTE Voice / Data requirements	Voice and Data																																																														
LTE Release Version	R11, Cat4																																																														
CA Support	Supported, Downlink Only																																																														
LTE MPR permanently built-in by design	<p>Table 6.2.3-1: Maximum Power Reduction (MPR) for Power Class 1, 2 and 3</p> <table border="1"> <thead> <tr> <th rowspan="2">Modulation</th> <th colspan="6">Channel bandwidth / Transmission bandwidth (N_{RB})</th> <th rowspan="2">MPR (dB)</th> </tr> <tr> <th>1.4 MHz</th> <th>3.0 MHz</th> <th>5 MHz</th> <th>10 MHz</th> <th>15 MHz</th> <th>20 MHz</th> </tr> </thead> <tbody> <tr> <td>QPSK</td> <td>> 5</td> <td>> 4</td> <td>> 8</td> <td>> 12</td> <td>> 16</td> <td>> 18</td> <td>≤ 1</td> </tr> <tr> <td>16 QAM</td> <td>≤ 5</td> <td>≤ 4</td> <td>≤ 8</td> <td>≤ 12</td> <td>≤ 16</td> <td>≤ 18</td> <td>≤ 1</td> </tr> <tr> <td>16 QAM</td> <td>> 5</td> <td>> 4</td> <td>> 8</td> <td>> 12</td> <td>> 16</td> <td>> 18</td> <td>≤ 2</td> </tr> <tr> <td>64 QAM</td> <td>≤ 5</td> <td>≤ 4</td> <td>≤ 8</td> <td>≤ 12</td> <td>≤ 16</td> <td>≤ 18</td> <td>≤ 2</td> </tr> <tr> <td>64 QAM</td> <td>> 5</td> <td>> 4</td> <td>> 8</td> <td>> 12</td> <td>> 16</td> <td>> 18</td> <td>≤ 3</td> </tr> <tr> <td>256 QAM</td> <td colspan="6">≥ 1</td> <td>≤ 5</td> </tr> </tbody> </table>	Modulation	Channel bandwidth / Transmission bandwidth (N _{RB})						MPR (dB)	1.4 MHz	3.0 MHz	5 MHz	10 MHz	15 MHz	20 MHz	QPSK	> 5	> 4	> 8	> 12	> 16	> 18	≤ 1	16 QAM	≤ 5	≤ 4	≤ 8	≤ 12	≤ 16	≤ 18	≤ 1	16 QAM	> 5	> 4	> 8	> 12	> 16	> 18	≤ 2	64 QAM	≤ 5	≤ 4	≤ 8	≤ 12	≤ 16	≤ 18	≤ 2	64 QAM	> 5	> 4	> 8	> 12	> 16	> 18	≤ 3	256 QAM	≥ 1						≤ 5
Modulation	Channel bandwidth / Transmission bandwidth (N _{RB})						MPR (dB)																																																								
	1.4 MHz	3.0 MHz	5 MHz	10 MHz	15 MHz	20 MHz																																																									
QPSK	> 5	> 4	> 8	> 12	> 16	> 18	≤ 1																																																								
16 QAM	≤ 5	≤ 4	≤ 8	≤ 12	≤ 16	≤ 18	≤ 1																																																								
16 QAM	> 5	> 4	> 8	> 12	> 16	> 18	≤ 2																																																								
64 QAM	≤ 5	≤ 4	≤ 8	≤ 12	≤ 16	≤ 18	≤ 2																																																								
64 QAM	> 5	> 4	> 8	> 12	> 16	> 18	≤ 3																																																								
256 QAM	≥ 1						≤ 5																																																								
LTE A-MPR	In the base station simulator configuration, Network Setting value is set to NS_01 to disable A-MPR during SAR testing and the LTE SAR tests was transmitting on all TTI frames (Maximum TTI)																																																														
Spectrum plots for RB configuration	A properly configured base station simulator was used for the SAR and power measurement; therefore, spectrum plots for each RB allocation and offset configuration are not included in the SAR report.																																																														
Power reduction applied to satisfy SAR compliance	Yes 1. When the phone is in talking mode and receiver worked, then power reduction will be implemented immediately at LTE band 5 for head SAR. 2. When receiver not worked, then power reduction will be implemented immediately at LTE band 2/4/66 for body-worn and product specific 10g SAR. 3. When hotspot mode is enabled, power reduction will be activated to limit the maximum power of LTE band 2/4/66 for hotspot SAR.																																																														
LTE Carrier Aggregation Combinations	Inter-Band possible combinations and the detail power verification please referred to section 12.																																																														
LTE Carrier Aggregation Additional Information	This device supports maximum of 2 carriers in the downlink. Additional following LTE Release features are not supported: Relay, HetNet, Enhanced MIMO, eICI, WiFi Offloading, MDH, eMBMA, Cross-Carrier Scheduling, Enhanced SC-FDMA.																																																														



Transmission (H, M, L) channel numbers and frequencies in each LTE band												
LTE Band 2												
	Bandwidth 1.4 MHz		Bandwidth 3 MHz		Bandwidth 5 MHz		Bandwidth 10 MHz		Bandwidth 15 MHz		Bandwidth 20 MHz	
	Ch. #	Freq. (MHz)	Ch. #	Freq. (MHz)	Ch. #	Freq. (MHz)	Ch. #	Freq. (MHz)	Ch. #	Freq. (MHz)	Ch. #	Freq. (MHz)
L	18607	1850.7	18615	1851.5	18625	1852.5	18650	1855	18675	1857.5	18700	1860
M	18900	1880	18900	1880	18900	1880	18900	1880	18900	1880	18900	1880
H	19193	1909.3	19185	1908.5	19175	1907.5	19150	1905	19125	1902.5	19100	1900
LTE Band 4												
	Bandwidth 1.4 MHz		Bandwidth 3 MHz		Bandwidth 5 MHz		Bandwidth 10 MHz		Bandwidth 15 MHz		Bandwidth 20 MHz	
	Ch. #	Freq. (MHz)	Ch. #	Freq. (MHz)	Ch. #	Freq. (MHz)	Ch. #	Freq. (MHz)	Ch. #	Freq. (MHz)	Ch. #	Freq. (MHz)
L	19957	1710.7	19965	1711.5	19975	1712.5	20000	1715	20025	1717.5	20050	1720
M	20175	1732.5	20175	1732.5	20175	1732.5	20175	1732.5	20175	1732.5	20175	1732.5
H	20393	1754.3	20385	1753.5	20375	1752.5	20350	1750	20325	1747.5	20300	1745
LTE Band 5												
	Bandwidth 1.4 MHz		Bandwidth 3 MHz		Bandwidth 5 MHz		Bandwidth 10 MHz		Bandwidth 15 MHz		Bandwidth 20 MHz	
	Ch. #	Freq. (MHz)	Ch. #	Freq. (MHz)	Ch. #	Freq. (MHz)	Ch. #	Freq. (MHz)	Ch. #	Freq. (MHz)	Ch. #	Freq. (MHz)
L	20407	824.7	20415	825.5	20425	826.5	20450	829	20450	829	20450	829
M	20525	836.5	20525	836.5	20525	836.5	20525	836.5	20525	836.5	20525	836.5
H	20643	848.3	20635	847.5	20625	846.5	20600	844	20600	844	20600	844
LTE Band 12												
	Bandwidth 1.4 MHz		Bandwidth 3 MHz		Bandwidth 5 MHz		Bandwidth 10 MHz		Bandwidth 15 MHz		Bandwidth 20 MHz	
	Ch. #	Freq. (MHz)	Ch. #	Freq. (MHz)	Ch. #	Freq. (MHz)	Ch. #	Freq. (MHz)	Ch. #	Freq. (MHz)	Ch. #	Freq. (MHz)
L	23017	699.7	23025	700.5	23035	701.5	23060	704	23060	704	23060	704
M	23095	707.5	23095	707.5	23095	707.5	23095	707.5	23095	707.5	23095	707.5
H	23173	715.3	23165	714.5	23155	713.5	23130	711	23130	711	23130	711
LTE Band 14												
	Bandwidth 5 MHz				Bandwidth 10 MHz				Bandwidth 15 MHz			
	Channel #		Channel #		Channel #		Channel #		Channel #		Channel #	
L	23305		790.5		23330		793		23355		795.5	
M	23330		793		23330		793		23355		795.5	
H	23355		795.5		23330		793		23355		795.5	
LTE Band 30												
	Bandwidth 5 MHz				Bandwidth 10 MHz				Bandwidth 15 MHz			
	Channel #		Freq.(MHz)		Channel #		Channel #		Channel #		Channel #	
L	27685		2307.5		27710		2310		27735		2312.5	
M	27710		2310		27710		2310		27735		2312.5	
H	27735		2312.5		27710		2310		27735		2312.5	
LTE Band 66												
	Bandwidth 1.4 MHz		Bandwidth 3 MHz		Bandwidth 5 MHz		Bandwidth 10 MHz		Bandwidth 15 MHz		Bandwidth 20 MHz	
	Ch. #	Freq. (MHz)	Ch. #	Freq. (MHz)	Ch. #	Freq. (MHz)	Ch. #	Freq. (MHz)	Ch. #	Freq. (MHz)	Ch. #	Freq. (MHz)
L	131979	1710.7	131987	1711.5	131997	1712.5	132022	1715	132047	1717.5	132072	1720
M	132322	1745	132322	1745	132322	1745	132322	1745	132322	1745	132322	1745
H	132665	1779.3	132657	1778.5	132647	1777.5	132622	1775	132597	1772.5	132572	1770

5. RF Exposure Limits

5.1 Uncontrolled Environment

Uncontrolled Environments are defined as locations where there is the exposure of individuals who have no knowledge or control of their exposure. The general population/uncontrolled exposure limits are applicable to situations in which the general public may be exposed or in which persons who are exposed as a consequence of their employment may not be made fully aware of the potential for exposure or cannot exercise control over their exposure. Members of the general public would come under this category when exposure is not employment-related; for example, in the case of a wireless transmitter that exposes persons in its vicinity.

5.2 Controlled Environment

Controlled Environments are defined as locations where there is exposure that may be incurred by persons who are aware of the potential for exposure, (i.e. as a result of employment or occupation). In general, occupational/controlled exposure limits are applicable to situations in which persons are exposed as a consequence of their employment, who have been made fully aware of the potential for exposure and can exercise control over their exposure. The exposure category is also applicable when the exposure is of a transient nature due to incidental passage through a location where the exposure levels may be higher than the general population/uncontrolled limits, but the exposed person is fully aware of the potential for exposure and can exercise control over his or her exposure by leaving the area or by some other appropriate means.

Limits for Occupational/Controlled Exposure (W/kg)

Whole-Body	Partial-Body	Hands, Wrists, Feet and Ankles
0.4	8.0	20.0

Limits for General Population/Uncontrolled Exposure (W/kg)

Whole-Body	Partial-Body	Hands, Wrists, Feet and Ankles
0.08	1.6	4.0

Whole-Body SAR is averaged over the entire body, partial-body SAR is averaged over any 1gram of tissue defined as a tissue volume in the shape of a cube. SAR for hands, wrists, feet and ankles is averaged over any 10 grams of tissue defined as a tissue volume in the shape of a cube.

6. Specific Absorption Rate (SAR)

6.1 Introduction

SAR is related to the rate at which energy is absorbed per unit mass in an object exposed to a radio field. The SAR distribution in a biological body is complicated and is usually carried out by experimental techniques or numerical modeling. The standard recommends limits for two tiers of groups, occupational/controlled and general population/uncontrolled, based on a person's awareness and ability to exercise control over his or her exposure. In general, occupational/controlled exposure limits are higher than the limits for general population/uncontrolled.

6.2 SAR Definition

The SAR definition is the time derivative (rate) of the incremental energy (dW) absorbed by (dissipated in) an incremental mass (dm) contained in a volume element (dv) of a given density (ρ). The equation description is as below:

$$\text{SAR} = \frac{d}{dt} \left(\frac{dW}{dm} \right) = \frac{d}{dt} \left(\frac{dW}{\rho dv} \right)$$

SAR is expressed in units of Watts per kilogram (W/kg)

$$\text{SAR} = \frac{\sigma |E|^2}{\rho}$$

Where: σ is the conductivity of the tissue, ρ is the mass density of the tissue and E is the RMS electrical field strength.

7. System Description and Setup

The DASY system used for performing compliance tests consists of the following items:

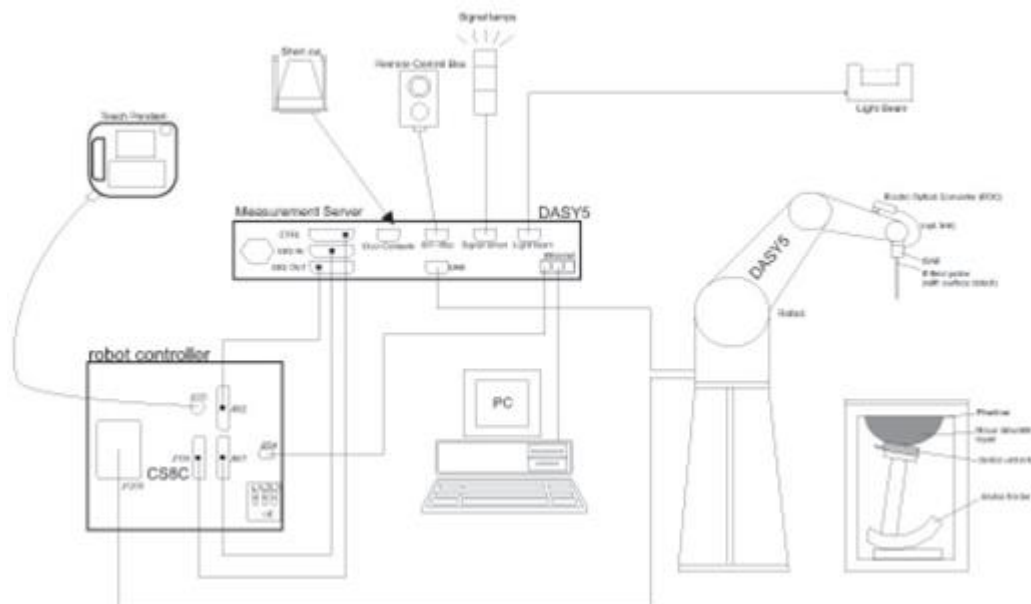

- A standard high precision 6-axis robot with controller, teach pendant and software. An arm extension for accommodating the data acquisition electronics (DAE).
- An isotropic Field probe optimized and calibrated for the targeted measurement.
- A data acquisition electronics (DAE) which performs the signal amplification, signal multiplexing, AD-conversion, offset measurements, mechanical surface detection, collision detection, etc. The unit is battery powered with standard or rechargeable batteries. The signal is optically transmitted to the EOC.
- The Electro-optical converter (EOC) performs the conversion from optical to electrical signals for the digital communication to the DAE. To use optical surface detection, a special version of the EOC is required. The EOC signal is transmitted to the measurement server.
- The function of the measurement server is to perform the time critical tasks such as signal filtering, control of the robot operation and fast movement interrupts.
- The Light Beam used is for probe alignment. This improves the (absolute) accuracy of the probe positioning.
- A computer running WinXP or Win7 and the DASY5 software.
- Remote control and teach pendant as well as additional circuitry for robot safety such as warning lamps, etc.
- The phantom, the device holder and other accessories according to the targeted measurement.

7.1 E-Field Probe

The SAR measurement is conducted with the dosimetric probe (manufactured by SPEAG).The probe is specially designed and calibrated for use in liquid with high permittivity. The dosimetric probe has special calibration in liquid at different frequency. This probe has a built in optical surface detection system to prevent from collision with phantom.

<EX3DV4 Probe>

Construction	Symmetric design with triangular core Built-in shielding against static charges PEEK enclosure material (resistant to organic solvents, e.g., DGBE)	
Frequency	10 MHz – >6 GHz Linearity: ±0.2 dB (30 MHz – 6 GHz)	
Directivity	±0.3 dB in TSL (rotation around probe axis) ±0.5 dB in TSL (rotation normal to probe axis)	
Dynamic Range	10 µW/g – >100 mW/g Linearity: ±0.2 dB (noise: typically <1 µW/g)	
Dimensions	Overall length: 337 mm (tip: 20 mm) Tip diameter: 2.5 mm (body: 12 mm) Typical distance from probe tip to dipole centers: 1 mm	

7.2 Data Acquisition Electronics (DAE)

The data acquisition electronics (DAE) consists of a highly sensitive electrometer-grade preamplifier with auto-zeroing, a channel and gain-switching multiplexer, a fast 16 bit AD-converter and a command decoder and control logic unit. Transmission to the measurement server is accomplished through an optical downlink for data and status information as well as an optical uplink for commands and the clock.

The input impedance of the DAE is 200 MOhm; the inputs are symmetrical and floating. Common mode rejection is above 80 dB.



Photo of DAE

7.3 Phantom

<SAM Twin Phantom>

Shell Thickness	2 ± 0.2 mm; Center ear point: 6 ± 0.2 mm	
Filling Volume	Approx. 25 liters	
Dimensions	Length: 1000 mm; Width: 500 mm; Height: adjustable feet	
Measurement Areas	Left Hand, Right Hand, Flat Phantom	

The bottom plate contains three pair of bolts for locking the device holder. The device holder positions are adjusted to the standard measurement positions in the three sections. A white cover is provided to tap the phantom during off-periods to prevent water evaporation and changes in the liquid parameters. On the phantom top, three reference markers are provided to identify the phantom position with respect to the robot.

<ELI Phantom>

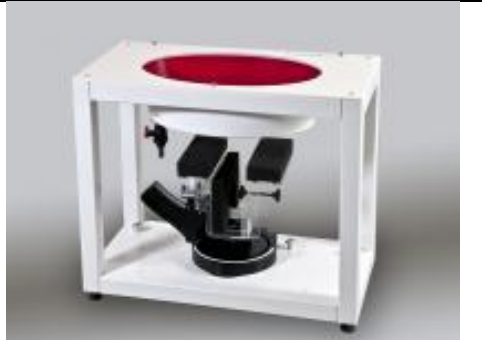
Shell Thickness	2 ± 0.2 mm (sagging: <1%)	
Filling Volume	Approx. 30 liters	
Dimensions	Major ellipse axis: 600 mm Minor axis: 400 mm	

The ELI phantom is intended for compliance testing of handheld and body-mounted wireless devices in the frequency range of 30 MHz to 6 GHz. ELI4 is fully compatible with standard and all known tissue simulating liquids.

7.4 Device Holder

<Mounting Device for Hand-Held Transmitter>

In combination with the Twin SAM V5.0/V5.0c or ELI phantoms, the Mounting Device for Hand-Held Transmitters enables rotation of the mounted transmitter device to specified spherical coordinates. At the heads, the rotation axis is at the ear opening. Transmitter devices can be easily and accurately positioned according to IEC 62209-1, IEEE 1528, FCC, or other specifications. The device holder can be locked for positioning at different phantom sections (left head, right head, flat). And upgrade kit to Mounting Device to enable easy mounting of wider devices like big smart-phones, e-books, small tablets, etc. It holds devices with width up to 140 mm.



Mounting Device for Hand-Held Transmitters



Mounting Device Adaptor for Wide-Phones

<Mounting Device for Laptops and other Body-Worn Transmitters>

The extension is lightweight and made of POM, acrylic glass and foam. It fits easily on the upper part of the mounting device in place of the phone positioned. The extension is fully compatible with the SAM Twin and ELI phantoms.



Mounting Device for Laptops

8. Measurement Procedures

The measurement procedures are as follows:

<Conducted power measurement>

- (a) For WWAN power measurement, use base station simulator to configure EUT WWAN transmission in conducted connection with RF cable, at maximum power in each supported wireless interface and frequency band.
- (b) Read the WWAN RF power level from the base station simulator.
- (c) For WLAN/BT power measurement, use engineering software to configure EUT WLAN/BT continuously transmission, at maximum RF power in each supported wireless interface and frequency band
- (d) Connect EUT RF port through RF cable to the power meter, and measure WLAN/BT output power

<SAR measurement>

- (a) Use base station simulator to configure EUT WWAN transmission in radiated connection, and engineering software to configure EUT WLAN/BT continuously transmission, at maximum RF power, in the highest power channel.
- (b) Place the EUT in the positions as Appendix D demonstrates.
- (c) Set scan area, grid size and other setting on the DASY software.
- (d) Measure SAR results for the highest power channel on each testing position.
- (e) Find out the largest SAR result on these testing positions of each band
- (f) Measure SAR results for other channels in worst SAR testing position if the reported SAR of highest power channel is larger than 0.8 W/kg

According to the test standard, the recommended procedure for assessing the peak spatial-average SAR value consists of the following steps:

- (a) Power reference measurement
- (b) Area scan
- (c) Zoom scan
- (d) Power drift measurement

8.1 Spatial Peak SAR Evaluation

The procedure for spatial peak SAR evaluation has been implemented according to the test standard. It can be conducted for 1g and 10g, as well as for user-specific masses. The DASY software includes all numerical procedures necessary to evaluate the spatial peak SAR value.

The base for the evaluation is a "cube" measurement. The measured volume must include the 1g and 10g cubes with the highest averaged SAR values. For that purpose, the center of the measured volume is aligned to the interpolated peak SAR value of a previously performed area scan.

The entire evaluation of the spatial peak values is performed within the post-processing engine (SEMCAD). The system always gives the maximum values for the 1g and 10g cubes. The algorithm to find the cube with highest averaged SAR is divided into the following stages:

- (a) Extraction of the measured data (grid and values) from the Zoom Scan
- (b) Calculation of the SAR value at every measurement point based on all stored data (A/D values and measurement parameters)
- (c) Generation of a high-resolution mesh within the measured volume
- (d) Interpolation of all measured values from the measurement grid to the high-resolution grid
- (e) Extrapolation of the entire 3-D field distribution to the phantom surface over the distance from sensor to surface
- (f) Calculation of the averaged SAR within masses of 1g and 10g

8.2 Power Reference Measurement

The Power Reference Measurement and Power Drift Measurements are for monitoring the power drift of the device under test in the batch process. The minimum distance of probe sensors to surface determines the closest measurement point to phantom surface. This distance cannot be smaller than the distance of sensor calibration points to probe tip as defined in the probe properties.

8.3 Area Scan

The area scan is used as a fast scan in two dimensions to find the area of high field values, before doing a fine measurement around the hot spot. The sophisticated interpolation routines implemented in DASY software can find the maximum found in the scanned area, within a range of the global maximum. The range (in dB0 is specified in the standards for compliance testing. For example, a 2 dB range is required in IEEE standard 1528 and IEC 62209 standards, whereby 3 dB is a requirement when compliance is assessed in accordance with the ARIB standard (Japan), if only one zoom scan follows the area scan, then only the absolute maximum will be taken as reference. For cases where multiple maximums are detected, the number of zoom scans has to be increased accordingly.

Area scan parameters extracted from FCC KDB 865664 D01v01r04 SAR measurement 100 MHz to 6 GHz.

	≤ 3 GHz	> 3 GHz
Maximum distance from closest measurement point (geometric center of probe sensors) to phantom surface	5 ± 1 mm	$\frac{1}{2} \cdot \delta \cdot \ln(2) \pm 0.5$ mm
Maximum probe angle from probe axis to phantom surface normal at the measurement location	$30^\circ \pm 1^\circ$	$20^\circ \pm 1^\circ$
Maximum area scan spatial resolution: $\Delta x_{Area}, \Delta y_{Area}$	≤ 2 GHz: ≤ 15 mm $2 - 3$ GHz: ≤ 12 mm	$3 - 4$ GHz: ≤ 12 mm $4 - 6$ GHz: ≤ 10 mm
	When the x or y dimension of the test device, in the measurement plane orientation, is smaller than the above, the measurement resolution must be \leq the corresponding x or y dimension of the test device with at least one measurement point on the test device.	

8.4 Zoom Scan

Zoom scans are used to assess the peak spatial SAR values within a cubic averaging volume containing 1 gram and 10 gram of simulated tissue. The zoom scan measures points (refer to table below) within a cube whose base faces are centered on the maxima found in a preceding area scan job within the same procedure. When the measurement is done, the zoom scan evaluates the averaged SAR for 1 gram and 10 gram and displays these values next to the job's label.

Zoom scan parameters extracted from FCC KDB 865664 D01v01r04 SAR measurement 100 MHz to 6 GHz.

		≤ 3 GHz	> 3 GHz	
Maximum zoom scan spatial resolution: Δx_{Zoom} , Δy_{Zoom}		≤ 2 GHz: ≤ 8 mm 2 – 3 GHz: ≤ 5 mm*	3 – 4 GHz: ≤ 5 mm* 4 – 6 GHz: ≤ 4 mm*	
Maximum zoom scan spatial resolution, normal to phantom surface	uniform grid: $\Delta z_{Zoom}(n)$	≤ 5 mm	3 – 4 GHz: ≤ 4 mm 4 – 5 GHz: ≤ 3 mm 5 – 6 GHz: ≤ 2 mm	
	graded grid	$\Delta z_{Zoom}(1)$: between 1 st two points closest to phantom surface	≤ 4 mm	3 – 4 GHz: ≤ 3 mm 4 – 5 GHz: ≤ 2.5 mm 5 – 6 GHz: ≤ 2 mm
		$\Delta z_{Zoom}(n>1)$: between subsequent points	$\leq 1.5 \cdot \Delta z_{Zoom}(n-1)$	
Minimum zoom scan volume	x, y, z	≥ 30 mm	3 – 4 GHz: ≥ 28 mm 4 – 5 GHz: ≥ 25 mm 5 – 6 GHz: ≥ 22 mm	
Note: δ is the penetration depth of a plane-wave at normal incidence to the tissue medium; see draft standard IEEE P1528-2011 for details. * When zoom scan is required and the <i>reported</i> SAR from the <i>area scan based 1-g SAR estimation</i> procedures of KDB 447498 is ≤ 1.4 W/kg, ≤ 8 mm, ≤ 7 mm and ≤ 5 mm zoom scan resolution may be applied, respectively, for 2 GHz to 3 GHz, 3 GHz to 4 GHz and 4 GHz to 6 GHz.				

8.5 Volume Scan Procedures

The volume scan is used to assess overlapping SAR distributions for antennas transmitting in different frequency bands. It is equivalent to an oversized zoom scan used in standalone measurements. The measurement volume will be used to enclose all the simultaneous transmitting antennas. For antennas transmitting simultaneously in different frequency bands, the volume scan is measured separately in each frequency band. In order to sum correctly to compute the 1g aggregate SAR, the EUT remain in the same test position for all measurements and all volume scan use the same spatial resolution and grid spacing. When all volume scan were completed, the software, SEMCAD postprocessor can combine and subsequently superpose these measurement data to calculating the multiband SAR.

8.6 Power Drift Monitoring

All SAR testing is under the EUT install full charged battery and transmit maximum output power. In DASy measurement software, the power reference measurement and power drift measurement procedures are used for monitoring the power drift of EUT during SAR test. Both these procedures measure the field at a specified reference position before and after the SAR testing. The software will calculate the field difference in dB. If the power drifts more than 5%, the SAR will be retested.



9. Test Equipment List

Manufacturer	Name of Equipment	Type/Model	Serial Number	Calibration	
				Last Cal.	Due Date
SPEAG	750MHz System Validation Kit	D750V3	1099	Dec. 06, 2018	Dec. 05, 2021
SPEAG	835MHz System Validation Kit	D835V2	4d162	Dec. 05, 2018	Dec. 04, 2021
SPEAG	1750MHz System Validation Kit	D1750V2	1090	Mar. 27, 2019	Mar. 26, 2022
SPEAG	1900MHz System Validation Kit	D1900V2	5d182	Dec. 07, 2018	Dec. 06, 2021
SPEAG	2300MHz System Validation Kit	D2300V2	1056	Nov. 01, 2018	Oct. 31, 2021
SPEAG	2450MHz System Validation Kit	D2450V2	924	Apr. 15, 2019	Apr. 14, 2020
SPEAG	5000MHz System Validation Kit	D5GHzV2	1167	Aug. 03, 2018	Aug. 02, 2021
SPEAG	Data Acquisition Electronics	DAE4	1386	Sep. 09, 2019	Sep. 08, 2020
SPEAG	Dosimetric E-Field Probe	EX3DV4	3753	Jun. 19, 2019	Jun. 18, 2020
SPEAG	SAM Twin Phantom	QD 000 P40 CD	TP-1671	NCR	NCR
SPEAG	Phone Positioner	N/A	N/A	NCR	NCR
Anritsu	Radio communication analyzer	MT8820C	6201300653	Jul. 22, 2019	Jul. 21, 2020
Anritsu	Radio communication analyzer	MT8821C	6201588572	Dec. 26, 2019	Dec. 25, 2020
Agilent	Wireless Communication Test Set	E5515C	MY50267224	Jul. 22, 2019	Jul. 21, 2020
Speag	Dielectric Assessment KIT	DAK-3.5	1071	Oct. 28, 2019	Oct. 27, 2020
Agilent	Signal Generator	N5181A	MY50145381	Dec. 26, 2019	Dec. 25, 2020
Anritsu	Power Sensor	MA2411B	1306099	Jul. 22, 2019	Jul. 21, 2020
Anritsu	Power Meter	ML2495A	1349001	Jul. 22, 2019	Jul. 21, 2020
Anritsu	Power Sensor	MA2411B	1207253	Dec. 26, 2019	Dec. 25, 2020
Anritsu	Power Meter	ML2495A	1218010	Dec. 26, 2019	Dec. 25, 2020
R&S	CBT BLUETOOTH TESTER	CBT	100963	Dec. 26, 2019	Dec. 25, 2020
R&S	Spectrum Analyzer	FSP7	100818	Jul. 22, 2019	Jul. 21, 2020
LKM electronic	Hygrometer	DTM3000	3241	Jul. 25, 2019	Jul. 24, 2020
Anymetre	Thermo-Hygrometer	JR593	2015102801	Dec. 30, 2019	Dec. 29, 2020
AR	Amplifier	5S1G4	0333096	Note	
mini-circuits	Amplifier	ZVE-3W-83+	599201528	Note	
ARRA	Power Divider	A3200-2	N/A	Note	
MCL	Attenuation1	BW-S10W5	N/A	Note	
Weinschel	Attenuation2	3M-20	N/A	Note	
Zhongjilianhe	Attenuation3	MVE2214-03	N/A	Note	
PASTERNAK	Dual Directional Coupler	PE2214-10	N/A	Note	
Agilent	Dual Directional Coupler	778D	50422	Note	

Note:

1. Prior to system verification and validation, the path loss from the signal generator to the system check source and the power meter, which includes the amplifier, cable, attenuator and directional coupler, was measured by the network analyzer. The reading of the power meter was offset by the path loss difference between the path to the power meter and the path to the system check source to monitor the actual power level fed to the system check
2. Referring to KDB 865664 D01v01r04, the dipole calibration interval can be extended to 3 years with justification. The dipoles are also not physically damaged, or repaired during the interval.
3. The justification data of dipole can be found in appendix C. The return loss is < -20dB, within 20% of prior calibration, the impedance is within 5 ohm of prior calibration.

10. System Verification

10.1 Tissue Simulating Liquids

For the measurement of the field distribution inside the SAM phantom with DASY, the phantom must be filled with around 25 liters of homogeneous body tissue simulating liquid. For head SAR testing, the liquid height from the ear reference point (ERP) of the phantom to the liquid top surface is larger than 15 cm, which is shown in Fig. 11.1. For body SAR testing, the liquid height from the center of the flat phantom to the liquid top surface is larger than 15 cm, which is shown in Fig. 11.2.

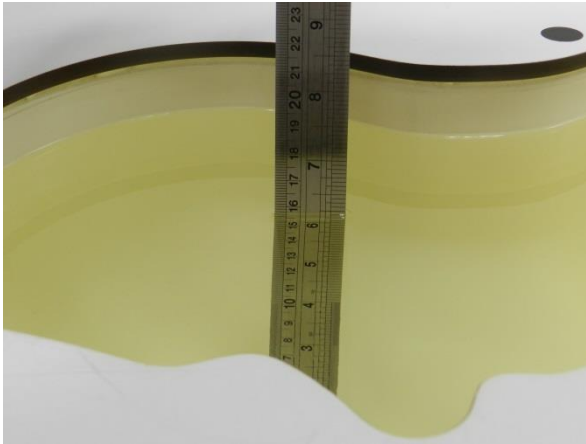

Fig 11.1 Photo of Liquid Height for Head SAR

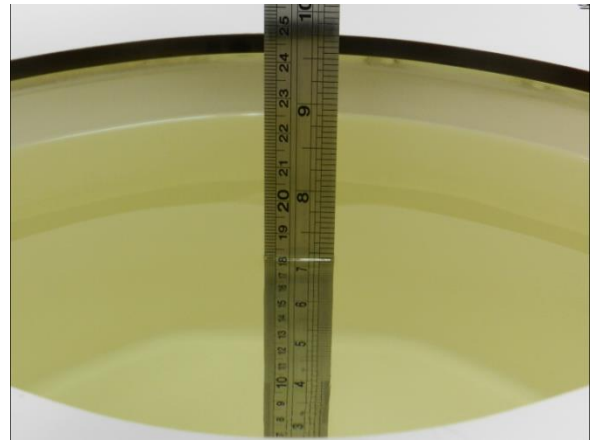

Fig 11.2 Photo of Liquid Height for Body SAR

10.2 Tissue Verification

The following tissue formulations are provided for reference only as some of the parameters have not been thoroughly verified. The composition of ingredients may be modified accordingly to achieve the desired target tissue parameters required for routine SAR evaluation.

Frequency (MHz)	Water (%)	Sugar (%)	Cellulose (%)	Salt (%)	Preventol (%)	DGBE (%)	Conductivity (σ)	Permittivity (ϵ_r)
For Head								
750	41.1	57.0	0.2	1.4	0.2	0	0.89	41.9
835	40.3	57.9	0.2	1.4	0.2	0	0.90	41.5
1800, 1900, 2000	55.2	0	0	0.3	0	44.5	1.40	40.0
2450	55.0	0	0	0	0	45.0	1.80	39.2
2600	54.8	0	0	0.1	0	45.1	1.96	39.0

Simulating Liquid for 5GHz, Manufactured by SPEAG

Ingredients	(% by weight)
Water	64~78%
Mineral oil	11~18%
Emulsifiers	9~15%
Additives and Salt	2~3%

<Tissue Dielectric Parameter Check Results>

Frequency (MHz)	Tissue Type	Liquid Temp. (°C)	Conductivity (σ)	Permittivity (ϵ_r)	Conductivity Target (σ)	Permittivity Target (ϵ_r)	Delta (σ) (%)	Delta (ϵ_r) (%)	Limit (%)	Date
750	Head	22.4	0.879	40.711	0.89	41.90	-1.24	-2.84	±5	2020/3/28
835	Head	22.5	0.913	40.859	0.90	41.50	1.44	-1.54	±5	2020/4/3
1750	Head	22.9	1.377	41.359	1.37	40.10	0.51	3.14	±5	2020/4/19
1900	Head	22.6	1.417	40.994	1.40	40.00	1.21	2.49	±5	2020/4/23
2300	Head	22.9	1.664	38.851	1.67	39.50	-0.36	-1.64	±5	2020/4/1
2450	Head	22.4	1.829	40.081	1.80	39.20	1.61	2.25	±5	2020/4/11
5250	Head	22.7	4.748	36.881	4.71	35.95	0.81	2.59	±5	2020/4/17
5600	Head	22.6	5.182	36.105	5.07	35.50	2.21	1.70	±5	2020/4/18
5750	Head	22.7	5.364	35.845	5.22	35.35	2.76	1.40	±5	2020/4/20

10.3 System Performance Check Results

Comparing to the original SAR value provided by SPEAG, the verification data should be within its specification of 10 %. Below table shows the target SAR and measured SAR after normalized to 1W input power. The table below indicates the system performance check can meet the variation criterion and the plots can be referred to Appendix A of this report.

<1g SAR>

Date	Frequency (MHz)	Tissue Type	Input Power (mW)	Dipole S/N	Probe S/N	DAE S/N	Measured 1g SAR (W/kg)	Targeted 1g SAR (W/kg)	Normalized 1g SAR (W/kg)	Deviation (%)
2020/3/28	750	Head	250	1099	3753	1386	2.26	8.52	9.04	6.10
2020/4/3	835	Head	250	4d162	3753	1386	2.32	9.61	9.28	-3.43
2020/4/19	1750	Head	250	1090	3753	1386	8.92	36.40	35.68	-1.98
2020/4/23	1900	Head	250	5d182	3753	1386	9.87	39.60	39.48	-0.30
2020/4/1	2300	Head	250	1056	3753	1386	11.80	49.90	47.2	-5.41
2020/4/11	2450	Head	250	924	3753	1386	12.20	52.10	48.8	-6.33
2020/4/17	5250	Head	100	1167	3753	1386	7.37	77.00	73.7	-4.29
2020/4/18	5600	Head	100	1167	3753	1386	8.55	80.80	85.5	5.82
2020/4/20	5750	Head	100	1167	3753	1386	7.80	76.90	78	1.43

<10g SAR>

Date	Frequency (MHz)	Tissue Type	Input Power (mW)	Dipole S/N	Probe S/N	DAE S/N	Measured 10g SAR (W/kg)	Targeted 10g SAR (W/kg)	Normalized 10g SAR (W/kg)	Deviation (%)
2020/4/19	1750	Head	250	1090	3753	1386	4.77	19.20	19.08	-0.63
2020/4/23	1900	Head	250	5d182	3753	1386	5.06	20.70	20.24	-2.22
2020/4/17	5250	Head	100	1167	3753	1386	2.03	22.00	20.3	-7.73
2020/4/18	5600	Head	100	1167	3753	1386	2.33	23.20	23.3	0.43

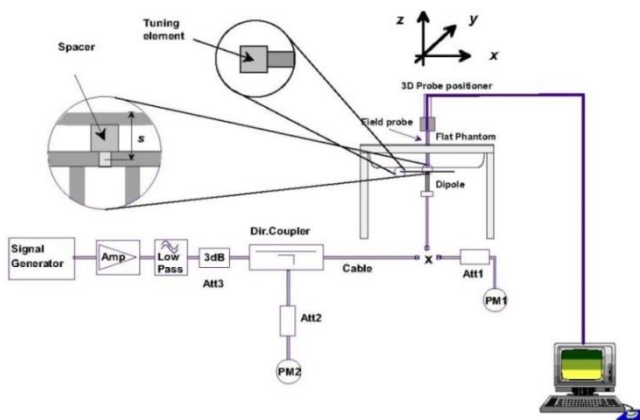

Fig 11.3.1 System Performance Check Setup



Fig 11.3.2 Setup Photo

11. RF Exposure Positions

11.1 Ear and handset reference point

Figure 12.1.1 shows the front, back, and side views of the SAM phantom. The center-of-mouth reference point is labeled “M,” the left ear reference point (ERP) is marked “LE,” and the right ERP is marked “RE.” Each ERP is 15 mm along the B-M (back-mouth) line behind the entrance-to-ear-canal (EEC) point, as shown in Figure 12.1.2 The Reference Plane is defined as passing through the two ear reference points and point M. The line N-F (neck-front), also called the reference pivoting line, is normal to the Reference Plane and perpendicular to both a line passing through RE and LE and the B-M line (see Figure 12.1.3). Both N-F and B-M lines should be marked on the exterior of the phantom shell to facilitate handset positioning. Posterior to the N-F line the ear shape is a flat surface with 6 mm thickness at each ERP, and forward of the N-F line the ear is truncated, as illustrated in Figure 12.1.2. The ear truncation is introduced to preclude the ear lobe from interfering with handset tilt, which could lead to unstable positioning at the cheek.

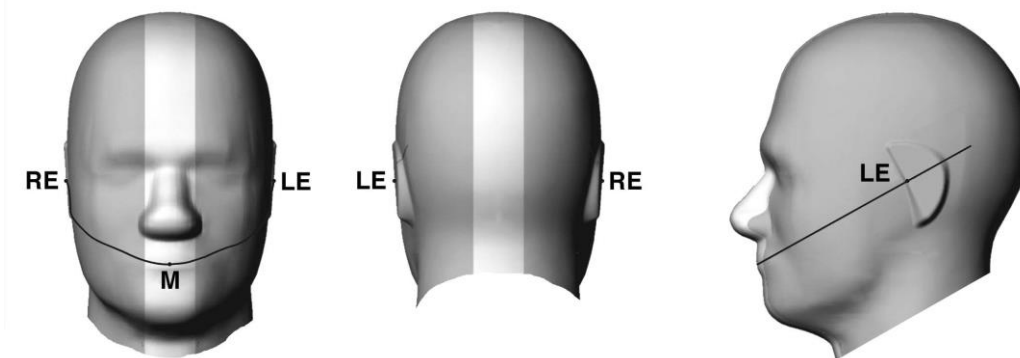

Fig 12.1.1 Front, back, and side views of SAM twin phantom

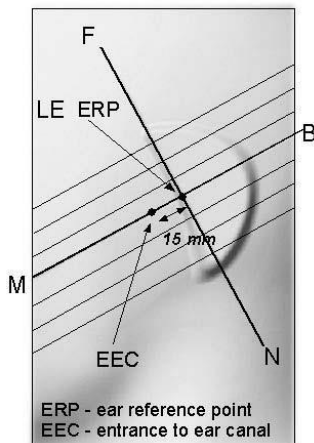

Fig 12.1.2 Close-up side view of phantom showing the ear region.

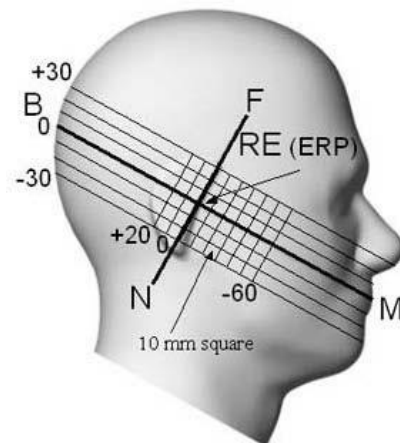

Fig 12.1.3 Side view of the phantom showing relevant markings and seven cross-sectional plane locations

11.2 Definition of the cheek position

1. Ready the handset for talk operation, if necessary. For example, for handsets with a cover piece (flip cover), open the cover. If the handset can transmit with the cover closed, both configurations must be tested.
2. Define two imaginary lines on the handset—the vertical centerline and the horizontal line. The vertical centerline passes through two points on the front side of the handset—the midpoint of the width w_t of the handset at the level of the acoustic output (point A in Figure 12.2.1 and Figure 12.2.2), and the midpoint of the width w_b of the bottom of the handset (point B). The horizontal line is perpendicular to the vertical centerline and passes through the center of the acoustic output (see Figure 12.2.1). The two lines intersect at point A. Note that for many handsets, point A coincides with the center of the acoustic output; however, the acoustic output may be located elsewhere on the horizontal line. Also note that the vertical centerline is not necessarily parallel to the front face of the handset (see Figure 12.2.2), especially for clamshell handsets, handsets with flip covers, and other irregularly-shaped handsets.
3. Position the handset close to the surface of the phantom such that point A is on the (virtual) extension of the line passing through points RE and LE on the phantom (see Figure 12.2.3), such that the plane defined by the vertical centerline and the horizontal line of the handset is approximately parallel to the sagittal plane of the phantom.
4. Translate the handset towards the phantom along the line passing through RE and LE until handset point A touches the pinna at the ERP.
5. While maintaining the handset in this plane, rotate it around the LE-RE line until the vertical centerline is in the plane normal to the plane containing B-M and N-F lines, i.e., the Reference Plane.
6. Rotate the handset around the vertical centerline until the handset (horizontal line) is parallel to the N-F line.
7. While maintaining the vertical centerline in the Reference Plane, keeping point A on the line passing through RE and LE, and maintaining the handset contact with the pinna, rotate the handset about the N-F line until any point on the handset is in contact with a phantom point below the pinna on the cheek. See Figure 12.2.3. The actual rotation angles should be documented in the test report.

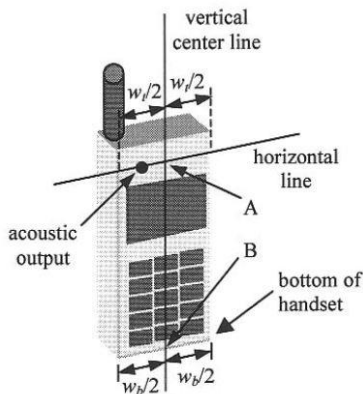

Fig 12.2.1 Handset vertical and horizontal reference lines—“fixed case”

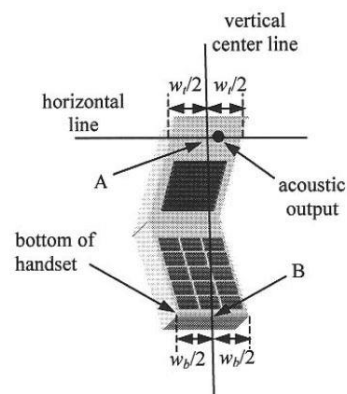

Fig 12.2.2 Handset vertical and horizontal reference lines—“clam-shell case”

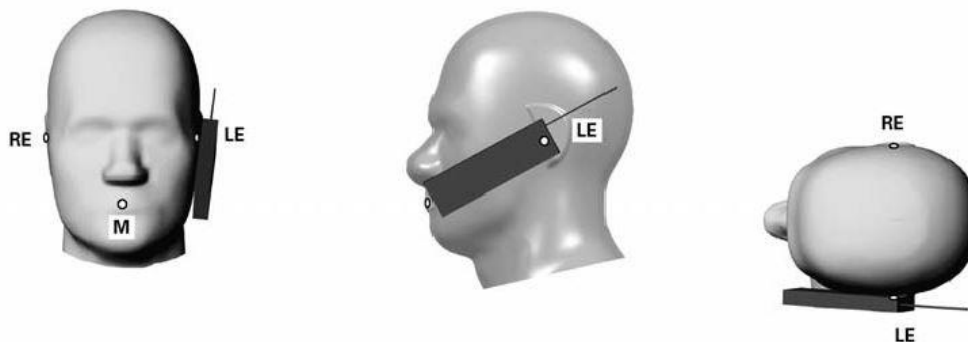

Fig 12.2.3 cheek or touch position. The reference points for the right ear (RE), left ear (LE), and mouth (M), which establish the Reference Plane for handset positioning, are indicated.

11.3 Definition of the tilt position

1. Ready the handset for talk operation, if necessary. For example, for handsets with a cover piece (flip cover), open the cover. If the handset can transmit with the cover closed, both configurations must be tested.
2. While maintaining the orientation of the handset, move the handset away from the pinna along the line passing through RE and LE far enough to allow a rotation of the handset away from the cheek by 15°.
3. Rotate the handset around the horizontal line by 15°.
4. While maintaining the orientation of the handset, move the handset towards the phantom on the line passing through RE and LE until any part of the handset touches the ear. The tilt position is obtained when the contact point is on the pinna. See Figure 12.3.1. If contact occurs at any location other than the pinna, e.g., the antenna at the back of the phantom head, the angle of the handset should be reduced. In this case, the tilt position is obtained if any point on the handset is in contact with the pinna and a second point

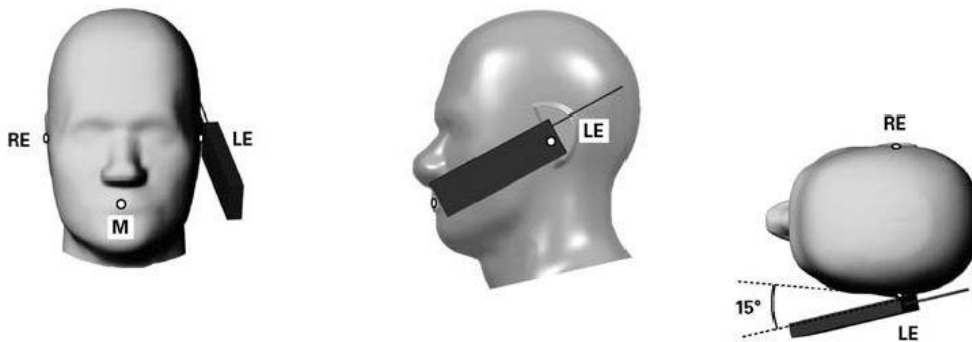

Fig 12.3.1 Tilt position. The reference points for the right ear (RE), left ear (LE), and mouth (M), which define the Reference Plane for handset positioning, are indicated.

11.4 Body Worn Accessory

Body-worn operating configurations are tested with the belt-clips and holsters attached to the device and positioned against a flat phantom in a normal use configuration (see Figure 12.4). Per KDB648474 D04v01r03, body-worn accessory exposure is typically related to voice mode operations when handsets are carried in body-worn accessories. The body-worn accessory procedures in FCC KDB 447498 D01v06 should be used to test for body-worn accessory SAR compliance, without a headset connected to it. This enables the test results for such configuration to be compatible with that required for hotspot mode when the body-worn accessory test separation distance is greater than or equal to that required for hotspot mode, when applicable. When the reported SAR for body-worn accessory, measured without a headset connected to the handset is $> 1.2 \text{ W/kg}$, the highest reported SAR configuration for that wireless mode and frequency band should be repeated for that body-worn accessory with a headset attached to the handset.

Accessories for body-worn operation configurations are divided into two categories: those that do not contain metallic components and those that do contain metallic components. When multiple accessories that do not contain metallic components are supplied with the device, the device is tested with only the accessory that dictates the closest spacing to the body. Then multiple accessories that contain metallic components are tested with the device with each accessory. If multiple accessories share an identical metallic component (i.e. the same metallic belt-clip used with different holsters with no other metallic components) only the accessory that dictates the closest spacing to the body is tested.

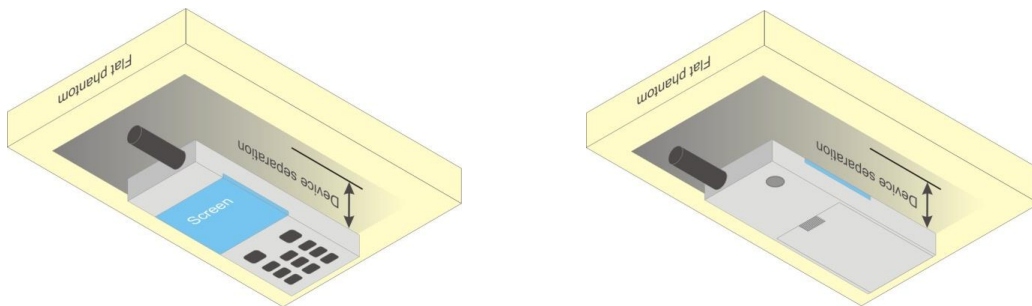

Fig 12.4 Body Worn Position



11.5 Product Specific 10g SAR Exposure

For smart phones with a display diagonal dimension > 15.0 cm or an overall diagonal dimension > 16.0 cm that provide similar mobile web access and multimedia support found in mini-tablets or UMPC mini-tablets that support voice calls next to the ear, According to KDB648474 D04v01r03, the following phablet procedures should be applied to evaluate SAR compliance for each applicable wireless modes and frequency band. Devices marketed as phablets, regardless of form factors and operating characteristics must be tested as a phablet to determine SAR compliance

1. The normally required head and body-worn accessory SAR test procedures for handsets, including hotspot mode, must be applied.
2. The UMPC mini-tablet procedures must also be applied to test the SAR of all surfaces and edges with an antenna located at ≤ 25 mm from that surface or edge, in direct contact with a flat phantom, for 10-g extremity SAR according to the body-equivalent tissue dielectric parameters in KDB 865664 to address interactive hand use exposure conditions.6 The UMPC mini-tablet 1-g SAR at 5 mm is not required. When hotspot mode applies, 10-g extremity SAR is required only for the surfaces and edges with hotspot mode 1-g reported SAR > 1.2 W/kg.

11.6 Wireless Router

Some battery-operated handsets have the capability to transmit and receive user through simultaneous transmission of WIFI simultaneously with a separate licensed transmitter. The FCC has provided guidance in FCC KDB Publication 941225 D06 v02r01 where SAR test considerations for handsets ($L \times W \geq 9$ cm x 5 cm) are based on a composite test separation distance of 10mm from the front, back and edges of the device containing transmitting antennas within 2.5cm of their edges, determined from general mixed use conditions for this type of devices. Since the hotspot SAR results may overlap with the body-worn accessory SAR requirements, the more conservative configurations can be considered, thus excluding some body-worn accessory SAR tests.

When the user enables the personal wireless router functions for the handset, actual operations include simultaneous transmission of both the WIFI transmitter and another licensed transmitter. Both transmitters often do not transmit at the same transmitting frequency and thus cannot be evaluated for SAR under actual use conditions due to the limitations of the SAR assessment probes. Therefore, SAR must be evaluated for each frequency transmission and mode separately and spatially summed with the WIFI transmitter according to FCC KDB Publication 447498 D01v06 publication procedures. The "Portable Hotspot" feature on the handset was NOT activated during SAR assessments, to ensure the SAR measurements were evaluated for a single transmission frequency RF signal at a time.



12. Conducted RF Output Power (Unit: dBm)

The detailed conducted power table can refer to Appendix E.

<GSM Conducted Power>

1. Per KDB 447498 D01v06, the maximum output power channel is used for SAR testing and for further SAR test reduction.
2. Per KDB 941225 D01v03r01, for SAR test reduction for GSM / GPRS / EDGE modes is determined by the source-based time-averaged output power including tune-up tolerance. The mode with highest specified time-averaged output power should be tested for SAR compliance in the applicable exposure conditions. For modes with the same specified maximum output power and tolerance, the higher number time-slot configuration should be tested. Therefore, the GPRS 2Tx slots for GSM850/GSM1900 are considered as the primary mode.
3. Other configurations of GSM / GPRS / EDGE are considered as secondary modes. The 3G SAR test reduction procedure is applied, when the maximum output power and tune-up tolerance specified for production units in a secondary mode is $\leq \frac{1}{4}$ dB higher than the primary mode, SAR measurement is not required for the secondary mode.

<WCDMA Conducted Power>

1. The following tests were conducted according to the test requirements outlines in 3GPP TS 34.121 specification.
2. The procedures in KDB 941225 D01v03r01 are applied for 3GPP Rel. 6 HSPA to configure the device in the required sub-test mode(s) to determine SAR test exclusion.
3. For HSPA+ devices supporting 16 QAM in the uplink, power measurements procedure is according to the configurations in Table C.11.1.4 of 3GPP TS 34.121-1.
4. For DC-HSDPA, the device was configured according to the H-Set 12, Fixed Reference Channel (FRC) configuration in Table C.8.1.12 of 3GPP TS 34.121-1, with the primary and the secondary serving HS-DSCH Cell enabled during the power measurement.

A summary of these settings are illustrated below:

HSDPA Setup Configuration:

- a. The EUT was connected to Base Station Agilent E5515C referred to the Setup Configuration.
- b. The RF path losses were compensated into the measurements.
- c. A call was established between EUT and Base Station with following setting:
 - i. Set Gain Factors (β_c and β_d) and parameters were set according to each
 - ii. Specific sub-test in the following table, C10.1.4, quoted from the TS 34.121
 - iii. Set RMC 12.2Kbps + HSDPA mode.
 - iv. Set Cell Power = -86 dBm
 - v. Set HS-DSCH Configuration Type to FRC (H-set 1, QPSK)
 - vi. Select HSDPA Uplink Parameters
 - vii. Set Delta ACK, Delta NACK and Delta CQI = 8
 - viii. Set Ack-Nack Repetition Factor to 3
 - ix. Set CQI Feedback Cycle (k) to 4 ms
 - x. Set CQI Repetition Factor to 2
 - xi. Power Ctrl Mode = All Up bits
- d. The transmitted maximum output power was recorded.

Table C.10.1.4: β values for transmitter characteristics tests with HS-DPCCH

Sub-test	β_c	β_d	β_d (SF)	β_c/β_d	β_{HS} (Note 1, Note 2)	CM (dB) (Note 3)	MPR (dB) (Note 3)
1	2/15	15/15	64	2/15	4/15	0.0	0.0
2	12/15 (Note 4)	15/15 (Note 4)	64	12/15 (Note 4)	24/15	1.0	0.0
3	15/15	8/15	64	15/8	30/15	1.5	0.5
4	15/15	4/15	64	15/4	30/15	1.5	0.5

Note 1: Δ_{ACK} , Δ_{NACK} and $\Delta_{CQI} = 30/15$ with $\beta_{HS} = 30/15 * \beta_c$.

Note 2: For the HS-DPCCH power mask requirement test in clause 5.2C, 5.7A, and the Error Vector Magnitude (EVM) with HS-DPCCH test in clause 5.13.1A, and HSDPA EVM with phase discontinuity in clause 5.13.1AA, Δ_{ACK} and $\Delta_{NACK} = 30/15$ with $\beta_{HS} = 30/15 * \beta_c$, and $\Delta_{CQI} = 24/15$ with $\beta_{HS} = 24/15 * \beta_c$.

Note 3: CM = 1 for $\beta_c/\beta_d = 12/15$, $\beta_{HS}/\beta_c = 24/15$. For all other combinations of DPDCH, DPCCH and HS-DPCCH the MPR is based on the relative CM difference. This is applicable for only UEs that support HSDPA in release 6 and later releases.

Note 4: For subtest 2 the β_c/β_d ratio of 12/15 for the TFC during the measurement period (TF1, TF0) is achieved by setting the signalled gain factors for the reference TFC (TF1, TF1) to $\beta_c = 11/15$ and $\beta_d = 15/15$.

Setup Configuration

HSUPA Setup Configuration:

- a. The EUT was connected to Base Station Agilent E5515C referred to the Setup Configuration.
- b. The RF path losses were compensated into the measurements.
- c. A call was established between EUT and Base Station with following setting * :
 - i. Call Configs = 5.2B, 5.9B, 5.10B, and 5.13.2B with QPSK
 - ii. Set the Gain Factors (β_c and β_d) and parameters (AG Index) were set according to each specific sub-test in the following table, C11.1.3, quoted from the TS 34.121
 - iii. Set Cell Power = -86 dBm
 - iv. Set Channel Type = 12.2k + HSPA
 - v. Set UE Target Power
 - vi. Power Ctrl Mode= Alternating bits
 - vii. Set and observe the E-TFCI
 - viii. Confirm that E-TFCI is equal to the target E-TFCI of 75 for sub-test 1, and other subtest's E-TFCI
- d. The transmitted maximum output power was recorded.

Table C.11.1.3: β values for transmitter characteristics tests with HS-DPCCH and E-DCH

Sub-test	β_c	β_d	β_d (SF)	β_c/β_d	β_{HS} (Note1)	β_{ec}	β_{ed} (Note 4) (Note 5)	β_{ed} (SF)	β_{ed} (Codes)	CM (dB) (Note 2)	MPR (dB) (Note 2) (Note 6)	AG Index (Note 5)	E-TFCI
1	11/15 (Note 3)	15/15 (Note 3)	64	11/15 (Note 3)	22/15	209/25	1309/225	4	1	1.0	0.0	20	75
2	6/15	15/15	64	6/15	12/15	12/15	94/75	4	1	3.0	2.0	12	67
3	15/15	9/15	64	15/9	30/15	30/15	β_{ed1} : 47/15 β_{ed2} : 47/15	4 4	2	2.0	1.0	15	92
4	2/15	15/15	64	2/15	4/15	2/15	56/75	4	1	3.0	2.0	17	71
5	15/15	0	-	-	5/15	5/15	47/15	4	1	1.0	0.0	12	67

Note 1: For sub-test 1 to 4, Δ_{ACK} , Δ_{NACK} and $\Delta_{CQI} = 30/15$ with $\beta_{hs} = 30/15 * \beta_c$. For sub-test 5, Δ_{ACK} , Δ_{NACK} and $\Delta_{CQI} = 5/15$ with $\beta_{hs} = 5/15 * \beta_c$.

Note 2: CM = 1 for $\beta_c/\beta_d = 12/15$, $\beta_{hs}/\beta_c = 24/15$. For all other combinations of DPDCH, DPCCH, HS- DPCCH, E-DPDCH and E-DPCCH the MPR is based on the relative CM difference.

Note 3: For subtest 1 the β_c/β_d ratio of 11/15 for the TFC during the measurement period (TF1, TF0) is achieved by setting the signalled gain factors for the reference TFC (TF1, TF0) to $\beta_c = 10/15$ and $\beta_d = 15/15$.

Note 4: In case of testing by UE using E-DPDCH Physical Layer category 1, Sub-test 3 is omitted according to TS25.306 Table 5.1g.

Note 5: β_{ed} can not be set directly; it is set by Absolute Grant Value.

Note 6: For subtests 2, 3 and 4, UE may perform E-DPDCH power scaling at max power which could results in slightly smaller MPR values.

Setup Configuration

DC-HSDPA 3GPP release 8 Setup Configuration:

- a. The EUT was connected to Base Station referred to the Setup Configuration below
- b. The RF path losses were compensated into the measurements.
- c. A call was established between EUT and Base Station with following setting:
 - i. Set RMC 12.2Kbps + HSDPA mode.
 - ii. Set Cell Power = -25 dBm
 - iii. Set HS-DSCH Configuration Type to FRC (H-set 12, QPSK)
 - iv. Select HSDPA Uplink Parameters
 - v. Set Gain Factors (β_c and β_d) and parameters were set according to each Specific sub-test in the following table, C10.1.4, quoted from the TS 34.121
 - a). Subtest 1: $\beta_c/\beta_d=2/15$
 - b). Subtest 2: $\beta_c/\beta_d=12/15$
 - c). Subtest 3: $\beta_c/\beta_d=15/8$
 - d). Subtest 4: $\beta_c/\beta_d=15/4$
 - vi. Set Delta ACK, Delta NACK and Delta CQI = 8
 - vii. Set Ack-Nack Repetition Factor to 3
 - viii. Set CQI Feedback Cycle (k) to 4 ms
 - ix. Set CQI Repetition Factor to 2
 - x. Power Ctrl Mode = All Up bits
- d. The transmitted maximum output power was recorded.

The following tests were conducted according to the test requirements outlines in 3GPP TS 34.121 specification. A summary of these settings are illustrated below:

C.8.1.12 Fixed Reference Channel Definition H-Set 12

Table C.8.1.12: Fixed Reference Channel H-Set 12

Parameter	Unit	Value
Nominal Avg. Inf. Bit Rate	kbps	60
Inter-TTI Distance	TTI's	1
Number of HARQ Processes	Processes	6
Information Bit Payload (N_{INF})	Bits	120
Number Code Blocks	Blocks	1
Binary Channel Bits Per TTI	Bits	960
Total Available SML's in UE	SML's	19200
Number of SML's per HARQ Proc.	SML's	3200
Coding Rate		0.15
Number of Physical Channel Codes	Codes	1
Modulation		QPSK
Note 1: The RMC is intended to be used for DC-HSDPA mode and both cells shall transmit with identical parameters as listed in the table. Note 2: Maximum number of transmission is limited to 1, i.e., retransmission is not allowed. The redundancy and constellation version 0 shall be used.		

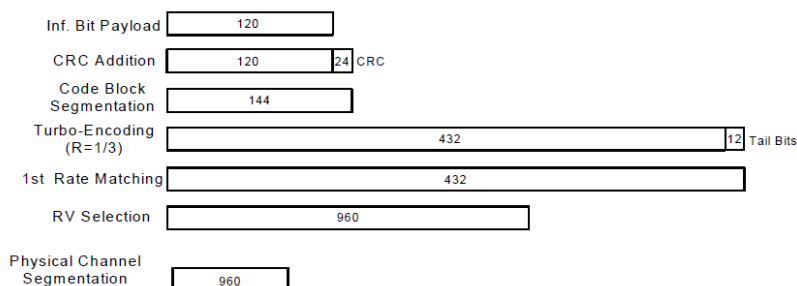

Figure C.8.19: Coding rate for Fixed reference Channel H-Set 12 (QPSK)

Setup Configuration

HSPA+ 3GPP release 7 (uplink category 7) 16QAM, Setup Configuration:

- a. The EUT was connected to Base Station Agilent E5515C referred to the Setup Configuration.
- b. The RF path losses were compensated into the measurements.
- c. A call was established between EUT and Base Station with following setting * :
 - i. Call Configs = 5.2E:HSPA+:UL with 16QAM
 - ii. Set the Gain Factors (β_c and β_d) and parameters (AG Index) were set according to each specific sub-test in the following table, C11.1.4, quoted from the TS 34.121-1 s5.2E
 - iii. Set Channel Parms
 - iv. Set Cell Power = -86 dBm
 - v. Set Channel Type = HSPA
 - vi. Set UE Target Power =21 dBm
 - vii. Power Ctrl Mode= All Up Bits
 - viii. Set Manual Uplink DPCH Bc/Bd = Manual
 - ix. Set Manual Uplink DPCH Bc and Bd=15,15(for 34.121-1 v8.10.0 table C11.1.4 sub-test 1)
 - x. Set HSPA Conn DL Channel Levels
 - xi. Set HS-SCCH Configs
 - xii. Set RB Test Mode Setup
 - xiii. Set Common HSUPA Parameters
 - xiv. Set Serving Grant
 - xv. Confirm that E-TFCI is equal to the target E-TFCI of 105 for sub-test 1, and other subtest's E-TFCI
- d. The transmitted maximum output power was recorded.

Table C.11.1.4: β values for transmitter characteristics tests with HS-DPCCH and E-DCH with 16QAM

Sub-test	β_c (Note3)	β_d	β_{HS} (Note1)	β_{ec}	β_{ed} (2xSF2) (Note 4)	β_{ed} (2xSF4) (Note 4)	CM (dB) (Note 2)	MPR (dB) (Note 2)	AG Index (Note 4)	E-TFCI (Note 5)	E-TFCI (boost)
1	1	0	30/15	30/15	β_{ed1} : 30/15 β_{ed2} : 30/15	β_{ed3} : 24/15 β_{ed4} : 24/15	3.5	2.5	14	105	105

Note 1: $\Delta_{ACK}, \Delta_{NACK}$ and $\Delta_{CQI} = 30/15$ with $\beta_{fs} = 30/15 * \beta_c$.

Note 2: CM = 3.5 and the MPR is based on the relative CM difference, MPR = MAX(CM-1,0).

Note 3: DPDCH is not configured, therefore the β_c is set to 1 and $\beta_d = 0$ by default.

Note 4: β_{ed} can not be set directly; it is set by Absolute Grant Value.

Note 5: All the sub-tests require the UE to transmit 2SF2+2SF4 16QAM EDCH and they apply for UE using E-DPDCH category 7. E-DCH TTI is set to 2ms TTI and E-DCH table index = 2. To support these E-DCH configurations DPDCH is not allocated. The UE is signaled to use the extrapolation algorithm.

Setup Configuration



<WCDMA Conducted Power>

General Note:

1. Per KDB 941225 D01v03r01, for SAR testing is measured using a 12.2 kbps RMC with TPC bits configured to all "1's".
2. Per KDB 941225 D01v03r01, RMC 12.2kbps setting is used to evaluate SAR. The maximum output power and tune-up tolerance specified for production units in HSDPA / HSUPA / DC-HSDPA / HSPA+ is $\leq \frac{1}{4}$ dB higher than RMC 12.2Kbps or when the highest reported SAR of the RMC12.2Kbps is scaled by the ratio of specified maximum output power and tune-up tolerance of HSDPA / HSUPA / DC-HSDPA / HSPA+ to RMC12.2Kbps and the adjusted SAR is ≤ 1.2 W/kg, SAR measurement is not required for HSDPA / HSUPA / DC-HSDPA / HSPA+, and according to the following RF output power, the output power results of the secondary modes (HSDPA / HSUPA / DC-HSDPA / HSPA+) are less than $\frac{1}{4}$ dB higher than the primary modes; therefore, SAR measurement is not required for HSDPA / HSUPA / DC-HSDPA / HSPA+

<LTE Conducted Power>

General Note:

1. Anritsu MT8820C base station simulator was used to setup the connection with EUT; the frequency band, channel bandwidth, RB allocation configuration, modulation type are set in the base station simulator to configure EUT transmitting at maximum power and at different configurations which are requested to be reported to FCC, for conducted power measurement and SAR testing.
2. Per KDB 941225 D05v02r05, when a properly configured base station simulator is used for the SAR and power measurements, spectrum plots for each RB allocation and offset configuration is not required.
3. Per KDB 941225 D05v02r05, start with the largest channel bandwidth and measure SAR for QPSK with 1 RB allocation, using the RB offset and required test channel combination with the highest maximum output power for RB offsets at the upper edge, middle and lower edge of each required test channel.
4. Per KDB 941225 D05v02r05, 50% RB allocation for QPSK SAR testing follows 1RB QPSK allocation procedure.
5. Per KDB 941225 D05v02r05, for QPSK with 100% RB allocation, SAR is not required when the highest maximum output power for 100 % RB allocation is less than the highest maximum output power in 50% and 1 RB allocations and the highest reported SAR for 1 RB and 50% RB allocation are ≤ 0.8 W/kg. Otherwise, SAR is measured for the highest output power channel; and if the reported SAR is > 1.45 W/kg, the remaining required test channels must also be tested.
6. Per KDB 941225 D05v02r05, 16QAM/64QAM output power for each RB allocation configuration is $>$ not $\frac{1}{2}$ dB higher than the same configuration in QPSK and the reported SAR for the QPSK configuration is ≤ 1.45 W/kg; Per KDB 941225 D05v02r05, 16QAM/64QAM SAR testing is not required.
7. Per KDB 941225 D05v02r05, smaller bandwidth output power for each RB allocation configuration is $>$ not $\frac{1}{2}$ dB higher than the same configuration in the largest supported bandwidth, and the reported SAR for the largest supported bandwidth is ≤ 1.45 W/kg; Per KDB 941225 D05v02r05, smaller bandwidth SAR testing is not required.
8. For LTE B4 / B5 / B12 the maximum bandwidth does not support three non-overlapping channels, per KDB 941225 D05v02r05, when a device supports overlapping channel assignment in a channel bandwidth configuration, the middle channel of the group of overlapping channels should be selected for testing.
9. According to 2017 TCB workshop, for 64 QAM and 16 QAM should be verified by checking the signal constellation with a call box to avoid incorrect maximum power levels due to MPR and other requirements associated with signal modulation, and the following figure is taken from the "Fundamental Measurement >> Modulation Analysis >> constellation" mode of the device connect to the MT8821C base station, therefore, the device 64QAM and 16QAM signal modulation are correct.

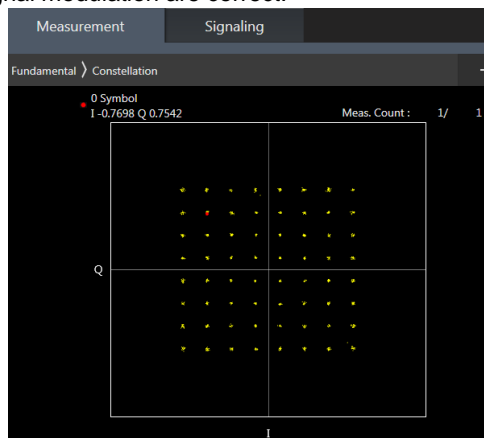

64QAM



16QAM



<LTE Carrier Aggregation>

General Note:

- 1. This device supports Carrier Aggregation on downlink for inter and intra band. For the device supports bands and bandwidths and configurations are provided as follow table was according to 3GPP.
- 2. In applying the existing power measurement procedures of KDB 941225 D05A for DL CA SAR test exclusion, only the subset with the largest number of combinations of frequency bands and CCs in each row need combination, and for this device that all the configurations were choose to power measurement.
- 3. All permutations exist. No restrictions on Pcell & Scell combinations. Only LTE Band 29A is limited to Scell.

Index	2CC
2CC #1	CA_2A-12A
2CC #2	CA_12A-30A
2CC #3	CA_66A-12A



LTE Carrier Aggregation Conducted Power (Downlink)

- i. According to KDB941225 D05A v01r02, Uplink maximum output power measurement with downlink carrier aggregation active should be measured, using the highest output channel measured without downlink carrier aggregation, to confirm that uplink maximum output power with downlink carrier aggregation active remains within the specified tune-up tolerance limits and not more than ¼ dB higher than the maximum output measured without downlink carrier aggregation active.
- ii. Uplink maximum output power with downlink carrier aggregation active does not show more than ¼ dB higher than the maximum output power without downlink carrier aggregation active, therefore SAR evaluation with downlink carrier aggregation active can be excluded.
- iii. The device supports downlink two carrier aggregation. For power measurement were control and acknowledge data is sent on uplink channels that operate identical to specifications when downlink carrier aggregation is inactive.
- iv. Selected highest measured power when downlink carrier aggregation is inactive for conducted power comparison with downlink carrier aggregation is active, to confirm that when downlink carrier aggregation is active uplink maximum output power remains within the specified tune-up tolerance limits and not more than ¼ dB higher than the maximum output power measured when downlink carrier aggregation inactive.
- v. For inter-band CA, the SCC selected highest bandwidth and near the middle of its transmission band. For SCC DL RB size and offset will base on the PCC corresponding RB allocation.

<WLAN Conducted Power>

General Note:

1. Per KDB 248227 D01v02r02, SAR test reduction is determined according to 802.11 transmission mode configurations and certain exposure conditions with multiple test positions. In the 2.4 GHz band, separate SAR procedures are applied to DSSS and OFDM configurations to simplify DSSS test requirements. For OFDM, in both 2.4 and 5 GHz bands, an initial test configuration must be determined for each standalone and aggregated frequency band, according to the transmission mode configuration with the highest maximum output power specified for production units to perform SAR measurements. If the same highest maximum output power applies to different combinations of channel bandwidths, modulations and data rates, additional procedures are applied to determine which test configurations require SAR measurement. When applicable, an initial test position may be applied to reduce the number of SAR measurements required for next to the ear, UMPC mini-tablet or hotspot mode configurations with multiple test positions.
2. For 2.4 GHz 802.11b DSSS, either the initial test position procedure for multiple exposure test positions or the DSSS procedure for fixed exposure position is applied; these are mutually exclusive. For 2.4 GHz and 5 GHz OFDM configurations, the initial test configuration is applied to measure SAR using either the initial test position procedure for multiple exposure test position configurations or the initial test configuration procedures for fixed exposure test conditions. Based on the reported SAR of the measured configurations and maximum output power of the transmission mode configurations that are not included in the initial test configuration, the subsequent test configuration and initial test position procedures are applied to determine if SAR measurements are required for the remaining OFDM transmission configurations. In general, the number of test channels that require SAR measurement is minimized based on maximum output power measured for the test sample(s).
3. For OFDM transmission configurations in the 2.4 GHz and 5 GHz bands, When the same maximum power is specified for multiple transmission modes in a frequency band, the largest channel bandwidth, lowest order modulation, lowest data rate and lowest order 802.11a/g/n/ac mode is used for SAR measurement, on the highest measured output power channel for each frequency band.
4. DSSS and OFDM configurations are considered separately according to the required SAR procedures. SAR is measured in the initial test position using the 802.11 transmission mode configuration required by the DSSS procedure or initial test configuration and subsequent test configuration(s) according to the OFDM procedures.18 The initial test position procedure is described in the following:
 - a. When the reported SAR of the initial test position is ≤ 0.4 W/kg, further SAR measurement is not required for the other test positions in that exposure configuration and 802.11 transmission mode combinations within the frequency band or aggregated band.
 - b. When the reported SAR of the test position is > 0.4 W/kg, SAR is repeated for the 802.11 transmission mode configuration tested in the initial test position to measure the subsequent next closet/smallest test separation distance and maximum coupling test position on the highest maximum output power channel, until the report SAR is ≤ 0.8 W/kg or all required test position are tested.
 - c. For all positions/configurations, when the reported SAR is > 0.8 W/kg, SAR is measured for these test positions/configurations on the subsequent next highest measured output power channel(s) until the reported SAR is ≤ 1.2 W/kg or all required channels are tested.

<2.4GHz Bluetooth>

General Note:

1. For 2.4GHz Bluetooth SAR testing was selected 1Mbps, due to its highest average power.
2. The Bluetooth duty cycle is 76.74 % as following figure, according to 2016 Oct. TCB workshop for Bluetooth SAR scaling need further consideration and the theoretical duty cycle is 83.3%, therefore the actual duty cycle will be scaled up to the theoretical value of Bluetooth reported SAR calculation

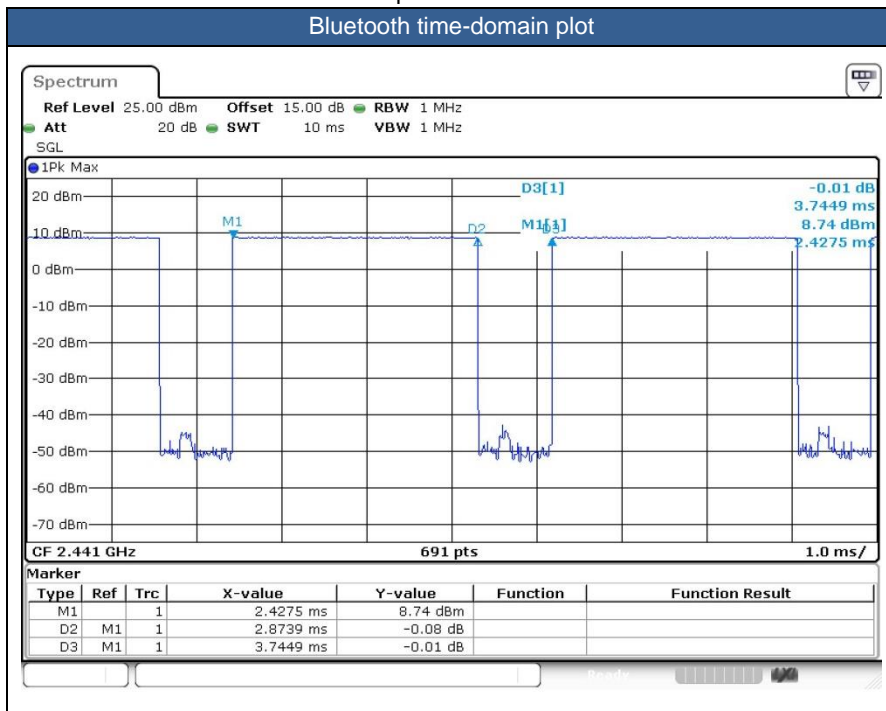

13. Antenna Location

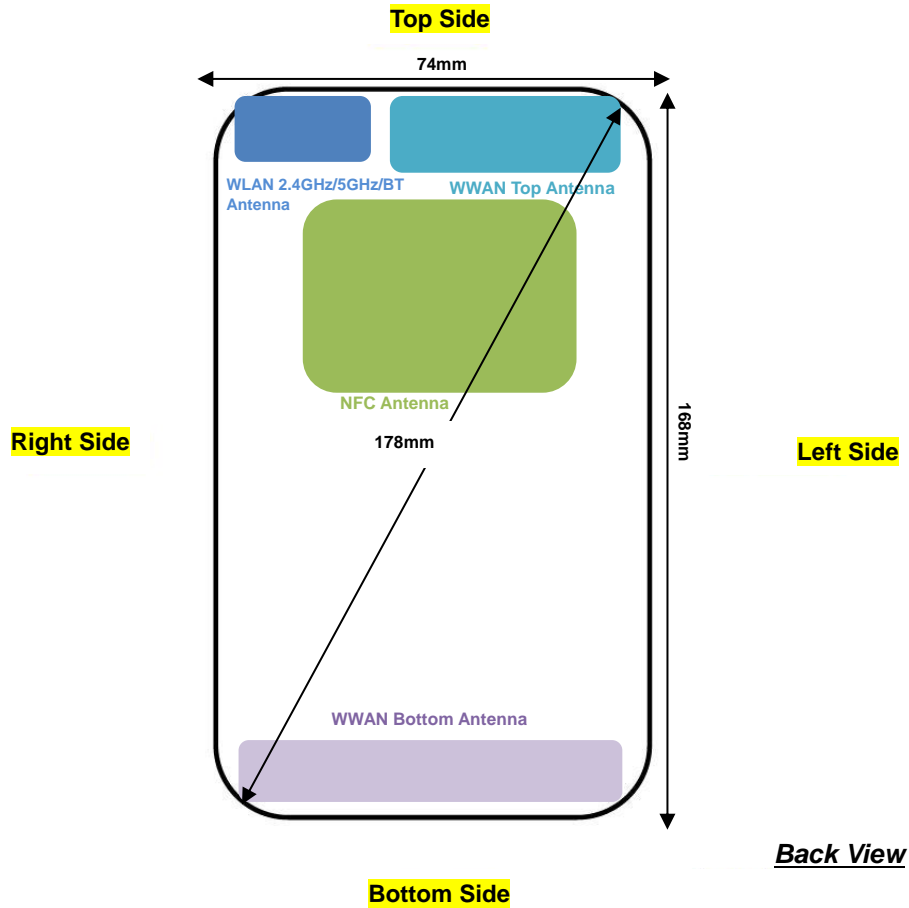

Antenna	Support Band
WWAN Top Antenna	WCDMA: B5 LTE: B5
WWAN Bottom Antenna	GSM: 850 / 1900 WCDMA: B2 / B4 LTE: B2 / B4 / B12 / B14 / B30 / B66
WLAN 2.4GHz/5GHz/BT Antenna	WLAN 2.4GHz WLAN 5GHz Bluetooth
NFC Antenna	NFC

Distance of the Antenna to the EUT surface/edge						
Antennas	Back	Front	Top Side	Bottom Side	Right Side	Left Side
WWAN Top Antenna	≤ 25mm	≤ 25mm	≤ 25mm	>25mm	>25mm	≤ 25mm
WWAN Bottom Antenna	≤ 25mm	≤ 25mm	>25mm	≤ 25mm	≤ 25mm	≤ 25mm
WLAN 2.4GHz/5GHz/BT	≤ 25mm	≤ 25mm	≤ 25mm	>25mm	≤ 25mm	>25mm

Distance of the Antenna to the EUT surface/edge						
Antennas	Back	Front	Top Side	Bottom Side	Right Side	Left Side
WWAN Top Antenna	Yes	Yes	Yes	No	No	Yes
WWAN Bottom Antenna	Yes	Yes	No	Yes	Yes	Yes
WLAN 2.4GHz/5GHz/BT	Yes	Yes	Yes	No	Yes	No

General Note:

Referring to KDB 941225 D06 v02r01, when the overall device length and width are ≥ 9cm*5cm, the test distance is 10 mm. SAR must be measured for all sides and surfaces with a transmitting antenna located within 25mm from that surface or edge.

14. SAR Test Results

General Note:

1. Per KDB 447498 D01v06, the reported SAR is the measured SAR value adjusted for maximum tune-up tolerance.
 - a. Tune-up scaling Factor = tune-up limit power (mW) / EUT RF power (mW), where tune-up limit is the maximum rated power among all production units.
 - b. For SAR testing of WLAN signal with non-100% duty cycle, the measured SAR is scaled-up by the duty cycle scaling factor which is equal to "1/(duty cycle)"
 - c. For WWAN: Reported SAR(W/kg)= Measured SAR(W/kg)*Tune-up Scaling Factor
 - d. For BT/WLAN: Reported SAR(W/kg)= Measured SAR(W/kg)* Duty Cycle scaling factor * Tune-up scaling factor
2. Per KDB 447498 D01v06, for each exposure position, testing of other required channels within the operating mode of a frequency band is not required when the *reported* 1-g or 10-g SAR for the mid-band or highest output power channel is:
 - ≤ 0.8 W/kg or 2.0 W/kg, for 1-g or 10-g respectively, when the transmission band is ≤ 100 MHz
 - ≤ 0.6 W/kg or 1.5 W/kg, for 1-g or 10-g respectively, when the transmission band is between 100 MHz and 200 MHz
 - ≤ 0.4 W/kg or 1.0 W/kg, for 1-g or 10-g respectively, when the transmission band is ≥ 200 MHz
3. Per KDB 865664 D01v01r04, for each frequency band, repeated SAR measurement is required when the measured SAR is ≥ 0.8 W/kg. Per KDB 865664 D01v01r04, if the extremity repeated SAR is necessary, the same procedures should be adapted for measurements according to extremity and occupational exposure limits by applying a factor of 2.5 for extremity exposure and a factor of 5 for occupational exposure to the corresponding SAR thresholds.
4. Per KDB 648474 D04v01r03, when the reported SAR for a body-worn accessory measured without a headset connected to the handset is ≤ 1.2 W/kg, SAR testing with a headset connected to the handset is not required.
5. When the phone is in talking mode and receiver worked, then power reduction will be implemented immediately at WCDMA band V, LTE band 5 and WLAN5.2GHz/5.3GHz/5.5GHz/5.8GHz for head SAR.
6. When receiver not worked, then power reduction will be implemented immediately at GSM1900, WCDMA band II/IV, LTE band 2/4/66 for body-worn and product specific 10g SAR.
7. When hotspot mode is enabled, power reduction will be activated to limit the maximum power of GSM1900, WCDMA band II/IV, LTE band 2/4/66 for hotspot SAR.
8. This device has two WWAN transmit antennas. WWAN bottom antenna is located at the bottom edge of the device, and WWAN top antenna is located at the top edge of the device which can refer to antenna location chapter. WWAN top antenna frequency bands include WCDMA Band V and LTE Band 5, WWAN bottom antenna frequency band include GSM850/1900, WCDMA Band II/IV and LTE Band 2/4/12/14/30/66.
9. Per KDB648474 D04v01r03, for smart phones with a display diagonal dimension > 15.0 cm or an overall diagonal dimension > 16.0 cm, when hotspot mode applies, 10-g extremity SAR is required only for the surfaces and edges with hotspot mode 1-g reported SAR > 1.2 W/kg, however, when power reduction applies to hotspot mode the measured SAR must be scaled to the maximum output power (for handheld on state, the maximum full power means reduced power), including tolerance, allowed for phablet modes to compare with the 1.2 W/kg SAR test reduction threshold.
 - a. For this device SAR for WWAN/WLAN transmitter scaled to maximum output power mode for product specific 10g SAR is higher than 1.2W/kg of GSM1900, WCDMA Band II/IV, LTE Band 2/4/66 therefore product specific 10g SAR is necessary.
 - b. WLAN 5.3/5.5GHz tested the product specific 10g SAR since it has no hotspot mode.
 - c. When 10-g product specific 10g SAR is considered, SAR thresholds is specified in the procedures for SAR test reduction and exclusion should be multiplied by 2.5.

GSM Note:

1. Per KDB 941225 D01v03r01, for SAR test reduction for GSM / GPRS / EDGE modes is determined by the source-based time-averaged output power including tune-up tolerance. The mode with highest specified time-averaged output power should be tested for SAR compliance in the applicable exposure conditions. For modes with the same specified maximum output power and tolerance, the higher number time-slot configuration should be tested. Therefore, the GPRS 2Tx slots for GSM850/GSM1900 are considered as the primary mode.
2. Other configurations of GSM / GPRS / EDGE are considered as secondary modes. The 3G SAR test reduction procedure is applied, when the maximum output power and tune-up tolerance specified for production units in a secondary mode is $\leq \frac{1}{4}$ dB higher than the primary mode, SAR measurement is not required for the secondary mode.

WCDMA Note:

1. Per KDB 941225 D01v03r01, for SAR testing is measured using a 12.2 kbps RMC with TPC bits configured to all "1's".
2. Per KDB 941225 D01v03r01, RMC 12.2kbps setting is used to evaluate SAR. The maximum output power and tune-up tolerance specified for production units in HSDPA / HSUPA / DC-HSDPA / HSPA+ is $\leq \frac{1}{4}$ dB higher than RMC 12.2Kbps or when the highest reported SAR of the RMC12.2Kbps is scaled by the ratio of specified maximum output power and tune-up tolerance of HSDPA / HSUPA / DC-HSDPA / HSPA+ to RMC12.2Kbps and the adjusted SAR is ≤ 1.2 W/kg, SAR measurement is not required for HSDPA / HSUPA / DC-HSDPA / HSPA+, and according to the following RF output power, the output power results of the secondary modes (HSDPA / HSUPA / DC-HSDPA / HSPA+) are less than $\frac{1}{4}$ dB higher than the primary modes; therefore, SAR measurement is not required for HSDPA / HSUPA / DC-HSDPA / HSPA+.

LTE Note:

1. Per KDB 941225 D05v02r05, start with the largest channel bandwidth and measure SAR for QPSK with 1 RB allocation, using the RB offset and required test channel combination with the highest maximum output power for RB offsets at the upper edge, middle and lower edge of each required test channel.
2. Per KDB 941225 D05v02r05, 50% RB allocation for QPSK SAR testing follows 1RB QPSK allocation procedure.
3. Per KDB 941225 D05v02r05, for QPSK with 100% RB allocation, SAR is not required when the highest maximum output power for 100 % RB allocation is less than the highest maximum output power in 50% and 1 RB allocations and the highest reported SAR for 1 RB and 50% RB allocation are ≤ 0.8 W/kg. Otherwise, SAR is measured for the highest output power channel; and if the reported SAR is > 1.45 W/kg, the remaining required test channels must also be tested.
4. Per KDB 941225 D05v02r05, 16QAM/64QAM output power for each RB allocation configuration is $>$ not $\frac{1}{2}$ dB higher than the same configuration in QPSK and the reported SAR for the QPSK configuration is ≤ 1.45 W/kg; Per KDB 941225 D05v02r05, 16QAM/64QAM SAR testing is not required.
5. Per KDB 941225 D05v02r05, smaller bandwidth output power for each RB allocation configuration is $>$ not $\frac{1}{2}$ dB higher than the same configuration in the largest supported bandwidth, and the reported SAR for the largest supported bandwidth is ≤ 1.45 W/kg; Per KDB 941225 D05v02r05, smaller bandwidth SAR testing is not required.
6. For LTE B4 / B5 / B12 the maximum bandwidth does not support three non-overlapping channels, per KDB 941225 D05v02r05, when a device supports overlapping channel assignment in a channel bandwidth configuration, the middle channel of the group of overlapping channels should be selected for testing.

WLAN Note:

1. Per KDB 248227 D01v02r02, for 2.4GHz 802.11g/n SAR testing is not required when the highest reported SAR for DSSS is adjusted by the ratio of OFDM to DSSS specified maximum output power and the adjusted SAR is ≤ 1.2 W/kg.
2. Per KDB 248227 D01v02r02, U-NII-1 SAR testing is not required when the U-NII-2A band highest reported SAR for a test configuration is ≤ 1.2 W/kg, SAR is not required for U-NII-1 band.
3. When the reported SAR of the test position is > 0.4 W/kg, SAR is repeated for the 802.11 transmission mode configuration tested in the initial test position to measure the subsequent next closet/smallest test separation distance and maximum coupling test position on the highest maximum output power channel, until the report SAR is ≤ 0.8 W/kg or all required test position are tested.
4. For all positions / configurations, when the reported SAR is > 0.8 W/kg, SAR is measured for these test positions / configurations on the subsequent next highest measured output power channel(s) until the reported SAR is ≤ 1.2 W/kg or all required channels are tested.
5. During SAR testing the WLAN transmission was verified using a spectrum analyzer.



14.1 Head SAR

<GSM SAR>

Plot No.	Band	Mode	Test Position	Power Reduction	Ch.	Freq. (MHz)	Average Power (dBm)	Tune-Up Limit (dBm)	Tune-up Scaling Factor	Power Drift (dB)	Measured 1g SAR (W/kg)	Reported 1g SAR (W/kg)
	GSM850	GPRS(2 Tx slots)	Right Cheek	Full	251	848.8	30.87	31.50	1.156	-0.11	0.414	0.479
	GSM850	GPRS(2 Tx slots)	Right Tilted	Full	251	848.8	30.87	31.50	1.156	0.11	0.172	0.199
01	GSM850	GPRS(2 Tx slots)	Left Cheek	Full	251	848.8	30.87	31.50	1.156	-0.07	0.447	0.517
	GSM850	GPRS(2 Tx slots)	Left Tilted	Full	251	848.8	30.87	31.50	1.156	0.09	0.189	0.219
02	GSM1900	GPRS(2 Tx slots)	Right Cheek	Full	661	1880	28.13	29.00	1.222	0.08	0.030	0.037
	GSM1900	GPRS(2 Tx slots)	Right Tilted	Full	661	1880	28.13	29.00	1.222	0.06	0.016	0.019
	GSM1900	GPRS(2 Tx slots)	Left Cheek	Full	661	1880	28.13	29.00	1.222	0.05	0.024	0.029
	GSM1900	GPRS(2 Tx slots)	Left Tilted	Full	661	1880	28.13	29.00	1.222	0.12	0.017	0.021

<WCDMA SAR>

Plot No.	Band	Mode	Test Position	Power Reduction	Ch.	Freq. (MHz)	Average Power (dBm)	Tune-Up Limit (dBm)	Tune-up Scaling Factor	Power Drift (dB)	Measured 1g SAR (W/kg)	Reported 1g SAR (W/kg)
03	WCDMA V	RMC 12.2Kbps	Right Cheek	Reduced	4233	846.6	19.76	21.00	1.330	0.03	0.495	0.659
	WCDMA V	RMC 12.2Kbps	Right Tilted	Reduced	4233	846.6	19.76	21.00	1.330	0.05	0.421	0.560
	WCDMA V	RMC 12.2Kbps	Left Cheek	Reduced	4233	846.6	19.76	21.00	1.330	-0.02	0.397	0.528
	WCDMA V	RMC 12.2Kbps	Left Tilted	Reduced	4233	846.6	19.76	21.00	1.330	0.13	0.311	0.414
04	WCDMA IV	RMC 12.2Kbps	Right Cheek	Full	1312	1712.4	22.79	24.00	1.321	-0.15	0.138	0.182
	WCDMA IV	RMC 12.2Kbps	Right Tilted	Full	1312	1712.4	22.79	24.00	1.321	0.11	0.098	0.130
	WCDMA IV	RMC 12.2Kbps	Left Cheek	Full	1312	1712.4	22.79	24.00	1.321	0.12	0.071	0.094
	WCDMA IV	RMC 12.2Kbps	Left Tilted	Full	1312	1712.4	22.79	24.00	1.321	0.15	0.076	0.100
05	WCDMA II	RMC 12.2Kbps	Right Cheek	Full	9400	1880	23.14	24.00	1.219	-0.04	0.041	0.050
	WCDMA II	RMC 12.2Kbps	Right Tilted	Full	9400	1880	23.14	24.00	1.219	0.01	0.017	0.021
	WCDMA II	RMC 12.2Kbps	Left Cheek	Full	9400	1880	23.14	24.00	1.219	0.05	0.035	0.042
	WCDMA II	RMC 12.2Kbps	Left Tilted	Full	9400	1880	23.14	24.00	1.219	0.07	0.030	0.036



<LTE SAR>

Plot No.	Band	BW (MHz)	Modulation	RB Size	RB offset	Test Position	Power Reduction	Ch.	Freq. (MHz)	Average Power (dBm)	Tune-Up Limit (dBm)	Tune-up Scaling Factor	Power Drift (dB)	Measured 1g SAR (W/kg)	Reported 1g SAR (W/kg)
	LTE Band 12	1.4M	QPSK	1	3	Right Cheek	Full	23095	707.5	22.10	23.50	1.380	-0.01	0.141	0.195
	LTE Band 12	1.4M	QPSK	1	3	Right Tilted	Full	23095	707.5	22.10	23.50	1.380	0.12	0.059	0.081
	LTE Band 12	1.4M	QPSK	1	3	Left Cheek	Full	23095	707.5	22.10	23.50	1.380	0.17	0.150	0.207
	LTE Band 12	1.4M	QPSK	1	3	Left Tilted	Full	23095	707.5	22.10	23.50	1.380	0.09	0.071	0.098
	LTE Band 12	1.4M	QPSK	3	1	Right Cheek	Full	23095	707.5	24.18	25.50	1.355	0.17	0.223	0.302
	LTE Band 12	1.4M	QPSK	3	1	Right Tilted	Full	23095	707.5	24.18	25.50	1.355	0.12	0.100	0.136
06	LTE Band 12	1.4M	QPSK	3	1	Left Cheek	Full	23095	707.5	24.18	25.50	1.355	0.15	0.252	0.342
	LTE Band 12	1.4M	QPSK	3	1	Left Tilted	Full	23095	707.5	24.18	25.50	1.355	0.02	0.115	0.156
	LTE Band 14	10M	QPSK	1	25	Right Cheek	Full	23330	793	21.00	22.50	1.413	-0.12	0.117	0.165
	LTE Band 14	10M	QPSK	1	25	Right Tilted	Full	23330	793	21.00	22.50	1.413	0.12	0.057	0.081
	LTE Band 14	10M	QPSK	1	25	Left Cheek	Full	23330	793	21.00	22.50	1.413	0.02	0.124	0.175
	LTE Band 14	10M	QPSK	1	25	Left Tilted	Full	23330	793	21.00	22.50	1.413	-0.16	0.052	0.073
	LTE Band 14	10M	QPSK	25	0	Right Cheek	Full	23330	793	22.97	24.50	1.422	0.02	0.172	0.245
	LTE Band 14	10M	QPSK	25	0	Right Tilted	Full	23330	793	22.97	24.50	1.422	0.11	0.067	0.095
07	LTE Band 14	10M	QPSK	25	0	Left Cheek	Full	23330	793	22.97	24.50	1.422	0.02	0.194	0.276
	LTE Band 14	10M	QPSK	25	0	Left Tilted	Full	23330	793	22.97	24.50	1.422	0.02	0.194	0.276
	LTE Band 5	10M	QPSK	1	25	Right Cheek	Reduced	20525	836.5	21.40	22.50	1.288	0.12	0.650	0.837
	LTE Band 5	10M	QPSK	1	25	Right Tilted	Reduced	20525	836.5	21.40	22.50	1.288	0.07	0.470	0.605
	LTE Band 5	10M	QPSK	1	25	Left Cheek	Reduced	20525	836.5	21.40	22.50	1.288	-0.09	0.435	0.560
	LTE Band 5	10M	QPSK	1	25	Left Tilted	Reduced	20525	836.5	21.40	22.50	1.288	0.07	0.355	0.457
	LTE Band 5	10M	QPSK	25	0	Right Cheek	Reduced	20525	836.5	21.16	22.50	1.361	-0.03	0.596	0.811
	LTE Band 5	10M	QPSK	25	0	Right Tilted	Reduced	20525	836.5	21.16	22.50	1.361	0.06	0.428	0.583
	LTE Band 5	10M	QPSK	25	0	Left Cheek	Reduced	20525	836.5	21.16	22.50	1.361	0.05	0.405	0.551
	LTE Band 5	10M	QPSK	25	0	Left Tilted	Reduced	20525	836.5	21.16	22.50	1.361	0.08	0.325	0.442
08	LTE Band 5	10M	QPSK	50	0	Right Cheek	Reduced	20525	836.5	21.15	22.50	1.365	0.04	0.625	0.853
09	LTE Band 4	20M	QPSK	1	49	Right Cheek	Full	20175	1732.5	23.86	25.00	1.300	-0.06	0.196	0.255
	LTE Band 4	20M	QPSK	1	49	Right Tilted	Full	20175	1732.5	23.86	25.00	1.300	-0.01	0.133	0.173
	LTE Band 4	20M	QPSK	1	49	Left Cheek	Full	20175	1732.5	23.86	25.00	1.300	-0.06	0.109	0.142
	LTE Band 4	20M	QPSK	1	49	Left Tilted	Full	20175	1732.5	23.86	25.00	1.300	0.11	0.106	0.138
	LTE Band 4	20M	QPSK	50	0	Right Cheek	Full	20175	1732.5	22.81	24.00	1.315	0.08	0.156	0.205
	LTE Band 4	20M	QPSK	50	0	Right Tilted	Full	20175	1732.5	22.81	24.00	1.315	0.17	0.104	0.137
	LTE Band 4	20M	QPSK	50	0	Left Cheek	Full	20175	1732.5	22.81	24.00	1.315	-0.06	0.083	0.109
	LTE Band 4	20M	QPSK	50	0	Left Tilted	Full	20175	1732.5	22.81	24.00	1.315	-0.07	0.081	0.107
	LTE Band 66	1.4M	QPSK	1	3	Right Cheek	Full	132322	1745	20.86	22.00	1.300	0.13	0.072	0.094
	LTE Band 66	1.4M	QPSK	1	3	Right Tilted	Full	132322	1745	20.86	22.00	1.300	-0.11	0.047	0.061
	LTE Band 66	1.4M	QPSK	1	3	Left Cheek	Full	132322	1745	20.86	22.00	1.300	-0.13	0.055	0.072
	LTE Band 66	1.4M	QPSK	1	3	Left Tilted	Full	132322	1745	20.86	22.00	1.300	0.12	0.046	0.060
10	LTE Band 66	1.4M	QPSK	3	1	Right Cheek	Full	132322	1745	23.53	25.00	1.403	-0.02	0.195	0.274
	LTE Band 66	1.4M	QPSK	3	1	Right Tilted	Full	132322	1745	23.53	25.00	1.403	0.05	0.096	0.135
	LTE Band 66	1.4M	QPSK	3	1	Left Cheek	Full	132322	1745	23.53	25.00	1.403	0.08	0.110	0.154
	LTE Band 66	1.4M	QPSK	3	1	Left Tilted	Full	132322	1745	23.53	25.00	1.403	0.09	0.114	0.160
11	LTE Band 2	20M	QPSK	1	49	Right Cheek	Full	19100	1900	24.30	25.00	1.175	-0.03	0.090	0.106
	LTE Band 2	20M	QPSK	1	49	Right Tilted	Full	19100	1900	24.30	25.00	1.175	0.07	0.027	0.032
	LTE Band 2	20M	QPSK	1	49	Left Cheek	Full	19100	1900	24.30	25.00	1.175	-0.05	0.060	0.070
	LTE Band 2	20M	QPSK	1	49	Left Tilted	Full	19100	1900	24.30	25.00	1.175	0.04	0.027	0.032
	LTE Band 2	20M	QPSK	50	0	Right Cheek	Full	19100	1900	23.19	24.00	1.205	0.12	0.053	0.064
	LTE Band 2	20M	QPSK	50	0	Right Tilted	Full	19100	1900	23.19	24.00	1.205	0.08	0.016	0.019
	LTE Band 2	20M	QPSK	50	0	Left Cheek	Full	19100	1900	23.19	24.00	1.205	-0.12	0.038	0.046
	LTE Band 2	20M	QPSK	50	0	Left Tilted	Full	19100	1900	23.19	24.00	1.205	0.09	0.017	0.020



Plot No.	Band	BW (MHz)	Modulation	RB Size	RB offset	Test Position	Power Reduction	Ch.	Freq. (MHz)	Average Power (dBm)	Tune-Up Limit (dBm)	Tune-up Scaling Factor	Power Drift (dB)	Measured 1g SAR (W/kg)	Reported 1g SAR (W/kg)
	LTE Band 30	10M	QPSK	1	25	Right Cheek	Full	27710	2310	19.09	20.50	1.384	0.05	0.135	0.187
	LTE Band 30	10M	QPSK	1	25	Right Tilted	Full	27710	2310	19.09	20.50	1.384	0.15	0.085	0.118
	LTE Band 30	10M	QPSK	1	25	Left Cheek	Full	27710	2310	19.09	20.50	1.384	0.07	0.107	0.148
	LTE Band 30	10M	QPSK	1	25	Left Tilted	Full	27710	2310	19.09	20.50	1.384	0.06	0.110	0.152
12	LTE Band 30	10M	QPSK	25	12	Right Cheek	Full	27710	2310	21.15	22.50	1.365	-0.02	0.219	0.299
	LTE Band 30	10M	QPSK	25	12	Right Tilted	Full	27710	2310	21.15	22.50	1.365	0.08	0.137	0.187
	LTE Band 30	10M	QPSK	25	12	Left Cheek	Full	27710	2310	21.15	22.50	1.365	0.13	0.178	0.243
	LTE Band 30	10M	QPSK	25	12	Left Tilted	Full	27710	2310	21.15	22.50	1.365	0.12	0.135	0.184

<WLAN2.4G SAR>

Plot No.	Band	Mode	Test Position	Power Reduction	Ch.	Freq. (MHz)	Average Power (dBm)	Tune-Up Limit (dBm)	Tune-up Scaling Factor	Duty Cycle %	Duty Cycle Scaling Factor	Power Drift (dB)	Measured 1g SAR (W/kg)	Reported 1g SAR (W/kg)
	WLAN2.4GHz	802.11b 1Mbps	Right Cheek	Full	11	2462	17.20	18.00	1.202	100	1.000	0.11	0.256	0.308
	WLAN2.4GHz	802.11b 1Mbps	Right Tilted	Full	11	2462	17.20	18.00	1.202	100	1.000	0.17	0.212	0.255
13	WLAN2.4GHz	802.11b 1Mbps	Left Cheek	Full	11	2462	17.20	18.00	1.202	100	1.000	0.16	0.637	0.766
	WLAN2.4GHz	802.11b 1Mbps	Left Tilted	Full	11	2462	17.20	18.00	1.202	100	1.000	0.05	0.480	0.577

<WLAN5G SAR>

Plot No.	Band	Mode	Test Position	Power Reduction	Ch.	Freq. (MHz)	Average Power (dBm)	Tune-Up Limit (dBm)	Tune-up Scaling Factor	Duty Cycle %	Duty Cycle Scaling Factor	Power Drift (dB)	Measured 1g SAR (W/kg)	Reported 1g SAR (W/kg)
	WLAN5.3GHz	802.11a 6Mbps	Right Cheek	Reduced	60	5300	11.90	13.00	1.288	100	1.000	0.11	0.144	0.186
	WLAN5.3GHz	802.11a 6Mbps	Right Tilted	Reduced	60	5300	11.90	13.00	1.288	100	1.000	0.14	0.173	0.223
	WLAN5.3GHz	802.11a 6Mbps	Left Cheek	Reduced	60	5300	11.90	13.00	1.288	100	1.000	0.15	0.189	0.243
14	WLAN5.3GHz	802.11a 6Mbps	Left Tilted	Reduced	60	5300	11.90	13.00	1.288	100	1.000	0.01	0.190	0.245
	WLAN5.5GHz	802.11ac-VHT80 MCS0	Right Cheek	Reduced	106	5530	11.77	13.00	1.327	100	1.000	0.14	0.334	0.443
	WLAN5.5GHz	802.11ac-VHT80 MCS0	Right Tilted	Reduced	106	5530	11.77	13.00	1.327	100	1.000	0.04	0.427	0.567
	WLAN5.5GHz	802.11ac-VHT80 MCS0	Left Cheek	Reduced	106	5530	11.77	13.00	1.327	100	1.000	0.05	0.384	0.510
15	WLAN5.5GHz	802.11ac-VHT80 MCS0	Left Tilted	Reduced	106	5530	11.77	13.00	1.327	100	1.000	0.06	0.444	0.589
	WLAN5.8GHz	802.11a 6Mbps	Right Cheek	Reduced	165	5825	11.71	13.00	1.346	100	1.000	0.06	0.476	0.641
	WLAN5.8GHz	802.11a 6Mbps	Right Tilted	Reduced	165	5825	11.71	13.00	1.346	100	1.000	0.04	0.545	0.733
	WLAN5.8GHz	802.11a 6Mbps	Left Cheek	Reduced	165	5825	11.71	13.00	1.346	100	1.000	0.03	0.493	0.664
16	WLAN5.8GHz	802.11a 6Mbps	Left Tilted	Reduced	165	5825	11.71	13.00	1.346	100	1.000	-0.04	0.562	0.756

<Bluetooth SAR>

Plot No.	Band	Mode	Test Position	Power Reduction	Ch.	Freq. (MHz)	Average Power (dBm)	Tune-Up Limit (dBm)	Tune-up Scaling Factor	Duty Cycle %	Duty Cycle Scaling Factor	Power Drift (dB)	Measured 1g SAR (W/kg)	Reported 1g SAR (W/kg)
	Bluetooth	DH5 1Mbps	Right Cheek	Full	0	2402	9.40	10.00	1.148	76.74	1.085	0.13	0.046	0.057
	Bluetooth	DH5 1Mbps	Right Tilted	Full	0	2402	9.40	10.00	1.148	76.74	1.085	0.14	0.027	0.034
17	Bluetooth	DH5 1Mbps	Left Cheek	Full	0	2402	9.40	10.00	1.148	76.74	1.085	0.05	0.075	0.093
	Bluetooth	DH5 1Mbps	Left Tilted	Full	0	2402	9.40	10.00	1.148	76.74	1.085	0.16	0.066	0.083



14.2 Hotspot SAR

<GSM SAR>

Plot No.	Band	Mode	Test Position	Gap (mm)	Power Reduction	Ch.	Freq. (MHz)	Average Power (dBm)	Tune-Up Limit (dBm)	Tune-up Scaling Factor	Power Drift (dB)	Measured 1g SAR (W/kg)	Reported 1g SAR (W/kg)
	GSM850	GPRS(2 Tx slots)	Front	10mm	Full	251	848.8	30.87	31.50	1.156	-0.01	0.360	0.416
18	GSM850	GPRS(2 Tx slots)	Back	10mm	Full	251	848.8	30.87	31.50	1.156	-0.09	0.575	0.665
	GSM850	GPRS(2 Tx slots)	Left Side	10mm	Full	251	848.8	30.87	31.50	1.156	0.03	0.227	0.262
	GSM850	GPRS(2 Tx slots)	Right Side	10mm	Full	251	848.8	30.87	31.50	1.156	0.04	0.169	0.195
	GSM850	GPRS(2 Tx slots)	Bottom Side	10mm	Full	251	848.8	30.87	31.50	1.156	0.08	0.197	0.228
	GSM1900	GPRS(2 Tx slots)	Front	10mm	Reduced	661	1880	22.89	24.00	1.291	0.14	0.145	0.187
	GSM1900	GPRS(2 Tx slots)	Back	10mm	Reduced	661	1880	22.89	24.00	1.291	0.15	0.633	0.817
	GSM1900	GPRS(2 Tx slots)	Left Side	10mm	Reduced	661	1880	22.89	24.00	1.291	0.12	0.016	0.021
	GSM1900	GPRS(2 Tx slots)	Right Side	10mm	Reduced	661	1880	22.89	24.00	1.291	-0.14	0.016	0.021
	GSM1900	GPRS(2 Tx slots)	Bottom Side	10mm	Reduced	661	1880	22.89	24.00	1.291	0.09	0.466	0.602
	GSM1900	GPRS(2 Tx slots)	Back	10mm	Reduced	512	1850.2	22.68	24.00	1.355	0.08	0.477	0.646
19	GSM1900	GPRS(2 Tx slots)	Back	10mm	Reduced	810	1909.8	22.86	24.00	1.300	0.08	0.836	1.087

<WCDMA SAR>

Plot No.	Band	Mode	Test Position	Gap (mm)	Power Reduction	Ch.	Freq. (MHz)	Average Power (dBm)	Tune-Up Limit (dBm)	Tune-up Scaling Factor	Power Drift (dB)	Measured 1g SAR (W/kg)	Reported 1g SAR (W/kg)
	WCDMA V	RMC 12.2Kbps	Front	10mm	Full	4233	846.6	22.85	24.00	1.303	0.01	0.172	0.224
20	WCDMA V	RMC 12.2Kbps	Back	10mm	Full	4233	846.6	22.85	24.00	1.303	0.06	0.330	0.430
	WCDMA V	RMC 12.2Kbps	Left Side	10mm	Full	4233	846.6	22.85	24.00	1.303	0.08	0.101	0.132
	WCDMA V	RMC 12.2Kbps	Right Side	10mm	Full	4233	846.6	22.85	24.00	1.303	0.11	0.104	0.136
	WCDMA V	RMC 12.2Kbps	Top Side	10mm	Full	4233	846.6	22.85	24.00	1.303	0.12	0.155	0.202
	WCDMA IV	RMC 12.2Kbps	Front	10mm	Reduced	1312	1712.4	18.93	20.00	1.279	0.11	0.271	0.347
21	WCDMA IV	RMC 12.2Kbps	Back	10mm	Reduced	1312	1712.4	18.93	20.00	1.279	-0.07	0.826	1.057
	WCDMA IV	RMC 12.2Kbps	Left Side	10mm	Reduced	1312	1712.4	18.93	20.00	1.279	0.12	0.022	0.028
	WCDMA IV	RMC 12.2Kbps	Right Side	10mm	Reduced	1312	1712.4	18.93	20.00	1.279	0.13	0.044	0.056
	WCDMA IV	RMC 12.2Kbps	Bottom Side	10mm	Reduced	1312	1712.4	18.93	20.00	1.279	0.09	0.719	0.920
	WCDMA IV	RMC 12.2Kbps	Back	10mm	Reduced	1413	1732.6	18.92	20.00	1.282	0.11	0.727	0.932
	WCDMA IV	RMC 12.2Kbps	Back	10mm	Reduced	1513	1752.6	18.90	20.00	1.288	0.12	0.638	0.822
	WCDMA IV	RMC 12.2Kbps	Bottom Side	10mm	Reduced	1413	1732.6	18.92	20.00	1.282	0.04	0.709	0.909
	WCDMA IV	RMC 12.2Kbps	Bottom Side	10mm	Reduced	1513	1752.6	18.90	20.00	1.288	0.05	0.630	0.812
	WCDMA II	RMC 12.2Kbps	Front	10mm	Reduced	9400	1880	18.05	19.00	1.245	0.13	0.240	0.299
	WCDMA II	RMC 12.2Kbps	Back	10mm	Reduced	9400	1880	18.05	19.00	1.245	0.14	0.873	1.086
	WCDMA II	RMC 12.2Kbps	Left Side	10mm	Reduced	9400	1880	18.05	19.00	1.245	0.15	0.029	0.036
	WCDMA II	RMC 12.2Kbps	Right Side	10mm	Reduced	9400	1880	18.05	19.00	1.245	-0.05	0.035	0.043
	WCDMA II	RMC 12.2Kbps	Bottom Side	10mm	Reduced	9400	1880	18.05	19.00	1.245	0.06	0.768	0.956
	WCDMA II	RMC 12.2Kbps	Back	10mm	Reduced	9262	1852.4	17.95	19.00	1.274	0.07	0.744	0.947
22	WCDMA II	RMC 12.2Kbps	Back	10mm	Reduced	9538	1907.6	18.02	19.00	1.253	0.03	1.040	1.303
	WCDMA II	RMC 12.2Kbps	Bottom Side	10mm	Reduced	9262	1852.4	17.95	19.00	1.274	0.08	0.635	0.809
	WCDMA II	RMC 12.2Kbps	Bottom Side	10mm	Reduced	9538	1907.6	18.02	19.00	1.253	0.09	0.932	1.168



<LTE SAR>

Plot No.	Band	BW (MHz)	Modulation	RB Size	RB offset	Test Position	Gap (mm)	Power Reduction	Ch.	Freq. (MHz)	Average Power (dBm)	Tune-Up Limit (dBm)	Tune-up Scaling Factor	Power Drift (dB)	Measured 1g SAR (W/kg)	Reported 1g SAR (W/kg)
	LTE Band 12	1.4M	QPSK	1	3	Front	10mm	Full	23095	707.5	22.10	23.50	1.380	0.12	0.145	0.200
	LTE Band 12	1.4M	QPSK	1	3	Back	10mm	Full	23095	707.5	22.10	23.50	1.380	0.11	0.188	0.260
	LTE Band 12	1.4M	QPSK	1	3	Left Side	10mm	Full	23095	707.5	22.10	23.50	1.380	0.13	0.169	0.233
	LTE Band 12	1.4M	QPSK	1	3	Right Side	10mm	Full	23095	707.5	22.10	23.50	1.380	0.03	0.176	0.243
	LTE Band 12	1.4M	QPSK	1	3	Bottom Side	10mm	Full	23095	707.5	22.10	23.50	1.380	0.04	0.027	0.038
	LTE Band 12	1.4M	QPSK	3	1	Front	10mm	Full	23095	707.5	24.18	25.50	1.355	0.05	0.218	0.295
23	LTE Band 12	1.4M	QPSK	3	1	Back	10mm	Full	23095	707.5	24.18	25.50	1.355	0.05	0.274	0.371
	LTE Band 12	1.4M	QPSK	3	1	Left Side	10mm	Full	23095	707.5	24.18	25.50	1.355	0.15	0.256	0.347
	LTE Band 12	1.4M	QPSK	3	1	Right Side	10mm	Full	23095	707.5	24.18	25.50	1.355	0.13	0.273	0.370
	LTE Band 12	1.4M	QPSK	3	1	Bottom Side	10mm	Full	23095	707.5	24.18	25.50	1.355	0.03	0.048	0.065
	LTE Band 14	10M	QPSK	1	25	Front	10mm	Full	23330	793	21.00	22.50	1.413	0.03	0.119	0.168
	LTE Band 14	10M	QPSK	1	25	Back	10mm	Full	23330	793	21.00	22.50	1.413	0.12	0.170	0.240
	LTE Band 14	10M	QPSK	1	25	Left Side	10mm	Full	23330	793	21.00	22.50	1.413	0.12	0.110	0.155
	LTE Band 14	10M	QPSK	1	25	Right Side	10mm	Full	23330	793	21.00	22.50	1.413	0.17	0.105	0.148
	LTE Band 14	10M	QPSK	1	25	Bottom Side	10mm	Full	23330	793	21.00	22.50	1.413	0.07	0.051	0.072
	LTE Band 14	10M	QPSK	25	0	Front	10mm	Full	23330	793	22.97	24.50	1.422	0.08	0.182	0.259
24	LTE Band 14	10M	QPSK	25	0	Back	10mm	Full	23330	793	22.97	24.50	1.422	-0.03	0.373	0.531
	LTE Band 14	10M	QPSK	25	0	Left Side	10mm	Full	23330	793	22.97	24.50	1.422	0.07	0.166	0.236
	LTE Band 14	10M	QPSK	25	0	Right Side	10mm	Full	23330	793	22.97	24.50	1.422	0.14	0.263	0.374
	LTE Band 14	10M	QPSK	25	0	Bottom Side	10mm	Full	23330	793	22.97	24.50	1.422	0.15	0.064	0.091
	LTE Band 5	10M	QPSK	1	25	Front	10mm	Full	20525	836.5	24.18	25.50	1.355	0.01	0.287	0.389
25	LTE Band 5	10M	QPSK	1	25	Back	10mm	Full	20525	836.5	24.18	25.50	1.355	0.08	0.531	0.720
	LTE Band 5	10M	QPSK	1	25	Left Side	10mm	Full	20525	836.5	24.18	25.50	1.355	0.06	0.172	0.233
	LTE Band 5	10M	QPSK	1	25	Right Side	10mm	Full	20525	836.5	24.18	25.50	1.355	0.07	0.192	0.260
	LTE Band 5	10M	QPSK	1	25	Top Side	10mm	Full	20525	836.5	24.18	25.50	1.355	0.08	0.389	0.527
	LTE Band 5	10M	QPSK	25	0	Front	10mm	Full	20525	836.5	23.21	24.50	1.346	0.11	0.186	0.250
	LTE Band 5	10M	QPSK	25	0	Back	10mm	Full	20525	836.5	23.21	24.50	1.346	-0.12	0.368	0.495
	LTE Band 5	10M	QPSK	25	0	Left Side	10mm	Full	20525	836.5	23.21	24.50	1.346	0.09	0.119	0.160
	LTE Band 5	10M	QPSK	25	0	Right Side	10mm	Full	20525	836.5	23.21	24.50	1.346	0.13	0.141	0.190
	LTE Band 5	10M	QPSK	25	0	Top Side	10mm	Full	20525	836.5	23.21	24.50	1.346	0.14	0.197	0.265
	LTE Band 4	20M	QPSK	1	49	Front	10mm	Reduced	20175	1732.5	20.31	21.00	1.172	-0.05	0.351	0.411
	LTE Band 4	20M	QPSK	1	49	Back	10mm	Reduced	20175	1732.5	20.31	21.00	1.172	-0.15	0.834	0.978
	LTE Band 4	20M	QPSK	1	49	Left Side	10mm	Reduced	20175	1732.5	20.31	21.00	1.172	0.01	0.030	0.036
	LTE Band 4	20M	QPSK	1	49	Right Side	10mm	Reduced	20175	1732.5	20.31	21.00	1.172	0.05	0.054	0.063
	LTE Band 4	20M	QPSK	1	49	Bottom Side	10mm	Reduced	20175	1732.5	20.31	21.00	1.172	0.03	0.815	0.955
	LTE Band 4	20M	QPSK	50	0	Front	10mm	Reduced	20175	1732.5	20.13	21.00	1.222	0.03	0.271	0.331
26	LTE Band 4	20M	QPSK	50	0	Back	10mm	Reduced	20175	1732.5	20.13	21.00	1.222	0.11	0.847	1.035
	LTE Band 4	20M	QPSK	50	0	Left Side	10mm	Reduced	20175	1732.5	20.13	21.00	1.222	0.18	0.032	0.039
	LTE Band 4	20M	QPSK	50	0	Right Side	10mm	Reduced	20175	1732.5	20.13	21.00	1.222	0.15	0.060	0.073
	LTE Band 4	20M	QPSK	50	0	Bottom Side	10mm	Reduced	20175	1732.5	20.13	21.00	1.222	0.03	0.843	1.030
	LTE Band 4	20M	QPSK	100	0	Back	10mm	Reduced	20175	1732.5	20.05	21.00	1.245	0.01	0.827	1.029
	LTE Band 4	20M	QPSK	100	0	Bottom Side	10mm	Reduced	20175	1732.5	20.05	21.00	1.245	-0.07	0.821	1.022



Plot No.	Band	BW (MHz)	Modulation	RB Size	RB offset	Test Position	Gap (mm)	Power Reduction	Ch.	Freq. (MHz)	Average Power (dBm)	Tune-Up Limit (dBm)	Tune-up Scaling Factor	Power Drift (dB)	Measured 1g SAR (W/kg)	Reported 1g SAR (W/kg)
	LTE Band 66	1.4M	QPSK	1	3	Front	10mm	Reduced	132322	1745	16.96	18.00	1.271	-0.1	0.175	0.222
	LTE Band 66	1.4M	QPSK	1	3	Back	10mm	Reduced	132322	1745	16.96	18.00	1.271	0.18	0.316	0.402
	LTE Band 66	1.4M	QPSK	1	3	Left Side	10mm	Reduced	132322	1745	16.96	18.00	1.271	0.09	0.019	0.024
	LTE Band 66	1.4M	QPSK	1	3	Right Side	10mm	Reduced	132322	1745	16.96	18.00	1.271	0.08	0.037	0.047
	LTE Band 66	1.4M	QPSK	1	3	Bottom Side	10mm	Reduced	132322	1745	16.96	18.00	1.271	0.02	0.441	0.560
	LTE Band 66	1.4M	QPSK	3	1	Front	10mm	Reduced	132322	1745	19.98	21.00	1.265	-0.01	0.346	0.438
	LTE Band 66	1.4M	QPSK	3	1	Back	10mm	Reduced	132322	1745	19.98	21.00	1.265	-0.05	0.673	0.851
	LTE Band 66	1.4M	QPSK	3	1	Left Side	10mm	Reduced	132322	1745	19.98	21.00	1.265	0.09	0.039	0.049
	LTE Band 66	1.4M	QPSK	3	1	Right Side	10mm	Reduced	132322	1745	19.98	21.00	1.265	0.12	0.079	0.100
	LTE Band 66	1.4M	QPSK	3	1	Bottom Side	10mm	Reduced	132322	1745	19.98	21.00	1.265	-0.09	0.867	1.097
	LTE Band 66	1.4M	QPSK	3	1	Back	10mm	Reduced	131979	1710.7	19.96	21.00	1.271	-0.11	0.994	1.263
	LTE Band 66	1.4M	QPSK	3	1	Back	10mm	Reduced	132665	1779.3	19.63	21.00	1.371	0.09	0.522	0.716
27	LTE Band 66	1.4M	QPSK	3	1	Bottom Side	10mm	Reduced	131979	1710.7	19.96	21.00	1.271	0.04	1.060	1.347
	LTE Band 66	1.4M	QPSK	3	1	Bottom Side	10mm	Reduced	132665	1779.3	19.63	21.00	1.371	0.12	0.772	1.058
	LTE Band 66	1.4M	QPSK	6	0	Back	10mm	Reduced	132322	1745	19.56	21.00	1.393	0.18	0.652	0.908
	LTE Band 66	1.4M	QPSK	6	0	Bottom Side	10mm	Reduced	132322	1745	19.56	21.00	1.393	0.06	0.876	1.220
	LTE Band 2	20M	QPSK	1	49	Front	10mm	Reduced	19100	1900	19.40	20.00	1.148	0.16	0.327	0.375
28	LTE Band 2	20M	QPSK	1	49	Back	10mm	Reduced	19100	1900	19.40	20.00	1.148	0.14	1.190	1.366
	LTE Band 2	20M	QPSK	1	49	Left Side	10mm	Reduced	19100	1900	19.40	20.00	1.148	0.17	0.044	0.051
	LTE Band 2	20M	QPSK	1	49	Right Side	10mm	Reduced	19100	1900	19.40	20.00	1.148	0.11	0.043	0.049
	LTE Band 2	20M	QPSK	1	49	Bottom Side	10mm	Reduced	19100	1900	19.40	20.00	1.148	-0.15	0.934	1.072
	LTE Band 2	20M	QPSK	1	49	Back	10mm	Reduced	18700	1860	18.92	20.00	1.282	-0.13	0.813	1.043
	LTE Band 2	20M	QPSK	1	49	Back	10mm	Reduced	18900	1880	19.04	20.00	1.247	-0.14	1.010	1.260
	LTE Band 2	20M	QPSK	1	49	Bottom Side	10mm	Reduced	18700	1860	18.92	20.00	1.282	-0.16	0.624	0.800
	LTE Band 2	20M	QPSK	1	49	Bottom Side	10mm	Reduced	18900	1880	19.04	20.00	1.247	-0.09	0.779	0.972
	LTE Band 2	20M	QPSK	50	0	Front	10mm	Reduced	19100	1900	19.19	20.00	1.205	0.05	0.307	0.370
	LTE Band 2	20M	QPSK	50	0	Back	10mm	Reduced	19100	1900	19.19	20.00	1.205	0.14	1.110	1.338
	LTE Band 2	20M	QPSK	50	0	Left Side	10mm	Reduced	19100	1900	19.19	20.00	1.205	0.08	0.035	0.043
	LTE Band 2	20M	QPSK	50	0	Right Side	10mm	Reduced	19100	1900	19.19	20.00	1.205	0.11	0.039	0.047
	LTE Band 2	20M	QPSK	50	0	Bottom Side	10mm	Reduced	19100	1900	19.19	20.00	1.205	0.15	0.868	1.046
	LTE Band 2	20M	QPSK	50	0	Back	10mm	Reduced	18700	1860	18.93	20.00	1.279	-0.17	0.749	0.958
	LTE Band 2	20M	QPSK	50	0	Back	10mm	Reduced	18900	1880	19.02	20.00	1.253	-0.12	0.959	1.202
	LTE Band 2	20M	QPSK	50	0	Bottom Side	10mm	Reduced	18700	1860	18.93	20.00	1.279	-0.06	0.599	0.766
	LTE Band 2	20M	QPSK	50	0	Bottom Side	10mm	Reduced	18900	1880	19.02	20.00	1.253	-0.05	0.758	0.950
	LTE Band 2	20M	QPSK	100	0	Back	10mm	Reduced	19100	1900	19.17	20.00	1.211	0.12	1.110	1.344
	LTE Band 2	20M	QPSK	100	0	Bottom Side	10mm	Reduced	19100	1900	19.17	20.00	1.211	0.14	0.895	1.083
	LTE Band 30	10M	QPSK	1	25	Front	10mm	Full	27710	2310	19.09	20.50	1.384	0.13	0.234	0.324
	LTE Band 30	10M	QPSK	1	25	Back	10mm	Full	27710	2310	19.09	20.50	1.384	-0.09	0.401	0.555
	LTE Band 30	10M	QPSK	1	25	Left Side	10mm	Full	27710	2310	19.09	20.50	1.384	-0.14	0.128	0.177
	LTE Band 30	10M	QPSK	1	25	Right Side	10mm	Full	27710	2310	19.09	20.50	1.384	-0.08	0.154	0.213
	LTE Band 30	10M	QPSK	1	25	Bottom Side	10mm	Full	27710	2310	19.09	20.50	1.384	-0.07	0.385	0.533
	LTE Band 30	10M	QPSK	25	12	Front	10mm	Full	27710	2310	21.15	22.50	1.365	0.05	0.387	0.528
29	LTE Band 30	10M	QPSK	25	12	Back	10mm	Full	27710	2310	21.15	22.50	1.365	0.12	0.727	0.992
	LTE Band 30	10M	QPSK	25	12	Left Side	10mm	Full	27710	2310	21.15	22.50	1.365	0.03	0.214	0.292
	LTE Band 30	10M	QPSK	25	12	Right Side	10mm	Full	27710	2310	21.15	22.50	1.365	0.05	0.281	0.383
	LTE Band 30	10M	QPSK	25	12	Bottom Side	10mm	Full	27710	2310	21.15	22.50	1.365	0.06	0.639	0.872
	LTE Band 30	10M	QPSK	50	0	Back	10mm	Full	27710	2310	20.81	22.50	1.476	0.12	0.671	0.990
	LTE Band 30	10M	QPSK	50	0	Bottom Side	10mm	Full	27710	2310	20.81	22.50	1.476	0.17	0.623	0.919



<WLAN2.4G SAR>

Plot No.	Band	Mode	Test Position	Gap (mm)	Power Reduction	Ch.	Freq. (MHz)	Average Power (dBm)	Tune-Up Limit (dBm)	Tune-up Scaling Factor	Duty Cycle %	Duty Cycle Scaling Factor	Power Drift (dB)	Measured 1g SAR (W/kg)	Reported 1g SAR (W/kg)
	WLAN2.4GHz	802.11b 1Mbps	Front	10mm	Full	11	2462	17.20	18.00	1.202	100	1.000	0.03	0.110	0.132
30	WLAN2.4GHz	802.11b 1Mbps	Back	10mm	Full	11	2462	17.20	18.00	1.202	100	1.000	0.06	0.248	0.298
	WLAN2.4GHz	802.11b 1Mbps	Left Side	10mm	Full	11	2462	17.20	18.00	1.202	100	1.000	0.1	0.013	0.016
	WLAN2.4GHz	802.11b 1Mbps	Right Side	10mm	Full	11	2462	17.20	18.00	1.202	100	1.000	-0.1	0.141	0.170
	WLAN2.4GHz	802.11b 1Mbps	Top Side	10mm	Full	11	2462	17.20	18.00	1.202	100	1.000	0.08	0.131	0.157

<WLAN5G SAR>

Plot No.	Band	Mode	Test Position	Gap (mm)	Power Reduction	Ch.	Freq. (MHz)	Average Power (dBm)	Tune-Up Limit (dBm)	Tune-up Scaling Factor	Duty Cycle %	Duty Cycle Scaling Factor	Power Drift (dB)	Measured 1g SAR (W/kg)	Reported 1g SAR (W/kg)
	WLAN5.2GHz	802.11a 6Mbps	Front	10mm	Full	48	5240	13.70	15.00	1.349	100	1.000	0.11	0.056	0.076
31	WLAN5.2GHz	802.11a 6Mbps	Back	10mm	Full	48	5240	13.70	15.00	1.349	100	1.000	0.04	0.286	0.386
	WLAN5.2GHz	802.11a 6Mbps	Left Side	10mm	Full	48	5240	13.70	15.00	1.349	100	1.000	0.12	0.002	0.002
	WLAN5.2GHz	802.11a 6Mbps	Right Side	10mm	Full	48	5240	13.70	15.00	1.349	100	1.000	0.14	0.071	0.095
	WLAN5.2GHz	802.11a 6Mbps	Top Side	10mm	Full	48	5240	13.70	15.00	1.349	100	1.000	0.15	0.172	0.232
	WLAN5.8GHz	802.11a 6Mbps	Front	10mm	Full	165	5825	13.68	15.00	1.355	100	1.000	0.11	0.167	0.226
32	WLAN5.8GHz	802.11a 6Mbps	Back	10mm	Full	165	5825	13.68	15.00	1.355	100	1.000	-0.07	0.493	0.668
	WLAN5.8GHz	802.11a 6Mbps	Left Side	10mm	Full	165	5825	13.68	15.00	1.355	100	1.000	0.14	0.018	0.025
	WLAN5.8GHz	802.11a 6Mbps	Right Side	10mm	Full	165	5825	13.68	15.00	1.355	100	1.000	-0.14	0.093	0.126
	WLAN5.8GHz	802.11a 6Mbps	Top Side	10mm	Full	165	5825	13.68	15.00	1.355	100	1.000	0.04	0.467	0.633

<Bluetooth SAR>

Plot No.	Band	Mode	Test Position	Gap (mm)	Power Reduction	Ch.	Freq. (MHz)	Average Power (dBm)	Tune-Up Limit (dBm)	Tune-up Scaling Factor	Duty Cycle %	Duty Cycle Scaling Factor	Power Drift (dB)	Measured 1g SAR (W/kg)	Reported 1g SAR (W/kg)
	Bluetooth	DH5 1Mbps	Front	10mm	Full	0	2402	9.40	10.00	1.148	76.74	1.303	0.1	0.016	0.023
33	Bluetooth	DH5 1Mbps	Back	10mm	Full	0	2402	9.40	10.00	1.148	76.74	1.303	0.02	0.031	0.046
	Bluetooth	DH5 1Mbps	Left Side	10mm	Full	0	2402	9.40	10.00	1.148	76.74	1.303	0.14	0.001	0.001
	Bluetooth	DH5 1Mbps	Right Side	10mm	Full	0	2402	9.40	10.00	1.148	76.74	1.303	0.11	0.023	0.034
	Bluetooth	DH5 1Mbps	Top Side	10mm	Full	0	2402	9.40	10.00	1.148	76.74	1.303	0.09	0.020	0.031



14.3 Body Worn Accessory SAR

<GSM SAR>

Plot No.	Band	Mode	Test Position	Gap (mm)	Power Reduction	Ch.	Freq. (MHz)	Average Power (dBm)	Tune-Up Limit (dBm)	Tune-up Scaling Factor	Power Drift (dB)	Measured 1g SAR (W/kg)	Reported 1g SAR (W/kg)
	GSM850	GPRS(2 Tx slots)	Front	15mm	Full	251	848.8	30.87	31.50	1.156	0.02	0.281	0.325
34	GSM850	GPRS(2 Tx slots)	Back	15mm	Full	251	848.8	30.87	31.50	1.156	-0.13	0.317	0.366
	GSM1900	GPRS(2 Tx slots)	Front	15mm	Reduced	661	1880	25.78	27.00	1.324	0.13	0.180	0.238
	GSM1900	GPRS(2 Tx slots)	Back	15mm	Reduced	661	1880	25.78	27.00	1.324	0.14	0.606	0.803
	GSM1900	GPRS(2 Tx slots)	Back	15mm	Reduced	512	1850.2	25.63	27.00	1.371	0.15	0.449	0.616
35	GSM1900	GPRS(2 Tx slots)	Back	15mm	Reduced	810	1909.8	25.77	27.00	1.327	0.01	0.854	1.134

<WCDMA SAR>

Plot No.	Band	Mode	Test Position	Gap (mm)	Power Reduction	Ch.	Freq. (MHz)	Average Power (dBm)	Tune-Up Limit (dBm)	Tune-up Scaling Factor	Power Drift (dB)	Measured 1g SAR (W/kg)	Reported 1g SAR (W/kg)
	WCDMA V	RMC 12.2Kbps	Front	15mm	Full	4233	846.6	22.85	24.00	1.303	0.11	0.103	0.134
36	WCDMA V	RMC 12.2Kbps	Back	15mm	Full	4233	846.6	22.85	24.00	1.303	0.04	0.184	0.240
	WCDMA IV	RMC 12.2Kbps	Front	15mm	Reduced	1312	1712.4	21.78	23.00	1.324	0.12	0.258	0.342
37	WCDMA IV	RMC 12.2Kbps	Back	15mm	Reduced	1312	1712.4	21.78	23.00	1.324	0.09	0.791	1.048
	WCDMA IV	RMC 12.2Kbps	Back	15mm	Reduced	1413	1732.6	21.75	23.00	1.334	0.14	0.691	0.921
	WCDMA IV	RMC 12.2Kbps	Back	15mm	Reduced	1513	1752.6	21.68	23.00	1.355	0.04	0.602	0.816
	WCDMA II	RMC 12.2Kbps	Front	15mm	Reduced	9400	1880	19.92	21.00	1.282	0.11	0.175	0.224
	WCDMA II	RMC 12.2Kbps	Back	15mm	Reduced	9400	1880	19.92	21.00	1.282	0.12	0.606	0.777
	WCDMA II	RMC 12.2Kbps	Back	15mm	Reduced	9262	1852.4	19.86	21.00	1.300	0.14	0.506	0.658
38	WCDMA II	RMC 12.2Kbps	Back	15mm	Reduced	9538	1907.6	19.84	21.00	1.306	-0.06	0.718	0.938



<LTE SAR>

Plot No.	Band	BW (MHz)	Modulation	RB Size	RB offset	Test Position	Gap (mm)	Power Reduction	Ch.	Freq. (MHz)	Average Power (dBm)	Tune-Up Limit (dBm)	Tune-up Scaling Factor	Power Drift (dB)	Measured 1g SAR (W/kg)	Reported 1g SAR (W/kg)
	LTE Band 12	1.4M	QPSK	1	3	Front	15mm	Full	23095	707.5	22.10	23.50	1.380	0.15	0.163	0.225
	LTE Band 12	1.4M	QPSK	1	3	Back	15mm	Full	23095	707.5	22.10	23.50	1.380	0.13	0.183	0.253
	LTE Band 12	1.4M	QPSK	3	1	Front	15mm	Full	23095	707.5	24.18	25.50	1.355	0.09	0.257	0.348
39	LTE Band 12	1.4M	QPSK	3	1	Back	15mm	Full	23095	707.5	24.18	25.50	1.355	-0.13	0.292	0.396
	LTE Band 14	10M	QPSK	1	25	Front	15mm	Full	23330	793	21.00	22.50	1.413	0.11	0.121	0.171
	LTE Band 14	10M	QPSK	1	25	Back	15mm	Full	23330	793	21.00	22.50	1.413	-0.12	0.149	0.210
	LTE Band 14	10M	QPSK	25	0	Front	15mm	Full	23330	793	22.97	24.50	1.422	0.02	0.171	0.243
40	LTE Band 14	10M	QPSK	25	0	Back	15mm	Full	23330	793	22.97	24.50	1.422	-0.14	0.203	0.289
	LTE Band 5	10M	QPSK	1	25	Front	15mm	Full	20525	836.5	24.18	25.50	1.355	0.08	0.174	0.236
41	LTE Band 5	10M	QPSK	1	25	Back	15mm	Full	20525	836.5	24.18	25.50	1.355	0.16	0.315	0.427
	LTE Band 5	10M	QPSK	25	0	Front	15mm	Full	20525	836.5	23.21	24.50	1.346	0.18	0.125	0.168
	LTE Band 5	10M	QPSK	25	0	Back	15mm	Full	20525	836.5	23.21	24.50	1.346	0.12	0.194	0.261
	LTE Band 4	20M	QPSK	1	49	Front	15mm	Reduced	20175	1732.5	23.22	24.00	1.197	-0.12	0.346	0.414
	LTE Band 4	20M	QPSK	1	49	Back	15mm	Reduced	20175	1732.5	23.22	24.00	1.197	-0.09	0.964	1.154
	LTE Band 4	20M	QPSK	50	0	Front	15mm	Reduced	20175	1732.5	23.12	24.00	1.225	0.09	0.357	0.437
	LTE Band 4	20M	QPSK	50	0	Back	15mm	Reduced	20175	1732.5	23.12	24.00	1.225	-0.09	0.892	1.092
42	LTE Band 4	20M	QPSK	100	0	Back	15mm	Reduced	20175	1732.5	23.09	24.00	1.233	0.03	0.952	1.174
	LTE Band 66	1.4M	QPSK	1	3	Front	15mm	Reduced	132322	1745	18.95	20.00	1.274	-0.03	0.124	0.158
	LTE Band 66	1.4M	QPSK	1	3	Back	15mm	Reduced	132322	1745	18.95	20.00	1.274	0.04	0.292	0.372
	LTE Band 66	1.4M	QPSK	3	1	Front	15mm	Reduced	132322	1745	21.69	23.00	1.352	0.12	0.241	0.326
	LTE Band 66	1.4M	QPSK	3	1	Back	15mm	Reduced	132322	1745	21.69	23.00	1.352	0.11	0.598	0.809
43	LTE Band 66	1.4M	QPSK	3	1	Back	15mm	Reduced	131979	1710.7	21.48	23.00	1.419	0.09	0.808	1.147
	LTE Band 66	1.4M	QPSK	3	1	Back	15mm	Reduced	132665	1779.3	21.42	23.00	1.439	0.15	0.527	0.758
	LTE Band 66	1.4M	QPSK	6	0	Back	15mm	Reduced	132322	1745	21.52	23.00	1.406	0.16	0.591	0.831
	LTE Band 2	20M	QPSK	1	49	Front	15mm	Reduced	19100	1900	21.35	22.00	1.161	0.12	0.326	0.379
	LTE Band 2	20M	QPSK	1	49	Back	15mm	Reduced	19100	1900	21.35	22.00	1.161	0.12	1.000	1.161
	LTE Band 2	20M	QPSK	1	49	Back	15mm	Reduced	18700	1860	20.88	22.00	1.294	0.02	0.776	1.004
	LTE Band 2	20M	QPSK	1	49	Back	15mm	Reduced	18900	1880	20.95	22.00	1.274	0.09	0.859	1.094
	LTE Band 2	20M	QPSK	50	0	Front	15mm	Reduced	19100	1900	21.14	22.00	1.219	0.12	0.281	0.343
	LTE Band 2	20M	QPSK	50	0	Back	15mm	Reduced	19100	1900	21.14	22.00	1.219	0.17	0.950	1.158
	LTE Band 2	20M	QPSK	50	0	Back	15mm	Reduced	18700	1860	20.90	22.00	1.288	-0.05	0.725	0.934
	LTE Band 2	20M	QPSK	50	0	Back	15mm	Reduced	18900	1880	21.01	22.00	1.256	0.07	0.851	1.069
44	LTE Band 2	20M	QPSK	100	0	Back	15mm	Reduced	19100	1900	21.12	22.00	1.225	-0.03	0.968	1.185
	LTE Band 30	10M	QPSK	1	25	Front	15mm	Full	27710	2310	19.09	20.50	1.384	0.03	0.120	0.166
	LTE Band 30	10M	QPSK	1	25	Back	15mm	Full	27710	2310	19.09	20.50	1.384	0.14	0.210	0.291
	LTE Band 30	10M	QPSK	25	12	Front	15mm	Full	27710	2310	21.15	22.50	1.365	0.15	0.203	0.277
45	LTE Band 30	10M	QPSK	25	12	Back	15mm	Full	27710	2310	21.15	22.50	1.365	0.17	0.365	0.498



<WLAN2.4G SAR>

Plot No.	Band	Mode	Test Position	Gap (mm)	Power Reduction	Ch.	Freq. (MHz)	Average Power (dBm)	Tune-Up Limit (dBm)	Tune-up Scaling Factor	Duty Cycle %	Duty Cycle Scaling Factor	Power Drift (dB)	Measured 1g SAR (W/kg)	Reported 1g SAR (W/kg)
	WLAN2.4GHz	802.11b 1Mbps	Front	15mm	Full	11	2462	17.20	18.00	1.202	100	1.000	-0.07	0.054	0.065
46	WLAN2.4GHz	802.11b 1Mbps	Back	15mm	Full	11	2462	17.20	18.00	1.202	100	1.000	-0.02	0.111	0.133

<WLAN5G SAR>

Plot No.	Band	Mode	Test Position	Gap (mm)	Power Reduction	Ch.	Freq. (MHz)	Average Power (dBm)	Tune-Up Limit (dBm)	Tune-up Scaling Factor	Duty Cycle %	Duty Cycle Scaling Factor	Power Drift (dB)	Measured 1g SAR (W/kg)	Reported 1g SAR (W/kg)
	WLAN5.3GHz	802.11a 6Mbps	Front	15mm	Full	60	5300	14.01	15.00	1.256	100	1.000	0.08	0.059	0.074
47	WLAN5.3GHz	802.11a 6Mbps	Back	15mm	Full	60	5300	14.01	15.00	1.256	100	1.000	0.09	0.246	0.309
	WLAN5.5GHz	802.11ac-VHT80 MCS0	Front	15mm	Full	106	5530	13.84	15.00	1.306	100	1.000	0.11	0.059	0.077
48	WLAN5.5GHz	802.11ac-VHT80 MCS0	Back	15mm	Full	106	5530	13.84	15.00	1.306	100	1.000	-0.09	0.298	0.389
	WLAN5.8GHz	802.11a 6Mbps	Front	15mm	Full	165	5825	13.68	15.00	1.355	100	1.000	0.12	0.115	0.156
49	WLAN5.8GHz	802.11a 6Mbps	Back	15mm	Full	165	5825	13.68	15.00	1.355	100	1.000	-0.09	0.286	0.388

<Bluetooth SAR>

Plot No.	Band	Mode	Test Position	Gap (mm)	Power Reduction	Ch.	Freq. (MHz)	Average Power (dBm)	Tune-Up Limit (dBm)	Tune-up Scaling Factor	Duty Cycle %	Duty Cycle Scaling Factor	Power Drift (dB)	Measured 1g SAR (W/kg)	Reported 1g SAR (W/kg)
	Bluetooth	DH5 1Mbps	Front	15mm	Full	0	2402	9.40	10.00	1.148	76.74	1.303	0.13	0.002	0.003
50	Bluetooth	DH5 1Mbps	Back	15mm	Full	0	2402	9.40	10.00	1.148	76.74	1.303	-0.05	0.012	0.018



14.4 Product specific 10g SAR

<GSM SAR>

Plot No.	Band	Mode	Test Position	Gap (mm)	Power Reduction	Ch.	Freq. (MHz)	Average Power (dBm)	Tune-Up Limit (dBm)	Tune-up Scaling Factor	Power Drift (dB)	Measured 10g SAR (W/kg)	Reported 10g SAR (W/kg)
	GSM1900	GPRS(2 Tx slots)	Back	0mm	Reduced	661	1880	25.78	27.00	1.324	0.04	1.790	2.371
	GSM1900	GPRS(2 Tx slots)	Back	0mm	Reduced	512	1850.2	25.63	27.00	1.371	0.03	1.560	2.139
51	GSM1900	GPRS(2 Tx slots)	Back	0mm	Reduced	810	1909.8	25.77	27.00	1.327	0.04	1.840	2.442
	GSM1900	GPRS(2 Tx slots)	Bottom Side	0mm	Reduced	661	1880	25.78	27.00	1.324	0.11	1.400	1.854

<WCDMA SAR>

Plot No.	Band	Mode	Test Position	Gap (mm)	Power Reduction	Ch.	Freq. (MHz)	Average Power (dBm)	Tune-Up Limit (dBm)	Tune-up Scaling Factor	Power Drift (dB)	Measured 10g SAR (W/kg)	Reported 10g SAR (W/kg)
	WCDMA IV	RMC 12.2Kbps	Back	0mm	Reduced	1312	1712.4	21.78	23.00	1.324	-0.14	1.250	1.655
52	WCDMA IV	RMC 12.2Kbps	Bottom Side	0mm	Reduced	1312	1712.4	21.78	23.00	1.324	0.01	1.710	2.265
	WCDMA IV	RMC 12.2Kbps	Bottom Side	0mm	Reduced	1413	1732.6	21.75	23.00	1.334	0.01	1.670	2.227
	WCDMA IV	RMC 12.2Kbps	Bottom Side	0mm	Reduced	1513	1752.6	21.68	23.00	1.355	0.02	1.670	2.263
	WCDMA II	RMC 12.2Kbps	Back	0mm	Reduced	9400	1880	19.92	21.00	1.282	0.02	1.840	2.359
	WCDMA II	RMC 12.2Kbps	Back	0mm	Reduced	9262	1852.4	19.86	21.00	1.300	0.01	1.710	2.223
53	WCDMA II	RMC 12.2Kbps	Back	0mm	Reduced	9538	1907.6	19.84	21.00	1.306	-0.03	1.920	2.508
	WCDMA II	RMC 12.2Kbps	Bottom Side	0mm	Reduced	9400	1880	19.92	21.00	1.282	0.04	1.410	1.808

<LTE SAR>

Plot No.	Band	BW (MHz)	Modulation	RB Size	RB offset	Test Position	Gap (mm)	Power Reduction	Ch.	Freq. (MHz)	Average Power (dBm)	Tune-Up Limit (dBm)	Tune-up Scaling Factor	Power Drift (dB)	Measured 10g SAR (W/kg)	Reported 10g SAR (W/kg)
	LTE Band 4	20M	QPSK	1	49	Back	0mm	Reduced	20175	1732.5	23.22	24.00	1.197	0.17	1.540	1.843
	LTE Band 4	20M	QPSK	1	49	Bottom Side	0mm	Reduced	20175	1732.5	23.22	24.00	1.197	-0.11	2.040	2.441
	LTE Band 4	20M	QPSK	50	0	Back	0mm	Reduced	20175	1732.5	23.12	24.00	1.225	-0.09	1.530	1.874
54	LTE Band 4	20M	QPSK	50	0	Bottom Side	0mm	Reduced	20175	1732.5	23.12	24.00	1.225	0.03	2.270	2.780
	LTE Band 4	20M	QPSK	100	0	Bottom Side	0mm	Reduced	20175	1732.5	23.09	24.00	1.233	-0.11	2.040	2.516
	LTE Band 66	1.4M	QPSK	1	3	Back	0mm	Reduced	132322	1745	18.95	20.00	1.274	-0.13	0.732	0.932
	LTE Band 66	1.4M	QPSK	1	3	Bottom Side	0mm	Reduced	132322	1745	18.95	20.00	1.274	0.12	0.876	1.116
	LTE Band 66	1.4M	QPSK	3	1	Back	0mm	Reduced	132322	1745	21.69	23.00	1.352	-0.01	1.490	2.015
	LTE Band 66	1.4M	QPSK	3	1	Back	0mm	Reduced	131979	1710.7	21.48	23.00	1.419	-0.06	1.220	1.731
	LTE Band 66	1.4M	QPSK	3	1	Back	0mm	Reduced	132665	1779.3	21.42	23.00	1.439	0.09	1.350	1.942
	LTE Band 66	1.4M	QPSK	3	1	Bottom Side	0mm	Reduced	132322	1745	21.69	23.00	1.352	-0.12	1.770	2.393
55	LTE Band 66	1.4M	QPSK	3	1	Bottom Side	0mm	Reduced	131979	1710.7	21.48	23.00	1.419	-0.06	1.820	2.583
	LTE Band 66	1.4M	QPSK	3	1	Bottom Side	0mm	Reduced	132665	1779.3	21.42	23.00	1.439	0.09	1.680	2.417
	LTE Band 66	1.4M	QPSK	6	0	Back	0mm	Reduced	132322	1745	21.52	23.00	1.406	0.01	1.480	2.081
	LTE Band 66	1.4M	QPSK	6	0	Bottom Side	0mm	Reduced	132322	1745	21.52	23.00	1.406	0.03	1.740	2.447
	LTE Band 2	20M	QPSK	1	49	Back	0mm	Reduced	19100	1900	21.35	22.00	1.161	-0.17	2.600	3.020
	LTE Band 2	20M	QPSK	1	49	Back	0mm	Reduced	18700	1860	20.88	22.00	1.294	-0.16	2.390	3.093
	LTE Band 2	20M	QPSK	1	49	Back	0mm	Reduced	18900	1880	20.95	22.00	1.274	0.09	2.520	3.209
	LTE Band 2	20M	QPSK	1	49	Bottom Side	0mm	Reduced	19100	1900	21.35	22.00	1.161	0.07	2.230	2.590
	LTE Band 2	20M	QPSK	1	49	Bottom Side	0mm	Reduced	18700	1860	20.88	22.00	1.294	0.04	1.780	2.304
	LTE Band 2	20M	QPSK	1	49	Bottom Side	0mm	Reduced	18900	1880	20.95	22.00	1.274	0.06	2.010	2.560
	LTE Band 2	20M	QPSK	50	0	Back	0mm	Reduced	19100	1900	21.14	22.00	1.219	0.05	2.610	3.182
	LTE Band 2	20M	QPSK	50	0	Back	0mm	Reduced	18700	1860	20.90	22.00	1.288	0.15	2.280	2.937
	LTE Band 2	20M	QPSK	50	0	Back	0mm	Reduced	18900	1880	21.01	22.00	1.256	0.13	2.620	3.291
	LTE Band 2	20M	QPSK	50	0	Bottom Side	0mm	Reduced	19100	1900	21.14	22.00	1.219	0.04	2.290	2.791
	LTE Band 2	20M	QPSK	50	0	Bottom Side	0mm	Reduced	18700	1860	20.90	22.00	1.288	0.06	1.620	2.087
	LTE Band 2	20M	QPSK	50	0	Bottom Side	0mm	Reduced	18900	1880	21.01	22.00	1.256	0.14	2.010	2.525
56	LTE Band 2	20M	QPSK	100	0	Back	0mm	Reduced	19100	1900	21.12	22.00	1.225	0.06	2.690	3.294
	LTE Band 2	20M	QPSK	100	0	Bottom Side	0mm	Reduced	19100	1900	21.12	22.00	1.225	0.04	2.340	2.866



<WLAN5G SAR>

Plot No.	Band	Mode	Test Position	Gap (mm)	Power Reduction	Ch.	Freq. (MHz)	Average Power (dBm)	Tune-Up Limit (dBm)	Tune-up Scaling Factor	Duty Cycle %	Duty Cycle Scaling Factor	Power Drift (dB)	Measured 10g SAR (W/kg)	Reported 10g SAR (W/kg)
	WLAN5.3GHz	802.11a 6Mbps	Front	0mm	Full	60	5300	14.01	15.00	1.256	100	1.000	0.09	0.135	0.170
57	WLAN5.3GHz	802.11a 6Mbps	Back	0mm	Full	60	5300	14.01	15.00	1.256	100	1.000	0.01	0.533	0.669
	WLAN5.3GHz	802.11a 6Mbps	Left Side	0mm	Full	60	5300	14.01	15.00	1.256	100	1.000	-0.1	0.317	0.398
	WLAN5.3GHz	802.11a 6Mbps	Right Side	0mm	Full	60	5300	14.01	15.00	1.256	100	1.000	0.11	0.226	0.284
	WLAN5.3GHz	802.11a 6Mbps	Top Side	0mm	Full	60	5300	14.01	15.00	1.256	100	1.000	0.12	0.369	0.463
	WLAN5.5GHz	802.11ac-VHT80 MCS0	Front	0mm	Full	106	5530	13.84	15.00	1.306	100	1.000	0.13	0.252	0.329
58	WLAN5.5GHz	802.11ac-VHT80 MCS0	Back	0mm	Full	106	5530	13.84	15.00	1.306	100	1.000	0.01	1.120	1.463
	WLAN5.5GHz	802.11ac-VHT80 MCS0	Left Side	0mm	Full	106	5530	13.84	15.00	1.306	100	1.000	0.15	0.020	0.027
	WLAN5.5GHz	802.11ac-VHT80 MCS0	Right Side	0mm	Full	106	5530	13.84	15.00	1.306	100	1.000	0.14	0.167	0.218
	WLAN5.5GHz	802.11ac-VHT80 MCS0	Top Side	0mm	Full	106	5530	13.84	15.00	1.306	100	1.000	-0.1	0.633	0.827

14.5 Repeated SAR Measurement

<1g>

No.	Band	BW (MHz)	Modulation	RB Size	RB offset	Test Position	Gap (mm)	Power Reduction	Ch.	Freq. (MHz)	Average Power (dBm)	Tune-Up Limit (dBm)	Tune-up Scaling Factor	Power Drift (dB)	Measured 1g SAR (W/kg)	Ratio	Reported 1g SAR (W/kg)
1st	LTE Band 66	1.4M	QPSK	3	1	Bottom Side	10mm	Reduced	131979	1710.7	19.96	21.00	1.271	0.04	1.060	1	1.347
2nd	LTE Band 66	1.4M	QPSK	3	1	Bottom Side	10mm	Reduced	131979	1710.7	19.96	21.00	1.271	0.11	1.050	1.010	1.334
1st	LTE Band 2	20M	QPSK	1	49	Back	10mm	Reduced	19100	1900	19.40	20.00	1.148	0.14	1.190	1	1.366
2nd	LTE Band 2	20M	QPSK	1	49	Back	10mm	Reduced	19100	1900	19.40	20.00	1.148	-0.13	1.170	1.017	1.343

<10g>

No.	Band	BW (MHz)	Modulation	RB Size	RB offset	Test Position	Gap (mm)	Power Reduction	Ch.	Freq. (MHz)	Average Power (dBm)	Tune-Up Limit (dBm)	Tune-up Scaling Factor	Power Drift (dB)	Measured 10g SAR (W/kg)	Ratio	Reported 10g SAR (W/kg)
1st	LTE Band 4	20M	QPSK	50	0	Bottom Side	0mm	Reduced	20175	1732.5	23.12	24.00	1.225	0.03	2.270	1	2.780
2nd	LTE Band 4	20M	QPSK	50	0	Bottom Side	0mm	Reduced	20175	1732.5	23.12	24.00	1.225	0.03	2.140	1.061	2.621
1st	LTE Band 2	20M	QPSK	100	0	Back	0mm	Reduced	19100	1900	21.12	22.00	1.225	0.06	2.690	1	3.294
2nd	LTE Band 2	20M	QPSK	100	0	Back	0mm	Reduced	19100	1900	21.12	22.00	1.225	0.09	2.530	1.063	3.098

General Note:

1. Per KDB 865664 D01v01r04, for each frequency band, repeated SAR measurement is required only when the measured SAR is $\geq 0.8W/kg$.
2. Per KDB 865664 D01v01r04, if the ratio among the repeated measurement is ≤ 1.2 and the measured SAR $< 1.45W/kg$, only one repeated measurement is required.
3. Per KDB 865664 D01v01r04, if the extremity repeated SAR is necessary, the same procedures should be adapted for measurements according to extremity and occupational exposure limits by applying a factor of 2.5 for extremity exposure and a factor of 5 for occupational exposure to the corresponding SAR thresholds.
4. The ratio is the difference in percentage between original and repeated *measured SAR*.
5. All measurement SAR result is scaled-up to account for tune-up tolerance and is compliant.

15. Simultaneous Transmission Analysis

No.	Simultaneous Transmission Configurations	Portable Handset			
		Head	Body-worn	Hotspot	Product specific 10g SAR
1.	GSM Voice + WLAN2.4GHz	Yes	Yes		
2.	GPRS/EDGE + WLAN2.4GHz	Yes	Yes	Yes	Yes
3.	WCDMA + WLAN2.4GHz	Yes	Yes	Yes	Yes
4.	LTE + WLAN2.4GHz	Yes	Yes	Yes	Yes
5.	GSM Voice + WLAN5.3/5.5GHz	Yes	Yes		
6.	GPRS/EDGE + WLAN5.3/5.5GHz	Yes	Yes		Yes
7.	WCDMA + WLAN5.3/5.5GHz	Yes	Yes		Yes
8.	LTE + WLAN5.3/5.5GHz	Yes	Yes		Yes
9.	GSM Voice + WLAN5.2/5.8GHz	Yes	Yes		
10.	GPRS/EDGE + WLAN5.2/5.8GHz	Yes	Yes	Yes	Yes
11.	WCDMA + WLAN5.2/5.8GHz	Yes	Yes	Yes	Yes
12.	LTE + WLAN5.2/5.8GHz	Yes	Yes	Yes	Yes
13.	GSM Voice + WLAN5.3/5.5GHz+Bluetooth	Yes	Yes		
14.	GPRS/EDGE + WLAN5.3/5.5GHz+Bluetooth	Yes	Yes		Yes
15.	WCDMA + WLAN5.3/5.5GHz+Bluetooth	Yes	Yes		Yes
16.	LTE + WLAN5.3/5.5GHz+Bluetooth	Yes	Yes		Yes
17.	GSM Voice + WLAN5.2/5.8GHz+Bluetooth	Yes	Yes		
18.	GPRS/EDGE + WLAN5.2/5.8GHz+Bluetooth	Yes	Yes	Yes	Yes
19.	WCDMA + WLAN5.2/5.8GHz+Bluetooth	Yes	Yes	Yes	Yes
20.	LTE + WLAN5.2/5.8GHz+Bluetooth	Yes	Yes	Yes	Yes
21.	WLAN5.2/5.8GHz+ Bluetooth	Yes	Yes	Yes	Yes
22.	WLAN5.3/5.5GHz + Bluetooth	Yes	Yes	Yes	Yes
23.	GSM Voice + Bluetooth	Yes	Yes		
24.	GPRS/EDGE + Bluetooth	Yes	Yes	Yes	Yes
25.	WCDMA + Bluetooth	Yes	Yes	Yes	Yes
26.	LTE + Bluetooth	Yes	Yes	Yes	Yes

General Note:

- This device supports VoIP in GPRS, EGPRS, WCDMA, and LTE (e.g. for 3rd-party VoIP), LTE supports VoLTE operation.
- EUT will choose each GSM, WCDMA and LTE according to the network signal condition; therefore, they will not operate simultaneously at any moment.
- This device 2.4GHz WLAN support hotspot operation and Bluetooth support tethering applications.
- This device 2.4GHz WLAN/ 5.2GHz WLAN/5.8GHz WLAN support hotspot operation, and 5.2GHz WLAN/5.8GHz WLAN supports WLAN Direct (GC/GO), and 5.3GHz / 5.5GHz supports WLAN Direct (GC only).
- EUT will choose either WLAN 2.4GHz or WLAN 5GHz according to the network signal condition; therefore, 2.4GHz WLAN and 5GHz WLAN will not operate simultaneously at any moment though they have independent antenna.
- WLAN 2.4GHz and Bluetooth share the same antenna so can't transmit simultaneously.
- According to the EUT character, WLAN 5GHz and Bluetooth can transmit simultaneously.
- Chose the worst zoom scan SAR of WLAN correspondingly for co-located with WWAN analysis.
- The reported SAR summation is calculated based on the same configuration and test position.
- Per KDB 447498 D01v06, simultaneous transmission SAR is compliant if,
 - 1g Scalar SAR summation < 1.6W/kg and 10g Scalar SAR summation < 4.0W/kg.
 - $SPLSR = (SAR1 + SAR2)^{1.5} / (\text{min. separation distance, mm})$, and the peak separation distance is determined from the square root of $[(x1-x2)^2 + (y1-y2)^2 + (z1-z2)^2]$, where (x1, y1, z1) and (x2, y2, z2) are the coordinates of the extrapolated peak SAR locations in the zoom scan.
 - If $SPLSR \leq 0.04$ for 1g SAR and $SPLSR \leq 0.10$ for 10g SAR, simultaneously transmission SAR measurement is not necessary.
 - Simultaneously transmission SAR measurement, and the reported multi-band 1g SAR < 1.6W/kg and 10g SAR < 4.0W/kg.
 - The SPLSR calculated results please refer to section 15.5.



15.1 Head Exposure Conditions

WWAN Band		Exposure Position	1	2	4	6	1+2 Summed 1g SAR (W/kg)	1+4 Summed 1g SAR (W/kg)	1+6 Summed 1g SAR (W/kg)	1+4+6 Summed 1g SAR (W/kg)
			WWAN 1g SAR (W/kg)	2.4GHz WLAN 1g SAR (W/kg)	5GHz WLAN 1g SAR (W/kg)	Bluetooth 1g SAR (W/kg)				
GSM	GSM850	Right Cheek	0.479	0.308	0.641	0.057	0.79	1.12	0.54	1.18
		Right Tilted	0.199	0.255	0.733	0.034	0.45	0.93	0.23	0.97
		Left Cheek	0.517	0.766	0.664	0.093	1.28	1.18	0.61	1.27
		Left Tilted	0.219	0.577	0.756	0.083	0.80	0.98	0.30	1.06
	GSM1900	Right Cheek	0.037	0.308	0.641	0.057	0.35	0.68	0.09	0.74
		Right Tilted	0.019	0.255	0.733	0.034	0.27	0.75	0.05	0.79
		Left Cheek	0.029	0.766	0.664	0.093	0.80	0.69	0.12	0.79
		Left Tilted	0.021	0.577	0.756	0.083	0.60	0.78	0.10	0.86
WCDMA	WCDMA II	Right Cheek	0.050	0.308	0.641	0.057	0.36	0.69	0.11	0.75
		Right Tilted	0.021	0.255	0.733	0.034	0.28	0.75	0.06	0.79
		Left Cheek	0.042	0.766	0.664	0.093	0.81	0.71	0.14	0.80
		Left Tilted	0.036	0.577	0.756	0.083	0.61	0.79	0.12	0.88
	WCDMA IV	Right Cheek	0.182	0.308	0.641	0.057	0.49	0.82	0.24	0.88
		Right Tilted	0.130	0.255	0.733	0.034	0.39	0.86	0.16	0.90
		Left Cheek	0.094	0.766	0.664	0.093	0.86	0.76	0.19	0.85
		Left Tilted	0.100	0.577	0.756	0.083	0.68	0.86	0.18	0.94
	WCDMA V	Right Cheek	0.659	0.308	0.641	0.057	0.97	1.30	0.72	1.36
		Right Tilted	0.560	0.255	0.733	0.034	0.82	1.29	0.59	1.33
		Left Cheek	0.528	0.766	0.664	0.093	1.29	1.19	0.62	1.29
		Left Tilted	0.414	0.577	0.756	0.083	0.99	1.17	0.50	1.25
LTE	LTE Band 12	Right Cheek	0.302	0.308	0.641	0.057	0.61	0.94	0.36	1.00
		Right Tilted	0.136	0.255	0.733	0.034	0.39	0.87	0.17	0.90
		Left Cheek	0.342	0.766	0.664	0.093	1.11	1.01	0.44	1.10
		Left Tilted	0.156	0.577	0.756	0.083	0.73	0.91	0.24	1.00
	LTE Band 14	Right Cheek	0.245	0.308	0.641	0.057	0.55	0.89	0.30	0.94
		Right Tilted	0.095	0.255	0.733	0.034	0.35	0.83	0.13	0.86
		Left Cheek	0.276	0.766	0.664	0.093	1.04	0.94	0.37	1.03
		Left Tilted	0.276	0.577	0.756	0.083	0.85	1.03	0.36	1.12
	LTE Band 5	Right Cheek	0.853	0.308	0.641	0.057	1.16	1.49	0.91	1.55
		Right Tilted	0.605	0.255	0.733	0.034	0.86	1.34	0.64	1.37
		Left Cheek	0.560	0.766	0.664	0.093	1.33	1.22	0.65	1.32
		Left Tilted	0.457	0.577	0.756	0.083	1.03	1.21	0.54	1.30
	LTE Band 4	Right Cheek	0.255	0.308	0.641	0.057	0.56	0.90	0.31	0.95
		Right Tilted	0.173	0.255	0.733	0.034	0.43	0.91	0.21	0.94
		Left Cheek	0.142	0.766	0.664	0.093	0.91	0.81	0.24	0.90
		Left Tilted	0.138	0.577	0.756	0.083	0.72	0.89	0.22	0.98
	LTE Band 66	Right Cheek	0.274	0.308	0.641	0.057	0.58	0.92	0.33	0.97
		Right Tilted	0.135	0.255	0.733	0.034	0.39	0.87	0.17	0.90
		Left Cheek	0.154	0.766	0.664	0.093	0.92	0.82	0.25	0.91
		Left Tilted	0.160	0.577	0.756	0.083	0.74	0.92	0.24	1.00
	LTE Band 2	Right Cheek	0.106	0.308	0.641	0.057	0.41	0.75	0.16	0.80
		Right Tilted	0.032	0.255	0.733	0.034	0.29	0.77	0.07	0.80
		Left Cheek	0.070	0.766	0.664	0.093	0.84	0.73	0.16	0.83
		Left Tilted	0.032	0.577	0.756	0.083	0.61	0.79	0.12	0.87
	LTE Band 30	Right Cheek	0.299	0.308	0.641	0.057	0.61	0.94	0.36	1.00
		Right Tilted	0.187	0.255	0.733	0.034	0.44	0.92	0.22	0.95
		Left Cheek	0.243	0.766	0.664	0.093	1.01	0.91	0.34	1.00
		Left Tilted	0.184	0.577	0.756	0.083	0.76	0.94	0.27	1.02



15.2 Hotspot Exposure Conditions

WWAN Band	Exposure Position	1	2	4	6	1+2 Summed 1g SAR (W/kg)	1+4 Summed 1g SAR (W/kg)	1+6 Summed 1g SAR (W/kg)	1+4+6 Summed 1g SAR (W/kg)	1+2 Case No	1+2 SPLSR	1+4 Case No	1+4 SPLSR	1+4+6 Case No	1+4+6 SPLSR	
		WWAN	2.4GHz WLAN	5GHz WLAN	Bluetooth											
		1g SAR (W/kg)	1g SAR (W/kg)	1g SAR (W/kg)	1g SAR (W/kg)											
GSM	GSM850	Front	0.416	0.132	0.226	0.023	0.55	0.64	0.44	0.67						
		Back	0.665	0.298	0.668	0.046	0.96	1.33	0.71	1.38						
		Left side	0.262	0.016	0.025	0.001	0.28	0.29	0.26	0.29						
		Right side	0.195	0.170	0.126	0.034	0.37	0.32	0.23	0.36						
		Top side		0.157	0.633	0.031	0.16	0.63	0.03	0.66						
		Bottom side	0.228				0.23	0.23	0.23	0.23						
	GSM1900	Front	0.187	0.132	0.226	0.023	0.32	0.41	0.21	0.44						
		Back	1.087	0.298	0.668	0.046	1.39	1.76	1.13	1.80			*	*	#01	0.02
		Left side	0.021	0.016	0.025	0.001	0.04	0.05	0.02	0.05						
		Right side	0.021	0.170	0.126	0.034	0.19	0.15	0.06	0.18						
		Top side		0.157	0.633	0.031	0.16	0.63	0.03	0.66						
		Bottom side	0.602				0.60	0.60	0.60	0.60						
WCDMA	WCDMA II	Front	0.299	0.132	0.226	0.023	0.43	0.53	0.32	0.55						
		Back	1.303	0.298	0.668	0.046	1.60	1.97	1.35	2.02	#02	0.01	*	*	#03	0.02
		Left side	0.036	0.016	0.025	0.001	0.05	0.06	0.04	0.06						
		Right side	0.043	0.170	0.126	0.034	0.21	0.17	0.08	0.20						
		Top side		0.157	0.633	0.031	0.16	0.63	0.03	0.66						
		Bottom side	1.168				1.17	1.17	1.17	1.17						
	WCDMA IV	Front	0.347	0.132	0.226	0.023	0.48	0.57	0.37	0.60						
		Back	1.057	0.298	0.668	0.046	1.36	1.73	1.10	1.77			*	*	#04	0.01
		Left side	0.028	0.016	0.025	0.001	0.04	0.05	0.03	0.05						
		Right side	0.056	0.170	0.126	0.034	0.23	0.18	0.09	0.22						
		Top side		0.157	0.633	0.031	0.16	0.63	0.03	0.66						
		Bottom side	0.920				0.92	0.92	0.92	0.92						
	WCDMA V	Front	0.224	0.132	0.226	0.023	0.36	0.45	0.25	0.47						
		Back	0.430	0.298	0.668	0.046	0.73	1.10	0.48	1.14						
		Left side	0.132	0.016	0.025	0.001	0.15	0.16	0.13	0.16						
		Right side	0.136	0.170	0.126	0.034	0.31	0.26	0.17	0.30						
		Top side	0.202	0.157	0.633	0.031	0.36	0.84	0.23	0.87						
		Bottom side					0.00	0.00	0.00	0.00						
LTE	LTE Band 12	Front	0.295	0.132	0.226	0.023	0.43	0.52	0.32	0.54						
		Back	0.371	0.298	0.668	0.046	0.67	1.04	0.42	1.09						
		Left side	0.347	0.016	0.025	0.001	0.36	0.37	0.35	0.37						
		Right side	0.370	0.170	0.126	0.034	0.54	0.50	0.40	0.53						
		Top side		0.157	0.633	0.031	0.16	0.63	0.03	0.66						
		Bottom side	0.065				0.07	0.07	0.07	0.07						
	LTE Band 14	Front	0.259	0.132	0.226	0.023	0.39	0.49	0.28	0.51						
		Back	0.531	0.298	0.668	0.046	0.83	1.20	0.58	1.25						
		Left side	0.236	0.016	0.025	0.001	0.25	0.26	0.24	0.26						
		Right side	0.374	0.170	0.126	0.034	0.54	0.50	0.41	0.53						
		Top side		0.157	0.633	0.031	0.16	0.63	0.03	0.66						
		Bottom side	0.091				0.09	0.09	0.09	0.09						
	LTE Band 5	Front	0.389	0.132	0.226	0.023	0.52	0.62	0.41	0.64						
		Back	0.720	0.298	0.668	0.046	1.02	1.39	0.77	1.43						
		Left side	0.233	0.016	0.025	0.001	0.25	0.26	0.23	0.26						
		Right side	0.260	0.170	0.126	0.034	0.43	0.39	0.29	0.42						
		Top side	0.527	0.157	0.633	0.031	0.68	1.16	0.56	1.19						
		Bottom side					0.00	0.00	0.00	0.00						



	LTE Band 4	Front	0.411	0.132	0.226	0.023	0.54	0.64	0.43	0.66							
		Back	1.035	0.298	0.668	0.046	1.33	1.70	1.08	1.75			*	*	#05	0.01	
		Left side	0.039	0.016	0.025	0.001	0.06	0.06	0.04	0.07							
		Right side	0.073	0.170	0.126	0.034	0.24	0.20	0.11	0.23							
		Top side		0.157	0.633	0.031	0.16	0.63	0.03	0.66							
		Bottom side	1.030				1.03	1.03	1.03	1.03							
	LTE Band 66	Front	0.438	0.132	0.226	0.023	0.57	0.66	0.46	0.69							
		Back	1.263	0.298	0.668	0.046	1.56	1.93	1.31	1.98			*	*	#07	0.02	
		Left side	0.049	0.016	0.025	0.001	0.07	0.07	0.05	0.08							
		Right side	0.100	0.170	0.126	0.034	0.27	0.23	0.13	0.26							
		Top side		0.157	0.633	0.031	0.16	0.63	0.03	0.66							
		Bottom side	1.347				1.35	1.35	1.35	1.35							
	LTE Band 2	Front	0.375	0.132	0.226	0.023	0.51	0.60	0.40	0.62							
		Back	1.366	0.298	0.668	0.046	1.66	2.03	1.41	2.08	#08	0.01	*	*	#09	0.02	
		Left side	0.051	0.016	0.025	0.001	0.07	0.08	0.05	0.08							
		Right side	0.049	0.170	0.126	0.034	0.22	0.18	0.08	0.21							
		Top side		0.157	0.633	0.031	0.16	0.63	0.03	0.66							
		Bottom side	1.083				1.08	1.08	1.08	1.08							
LTE Band 30	Front	0.528	0.132	0.226	0.023	0.66	0.75	0.55	0.78								
	Back	0.992	0.298	0.668	0.046	1.29	1.66	1.04	1.71			*	*	#10	0.02		
	Left side	0.292	0.016	0.025	0.001	0.31	0.32	0.29	0.32								
	Right side	0.383	0.170	0.126	0.034	0.55	0.51	0.42	0.54								
	Top side		0.157	0.633	0.031	0.16	0.63	0.03	0.66								
	Bottom side	0.919				0.92	0.92	0.92	0.92								

***means sum SAR value is higher than 1.6W/Kg for 2 transmitters, for those bands with the same SAR value used for 3 transmitters reported table. Due to 3 transmitters value is more conservatively than 2 transmitters and SPLSR analysis for 3 transmitters can represent 2 transmitters. SPLSR analysis. So they are not required to consider 2 transmitters once more.



15.3 Body-Worn Accessory Exposure Conditions

WWAN Band		Exposure Position	1	2	4	6	1+2 Summed 1g SAR (W/kg)	1+4 Summed 1g SAR (W/kg)	1+6 Summed 1g SAR (W/kg)	1+4+6 Summed 1g SAR (W/kg)
			WWAN 1g SAR (W/kg)	2.4GHz WLAN 1g SAR (W/kg)	5GHz WLAN 1g SAR (W/kg)	Bluetooth 1g SAR (W/kg)				
GSM	GSM850	Front	0.325	0.065	0.156	0.003	0.39	0.48	0.33	0.48
		Back	0.366	0.133	0.389	0.018	0.50	0.76	0.38	0.77
	GSM1900	Front	0.238	0.065	0.156	0.003	0.30	0.39	0.24	0.40
		Back	1.134	0.133	0.389	0.018	1.27	1.52	1.15	1.54
WCDMA	WCDMA II	Front	0.224	0.065	0.156	0.003	0.29	0.38	0.23	0.38
		Back	0.938	0.133	0.389	0.018	1.07	1.33	0.96	1.35
	WCDMA IV	Front	0.342	0.065	0.156	0.003	0.41	0.50	0.35	0.50
		Back	1.048	0.133	0.389	0.018	1.18	1.44	1.07	1.46
	WCDMA V	Front	0.134	0.065	0.156	0.003	0.20	0.29	0.14	0.29
		Back	0.240	0.133	0.389	0.018	0.37	0.63	0.26	0.65
LTE	LTE Band 12	Front	0.348	0.065	0.156	0.003	0.41	0.50	0.35	0.51
		Back	0.396	0.133	0.389	0.018	0.53	0.79	0.41	0.80
	LTE Band 14	Front	0.243	0.065	0.156	0.003	0.31	0.40	0.25	0.40
		Back	0.289	0.133	0.389	0.018	0.42	0.68	0.31	0.70
	LTE Band 5	Front	0.236	0.065	0.156	0.003	0.30	0.39	0.24	0.40
		Back	0.427	0.133	0.389	0.018	0.56	0.82	0.45	0.83
	LTE Band 4	Front	0.437	0.065	0.156	0.003	0.50	0.59	0.44	0.60
		Back	1.174	0.133	0.389	0.018	1.31	1.56	1.19	1.58
	LTE Band 66	Front	0.326	0.065	0.156	0.003	0.39	0.48	0.33	0.49
		Back	1.147	0.133	0.389	0.018	1.28	1.54	1.17	1.55
	LTE Band 2	Front	0.379	0.065	0.156	0.003	0.44	0.54	0.38	0.54
		Back	1.185	0.133	0.389	0.018	1.32	1.57	1.20	1.59
	LTE Band 30	Front	0.277	0.065	0.156	0.003	0.34	0.43	0.28	0.44
		Back	0.498	0.133	0.389	0.018	0.63	0.89	0.52	0.91



15.4 Product specific 10g SAR Exposure Conditions

WWAN Band		Exposure Position	1	4	1+4 Summed 10g SAR (W/kg)	Case No	SPLSR
			WWAN 10g SAR (W/kg)	5GHz WLAN 10g SAR (W/kg)			
GSM	GSM1900	Front		0.329	0.33		
		Back	2.442	1.463	3.91		
		Left side		0.398	0.40		
		Right side		0.284	0.28		
		Top side		0.827	0.83		
		Bottom side	1.854		1.85		
WCDMA	WCDMA II	Front		0.329	0.33		
		Back	2.508	1.463	3.97		
		Left side		0.398	0.40		
		Right side		0.284	0.28		
		Top side		0.827	0.83		
		Bottom side	1.808		1.81		
	WCDMA IV	Front		0.329	0.33		
		Back	1.655	1.463	3.12		
		Left side		0.398	0.40		
		Right side		0.284	0.28		
		Top side		0.827	0.83		
		Bottom side	2.265		2.27		
LTE	LTE Band 4	Back	1.874	1.463	3.34		
		Left side		0.398	0.40		
		Right side		0.284	0.28		
		Top side		0.827	0.83		
		Bottom side	2.780		2.78		
	LTE Band 66	Front		0.329	0.33		
		Back	2.081	1.463	3.54		
		Left side		0.398	0.40		
		Right side		0.284	0.28		
		Bottom side	2.583		2.58		
	LTE Band 2	Front		0.329	0.33		
		Back	3.294	1.463	4.76	#11	0.07
		Left side		0.398	0.40		
		Right side		0.284	0.28		
		Top side		0.827	0.83		
		Bottom side	2.866		2.87		

15.5 SPLSR Evaluation and Analysis

General Note:

1. When standalone SAR is measured for both antennas in the pair, the peak location separation distance is computed by the square root of $[(x1-x2)^2 + (y1-y2)^2 + (z1-z2)^2]$, where $(x1, y1, z1)$ and $(x2, y2, z2)$ are the coordinates in the area scans or extrapolated peak SAR locations in the zoom scans, as appropriate.
2. $SPLSR = (SAR1 + SAR2)1.5 / (\text{min. separation distance, mm})$. If $SPLSR \leq 0.04$ for 1g SAR and $SPLSR \leq 0.10$ for 10g SAR, simultaneously transmission SAR measurement is not necessary.

Case #01	Band	Position	SAR (W/kg)	Gap (mm)	SAR peak location (m)			3D distance (mm)	Summed SAR (W/kg)	SPLSR Results	Simultaneous SAR
					X	Y	Z				
	GSM1900	Back	1.087	10	-0.0275	-0.084	-0.204	164.6	1.80	0.01	Not required
	WLAN5GHz		0.668	10	-0.05	0.079	-0.206				
	Bluetooth		0.046	10	-0.0554	0.0696	-0.205				
	GSM1900	Back	1.087	10	-0.0275	-0.084	-0.204	156.1	1.80	0.02	Not required
	Bluetooth		0.046	10	-0.0554	0.0696	-0.205				
	WLAN5GHz		0.668	10	-0.05	0.079	-0.206				

Test Laboratory: Sporton International Inc. SAR/HAC Testing Lab

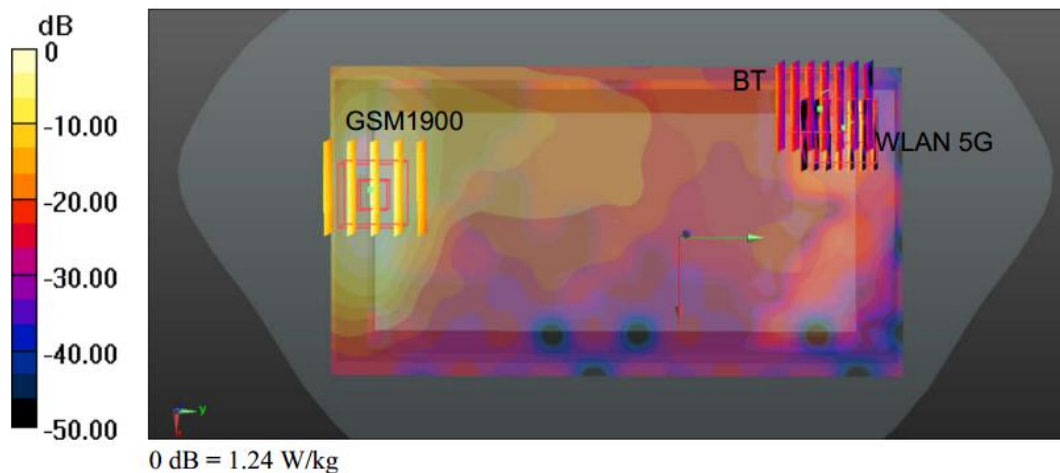

Case #02	Band	Position	SAR (W/kg)	Gap (mm)	SAR peak location (m)			3D distance (mm)	Summed SAR (W/kg)	SPLSR Results	Simultaneous SAR
					X	Y	Z				
	WCDMA II	Back	1.303	10	-0.0305	-0.084	-0.204	149.7	1.60	0.01	Not required
	WLAN2.4GHz		0.298	10	-0.047	0.0648	-0.205				

Test Laboratory: Sporton International Inc. SAR/HAC Testing Lab

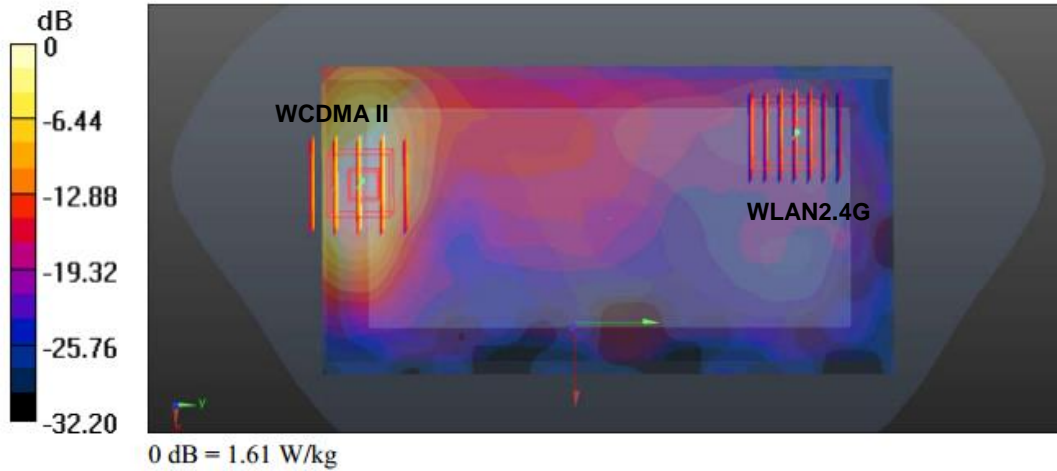

Case #03	Band	Position	SAR (W/kg)	Gap (mm)	SAR peak location (m)			3D distance (mm)	Summed SAR (W/kg)	SPLSR Results	Simultaneous SAR
					X	Y	Z				
Case #03	WCDMA II	Back	1.303	10	-0.0305	-0.084	-0.204	164.2	2.02	0.02	Not required
	WLAN5GHz		0.668	10	-0.05	0.079	-0.206				
	Bluetooth		0.046	10	-0.0554	0.0696	-0.205				
	WCDMA II	Back	1.303	10	-0.0305	-0.084	-0.204	155.6	2.02	0.02	Not required
	Bluetooth		0.046	10	-0.0554	0.0696	-0.205				
	WLAN5GHz		0.668	10	-0.05	0.079	-0.206				

Test Laboratory: Sporton International Inc. SAR/HAC Testing Lab

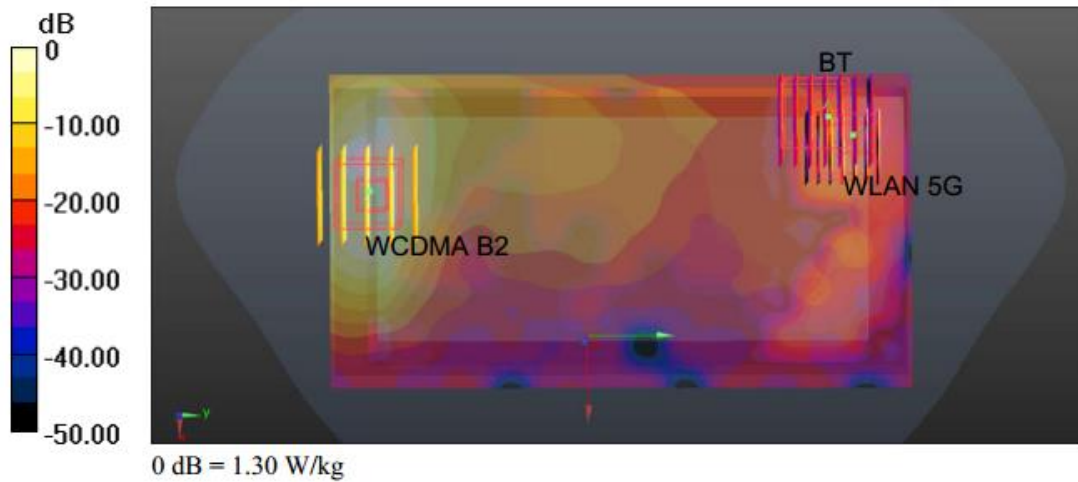

Case #04	Band	Position	SAR (W/kg)	Gap (mm)	SAR peak location (m)			3D distance (mm)	Summed SAR (W/kg)	SPLSR Results	Simultaneous SAR
					X	Y	Z				
Case #04	WCDMA IV	Back	1.057	10	-0.0335	-0.0885	-0.204	168.3	1.77	0.01	Not required
	WLAN5GHz		0.668	10	-0.05	0.079	-0.206				
	Bluetooth		0.046	10	-0.0554	0.0696	-0.205				
	WCDMA IV	Back	1.057	10	-0.0335	-0.0885	-0.204	159.6	1.77	0.01	Not required
	Bluetooth		0.046	10	-0.0554	0.0696	-0.205				
	WLAN5GHz		0.668	10	-0.05	0.079	-0.206				

Test Laboratory: Sporton International Inc. SAR/HAC Testing Lab

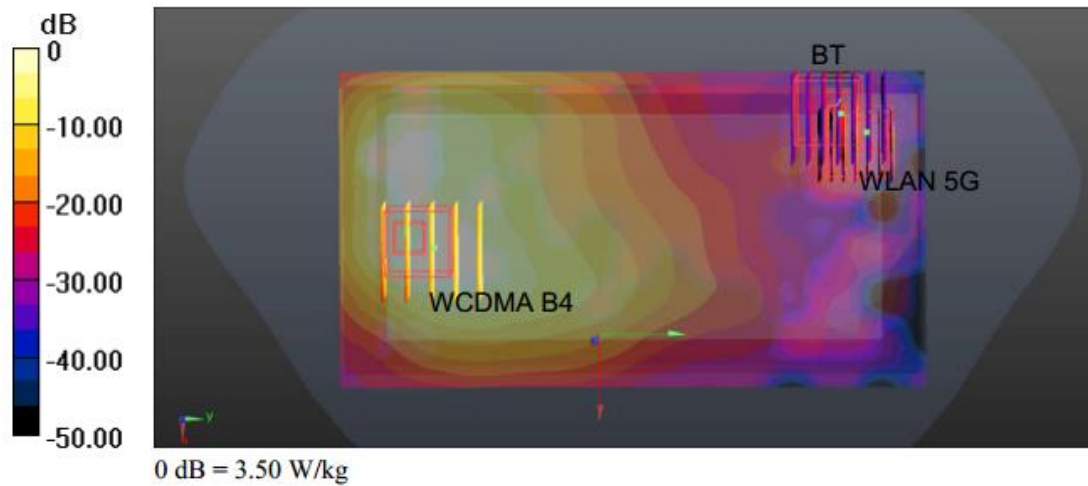

Case #05	Band	Position	SAR (W/kg)	Gap (mm)	SAR peak location (m)			3D distance (mm)	Summed SAR (W/kg)	SPLSR Results	Simultaneous SAR
					X	Y	Z				
	LTE Band 4	Back	1.035	10	-0.0215	-0.0855	-0.204	167.0	1.75	0.01	Not required
	WLAN5GHz		0.668	10	-0.05	0.079	-0.206				
	Bluetooth		0.046	10	-0.0554	0.0696	-0.205				
	LTE Band 4	Back	1.035	10	-0.0215	-0.0855	-0.204	158.8	1.75	0.01	Not required
	Bluetooth		0.046	10	-0.0554	0.0696	-0.205				
	WLAN5GHz		0.668	10	-0.05	0.079	-0.206				

Test Laboratory: Sporton International Inc. SAR/HAC Testing Lab

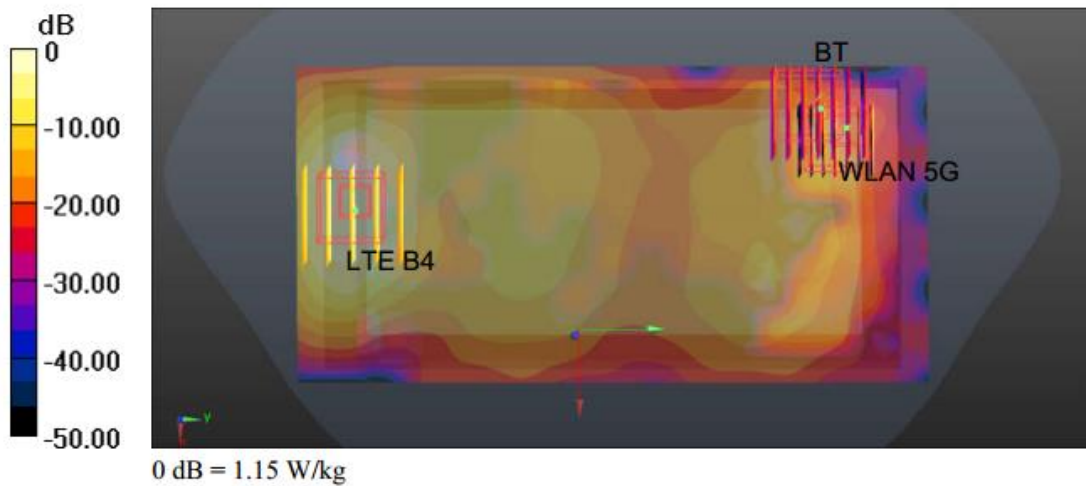

Case #07	Band	Position	SAR (W/kg)	Gap (mm)	SAR peak location (m)			3D distance (mm)	Summed SAR (W/kg)	SPLSR Results	Simultaneous SAR
					X	Y	Z				
Case #07	LTE Band 66	Back	1.263	10	-0.028	-0.0815	-0.204	162.0	1.98	0.02	Not required
	WLAN5GHz		0.668	10	-0.05	0.079	-0.206				
	Bluetooth		0.046	10	-0.0554	0.0696	-0.205				
	LTE Band 66	Back	1.263	10	-0.028	-0.0815	-0.204	153.6	1.98	0.02	Not required
	Bluetooth		0.046	10	-0.0554	0.0696	-0.205				
	WLAN5GHz		0.668	10	-0.05	0.079	-0.206				

Test Laboratory: Sporton International Inc. SAR/HAC Testing Lab

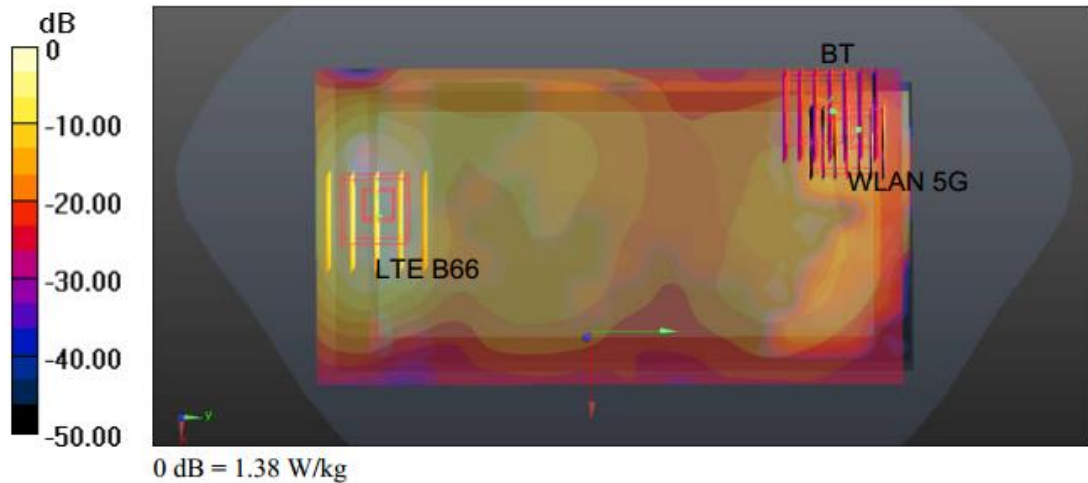

Case #08	Band	Position	SAR (W/kg)	Gap (mm)	SAR peak location (m)			3D distance (mm)	Summed SAR (W/kg)	SPLSR Results	Simultaneous SAR
					X	Y	Z				
	LTE Band 2	Back	1.366	10	-0.0275	-0.0785	-0.204	144.6	1.66	0.01	Not required
	WLAN2.4GHz		0.298	10	-0.047	0.0648	-0.205				

Test Laboratory: Sporton International Inc. SAR/HAC Testing Lab

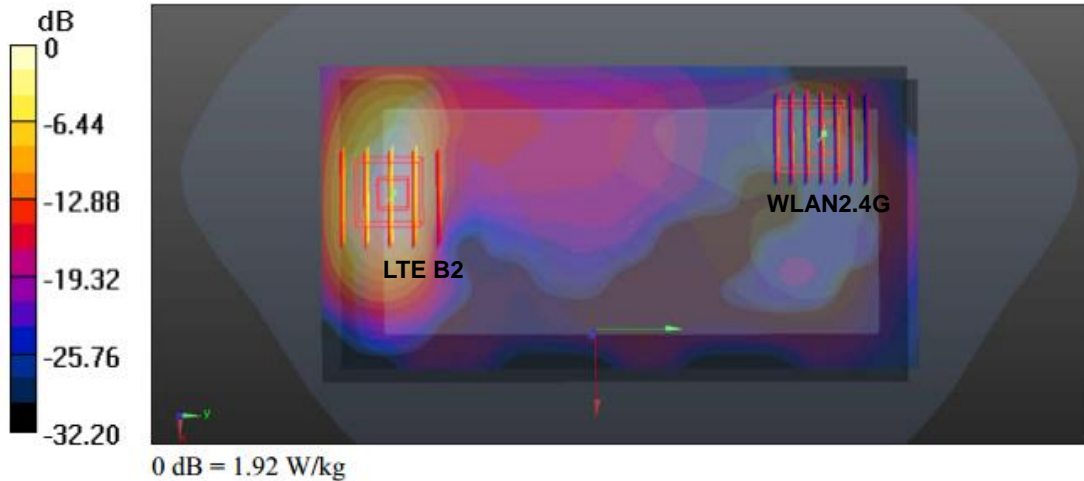

Case #09	Band	Position	SAR (W/kg)	Gap (mm)	SAR peak location (m)			3D distance (mm)	Summed SAR (W/kg)	SPLSR Results	Simultaneous SAR
					X	Y	Z				
	LTE Band 2	Back	1.366	10	-0.0275	-0.0785	-0.204	159.1	2.08	0.02	Not required
	WLAN5GHz		0.668	10	-0.05	0.079	-0.206				
	Bluetooth		0.046	10	-0.0554	0.0696	-0.205				
	LTE Band 2	Back	1.366	10	-0.0275	-0.0785	-0.204	150.7	2.08	0.02	Not required
	Bluetooth		0.046	10	-0.0554	0.0696	-0.205				
	WLAN5GHz		0.668	10	-0.05	0.079	-0.206				

Test Laboratory: Sporton International Inc. SAR/HAC Testing Lab

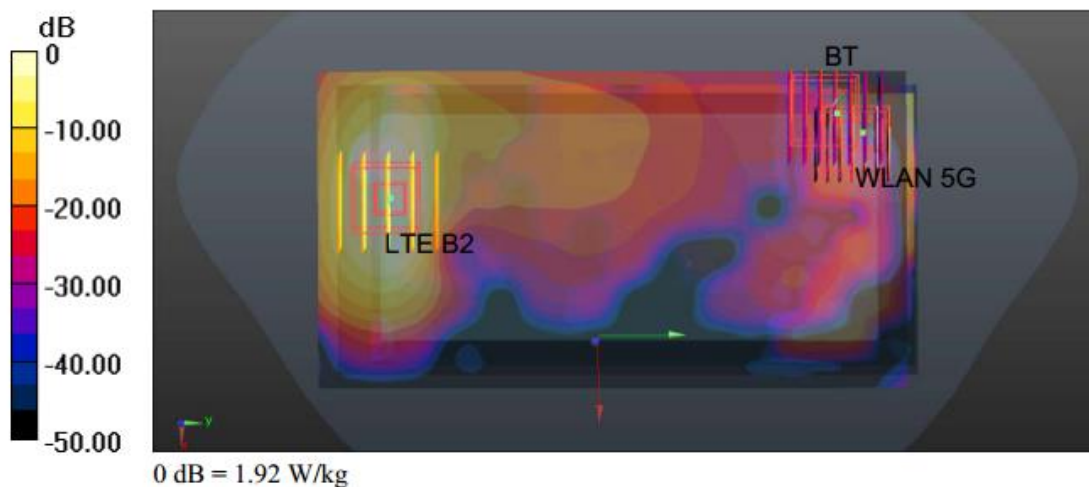

Case #10	Band	Position	SAR (W/kg)	Gap (mm)	SAR peak location (m)			3D distance (mm)	Summed SAR (W/kg)	SPLSR Results	Simultaneous SAR
					X	Y	Z				
Case #10	LTE Band 30	Back	0.992	10	-0.0398	-0.0684	-0.208	147.8	1.71	0.02	Not required
	WLAN5GHz		0.668	10	-0.05	0.079	-0.206				
	Bluetooth		0.046	10	-0.0554	0.0696	-0.205				
Case #10	LTE Band 30	Back	0.992	10	-0.0398	-0.0684	-0.208	138.9	1.71	0.02	Not required
	Bluetooth		0.046	10	-0.0554	0.0696	-0.205				
	WLAN5GHz		0.668	10	-0.05	0.079	-0.206				

Test Laboratory: Sporton International Inc. SAR/HAC Testing Lab

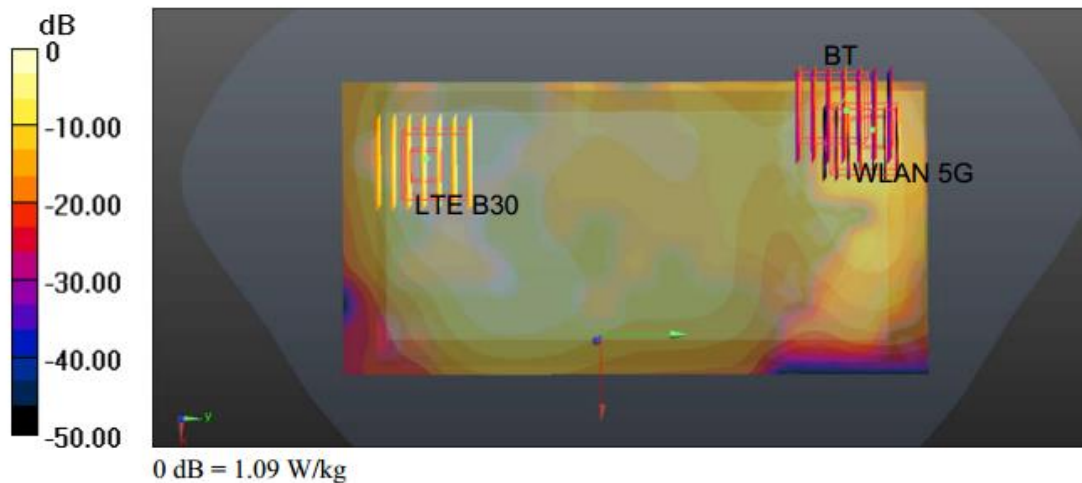

Case #11	Band	Position	SAR (W/kg)	Gap (mm)	SAR peak location (m)			3D distance (mm)	Summed SAR (W/kg)	SPLSR Results	Simultaneous SAR
					X	Y	Z				
Case #11	LTE Band 2	Back	3.294	0	-0.014	-0.0815	-0.204	158.1	4.76	0.07	Not required
	WLAN5GHz		1.463	0	-0.052	0.072	-0.205				

Test Laboratory: Sporton International Inc. SAR/HAC Testing Lab

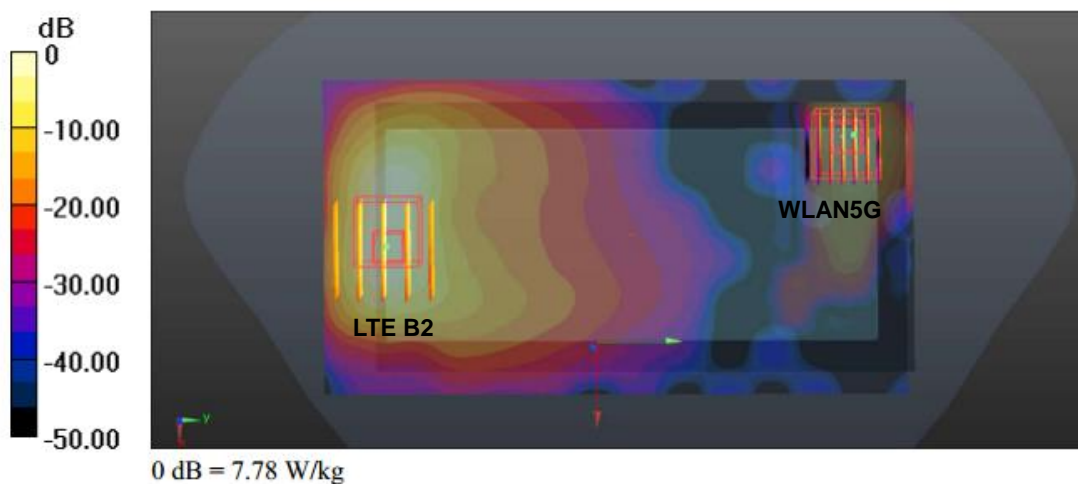

Test Engineer : Changlin Huang, Bin He, Mengming Dai



16. Uncertainty Assessment

Per KDB 865664 D01 SAR measurement 100MHz to 6GHz, when the highest measured 1-g SAR within a frequency band is < 1.5 W/kg and the measured 10-g SAR within a frequency band is < 3.75 W/kg. The expanded SAR measurement uncertainty must be $\leq 30\%$, for a confidence interval of $k = 2$. If these conditions are met, extensive SAR measurement uncertainty analysis described in IEEE Std 1528-2013 is not required in SAR reports submitted for equipment approval. For this device, the highest measured 1-g SAR is less 1.5W/kg and highest measured 10-g SAR is less 3.75W/kg. Therefore, the measurement uncertainty table is not required in this report.

17. References

- [1] FCC 47 CFR Part 2 “Frequency Allocations and Radio Treaty Matters; General Rules and Regulations”
- [2] ANSI/IEEE Std. C95.1-1992, “IEEE Standard for Safety Levels with Respect to Human Exposure to Radio Frequency Electromagnetic Fields, 3 kHz to 300 GHz”, September 1992
- [3] IEEE Std. 1528-2013, “IEEE Recommended Practice for Determining the Peak Spatial-Average Specific Absorption Rate (SAR) in the Human Head from Wireless Communications Devices: Measurement Techniques”, Sep 2013
- [4] SPEAG DASY System Handbook
- [5] FCC KDB 865664 D01 v01r04, "SAR Measurement Requirements for 100 MHz to 6 GHz", Aug 2015.
- [6] FCC KDB 865664 D02 v01r02, “RF Exposure Compliance Reporting and Documentation Considerations” Oct 2015.
- [7] FCC KDB 447498 D01 v06, “Mobile and Portable Device RF Exposure Procedures and Equipment Authorization Policies”, Oct 2015
- [8] FCC KDB 648474 D04 v01r03, “SAR Evaluation Considerations for Wireless Handsets”, Oct 2015.
- [9] FCC KDB 248227 D01 v02r02, “SAR Guidance for IEEE 802.11 (WiFi) Transmitters”, Oct 2015.
- [10] FCC KDB 941225 D01 v03r01, “3G SAR MEAUREMENT PROCEDURES”, Oct 2015
- [11] FCC KDB 941225 D05 v02r05, “SAR Evaluation Considerations for LTE Devices”, Dec 2015
- [12] FCC KDB 941225 D06 v02r01, "SAR Evaluation Procedures for Portable Devices with Wireless Router Capabilities", Oct 2015.
- [13] FCC KDB 941225 D05A v01r02, “Rel. 10 LTE SAR Test Guidance and KDB Inquiries”, Oct 2015

-----THE END-----



Appendix A. Plots of System Performance Check

The plots are shown as follows.

System Check_Head_750MHz

DUT: D750V3-SN:1099

Communication System: UID 0, CW (0); Frequency: 750 MHz; Duty Cycle: 1:1

Medium: HSL_750_200328 Medium parameters used: $f = 750 \text{ MHz}$; $\sigma = 0.879 \text{ S/m}$; $\epsilon_r = 40.711$; $\rho = 1000 \text{ kg/m}^3$

Ambient Temperature : 23.5 °C; Liquid Temperature : 22.4 °C

DASY5 Configuration:

- Probe: EX3DV4 - SN3753; ConvF(9.47, 9.47, 9.47); Calibrated: 2019.06.19;
- Sensor-Surface: 2mm (Mechanical Surface Detection)
- Electronics: DAE4 Sn1386 ; Calibrated: 2019.09.09
- Phantom: SAM2; Type: QD000P40CD; Serial: TP:1671
- Measurement SW: DASY52, Version 52.8 (8); SEMCAD X Version 14.6.10 (7331)

Pin=250mW/Area Scan (61x61x1): Interpolated grid: $dx=1.5\text{mm}$, $dy=1.5\text{mm}$

Maximum value of SAR (interpolated) = 2.82 W/kg

Pin=250mW/Zoom Scan (5x5x7)/Cube 0: Measurement grid: $dx=8\text{mm}$, $dy=8\text{mm}$, $dz=5\text{mm}$

Reference Value = 56.54 V/m; Power Drift = 0.10 dB

Peak SAR (extrapolated) = 3.39 W/kg

SAR(1 g) = 2.26 W/kg; SAR(10 g) = 1.5 W/kg

Maximum value of SAR (measured) = 2.86 W/kg

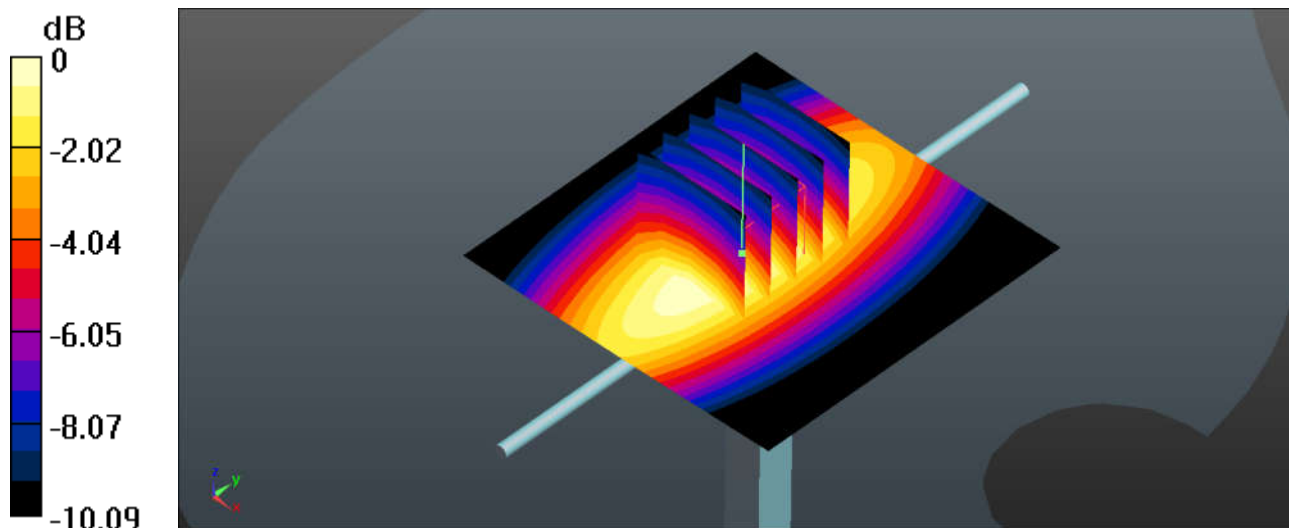

0 dB = 2.82 W/kg

System Check_Head_835MHz

DUT: D835V2-SN:4d162

Communication System: UID 0, CW (0); Frequency: 835 MHz; Duty Cycle: 1:1

Medium: HSL_835_200403 Medium parameters used: $f = 835$ MHz; $\sigma = 0.913$ S/m; $\epsilon_r = 40.859$; $\rho = 1000$ kg/m³

Ambient Temperature : 23.4 °C; Liquid Temperature : 22.5 °C

DASY5 Configuration:

- Probe: EX3DV4 - SN3753; ConvF(9.13, 9.13, 9.13); Calibrated: 2019.06.19;
- Sensor-Surface: 2mm (Mechanical Surface Detection)
- Electronics: DAE4 Sn1386 ; Calibrated: 2019.09.09
- Phantom: SAM2; Type: QD000P40CD; Serial: TP:1671
- Measurement SW: DASY52, Version 52.8 (8); SEMCAD X Version 14.6.10 (7331)

Pin=250mW/Area Scan (61x61x1): Interpolated grid: dx=1.5mm, dy=1.5mm

Maximum value of SAR (interpolated) = 2.93 W/kg

Pin=250mW/Zoom Scan (5x5x7)/Cube 0: Measurement grid: dx=8mm, dy=8mm, dz=5mm

Reference Value = 56.79 V/m; Power Drift = 0.10 dB

Peak SAR (extrapolated) = 3.55 W/kg

SAR(1 g) = 2.32 W/kg; SAR(10 g) = 1.51 W/kg

Maximum value of SAR (measured) = 2.96 W/kg

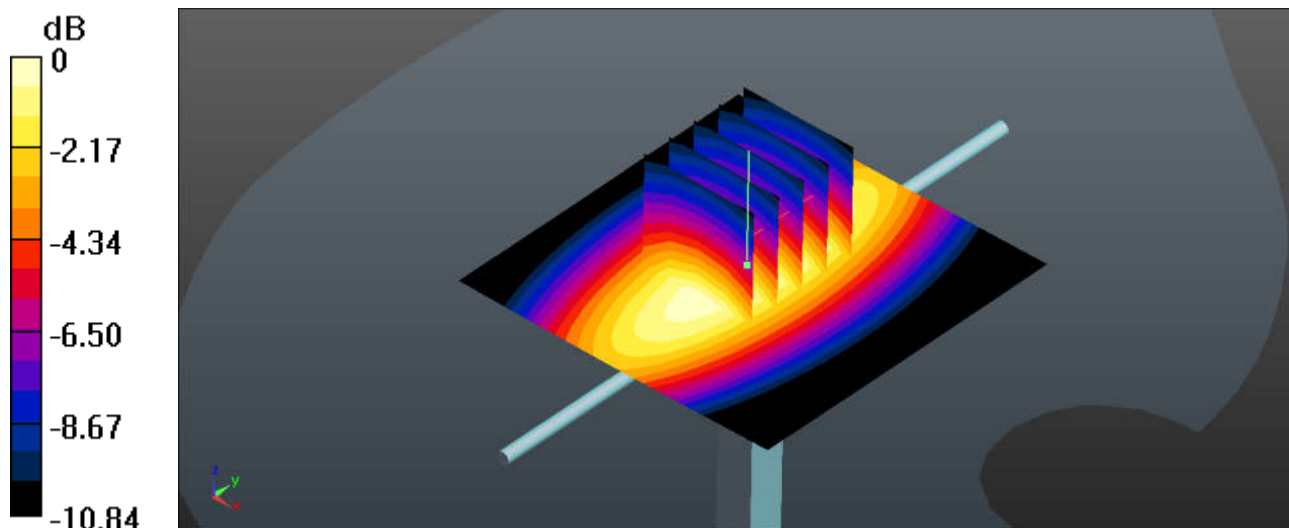

0 dB = 2.93 W/kg

System Check_Head_1750MHz

DUT: D1750V2-SN:1090

Communication System: UID 0, CW; Frequency: 1750 MHz; Duty Cycle: 1:1

Medium: HSL_1750_200419 Medium parameters used: $f = 1750$ MHz; $\sigma = 1.377$ S/m; $\epsilon_r = 41.359$; $\rho = 1000$ kg/m³

Ambient Temperature : 23.3 °C; Liquid Temperature : 22.9 °C

DASY5 Configuration:

- Probe: EX3DV4 - SN3753; ConvF(8.1, 8.1, 8.1); Calibrated: 2019.06.19;
- Sensor-Surface: 2mm (Mechanical Surface Detection)
- Electronics: DAE4 Sn1386 ; Calibrated: 2019.09.09
- Phantom: SAM2; Type: QD000P40CD; Serial: TP:1671
- Measurement SW: DASY52, Version 52.8 (8); SEMCAD X Version 14.6.10 (7331)

Pin=250mW/Area Scan (61x61x1): Interpolated grid: dx=1.5mm, dy=1.5mm

Maximum value of SAR (interpolated) = 12.5 W/kg

Pin=250mW/Zoom Scan (5x5x7)/Cube 0: Measurement grid: dx=8mm, dy=8mm, dz=5mm

Reference Value = 84.86 V/m; Power Drift = 0.06 dB

Peak SAR (extrapolated) = 15.8 W/kg

SAR(1 g) = 8.92 W/kg; SAR(10 g) = 4.77 W/kg

Maximum value of SAR (measured) = 12.6 W/kg

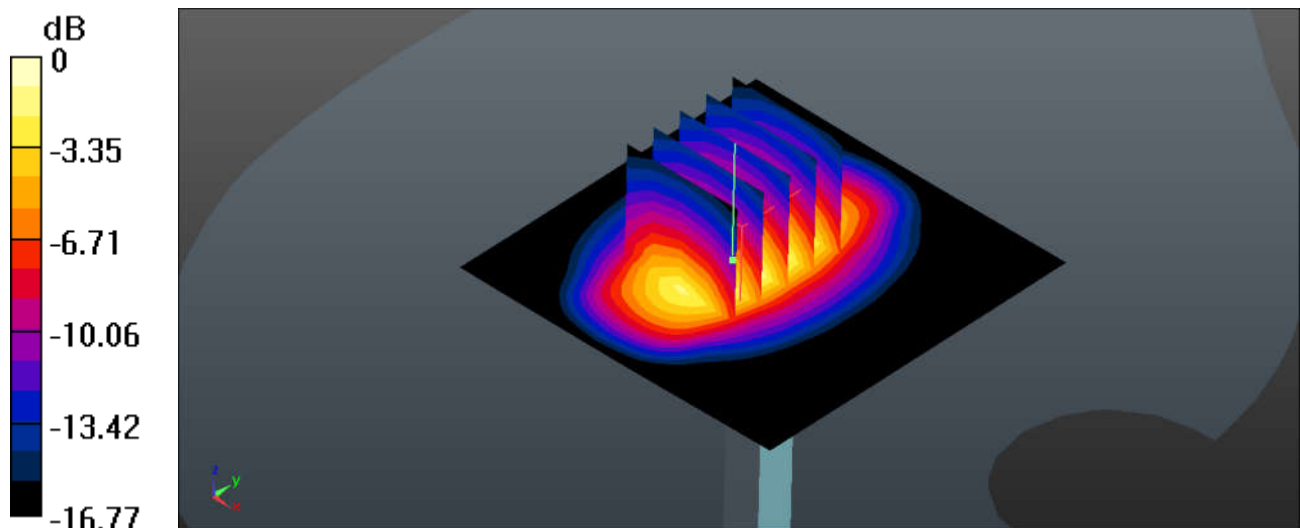

0 dB = 12.5 W/kg

System Check_Head_1900MHz

DUT: D1900V2-SN:5d182

Communication System: UID 0, CW; Frequency: 1900 MHz; Duty Cycle: 1:1

Medium: HSL_1900_200423 Medium parameters used: $f = 1900$ MHz; $\sigma = 1.417$ S/m; $\epsilon_r = 40.994$; $\rho = 1000$ kg/m³

Ambient Temperature : 23.4 °C; Liquid Temperature : 22.6 °C

DASY5 Configuration:

- Probe: EX3DV4 - SN3753; ConvF(7.73, 7.73, 7.73); Calibrated: 2019.06.19;
- Sensor-Surface: 2mm (Mechanical Surface Detection)
- Electronics: DAE4 Sn1386 ; Calibrated: 2019.09.09
- Phantom: SAM2; Type: QD000P40CD; Serial: TP:1671
- Measurement SW: DASY52, Version 52.8 (8); SEMCAD X Version 14.6.10 (7331)

Pin=250mW/Area Scan (61x61x1): Interpolated grid: dx=1.5mm, dy=1.5mm

Maximum value of SAR (interpolated) = 14.9 W/kg

Pin=250mW/Zoom Scan (5x5x7)/Cube 0: Measurement grid: dx=8mm, dy=8mm, dz=5mm

Reference Value = 89.59 V/m; Power Drift = 0.09 dB

Peak SAR (extrapolated) = 18.3 W/kg

SAR(1 g) = 9.87 W/kg; SAR(10 g) = 5.06 W/kg

Maximum value of SAR (measured) = 14.0 W/kg

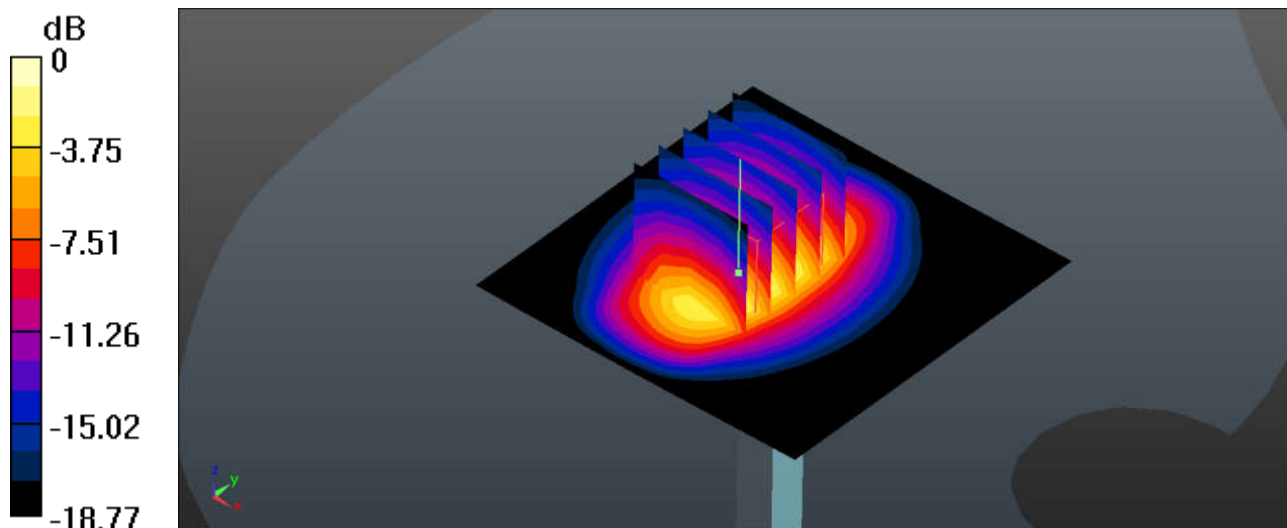

0 dB = 14.9 W/kg

System Check_Head_2300MHz

DUT: D2300V2-SN:1056

Communication System: UID 0, CW (0); Frequency: 2300 MHz; Duty Cycle: 1:1
Medium: HSL_2300_200401 Medium parameters used: $f = 2300$ MHz; $\sigma = 1.664$ S/m; $\epsilon_r = 38.851$; $\rho = 1000$ kg/m³
Ambient Temperature : 23.4 °C; Liquid Temperature : 22.9 °C

DASY5 Configuration:

- Probe: EX3DV4 - SN3753; ConvF(7.6, 7.6, 7.6); Calibrated: 2019.06.19;
- Sensor-Surface: 2mm (Mechanical Surface Detection)
- Electronics: DAE4 Sn1386 ; Calibrated: 2019.09.09
- Phantom: SAM2; Type: QD000P40CD; Serial: TP:1671
- Measurement SW: DASY52, Version 52.8 (8); SEMCAD X Version 14.6.10 (7331)

Pin=250mW/Area Scan (81x81x1): Interpolated grid: dx=1.2mm, dy=1.2mm
Maximum value of SAR (interpolated) = 18.0 W/kg

Pin=250mW/Zoom Scan (7x7x7)/Cube 0: Measurement grid: dx=5mm, dy=5mm, dz=5mm
Reference Value = 100.4 V/m; Power Drift = 0.01 dB
Peak SAR (extrapolated) = 24.9 W/kg
SAR(1 g) = 11.8 W/kg; SAR(10 g) = 5.51 W/kg
Maximum value of SAR (measured) = 18.1 W/kg

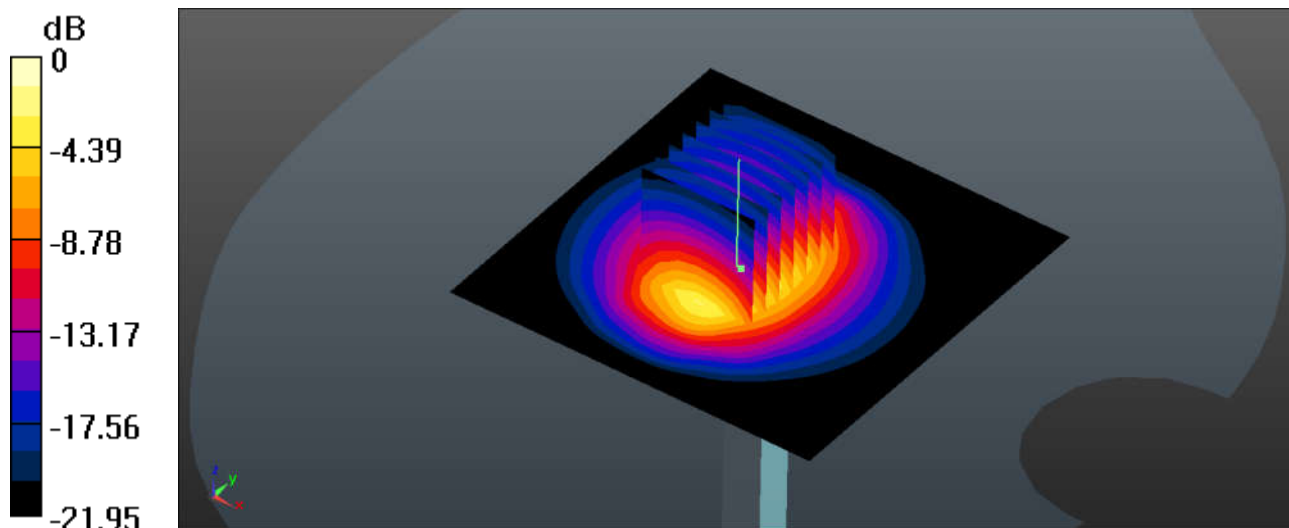

0 dB = 18.0 W/kg

System Check_Head_2450MHz

DUT: D2450V2-SN:924

Communication System: UID 0, CW; Frequency: 2450 MHz; Duty Cycle: 1:1

Medium: HSL_2450_200411 Medium parameters used: $f = 2450$ MHz; $\sigma = 1.829$ S/m; $\epsilon_r = 40.081$; $\rho = 1000$ kg/m³

Ambient Temperature : 23.4 °C; Liquid Temperature : 22.4 °C

DASY5 Configuration:

- Probe: EX3DV4 - SN3753; ConvF(7.43, 7.43, 7.43); Calibrated: 2019.06.19;
- Sensor-Surface: 2mm (Mechanical Surface Detection)
- Electronics: DAE4 Sn1386 ; Calibrated: 2019.09.09
- Phantom: SAM2; Type: QD000P40CD; Serial: TP:1671
- Measurement SW: DASY52, Version 52.8 (8); SEMCAD X Version 14.6.10 (7331)

Pin=250mW/Area Scan (81x81x1): Interpolated grid: dx=1.2mm, dy=1.2mm

Maximum value of SAR (interpolated) = 19.2 W/kg

Pin=250mW/Zoom Scan (7x7x7)/Cube 0: Measurement grid: dx=5mm, dy=5mm, dz=5mm

Reference Value = 68.64 V/m; Power Drift = 0.07 dB

Peak SAR (extrapolated) = 26.9 W/kg

SAR(1 g) = 12.2 W/kg; SAR(10 g) = 5.4 W/kg

Maximum value of SAR (measured) = 19.1 W/kg

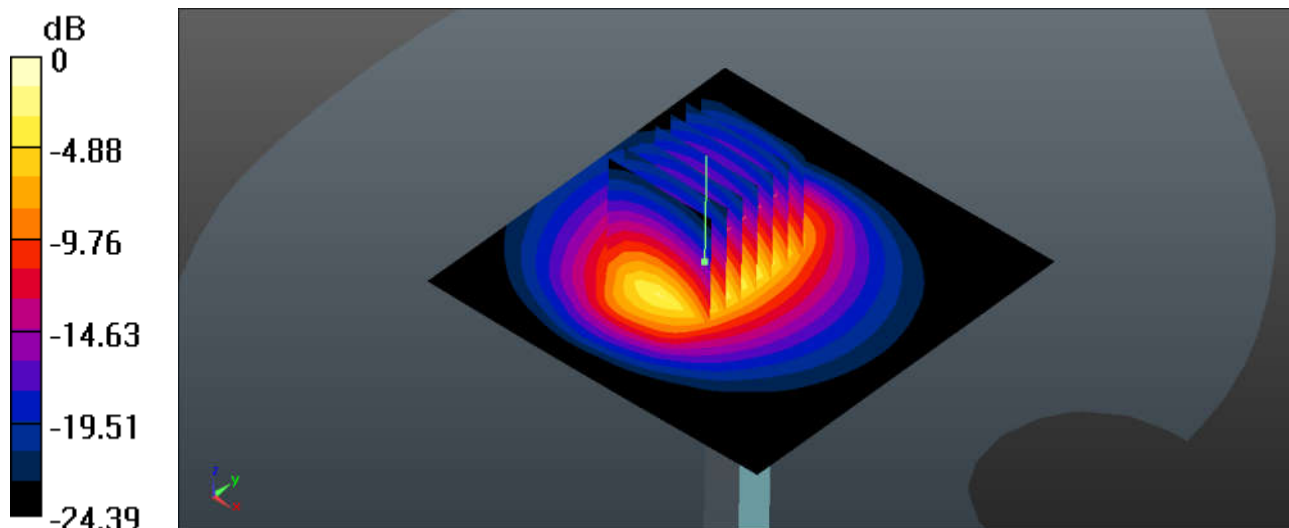

0 dB = 19.2 W/kg

System Check_Head_5250MHz

DUT: D5GHzV2-SN:1167

Communication System: UID 0, CW (0); Frequency: 5250 MHz;Duty Cycle: 1:1
Medium: HSL_5250_200417 Medium parameters used: $f = 5250$ MHz; $\sigma = 4.748$ S/m; $\epsilon_r = 36.881$; $\rho = 1000$ kg/m³
Ambient Temperature : 23.7 °C; Liquid Temperature : 22.7 °C

DASY5 Configuration:

- Probe: EX3DV4 - SN3753; ConvF(5.39, 5.39, 5.39); Calibrated: 2019.06.19;
- Sensor-Surface: 1.4mm (Mechanical Surface Detection)
- Electronics: DAE4 Sn1386 ; Calibrated: 2019.09.09
- Phantom: SAM2; Type: QD000P40CD; Serial: TP:1671
- Measurement SW: DASY52, Version 52.8 (8); SEMCAD X Version 14.6.10 (7331)

Pin=100mW/Area Scan (71x71x1): Interpolated grid: dx=1.0mm, dy=1.0mm
Maximum value of SAR (interpolated) = 18.6 W/kg

Pin=100mW/Zoom Scan (7x7x7)/Cube 0: Measurement grid: dx=4mm, dy=4mm, dz=1.4mm
Reference Value = 47.94 V/m; Power Drift = 0.03 dB
Peak SAR (extrapolated) = 32.4 W/kg
SAR(1 g) = 7.37 W/kg; SAR(10 g) = 2.03 W/kg
Maximum value of SAR (measured) = 18.5 W/kg

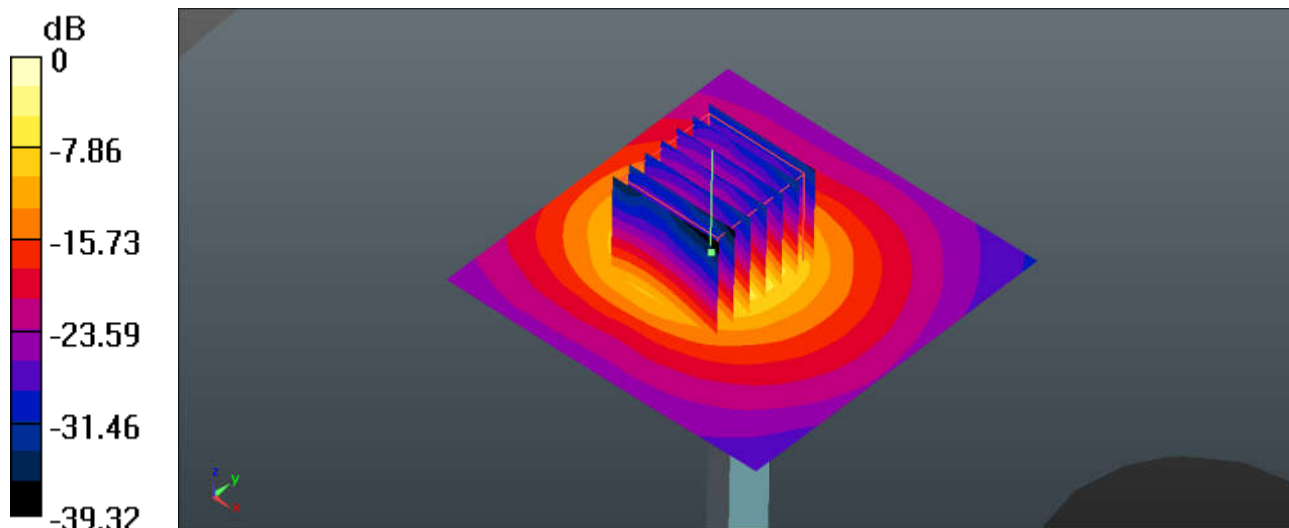

0 dB = 18.6 W/kg

System Check_Head_5600MHz

DUT: D5GHzV2-SN:1167

Communication System: UID 0, CW (0); Frequency: 5600 MHz;Duty Cycle: 1:1
Medium: HSL_5600_200418 Medium parameters used: $f = 5600$ MHz; $\sigma = 5.182$ S/m; $\epsilon_r = 36.105$; $\rho = 1000$ kg/m³
Ambient Temperature : 23.7 °C; Liquid Temperature : 22.6 °C

DASY5 Configuration:

- Probe: EX3DV4 - SN3753; ConvF(4.74, 4.74, 4.74); Calibrated: 2019.06.19;
- Sensor-Surface: 1.4mm (Mechanical Surface Detection)
- Electronics: DAE4 Sn1386 ; Calibrated: 2019.09.09
- Phantom: SAM2; Type: QD000P40CD; Serial: TP:1671
- Measurement SW: DASY52, Version 52.8 (8); SEMCAD X Version 14.6.10 (7331)

Pin=100mW/Area Scan (71x71x1): Interpolated grid: dx=1.0mm, dy=1.0mm
Maximum value of SAR (interpolated) = 21.4 W/kg

Pin=100mW/Zoom Scan (7x7x7)/Cube 0: Measurement grid: dx=4mm, dy=4mm, dz=1.4mm
Reference Value = 37.25 V/m; Power Drift = 0.06 dB
Peak SAR (extrapolated) = 40.1 W/kg
SAR(1 g) = 8.55 W/kg; SAR(10 g) = 2.33 W/kg
Maximum value of SAR (measured) = 22.1 W/kg

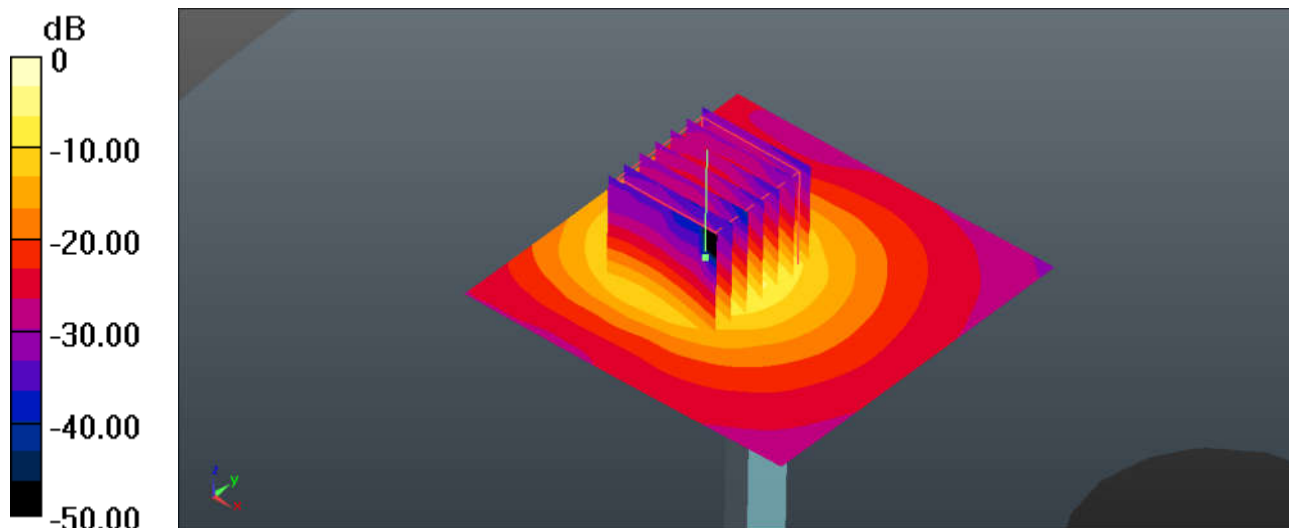

0 dB = 21.4 W/kg

System Check_Head_5750MHz

DUT: D5GHzV2-SN:1167

Communication System: UID 0, CW (0); Frequency: 5750 MHz; Duty Cycle: 1:1

Medium: HSL_5750_200420 Medium parameters used: $f = 5750$ MHz; $\sigma = 5.364$ S/m; $\epsilon_r = 35.845$; $\rho = 1000$ kg/m³

Ambient Temperature : 23.7 °C; Liquid Temperature : 22.7 °C

DASY5 Configuration:

- Probe: EX3DV4 - SN3753; ConvF(4.78, 4.78, 4.78); Calibrated: 2019.06.19;
- Sensor-Surface: 1.4mm (Mechanical Surface Detection)
- Electronics: DAE4 Sn1386 ; Calibrated: 2019.09.09
- Phantom: SAM2; Type: QD000P40CD; Serial: TP:1671
- Measurement SW: DASY52, Version 52.8 (8); SEMCAD X Version 14.6.10 (7331)

Pin=100mW/Area Scan (71x71x1): Interpolated grid: dx=1.0mm, dy=1.0mm

Maximum value of SAR (interpolated) = 20.3 W/kg

Pin=100mW/Zoom Scan (7x7x7)/Cube 0: Measurement grid: dx=4mm, dy=4mm, dz=1.4mm

Reference Value = 39.42 V/m; Power Drift = 0.06 dB

Peak SAR (extrapolated) = 37.4 W/kg

SAR(1 g) = 7.8 W/kg; SAR(10 g) = 2.13 W/kg

Maximum value of SAR (measured) = 20.4 W/kg

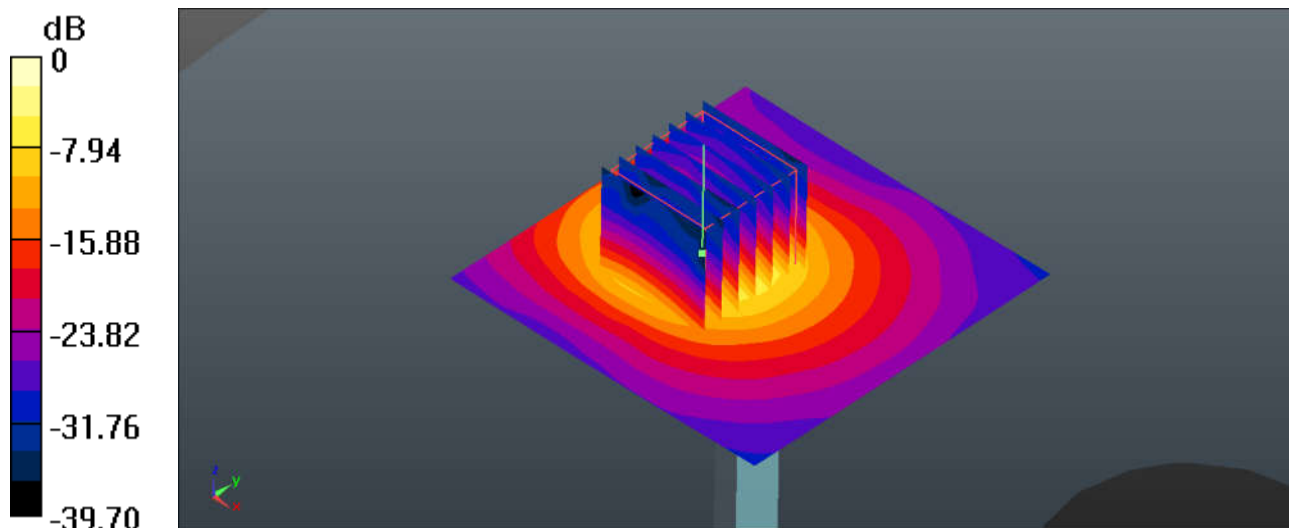

0 dB = 20.3 W/kg



Appendix B. Plots of High SAR Measurement

The plots are shown as follows.

01_GSM850_GPRS(2 Tx slots)_Left Check_Ch251

Communication System: UID 0, GPRS/EDGE10 (0); Frequency: 848.8 MHz; Duty Cycle: 1:4.15
Medium: HSL_835_200403 Medium parameters used: $f = 849$ MHz; $\sigma = 0.925$ S/m; $\epsilon_r = 40.705$; $\rho = 1000$ kg/m³
Ambient Temperature : 23.4 °C; Liquid Temperature : 22.5 °C

DASY5 Configuration:

- Probe: EX3DV4 - SN3753; ConvF(9.13, 9.13, 9.13); Calibrated: 2019.06.19;
- Sensor-Surface: 2mm (Mechanical Surface Detection)
- Electronics: DAE4 Sn1386 ; Calibrated: 2019.09.09
- Phantom: SAM2; Type: QD000P40CD; Serial: TP:1671
- Measurement SW: DASY52, Version 52.8 (8); SEMCAD X Version 14.6.10 (7331)

Ch251/Area Scan (71x131x1): Interpolated grid: dx=1.5mm, dy=1.5mm
Maximum value of SAR (interpolated) = 0.537 W/kg

Ch251/Zoom Scan (5x5x7)/Cube 0: Measurement grid: dx=8mm, dy=8mm, dz=5mm
Reference Value = 6.575 V/m; Power Drift = -0.07 dB
Peak SAR (extrapolated) = 0.566 W/kg
SAR(1 g) = 0.447 W/kg; SAR(10 g) = 0.339 W/kg
Maximum value of SAR (measured) = 0.489 W/kg

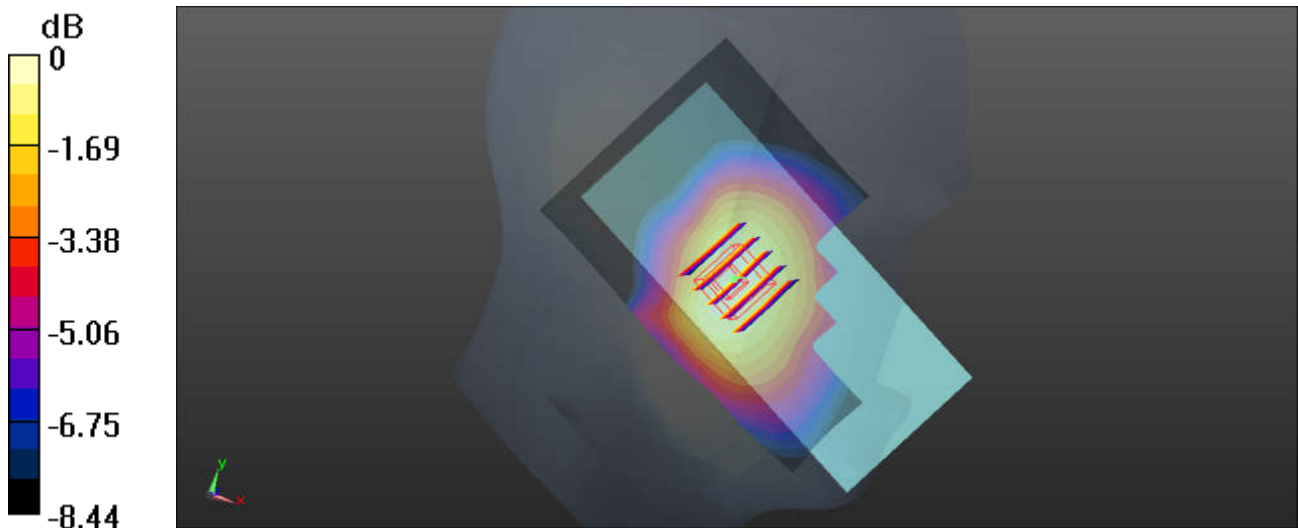

0 dB = 0.537 W/kg

02_GSM1900_GPRS(2 Tx slots)_Right Cheek_Ch661

Communication System: UID 0, GPRS/EDGE10 (0); Frequency: 1880 MHz; Duty Cycle: 1:4.15
Medium: HSL_1900_200423 Medium parameters used: $f = 1880$ MHz; $\sigma = 1.392$ S/m; $\epsilon_r = 41.101$; $\rho = 1000$ kg/m³
Ambient Temperature : 23.4 °C; Liquid Temperature : 22.6 °C

DASY5 Configuration:

- Probe: EX3DV4 - SN3753; ConvF(7.73, 7.73, 7.73); Calibrated: 2019.06.19;
- Sensor-Surface: 2mm (Mechanical Surface Detection)
- Electronics: DAE4 Sn1386 ; Calibrated: 2019.09.09
- Phantom: SAM2; Type: QD000P40CD; Serial: TP:1671
- Measurement SW: DASY52, Version 52.8 (8); SEMCAD X Version 14.6.10 (7331)

Ch661/Area Scan (71x131x1): Interpolated grid: dx=1.5mm, dy=1.5mm
Maximum value of SAR (interpolated) = 0.0410 W/kg

Ch661/Zoom Scan (5x5x7)/Cube 0: Measurement grid: dx=8mm, dy=8mm, dz=5mm
Reference Value = 0.9790 V/m; Power Drift = 0.08 dB
Peak SAR (extrapolated) = 0.0460 W/kg
SAR(1 g) = 0.030 W/kg; SAR(10 g) = 0.017 W/kg
Maximum value of SAR (measured) = 0.0363 W/kg

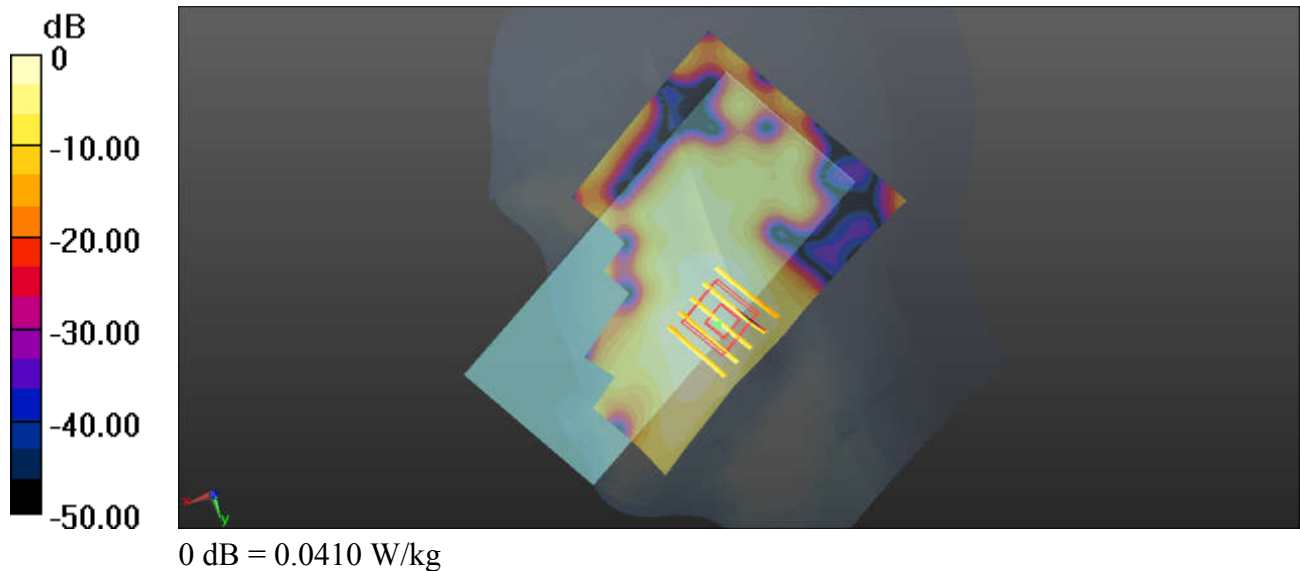

03_WCDMA V_RMC 12.2Kbps_Right Cheek_Ch4233

Communication System: UID 0, UMTS (0); Frequency: 846.6 MHz; Duty Cycle: 1:1
Medium: HSL_835_200403 Medium parameters used: $f = 846.6$ MHz; $\sigma = 0.923$ S/m; $\epsilon_r = 40.736$; $\rho = 1000$ kg/m³
Ambient Temperature : 23.4 °C; Liquid Temperature : 22.5 °C

DASY5 Configuration:

- Probe: EX3DV4 - SN3753; ConvF(9.13, 9.13, 9.13); Calibrated: 2019.06.19;
- Sensor-Surface: 2mm (Mechanical Surface Detection)
- Electronics: DAE4 Sn1386 ; Calibrated: 2019.09.09
- Phantom: SAM2; Type: QD000P40CD; Serial: TP:1671
- Measurement SW: DASY52, Version 52.8 (8); SEMCAD X Version 14.6.10 (7331)

Ch4233/Area Scan (71x131x1): Interpolated grid: dx=1.5mm, dy=1.5mm
Maximum value of SAR (interpolated) = 0.730 W/kg

Ch4233/Zoom Scan (5x5x7)/Cube 0: Measurement grid: dx=8mm, dy=8mm, dz=5mm
Reference Value = 20.33 V/m; Power Drift = 0.03 dB
Peak SAR (extrapolated) = 0.924 W/kg
SAR(1 g) = 0.495 W/kg; SAR(10 g) = 0.302 W/kg
Maximum value of SAR (measured) = 0.569 W/kg

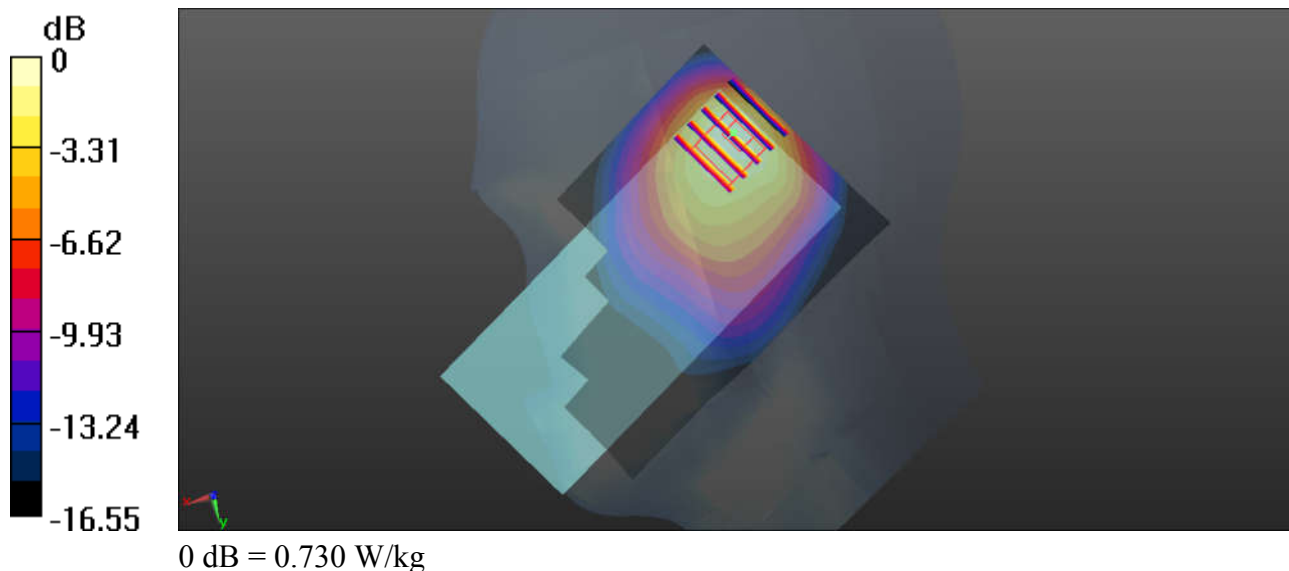

04_WCDMA IV_RMC 12.2Kbps_Right Cheek_Ch1312

Communication System: UID 0, UMTS (0); Frequency: 1712.4 MHz; Duty Cycle: 1:1
Medium: HSL_1750_200419 Medium parameters used: $f = 1712.4$ MHz; $\sigma = 1.337$ S/m; $\epsilon_r = 41.546$;
 $\rho = 1000$ kg/m³
Ambient Temperature : 23.3 °C; Liquid Temperature : 22.9 °C

DASY5 Configuration:

- Probe: EX3DV4 - SN3753; ConvF(8.1, 8.1, 8.1); Calibrated: 2019.06.19;
- Sensor-Surface: 2mm (Mechanical Surface Detection)
- Electronics: DAE4 Sn1386 ; Calibrated: 2019.09.09
- Phantom: SAM2; Type: QD000P40CD; Serial: TP:1671
- Measurement SW: DASY52, Version 52.8 (8); SEMCAD X Version 14.6.10 (7331)

Ch1312/Area Scan (71x131x1): Interpolated grid: dx=1.5mm, dy=1.5mm
Maximum value of SAR (interpolated) = 0.169 W/kg

Ch1312/Zoom Scan (5x5x7)/Cube 0: Measurement grid: dx=8mm, dy=8mm, dz=5mm
Reference Value = 2.152 V/m; Power Drift = -0.15 dB
Peak SAR (extrapolated) = 0.199 W/kg
SAR(1 g) = 0.138 W/kg; SAR(10 g) = 0.089 W/kg
Maximum value of SAR (measured) = 0.155 W/kg

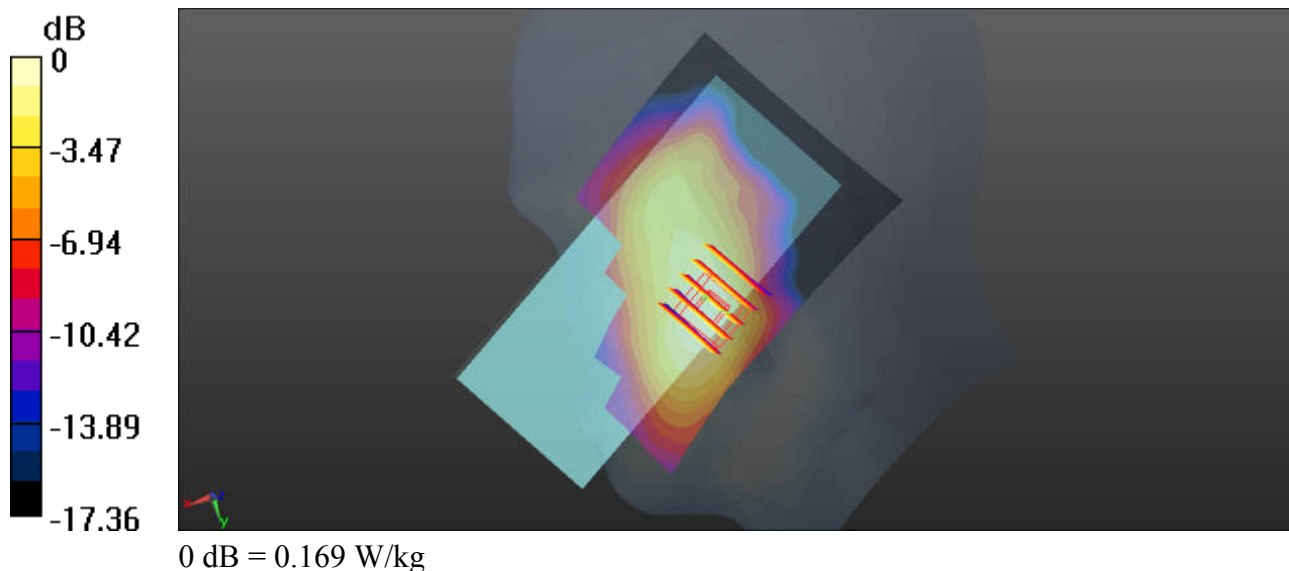

05_WCDMA II_RMC 12.2Kbps_Right Cheek_Ch9400

Communication System: UID 0, UMTS (0); Frequency: 1880 MHz; Duty Cycle: 1:1
Medium: HSL_1900_200423 Medium parameters used: $f = 1880$ MHz; $\sigma = 1.392$ S/m; $\epsilon_r = 41.101$; $\rho = 1000$ kg/m³
Ambient Temperature : 23.4 °C; Liquid Temperature : 22.6 °C

DASY5 Configuration:

- Probe: EX3DV4 - SN3753; ConvF(7.73, 7.73, 7.73); Calibrated: 2019.06.19;
- Sensor-Surface: 2mm (Mechanical Surface Detection)
- Electronics: DAE4 Sn1386 ; Calibrated: 2019.09.09
- Phantom: SAM2; Type: QD000P40CD; Serial: TP:1671
- Measurement SW: DASY52, Version 52.8 (8); SEMCAD X Version 14.6.10 (7331)

Ch9400/Area Scan (71x131x1): Interpolated grid: dx=1.5mm, dy=1.5mm
Maximum value of SAR (interpolated) = 0.0687 W/kg

Ch9400/Zoom Scan (5x5x7)/Cube 0: Measurement grid: dx=8mm, dy=8mm, dz=5mm
Reference Value = 0.7760 V/m; Power Drift = -0.04 dB
Peak SAR (extrapolated) = 0.0640 W/kg
SAR(1 g) = 0.041 W/kg; SAR(10 g) = 0.024 W/kg
Maximum value of SAR (measured) = 0.0503 W/kg

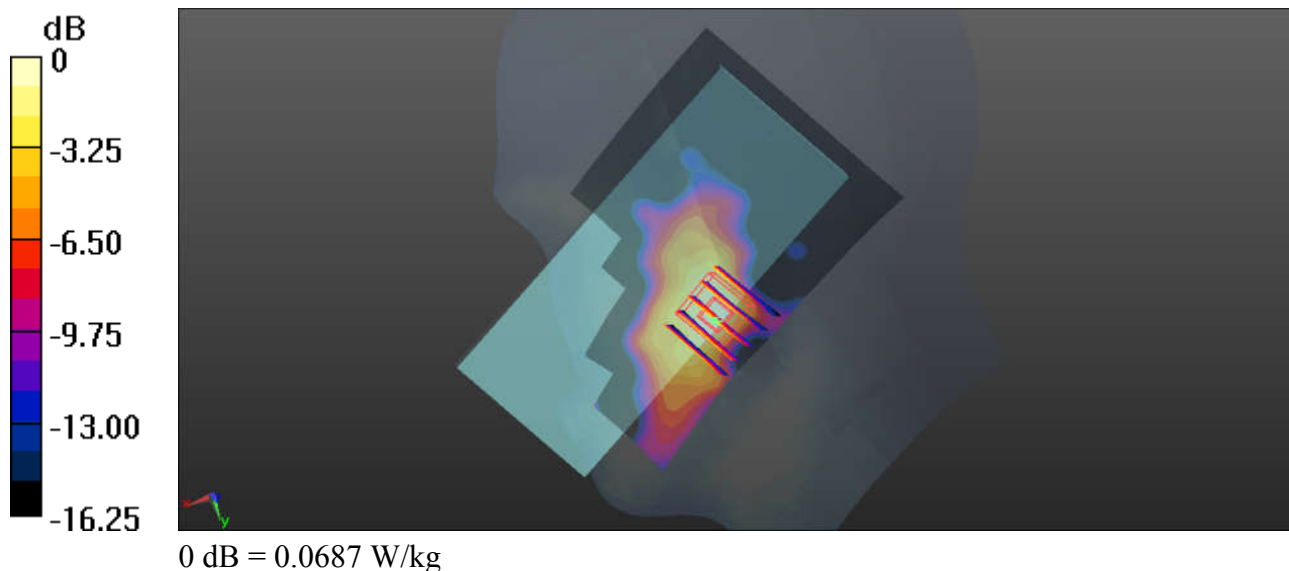

06_LTE Band 12_1.4M_QPSK_3RB_1Offset_Left Check_Ch23095

Communication System: UID 0, LTE (0); Frequency: 707.5 MHz; Duty Cycle: 1:1
Medium: HSL_750_200328 Medium parameters used: $f = 707.5$ MHz; $\sigma = 0.857$ S/m; $\epsilon_r = 41.645$; $\rho = 1000$ kg/m³
Ambient Temperature : 23.5 °C; Liquid Temperature : 22.4 °C

DASY5 Configuration:

- Probe: EX3DV4 - SN3753; ConvF(9.47, 9.47, 9.47); Calibrated: 2019.06.19;
- Sensor-Surface: 2mm (Mechanical Surface Detection)
- Electronics: DAE4 Sn1386 ; Calibrated: 2019.09.09
- Phantom: SAM2; Type: QD000P40CD; Serial: TP:1671
- Measurement SW: DASY52, Version 52.8 (8); SEMCAD X Version 14.6.10 (7331)

Ch23095/Area Scan (71x131x1): Interpolated grid: dx=1.5mm, dy=1.5mm
Maximum value of SAR (interpolated) = 0.281 W/kg

Ch23095/Zoom Scan (5x5x7)/Cube 0: Measurement grid: dx=8mm, dy=8mm, dz=5mm
Reference Value = 4.481 V/m; Power Drift = 0.15 dB
Peak SAR (extrapolated) = 0.303 W/kg
SAR(1 g) = 0.252 W/kg; SAR(10 g) = 0.203 W/kg
Maximum value of SAR (measured) = 0.271 W/kg

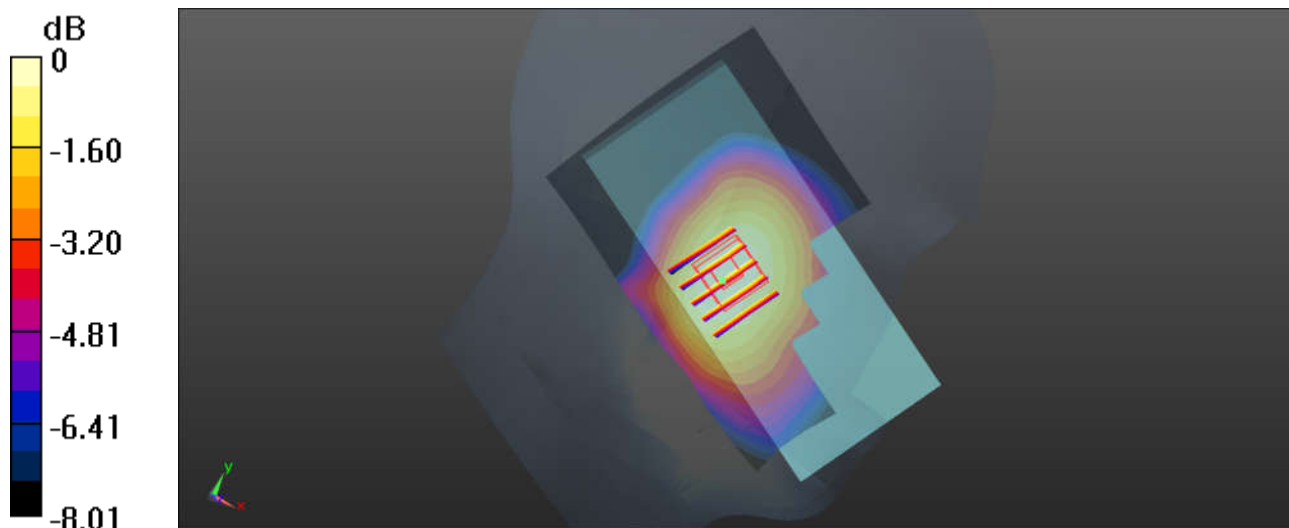

0 dB = 0.281 W/kg

07_LTE Band 14_10M_QPSK_25RB_0Offset_Left Cheek_Ch23330

Communication System: UID 0, LTE (0); Frequency: 793 MHz; Duty Cycle: 1:1

Medium: HSL_750_200328 Medium parameters used: $f = 793$ MHz; $\sigma = 0.911$ S/m; $\epsilon_r = 39.813$; $\rho = 1000$ kg/m³

Ambient Temperature : 23.5 °C ; Liquid Temperature : 22.4 °C

DASY5 Configuration:

- Probe: EX3DV4 - SN3753; ConvF(9.47, 9.47, 9.47); Calibrated: 2019.06.19;
- Sensor-Surface: 2mm (Mechanical Surface Detection)
- Electronics: DAE4 Sn1386 ; Calibrated: 2019.09.09
- Phantom: SAM2; Type: QD000P40CD; Serial: TP:1671
- Measurement SW: DASY52, Version 52.8 (8); SEMCAD X Version 14.6.10 (7331)

Ch23330/Area Scan (71x131x1): Interpolated grid: dx=1.5mm, dy=1.5mm

Maximum value of SAR (interpolated) = 0.224 W/kg

Ch23330/Zoom Scan (5x5x7)/Cube 0: Measurement grid: dx=8mm, dy=8mm, dz=5mm

Reference Value = 3.244 V/m; Power Drift = 0.02 dB

Peak SAR (extrapolated) = 0.234 W/kg

SAR(1 g) = 0.194 W/kg; SAR(10 g) = 0.153 W/kg

Maximum value of SAR (measured) = 0.208 W/kg

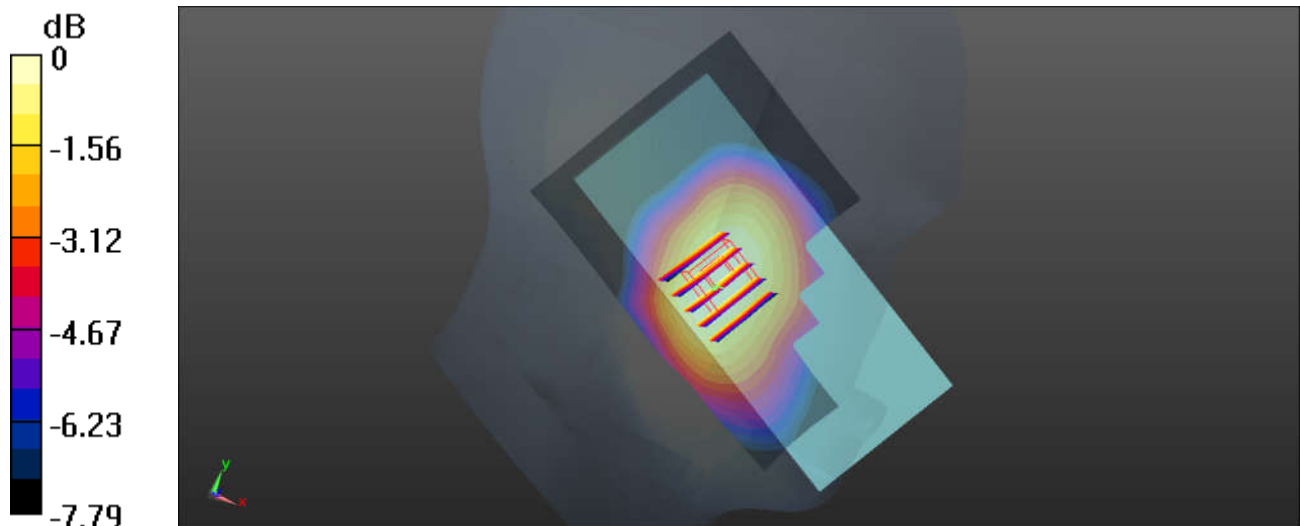

0 dB = 0.224 W/kg

08_LTE Band 5_10M_QPSK_50RB_0Offset_Right Cheek_Ch20525

Communication System: UID 0, LTE (0); Frequency: 836.5 MHz; Duty Cycle: 1:1
 Medium: HSL_835_200403 Medium parameters used: $f = 836.5$ MHz; $\sigma = 0.914$ S/m; $\epsilon_r = 40.842$; $\rho = 1000$ kg/m³
 Ambient Temperature : 23.4 °C; Liquid Temperature : 22.5 °C

DASY5 Configuration:

- Probe: EX3DV4 - SN3753; ConvF(9.13, 9.13, 9.13); Calibrated: 2019.06.19;
- Sensor-Surface: 2mm (Mechanical Surface Detection)
- Electronics: DAE4 Sn1386 ; Calibrated: 2019.09.09
- Phantom: SAM2; Type: QD000P40CD; Serial: TP:1671
- Measurement SW: DASY52, Version 52.8 (8); SEMCAD X Version 14.6.10 (7331)

Ch20525/Area Scan (71x131x1): Interpolated grid: dx=1.5mm, dy=1.5mm
 Maximum value of SAR (interpolated) = 0.965 W/kg

Ch20525/Zoom Scan (5x5x7)/Cube 0: Measurement grid: dx=8mm, dy=8mm, dz=5mm
 Reference Value = 23.36 V/m; Power Drift = 0.04 dB
 Peak SAR (extrapolated) = 1.17 W/kg
SAR(1 g) = 0.625 W/kg; SAR(10 g) = 0.383 W/kg
 Maximum value of SAR (measured) = 0.717 W/kg

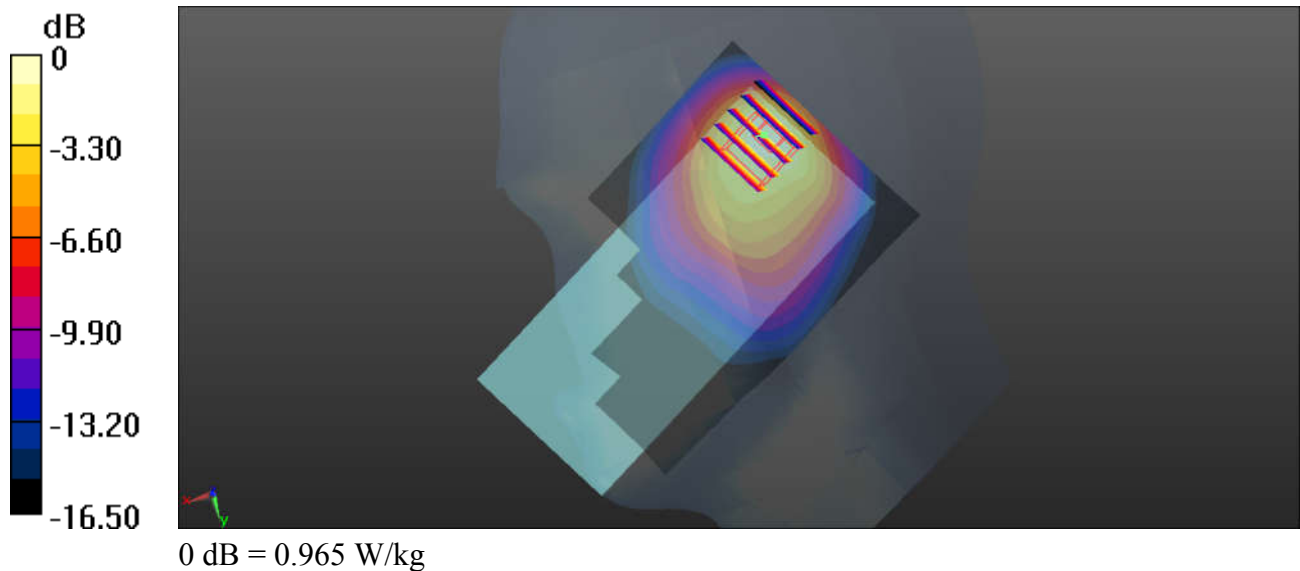

09_LTE Band 4_20M_QPSK_1RB_49Offset_Right Cheek_0mm_Ch20175

Communication System: UID 0, LTE (0); Frequency: 1732.5 MHz;Duty Cycle: 1:1
Medium: HSL_1750_200419 Medium parameters used: $f = 1732.5$ MHz; $\sigma = 1.358$ S/m; $\epsilon_r = 41.445$;
 $\rho = 1000$ kg/m³
Ambient Temperature : 23.3 °C; Liquid Temperature : 22.9 °C

DASY5 Configuration:

- Probe: EX3DV4 - SN3753; ConvF(8.1, 8.1, 8.1); Calibrated: 2019.06.19;
- Sensor-Surface: 2mm (Mechanical Surface Detection)
- Electronics: DAE4 Sn1386 ; Calibrated: 2019.09.09
- Phantom: SAM2; Type: QD000P40CD; Serial: TP:1671
- Measurement SW: DASY52, Version 52.8 (8); SEMCAD X Version 14.6.10 (7331)

Ch20175/Area Scan (71x131x1): Interpolated grid: dx=1.5mm, dy=1.5mm
Maximum value of SAR (interpolated) = 0.263 W/kg

Ch20175/Zoom Scan (5x5x7)/Cube 0: Measurement grid: dx=8mm, dy=8mm, dz=5mm
Reference Value = 3.596 V/m; Power Drift = -0.06 dB
Peak SAR (extrapolated) = 0.315 W/kg
SAR(1 g) = 0.196 W/kg; SAR(10 g) = 0.136 W/kg
Maximum value of SAR (measured) = 0.245 W/kg

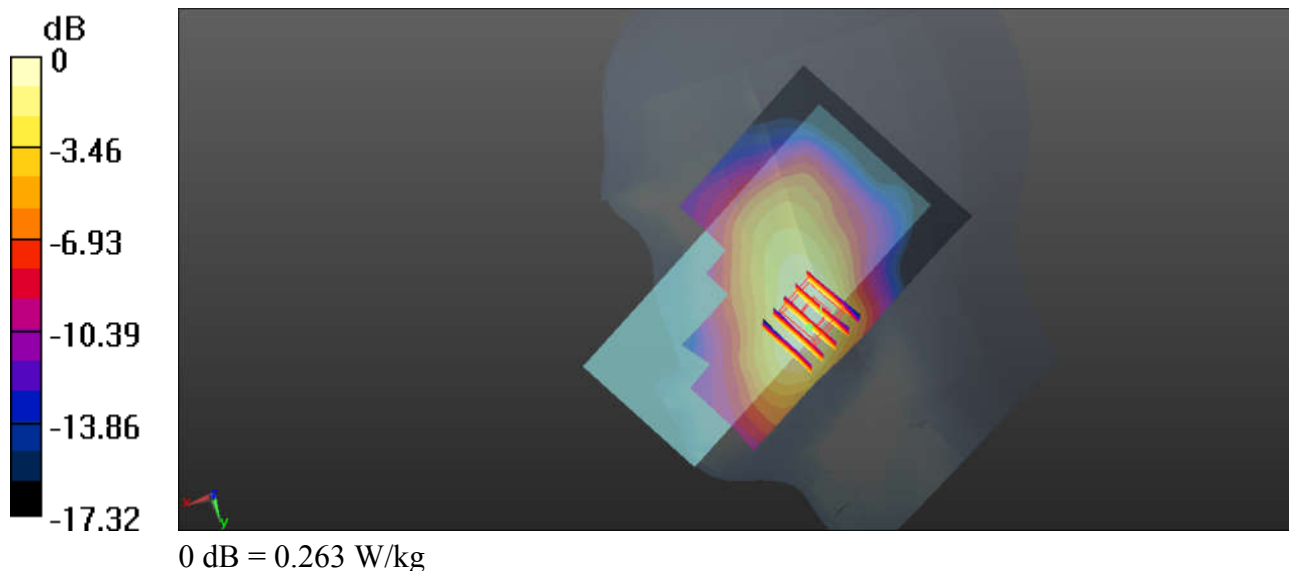

10_LTE Band 66_1.4M_QPSK_3RB_1Offset_Right Cheek_Ch132322

Communication System: UID 0, LTE (0); Frequency: 1745 MHz; Duty Cycle: 1:1

Medium: HSL_1750_200419 Medium parameters used: $f = 1745$ MHz; $\sigma = 1.372$ S/m; $\epsilon_r = 41.386$; $\rho = 1000$ kg/m³

Ambient Temperature : 23.3 °C; Liquid Temperature : 22.9 °C

DASY5 Configuration:

- Probe: EX3DV4 - SN3753; ConvF(8.1, 8.1, 8.1); Calibrated: 2019.06.19;
- Sensor-Surface: 2mm (Mechanical Surface Detection)
- Electronics: DAE4 Sn1386 ; Calibrated: 2019.09.09
- Phantom: SAM2; Type: QD000P40CD; Serial: TP:1671
- Measurement SW: DASY52, Version 52.8 (8); SEMCAD X Version 14.6.10 (7331)

Ch132322/Area Scan (71x121x1): Interpolated grid: dx=1.5mm, dy=1.5mm

Maximum value of SAR (interpolated) = 0.255 W/kg

Ch132322/Zoom Scan (5x5x7)/Cube 0: Measurement grid: dx=8mm, dy=8mm, dz=5mm

Reference Value = 3.448 V/m; Power Drift = -0.02 dB

Peak SAR (extrapolated) = 0.291 W/kg

SAR(1 g) = 0.195 W/kg; SAR(10 g) = 0.123 W/kg

Maximum value of SAR (measured) = 0.228 W/kg

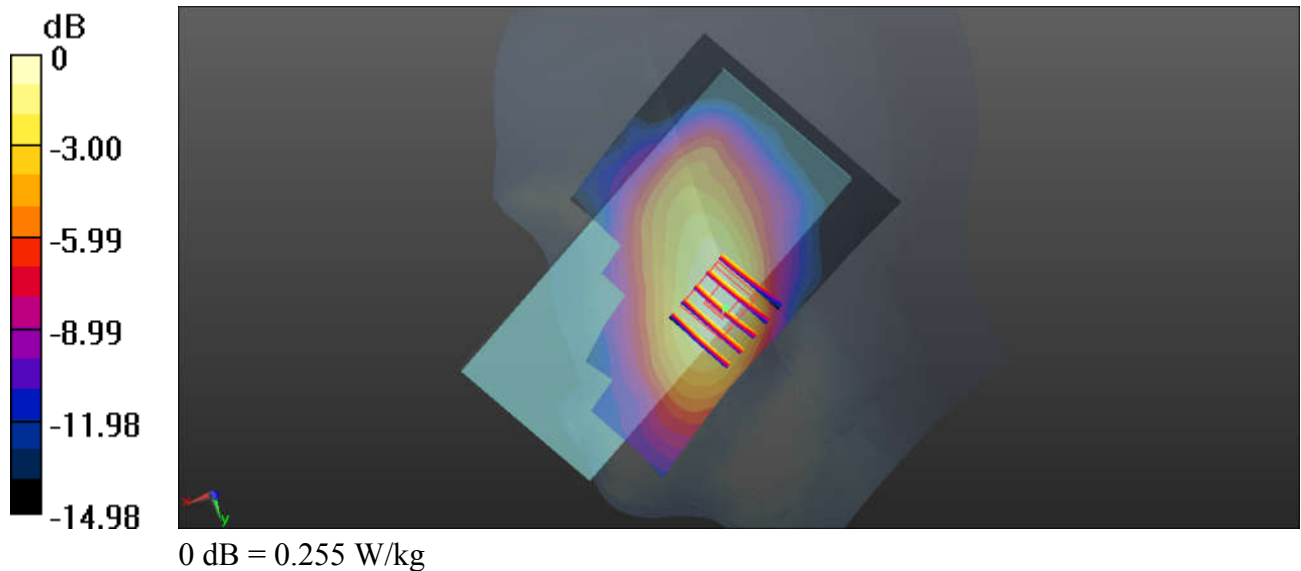

11_LTE Band 2_20M_QPSK_1RB_49Offset_Right Cheek_Ch19100

Communication System: UID 0, LTE (0); Frequency: 1900 MHz; Duty Cycle: 1:1
 Medium: HSL_1900_200423 Medium parameters used: $f = 1900$ MHz; $\sigma = 1.417$ S/m; $\epsilon_r = 40.994$; $\rho = 1000$ kg/m³
 Ambient Temperature : 23.4 °C; Liquid Temperature : 22.6 °C

DASY5 Configuration:

- Probe: EX3DV4 - SN3753; ConvF(7.73, 7.73, 7.73); Calibrated: 2019.06.19;
- Sensor-Surface: 2mm (Mechanical Surface Detection)
- Electronics: DAE4 Sn1386 ; Calibrated: 2019.09.09
- Phantom: SAM2; Type: QD000P40CD; Serial: TP:1671
- Measurement SW: DASY52, Version 52.8 (8); SEMCAD X Version 14.6.10 (7331)

Ch19100/Area Scan (71x131x1): Interpolated grid: dx=1.5mm, dy=1.5mm
 Maximum value of SAR (interpolated) = 0.118 W/kg

Ch19100/Zoom Scan (5x5x7)/Cube 0: Measurement grid: dx=8mm, dy=8mm, dz=5mm
 Reference Value = 1.226 V/m; Power Drift = -0.03 dB
 Peak SAR (extrapolated) = 0.144 W/kg
SAR(1 g) = 0.090 W/kg; SAR(10 g) = 0.053 W/kg
 Maximum value of SAR (measured) = 0.107 W/kg

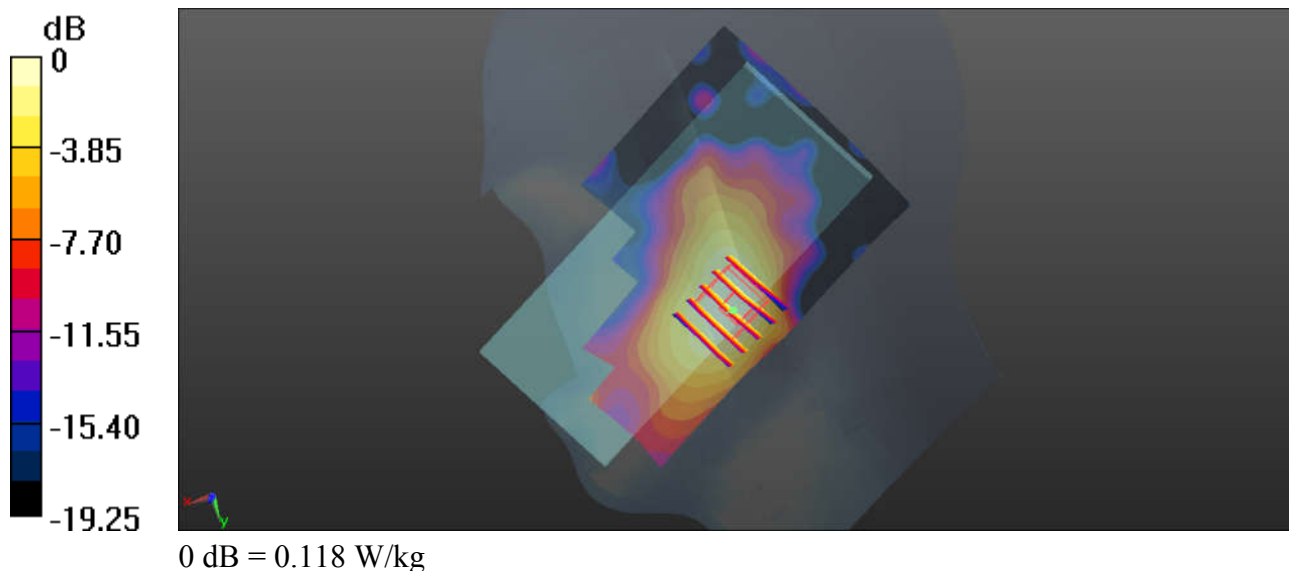

12_LTE Band 30_10M_QPSK_25RB_12Offset_Right Cheek_Ch27710

Communication System: UID 0, LTE (0); Frequency: 2310 MHz; Duty Cycle: 1:1
Medium: HSL_2300_200401 Medium parameters used: $f = 2310$ MHz; $\sigma = 1.677$ S/m; $\epsilon_r = 38.797$; $\rho = 1000$ kg/m³
Ambient Temperature : 23.4 °C; Liquid Temperature : 22.9 °C

DASY5 Configuration:

- Probe: EX3DV4 - SN3753; ConvF(7.6, 7.6, 7.6); Calibrated: 2019.06.19;
- Sensor-Surface: 2mm (Mechanical Surface Detection)
- Electronics: DAE4 Sn1386 ; Calibrated: 2019.09.09
- Phantom: SAM2; Type: QD000P40CD; Serial: TP:1671
- Measurement SW: DASY52, Version 52.8 (8); SEMCAD X Version 14.6.10 (7331)

Ch27710/Area Scan (91x151x1): Interpolated grid: dx=1.2mm, dy=1.2mm
Maximum value of SAR (interpolated) = 0.315 W/kg

Ch27710/Zoom Scan (7x7x7)/Cube 0: Measurement grid: dx=5mm, dy=5mm, dz=5mm
Reference Value = 2.225 V/m; Power Drift = -0.02 dB
Peak SAR (extrapolated) = 0.379 W/kg
SAR(1 g) = 0.219 W/kg; SAR(10 g) = 0.123 W/kg
Maximum value of SAR (measured) = 0.293 W/kg

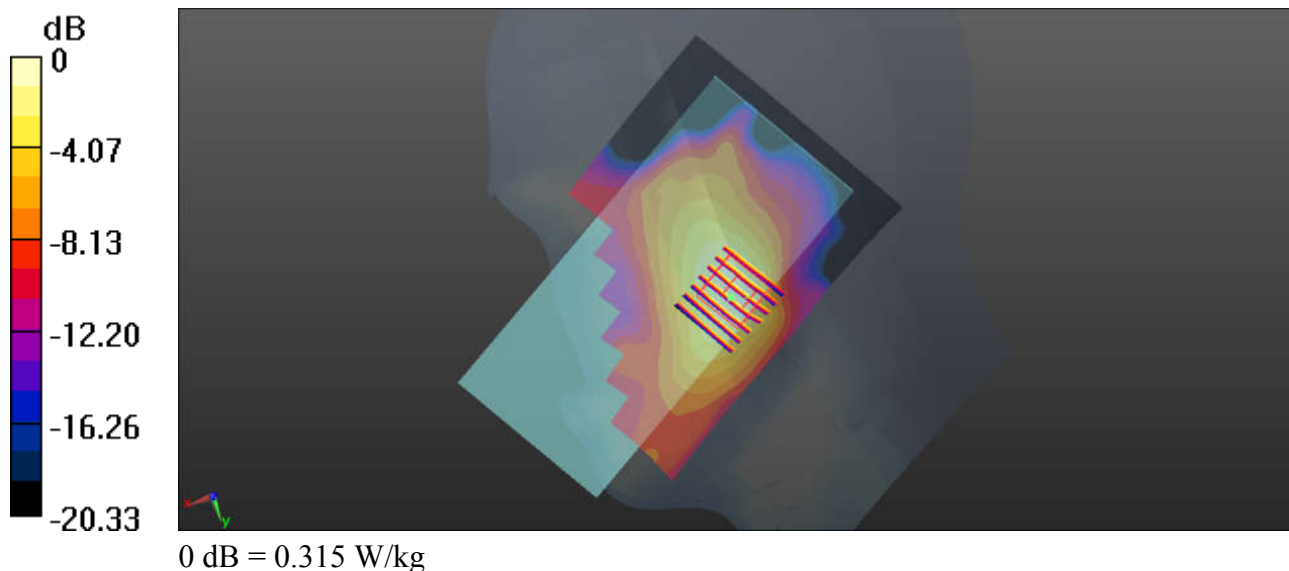

13_WLAN2.4GHz_802.11b 1Mbps_Left Check_Ch11

Communication System: UID 0, WIFI (0); Frequency: 2462 MHz; Duty Cycle: 1:1
Medium: HSL_2450_200411 Medium parameters used: $f = 2462$ MHz; $\sigma = 1.838$ S/m; $\epsilon_r = 39.623$; $\rho = 1000$ kg/m³
Ambient Temperature : 23.4 °C; Liquid Temperature : 22.4 °C

DASY5 Configuration:

- Probe: EX3DV4 - SN3753; ConvF(7.43, 7.43, 7.43); Calibrated: 2019.06.19;
- Sensor-Surface: 2mm (Mechanical Surface Detection)
- Electronics: DAE4 Sn1386 ; Calibrated: 2019.09.09
- Phantom: SAM2; Type: QD000P40CD; Serial: TP:1671
- Measurement SW: DASY52, Version 52.8 (8); SEMCAD X Version 14.6.10 (7331)

Ch11/Area Scan (91x151x1): Interpolated grid: dx=1.2mm, dy=1.2mm
Maximum value of SAR (interpolated) = 0.968 W/kg

Ch11/Zoom Scan (7x7x7)/Cube 0: Measurement grid: dx=5mm, dy=5mm, dz=5mm
Reference Value = 11.02 V/m; Power Drift = 0.16 dB
Peak SAR (extrapolated) = 1.43 W/kg
SAR(1 g) = 0.637 W/kg; SAR(10 g) = 0.289 W/kg
Maximum value of SAR (measured) = 1.01 W/kg

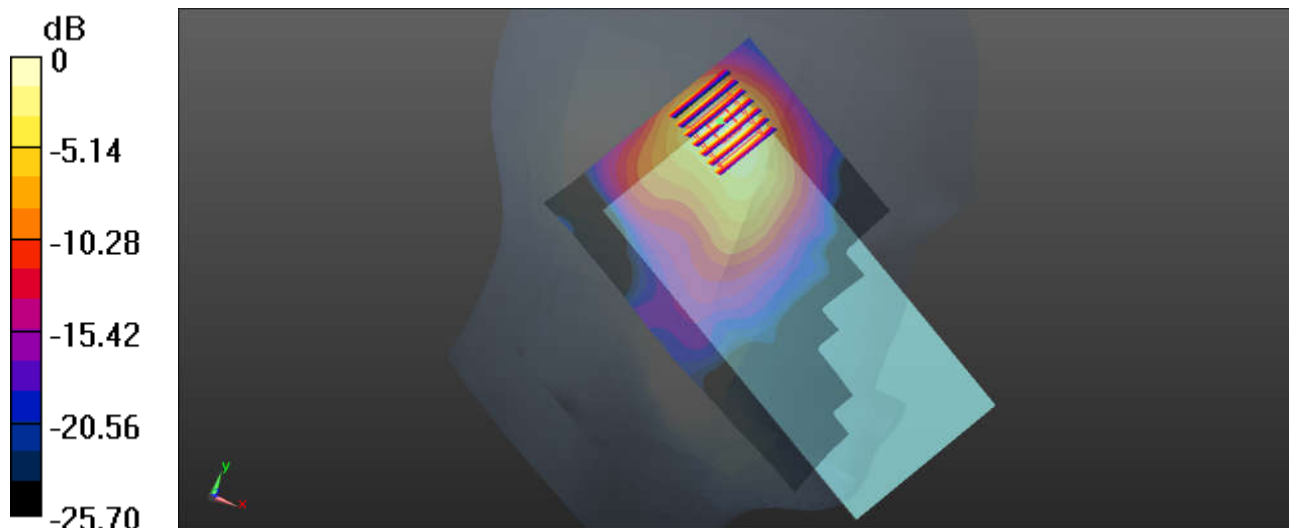

0 dB = 0.968 W/kg

14_WLAN5GHz_802.11a 6Mbps_Left Tilted_Ch60

Communication System: UID 0, WIFI (0); Frequency: 5300 MHz; Duty Cycle: 1:1
Medium: HSL_5250_200417 Medium parameters used: $f = 5300$ MHz; $\sigma = 4.641$ S/m; $\epsilon_r = 36.607$; $\rho = 1000$ kg/m³
Ambient Temperature : 23.7 °C; Liquid Temperature : 22.7 °C

DASY5 Configuration:

- Probe: EX3DV4 - SN3753; ConvF(5.39, 5.39, 5.39); Calibrated: 2019.06.19;
- Sensor-Surface: 1.4mm (Mechanical Surface Detection)
- Electronics: DAE4 Sn1386 ; Calibrated: 2019.09.09
- Phantom: SAM2; Type: QD000P40CD; Serial: TP:1671
- Measurement SW: DASY52, Version 52.8 (8); SEMCAD X Version 14.6.10 (7331)

Ch60/Area Scan (101x191x1): Interpolated grid: dx=1.0mm, dy=1.0mm
Maximum value of SAR (interpolated) = 0.677 W/kg

Ch60/Zoom Scan (7x7x7)/Cube 0: Measurement grid: dx=4mm, dy=4mm, dz=1.4mm
Reference Value = 0 V/m; Power Drift = 0.01 dB
Peak SAR (extrapolated) = 0.849 W/kg
SAR(1 g) = 0.190 W/kg; SAR(10 g) = 0.054 W/kg
Maximum value of SAR (measured) = 0.466 W/kg

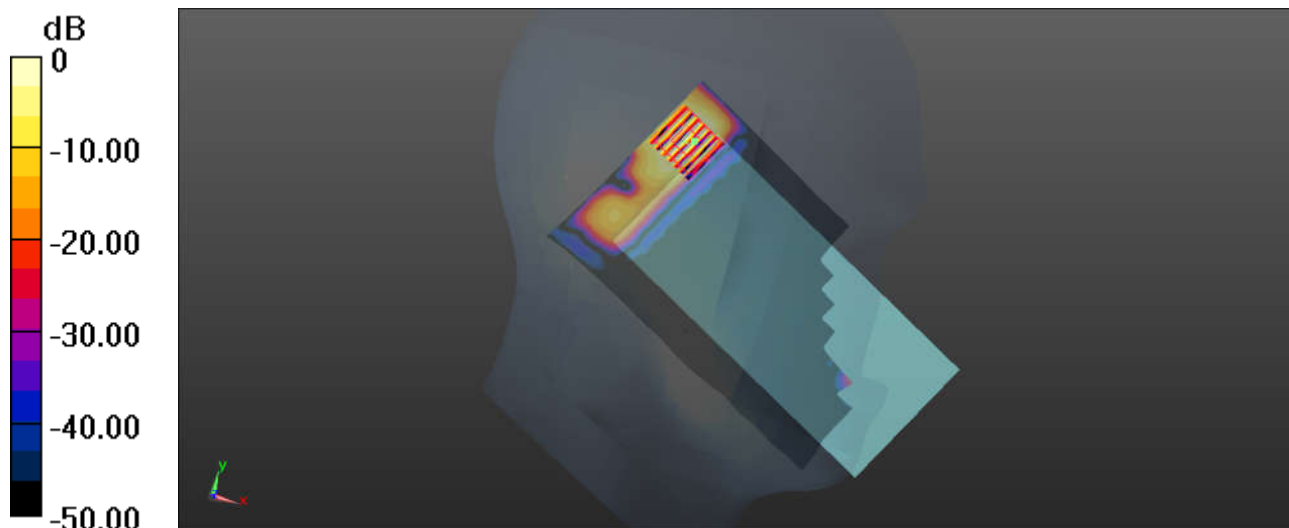

0 dB = 0.466 W/kg

15_WLAN5GHz_802.11ac-VHT80 MCS0_Left Tilted_Ch106

Communication System: UID 0, WIFI (0); Frequency: 5530 MHz; Duty Cycle: 1:1
Medium: HSL_5600_200418 Medium parameters used: $f = 5530$ MHz; $\sigma = 5.085$ S/m; $\epsilon_r = 36.272$; $\rho = 1000$ kg/m³
Ambient Temperature : 23.7 °C; Liquid Temperature : 22.6 °C

DASY5 Configuration:

- Probe: EX3DV4 - SN3753; ConvF(4.74, 4.74, 4.74); Calibrated: 2019.06.19;
- Sensor-Surface: 1.4mm (Mechanical Surface Detection)
- Electronics: DAE4 Sn1386 ; Calibrated: 2019.09.09
- Phantom: SAM2; Type: QD000P40CD; Serial: TP:1671
- Measurement SW: DASY52, Version 52.8 (8); SEMCAD X Version 14.6.10 (7331)

Ch106/Area Scan (101x191x1): Interpolated grid: dx=1.0mm, dy=1.0mm
Maximum value of SAR (interpolated) = 1.10 W/kg

Ch106/Zoom Scan (7x7x7)/Cube 0: Measurement grid: dx=4mm, dy=4mm, dz=1.4mm
Reference Value = 5.359 V/m; Power Drift = 0.06 dB
Peak SAR (extrapolated) = 2.08 W/kg
SAR(1 g) = 0.444 W/kg; SAR(10 g) = 0.119 W/kg
Maximum value of SAR (measured) = 1.14 W/kg

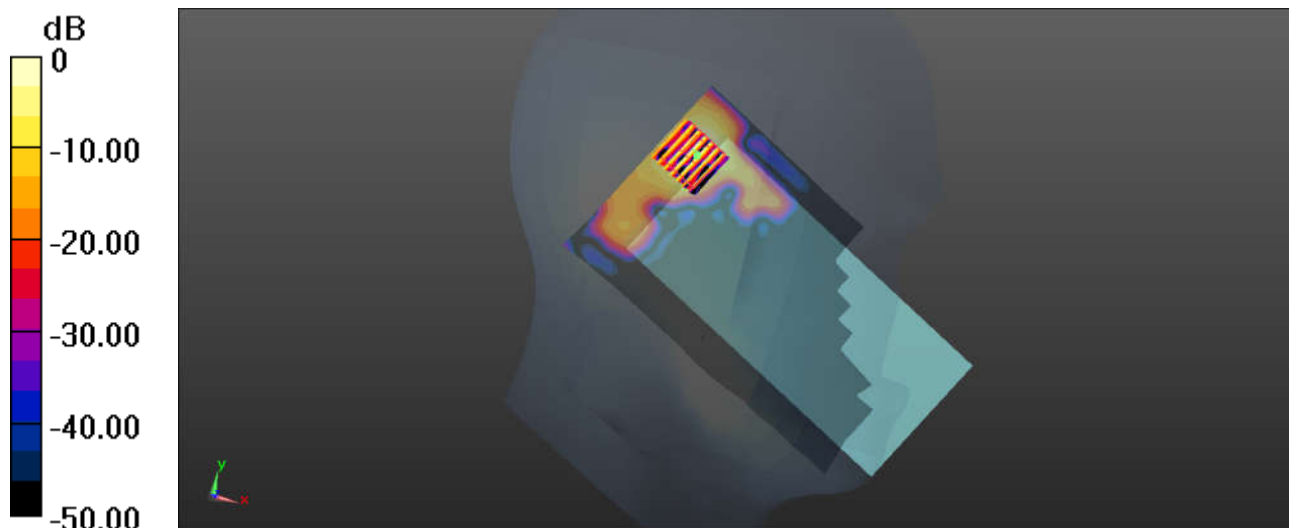

0 dB = 1.14 W/kg

16_WLAN5GHz_802.11a 6Mbps_Left Tilted_Ch165

Communication System: UID 0, WIFI (0); Frequency: 5825 MHz; Duty Cycle: 1:1

Medium: HSL_5750_200420 Medium parameters used: $f = 5825$ MHz; $\sigma = 5.25$ S/m; $\epsilon_r = 35.758$; $\rho = 1000$ kg/m³

Ambient Temperature : 23.7 °C; Liquid Temperature : 22.7 °C

DASY5 Configuration:

- Probe: EX3DV4 - SN3753; ConvF(4.78, 4.78, 4.78); Calibrated: 2019.06.19;
- Sensor-Surface: 1.4mm (Mechanical Surface Detection)
- Electronics: DAE4 Sn1386 ; Calibrated: 2019.09.09
- Phantom: SAM2; Type: QD000P40CD; Serial: TP:1671
- Measurement SW: DASY52, Version 52.8 (8); SEMCAD X Version 14.6.10 (7331)

Ch165/Area Scan (101x191x1): Interpolated grid: dx=1.0mm, dy=1.0mm

Maximum value of SAR (interpolated) = 1.21 W/kg

Ch165/Zoom Scan (7x7x7)/Cube 0: Measurement grid: dx=4mm, dy=4mm, dz=1.4mm

Reference Value = 1.437 V/m; Power Drift = -0.04 dB

Peak SAR (extrapolated) = 2.62 W/kg

SAR(1 g) = 0.562 W/kg; SAR(10 g) = 0.146 W/kg

Maximum value of SAR (measured) = 1.42 W/kg

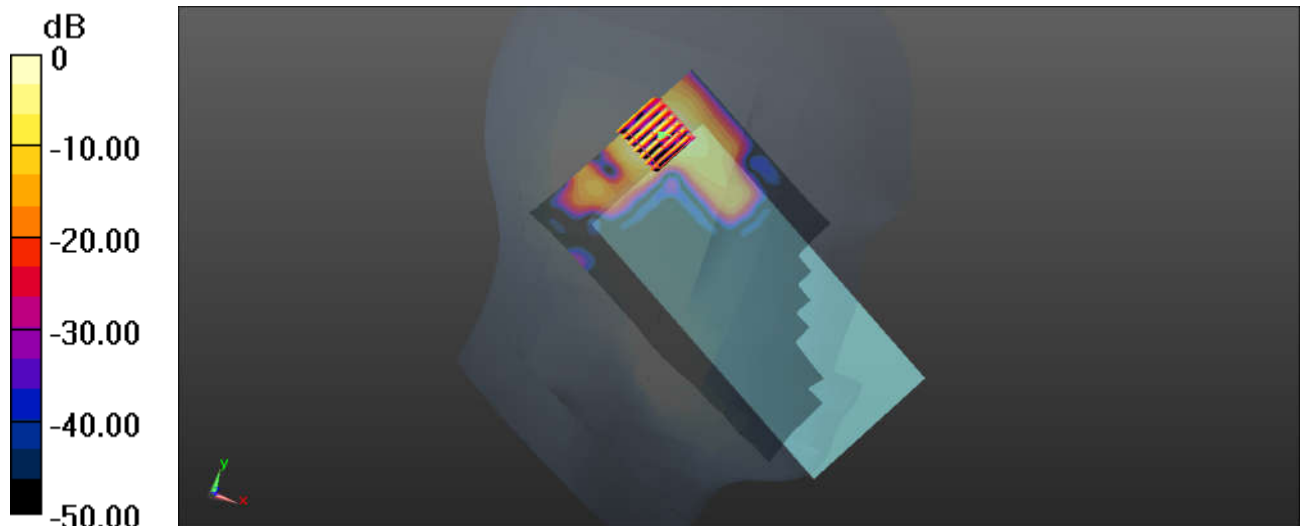

0 dB = 1.42 W/kg

17_Bluetooth_DH5 1Mbps_Left Cheek_0mm_Ch0

Communication System: UID 0, Bluetooth (0); Frequency: 2402 MHz; Duty Cycle: 1:1.303
 Medium: HSL_2450_200411 Medium parameters used: $f = 2402$ MHz; $\sigma = 1.77$ S/m; $\epsilon_r = 39.822$; $\rho = 1000$ kg/m³
 Ambient Temperature : 23.4 °C; Liquid Temperature : 22.4 °C

DASY5 Configuration:

- Probe: EX3DV4 - SN3753; ConvF(7.43, 7.43, 7.43); Calibrated: 2019.06.19;
- Sensor-Surface: 2mm (Mechanical Surface Detection)
- Electronics: DAE4 Sn1386 ; Calibrated: 2019.09.09
- Phantom: SAM2; Type: QD000P40CD; Serial: TP:1671
- Measurement SW: DASY52, Version 52.8 (8); SEMCAD X Version 14.6.10 (7331)

Ch0/Area Scan (91x151x1): Interpolated grid: dx=1.2mm, dy=1.2mm

Maximum value of SAR (interpolated) = 0.126 W/kg

Ch0/Zoom Scan (7x7x7)/Cube 0: Measurement grid: dx=5mm, dy=5mm, dz=5mm

Reference Value = 4.399 V/m; Power Drift = 0.05 dB

Peak SAR (extrapolated) = 0.177 W/kg

SAR(1 g) = 0.075 W/kg; SAR(10 g) = 0.034 W/kg

Maximum value of SAR (measured) = 0.118 W/kg

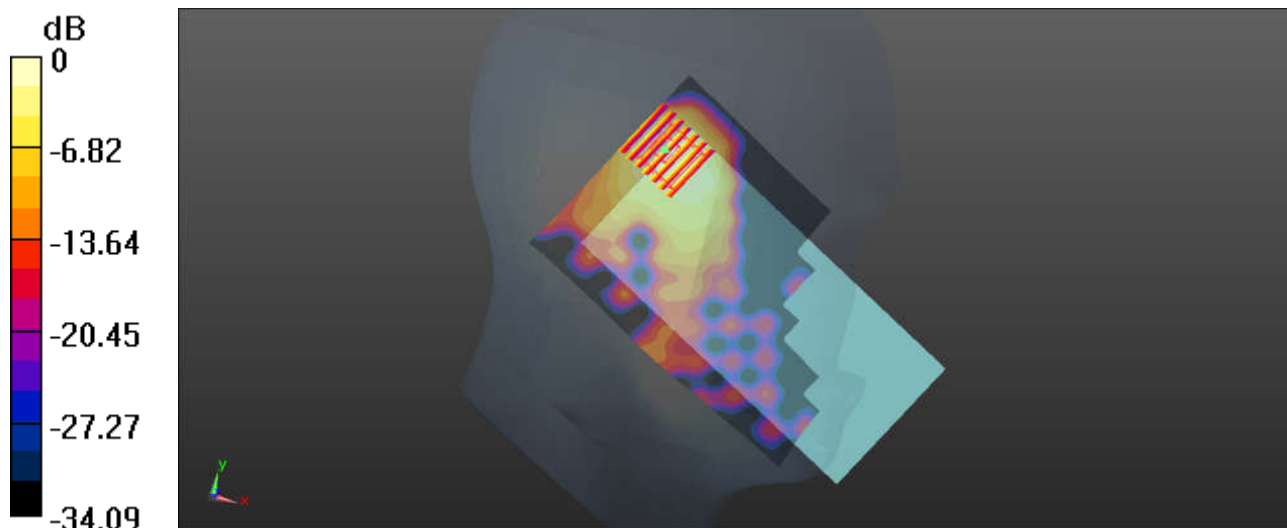

0 dB = 0.118 W/kg

18_GSM850_GPRS(2 Tx slots)_Back_10mm_Ch251

Communication System: UID 0, GPRS/EDGE10 (0); Frequency: 848.8 MHz; Duty Cycle: 1:4.15
Medium: HSL_835_200403 Medium parameters used : $f = 849$ MHz; $\sigma = 0.925$ S/m; $\epsilon_r = 40.705$;
 $\rho = 1000$ kg/m³
Ambient Temperature : 23.4 °C; Liquid Temperature : 22.5 °C

DASY5 Configuration:

- Probe: EX3DV4 - SN3753; ConvF(9.13, 9.13, 9.13); Calibrated: 2019.06.19;
- Sensor-Surface: 2mm (Mechanical Surface Detection)
- Electronics: DAE4 Sn1386 ; Calibrated: 2019.09.09
- Phantom: SAM2; Type: QD000P40CD; Serial: TP:1671
- Measurement SW: DASY52, Version 52.8 (8); SEMCAD X Version 14.6.10 (7331)

Ch251/Area Scan (71x131x1): Interpolated grid: dx=1.5mm, dy=1.5mm
Maximum value of SAR (interpolated) = 0.745 W/kg

Ch251/Zoom Scan (5x5x7)/Cube 0: Measurement grid: dx=8mm, dy=8mm, dz=5mm
Reference Value = 3.685 V/m; Power Drift = -0.09 dB
Peak SAR (extrapolated) = 0.930 W/kg
SAR(1 g) = 0.575 W/kg; SAR(10 g) = 0.370 W/kg
Maximum value of SAR (measured) = 0.661 W/kg

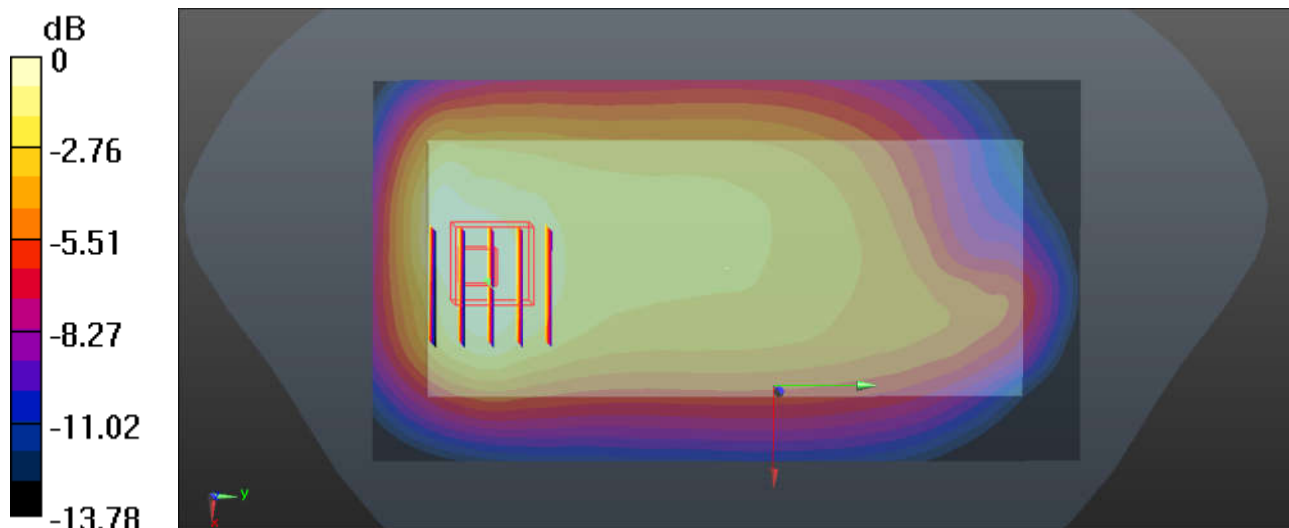

0 dB = 0.745 W/kg

19_GSM1900_GPRS(2 Tx slots)_Back_10mm_Ch810

Communication System: UID 0, GPRS/EDGE10 (0); Frequency: 1909.8 MHz; Duty Cycle: 1:4.15
Medium: HSL_1900_200423 Medium parameters used: $f = 1910$ MHz; $\sigma = 1.429$ S/m; $\epsilon_r = 40.972$;

$\rho = 1000$ kg/m³

Ambient Temperature : 23.4 °C ; Liquid Temperature : 22.6 °C

DASY5 Configuration:

- Probe: EX3DV4 - SN3753; ConvF(7.73, 7.73, 7.73); Calibrated: 2019.06.19;
- Sensor-Surface: 2mm (Mechanical Surface Detection)
- Electronics: DAE4 Sn1386 ; Calibrated: 2019.09.09
- Phantom: SAM2; Type: QD000P40CD; Serial: TP:1671
- Measurement SW: DASY52, Version 52.8 (8); SEMCAD X Version 14.6.10 (7331)

Ch810/Area Scan (71x131x1): Interpolated grid: dx=1.5mm, dy=1.5mm

Maximum value of SAR (interpolated) = 1.24 W/kg

Ch810/Zoom Scan (5x5x7)/Cube 0: Measurement grid: dx=8mm, dy=8mm, dz=5mm

Reference Value = 2.549 V/m; Power Drift = 0.08 dB

Peak SAR (extrapolated) = 1.53 W/kg

SAR(1 g) = 0.836 W/kg; SAR(10 g) = 0.423 W/kg

Maximum value of SAR (measured) = 1.04 W/kg

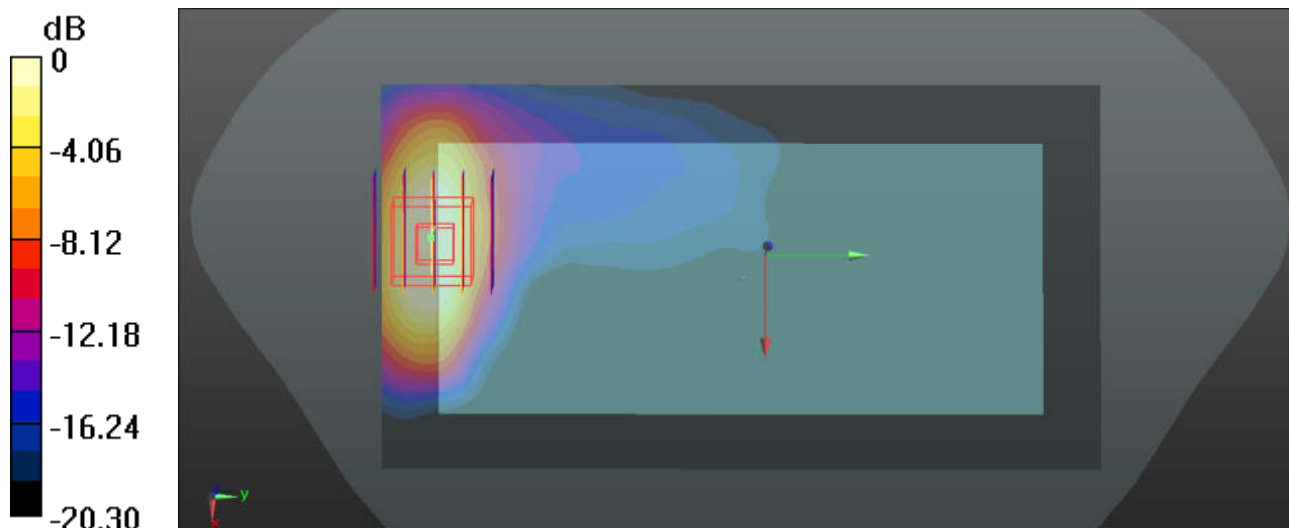

0 dB = 1.04 W/kg

20_WCDMA V_RMC 12.2Kbps_Back_10mm_Ch4233

Communication System: UID 0, UMTS (0); Frequency: 846.6 MHz; Duty Cycle: 1:1
Medium: HSL_835_200403 Medium parameters used: $f = 846.6$ MHz; $\sigma = 0.923$ S/m; $\epsilon_r = 40.736$; $\rho = 1000$ kg/m³
Ambient Temperature : 23.4 °C; Liquid Temperature : 22.5 °C

DASY5 Configuration:

- Probe: EX3DV4 - SN3753; ConvF(9.13, 9.13, 9.13); Calibrated: 2019.06.19;
- Sensor-Surface: 2mm (Mechanical Surface Detection)
- Electronics: DAE4 Sn1386 ; Calibrated: 2019.09.09
- Phantom: SAM2; Type: QD000P40CD; Serial: TP:1671
- Measurement SW: DASY52, Version 52.8 (8); SEMCAD X Version 14.6.10 (7331)

Ch4233/Area Scan (71x131x1): Interpolated grid: dx=1.5mm, dy=1.5mm
Maximum value of SAR (interpolated) = 0.465 W/kg

Ch4233/Zoom Scan (5x5x7)/Cube 0: Measurement grid: dx=8mm, dy=8mm, dz=5mm
Reference Value = 4.462 V/m; Power Drift = 0.06 dB
Peak SAR (extrapolated) = 0.608 W/kg
SAR(1 g) = 0.330 W/kg; SAR(10 g) = 0.197 W/kg
Maximum value of SAR (measured) = 0.398 W/kg

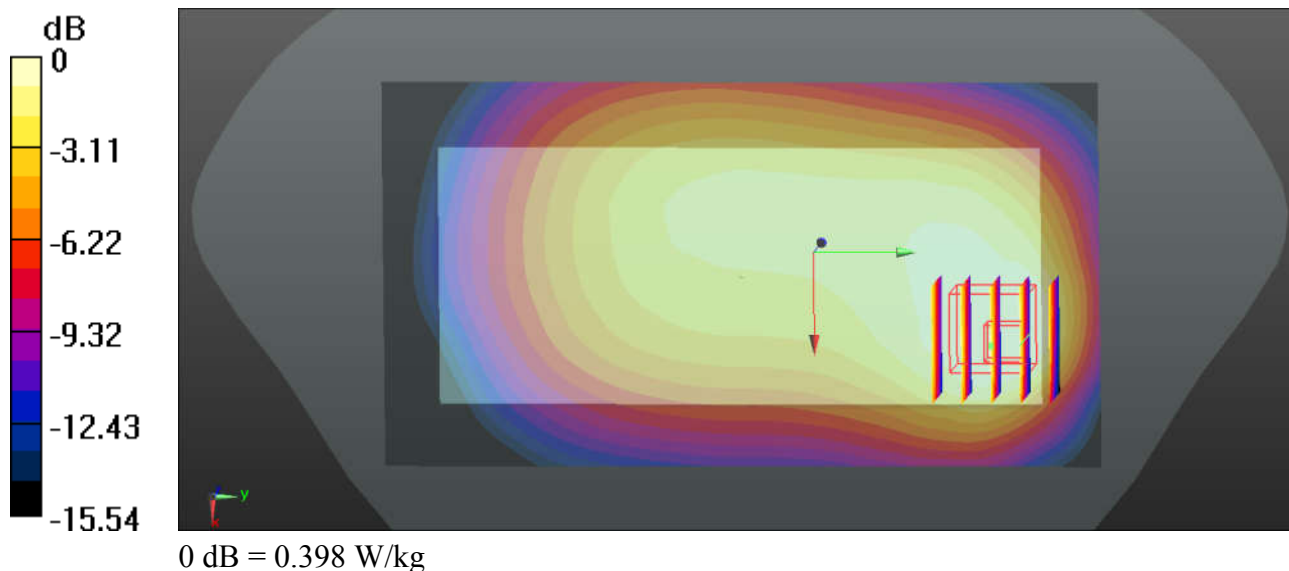

21_WCDMA IV_RMC 12.2Kbps_Back_10mm_Ch1312

Communication System: UID 0, UMTS (0); Frequency: 1712.4 MHz; Duty Cycle: 1:1
 Medium: HSL_1750_200419 Medium parameters used: $f = 1712.4$ MHz; $\sigma = 1.337$ S/m; $\epsilon_r = 41.546$;
 $\rho = 1000$ kg/m³
 Ambient Temperature : 23.3 °C ; Liquid Temperature : 22.9 °C

DASY5 Configuration:

- Probe: EX3DV4 - SN3753; ConvF(8.1, 8.1, 8.1); Calibrated: 2019.06.19;
- Sensor-Surface: 2mm (Mechanical Surface Detection)
- Electronics: DAE4 Sn1386 ; Calibrated: 2019.09.09
- Phantom: SAM2; Type: QD000P40CD; Serial: TP:1671
- Measurement SW: DASY52, Version 52.8 (8); SEMCAD X Version 14.6.10 (7331)

Ch1312/Area Scan (71x141x1): Interpolated grid: dx=1.5mm, dy=1.5mm
 Maximum value of SAR (interpolated) = 1.21 W/kg

Ch1312/Zoom Scan (5x5x7)/Cube 0: Measurement grid: dx=8mm, dy=8mm, dz=5mm
 Reference Value = 3.716 V/m; Power Drift = -0.07 dB
 Peak SAR (extrapolated) = 1.48 W/kg
SAR(1 g) = 0.826 W/kg; SAR(10 g) = 0.424 W/kg
 Maximum value of SAR (measured) = 1.04 W/kg

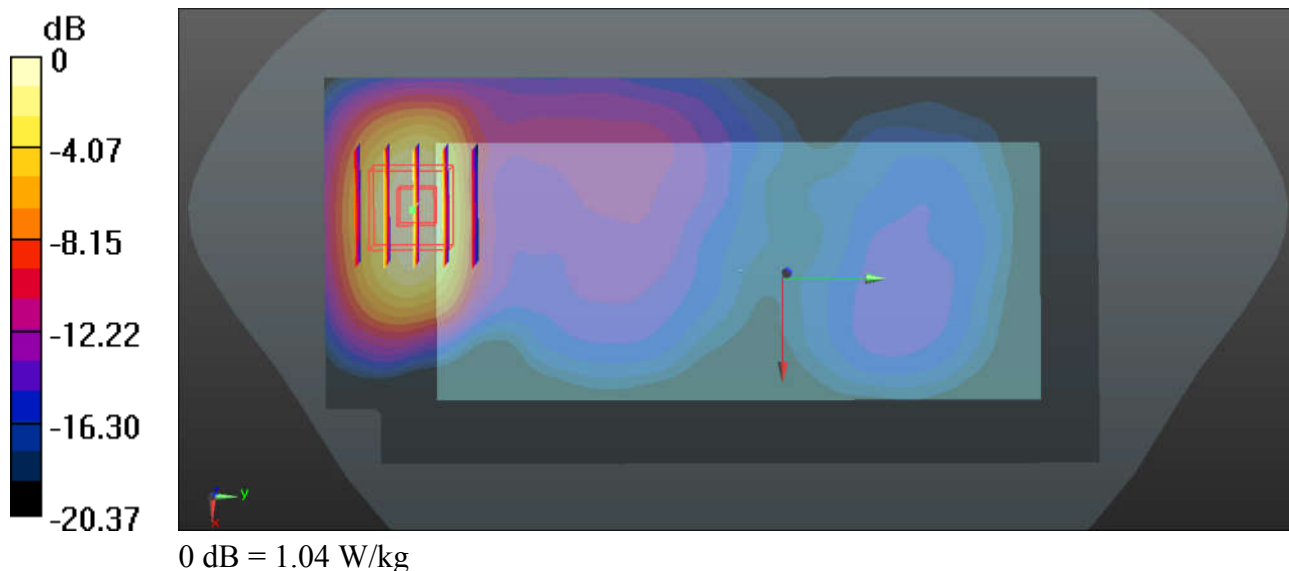

22_WCDMA II_RMC 12.2Kbps_Back_10mm_Ch9538

Communication System: UID 0, UMTS (0); Frequency: 1907.6 MHz; Duty Cycle: 1:1
Medium: HSL_1900_200423 Medium parameters used: $f = 1908$ MHz; $\sigma = 1.426$ S/m; $\epsilon_r = 40.977$;
 $\rho = 1000$ kg/m³
Ambient Temperature : 23.4 °C; Liquid Temperature : 22.6 °C

DASY5 Configuration:

- Probe: EX3DV4 - SN3753; ConvF(7.73, 7.73, 7.73); Calibrated: 2019.06.19;
- Sensor-Surface: 2mm (Mechanical Surface Detection)
- Electronics: DAE4 Sn1386 ; Calibrated: 2019.09.09
- Phantom: SAM2; Type: QD000P40CD; Serial: TP:1671
- Measurement SW: DASY52, Version 52.8 (8); SEMCAD X Version 14.6.10 (7331)

Ch9538/Area Scan (71x131x1): Interpolated grid: dx=1.5mm, dy=1.5mm
Maximum value of SAR (interpolated) = 1.61 W/kg

Ch9538/Zoom Scan (5x5x7)/Cube 0: Measurement grid: dx=8mm, dy=8mm, dz=5mm
Reference Value = 3.005 V/m; Power Drift = 0.03 dB
Peak SAR (extrapolated) = 1.96 W/kg
SAR(1 g) = 1.04 W/kg; SAR(10 g) = 0.518 W/kg
Maximum value of SAR (measured) = 1.30 W/kg

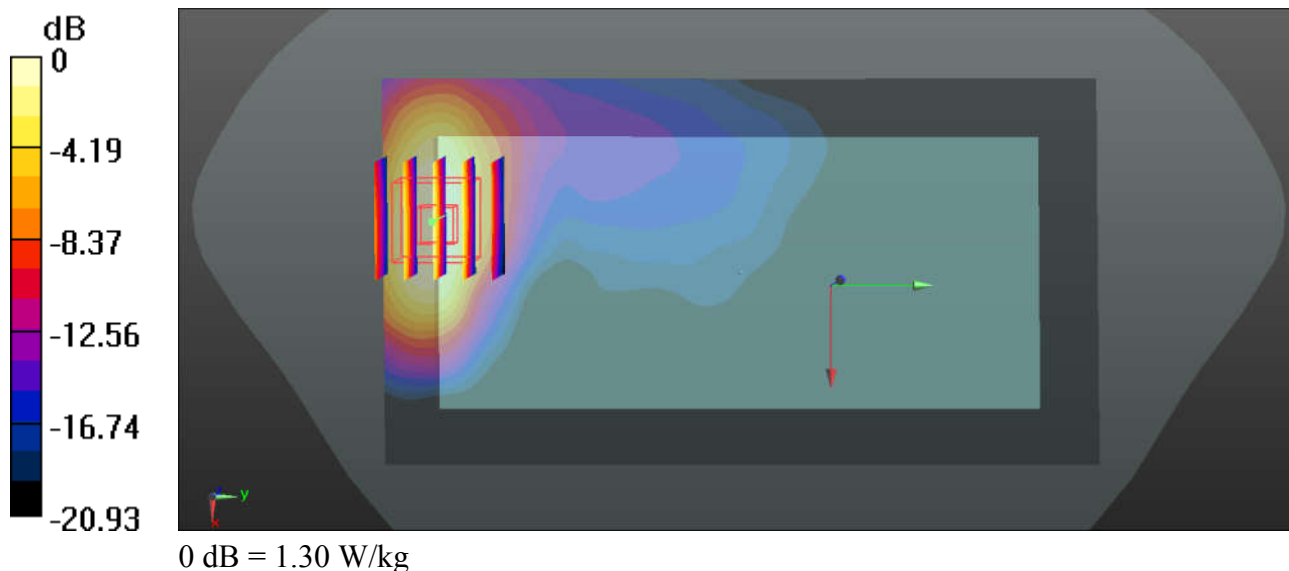

23_LTE Band 12_1.4M_QPSK_3RB_1Offset_Back_10mm_Ch23095

Communication System: UID 0, LTE (0); Frequency: 707.5 MHz; Duty Cycle: 1:1
Medium: HSL_750_200328 Medium parameters used: $f = 707.5$ MHz; $\sigma = 0.857$ S/m; $\epsilon_r = 41.645$; $\rho = 1000$ kg/m³
Ambient Temperature : 23.5 °C; Liquid Temperature : 22.4 °C

DASY5 Configuration:

- Probe: EX3DV4 - SN3753; ConvF(9.47, 9.47, 9.47); Calibrated: 2019.06.19;
- Sensor-Surface: 2mm (Mechanical Surface Detection)
- Electronics: DAE4 Sn1386 ; Calibrated: 2019.09.09
- Phantom: SAM2; Type: QD000P40CD; Serial: TP:1671
- Measurement SW: DASY52, Version 52.8 (8); SEMCAD X Version 14.6.10 (7331)

Ch23095/Area Scan (71x131x1): Interpolated grid: dx=1.5mm, dy=1.5mm
Maximum value of SAR (interpolated) = 0.313 W/kg

Ch23095/Zoom Scan (5x5x7)/Cube 0: Measurement grid: dx=8mm, dy=8mm, dz=5mm
Reference Value = 18.18 V/m; Power Drift = 0.05 dB
Peak SAR (extrapolated) = 0.330 W/kg
SAR(1 g) = 0.274 W/kg; SAR(10 g) = 0.221 W/kg
Maximum value of SAR (measured) = 0.295 W/kg

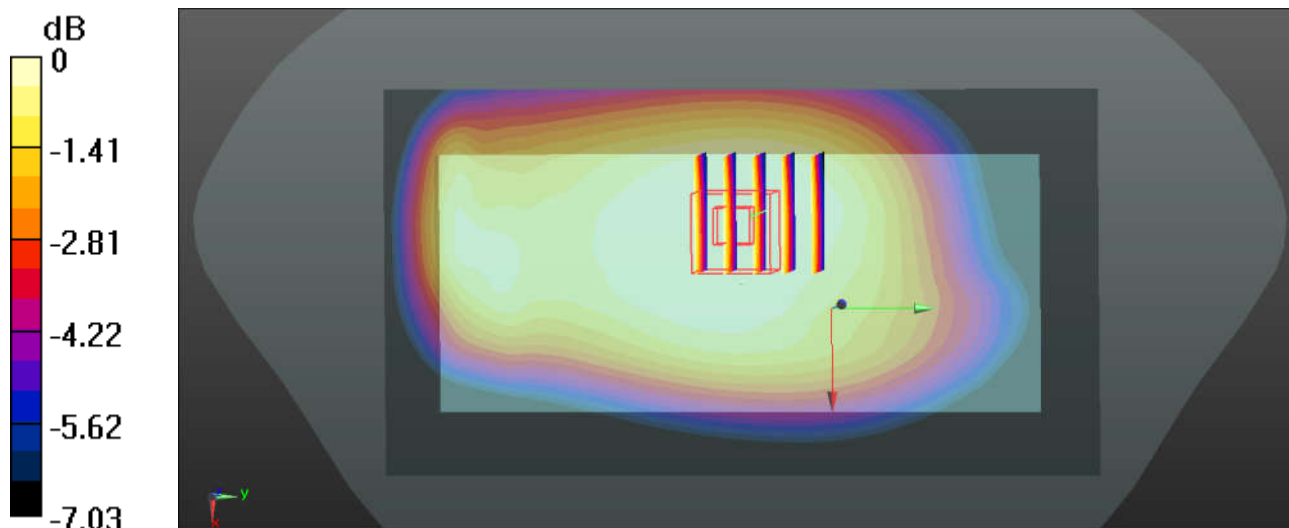

0 dB = 0.295 W/kg