



FCC RF Test Report

APPLICANT : Shenzhen Tinno Mobile Technology Corp.
EQUIPMENT : Smartphone
BRAND NAME : TINNO
MODEL NAME : U705AA, U705AC
FCC ID : XD6U705AA
STANDARD : 47 CFR Part 2, 22(H), 24(E), 27(L), 27(H)
CLASSIFICATION : PCS Licensed Transmitter Held to Ear (PCE)

The product was received on Feb. 21, 2020 and completely tested on Apr. 08, 2020. We, Sporton International (ShenZhen) Inc., would like to declare that the tested sample has been evaluated in accordance with the procedures given in ANSI C63.26-2015 and shown compliance with the applicable technical standards.

The test results in this report apply exclusively to the tested model / sample. Without written approval of Sporton International (ShenZhen) Inc., the test report shall not be reproduced except in full.

Reviewed by: Derreck Chen / Supervisor

Approved by: Eric Shih / Manager



Sporton International (ShenZhen) Inc.

1/F, 2/F, Bldg 5, Shiling Industrial Zone, Xinwei Village, Xili, Nanshan, Shenzhen, 518055

People's Republic of China



TABLE OF CONTENTS

REVISION HISTORY... 3
SUMMARY OF TEST RESULT ... 4
1 GENERAL DESCRIPTION ... 5
1.1 Applicant ... 5
1.2 Manufacturer ... 5
1.3 Product Feature of Equipment Under Test ... 5
1.4 Product Specification of Equipment Under Test ... 6
1.5 Modification of EUT ... 6
1.6 Maximum ERP/EIRP Power, Frequency Tolerance, and Emission Designator ... 7
1.7 Testing Location ... 10
1.8 Test Software ... 10
1.9 Applicable Standards ... 10
2 TEST CONFIGURATION OF EQUIPMENT UNDER TEST ... 11
2.1 Test Mode ... 11
2.2 Connection Diagram of Test System ... 13
2.3 Support Unit used in test configuration and system ... 13
2.4 Measurement Results Explanation Example ... 13
2.5 Frequency List of Low/Middle/High Channels ... 14
3 CONDUCTED TEST ITEMS ... 17
3.1 Measuring Instruments ... 17
3.2 Test Setup ... 17
3.3 Test Result of Conducted Test ... 17
3.4 Conducted Output Power and ERP/EIRP ... 18
3.5 Peak-to-Average Ratio ... 19
3.6 Occupied Bandwidth ... 20
3.7 Conducted Band Edge ... 21
3.8 Conducted Spurious Emission ... 23
3.9 Frequency Stability ... 24
4 RADIATED TEST ITEMS ... 25
4.1 Measuring Instruments ... 25
4.2 Test Setup ... 25
4.3 Test Result of Radiated Test ... 25
4.4 Radiated Spurious Emission ... 26
5 LIST OF MEASURING EQUIPMENT ... 27
6 UNCERTAINTY OF EVALUATION ... 28
APPENDIX A. TEST RESULTS OF CONDUCTED TEST
APPENDIX B. TEST RESULTS OF RADIATED TEST
APPENDIX C. TEST SETUP PHOTOGRAPHS



REVISION HISTORY

REPORT NO.	VERSION	DESCRIPTION	ISSUED DATE
FG022101B	Rev. 01	Initial issue of report	May 08, 2020



SUMMARY OF TEST RESULT

Report Section	FCC Rule	Description	Limit	Result	Remark
3.4	§2.1046	Conducted Output Power	Reporting Only	PASS	-
	§22.913(a)(5)	Effective Radiated Power (Band 5)	ERP < 7 Watt	PASS	-
	§27.50(c)(10)	Effective Radiated Power (Band 12)	ERP < 3 Watt	PASS	-
	§24.232(c)	Equivalent Isotropic Radiated Power (Band 2)	EIRP < 2Watt	PASS	-
	§27.50(d)(4)	Equivalent Isotropic Radiated Power (Band 4) (Band 66)	EIRP < 1Watt	PASS	-
3.5	§24.232(d)	Peak-to-Average Ratio	<13 dB	PASS	-
3.6	§2.1049	Occupied Bandwidth	Reporting Only	PASS	-
3.7	§2.1051 §22.917(a) §24.238(a) §27.53(g) §27.53(h)	Conducted Band Edge Measurement (Band 2) (Band 4) (Band 5) (Band 12) (Band 66)	< 43+10log ₁₀ (P[Watts])	PASS	-
3.8	§2.1051 §22.917(a) §24.238(a) §27.53(g) §27.53(h)	Conducted Spurious Emission (Band 2) (Band 4) (Band 5) (Band 12) (Band 66)	< 43+10log ₁₀ (P[Watts])	PASS	-
3.9	§2.1055 §22.355	Frequency Stability Temperature & Voltage	< 2.5 ppm for Part 22H	PASS	-
	§2.1055 §24.235 §27.54		Within Authorized Band		
4.4	§2.1053 §22.917(a) §24.238(a) §27.53(g) §27.53(h)	Radiated Spurious Emission (Band 2) (Band 4) (Band 5) (Band 12) (Band 66)	< 43+10log ₁₀ (P[Watts])	PASS	Under limit 25.25 dB at 3447.18 MHz

Declaration of Conformity:

The test results with all measurement uncertainty excluded are presented in accordance with the regulation limits or requirements declared by manufacturers.

Comments and Explanations:

The declared of product specification for EUT presented in the report are provided by the manufacturer, and the manufacturer takes all the responsibilities for the accuracy of product specification.



1 General Description

1.1 Applicant

Shenzhen Tinno Mobile Technology Corp.

4/F, H-3 Building, OCT Eastern Industrial Park. NO.1 XiangShan East Road, Nan Shan District, Shenzhen, P.R.China.

1.2 Manufacturer

Shenzhen Tinno Mobile Technology Corp.

4/F, H-3 Building, OCT Eastern Industrial Park. NO.1 XiangShan East Road, Nan Shan District, Shenzhen, P.R.China.

1.3 Product Feature of Equipment Under Test

Product Feature	
Equipment	Smartphone
Brand Name	TINNO
Model Name	U705AA, U705AC
FCC ID	XD6U705AA
EUT supports Radios application	GSM/WCDMA/LTE WLAN 2.4GHz 802.11b/g/n HT20 WLAN 5GHz 802.11a/n/ac HT20/HT40/VHT20/VHT40/VHT80 Bluetooth BR/EDR/LE NFC and GNSS
IMEI Code	Conducted: 865638040007008 for LTE B2/5 865638040006414 for LTE B4/12/B66 Radiation: 865638040006414
HW Version	V1.0
SW Version	For U705AA: U705AAV01.16.11 For U705AC: U705ACV01.43.01
EUT Stage	Identical Prototype

Remark:

1. The above EUT's information was declared by manufacturer. Please refer to the specifications or user's manual for more detailed description.
2. There are two types of EUT sample 1(Model Name: U705AA) and sample 2(Model Name: U705AC), the change note could be referred to the product equality declaration which is exhibit separately. According to the difference, we chose the sample 1 to perform all tests.



1.4 Product Specification of Equipment Under Test

Standards-related Product Specification	
Tx Frequency	LTE Band 2 : 1850.7 MHz ~ 1909.3 MHz LTE Band 4 : 1710.7 MHz ~ 1754.3 MHz LTE Band 5 : 824.7 MHz ~ 848.3 MHz LTE Band 12 : 699.7 MHz ~ 715.3 MHz LTE Band 66 : 1710.7 MHz ~ 1779.3 MHz
Rx Frequency	LTE Band 2 : 1930.7 MHz ~ 1989.3 MHz LTE Band 4 : 2110.7 MHz ~ 2154.3 MHz LTE Band 5 : 869.7 MHz ~ 893.3 MHz LTE Band 12 : 729.7 MHz ~ 745.3 MHz LTE Band 66 : 2110.7 MHz~ 2179.3 MHz
Bandwidth	LTE Band 2 : 1.4MHz / 3MHz / 5MHz / 10MHz / 15MHz / 20MHz LTE Band 4 : 1.4MHz / 3MHz / 5MHz / 10MHz / 15MHz / 20MHz LTE Band 5 : 1.4MHz / 3MHz / 5MHz / 10MHz LTE Band 12 : 1.4MHz / 3MHz / 5MHz / 10MHz LTE Band 66 : 1.4MHz / 3MHz / 5MHz / 10MHz / 15MHz / 20MHz
Maximum Output Power to Antenna	LTE Band 2 : 24.30 dBm LTE Band 4 : 23.86 dBm LTE Band 5 : 24.21 dBm LTE Band 12 : 24.18 dBm LTE Band 66 : 23.53 dBm
Antenna Gain	LTE Band 2 : -0.30 dBi LTE Band 4 : -0.80 dBi LTE Band 5 : -1.50 dBi LTE Band 12 : -2.00 dBi LTE Band 66 : -0.80 dBi
Type of Modulation	QPSK / 16QAM / 64QAM

1.5 Modification of EUT

No modifications are made to the EUT during all test items.



1.6 Maximum ERP/EIRP Power, Frequency Tolerance, and Emission Designator

LTE Band 2		QPSK			16QAM		
BW (MHz)	Frequency Range (MHz)	Emission Designator (99%OBW)	Frequency Tolerance (ppm)	Maximum EIRP(W)	Emission Designator (99%OBW)	Frequency Tolerance (ppm)	Maximum EIRP(W)
1.4	1850.7 ~ 1909.3	1M09G7D	-	0.2455	1M09W7D	-	0.2042
3	1851.5 ~ 1908.5	2M71G7D	-	0.2312	2M72W7D	-	0.1972
5	1852.5 ~ 1907.5	4M50G7D	-	0.2427	4M50W7D	-	0.2061
10	1855.0 ~ 1905.0	9M07G7D	0.0016	0.2388	9M05W7D	-	0.2037
15	1857.5 ~ 1902.5	13M5G7D	-	0.2460	13M5W7D	-	0.2089
20	1860.0 ~ 1900.0	17M9G7D	-	0.2512	17M9W7D	-	0.2113
LTE Band 2		64QAM					
BW (MHz)	Frequency Range (MHz)	Emission Designator (99%OBW)	Frequency Tolerance (ppm)		Maximum EIRP(W)		
1.4	1850.7 ~ 1909.3	1M09W7D	-		0.1626		
3	1851.5 ~ 1908.5	2M71W7D	-		0.1524		
5	1852.5 ~ 1907.5	4M49W7D	-		0.1600		
10	1855.0 ~ 1905.0	9M07W7D	-		0.1667		
15	1857.5 ~ 1902.5	13M5W7D	-		0.1667		
20	1860.0 ~ 1900.0	17M9W7D	-		0.1603		
LTE Band 4		QPSK			16QAM		
BW (MHz)	Frequency Range (MHz)	Emission Designator (99%OBW)	Frequency Tolerance (ppm)	Maximum EIRP(W)	Emission Designator (99%OBW)	Frequency Tolerance (ppm)	Maximum EIRP(W)
1.4	1710.7 ~ 1754.3	1M09G7D	-	0.2014	1M10W7D	-	0.1667
3	1711.5 ~ 1753.5	2M72G7D	-	0.1901	2M71W7D	-	0.1600
5	1712.5 ~ 1752.5	4M50G7D	-	0.1977	4M50W7D	-	0.1648
10	1715.0 ~ 1750.0	9M07G7D	0.0126	0.1968	9M03W7D	-	0.1679
15	1717.5 ~ 1747.5	13M5G7D	-	0.1977	13M5W7D	-	0.1667
20	1720.0 ~ 1745.0	17M9G7D	-	0.2023	17M9W7D	-	0.1660



LTE Band 4		64QAM					
BW (MHz)	Frequency Range (MHz)	Emission Designator (99%OBW)		Frequency Tolerance (ppm)		Maximum EIRP(W)	
1.4	1710.7 ~ 1754.3	1M09W7D		-		0.1288	
3	1711.5 ~ 1753.5	2M73W7D		-		0.1276	
5	1712.5 ~ 1752.5	4M48W7D		-		0.1371	
10	1715.0 ~ 1750.0	9M07W7D		-		0.1390	
15	1717.5 ~ 1747.5	13M5W7D		-		0.1300	
20	1720.0 ~ 1745.0	17M9W7D		-		0.1300	
LTE Band 5		QPSK			16QAM		
BW (MHz)	Frequency Range (MHz)	Emission Designator (99%OBW)	Frequency Tolerance (ppm)	Maximum ERP(W)	Emission Designator (99%OBW)	Frequency Tolerance (ppm)	Maximum ERP(W)
1.4	824.7 ~ 848.3	1M09G7D	-	0.1135	1M10W7D	-	0.0920
3	825.5 ~ 847.5	2M72G7D	-	0.1132	2M72W7D	-	0.0918
5	826.5 ~ 846.5	4M49G7D	-	0.1132	4M49W7D	-	0.0923
10	829.0 ~ 844.0	9M13G7D	0.0017	0.1138	9M03W7D	-	0.0957
LTE Band 5		64QAM					
BW (MHz)	Frequency Range (MHz)	Emission Designator (99%OBW)		Frequency Tolerance (ppm)		Maximum ERP(W)	
1.4	824.7 ~ 848.3	1M09W7D		-		0.0726	
3	825.5 ~ 847.5	2M73W7D		-		0.0733	
5	826.5 ~ 846.5	4M50W7D		-		0.0733	
10	829.0 ~ 844.0	9M07W7D		-		0.0767	
LTE Band 12		QPSK			16QAM		
BW (MHz)	Frequency Range (MHz)	Emission Designator (99%OBW)	Frequency Tolerance (ppm)	Maximum ERP(W)	Emission Designator (99%OBW)	Frequency Tolerance (ppm)	Maximum ERP(W)
1.4	699.7 ~ 715.3	1M10G7D	-	0.1007	1M09W7D	-	0.0793
3	700.5 ~ 714.5	2M72G7D	-	0.0787	2M72W7D	-	0.0630
5	701.5 ~ 713.5	4M51G7D	-	0.0804	4M53W7D	-	0.0632
10	704.0 ~ 711.0	9M07G7D	0.0192	0.0815	9M09W7D	-	0.0634



LTE Band 12		64QAM					
BW (MHz)	Frequency Range (MHz)	Emission Designator (99%OBW)		Frequency Tolerance (ppm)		Maximum EIRP(W)	
1.4	699.7 ~ 715.3	1M09W7D		-		0.0647	
3	700.5 ~ 714.5	2M74W7D		-		0.0500	
5	701.5 ~ 713.5	4M52W7D		-		0.0509	
10	704.0 ~ 711.0	9M09W7D		-		0.0507	
LTE Band 66		QPSK			16QAM		
BW (MHz)	Frequency Range (MHz)	Emission Designator (99%OBW)	Frequency Tolerance (ppm)	Maximum EIRP(W)	Emission Designator (99%OBW)	Frequency Tolerance (ppm)	Maximum EIRP(W)
1.4	1710.7 ~ 1779.3	1M09G7D	-	0.1875	1M10W7D	-	0.1483
3	1711.5 ~ 1778.5	2M72G7D	-	0.1489	2M72W7D	-	0.1216
5	1712.5 ~ 1777.5	4M51G7D	-	0.1507	4M50W7D	-	0.1205
10	1715.0 ~ 1775.0	9M07G7D	0.0191	0.1500	9M09W7D	-	0.1208
15	1717.5 ~ 1772.5	13M5G7D	-	0.1517	13M5W7D	-	0.1202
20	1720.0 ~ 1770.0	18M0G7D	-	0.1578	18M0W7D	-	0.1256
LTE Band 66		64QAM					
BW (MHz)	Frequency Range (MHz)	Emission Designator (99%OBW)		Frequency Tolerance (ppm)		Maximum EIRP(W)	
1.4	1710.7 ~ 1779.3	1M09W7D		-		0.1216	
3	1711.5 ~ 1778.5	2M73W7D		-		0.0953	
5	1712.5 ~ 1777.5	4M52W7D		-		0.0957	
10	1715.0 ~ 1775.0	9M07W7D		-		0.0955	
15	1717.5 ~ 1772.5	13M5W7D		-		0.0959	
20	1720.0 ~ 1770.0	17M9W7D		-		0.0998	



1.7 Testing Location

Sporton International (Shenzhen) Inc. is accredited to ISO/IEC 17025:2017 by American Association for Laboratory Accreditation with Certificate Number 5145.01.

Test Firm	Sporton International (Shenzhen) Inc.		
Test Site Location	1/F, 2/F, Bldg 5, Shiling Industrial Zone, Xinwei Village, Xili, Nanshan, Shenzhen, 518055 People's Republic of China TEL: +86-755-86379589 FAX: +86-755-86379595		
Test Site No.	Sporton Site No.	FCC Designation No.	FCC Test Firm Registration No.
	TH01-SZ	CN1256	421272

Test Firm	Sporton International (Shenzhen) Inc.		
Test Site Location	No. 3 Bldg the third floor of south, Shahe River west, Fengzeyuan Warehouse, Nanshan Shenzhen, 518055 People's Republic of China TEL: +86-755-33202398		
Test Site No.	Sporton Site No.	FCC Designation No.	FCC Test Firm Registration No.
	03CH01-SZ	CN1256	421272

1.8 Test Software

Item	Site	Manufacture	Name	Version
1.	03CH01-SZ	AUDIX	E3	6.2009-8-24

1.9 Applicable Standards

According to the specifications of the manufacturer, the EUT must comply with the requirements of the following standards:

- ♦ 47 CFR Part 2, 22(H), 24(E), 27(L), 27(H)
- ♦ ANSI C63.26-2015
- ♦ FCC KDB 971168 D01 Power Meas License Digital Systems v03r01
- ♦ FCC KDB 412172 D01 Determining ERP and EIRP v01r01

Remark:

1. All test items were verified and recorded according to the standards and without any deviation during the test.
2. This EUT has also been tested and complied with the requirements of FCC Part 15, Subpart B, recorded in a separate test report.



2 Test Configuration of Equipment Under Test

2.1 Test Mode

Antenna port conducted and radiated test items listed below are performed according to KDB 971168 D01 Power Meas License Digital Systems v03r01 with maximum output power.

Radiated measurements are performed by rotating the EUT in three different orthogonal test planes to find the maximum emission.

Test Items	Band	Bandwidth (MHz)						Modulation			RB #			Test Channel		
		1.4	3	5	10	15	20	QPSK	16QAM	64QAM	1	Half	Full	L	M	H
Max. Output Power	2	v	v	v	v	v	v	v	v	v	v	v	v	v	v	v
	4	v	v	v	v	v	v	v	v	v	v	v	v	v	v	v
	5	v	v	v	v	-	-	v	v	v	v	v	v	v	v	v
	12	v	v	v	v	-	-	v	v	v	v	v	v	v	v	v
	66	v	v	v	v	v	v	v	v	v	v	v	v	v	v	v
Peak-to-Average Ratio	2						v	v	v	v	v		v	v	v	v
	4						v	v	v	v	v		v	v	v	v
	5				v	-	-	v	v	v	v		v	v	v	v
	12				v	-	-	v	v	v	v		v	v	v	v
	66						v	v	v	v	v		v	v	v	v
26dB and 99% Bandwidth	2	v	v	v	v	v	v	v	v	v			v	v	v	v
	4	v	v	v	v	v	v	v	v	v			v	v	v	v
	5	v	v	v	v	-	-	v	v	v			v	v	v	v
	12	v	v	v	v	-	-	v	v	v			v	v	v	v
	66	v	v	v	v	v	v	v	v	v			v	v	v	v
Conducted Band Edge	2	v	v	v	v	v	v	v	v	v	v		v	v		v
	4	v	v	v	v	v	v	v	v	v	v		v	v		v
	5	v	v	v	v	-	-	v	v	v	v		v	v		v
	12	v	v	v	v	-	-	v	v	v	v		v	v		v
	66	v	v	v	v	v	v	v	v	v	v		v	v		v



Test Items	Band	Bandwidth (MHz)						Modulation			RB #			Test Channel		
		1.4	3	5	10	15	20	QPSK	16QAM	64QAM	1	Half	Full	L	M	H
Conducted Spurious Emission	2	v	v	v	v	v	v	v	v	v	v			v	v	v
	4	v	v	v	v	v	v	v	v	v	v			v	v	v
	5	v	v	v	v	-	-	v	v	v	v			v	v	v
	12	v	v	v	v	-	-	v	v	v	v			v	v	v
	66	v	v	v	v	v	v	v	v	v	v			v	v	v
Frequency Stability	2				v			v					v		v	
	4				v			v					v		v	
	5				v	-	-	v					v		v	
	12				v	-	-	v					v		v	
	66				v			v					v		v	
E.R.P / E.I.R.P	2	v	v	v	v	v	v	v	v	v	v			v	v	v
	4	v	v	v	v	v	v	v	v	v	v			v	v	v
	5	v	v	v	v	-	-	v	v	v	v			v	v	v
	12	v	v	v	v	-	-	v	v	v	v			v	v	v
	66	v	v	v	v	v	v	v	v	v	v			v	v	v
Radiated Spurious Emission	2	v	v	v	v	v	v	v			v				v	
	4	v	v	v	v	v	v	v			v				v	
	5	v	v	v	v	-	-	v			v				v	
	12	v	v	v	v	-	-	v			v				v	
	66	v	v	v	v	v	v	v			v				v	
Note	<ol style="list-style-type: none"> The mark "v" means that this configuration is chosen for testing The mark "-" means that this bandwidth is not supported. The device is investigated from 30MHz to 10 times of fundamental signal for radiated spurious emission test under different RB size/offset and modulations in exploratory test. Subsequently, only the worst case emissions are reported. 															

2.2 Connection Diagram of Test System

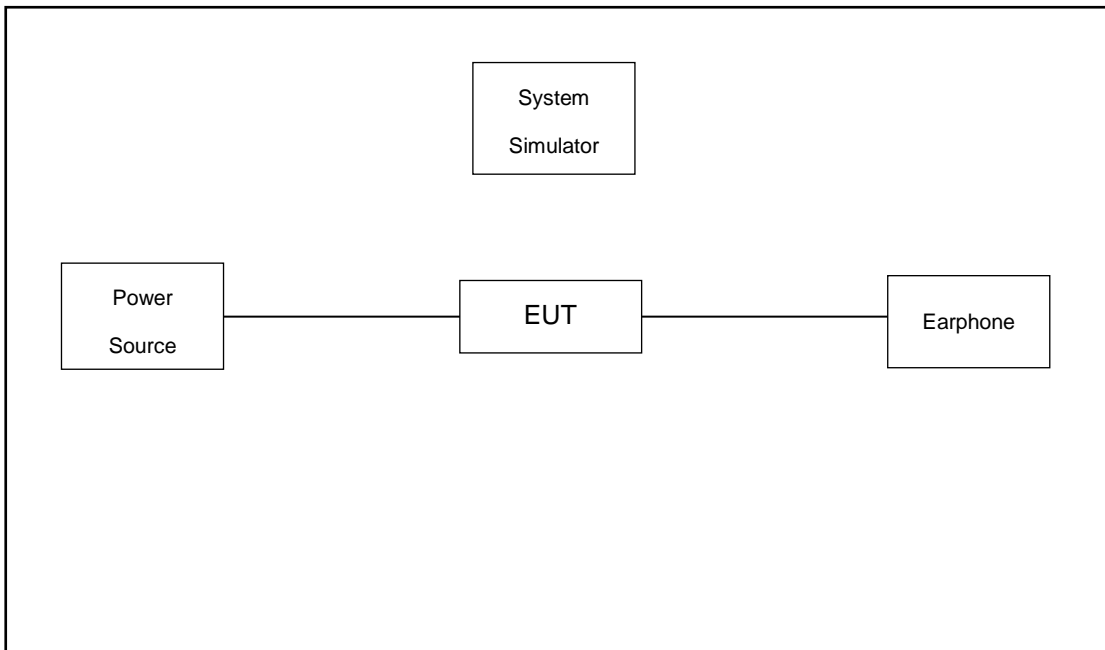

2.3 Support Unit used in test configuration and system

Item	Equipment	Trade Name	Model No.	FCC ID	Data Cable	Power Cord
1.	Power Supply	GWINSTEK	PSS-2002	N/A	N/A	Unshielded, 1.8 m
2.	LTE Base Station	Anritsu	MT8820C	N/A	N/A	Unshielded, 1.8 m
3.	Earphone	Lenovo	SH100	N/A	Unshielded, 1.2m	N/A

2.4 Measurement Results Explanation Example

For all conducted test items:

The offset level is set in the spectrum analyzer to compensate the RF cable loss and attenuator factor between EUT conducted output port and spectrum analyzer. With the offset compensation, the spectrum analyzer reading level is exactly the EUT RF output level.

The spectrum analyzer offset is derived from RF cable loss and attenuator factor.

Offset = RF cable loss + attenuator factor.

Following shows an offset computation example with cable loss 4.5 dB and 10dB attenuator.

Example :

$$\begin{aligned}
 \text{Offset}(dB) &= \text{RF cable loss}(dB) + \text{attenuator factor}(dB). \\
 &= 4.5 + 10 = 14.5 \text{ (dB)}
 \end{aligned}$$



2.5 Frequency List of Low/Middle/High Channels

LTE Band 2 Channel and Frequency List				
BW [MHz]	Channel/Frequency(MHz)	Lowest	Middle	Highest
20	Channel	18700	18900	19100
	Frequency	1860	1880	1900
15	Channel	18675	18900	19125
	Frequency	1857.5	1880	1902.5
10	Channel	18650	18900	19150
	Frequency	1855	1880	1905
5	Channel	18625	18900	19175
	Frequency	1852.5	1880	1907.5
3	Channel	18615	18900	19185
	Frequency	1851.5	1880	1908.5
1.4	Channel	18607	18900	19193
	Frequency	1850.7	1880	1909.3

LTE Band 4 Channel and Frequency List				
BW [MHz]	Channel/Frequency(MHz)	Lowest	Middle	Highest
20	Channel	20050	20175	20300
	Frequency	1720	1732.5	1745
15	Channel	20025	20175	20325
	Frequency	1717.5	1732.5	1747.5
10	Channel	20000	20175	20350
	Frequency	1715	1732.5	1750
5	Channel	19975	20175	20375
	Frequency	1712.5	1732.5	1752.5
3	Channel	19965	20175	20385
	Frequency	1711.5	1732.5	1753.5
1.4	Channel	19957	20175	20393
	Frequency	1710.7	1732.5	1754.3



LTE Band 5 Channel and Frequency List				
BW [MHz]	Channel/Frequency(MHz)	Lowest	Middle	Highest
10	Channel	20450	20525	20600
	Frequency	829	836.5	844
5	Channel	20425	20525	20625
	Frequency	826.5	836.5	846.5
3	Channel	20415	20525	20635
	Frequency	825.5	836.5	847.5
1.4	Channel	20407	20525	20643
	Frequency	824.7	836.5	848.3

LTE Band 12 Channel and Frequency List				
BW [MHz]	Channel/Frequency(MHz)	Lowest	Middle	Highest
10	Channel	23060	23095	23130
	Frequency	704	707.5	711
5	Channel	23035	23095	23155
	Frequency	701.5	707.5	713.5
3	Channel	23025	23095	23165
	Frequency	700.5	707.5	714.5
1.4	Channel	23017	23095	23173
	Frequency	699.7	707.5	715.3



LTE Band 66 Channel and Frequency List				
BW [MHz]	Channel/Frequency(MHz)	Lowest	Middle	Highest
20	Channel	132072	132322	132572
	Frequency	1720	1745	1770
15	Channel	132047	132322	132597
	Frequency	1717.5	1745	1772.5
10	Channel	132022	132322	132622
	Frequency	1715	1745	1775
5	Channel	131997	132322	132647
	Frequency	1712.5	1745	1777.5
3	Channel	131987	132322	132657
	Frequency	1711.5	1745	1778.5
1.4	Channel	131979	132322	132665
	Frequency	1710.7	1745	1779.3

3 Conducted Test Items

3.1 Measuring Instruments

See list of measuring instruments of this test report.

3.2 Test Setup

3.2.1 Conducted Output Power

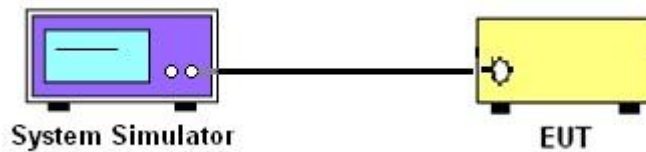

3.2.2 Peak-to-Average Ratio, Occupied Bandwidth ,Conducted Band-Edge and Conducted Spurious Emission



3.2.3 Frequency Stability

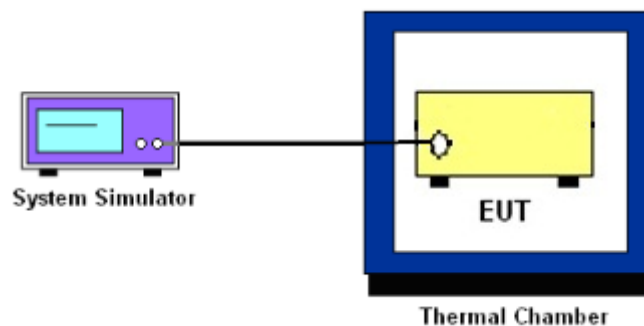

3.3 Test Result of Conducted Test

Please refer to Appendix A.



3.4 Conducted Output Power and ERP/EIRP

3.4.1 Description of the Conducted Output Power Measurement and ERP/EIRP Measurement

A system simulator was used to establish communication with the EUT. Its parameters were set to force the EUT transmitting at maximum output power. The measured power in the radio frequency on the transmitter output terminals shall be reported.

The ERP of mobile transmitters must not exceed 7 Watts for LTE Band 5.

The ERP of mobile transmitters must not exceed 3 Watts for LTE Band 12.

The EIRP of mobile transmitters must not exceed 2 Watts for LTE Band 2.

The EIRP of mobile transmitters must not exceed 1 Watts for LTE Band 4 and Band 66.

According to KDB 412172 D01 Power Approach,

$EIRP = P_T + G_T - L_C$, $ERP = EIRP - 2.15$, where

P_T = transmitter output power in dBm

G_T = gain of the transmitting antenna in dBi

L_C = signal attenuation in the connecting cable between the transmitter and antenna in dB

3.4.2 Test Procedures

1. The testing follows ANSI C63.26 Section 5.2
2. The transmitter output port was connected to the system simulator.
3. Set EUT at maximum power through the system simulator.
4. Select lowest, middle, and highest channels for each band and different modulation.
5. Measure and record the power level from the system simulator.



3.5 Peak-to-Average Ratio

3.5.1 Description of the PAR Measurement

Power Complementary Cumulative Distribution Function (CCDF) curves provide a means for characterizing the power peaks of a digitally modulated signal on a statistical basis. A CCDF curve depicts the probability of the peak signal amplitude exceeding the average power level. Most contemporary measurement instrumentation include the capability to produce CCDF curves for an input signal provided that the instrument's resolution bandwidth can be set wide enough to accommodate the entire input signal bandwidth. In measuring transmissions in this band using an average power technique, the peak-to-average ratio (PAR) of the transmission may not exceed 13 dB.

3.5.2 Test Procedures

1. The testing follows ANSI C63.26 Section 5.2.3.4 (CCDF).
2. The EUT was connected to spectrum and system simulator via a power divider.
3. Set the CCDF (Complementary Cumulative Distribution Function) option in spectrum analyzer.
4. The highest RF powers were measured and recorded the maximum PAPR level associated with a probability of 0.1 %.
5. Record the deviation as Peak to Average Ratio.



3.6 Occupied Bandwidth

3.6.1 Description of Occupied Bandwidth Measurement

The occupied bandwidth is the width of a frequency band such that, below the lower and above the upper frequency limits, the mean powers emitted are each equal to a specified percentage 0.5% of the total mean transmitted power.

The 26 dB emission bandwidth is defined as the frequency range between two points, one above and one below the carrier frequency, at which the spectral density of the emission is attenuated 26 dB below the maximum in-band spectral density of the modulated signal. Spectral density (power per unit bandwidth) is to be measured with a detector of resolution bandwidth equal to approximately 1.0% of the emission bandwidth.

3.6.2 Test Procedures

1. The testing follows ANSI C63.26 Section 5.4
2. The EUT was connected to spectrum analyzer and system simulator via a power divider.
3. The spectrum analyzer center frequency is set to the nominal EUT channel center frequency. The span range for the spectrum analyzer shall be between two and five times the anticipated OBW.
4. The nominal resolution bandwidth (RBW) shall be in the range of 1 to 5 % of the anticipated OBW, and the VBW shall be at least 3 times the RBW.
5. Set the detection mode to peak, and the trace mode to max hold.
6. Determine the reference value: Set the EUT to transmit a modulated signal. Allow the trace to stabilize. Set the spectrum analyzer marker to the highest level of the displayed trace.
(this is the reference value)
7. Determine the “-26 dB down amplitude” as equal to (Reference Value – X).
8. Place two markers, one at the lowest and the other at the highest frequency of the envelope of the spectral display such that each marker is at or slightly below the “-X dB down amplitude” determined in step 6. If a marker is below this “-X dB down amplitude” value it shall be placed as close as possible to this value. The OBW is the positive frequency difference between the two markers.
9. Use the 99 % power bandwidth function of the spectrum analyzer and report the measured bandwidth.



3.7 Conducted Band Edge

3.7.1 Description of Conducted Band Edge Measurement

22.917(a)

For operations in the 824 – 849 MHz band, the FCC limit is $43 + 10\log_{10}(P[\text{Watts}])$ dB below the transmitter power $P(\text{Watts})$ in a 100kHz bandwidth. However, in the 1MHz bands immediately outside and adjacent to the licensee's frequency block, a resolution bandwidth of at least one percent of the emission bandwidth of the fundamental emission of the transmitter may be employed.

24.238 (a)

For operations in the 1850-1910 and 1930-1990 MHz band, the FCC limit is $43 + 10\log_{10}(P[\text{Watts}])$ dB below the transmitter power $P(\text{Watts})$ in a 1MHz bandwidth. However, in the 1 MHz bands immediately outside and adjacent to the frequency block a resolution bandwidth of at least one percent of the emission bandwidth of the fundamental emission of the transmitter may be employed.

27.53 (g)

For operations in the 600MHz band and 698 -746 MHz band, the FCC limit is $43 + 10\log_{10}(P[\text{Watts}])$ dB below the transmitter power $P(\text{Watts})$ in a 100 kHz bandwidth. However, in the 100 kilohertz bands immediately outside and adjacent to a licensee's frequency block, a resolution bandwidth of at least 30 kHz may be employed.

27.53 (h)

For operations in the 1710 – 1755 MHz band, the FCC limit is $43 + 10\log_{10}(P[\text{Watts}])$ dB below the transmitter power $P(\text{Watts})$ in a 1 MHz bandwidth. However, in the 1MHz bands immediately outside and adjacent to the licensee's frequency block, a resolution bandwidth of at least one percent of the emission bandwidth of the fundamental emission of the transmitter may be employed.



3.7.2 Test Procedures

1. The testing follows ANSI C63.26 section 5.7
2. The EUT was connected to spectrum analyzer and system simulator via a power divider.
3. The band edges of low and high channels for the highest RF powers were measured.
4. Set RBW \geq 1% EBW in the 1MHz band immediately outside and adjacent to the band edge.
5. Beyond the 1 MHz band from the band edge, RBW=1MHz was used.
6. Set spectrum analyzer with RMS detector.
7. The RF fundamental frequency should be excluded against the limit line in the operating frequency band.
8. Checked that all the results comply with the emission limit line.

Example:

The limit line is derived from $43 + 10\log(P)$ dB below the transmitter power P(Watts)
= P(W)- [43 + 10log(P)] (dB)
= [30 + 10log(P)] (dBm) - [43 + 10log(P)] (dB) = -13dBm.



3.8 Conducted Spurious Emission

3.8.1 Description of Conducted Spurious Emission Measurement

The power of any emission outside of the authorized operating frequency ranges must be lower than the transmitter power (P) by a factor of at least $43 + 10 \log (P)$ dB.

It is measured by means of a calibrated spectrum analyzer and scanned from 30 MHz up to a frequency including its 10th harmonic.

3.8.2 Test Procedures

1. The testing follows ANSI C63.26 section 5.7
2. The EUT was connected to spectrum analyzer and system simulator via a power divider.
3. The RF output of EUT was connected to the spectrum analyzer by RF cable and attenuator. The path loss was compensated to the results for each measurement.
4. The middle channel for the highest RF power within the transmitting frequency was measured.
5. The conducted spurious emission for the whole frequency range was taken.
6. Make the measurement with the spectrum analyzer's RBW = 1MHz, VBW = 3MHz.
7. Set spectrum analyzer with RMS detector.
8. Taking the record of maximum spurious emission.
9. The RF fundamental frequency should be excluded against the limit line in the operating frequency band.
10. The limit line is derived from $43 + 10\log(P)$ dB below the transmitter power P(Watts)
= P(W)- [43 + 10log(P)] (dB)
= [30 + 10log(P)] (dBm) - [43 + 10log(P)] (dB)
= -13dBm.



3.9 Frequency Stability

3.9.1 Description of Frequency Stability Measurement

The frequency stability shall be measured by variation of ambient temperature and variation of primary supply voltage to ensure that the fundamental emission stays within the authorized frequency block. The frequency stability of the transmitter shall be maintained within $\pm 0.00025\%$ ($\pm 2.5\text{ppm}$) of the center frequency.

3.9.2 Test Procedures for Temperature Variation

1. The testing follows ANSI C63.26 section 5.6.4
2. The EUT was set up in the thermal chamber and connected with the system simulator.
3. With power OFF, the temperature was decreased to -30°C and the EUT was stabilized before testing. Power was applied and the maximum change in frequency was recorded within one minute.
4. With power OFF, the temperature was raised in 10°C step up to 50°C . The EUT was stabilized at each step for at least half an hour. Power was applied and the maximum frequency change was recorded within one minute.

3.9.3 Test Procedures for Voltage Variation

1. The testing follows ANSI C63.26 section 5.6.5
2. The EUT was placed in a temperature chamber at $20\pm 5^{\circ}\text{C}$ and connected with the system simulator.
3. The power supply voltage to the EUT was varied from 85% to 115% of the nominal value for other than hand carried battery equipment.
4. For hand carried, battery powered equipment, reduce the primary ac or dc supply voltage to the battery operating end point, which shall be specified by the manufacturer.
5. The variation in frequency was measured for the worst case.

4 Radiated Test Items

4.1 Measuring Instruments

See list of measuring instruments of this test report.

4.2 Test Setup

4.2.1 For radiated test from 30MHz to 1GHz



4.2.2 For radiated test above 1GHz

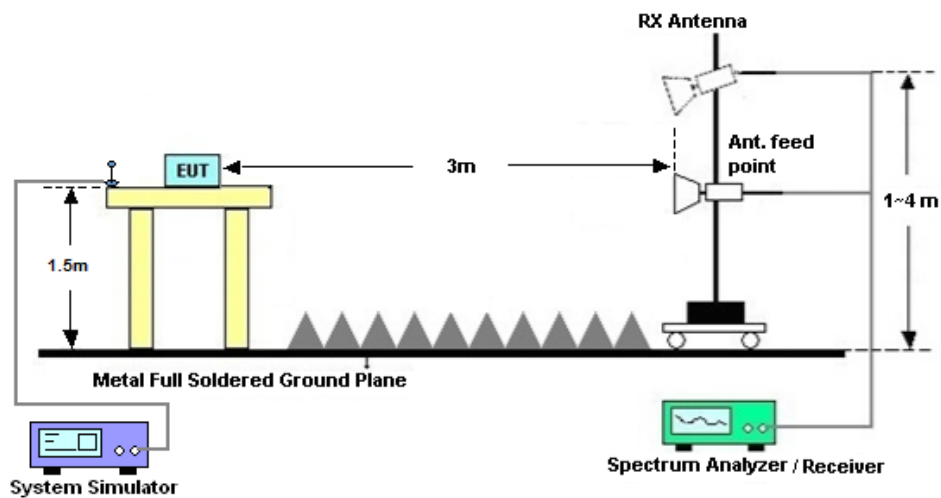

4.3 Test Result of Radiated Test

Please refer to Appendix B.



4.4 Radiated Spurious Emission

4.4.1 Description of Radiated Spurious Emission

The radiated spurious emission was measured by substitution method according to ANSI C63.26. The power of any emission outside of the authorized operating frequency ranges must be attenuated below the transmitter power (P) by a factor of at least $43 + 10 \log(P)$ dB.

The spectrum is scanned from 30 MHz up to a frequency including its 10th harmonic.

4.4.2 Test Procedures

1. The testing follows ANSI C63.26 Section 5.5
2. The EUT was placed on a turntable with 0.8 meter height for frequency below 1GHz and 1.5 meter height for frequency above 1GHz respectively above ground.
3. The EUT was set 3 meters from the receiving antenna mounted on the antenna tower.
4. The table was rotated 360 degrees to determine the position of the highest spurious emission.
5. The height of the receiving antenna is varied between 1m to 4m to search the maximum spurious emission for both horizontal and vertical polarizations.
6. During the measurement, the system simulator parameters were set to force the EUT transmitting at maximum output power.
7. Make the measurement with the spectrum analyzer's RBW = 1MHz, VBW = 3MHz, taking the record of maximum spurious emission.
8. A horn antenna was substituted in place of the EUT and was driven by a signal generator.
9. Tune the output power of signal generator to the same emission level with EUT maximum spurious emission.
10. $EIRP \text{ (dBm)} = S.G. \text{ Power} - Tx \text{ Cable Loss} + Tx \text{ Antenna Gain}$
11. $ERP \text{ (dBm)} = EIRP - 2.15$
12. The RF fundamental frequency should be excluded against the limit line in the operating frequency band.

The limit line is derived from $43 + 10\log(P)$ dB below the transmitter power P(Watts)
= $P(W) - [43 + 10\log(P)] \text{ (dB)}$
= $[30 + 10\log(P)] \text{ (dBm)} - [43 + 10\log(P)] \text{ (dB)}$
= -13dBm.



5 List of Measuring Equipment

Instrument	Manufacturer	Model No.	Serial No.	Characteristics	Calibration Date	Test Date	Due Date	Remark
Spectrum Analyzer	R&S	FSV40	101078	10Hz~40GHz	Apr. 18, 2019	Mar. 09, 2020~ Apr. 08, 2020	Apr. 17, 2020	Conducted (TH01-SZ)
DC Power Supply	GWINSTEK	AnritsuGPS-3030D	EM882636	Max 30V	Apr. 18, 2019	Mar. 09, 2020~ Apr. 08, 2020	Apr. 17, 2020	Conducted (TH01-SZ)
Thermal Chamber	Ten Billion Hongzhangroup	LP-150U	H2014081803	-40~+150°C	Dec. 26, 2019	Mar. 09, 2020~ Apr. 08, 2020	Dec. 25, 2020	Conducted (TH01-SZ)
EMI Test Receiver&SA	Agilent	N9038A	MY52260185	20Hz~26.5GHz	Jul. 22, 2019	Mar. 10, 2020~ Mar. 11, 2020	Jul. 21, 2020	Radiation (03CH01-SZ)
Bilog Antenna	TeseQ	CBL6112D	35407	30MHz-2GHz	Jul. 19, 2019	Mar. 10, 2020~ Mar. 11, 2020	Jul. 18, 2020	Radiation (03CH01-SZ)
Double Ridge Horn Antenna	ETS-Lindgren	3117	00119436	1GHz~18GHz	Aug. 27, 2019	Mar. 10, 2020~ Mar. 11, 2020	Aug. 26, 2020	Radiation (03CH01-SZ)
SHF-EHF Horn	com-power	AH-840	101071	18Ghz-40GHz	Apr. 18, 2019	Mar. 10, 2020~ Mar. 11, 2020	Apr. 17, 2020	Radiation (03CH01-SZ)
LF Amplifier	Burgeon	BPA-530	102209	0.01~3000Mhz	Apr. 19, 2019	Mar. 10, 2020~ Mar. 11, 2020	Apr. 18, 2020	Radiation (03CH01-SZ)
HF Amplifier	MITEQ	AMF-7D-00 101800-30-1 0P-R	1943528	1GHz~18GHz	Oct. 18, 2019	Mar. 10, 2020~ Mar. 11, 2020	Oct. 17, 2020	Radiation (03CH01-SZ)
HF Amplifier	KEYSIGHT	83017A	MY53270104	0.5GHz~26.5Ghz	Dec. 27, 2019	Mar. 10, 2020~ Mar. 11, 2020	Dec. 26, 2020	Radiation (03CH01-SZ)
HF Amplifier	MITEQ	TTA1840-35 -HG	1871923	18GHZ~40GHz	Jul. 22, 2019	Mar. 10, 2020~ Mar. 11, 2020	Jul. 21, 2020	Radiation (03CH01-SZ)
AC Power Source	Chroma	61601	616010001985	N/A	NCR	Mar. 10, 2020~ Mar. 11, 2020	NCR	Radiation (03CH01-SZ)
Turn Table	EM	EM1000	N/A	0~360 degree	NCR	Mar. 10, 2020~ Mar. 11, 2020	NCR	Radiation (03CH01-SZ)
Antenna Mast	EM	EM1000	N/A	1 m~4 m	NCR	Mar. 10, 2020~ Mar. 11, 2020	NCR	Radiation (03CH01-SZ)

NCR: No Calibration Required



6 Uncertainty of Evaluation

The measurement uncertainties shown below were calculated in accordance with the requirements of ANSI 63.26-2015. All the measurement uncertainty value were shown with a coverage K=2 to indicate 95% level of confidence. The measurement data show herein meets or exceeds the CISPR measurement uncertainty values specified in CISPR 16-4-2 and can be compared directly to specified limit to determine compliance.

Uncertainty of Radiated Emission Measurement (30 MHz ~ 1000 MHz)

Measuring Uncertainty for a Level of Confidence of 95% (U = 2Uc(y))	2.5dB
---	-------

Uncertainty of Radiated Emission Measurement (1 GHz ~ 18 GHz)

Measuring Uncertainty for a Level of Confidence of 95% (U = 2Uc(y))	3.5dB
---	-------

Uncertainty of Radiated Emission Measurement (18 GHz ~ 40 GHz)

Measuring Uncertainty for a Level of Confidence of 95% (U = 2Uc(y))	4.0dB
---	-------



Appendix A. Test Results of Conducted Test

Conducted Output Power(Average power)

LTE Band 2 Maximum Average Power [dBm]						
BW [MHz]	RB Size	RB Offset	Mod	Lowest	Middle	Highest
20	1	0	QPSK	23.94	24.00	24.04
20	1	49		24.16	24.20	24.30
20	1	99		23.88	23.91	23.98
20	50	0		22.95	23.14	23.19
20	50	24		22.99	23.17	23.19
20	50	50		22.94	23.08	23.12
20	100	0		22.94	23.10	23.13
20	1	0	16-QAM	23.12	23.22	23.22
20	1	49		23.34	23.55	23.43
20	1	99		23.06	23.13	23.07
20	50	0		21.97	22.11	22.19
20	50	24		22.03	22.12	22.18
20	50	50		21.97	22.08	22.05
20	100	0		21.96	22.08	22.12
20	1	0	64-QAM	22.07	22.08	22.13
20	1	49		22.29	22.28	22.35
20	1	99		22.05	21.98	22.02
20	50	0		21.01	21.16	21.26
20	50	24		21.04	21.19	21.21
20	50	50		20.99	21.11	21.12
20	100	0		21.01	21.11	21.19
15	1	0	QPSK	23.83	23.99	23.99
15	1	37		24.01	24.21	24.19
15	1	74		23.78	23.93	23.89
15	36	0		22.92	23.12	23.18
15	36	20		22.92	23.12	23.16
15	36	39		22.92	23.10	23.09
15	75	0		22.95	23.14	23.16
15	1	0	16-QAM	23.12	23.50	23.28



15	1	37		23.33	23.42	23.48
15	1	74		23.08	23.19	23.10
15	36	0		21.92	22.06	22.14
15	36	20		21.93	22.08	22.15
15	36	39		21.91	22.04	22.05
15	75	0		21.95	22.07	22.14
15	1	0	64-QAM	22.05	22.09	22.18
15	1	37		22.52	22.25	22.37
15	1	74		22.03	22.04	22.05
15	36	0		21.01	21.10	21.18
15	36	20		21.02	21.14	21.20
15	36	39		21.00	21.11	21.13
15	75	0		21.00	21.12	21.18



LTE Band 2 Maximum Average Power [dBm]						
BW [MHz]	RB Size	RB Offset	Mod	Lowest	Middle	Highest
10	1	0	QPSK	23.83	23.99	24.00
10	1	25		23.92	24.06	24.08
10	1	49		23.75	24.00	23.94
10	25	0		22.89	23.11	23.15
10	25	12		22.89	23.12	23.14
10	25	25		22.87	23.09	23.06
10	50	0		22.90	23.12	23.10
10	1	0	16-QAM	23.16	23.30	23.33
10	1	25		23.24	23.39	23.37
10	1	49		23.15	23.27	23.08
10	25	0		21.96	22.10	22.16
10	25	12		21.94	22.10	22.13
10	25	25		21.93	22.13	22.02
10	50	0		21.93	22.10	22.10
10	1	0	64-QAM	22.10	22.12	22.17
10	1	25		22.15	22.52	22.29
10	1	49		22.06	22.10	22.05
10	25	0		20.99	21.17	21.20
10	25	12		21.01	21.12	21.16
10	25	25		20.95	21.15	21.10
10	50	0		21.01	21.12	21.16
5	1	0	QPSK	23.71	23.90	23.83
5	1	12		23.98	24.15	24.09
5	1	24		23.70	23.86	23.81
5	12	0		22.86	23.03	23.00
5	12	7		22.91	23.05	23.03
5	12	13		22.87	23.03	22.95
5	25	0		22.88	23.05	23.01
5	1	0	16-QAM	23.08	23.19	23.09
5	1	12		23.32	23.44	23.32
5	1	24		23.04	23.21	23.00
5	12	0		21.87	22.01	22.00
5	12	7		21.92	22.07	21.99



5	12	13	64-QAM	21.84	22.00	21.90
5	25	0		21.92	22.04	21.95
5	1	0		22.00	22.04	22.02
5	1	12		22.21	22.34	22.28
5	1	24		21.92	22.04	21.91
5	12	0		20.99	21.10	21.06
5	12	7		21.02	21.12	21.11
5	12	13		20.95	21.06	20.98
5	25	0		20.96	21.10	21.05



LTE Band 2 Maximum Average Power [dBm]						
BW [MHz]	RB Size	RB Offset	Mod	Lowest	Middle	Highest
3	1	0	QPSK	23.75	23.94	23.87
3	1	8		23.73	23.92	23.88
3	1	14		23.75	23.92	23.86
3	8	0		22.84	23.00	22.93
3	8	4		22.87	22.98	22.96
3	8	7		22.77	22.98	22.93
3	15	0		22.81	22.97	22.95
3	1	0	16-QAM	23.12	23.20	23.15
3	1	8		23.11	23.25	23.06
3	1	14		23.11	23.25	23.07
3	8	0		21.89	22.02	21.98
3	8	4		21.91	22.05	21.98
3	8	7		21.89	21.97	21.91
3	15	0		21.85	21.96	21.92
3	1	0	64-QAM	21.98	22.05	22.03
3	1	8		22.03	22.10	22.13
3	1	14		22.00	22.07	21.94
3	8	0		20.97	21.04	21.04
3	8	4		20.96	21.07	21.06
3	8	7		20.95	21.03	21.00
3	15	0		20.91	21.01	20.97
1.4	1	0	QPSK	23.85	24.01	23.88
1.4	1	3		24.00	24.20	24.04
1.4	1	5		23.90	24.02	23.89
1.4	3	0		23.99	24.08	24.02
1.4	3	1		24.04	24.20	24.12
1.4	3	3		24.03	24.14	24.03
1.4	6	0		23.01	23.15	23.07
1.4	1	0	16-QAM	23.15	23.26	23.08
1.4	1	3		23.34	23.40	23.19
1.4	1	5		23.14	23.24	23.05
1.4	3	0		22.98	23.10	22.95
1.4	3	1		23.05	23.15	23.01



1.4	3	3	64-QAM	23.02	23.13	22.93
1.4	6	0		22.08	22.21	22.12
1.4	1	0		22.10	22.18	22.05
1.4	1	3		22.28	22.32	22.16
1.4	1	5		22.12	22.41	22.02
1.4	3	0		22.13	22.24	22.15
1.4	3	1		22.19	22.28	22.14
1.4	3	3		22.16	22.16	22.13
1.4	6	0		21.04	21.14	21.09



LTE Band 4 Maximum Average Power [dBm]						
BW [MHz]	RB Size	RB Offset	Mod	Lowest	Middle	Highest
20	1	0	QPSK	23.54	23.66	23.61
20	1	49		23.71	23.86	23.77
20	1	99		23.40	23.47	23.44
20	50	0		22.74	22.81	22.75
20	50	24		22.73	22.76	22.73
20	50	50		22.63	22.72	22.67
20	100	0		22.71	22.77	22.73
20	1	0	16-QAM	22.72	22.91	22.81
20	1	49		22.93	23.00	22.94
20	1	99		22.61	22.64	22.82
20	50	0		21.77	21.70	21.87
20	50	24		21.77	21.79	21.76
20	50	50		21.73	21.66	21.70
20	100	0		21.74	21.68	21.79
20	1	0	64-QAM	21.69	21.90	21.84
20	1	49		21.84	21.93	21.94
20	1	99		21.90	21.65	21.71
20	50	0		20.74	20.70	20.87
20	50	24		20.75	20.78	20.74
20	50	50		20.75	20.61	20.69
20	100	0		20.74	20.69	20.79
15	1	0	QPSK	23.58	23.66	23.62
15	1	37		23.73	23.76	23.72
15	1	74		23.51	23.51	23.52
15	36	0		22.68	22.72	22.75
15	36	20		22.67	22.74	22.68
15	36	39		22.69	22.66	22.67
15	75	0		22.67	22.70	22.70
15	1	0	16-QAM	22.77	22.92	22.86
15	1	37		22.99	23.02	22.98
15	1	74		22.79	22.72	22.78
15	36	0		21.69	21.70	21.75
15	36	20		21.66	21.75	21.70



15	36	39	64-QAM	21.71	21.66	21.67
15	75	0		21.71	21.71	21.72
15	1	0		21.78	21.93	21.78
15	1	37		21.94	21.94	21.89
15	1	74		21.79	21.64	21.66
15	36	0		20.72	20.72	20.75
15	36	20		20.70	20.75	20.71
15	36	39		20.69	20.68	20.69
15	75	0		20.72	20.69	20.71



LTE Band 4 Maximum Average Power [dBm]						
BW [MHz]	RB Size	RB Offset	Mod	Lowest	Middle	Highest
10	1	0	QPSK	23.59	23.66	23.62
10	1	25		23.66	23.74	23.67
10	1	49		23.57	23.55	23.52
10	25	0		22.73	22.76	22.70
10	25	12		22.67	22.72	22.65
10	25	25		22.67	22.68	22.65
10	50	0		22.71	22.74	22.71
10	1	0	16-QAM	22.73	22.84	22.77
10	1	25		22.79	23.05	22.85
10	1	49		22.77	22.71	22.72
10	25	0		21.74	21.78	21.75
10	25	12		21.70	21.74	21.68
10	25	25		21.68	21.72	21.71
10	50	0		21.73	21.75	21.74
10	1	0	64-QAM	21.74	22.23	21.82
10	1	25		21.86	21.92	21.92
10	1	49		21.77	21.80	21.74
10	25	0		20.75	20.76	20.72
10	25	12		20.70	20.73	20.66
10	25	25		20.67	20.71	20.67
10	50	0		20.74	20.76	20.72
5	1	0	QPSK	23.49	23.58	23.44
5	1	12		23.73	23.76	23.70
5	1	24		23.44	23.50	23.40
5	12	0		22.65	22.66	22.57
5	12	7		22.64	22.69	22.60
5	12	13		22.61	22.65	22.58
5	25	0		22.64	22.68	22.58
5	1	0	16-QAM	22.65	22.77	22.68
5	1	12		22.90	22.97	22.94
5	1	24		22.89	22.70	22.63
5	12	0		21.63	21.66	21.59
5	12	7		21.67	21.72	21.61



5	12	13		21.59	21.64	21.58
5	25	0		21.68	21.72	21.62
5	1	0	64-QAM	21.75	21.83	21.75
5	1	12		21.86	21.96	22.17
5	1	24		21.71	21.72	21.73
5	12	0		20.63	20.69	20.59
5	12	7		20.68	20.76	20.65
5	12	13		20.63	20.67	20.61
5	25	0		20.68	20.70	20.60



LTE Band 4 Maximum Average Power [dBm]						
BW [MHz]	RB Size	RB Offset	Mod	Lowest	Middle	Highest
3	1	0	QPSK	23.54	23.59	23.50
3	1	8		23.55	23.58	23.50
3	1	14		23.54	23.57	23.50
3	8	0		22.61	22.64	22.53
3	8	4		22.59	22.65	22.57
3	8	7		22.56	22.59	22.52
3	15	0		22.61	22.65	22.53
3	1	0	16-QAM	22.74	22.84	22.82
3	1	8		22.75	22.78	22.74
3	1	14		22.70	22.80	22.80
3	8	0		21.66	21.70	21.65
3	8	4		21.66	21.74	21.65
3	8	7		21.60	21.70	21.63
3	15	0		21.60	21.67	21.56
3	1	0	64-QAM	21.86	21.80	21.67
3	1	8		21.71	21.81	21.69
3	1	14		21.66	21.74	21.65
3	8	0		20.63	20.72	20.60
3	8	4		20.64	20.72	20.63
3	8	7		20.62	20.67	20.62
3	15	0		20.61	20.65	20.57
1.4	1	0	QPSK	23.53	23.61	23.48
1.4	1	3		23.65	23.77	23.66
1.4	1	5		23.54	23.63	23.49
1.4	3	0		23.67	23.75	23.63
1.4	3	1		23.74	23.84	23.67
1.4	3	3		23.68	23.77	23.65
1.4	6	0		22.70	22.78	22.57
1.4	1	0	16-QAM	22.71	22.85	22.76
1.4	1	3		22.87	23.02	22.87
1.4	1	5		22.71	22.85	22.78
1.4	3	0		22.59	22.69	22.59
1.4	3	1		22.66	22.71	22.68



1.4	3	3	64-QAM	22.60	22.66	22.59
1.4	6	0		21.81	21.86	21.76
1.4	1	0		21.70	21.84	21.73
1.4	1	3		21.84	21.88	21.78
1.4	1	5		21.69	21.78	21.70
1.4	3	0		21.78	21.84	21.77
1.4	3	1		21.85	21.90	21.80
1.4	3	3		21.77	21.85	21.70
1.4	6	0		20.67	20.78	20.62



LTE Band 5 Maximum Average Power [dBm]						
BW [MHz]	RB Size	RB Offset	Mod	Lowest	Middle	Highest
10	1	0	QPSK	24.05	24.08	24.11
10	1	25		24.10	24.18	24.21
10	1	49		24.07	24.07	24.08
10	25	0		23.15	23.21	23.26
10	25	12		23.17	23.18	23.25
10	25	25		23.14	23.16	23.24
10	50	0		23.18	23.20	23.31
10	1	0	16-QAM	23.25	23.36	23.34
10	1	25		23.45	23.46	23.39
10	1	49		23.35	23.28	23.34
10	25	0		22.17	22.21	22.33
10	25	12		22.21	22.24	22.32
10	25	25		22.20	22.27	22.30
10	50	0		22.20	22.25	22.32
10	1	0	64-QAM	22.29	22.33	22.34
10	1	25		22.50	22.42	22.47
10	1	49		22.39	22.25	22.38
10	25	0		21.21	21.21	21.33
10	25	12		21.21	21.25	21.30
10	25	25		21.21	21.26	21.29
10	50	0		21.23	21.23	21.30
5	1	0	QPSK	24.15	24.15	24.15
5	1	12		24.18	24.17	24.19
5	1	24		24.11	24.15	24.15
5	12	0		23.22	23.24	23.26
5	12	7		23.13	23.21	23.25
5	12	13		23.27	23.18	23.17
5	25	0		23.20	23.21	23.22
5	1	0	16-QAM	23.30	23.20	23.14
5	1	12		23.13	23.13	23.21
5	1	24		23.30	23.12	23.17
5	12	0		22.11	22.19	22.22
5	12	7		22.14	22.12	22.20



5	12	13	64-QAM	22.23	22.19	22.16
5	25	0		22.27	22.24	22.25
5	1	0		22.26	22.16	22.14
5	1	12		22.24	22.16	22.11
5	1	24		22.18	22.21	22.30
5	12	0		21.24	21.15	21.20
5	12	7		21.18	21.22	21.13
5	12	13		21.21	21.25	21.29
5	25	0		21.28	21.23	21.27



LTE Band 5 Maximum Average Power [dBm]						
BW [MHz]	RB Size	RB Offset	Mod	Lowest	Middle	Highest
3	1	0	QPSK	24.16	24.14	24.19
3	1	8		24.17	24.16	24.11
3	1	14		24.13	24.16	24.15
3	8	0		23.25	23.28	23.15
3	8	4		23.30	23.14	23.11
3	8	7		23.24	23.13	23.14
3	15	0		23.20	23.15	23.16
3	1	0	16-QAM	23.26	23.25	23.11
3	1	8		23.20	23.20	23.11
3	1	14		23.28	23.24	23.15
3	8	0		22.12	22.27	22.20
3	8	4		22.29	22.30	22.22
3	8	7		22.19	22.30	22.28
3	15	0		22.11	22.27	22.30
3	1	0	64-QAM	22.20	22.29	22.30
3	1	8		22.23	22.11	22.21
3	1	14		22.16	22.27	22.17
3	8	0		21.24	21.18	21.18
3	8	4		21.24	21.16	21.17
3	8	7		21.15	21.15	21.24
3	15	0		21.26	21.30	21.13
1.4	1	0	QPSK	24.20	24.15	24.11
1.4	1	3		24.20	24.16	24.15
1.4	1	5		24.15	24.13	24.19
1.4	3	0		24.03	23.94	24.02
1.4	3	1		23.91	23.96	23.98
1.4	3	3		23.96	24.03	23.95
1.4	6	0		23.15	23.19	23.25
1.4	1	0	16-QAM	23.21	23.24	23.13
1.4	1	3		23.20	23.20	23.19
1.4	1	5		23.29	23.24	23.13
1.4	3	0		23.06	23.06	23.06
1.4	3	1		23.04	22.99	22.99



1.4	3	3	64-QAM	23.00	22.95	22.93
1.4	6	0		22.94	23.08	23.04
1.4	1	0		22.26	22.18	22.17
1.4	1	3		22.18	22.25	22.17
1.4	1	5		22.20	22.25	22.21
1.4	3	0		22.01	21.93	22.00
1.4	3	1		22.05	21.98	22.08
1.4	3	3		22.00	21.95	22.06
1.4	6	0		21.30	21.13	21.29



LTE Band 12 Maximum Average Power [dBm]						
BW [MHz]	RB Size	RB Offset	Mod	Lowest	Middle	Highest
10	1	0	QPSK	21.98	21.97	21.97
10	1	25		22.19	22.16	22.19
10	1	49		22.05	22.06	22.04
10	25	0		23.08	23.14	23.17
10	25	12		23.13	23.26	23.18
10	25	25		23.14	23.15	23.16
10	50	0		23.11	23.17	23.20
10	1	0	16-QAM	21.16	21.17	21.10
10	1	25		21.39	21.33	21.39
10	1	49		21.22	21.21	21.20
10	25	0		22.08	22.10	22.13
10	25	12		22.15	22.15	22.17
10	25	25		22.15	22.13	22.13
10	50	0		22.07	22.13	22.14
10	1	0	64-QAM	20.10	20.15	20.14
10	1	25		20.38	20.33	20.39
10	1	49		20.19	20.26	20.20
10	25	0		21.06	21.10	21.16
10	25	12		21.15	21.14	21.20
10	25	25		21.14	21.15	21.15
10	50	0		21.11	21.11	21.18
5	1	0	QPSK	21.94	21.90	21.95
5	1	12		22.10	22.09	22.13
5	1	24		22.04	22.03	22.03
5	12	0		23.09	23.10	23.06
5	12	7		23.20	23.16	23.15
5	12	13		23.16	23.11	23.04
5	25	0		23.13	23.12	23.05
5	1	0	16-QAM	21.09	21.07	21.01
5	1	12		21.31	21.29	21.36
5	1	24		21.12	21.14	21.17
5	12	0		22.08	22.10	22.03
5	12	7		22.14	22.13	22.11



5	12	13	64-QAM	22.13	22.05	21.97
5	25	0		22.16	22.09	22.03
5	1	0		20.02	20.14	20.07
5	1	12		20.32	20.27	20.29
5	1	24		20.17	20.18	20.11
5	12	0		21.09	21.11	21.04
5	12	7		21.22	21.16	21.15
5	12	13		21.19	21.07	20.99
5	25	0		21.12	21.09	21.03



LTE Band 12 Maximum Average Power [dBm]						
BW [MHz]	RB Size	RB Offset	Mod	Lowest	Middle	Highest
3	1	0	QPSK	21.93	21.89	21.95
3	1	8		22.09	22.11	22.12
3	1	14		22.03	22.01	22.03
3	8	0		23.03	23.06	23.07
3	8	4		23.08	23.11	23.08
3	8	7		23.07	23.09	23.05
3	15	0		23.05	23.09	23.06
3	1	0	16-QAM	21.06	21.09	21.04
3	1	8		21.32	21.30	21.38
3	1	14		21.12	21.19	21.17
3	8	0		22.14	22.08	22.06
3	8	4		22.14	22.13	22.09
3	8	7		22.12	22.13	22.07
3	15	0		22.04	22.08	22.01
3	1	0	64-QAM	20.08	20.05	20.08
3	1	8		20.34	20.26	20.36
3	1	14		20.12	20.19	20.18
3	8	0		21.09	21.13	21.08
3	8	4		21.13	21.14	21.08
3	8	7		21.13	21.14	21.04
3	15	0		21.07	21.05	21.01
1.4	1	0	QPSK	21.88	21.96	21.89
1.4	1	3		22.12	22.10	22.10
1.4	1	5		22.04	22.00	22.01
1.4	3	0		24.07	24.11	24.07
1.4	3	1		24.15	24.18	24.12
1.4	3	3		24.09	24.11	24.07
1.4	6	0		23.11	23.14	23.08
1.4	1	0	16-QAM	21.15	21.09	21.00
1.4	1	3		21.32	21.30	21.35
1.4	1	5		21.18	21.14	21.14
1.4	3	0		23.10	23.07	22.98
1.4	3	1		23.14	23.11	23.09



1.4	3	3	64-QAM	23.11	23.07	23.00
1.4	6	0		22.19	22.15	22.14
1.4	1	0		20.06	20.05	20.06
1.4	1	3		20.28	20.32	20.30
1.4	1	5		20.17	20.22	20.15
1.4	3	0		22.20	22.18	22.09
1.4	3	1		22.26	22.23	22.18
1.4	3	3		22.23	22.19	22.09
1.4	6	0		21.11	21.10	21.04



LTE Band 66 Maximum Average Power [dBm]						
BW [MHz]	RB Size	RB Offset	Mod	Lowest	Middle	Highest
20	1	0	QPSK	20.58	20.69	20.57
20	1	49		20.83	20.87	20.66
20	1	99		20.48	20.52	20.30
20	50	0		22.63	22.78	22.54
20	50	24		22.62	22.68	22.52
20	50	50		22.63	22.59	22.32
20	100	0		22.64	22.66	22.43
20	1	0	16-QAM	19.86	19.91	19.84
20	1	49		20.11	20.08	20.01
20	1	99		19.80	19.70	19.65
20	50	0		21.67	21.79	21.56
20	50	24		21.64	21.71	21.52
20	50	50		21.67	21.62	21.31
20	100	0		21.67	21.69	21.37
20	1	0	64-QAM	18.76	18.83	18.80
20	1	49		18.94	19.01	18.93
20	1	99		18.62	18.57	18.57
20	50	0		20.68	20.79	20.55
20	50	24		20.66	20.68	20.51
20	50	50		20.67	20.58	20.32
20	100	0		20.65	20.69	20.45
15	1	0	QPSK	20.49	20.65	20.53
15	1	37		20.78	20.83	20.59
15	1	74		20.47	20.50	20.23
15	36	0		22.56	22.61	22.46
15	36	20		22.54	22.56	22.41
15	36	39		22.51	22.53	22.34
15	75	0		22.52	22.56	22.37
15	1	0	16-QAM	19.80	19.89	19.81
15	1	37		20.08	20.07	20.00
15	1	74		19.75	19.67	19.58
15	36	0		21.56	21.60	21.43
15	36	20		21.53	21.57	21.32



15	36	39	64-QAM	21.52	21.54	21.26
15	75	0		21.56	21.59	21.35
15	1	0		18.68	18.77	18.76
15	1	37		18.85	18.92	18.85
15	1	74		18.55	18.48	18.50
15	36	0		20.55	20.62	20.46
15	36	20		20.54	20.59	20.42
15	36	39		20.55	20.51	20.32
15	75	0		20.57	20.56	20.36



LTE Band 66 Maximum Average Power [dBm]						
BW [MHz]	RB Size	RB Offset	Mod	Lowest	Middle	Highest
10	1	0	QPSK	20.57	20.63	20.47
10	1	25		20.81	20.85	20.63
10	1	49		20.38	20.51	20.28
10	25	0		22.53	22.56	22.44
10	25	12		22.46	22.51	22.34
10	25	25		22.45	22.45	22.32
10	50	0		22.53	22.53	22.44
10	1	0	16-QAM	19.76	19.83	19.76
10	1	25		20.02	20.04	20.00
10	1	49		19.71	19.63	19.64
10	25	0		21.55	21.62	21.40
10	25	12		21.49	21.55	21.31
10	25	25		21.52	21.48	21.27
10	50	0		21.56	21.57	21.37
10	1	0	64-QAM	18.71	18.77	18.79
10	1	25		18.91	18.92	18.87
10	1	49		18.60	18.55	18.56
10	25	0		20.55	20.60	20.46
10	25	12		20.49	20.52	20.33
10	25	25		20.50	20.47	20.31
10	50	0		20.53	20.55	20.43
5	1	0	QPSK	20.56	20.64	20.49
5	1	12		20.73	20.80	20.58
5	1	24		20.39	20.42	20.29
5	12	0		22.53	22.58	22.41
5	12	7		22.55	22.58	22.46
5	12	13		22.50	22.52	22.40
5	25	0		22.53	22.54	22.38
5	1	0	16-QAM	19.83	19.82	19.76
5	1	12		20.06	19.99	19.94
5	1	24		19.71	19.63	19.55
5	12	0		21.56	21.58	21.33
5	12	7		21.56	21.61	21.37



5	12	13		21.51	21.54	21.31
5	25	0		21.59	21.58	21.33
5	1	0	64-QAM	18.68	18.80	18.78
5	1	12		18.90	18.95	18.86
5	1	24		18.57	18.54	18.56
5	12	0		20.59	20.61	20.45
5	12	7		20.61	20.60	20.47
5	12	13		20.60	20.55	20.44
5	25	0		20.56	20.58	20.41



LTE Band 66 Maximum Average Power [dBm]						
BW [MHz]	RB Size	RB Offset	Mod	Lowest	Middle	Highest
3	1	0	QPSK	20.57	20.64	20.52
3	1	8		20.77	20.84	20.57
3	1	14		20.44	20.48	20.22
3	8	0		22.47	22.52	22.36
3	8	4		22.49	22.53	22.40
3	8	7		22.44	22.49	22.34
3	15	0		22.48	22.49	22.37
3	1	0	16-QAM	19.82	19.81	19.83
3	1	8		20.03	20.00	19.92
3	1	14		19.77	19.66	19.61
3	8	0		21.56	21.65	21.38
3	8	4		21.56	21.62	21.41
3	8	7		21.50	21.57	21.41
3	15	0		21.51	21.55	21.34
3	1	0	64-QAM	18.71	18.81	18.73
3	1	8		18.87	18.94	18.85
3	1	14		18.57	18.47	18.51
3	8	0		20.55	20.57	20.43
3	8	4		20.55	20.59	20.45
3	8	7		20.52	20.53	20.43
3	15	0		20.50	20.53	20.39
1.4	1	0	QPSK	20.49	20.65	20.53
1.4	1	3		20.80	20.86	20.61
1.4	1	5		20.43	20.42	20.20
1.4	3	0		23.46	23.50	23.38
1.4	3	1		23.52	23.53	23.43
1.4	3	3		23.47	23.51	23.35
1.4	6	0		22.49	22.50	22.40
1.4	1	0	16-QAM	19.76	19.84	19.81
1.4	1	3		20.08	20.06	19.99
1.4	1	5		19.77	19.63	19.58
1.4	3	0		22.39	22.48	22.30
1.4	3	1		22.45	22.51	22.37



1.4	3	3	64-QAM	22.39	22.46	22.32
1.4	6	0		21.58	21.64	21.45
1.4	1	0		18.69	18.79	18.74
1.4	1	3		18.89	18.96	18.90
1.4	1	5		18.55	18.51	18.51
1.4	3	0		21.54	21.65	21.42
1.4	3	1		21.64	21.65	21.47
1.4	3	3		21.56	21.61	21.43
1.4	6	0		20.51	20.58	20.39



ERP/EIRP

LTE Band 2 (GT - LC = -0.30 dB) QPSK									
Bandwidth	1.4M			3M			5M		
Channel	18607	18900	19193	18615	18900	19185	18625	18900	19175
	(Low)	(Mid)	(High)	(Low)	(Mid)	(High)	(Low)	(Mid)	(High)
Frequency	1850.7	1880	1909.3	1851.5	1880	1908.5	1852.5	1880	1907.5
(MHz)									
Conducted Power (dBm)	24.00	24.20	24.04	23.75	23.94	23.87	23.98	24.15	24.09
Conducted Power (Watts)	0.2512	0.2630	0.2535	0.2371	0.2477	0.2438	0.2500	0.2600	0.2564
EIRP(dBm)	23.70	23.90	23.74	23.45	23.64	23.57	23.68	23.85	23.79
EIRP(Watts)	0.2344	0.2455	0.2366	0.2213	0.2312	0.2275	0.2333	0.2427	0.2393

LTE Band 2 (GT - LC = -0.30 dB) QPSK									
Bandwidth	10M			15M			20M		
Channel	18650	18900	19150	18675	18900	19125	18650	18900	19100
	(Low)	(Mid)	(High)	(Low)	(Mid)	(High)	(Low)	(Mid)	(High)
Frequency	1855	1880	1905	1857.5	1880	1902.5	1860	1880	1900
(MHz)									
Conducted Power (dBm)	23.92	24.06	24.08	24.01	24.21	24.19	24.16	24.20	24.30
Conducted Power (Watts)	0.2466	0.2547	0.2559	0.2518	0.2636	0.2624	0.2606	0.2630	0.2692
EIRP(dBm)	23.62	23.76	23.78	23.71	23.91	23.89	23.86	23.90	24.00
EIRP(Watts)	0.2301	0.2377	0.2388	0.2350	0.2460	0.2449	0.2432	0.2455	0.2512



LTE Band 2 (GT - LC = -0.30 dB) 16QAM									
Bandwidth	1.4M			3M			5M		
Channel	18607	18900	19193	18615	18900	19185	18625	18900	19175
	(Low)	(Mid)	(High)	(Low)	(Mid)	(High)	(Low)	(Mid)	(High)
Frequency (MHz)	1850.7	1880	1909.3	1851.5	1880	1908.5	1852.5	1880	1907.5
Conducted Power (dBm)	23.34	23.40	23.19	23.11	23.25	23.06	23.32	23.44	23.32
Conducted Power (Watts)	0.2158	0.2188	0.2084	0.2046	0.2113	0.2023	0.2148	0.2208	0.2148
EIRP(dBm)	23.04	23.10	22.89	22.81	22.95	22.76	23.02	23.14	23.02
EIRP(Watts)	0.2014	0.2042	0.1945	0.1910	0.1972	0.1888	0.2004	0.2061	0.2004

LTE Band 2 (GT - LC = -0.30 dB) 16QAM									
Bandwidth	10M			15M			20M		
Channel	18650	18900	19150	18675	18900	19125	18650	18900	19100
	(Low)	(Mid)	(High)	(Low)	(Mid)	(High)	(Low)	(Mid)	(High)
Frequency (MHz)	1855	1880	1905	1857.5	1880	1902.5	1860	1880	1900
Conducted Power (dBm)	23.24	23.39	23.37	23.12	23.50	23.28	23.34	23.55	23.43
Conducted Power (Watts)	0.2109	0.2183	0.2173	0.2051	0.2239	0.2128	0.2158	0.2265	0.2203
EIRP(dBm)	22.94	23.09	23.07	22.82	23.20	22.98	23.04	23.25	23.13
EIRP(Watts)	0.1968	0.2037	0.2028	0.1914	0.2089	0.1986	0.2014	0.2113	0.2056



LTE Band 2 (GT - LC = -0.30 dB) 64QAM									
Bandwidth	1.4M			3M			5M		
Channel	18607	18900	19193	18615	18900	19185	18625	18900	19175
	(Low)	(Mid)	(High)	(Low)	(Mid)	(High)	(Low)	(Mid)	(High)
Frequency (MHz)	1850.7	1880	1909.3	1851.5	1880	1908.5	1852.5	1880	1907.5
Conducted Power (dBm)	22.12	22.41	22.02	22.03	22.10	22.13	22.21	22.34	22.28
Conducted Power (Watts)	0.1629	0.1742	0.1592	0.1596	0.1622	0.1633	0.1663	0.1714	0.1690
EIRP(dBm)	21.82	22.11	21.72	21.73	21.80	21.83	21.91	22.04	21.98
EIRP(Watts)	0.1521	0.1626	0.1486	0.1489	0.1514	0.1524	0.1552	0.1600	0.1578

LTE Band 2 (GT - LC = -0.30 dB) 64QAM									
Bandwidth	10M			15M			20M		
Channel	18650	18900	19150	18675	18900	19125	18650	18900	19100
	(Low)	(Mid)	(High)	(Low)	(Mid)	(High)	(Low)	(Mid)	(High)
Frequency (MHz)	1855	1880	1905	1857.5	1880	1902.5	1860	1880	1900
Conducted Power (dBm)	22.15	22.52	22.29	22.52	22.25	22.37	22.29	22.28	22.35
Conducted Power (Watts)	0.1641	0.1786	0.1694	0.1786	0.1679	0.1726	0.1694	0.1690	0.1718
EIRP(dBm)	21.85	22.22	21.99	22.22	21.95	22.07	21.99	21.98	22.05
EIRP(Watts)	0.1531	0.1667	0.1581	0.1667	0.1567	0.1611	0.1581	0.1578	0.1603



LTE Band 4 (GT - LC = -0.80 dB) QPSK									
Bandwidth	1.4M			3M			5M		
Channel	131979	132322	132665	131987	132322	132657	131997	132322	132647
	(Low)	(Mid)	(High)	(Low)	(Mid)	(High)	(Low)	(Mid)	(High)
Frequency (MHz)	1710.7	1745	1779.3	1711.5	1745	1778.5	1712.5	1745	1777.5
Conducted Power (dBm)	23.74	23.84	23.67	23.54	23.59	23.50	23.73	23.76	23.70
Conducted Power (Watts)	0.2366	0.2421	0.2328	0.2259	0.2286	0.2239	0.2360	0.2377	0.2344
EIRP(dBm)	22.94	23.04	22.87	22.74	22.79	22.70	22.93	22.96	22.90
EIRP(Watts)	0.1968	0.2014	0.1936	0.1879	0.1901	0.1862	0.1963	0.1977	0.1950

LTE Band 4 (GT - LC = -0.80 dB) QPSK									
Bandwidth	10M			15M			20M		
Channel	132022	132322	132622	132047	132322	132597	132072	132322	132572
	(Low)	(Mid)	(High)	(Low)	(Mid)	(High)	(Low)	(Mid)	(Mid)
Frequency (MHz)	1715	1745	1775	1717.5	1745	1772.5	1720	1745	1770
Conducted Power (dBm)	23.66	23.74	23.67	23.73	23.76	23.72	23.71	23.86	23.77
Conducted Power (Watts)	0.2323	0.2366	0.2328	0.2360	0.2377	0.2355	0.2350	0.2432	0.2382
EIRP(dBm)	22.86	22.94	22.87	22.93	22.96	22.92	22.91	23.06	22.97
EIRP(Watts)	0.1932	0.1968	0.1936	0.1963	0.1977	0.1959	0.1954	0.2023	0.1982



LTE Band 4 (GT - LC = -0.80 dB) 16QAM									
Bandwidth	1.4M			3M			5M		
Channel	131979	132322	132665	131987	132322	132657	131997	132322	132647
	(Low)	(Mid)	(High)	(Low)	(Mid)	(High)	(Low)	(Mid)	(High)
Frequency (MHz)	1710.7	1745	1779.3	1711.5	1745	1778.5	1712.5	1745	1777.5
Conducted Power (dBm)	22.87	23.02	22.87	22.74	22.84	22.82	22.90	22.97	22.94
Conducted Power (Watts)	0.1936	0.2004	0.1936	0.1879	0.1923	0.1914	0.1950	0.1982	0.1968
EIRP(dBm)	22.07	22.22	22.07	21.94	22.04	22.02	22.10	22.17	22.14
EIRP(Watts)	0.1611	0.1667	0.1611	0.1563	0.1600	0.1592	0.1622	0.1648	0.1637

LTE Band 4 (GT - LC = -0.80 dB) 16QAM									
Bandwidth	10M			15M			20M		
Channel	132022	132322	132622	132047	132322	132597	132072	132322	132572
	(Low)	(Mid)	(High)	(Low)	(Mid)	(High)	(Low)	(Mid)	(Mid)
Frequency (MHz)	1715	1745	1775	1717.5	1745	1772.5	1720	1745	1770
Conducted Power (dBm)	22.79	23.05	22.85	22.99	23.02	22.98	22.93	23.00	22.94
Conducted Power (Watts)	0.1901	0.2018	0.1928	0.1991	0.2004	0.1986	0.1963	0.1995	0.1968
EIRP(dBm)	21.99	22.25	22.05	22.19	22.22	22.18	22.13	22.20	22.14
EIRP(Watts)	0.1581	0.1679	0.1603	0.1656	0.1667	0.1652	0.1633	0.1660	0.1637



LTE Band 4 (GT - LC = -0.80 dB) 64QAM									
Bandwidth	1.4M			3M			5M		
Channel	131979	132322	132665	131987	132322	132657	131997	132322	132647
	(Low)	(Mid)	(High)	(Low)	(Mid)	(High)	(Low)	(Mid)	(High)
Frequency (MHz)	1710.7	1745	1779.3	1711.5	1745	1778.5	1712.5	1745	1777.5
Conducted Power (dBm)	21.85	21.90	21.80	21.86	21.80	21.67	21.86	21.96	22.17
Conducted Power (Watts)	0.1531	0.1549	0.1514	0.1535	0.1514	0.1469	0.1535	0.1570	0.1648
EIRP(dBm)	21.05	21.10	21.00	21.06	21.00	20.87	21.06	21.16	21.37
EIRP(Watts)	0.1274	0.1288	0.1259	0.1276	0.1259	0.1222	0.1276	0.1306	0.1371

LTE Band 4 (GT - LC = -0.80 dB) 64QAM									
Bandwidth	10M			15M			20M		
Channel	132022	132322	132622	132047	132322	132597	132072	132322	132572
	(Low)	(Mid)	(High)	(Low)	(Mid)	(High)	(Low)	(Mid)	(Mid)
Frequency (MHz)	1715	1745	1775	1717.5	1745	1772.5	1720	1745	1770
Conducted Power (dBm)	21.74	22.23	21.82	21.94	21.94	21.89	21.84	21.93	21.94
Conducted Power (Watts)	0.1493	0.1671	0.1521	0.1563	0.1563	0.1545	0.1528	0.1560	0.1563
EIRP(dBm)	20.94	21.43	21.02	21.14	21.14	21.09	21.04	21.13	21.14
EIRP(Watts)	0.1242	0.1390	0.1265	0.1300	0.1300	0.1285	0.1271	0.1297	0.1300



LTE Band 5 (GT - LC = -1.50 dB) QPSK									
Bandwidth	1.4M			3M			5M		
Channel	20407	20525	20643	20415	20525	20635	20425	20525	20625
	(Low)	(Mid)	(High)	(Low)	(Mid)	(High)	(Low)	(Mid)	(High)
Frequency (MHz)	824.7	836.5	848.3	825.5	836.5	847.5	826.5	836.5	846.5
Conducted Power (dBm)	24.20	24.16	24.15	24.16	24.14	24.19	24.18	24.17	24.19
Conducted Power (Watts)	0.2630	0.2606	0.2600	0.2606	0.2594	0.2624	0.2618	0.2612	0.2624
ERP(dBm)	20.55	20.51	20.50	20.51	20.49	20.54	20.53	20.52	20.54
ERP(Watts)	0.1135	0.1125	0.1122	0.1125	0.1119	0.1132	0.1130	0.1127	0.1132

LTE Band 5 (GT - LC = -1.50 dB) QPSK			
Bandwidth	10M		
Channel	20450	20525	20600
	(Low)	(Mid)	(High)
Frequency (MHz)	829	836.5	844
Conducted Power (dBm)	24.10	24.18	24.21
Conducted Power (Watts)	0.2570	0.2618	0.2636
ERP(dBm)	20.45	20.53	20.56
ERP(Watts)	0.1109	0.1130	0.1138



LTE Band 5 (GT - LC = -1.50 dB) 16QAM									
Bandwidth	1.4M			3M			5M		
Channel	20407	20525	20643	20415	20525	20635	20425	20525	20625
	(Low)	(Mid)	(High)	(Low)	(Mid)	(High)	(Low)	(Mid)	(High)
Frequency (MHz)	824.7	836.5	848.3	825.5	836.5	847.5	826.5	836.5	846.5
Conducted Power (dBm)	23.29	23.24	23.13	23.28	23.24	23.15	23.30	23.20	23.14
Conducted Power (Watts)	0.2133	0.2109	0.2056	0.2128	0.2109	0.2065	0.2138	0.2089	0.2061
ERP(dBm)	19.64	19.59	19.48	19.63	19.59	19.50	19.65	19.55	19.49
ERP(Watts)	0.0920	0.0910	0.0887	0.0918	0.0910	0.0891	0.0923	0.0902	0.0889

LTE Band 5 (GT - LC = -1.50 dB) 16QAM			
Bandwidth	10M		
Channel	20450	20525	20600
	(Low)	(Mid)	(High)
Frequency (MHz)	829	836.5	844
Conducted Power (dBm)	23.45	23.46	23.39
Conducted Power (Watts)	0.2213	0.2218	0.2183
ERP(dBm)	19.80	19.81	19.74
ERP(Watts)	0.0955	0.0957	0.0942



LTE Band 5 (GT - LC = -1.50 dB) 64QAM									
Bandwidth	1.4M			3M			5M		
Channel	20407	20525	20643	20415	20525	20635	20425	20525	20625
	(Low)	(Mid)	(High)	(Low)	(Mid)	(High)	(Low)	(Mid)	(High)
Frequency (MHz)	824.7	836.5	848.3	825.5	836.5	847.5	826.5	836.5	846.5
Conducted Power (dBm)	22.26	22.18	22.17	22.20	22.29	22.30	22.18	22.21	22.30
Conducted Power (Watts)	0.1683	0.1652	0.1648	0.1660	0.1694	0.1698	0.1652	0.1663	0.1698
ERP(dBm)	18.61	18.53	18.52	18.55	18.64	18.65	18.53	18.56	18.65
ERP(Watts)	0.0726	0.0713	0.0711	0.0716	0.0731	0.0733	0.0713	0.0718	0.0733

LTE Band 5 (GT - LC = -1.50 dB) 64QAM			
Bandwidth	10M		
Channel	20450	20525	20600
	(Low)	(Mid)	(High)
Frequency (MHz)	829	836.5	844
Conducted Power (dBm)	22.50	22.42	22.47
Conducted Power (Watts)	0.1778	0.1746	0.1766
ERP(dBm)	18.85	18.77	18.82
ERP(Watts)	0.0767	0.0753	0.0762



LTE Band 12 (GT - LC = -2.00 dB) QPSK									
Bandwidth	1.4M			3M			5M		
Channel	23017	23095	23173	23025	23095	23165	23035	23095	23155
	(Low)	(Mid)	(High)	(Low)	(Mid)	(High)	(Low)	(Mid)	(High)
Frequency (MHz)	699.7	707.5	715.3	700.5	707.5	714.5	701.5	707.5	713.5
Conducted Power (dBm)	24.15	24.18	24.12	23.08	23.11	23.08	23.20	23.16	23.15
Conducted Power (Watts)	0.2600	0.2618	0.2582	0.2032	0.2046	0.2032	0.2089	0.2070	0.2065
ERP(dBm)	20.00	20.03	19.97	18.93	18.96	18.93	19.05	19.01	19.00
ERP(Watts)	0.1000	0.1007	0.0993	0.0782	0.0787	0.0782	0.0804	0.0796	0.0794

LTE Band 12 (GT - LC = -2.00 dB) QPSK			
Bandwidth	10M		
Channel	23060	23095	23130
	(Low)	(Mid)	(High)
Frequency (MHz)	704	707.5	711
Conducted Power (dBm)	23.13	23.26	23.18
Conducted Power (Watts)	0.2056	0.2118	0.2080
ERP(dBm)	18.98	19.11	19.03
ERP(Watts)	0.0791	0.0815	0.0800



LTE Band 12 (GT - LC = -2.00 dB) 16QAM									
Bandwidth	1.4M			3M			5M		
Channel	23017	23095	23173	23025	23095	23165	23035	23095	23155
	(Low)	(Mid)	(High)	(Low)	(Mid)	(High)	(Low)	(Mid)	(High)
Frequency (MHz)	699.7	707.5	715.3	700.5	707.5	714.5	701.5	707.5	713.5
Conducted Power (dBm)	23.14	23.11	23.09	22.14	22.13	22.09	22.16	22.09	22.03
Conducted Power (Watts)	0.2061	0.2046	0.2037	0.1637	0.1633	0.1618	0.1644	0.1618	0.1596
ERP(dBm)	18.99	18.96	18.94	17.99	17.98	17.94	18.01	17.94	17.88
ERP(Watts)	0.0793	0.0787	0.0783	0.0630	0.0628	0.0622	0.0632	0.0622	0.0614

LTE Band 12 (GT - LC = -2.00 dB) 16QAM			
Bandwidth	10M		
Channel	23060	23095	23130
	(Low)	(Mid)	(High)
Frequency (MHz)	704	707.5	711
Conducted Power (dBm)	22.15	22.15	22.17
Conducted Power (Watts)	0.1641	0.1641	0.1648
ERP(dBm)	18.00	18.00	18.02
ERP(Watts)	0.0631	0.0631	0.0634



LTE Band 12 (GT - LC = -2.00 dB) 64QAM									
Bandwidth	1.4M			3M			5M		
Channel	23017	23095	23173	23025	23095	23165	23035	23095	23155
	(Low)	(Mid)	(High)	(Low)	(Mid)	(High)	(Low)	(Mid)	(High)
Frequency (MHz)	699.7	707.5	715.3	700.5	707.5	714.5	701.5	707.5	713.5
Conducted Power (dBm)	22.26	22.23	22.18	21.13	21.14	21.08	21.22	21.16	21.15
Conducted Power (Watts)	0.1683	0.1671	0.1652	0.1297	0.1300	0.1282	0.1324	0.1306	0.1303
ERP(dBm)	18.11	18.08	18.03	16.98	16.99	16.93	17.07	17.01	17.00
ERP(Watts)	0.0647	0.0643	0.0635	0.0499	0.0500	0.0493	0.0509	0.0502	0.0501

LTE Band 12 (GT - LC = -2.00 dB) 64QAM			
Bandwidth	10M		
Channel	23060	23095	23130
	(Low)	(Mid)	(High)
Frequency (MHz)	704	707.5	711
Conducted Power (dBm)	21.15	21.14	21.20
Conducted Power (Watts)	0.1303	0.1300	0.1318
ERP(dBm)	17.00	16.99	17.05
ERP(Watts)	0.0501	0.0500	0.0507



LTE Band 66 (GT - LC = -0.80 dB) QPSK									
Bandwidth	1.4M			3M			5M		
Channel	131979	132322	132665	131987	132322	132657	131997	132322	132647
	(Low)	(Mid)	(High)	(Low)	(Mid)	(High)	(Low)	(Mid)	(High)
Frequency (MHz)	1710.7	1745	1779.3	1711.5	1745	1778.5	1712.5	1745	1777.5
Conducted Power (dBm)	23.52	23.53	23.43	22.49	22.53	22.40	22.55	22.58	22.46
Conducted Power (Watts)	0.2249	0.2254	0.2203	0.1774	0.1791	0.1738	0.1799	0.1811	0.1762
EIRP(dBm)	22.72	22.73	22.63	21.69	21.73	21.60	21.75	21.78	21.66
EIRP(Watts)	0.1871	0.1875	0.1832	0.1476	0.1489	0.1445	0.1496	0.1507	0.1466

LTE Band 66 (GT - LC = -0.80 dB) QPSK									
Bandwidth	10M			15M			20M		
Channel	132022	132322	132622	132047	132322	132597	132072	132322	132572
	(Low)	(Mid)	(High)	(Low)	(Mid)	(High)	(Low)	(Mid)	(Mid)
Frequency (MHz)	1715	1745	1775	1717.5	1745	1772.5	1720	1745	1770
Conducted Power (dBm)	22.53	22.56	22.44	22.56	22.61	22.46	22.63	22.78	22.54
Conducted Power (Watts)	0.1791	0.1803	0.1754	0.1803	0.1824	0.1762	0.1832	0.1897	0.1795
EIRP(dBm)	21.73	21.76	21.64	21.76	21.81	21.66	21.83	21.98	21.74
EIRP(Watts)	0.1489	0.1500	0.1459	0.1500	0.1517	0.1466	0.1524	0.1578	0.1493



LTE Band 66 (GT - LC = -0.80 dB) 16QAM									
Bandwidth	1.4M			3M			5M		
Channel	131979	132322	132665	131987	132322	132657	131997	132322	132647
	(Low)	(Mid)	(High)	(Low)	(Mid)	(High)	(Low)	(Mid)	(High)
Frequency (MHz)	1710.7	1745	1779.3	1711.5	1745	1778.5	1712.5	1745	1777.5
Conducted Power (dBm)	22.45	22.51	22.37	21.56	21.65	21.38	21.56	21.61	21.37
Conducted Power (Watts)	0.1758	0.1782	0.1726	0.1432	0.1462	0.1374	0.1432	0.1449	0.1371
EIRP(dBm)	21.65	21.71	21.57	20.76	20.85	20.58	20.76	20.81	20.57
EIRP(Watts)	0.1462	0.1483	0.1435	0.1191	0.1216	0.1143	0.1191	0.1205	0.1140

LTE Band 66 (GT - LC = -0.80 dB) 16QAM									
Bandwidth	10M			15M			20M		
Channel	132022	132322	132622	132047	132322	132597	132072	132322	132572
	(Low)	(Mid)	(High)	(Low)	(Mid)	(High)	(Low)	(Mid)	(Mid)
Frequency (MHz)	1715	1745	1775	1717.5	1745	1772.5	1720	1745	1770
Conducted Power (dBm)	21.55	21.62	21.40	21.56	21.60	21.43	21.67	21.79	21.56
Conducted Power (Watts)	0.1429	0.1452	0.1380	0.1432	0.1445	0.1390	0.1469	0.1510	0.1432
EIRP(dBm)	20.75	20.82	20.60	20.76	20.80	20.63	20.87	20.99	20.76
EIRP(Watts)	0.1189	0.1208	0.1148	0.1191	0.1202	0.1156	0.1222	0.1256	0.1191



LTE Band 66 (GT - LC = -0.80 dB) 64QAM									
Bandwidth	1.4M			3M			5M		
Channel	131979	132322	132665	131987	132322	132657	131997	132322	132647
	(Low)	(Mid)	(High)	(Low)	(Mid)	(High)	(Low)	(Mid)	(High)
Frequency (MHz)	1710.7	1745	1779.3	1711.5	1745	1778.5	1712.5	1745	1777.5
Conducted Power (dBm)	21.64	21.65	21.47	20.55	20.59	20.45	20.61	20.60	20.47
Conducted Power (Watts)	0.1459	0.1462	0.1403	0.1135	0.1146	0.1109	0.1151	0.1148	0.1114
EIRP(dBm)	20.84	20.85	20.67	19.75	19.79	19.65	19.81	19.80	19.67
EIRP(Watts)	0.1213	0.1216	0.1167	0.0944	0.0953	0.0923	0.0957	0.0955	0.0927

LTE Band 66 (GT - LC = -0.80 dB) 64QAM									
Bandwidth	10M			15M			20M		
Channel	132022	132322	132622	132047	132322	132597	132072	132322	132572
	(Low)	(Mid)	(High)	(Low)	(Mid)	(High)	(Low)	(Mid)	(Mid)
Frequency (MHz)	1715	1745	1775	1717.5	1745	1772.5	1720	1745	1770
Conducted Power (dBm)	20.55	20.60	20.46	20.55	20.62	20.46	20.68	20.79	20.55
Conducted Power (Watts)	0.1135	0.1148	0.1112	0.1135	0.1153	0.1112	0.1169	0.1199	0.1135
EIRP(dBm)	19.75	19.80	19.66	19.75	19.82	19.66	19.88	19.99	19.75
EIRP(Watts)	0.0944	0.0955	0.0925	0.0944	0.0959	0.0925	0.0973	0.0998	0.0944



LTE Band 2

Peak-to-Average Ratio

Mode	LTE Band 2 / 20MHz				
Mod.	QPSK		16QAM		Limit: 13dB
RB Size	1RB	Full RB	1RB	Full RB	Result
Lowest CH	4.84	5.48	5.77	6.41	PASS
Middle CH	5.01	5.3	5.88	6.14	
Highest CH	4.49	5.25	5.28	6.03	
Mode	LTE Band 2 / 20MHz				
Mod.	64QAM		-		Limit: 13dB
RB Size	1RB	Full RB	-	-	Result
Lowest CH	5.28	6.26	-	-	PASS
Middle CH	5.16	6.09	-	-	
Highest CH	5.16	5.97	-	-	



LTE Band 2 / 20MHz / QPSK

Lowest Channel / 1RB

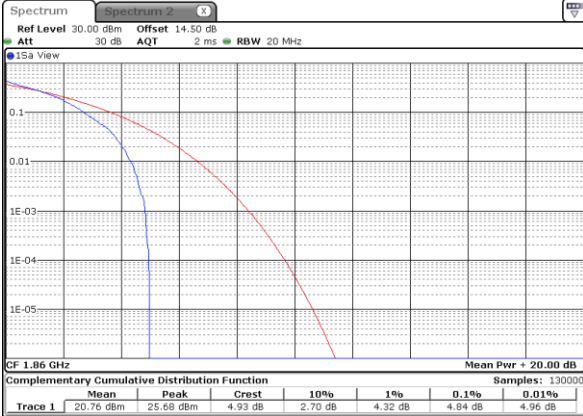

Date: 9,MAR,2020 22:41:42

Lowest Channel / Full RB

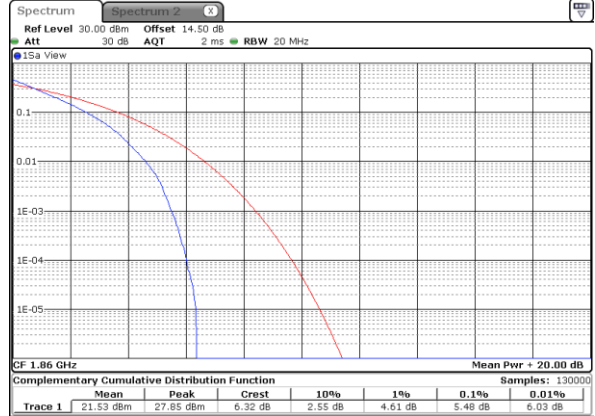

Date: 9,MAR,2020 22:44:42

Middle Channel / 1RB

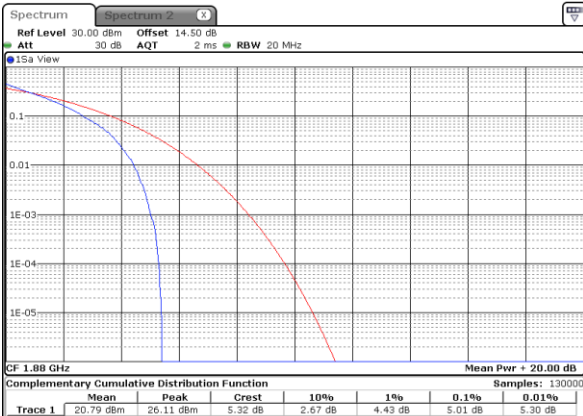

Date: 9,MAR,2020 22:47:24

Middle Channel / Full RB

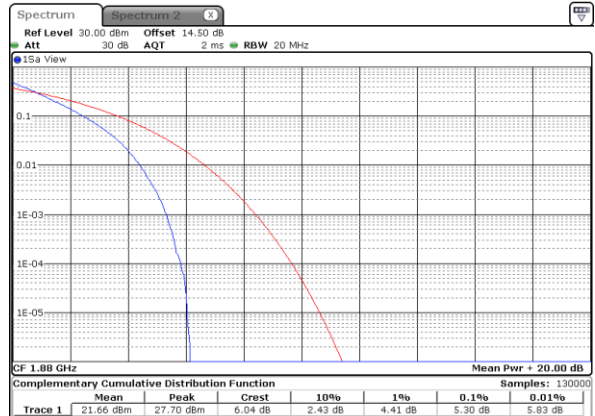

Date: 9,MAR,2020 22:45:27

Highest Channel / 1RB

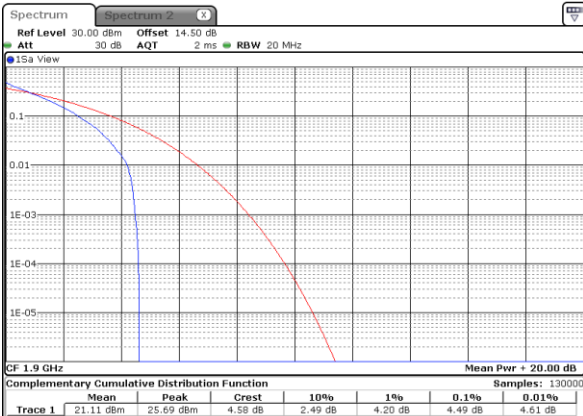

Date: 9,MAR,2020 22:47:56

Highest Channel / Full RB

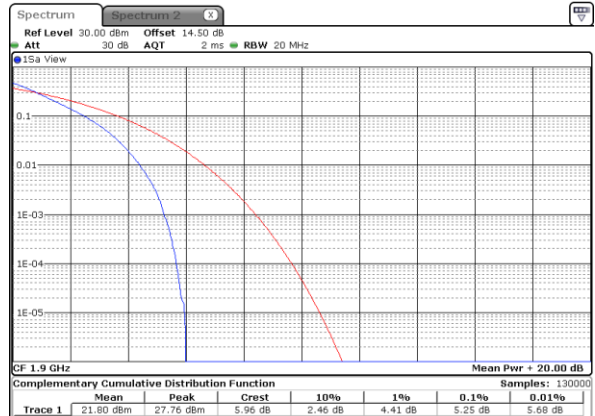

Date: 9,MAR,2020 22:49:46



LTE Band 2 / 20MHz / 16QAM

Lowest Channel / 1RB

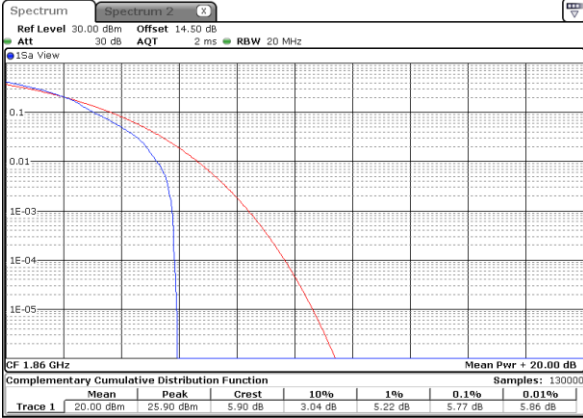

Date: 9,MAR,2020 22:41:59

Lowest Channel / Full RB

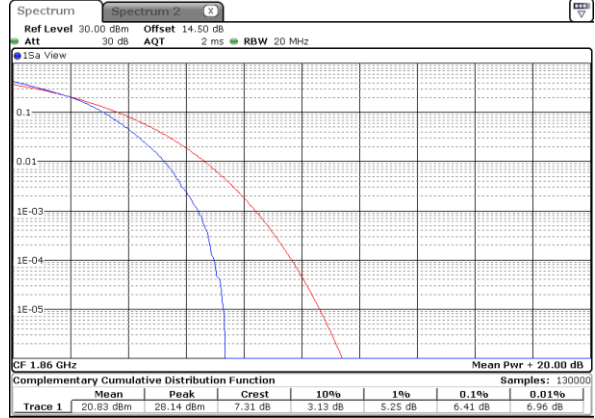

Date: 9,MAR,2020 22:44:22

Middle Channel / 1RB

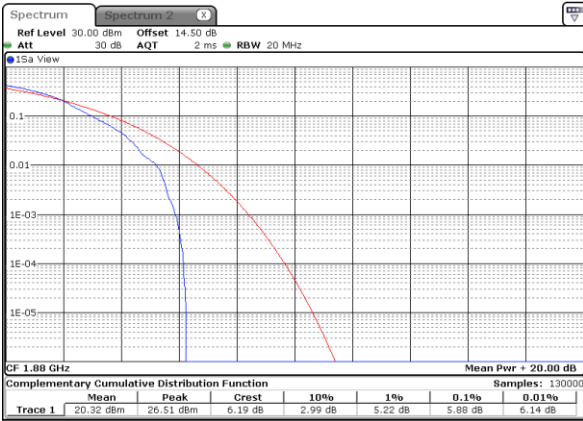

Date: 9,MAR,2020 22:47:03

Middle Channel / Full RB

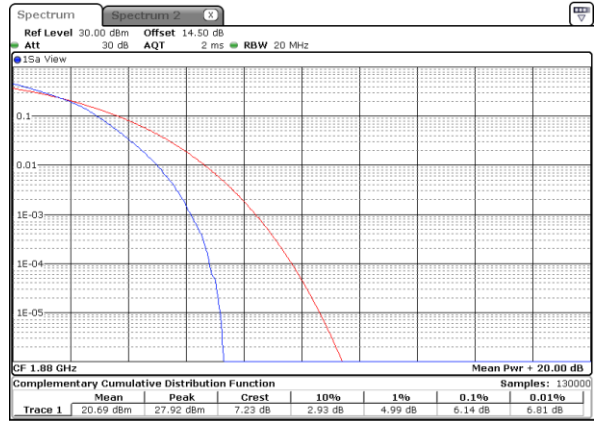

Date: 9,MAR,2020 22:45:49

Highest Channel / 1RB

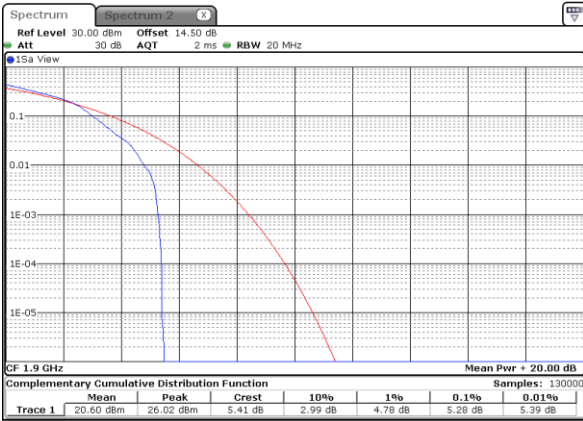

Date: 9,MAR,2020 22:48:19

Highest Channel / Full RB

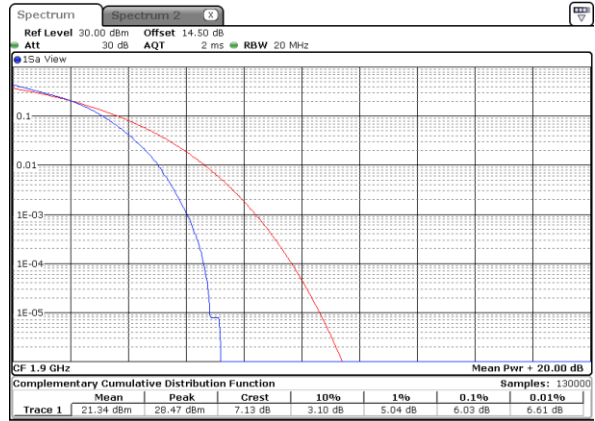

Date: 9,MAR,2020 22:49:23



LTE Band 2 / 20MHz / 64QAM

Lowest Channel / 1RB

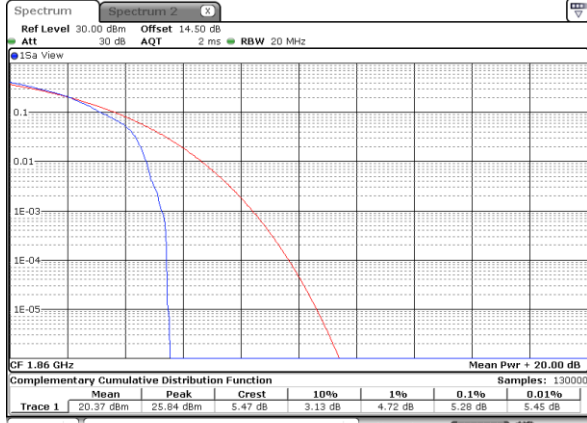

Date: 9,MAR,2020 22:43:21

Lowest Channel / Full RB

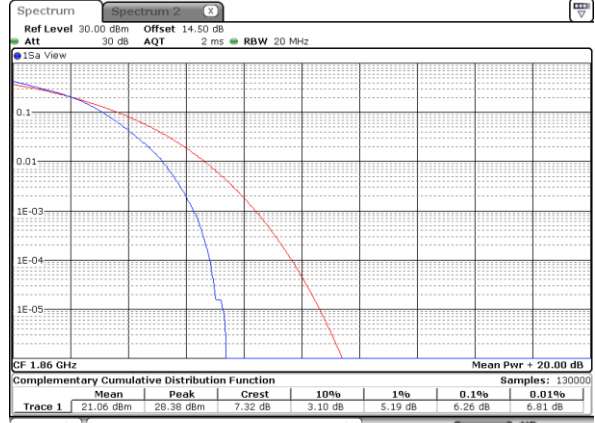

Date: 9,MAR,2020 22:43:59

Middle Channel / 1RB

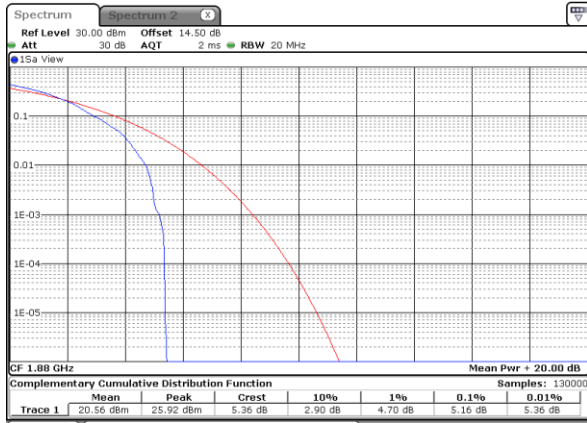

Date: 9,MAR,2020 22:46:39

Middle Channel / Full RB

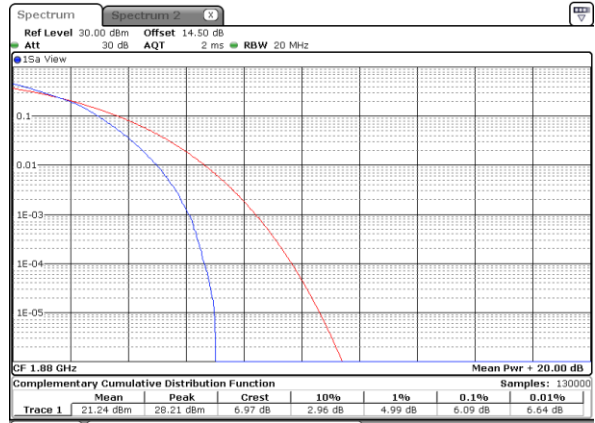

Date: 9,MAR,2020 22:46:19

Highest Channel / 1RB

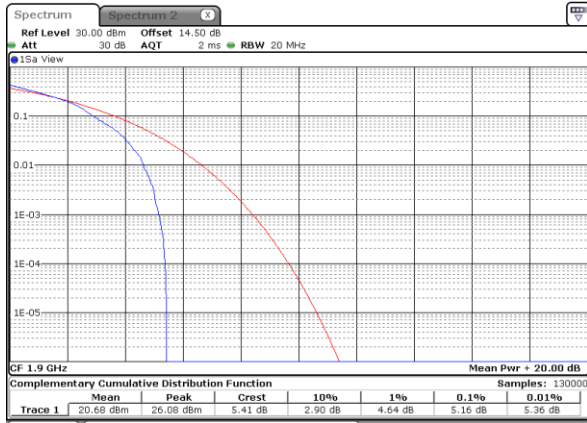

Date: 9,MAR,2020 22:48:44

Highest Channel / Full RB

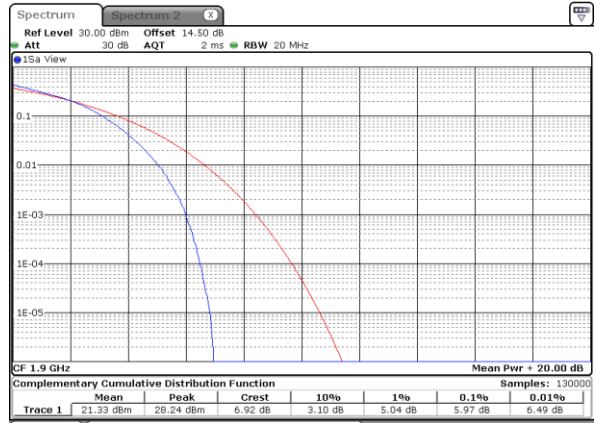

Date: 9,MAR,2020 22:49:05



26dB Bandwidth

Mode	LTE Band 2 : 26dB BW(MHz)											
BW	1.4MHz		3MHz		5MHz		10MHz		15MHz		20MHz	
Mod.	QPSK	16QAM	QPSK	16QAM	QPSK	16QAM	QPSK	16QAM	QPSK	16QAM	QPSK	16QAM
Lowest CH	1.29	1.27	2.97	2.94	4.84	4.83	9.73	9.63	14.24	14.39	19.06	18.78
Middle CH	1.28	1.28	2.93	2.94	4.79	4.83	9.63	9.95	14.36	14.27	18.98	18.74
Highest CH	1.28	1.26	2.96	2.94	4.92	4.86	9.79	9.79	14.3	14.48	18.9	18.74
Mode	LTE Band 2 : 26dB BW(MHz)											
BW	1.4MHz		3MHz		5MHz		10MHz		15MHz		20MHz	
Mod.	64QAM	-	64QAM	-	64QAM	-	64QAM	-	64QAM	-	64QAM	-
Lowest CH	1.26	-	3.00	-	4.89	-	9.69	-	14.36	-	18.98	-
Middle CH	1.27	-	2.97	-	4.83	-	9.71	-	14.39	-	19.10	-
Highest CH	1.27	-	2.93	-	4.87	-	9.67	-	14.21	-	18.94	-



LTE Band 2

Lowest Channel / 1.4MHz / QPSK

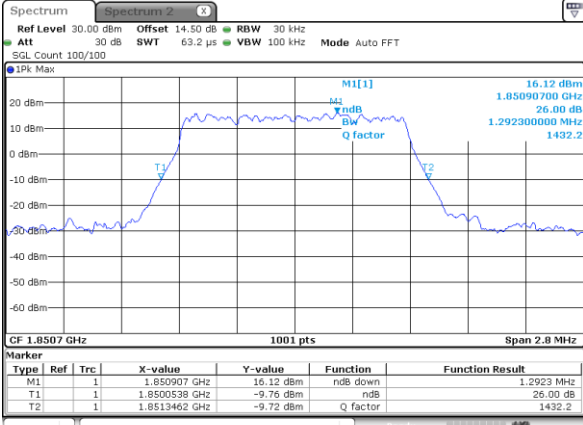

Date: 9,MAR,2020 17:34:53

Lowest Channel / 1.4MHz / 16QAM

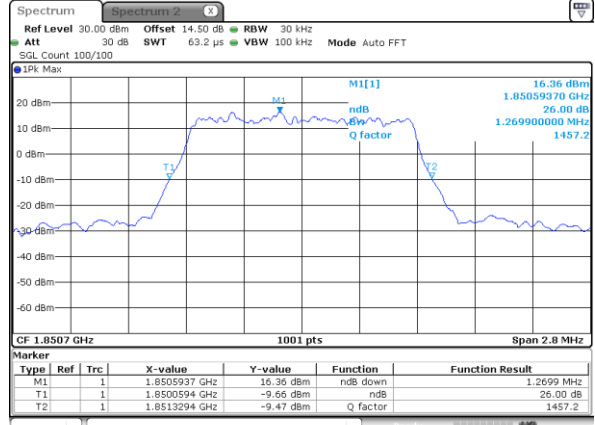

Date: 9,MAR,2020 17:36:39

Middle Channel / 1.4MHz / QPSK

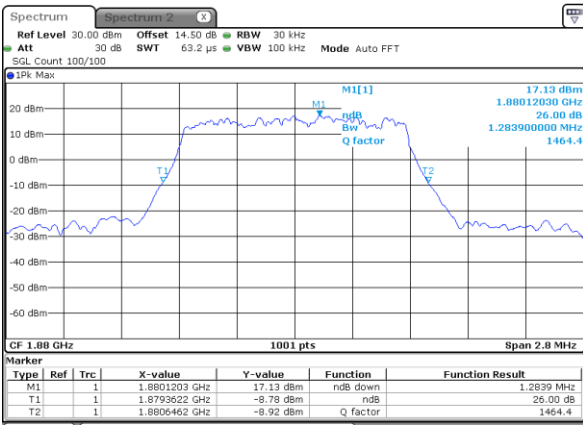

Date: 9,MAR,2020 18:29:20

Middle Channel / 1.4MHz / 16QAM

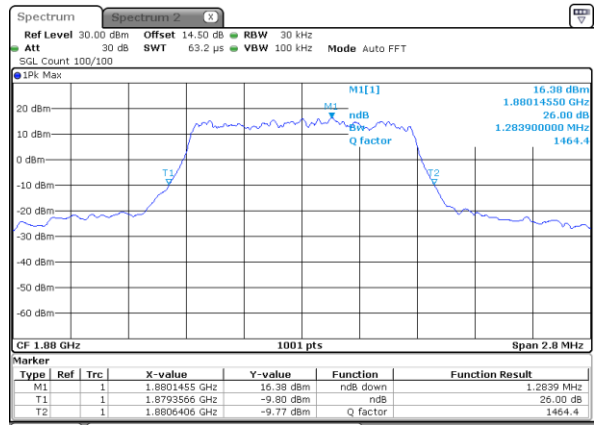

Date: 9,MAR,2020 18:28:51

Highest Channel / 1.4MHz / QPSK

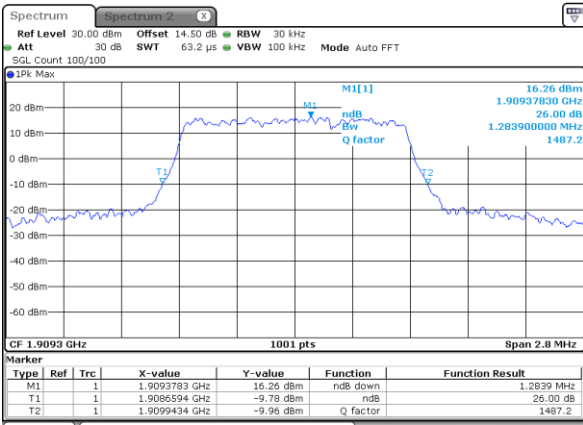

Date: 9,MAR,2020 18:30:13

Highest Channel / 1.4MHz / 16QAM

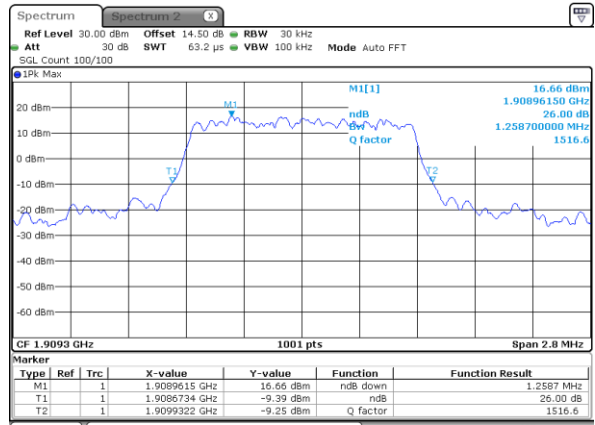

Date: 9,MAR,2020 18:32:02



LTE Band 2

Lowest Channel / 3MHz / QPSK

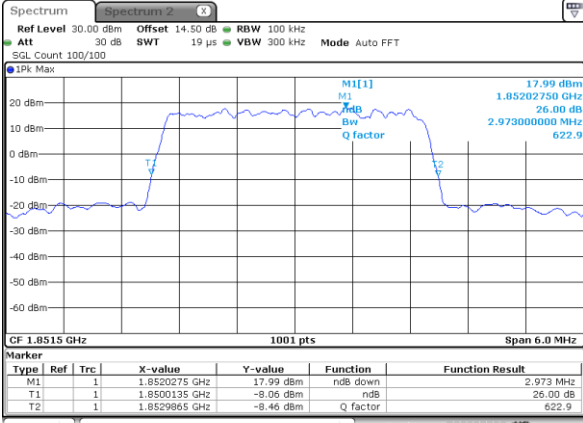

Date: 9_MAR_2020 18:52:11

Lowest Channel / 3MHz / 16QAM

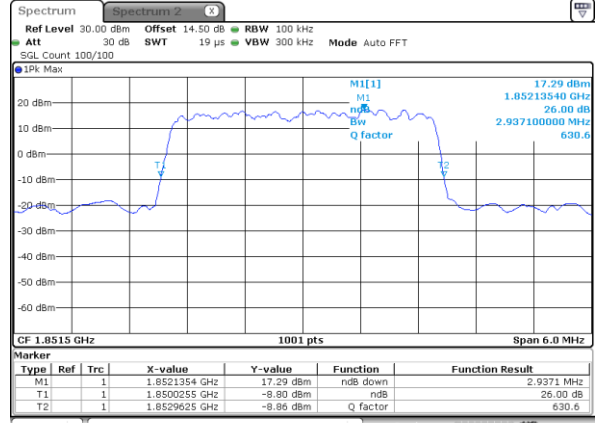

Date: 9_MAR_2020 18:53:13

Middle Channel / 3MHz / QPSK

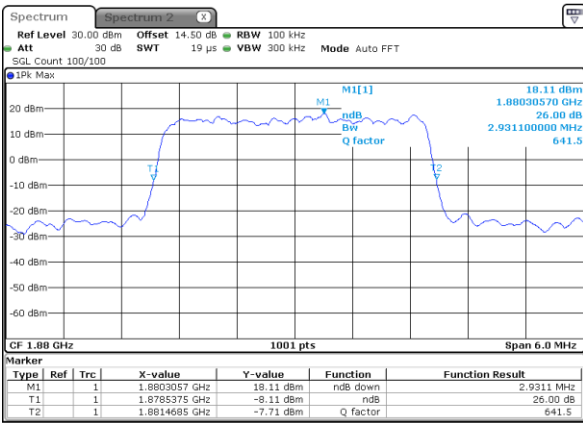

Date: 9_MAR_2020 19:15:55

Middle Channel / 3MHz / 16QAM

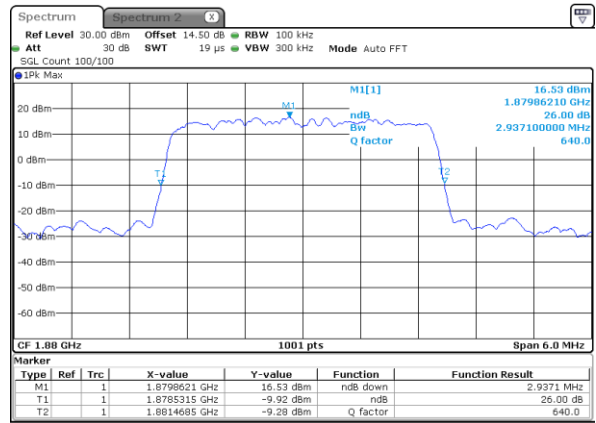

Date: 9_MAR_2020 19:16:21

Highest Channel / 3MHz / QPSK

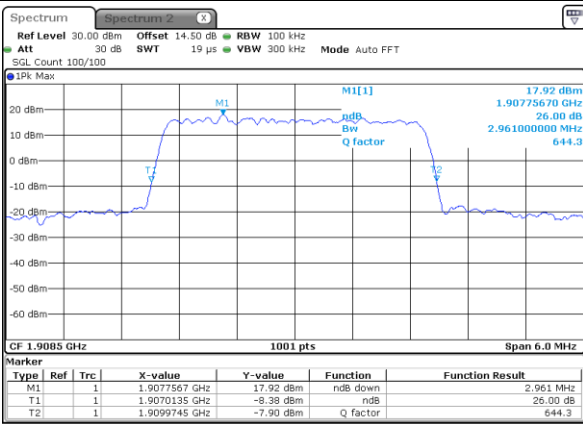

Date: 9_MAR_2020 19:21:00

Highest Channel / 3MHz / 16QAM

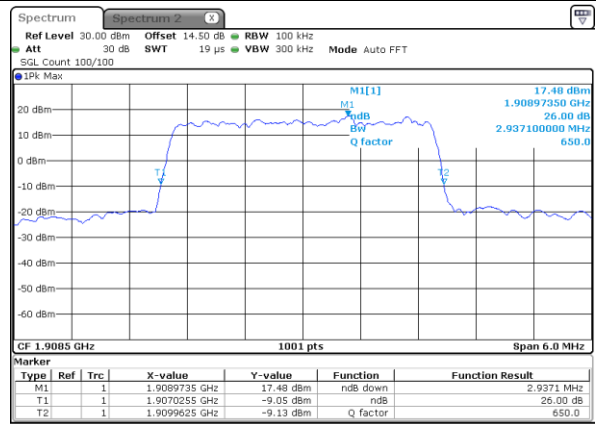

Date: 9_MAR_2020 19:19:52



LTE Band 2

Lowest Channel / 5MHz / QPSK

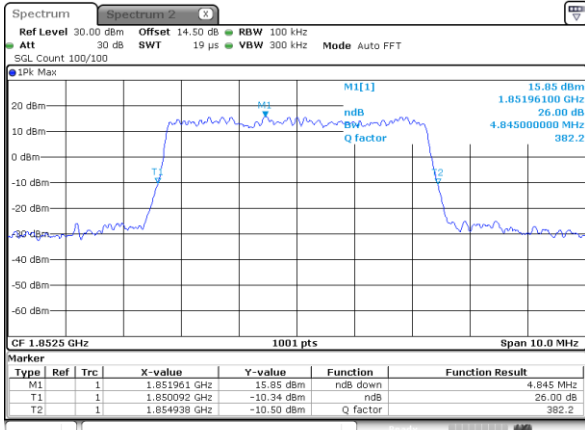

Date: 9,MAR,2020 19:31:02

Lowest Channel / 5MHz / 16QAM

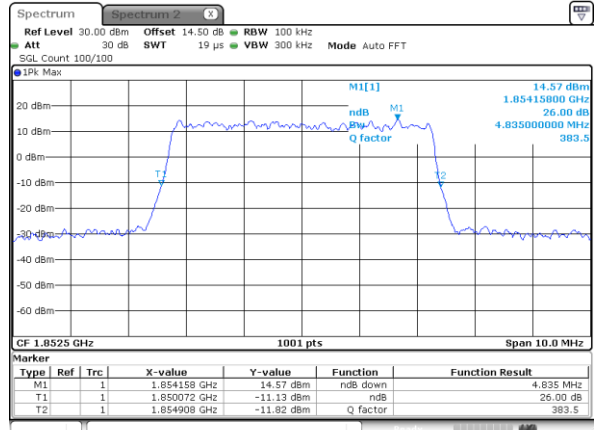

Date: 9,MAR,2020 19:31:45

Middle Channel / 5MHz / QPSK

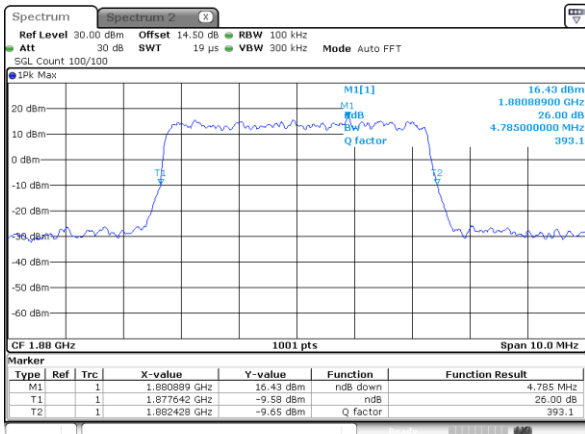

Date: 9,MAR,2020 19:46:32

Middle Channel / 5MHz / 16QAM

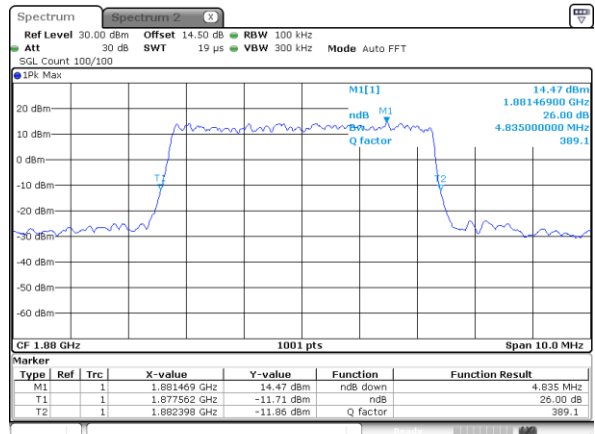

Date: 9,MAR,2020 19:46:12

Highest Channel / 5MHz / QPSK

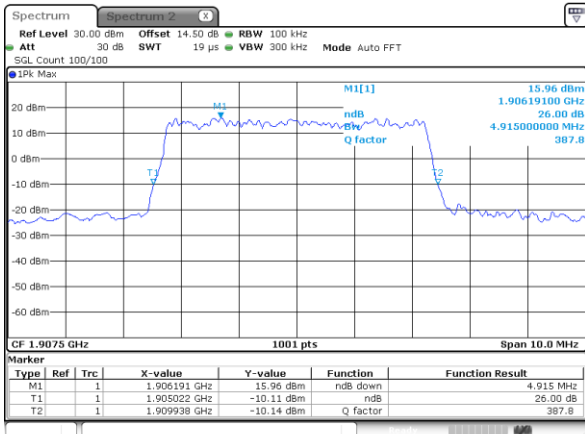

Date: 9,MAR,2020 19:47:08

Highest Channel / 5MHz / 16QAM

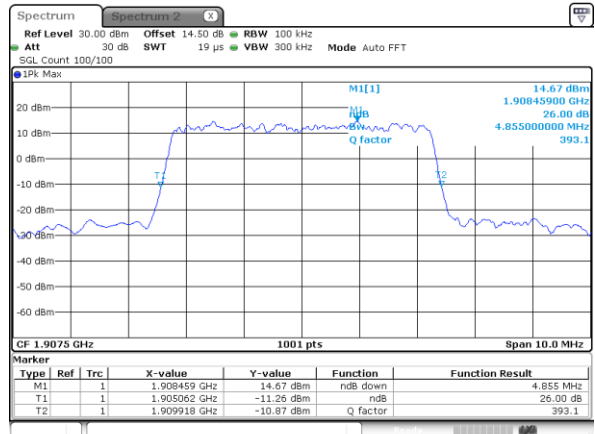

Date: 9,MAR,2020 19:47:55



LTE Band 2

Lowest Channel / 10MHz / QPSK

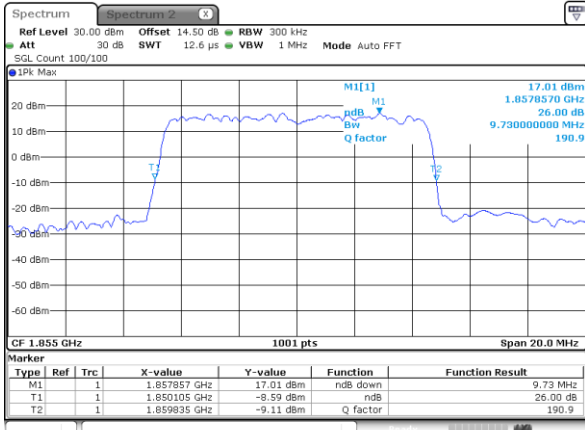

Date: 9,MAR,2020 19:58:54

Lowest Channel / 10MHz / 16QAM

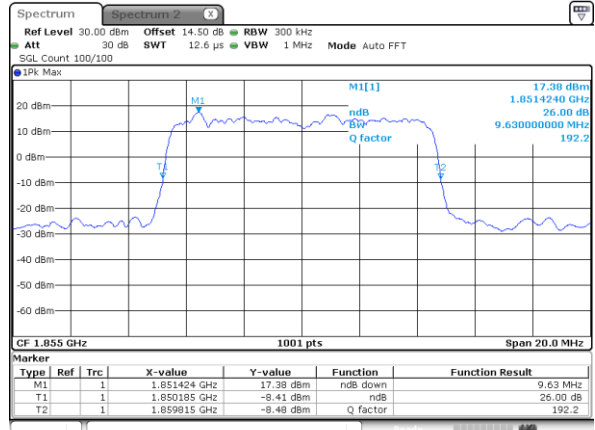

Date: 9,MAR,2020 19:58:19

Middle Channel / 10MHz / QPSK

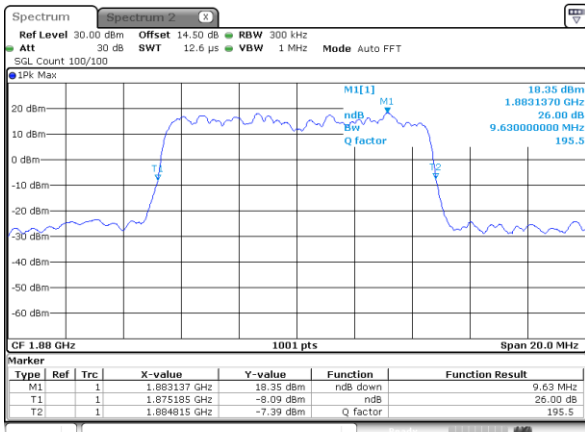

Date: 9,MAR,2020 20:11:58

Middle Channel / 10MHz / 16QAM

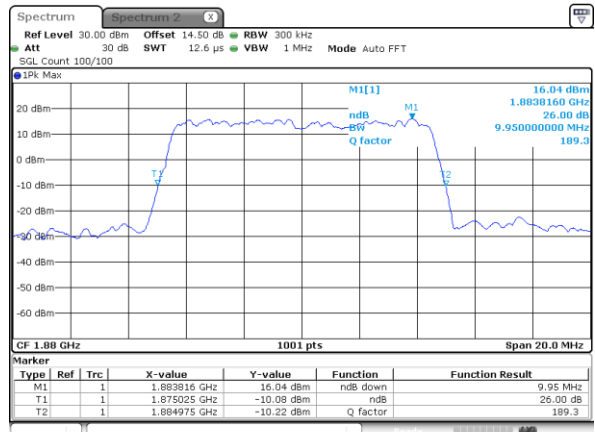

Date: 9,MAR,2020 20:12:27

Highest Channel / 10MHz / QPSK

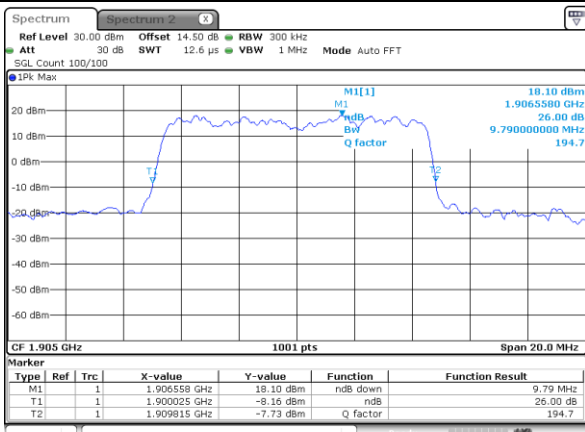

Date: 9,MAR,2020 20:15:35

Highest Channel / 10MHz / 16QAM

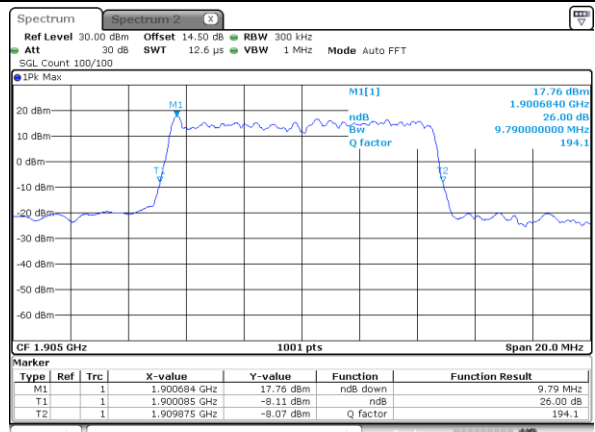

Date: 9,MAR,2020 20:14:58



LTE Band 2

Lowest Channel / 15MHz / QPSK

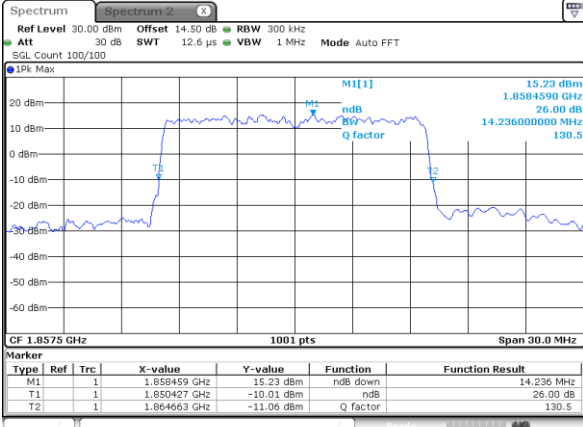

Date: 9,MAR,2020 20:26:24

Lowest Channel / 15MHz / 16QAM

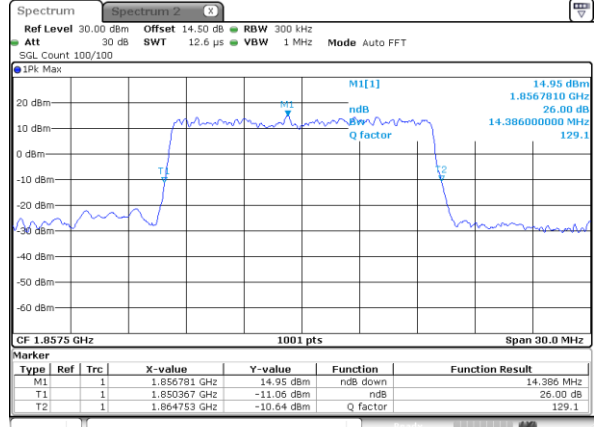

Date: 9,MAR,2020 20:27:02

Middle Channel / 15MHz / QPSK

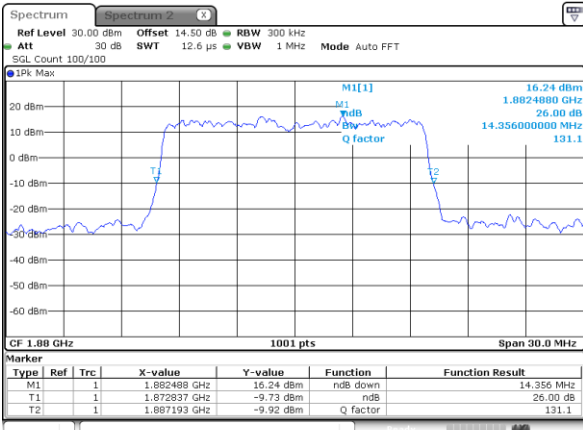

Date: 9,MAR,2020 20:37:36

Middle Channel / 15MHz / 16QAM

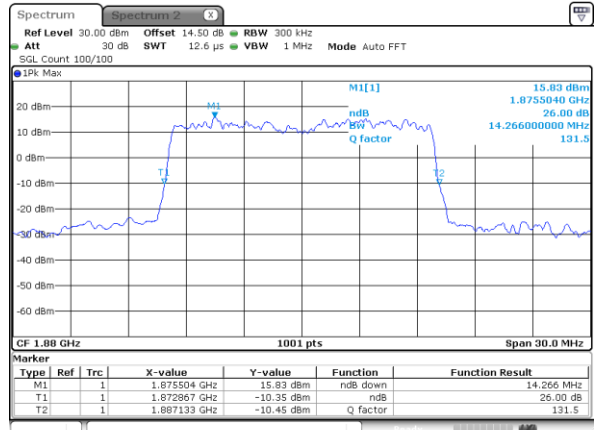

Date: 9,MAR,2020 20:37:59

Highest Channel / 15MHz / QPSK

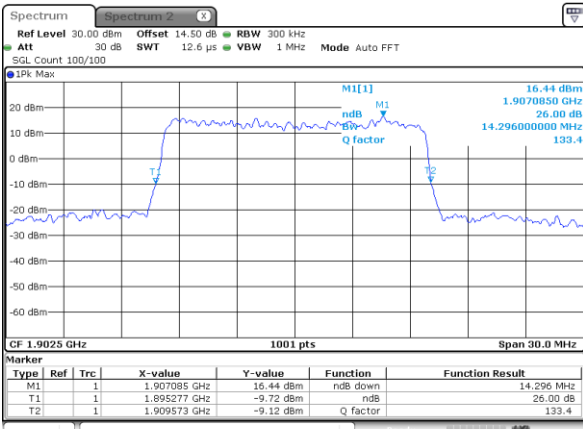

Date: 9,MAR,2020 20:39:58

Highest Channel / 15MHz / 16QAM

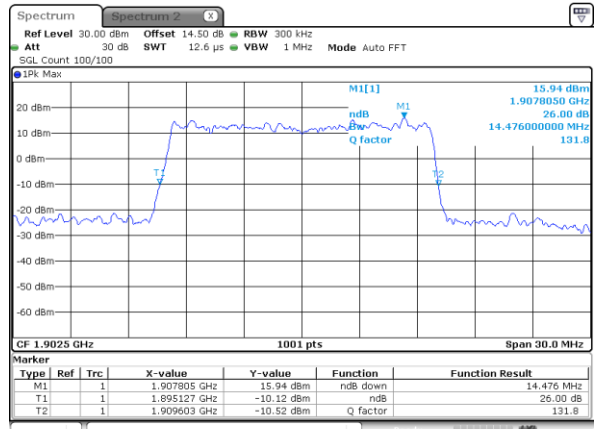

Date: 9,MAR,2020 20:39:23



LTE Band 2

Lowest Channel / 20MHz / QPSK

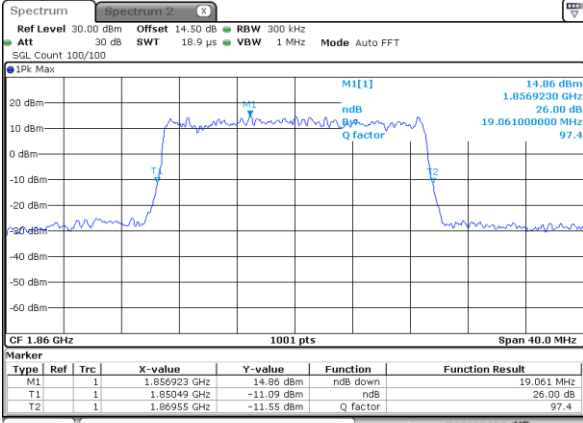

Date: 9_MAR_2020 21:03:06

Lowest Channel / 20MHz / 16QAM

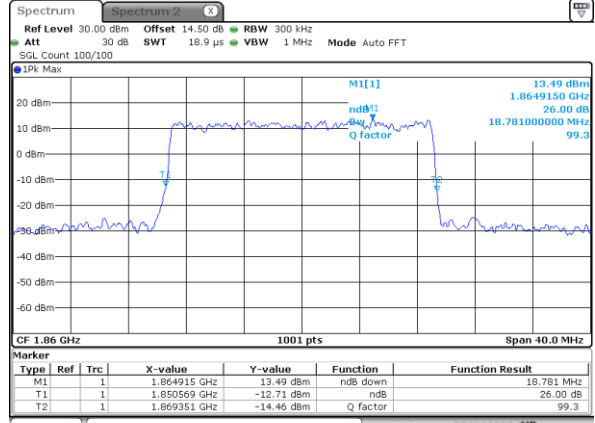

Date: 9_MAR_2020 21:02:23

Middle Channel / 20MHz / QPSK

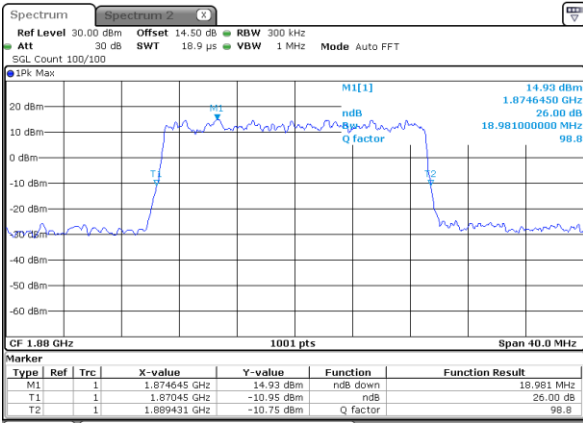

Date: 9_MAR_2020 21:11:52

Middle Channel / 20MHz / 16QAM

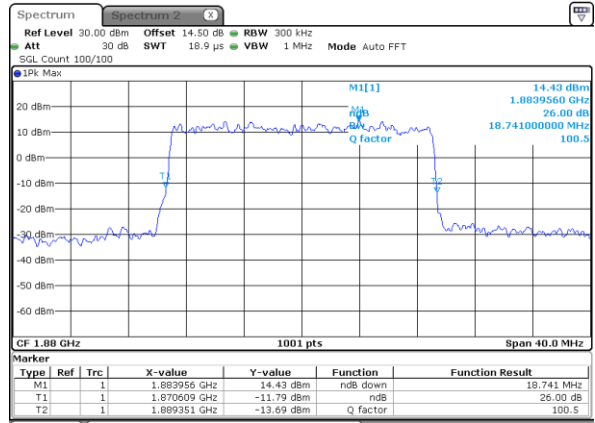

Date: 9_MAR_2020 21:12:13

Highest Channel / 20MHz / QPSK

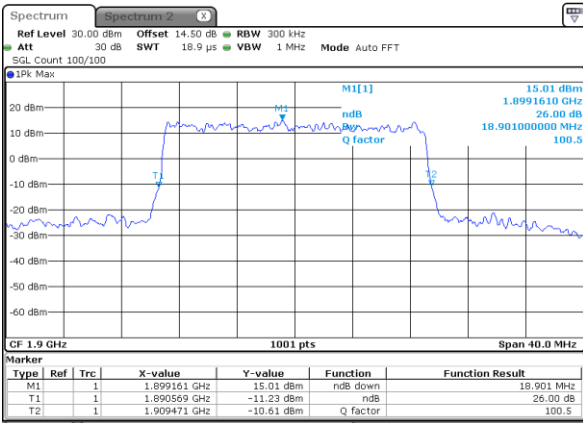

Date: 9_MAR_2020 21:11:52

Highest Channel / 20MHz / 16QAM

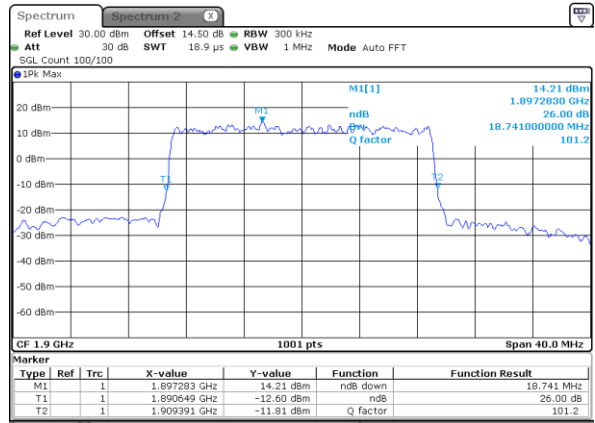

Date: 9_MAR_2020 21:14:45



LTE Band 2

Lowest Channel / 1.4MHz / 64QAM

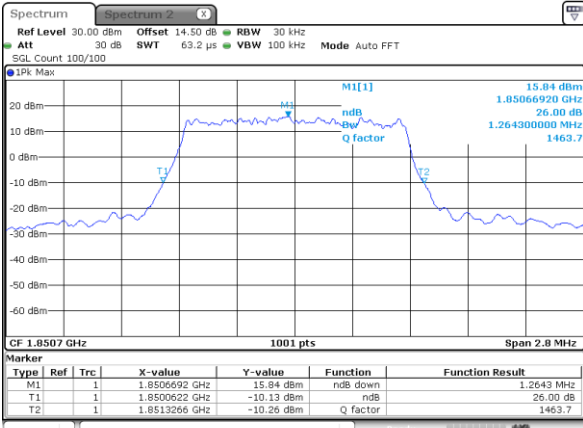

Date: 9,MAR,2020 17:38:23

Lowest Channel / 3MHz / 64QAM

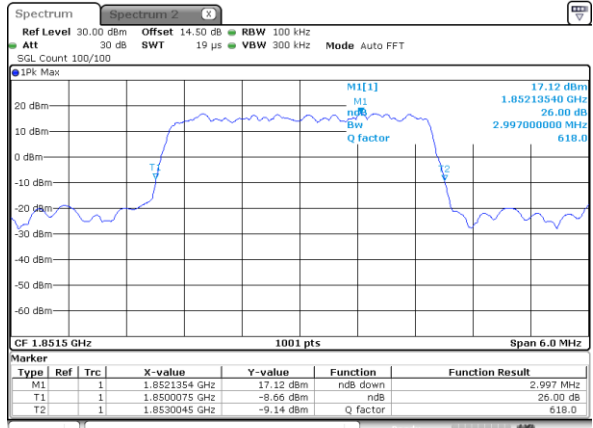

Date: 9,MAR,2020 18:51:04

Middle Channel / 1.4MHz / 64QAM

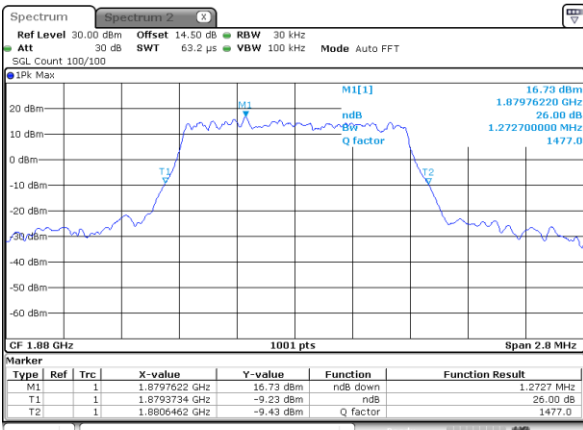

Date: 9,MAR,2020 18:28:20

Middle Channel / 3MHz / 64QAM

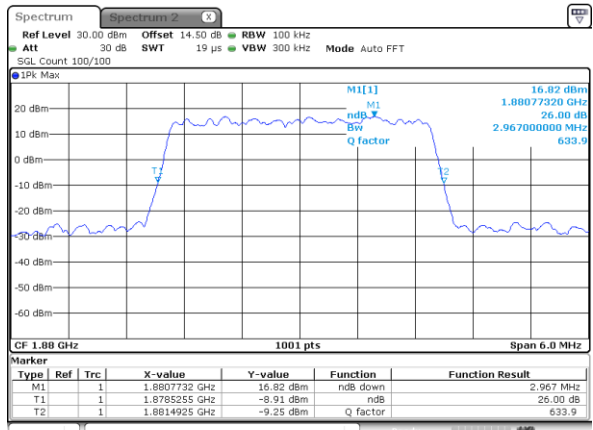

Date: 9,MAR,2020 19:17:25

Highest Channel / 1.4MHz / 64QAM

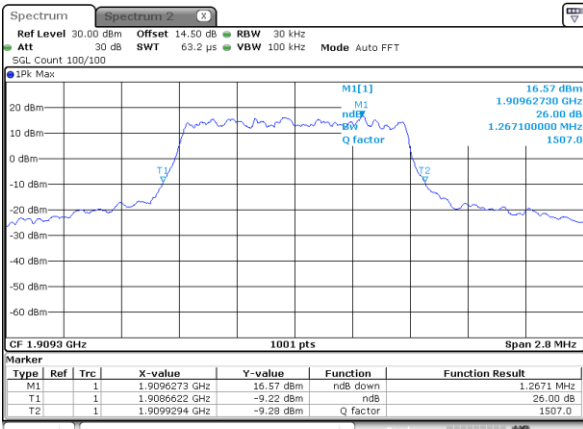

Date: 9,MAR,2020 18:34:45

Highest Channel / 3MHz / 64QAM

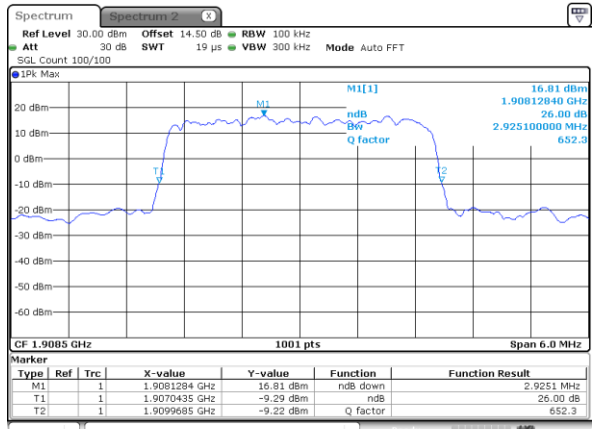

Date: 9,MAR,2020 19:18:32



LTE Band 2

Lowest Channel / 5MHz / 64QAM

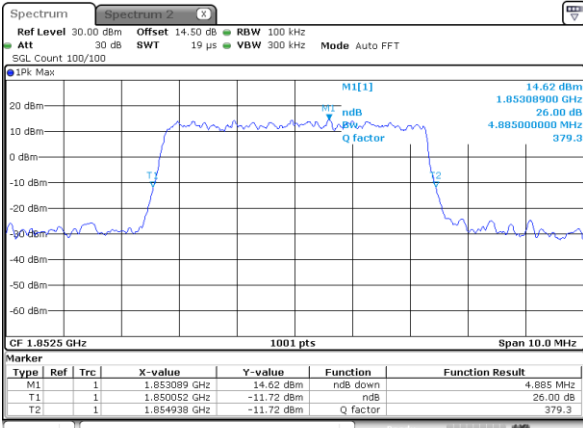

Date: 9,MAR,2020 19:32:47

Lowest Channel / 10MHz / 64QAM

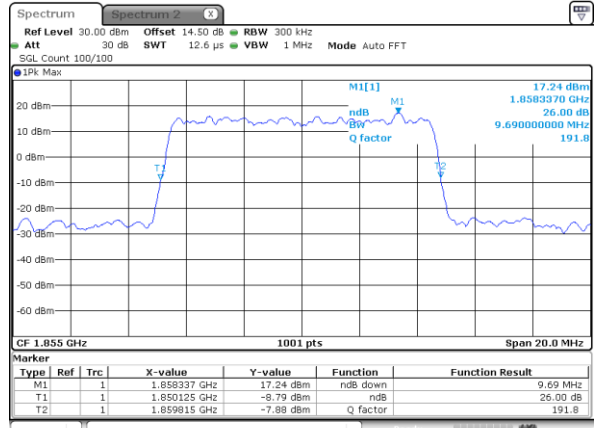

Date: 9,MAR,2020 19:57:29

Middle Channel / 5MHz / 64QAM

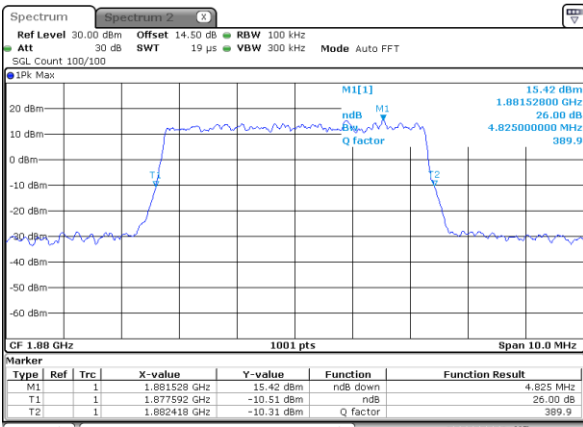

Date: 9,MAR,2020 19:45:49

Middle Channel / 10MHz / 64QAM

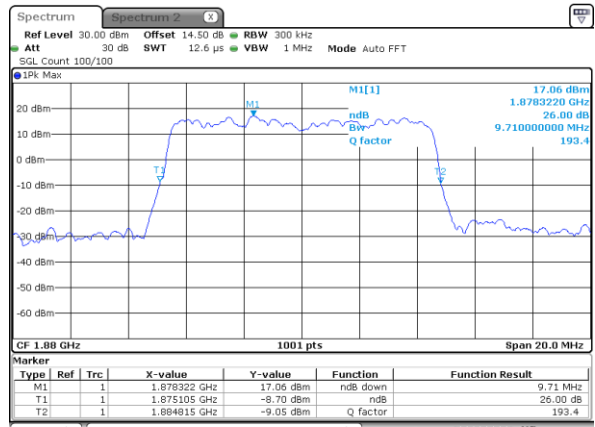

Date: 9,MAR,2020 20:13:06

Highest Channel / 5MHz / 64QAM

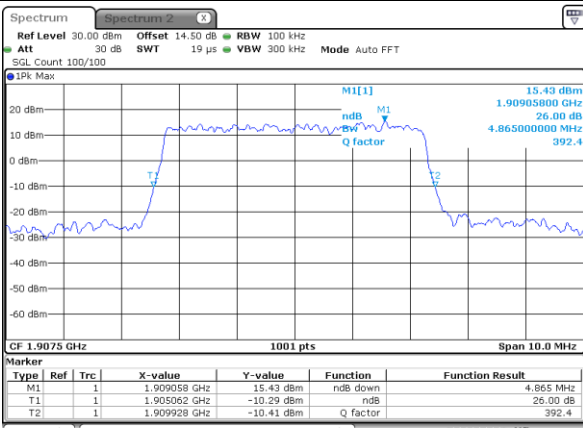

Date: 9,MAR,2020 19:48:48

Highest Channel / 10MHz / 64QAM

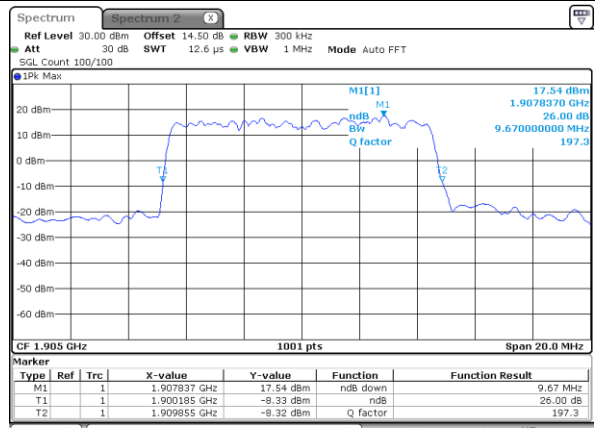

Date: 9,MAR,2020 20:14:14



LTE Band 2

Lowest Channel / 15MHz / 64QAM

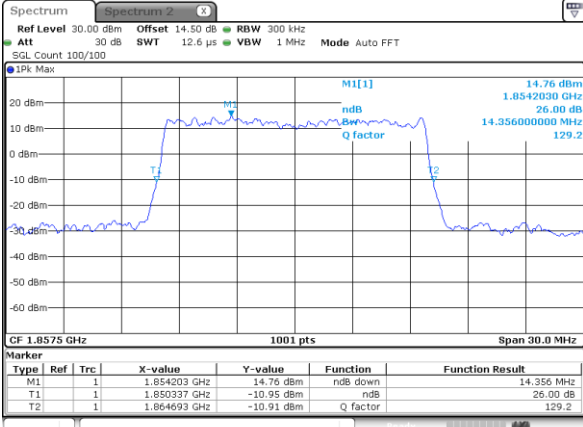

Date: 9,MAR,2020 20:27:59

Lowest Channel / 20MHz / 64QAM

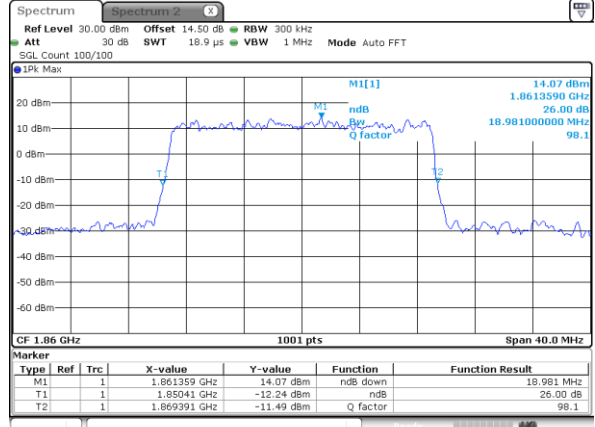

Date: 9,MAR,2020 21:01:39

Middle Channel / 15MHz / 64QAM

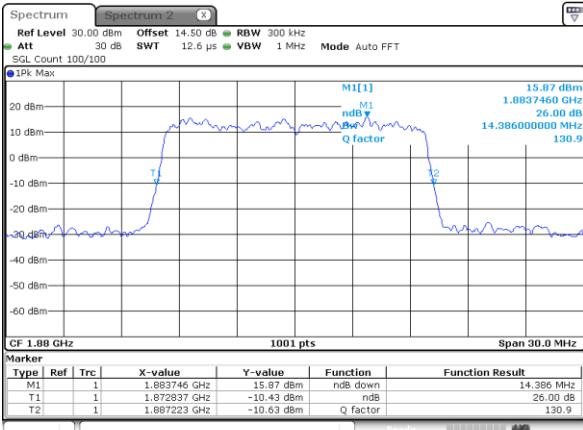

Date: 9,MAR,2020 20:37:10

Middle Channel / 20MHz / 64QAM

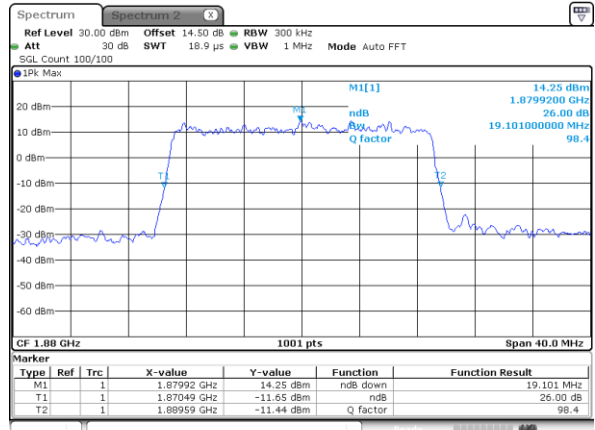

Date: 9,MAR,2020 21:12:54

Highest Channel / 15MHz / 64QAM

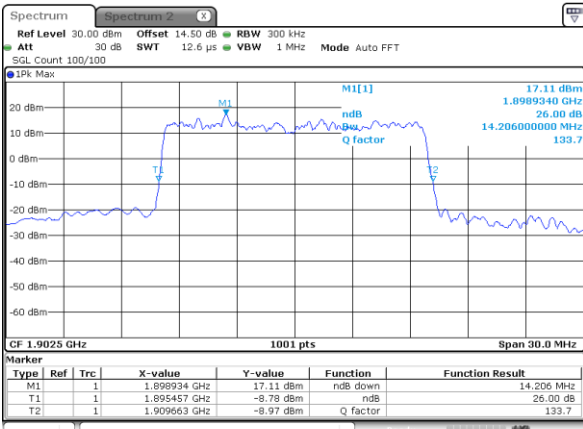

Date: 9,MAR,2020 20:40:49

Highest Channel / 20MHz / 64QAM

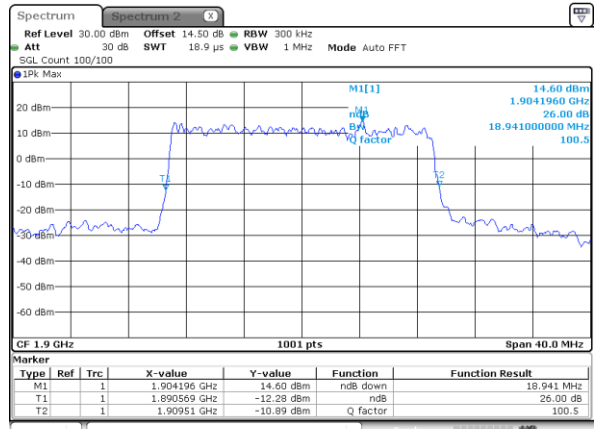

Date: 9,MAR,2020 21:14:02



Occupied Bandwidth

Mode	LTE Band 2 : 99%OBW(MHz)											
BW	1.4MHz		3MHz		5MHz		10MHz		15MHz		20MHz	
Mod.	QPSK	16QAM	QPSK	16QAM	QPSK	16QAM	QPSK	16QAM	QPSK	16QAM	QPSK	16QAM
Lowest CH	1.09	1.08	2.71	2.72	4.49	4.48	9.07	9.01	13.43	13.4	17.82	17.94
Middle CH	1.08	1.08	2.71	2.72	4.49	4.5	8.99	9.03	13.46	13.49	17.86	17.86
Highest CH	1.09	1.09	2.7	2.7	4.5	4.5	9.05	9.05	13.49	13.46	17.9	17.9
Mode	LTE Band 2 : 99%OBW(MHz)											
BW	1.4MHz		3MHz		5MHz		10MHz		15MHz		20MHz	
Mod.	64QAM		64QAM		64QAM		64QAM		64QAM		64QAM	
Lowest CH	1.08	-	2.7	-	4.48	-	9.01	-	13.46	-	17.86	-
Middle CH	1.09	-	2.7	-	4.49	-	9.01	-	13.43	-	17.9	-
Highest CH	1.09	-	2.71	-	4.49	-	9.07	-	13.49	-	17.9	-



LTE Band 2

Lowest Channel / 1.4MHz / QPSK

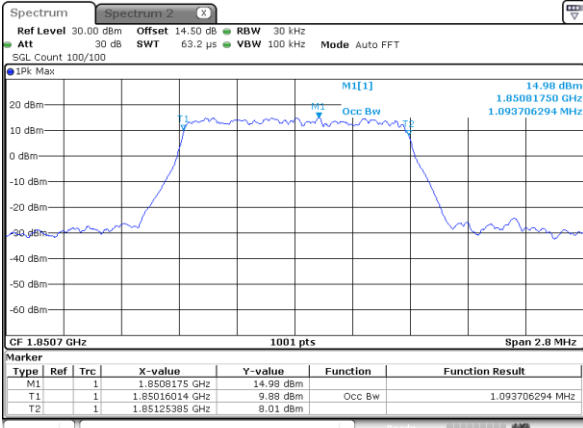

Date: 9_MAR.2020 17:36:12

Lowest Channel / 1.4MHz / 16QAM

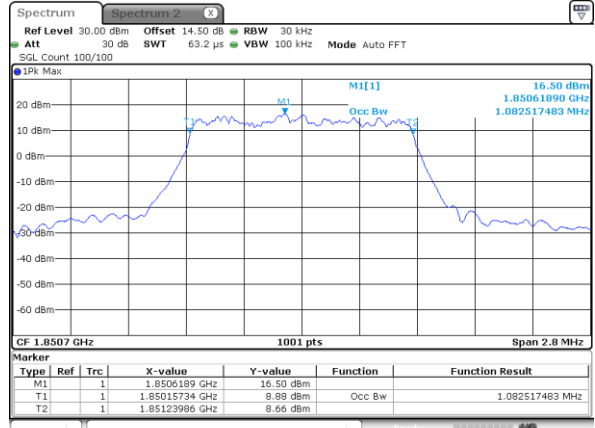

Date: 9_MAR.2020 17:36:28

Middle Channel / 1.4MHz / QPSK

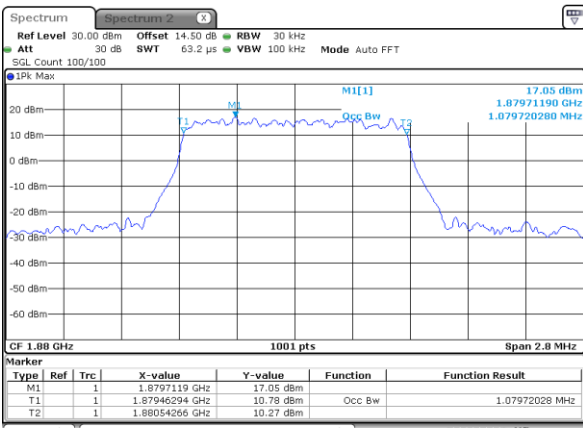

Date: 9_MAR.2020 18:29:11

Middle Channel / 1.4MHz / 16QAM

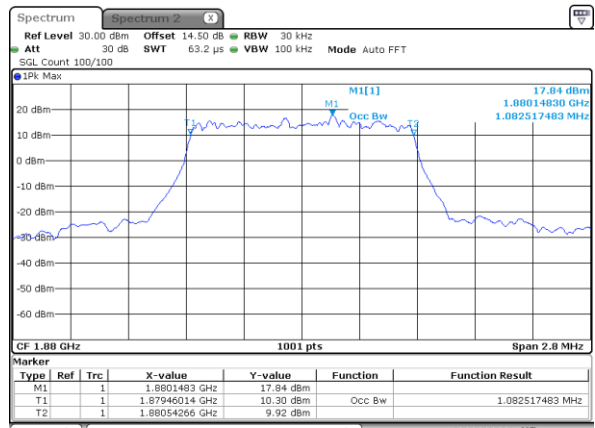

Date: 9_MAR.2020 18:28:41

Highest Channel / 1.4MHz / QPSK

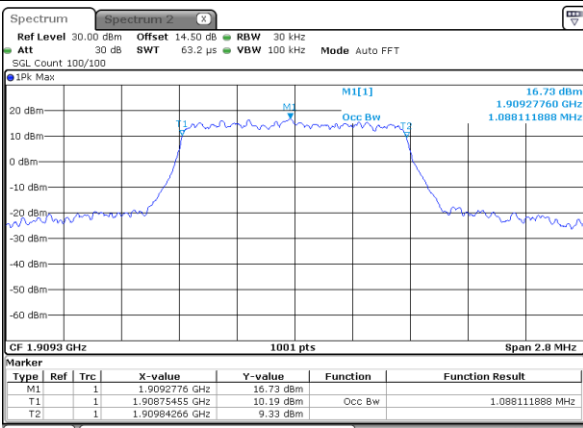

Date: 9_MAR.2020 18:30:05

Highest Channel / 1.4MHz / 16QAM

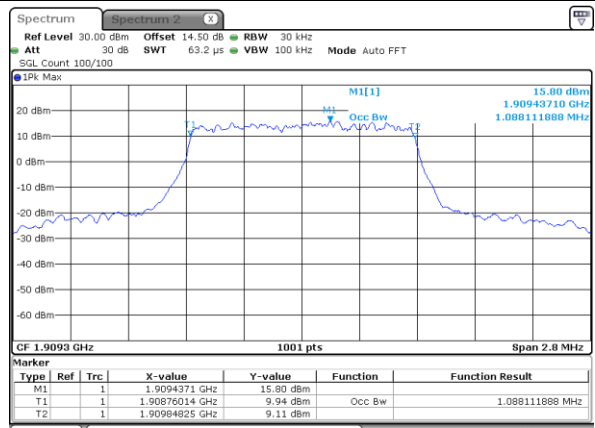

Date: 9_MAR.2020 18:31:54



LTE Band 2

Lowest Channel / 3MHz / QPSK

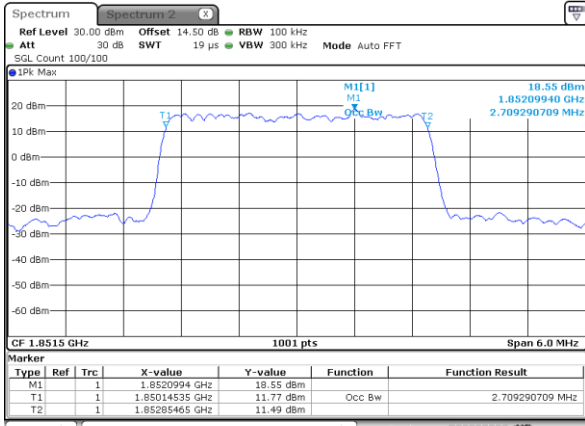

Date: 9_MAR.2020 18:52:03

Lowest Channel / 3MHz / 16QAM

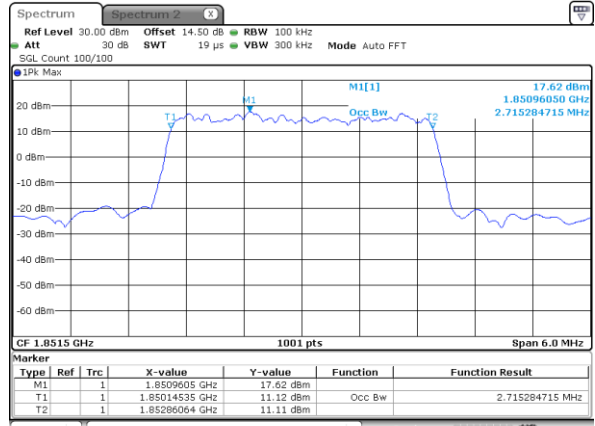

Date: 9_MAR.2020 18:53:05

Middle Channel / 3MHz / QPSK

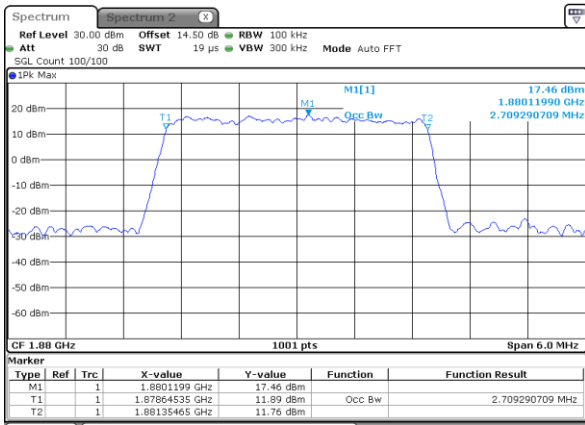

Date: 9_MAR.2020 19:15:48

Middle Channel / 3MHz / 16QAM

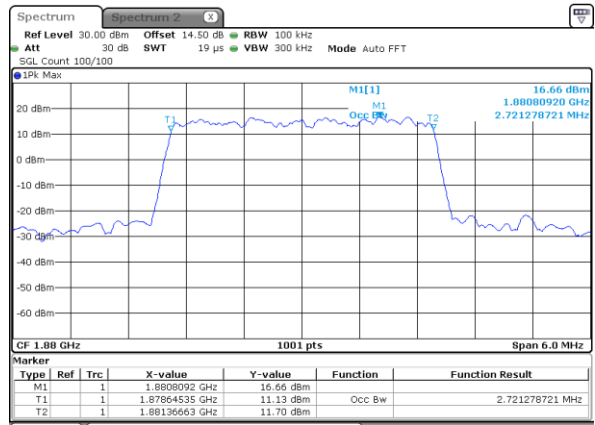

Date: 9_MAR.2020 19:16:13

Highest Channel / 3MHz / QPSK

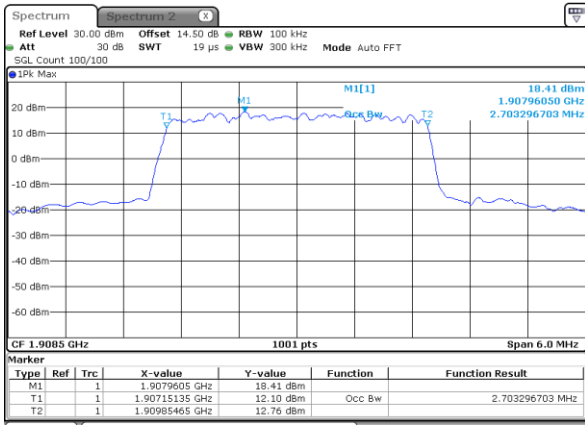

Date: 9_MAR.2020 19:20:53

Highest Channel / 3MHz / 16QAM

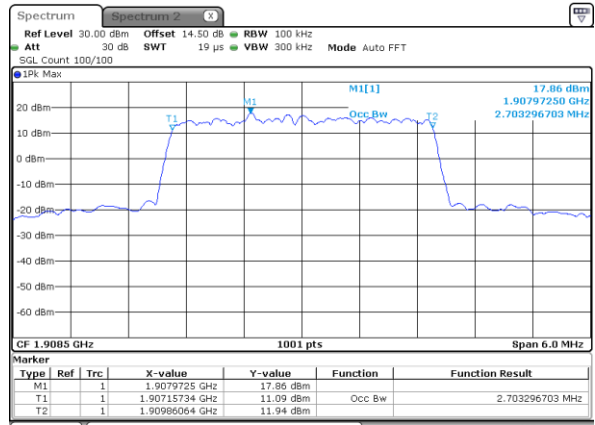

Date: 9_MAR.2020 19:19:42



LTE Band 2

Lowest Channel / 5MHz / QPSK

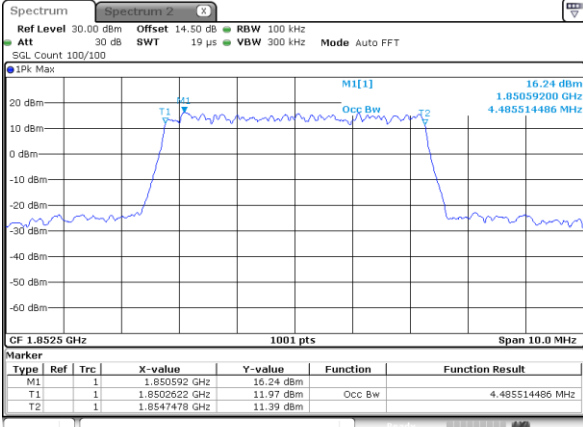

Date: 9,MAR,2020 19:30:54

Lowest Channel / 5MHz / 16QAM

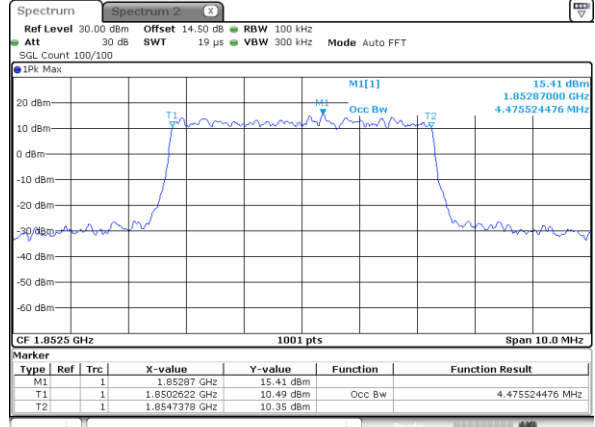

Date: 9,MAR,2020 19:31:37

Middle Channel / 5MHz / QPSK

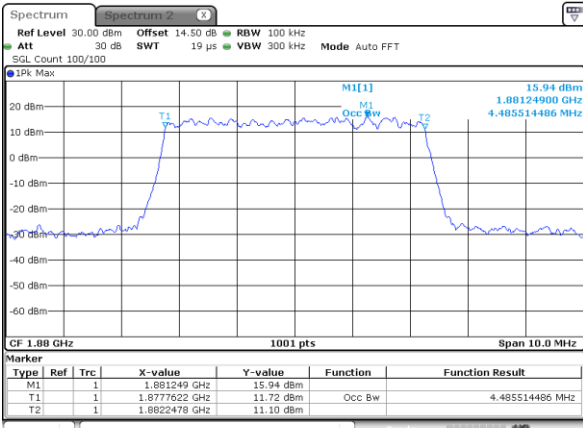

Date: 9,MAR,2020 19:46:25

Middle Channel / 5MHz / 16QAM

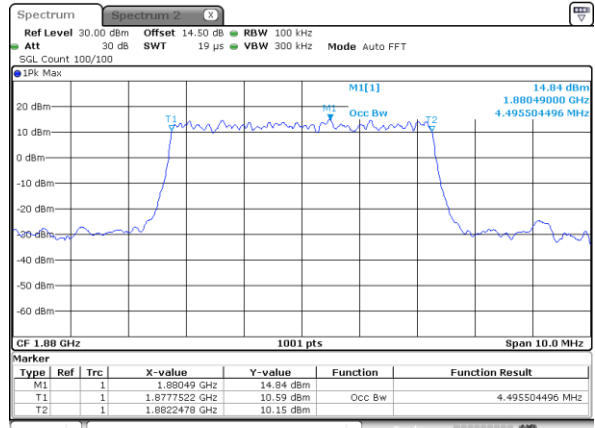

Date: 9,MAR,2020 19:46:05

Highest Channel / 5MHz / QPSK

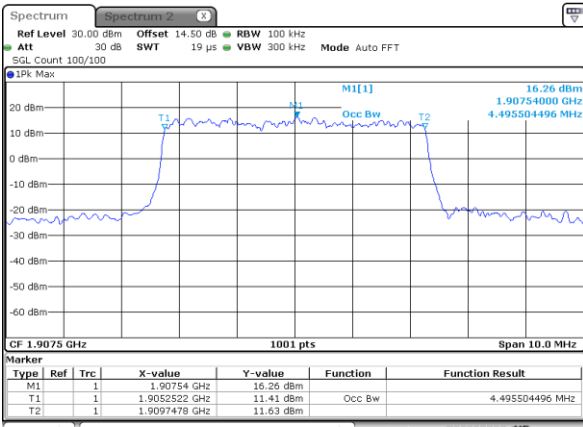

Date: 9,MAR,2020 19:47:00

Highest Channel / 5MHz / 16QAM

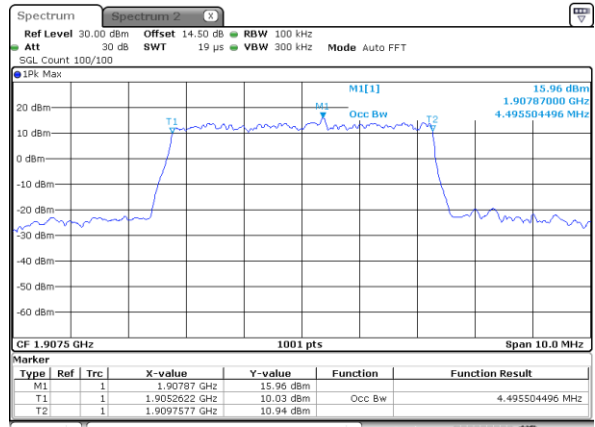

Date: 9,MAR,2020 19:47:46



LTE Band 2

Lowest Channel / 10MHz / QPSK

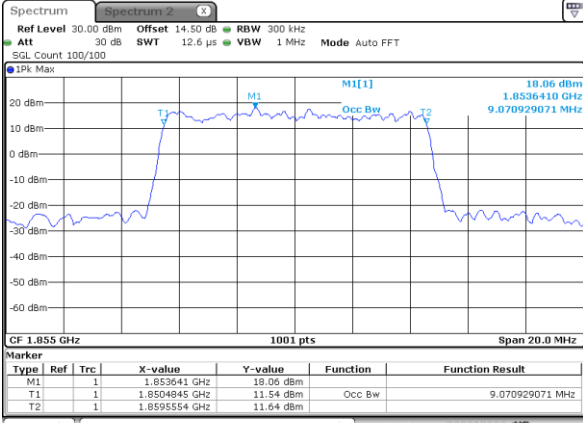

Date: 9,MAR,2020 19:58:47

Lowest Channel / 10MHz / 16QAM

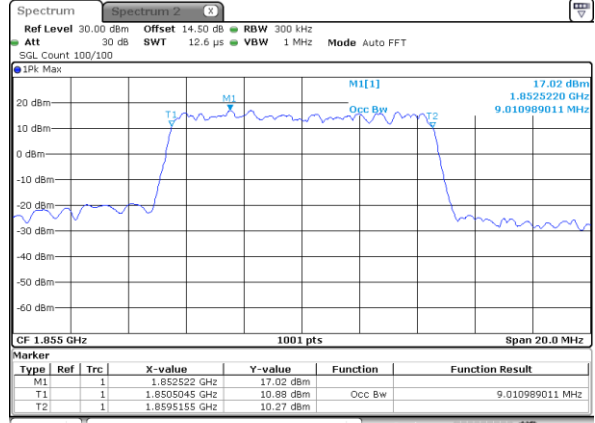

Date: 9,MAR,2020 19:58:10

Middle Channel / 10MHz / QPSK

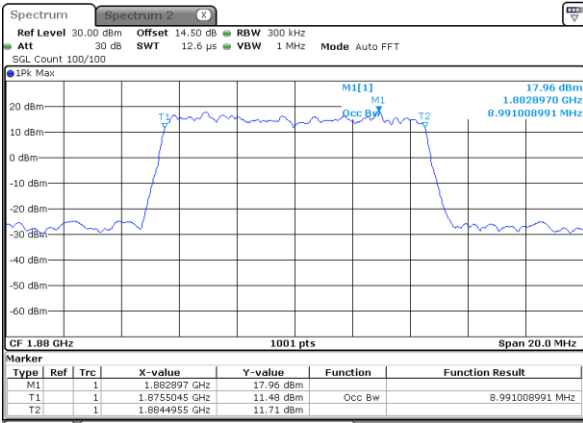

Date: 9,MAR,2020 20:11:49

Middle Channel / 10MHz / 16QAM

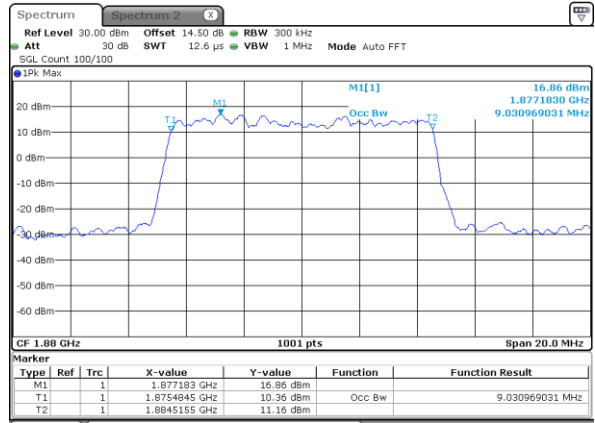

Date: 9,MAR,2020 20:12:19

Highest Channel / 10MHz / QPSK

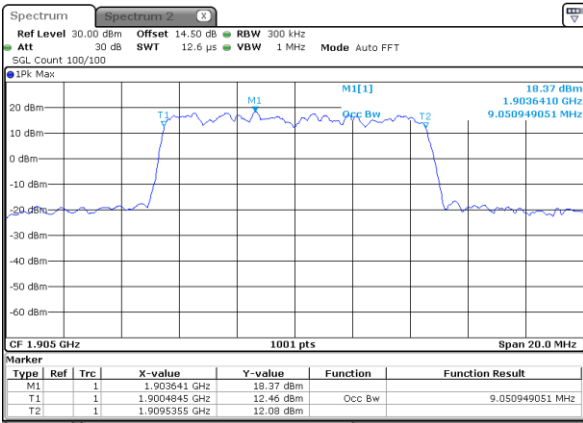

Date: 9,MAR,2020 20:15:27

Highest Channel / 10MHz / 16QAM

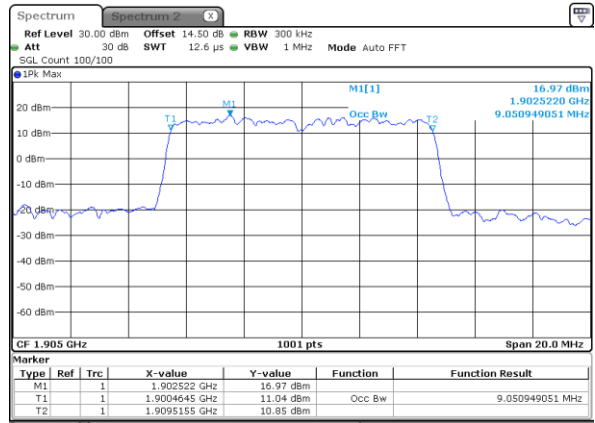

Date: 9,MAR,2020 20:14:50



LTE Band 2

Lowest Channel / 15MHz / QPSK

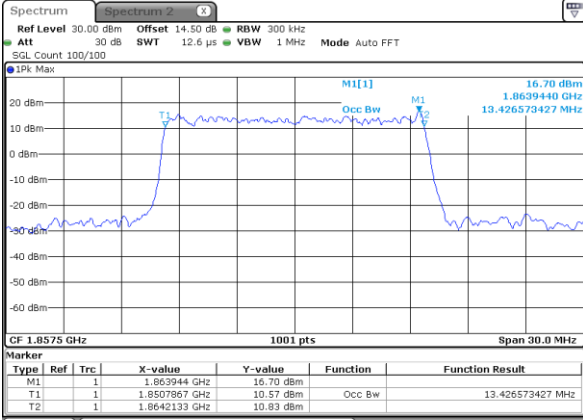

Date: 9,MAR,2020 20:26:16

Lowest Channel / 15MHz / 16QAM

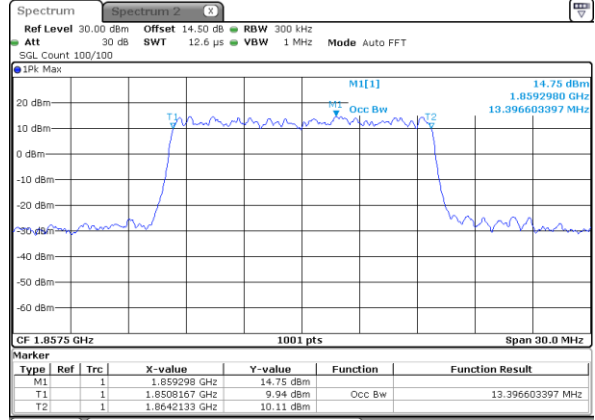

Date: 9,MAR,2020 20:26:53

Middle Channel / 15MHz / QPSK

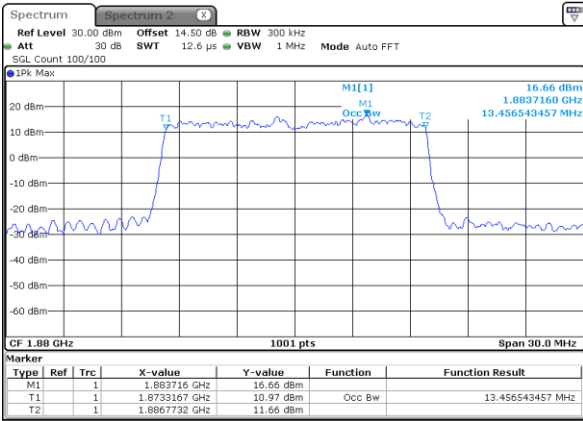

Date: 9,MAR,2020 20:37:28

Middle Channel / 15MHz / 16QAM

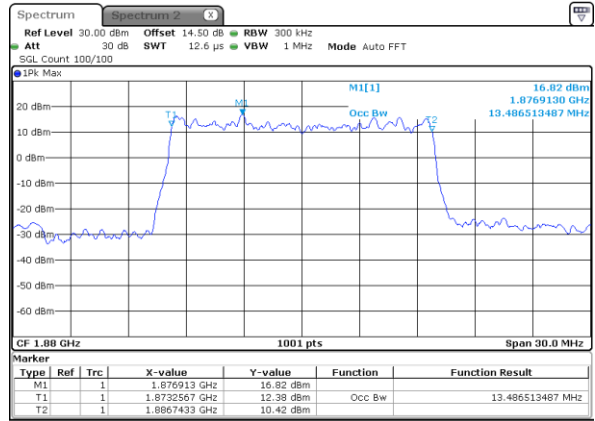

Date: 9,MAR,2020 20:37:51

Highest Channel / 15MHz / QPSK

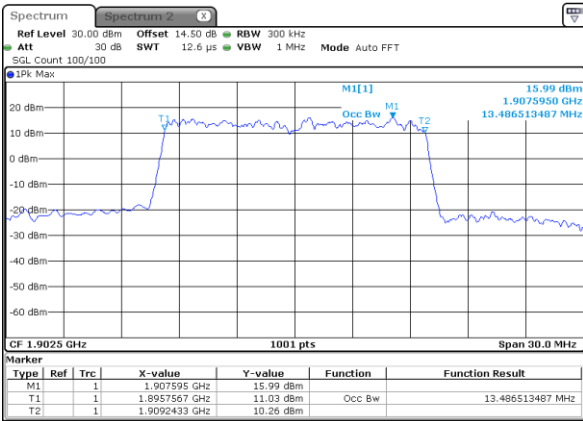

Date: 9,MAR,2020 20:39:51

Highest Channel / 15MHz / 16QAM

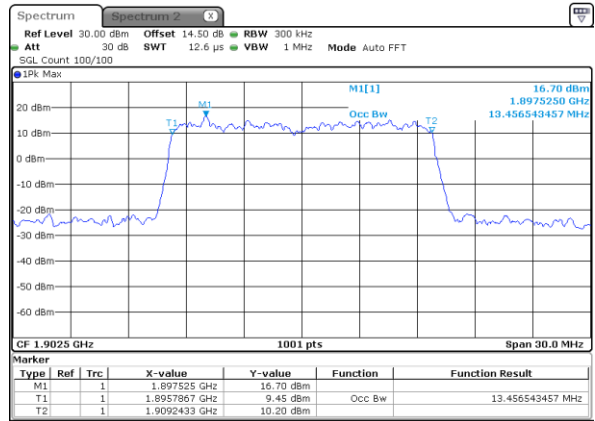

Date: 9,MAR,2020 20:39:15