



SAR TEST REPORT

No. I21Z60772-SEM01

For

Shenzhen Tinno Mobile Technology Corp.

Smart Phone

Model name: U319AA

With

Hardware Version: V1.0

Software Version: U319AAV01.02.10

FCC ID: XD6U319AA

Issued Date: 2021-6-10

Note:

The test results in this test report relate only to the devices specified in this report. This report shall not be reproduced except in full without the written approval of CTTL.

The report must not be used by the client to claim product certification, approval, or endorsement by NVLAP, NIST, or any agency of the U.S. Government.

Test Laboratory:

CTTL, Telecommunication Technology Labs, CAICT

No. 51, Xueyuan Road, Haidian District, Beijing, P. R. China 100191.

Tel:+86(0)10-62304633-2512, Fax:+86(0)10-62304633-2504

Email: ctl_terminals@caict.ac.cn, website: www.caict.ac.cn



No.I21Z60772-SEM01

REPORT HISTORY

Report Number	Revision	Issue Date	Description
I21Z60772-SEM01	Rev.0	2021-6-10	Initial creation of test report

TABLE OF CONTENT

1 TEST LABORATORY	5
1.1 TESTING LOCATION	5
1.2 TESTING ENVIRONMENT.....	5
1.3 PROJECT DATA	5
1.4 SIGNATURE.....	5
2 STATEMENT OF COMPLIANCE	6
3 CLIENT INFORMATION	8
3.1 APPLICANT INFORMATION	8
3.2 MANUFACTURER INFORMATION	8
4 EQUIPMENT UNDER TEST (EUT) AND ANCILLARY EQUIPMENT (AE)	9
4.1 ABOUT EUT	9
4.2 INTERNAL IDENTIFICATION OF EUT USED DURING THE TEST	9
4.3 INTERNAL IDENTIFICATION OF AE USED DURING THE TEST	9
5 TEST METHODOLOGY	10
5.1 APPLICABLE LIMIT REGULATIONS	10
5.2 APPLICABLE MEASUREMENT STANDARDS.....	10
6 SPECIFIC ABSORPTION RATE (SAR)	11
6.1 INTRODUCTION.....	11
6.2 SAR DEFINITION.....	11
7 TISSUE SIMULATING LIQUIDS	12
7.1 TARGETS FOR TISSUE SIMULATING LIQUID	12
7.2 DIELECTRIC PERFORMANCE	12
8 SYSTEM VERIFICATION	17
8.1 SYSTEM SETUP.....	17
8.2 SYSTEM VERIFICATION.....	18
9 MEASUREMENT PROCEDURES	19
9.1 TESTS TO BE PERFORMED	19
9.2 GENERAL MEASUREMENT PROCEDURE.....	21
9.3 WCDMA MEASUREMENT PROCEDURES FOR SAR	22
9.4 SAR MEASUREMENT FOR LTE.....	23
9.5 BLUETOOTH & WI-FI MEASUREMENT PROCEDURES FOR SAR	23
9.6 POWER DRIFT.....	24
10 AREA SCAN BASED 1-G SAR	25
10.1 REQUIREMENT OF KDB.....	25
10.2 FAST SAR ALGORITHMS	25



11 CONDUCTED OUTPUT POWER.....	26
11.1 WCDMA MEASUREMENT RESULT.....	26
11.2 LTE MEASUREMENT RESULT	28
11.3 WI-FI AND BT MEASUREMENT RESULT	50
12 SIMULTANEOUS TX SAR CONSIDERATIONS.....	51
12.1 TRANSMIT ANTENNA SEPARATION DISTANCES	51
12.2 SAR MEASUREMENT POSITIONS	52
12.3 STANDALONE SAR TEST EXCLUSION CONSIDERATIONS	52
13 EVALUATION OF SIMULTANEOUS.....	53
14 SAR TEST RESULT	54
14.1 SAR RESULT.....	55
14.2 SAR RESULTS FOR STANDARD PROCEDURE	65
14.3 WLAN EVALUATION FOR 2.4G	70
14.4 WLAN EVALUATION FOR 5G.....	73
14.5 SAR EVALUATION FOR PHABLET	77
15 SAR MEASUREMENT VARIABILITY.....	78
16 MEASUREMENT UNCERTAINTY	79
16.1 MEASUREMENT UNCERTAINTY FOR NORMAL SAR TESTS (300MHZ~3GHZ)	79
16.2 MEASUREMENT UNCERTAINTY FOR NORMAL SAR TESTS (3~6GHZ)	80
16.3 MEASUREMENT UNCERTAINTY FOR FAST SAR TESTS (300MHZ~3GHZ)	81
16.4 MEASUREMENT UNCERTAINTY FOR FAST SAR TESTS (3~6GHZ).....	82
17 MAIN TEST INSTRUMENTS.....	83
ANNEX A GRAPH RESULTS.....	84
ANNEX B SYSTEM VERIFICATION RESULTS	120
ANNEX C SAR MEASUREMENT SETUP	134
ANNEX D POSITION OF THE WIRELESS DEVICE IN RELATION TO THE PHANTOM	140
ANNEX E EQUIVALENT MEDIA RECIPES.....	143
ANNEX F SYSTEM VALIDATION	144
ANNEX G PROBE CALIBRATION CERTIFICATE.....	145
ANNEX H DIPOLE CALIBRATION CERTIFICATE	154
ANNEX I ACCREDITATION CERTIFICATE.....	225

1 Test Laboratory

1.1 Testing Location

Company Name:	CTTL(Shouxiang)
Address:	No. 51 Shouxiang Science Building, Xueyuan Road, Haidian District, Beijing, P. R. China100191

1.2 Testing Environment

Temperature:	18°C~25°C,
Relative humidity:	30%~ 70%
Ground system resistance:	< 0.5 Ω
Ambient noise & Reflection:	< 0.012 W/kg

1.3 Project Data

Project Leader:	Qi Dianyuan
Test Engineer:	Lin Xiaojun
Testing Start Date:	May 20, 2021
Testing End Date:	June 3, 2021

1.4 Signature



Lin Xiaojun

(Prepared this test report)

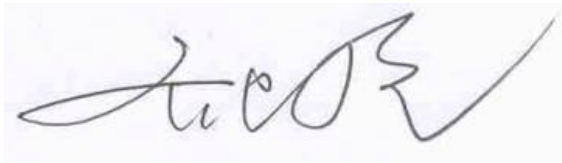

Qi Dianyuan

(Reviewed this test report)

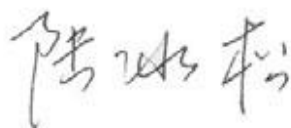

Lu Bingsong

Deputy Director of the laboratory

(Approved this test report)

2 Statement of Compliance

The maximum results of SAR found during testing for Shenzhen Tinno Mobile Technology Corp. Smart Phone U319AA are as follows:

Table 2.1: Highest Reported SAR (1g)

Exposure Configuration	Technology Band	Highest Reported SAR 1g(W/kg)	Equipment Class
Head (Separation Distance 0mm)	UMTS FDD 2	0.37	PCE
	UMTS FDD 4	0.44	
	UMTS FDD 5	0.35	
	LTE Band 2	0.42	
	LTE Band 4	0.33	
	LTE Band 5	0.38	
	LTE Band 12	0.35	
	LTE Band 14	0.28	
	LTE Band 30	0.26	
	WLAN 2.4 GHz	0.63	DTS
	WLAN 5 GHz	0.76	NII
Hotspot (Separation Distance 10mm)	UMTS FDD 2	0.91	PCE
	UMTS FDD 4	1.16	
	UMTS FDD 5	0.65	
	LTE Band 2	1.25	
	LTE Band 4	1.15	
	LTE Band 5	0.69	
	LTE Band 12	0.46	
	LTE Band 14	0.50	
	LTE Band 30	1.08	
	WLAN 2.4 GHz	0.44	DTS
	WLAN 5 GHz	0.44	NII
Body-worn (Separation Distance 15mm)	UMTS FDD 2	1.10	PCE
	UMTS FDD 4	0.48	
	LTE Band 2	0.87	
	LTE Band 4	0.52	
	LTE Band 30	1.31	

The SAR values found for the Mobile Phone are below the maximum recommended levels of 1.6 W/kg as averaged over any 1g tissue according to the ANSI C95.1-1992.

For body operation, this device has been tested and meets FCC RF exposure guidelines when used with any accessory that contains no metal and which provides a minimum separation distance of 10 mm for hotspot and 15mm for body worn between this device and the body of the user. Use of other accessories may not ensure compliance with FCC RF exposure guidelines.

The EUT battery must be fully charged and checked periodically during the test to ascertain uniform power output.

The measurement together with the test system set-up is described in annex C of this test report. A detailed description of the equipment under test can be found in chapter 4 of this test report. The highest reported SAR value is obtained at the case of **(Table 2.1)**, and the values are: **1.31 W/kg(1g)**.

Table 2.2: The sum of reported SAR values for main antenna and WiFi2.4G

	Position	Main antenna	WiFi	Sum
Highest reported SAR value for Head	Left hand, Cheek	0.38	0.61	0.99
Highest reported SAR value for Body	Rear 10mm	1.11	0.44	1.55
	Rear 15mm	1.31	0.19	1.50

Table 2.3: The sum of reported SAR values for main antenna and WiFi5G

	Position	Main antenna	WiFi	Sum
Highest reported SAR value for Head	Left hand, Tilt	0.27	0.76	1.03
Highest reported SAR value for Body	Rear 10mm	1.11	0.40	1.51
	Rear 15mm	1.31	0.21	1.52

Table 2.4: The sum of reported SAR values for main antenna + WiFi5G+BT

	Position	Main antenna	WiFi	BT	Sum
Highest reported SAR value for Head	Left hand, Tilt	0.27	0.76	0.17 ^[1]	1.03
Highest reported SAR value for Body	Rear 10mm	1.11	0.40	0.08 ^[1]	1.59
	Rear 15mm	1.31	0.21	0.06 ^[1]	1.58

[1] - Estimated SAR for Bluetooth (see the table 13.3)

According to the above tables, the highest sum of reported SAR values is **1.59 W/kg (1g)**. The detail for simultaneous transmission consideration is described in chapter 13.



3 Client Information

3.1 Applicant Information

Company Name:	Shenzhen Tinno Mobile Technology Corp.
Address/Post:	4/F, H-3 Building,OCT Eastern Industrial Park. NO.1 XiangShan East Road, Nan Shan District,Shenzhen, P.R.China
Contact Person:	xiaoping.li
Contact Email:	xiaoping.li@tinno.com
Telephone:	0755-86095550
Fax	NA

3.2 Manufacturer Information

Company Name:	Shenzhen Tinno Mobile Technology Corp.
Address/Post:	4/F, H-3 Building,OCT Eastern Industrial Park. NO.1 XiangShan East Road, Nan Shan District,Shenzhen, P.R.China
Contact Person:	xiaoping.li
Contact Email:	xiaoping.li@tinno.com
Telephone:	0755-86095550
Fax	NA

4 Equipment Under Test (EUT) and Ancillary Equipment (AE)

4.1 About EUT

Description:	Smart Phone
Model name:	U319AA
Operating mode(s):	UMTS FDD 2/4/5, BT, Wi-Fi(2.4G&5G), LTE Band 2/4/5/12/14/30
Tested Tx Frequency:	824–849 MHz (WCDMA 850 Band V)
	1710 – 1755 MHz (WCDMA 1700 Band IV)
	1850–1910 MHz (WCDMA1900 Band II)
	1850 – 1910 MHz (LTE Band 2)
	1710 – 1755 MHz (LTE Band 4)
	824 – 849 MHz (LTE Band 5)
	699 – 716 MHz (LTE Band 12)
	788 – 798 MHz (LTE Band 14)
	2305 – 2315 MHz(LTE Band 30)
2412 – 2462 MHz (Wi-Fi 2.4G)	
5150-5825 MHz (Wi-Fi 5G)	
Test device Production information:	Production unit
Device type:	Portable device
Antenna type:	Integrated antenna
Hotspot mode:	Support

4.2 Internal Identification of EUT used during the test

EUT ID*	IMEI	HW	SW Version
EUT1	864535050003433	V1.0	U319AAV01.02.10
EUT2	864535050003417	V1.0	U319AAV01.02.10
EUT3	860999050015272	V1.0	U319AAV01.02.10
EUT4	864535050003391	V1.0	U319AAV01.02.10

*EUT ID: is used to identify the test sample in the lab internally.

Note: It is performed to test SAR with the EUT1~3 and conducted power with the EUT4.

4.3 Internal Identification of AE used during the test

AE ID*	Description	Model	SN	Manufacturer
AE1	Battery	LT25H426271W	/	Ningbo Veken Battery Company Limited

*AE ID: is used to identify the test sample in the lab internally.

5 TEST METHODOLOGY

5.1 Applicable Limit Regulations

ANSI C95.1–1992: IEEE Standard for Safety Levels with Respect to Human Exposure to Radio Frequency Electromagnetic Fields, 3 kHz to 300 GHz.

It specifies the maximum exposure limit of **1.6 W/kg** as averaged over any 1 gram of tissue for portable devices being used within 20 cm of the user in the uncontrolled environment.

5.2 Applicable Measurement Standards

IEEE 1528–2013: Recommended Practice for Determining the Peak Spatial-Average Specific Absorption Rate (SAR) in the Human Head from Wireless Communications Devices: Measurement Techniques.

KDB447498 D01: General RF Exposure Guidance v06: Mobile and Portable Devices RF Exposure Procedures and Equipment Authorization Policies.

KDB648474 D04 Handset SAR v01r03: SAR Evaluation Considerations for Wireless Handsets.

KDB941225 D01 SAR test for 3G devices v03r01: SAR Measurement Procedures for 3G Devices

KDB941225 D05 SAR for LTE Devices v02r05: SAR Evaluation Considerations for LTE Devices

KDB941225 D06 Hotspot Mode SAR v02r01: SAR Evaluation Procedures for Portable Devices with Wireless Router Capabilities

KDB248227 D01 802.11 Wi-Fi SAR v02r02: SAR GUIDANCE FOR IEEE 802.11 (Wi-Fi) TRANSMITTERS

KDB865664 D01 SAR measurement 100 MHz to 6 GHz v01r04: SAR Measurement Requirements for 100 MHz to 6 GHz.

KDB865664 D02 RF Exposure Reporting v01r02: RF Exposure Compliance Reporting and Documentation Considerations

6 Specific Absorption Rate (SAR)

6.1 Introduction

SAR is related to the rate at which energy is absorbed per unit mass in an object exposed to a radio field. The SAR distribution in a biological body is complicated and is usually carried out by experimental techniques or numerical modeling. The standard recommends limits for two tiers of groups, occupational/controlled and general population/uncontrolled, based on a person's awareness and ability to exercise control over his or her exposure. In general, occupational/controlled exposure limits are higher than the limits for general population/uncontrolled.

6.2 SAR Definition

The SAR definition is the time derivative (rate) of the incremental energy (dW) absorbed by (dissipated in) an incremental mass (dm) contained in a volume element (dv) of a given density (ρ). The equation description is as below:

$$SAR = \frac{d}{dt} \left(\frac{dW}{dm} \right) = \frac{d}{dt} \left(\frac{dW}{\rho dv} \right)$$

SAR is expressed in units of Watts per kilogram (W/kg)

SAR measurement can be either related to the temperature elevation in tissue by

$$SAR = c \left(\frac{\delta T}{\delta t} \right)$$

Where: C is the specific heat capacity, δT is the temperature rise and δt is the exposure duration, or related to the electrical field in the tissue by

$$SAR = \frac{\sigma |E|^2}{\rho}$$

Where: σ is the conductivity of the tissue, ρ is the mass density of tissue and E is the RMS electrical field strength.

However for evaluating SAR of low power transmitter, electrical field measurement is typically applied.

7 Tissue Simulating Liquids

7.1 Targets for tissue simulating liquid

Table 7.1: Targets for tissue simulating liquid

Frequency(MHz)	Liquid Type	Conductivity(σ)	$\pm 10\%$ Range	Permittivity(ϵ)	$\pm 10\%$ Range
750	Head	0.89	0.80~0.98	41.94	37.75~46.13
835	Head	0.90	0.81~0.99	41.5	37.35~45.65
1750	Head	1.37	1.23~1.51	40.08	36.07~44.09
1900	Head	1.40	1.26~1.54	40.0	36~44
2300	Head	1.67	1.50~1.84	39.47	37.5~41.4
2450	Head	1.80	1.62~1.98	39.2	35.28~43.12

Table 7.2: Targets for tissue simulating liquid

Frequency(MHz)	Liquid Type	Conductivity(σ)	$\pm 5\%$ Range	Permittivity(ϵ)	$\pm 5\%$ Range
5250	Head	4.71	4.47~4.95	35.93	34.13~37.73
5600	Head	5.07	4.82~5.32	35.53	33.8~37.3
5750	Head	5.22	4.96~5.48	35.36	33.59~37.13

7.2 Dielectric Performance

Table 7.2: Dielectric Performance of Tissue Simulating Liquid

Measurement Date (yyyy-mm-dd)	Type	Frequency	Permittivity ϵ	Drift (%)	Conductivity σ (S/m)	Drift (%)
2021/5/21	Head	750 MHz	43.89	4.65	0.831	-6.63
2021/5/21	Head	750 MHz	44.99	7.27	0.815	-8.43
2021/5/20	Head	835 MHz	44.646	7.58	0.852	-5.33
2021/5/22	Head	1750 MHz	42.02	4.84	1.377	0.51
2021/5/22	Head	1900 MHz	42.03	5.08	1.443	3.07
2021/5/23	Head	2300 MHz	41.07	4.05	1.805	8.08
2021/5/28	Head	2300 MHz	39.42	-0.13	1.769	5.93
2021/5/26	Head	2450 MHz	40.74	3.93	1.921	6.72
2021/6/3	Head	5250 MHz	34.78	-3.20	4.765	1.17
2021/6/3	Head	5600 MHz	34.09	-4.05	5.149	1.56
2021/6/3	Head	5750 MHz	33.8	-4.41	5.321	1.93

Note: The liquid temperature is 22.0°C

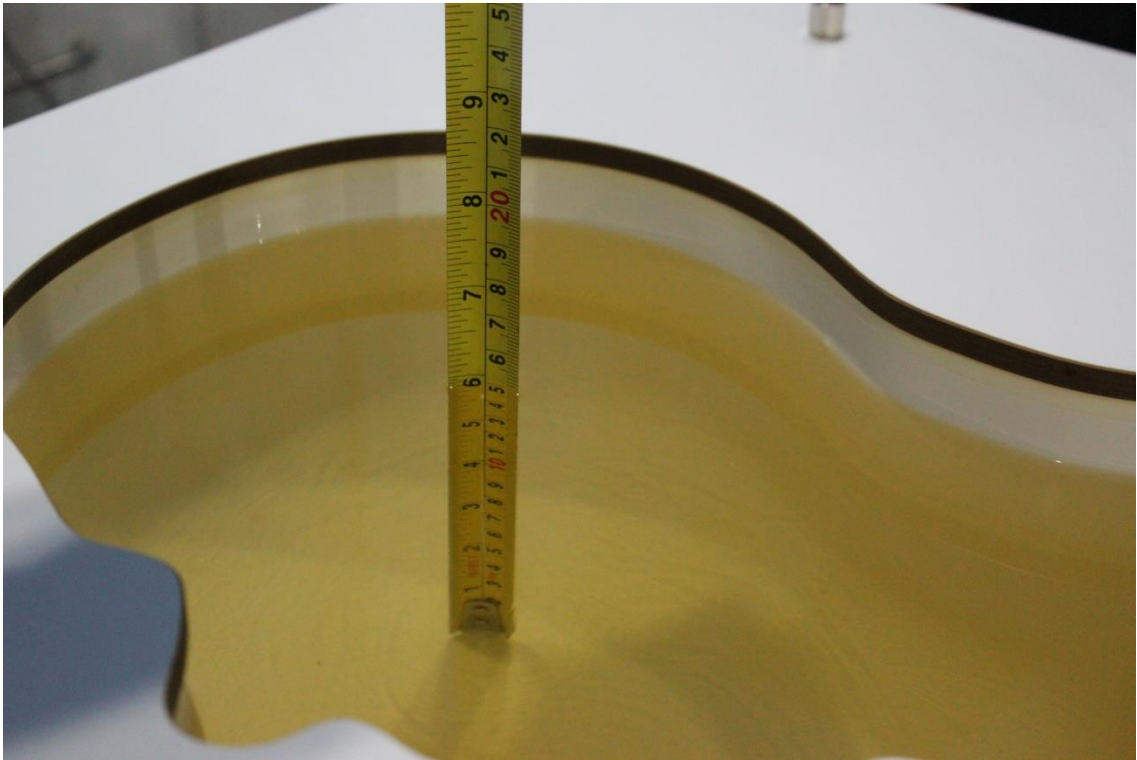

Picture 7-1 Liquid depth in the Head Phantom (750MHz)

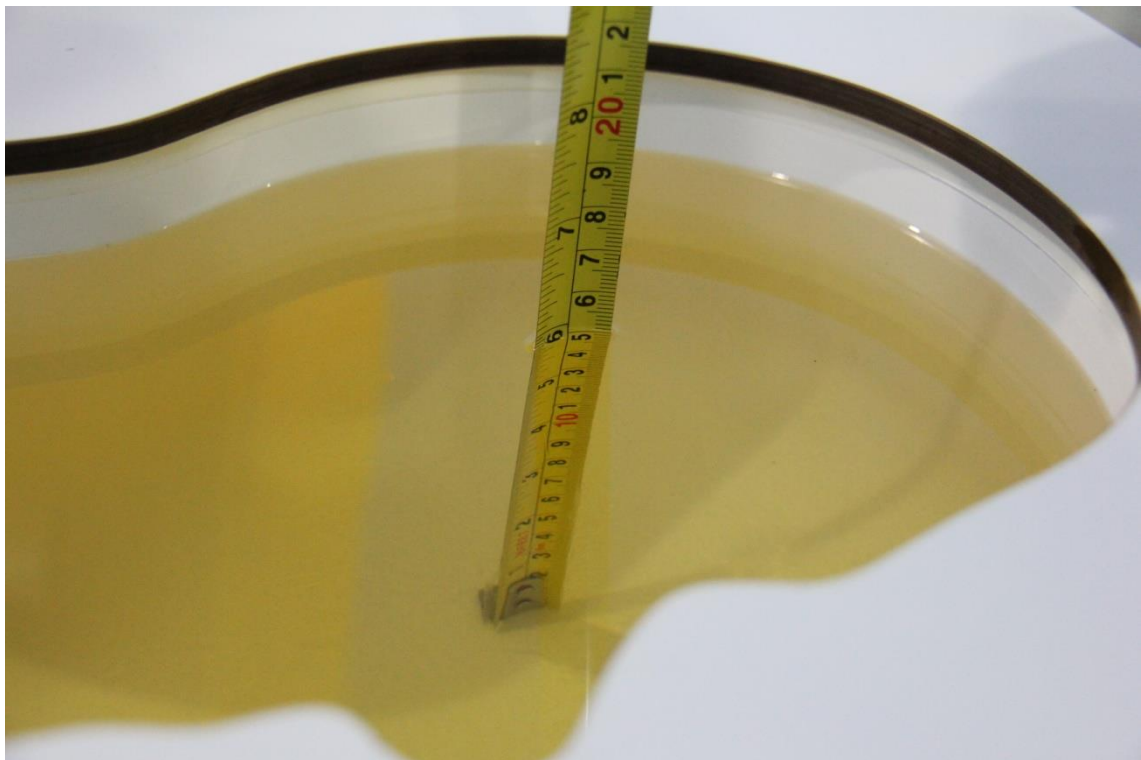

Picture 7-2 Liquid depth in the Head Phantom (835 MHz)

0



Picture 7-3 Liquid depth in the Head Phantom (1750 MHz)

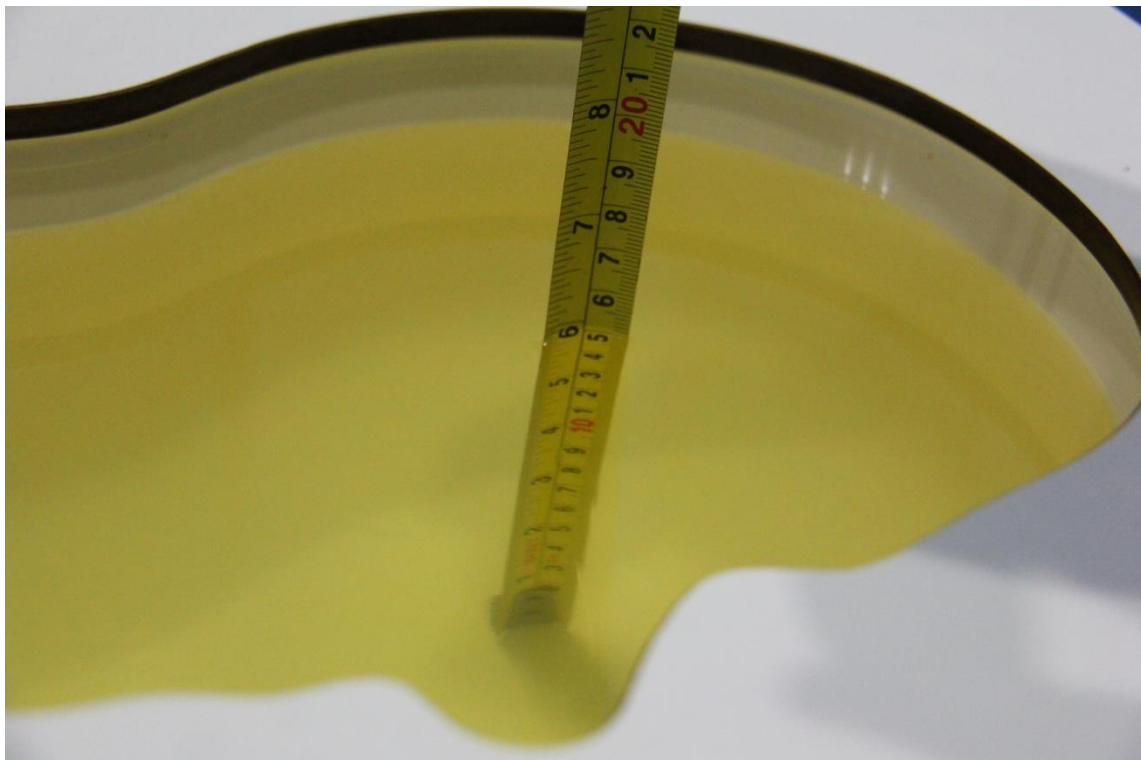

Picture 7-4 Liquid depth in the Head Phantom (1900 MHz)

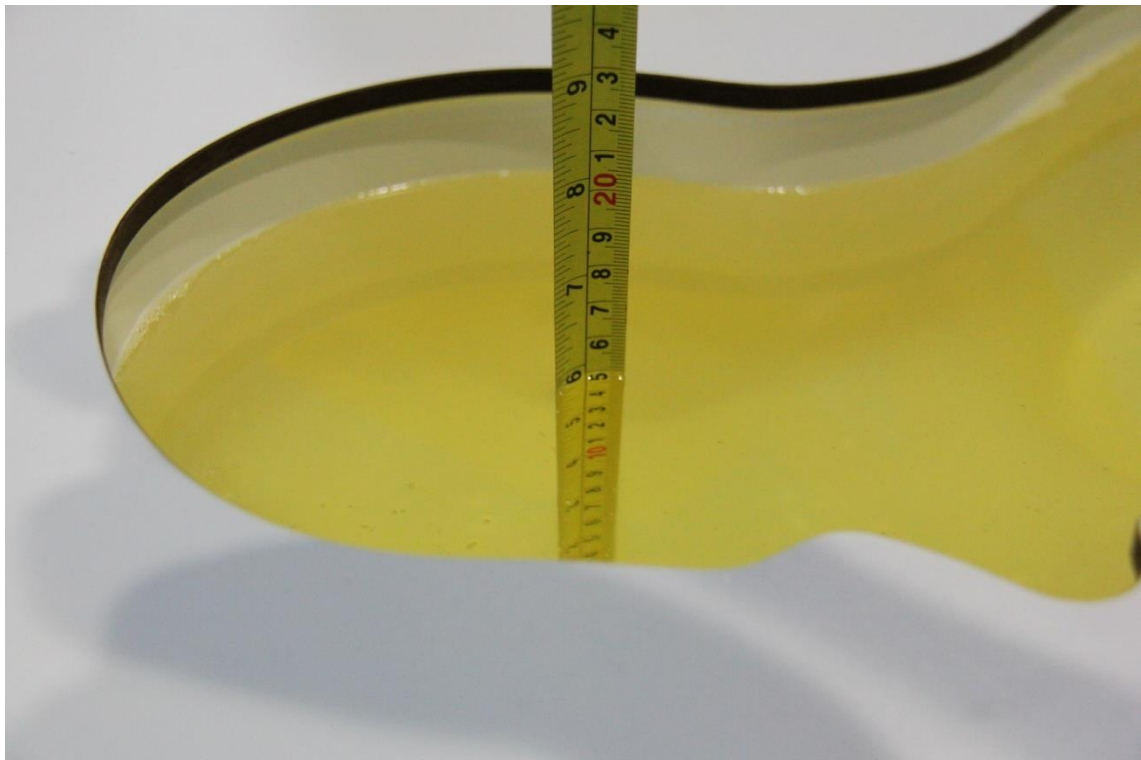

Picture 7-5 Liquid depth in the Head Phantom (2450MHz)

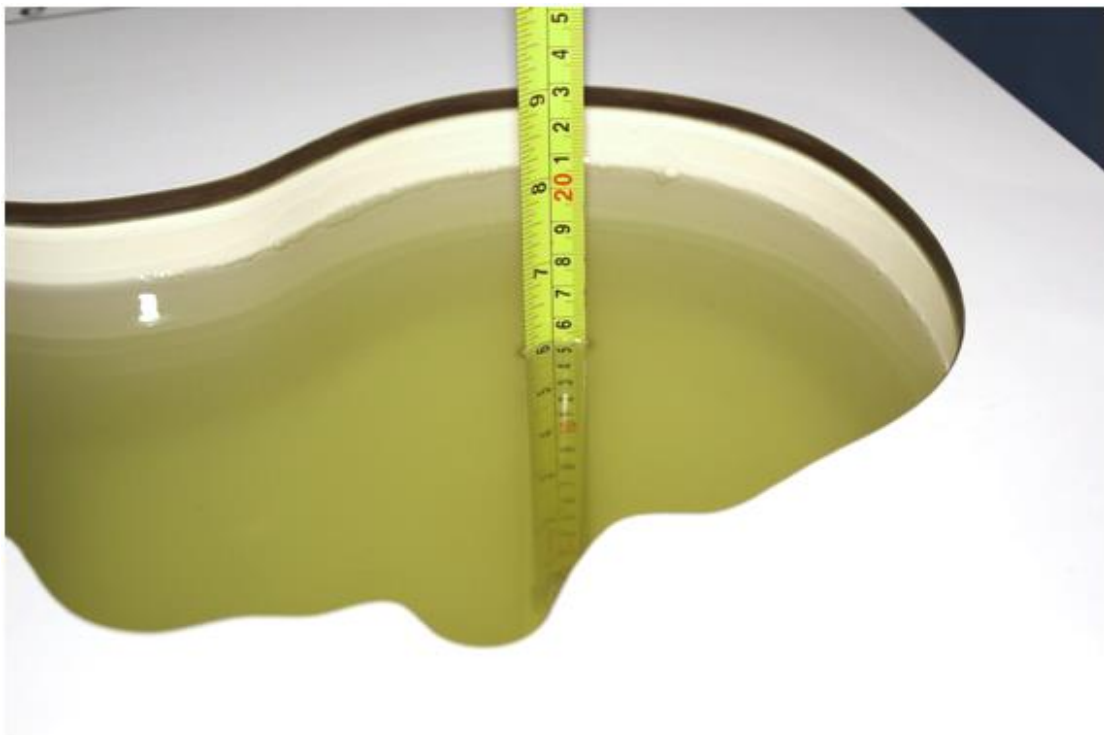

Picture 7-6 Liquid depth in the Head Phantom (2600 MHz)

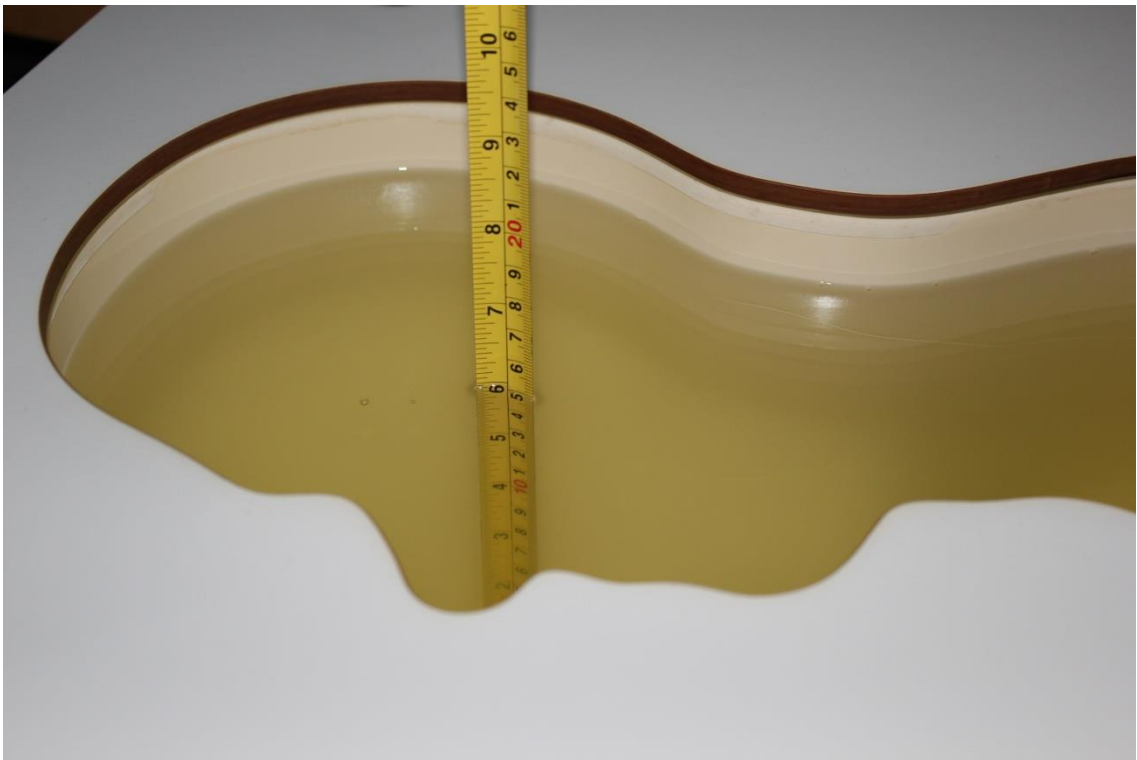

Picture 7-7 Liquid depth in the Head Phantom (2300 MHz)

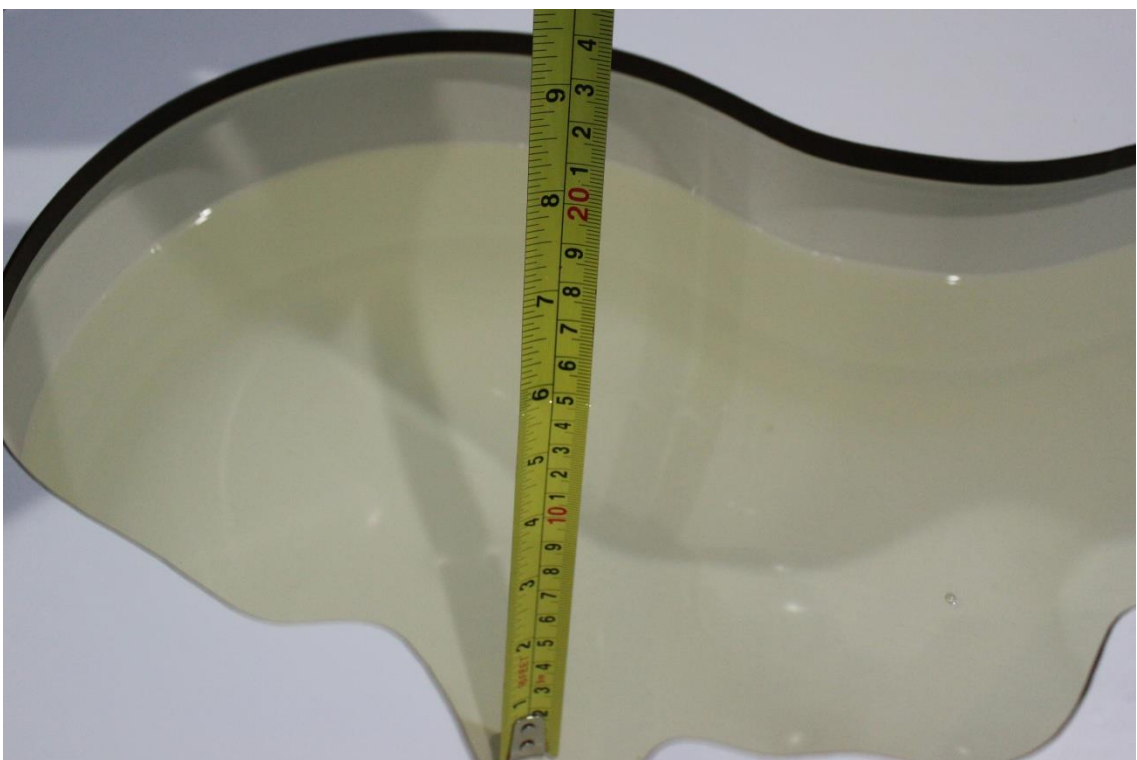

Picture 7-8 Liquid depth in the Head Phantom (5GHz)

8 System verification

8.1 System Setup

In the simplified setup for system evaluation, the DUT is replaced by a calibrated dipole and the power source is replaced by a continuous wave that comes from a signal generator. The calibrated dipole must be placed beneath the flat phantom section of the SAM twin phantom with the correct distance holder. The distance holder should touch the phantom surface with a light pressure at the reference marking and be oriented parallel to the long side of the phantom. The equipment setup is shown below:

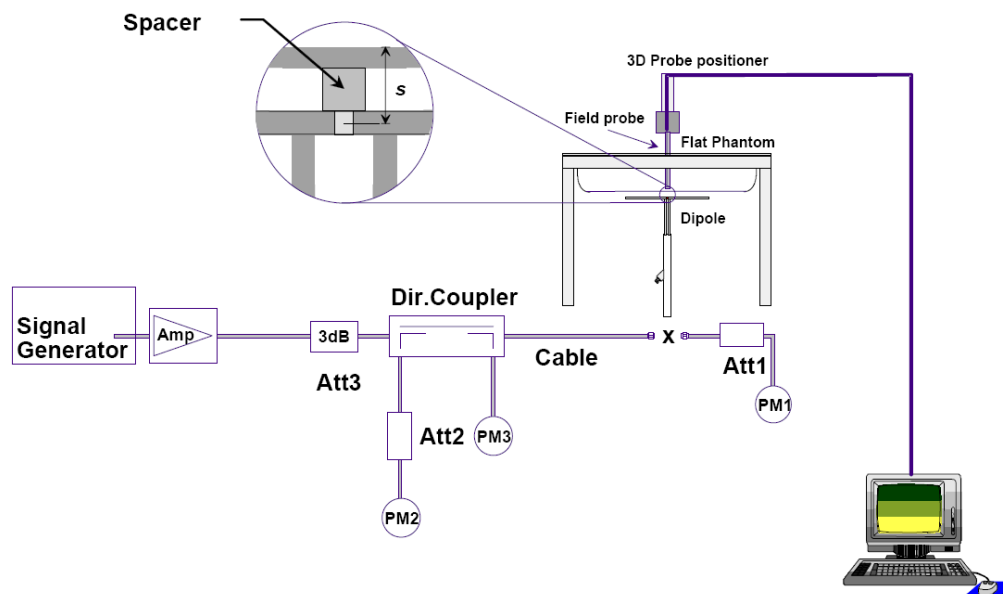

Picture 8.1 System Setup for System Evaluation



Picture 8.2 Photo of Dipole Setup

8.2 System Verification

SAR system verification is required to confirm measurement accuracy, according to the tissue dielectric media, probe calibration points and other system operating parameters required for measuring the SAR of a test device. The system verification must be performed for each frequency band and within the valid range of each probe calibration point required for testing the device.

The system verification results are required that the area scan estimated 1-g SAR is within 3% of the zoom scan 1-g SAR. The details are presented in annex B.

Table 8.1: System Verification of Head

Measurement Date (yyyy-mm-dd)	Frequency	Target value (W/kg)		Measured value(W/kg)		Deviation	
		10 g Average	1 g Average	10 g Average	1 g Average	10 g Average	1 g Average
2021/5/21	750 MHz	5.53	8.47	5.72	8.60	3.44%	1.53%
2021/5/21	750 MHz	5.53	8.47	5.36	8.08	-3.07%	-4.60%
2021/5/20	835 MHz	6.25	9.60	6.08	9.24	-2.72%	-3.75%
2021/5/22	1750 MHz	19.1	36.5	20.2	38.4	5.97%	5.21%
2021/5/23	1750 MHz	19.1	36.5	20.6	38.9	7.64%	6.63%
2021/5/22	1900 MHz	20.6	39.6	19.6	38.1	-5.05%	-3.84%
2021/5/23	1900 MHz	20.6	39.6	21.5	41.6	4.27%	5.05%
2021/5/23	2300 MHz	23.8	49.7	23.0	48.8	-3.53%	-1.81%
2021/5/28	2300 MHz	23.8	49.7	23.2	49.2	-2.52%	-1.01%
2021/5/26	2450 MHz	24.5	52.5	24.3	53.6	-0.73%	2.10%
2021/6/3	5250 MHz	22.9	80.5	22.5	80.4	-1.75%	-0.12%
2021/6/3	5600 MHz	23.6	83.3	24.0	85.8	1.69%	3.00%
2021/6/3	5750 MHz	22.7	80.4	22.7	81.0	0.00%	0.75%

9 Measurement Procedures

9.1 Tests to be performed

In order to determine the highest value of the peak spatial-average SAR of a handset, all device positions, configurations and operational modes shall be tested for each frequency band according to steps 1 to 3 below. A flowchart of the test process is shown in picture 9.1.

Step 1: The tests described in 9.2 shall be performed at the channel that is closest to the centre of the transmit frequency band (f_c) for:

- a) all device positions (cheek and tilt, for both left and right sides of the SAM phantom, as described in annex D),
- b) all configurations for each device position in a), e.g., antenna extended and retracted, and
- c) all operational modes, e.g., analogue and digital, for each device position in a) and configuration in b) in each frequency band.

If more than three frequencies need to be tested according to 11.1 (i.e., $N_c > 3$), then all frequencies, configurations and modes shall be tested for all of the above test conditions.

Step 2: For the condition providing highest peak spatial-average SAR determined in Step 1, perform all tests described in 9.2 at all other test frequencies, i.e., lowest and highest frequencies. In addition, for all other conditions (device position, configuration and operational mode) where the peak spatial-average SAR value determined in Step 1 is within 3 dB of the applicable SAR limit, it is recommended that all other test frequencies shall be tested as well.

Step 3: Examine all data to determine the highest value of the peak spatial-average SAR found in Steps 1 to 2.

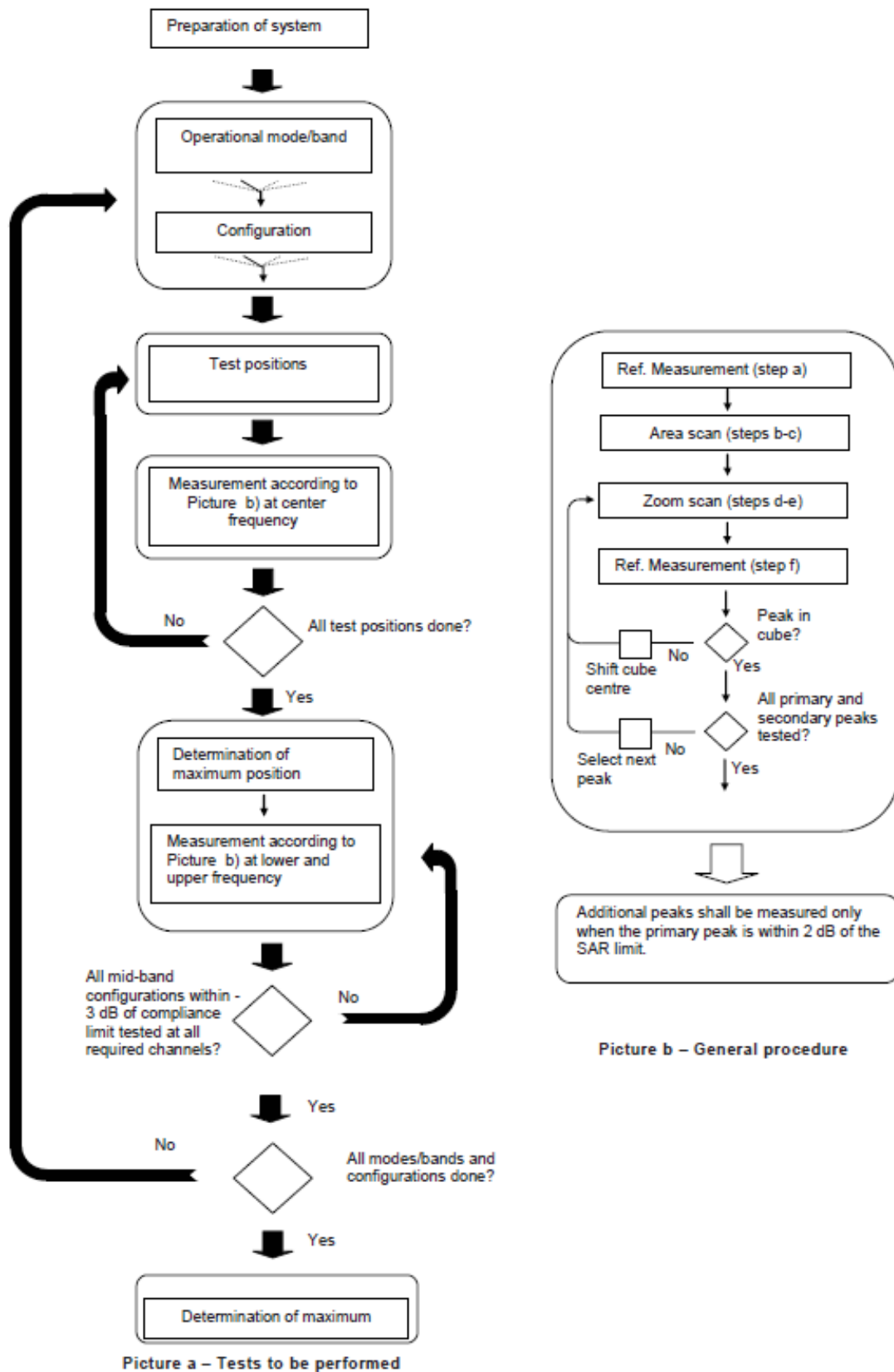

Picture 9.1 Block diagram of the tests to be performed

9.2 General Measurement Procedure

The area and zoom scan resolutions specified in the table below must be applied to the SAR measurements and fully documented in SAR reports to qualify for TCB approval. Probe boundary effect error compensation is required for measurements with the probe tip closer than half a probe tip diameter to the phantom surface. Both the probe tip diameter and sensor offset distance must satisfy measurement protocols; to ensure probe boundary effect errors are minimized and the higher fields closest to the phantom surface can be correctly measured and extrapolated to the phantom surface for computing 1-g SAR. Tolerances of the post-processing algorithms must be verified by the test laboratory for the scan resolutions used in the SAR measurements, according to the reference distribution functions specified in IEEE Std 1528-2013. The results should be documented as part of the system validation records and may be requested to support test results when all the measurement parameters in the following table are not satisfied.

		≤ 3 GHz	> 3 GHz	
Maximum distance from closest measurement point (geometric center of probe sensors) to phantom surface		5 ± 1 mm	$\frac{1}{2} \cdot \delta \cdot \ln(2) \pm 0.5$ mm	
Maximum probe angle from probe axis to phantom surface normal at the measurement location		$30^\circ \pm 1^\circ$	$20^\circ \pm 1^\circ$	
Maximum area scan spatial resolution: Δx_{Area} , Δy_{Area}		≤ 2 GHz: ≤ 15 mm 2 – 3 GHz: ≤ 12 mm	3 – 4 GHz: ≤ 12 mm 4 – 6 GHz: ≤ 10 mm	
		When the x or y dimension of the test device, in the measurement plane orientation, is smaller than the above, the measurement resolution must be \leq the corresponding x or y dimension of the test device with at least one measurement point on the test device.		
Maximum zoom scan spatial resolution: Δx_{Zoom} , Δy_{Zoom}		≤ 2 GHz: ≤ 8 mm 2 – 3 GHz: ≤ 5 mm*	3 – 4 GHz: ≤ 5 mm* 4 – 6 GHz: ≤ 4 mm*	
Maximum zoom scan spatial resolution, normal to phantom surface	uniform grid: $\Delta z_{Zoom}(n)$	≤ 5 mm	3 – 4 GHz: ≤ 4 mm 4 – 5 GHz: ≤ 3 mm 5 – 6 GHz: ≤ 2 mm	
	graded grid	$\Delta z_{Zoom}(1)$: between 1 st two points closest to phantom surface	≤ 4 mm	3 – 4 GHz: ≤ 3 mm 4 – 5 GHz: ≤ 2.5 mm 5 – 6 GHz: ≤ 2 mm
		$\Delta z_{Zoom}(n>1)$: between subsequent points	$\leq 1.5 \cdot \Delta z_{Zoom}(n-1)$	
Minimum zoom scan volume	x, y, z	≥ 30 mm	3 – 4 GHz: ≥ 28 mm 4 – 5 GHz: ≥ 25 mm 5 – 6 GHz: ≥ 22 mm	
Note: δ is the penetration depth of a plane-wave at normal incidence to the tissue medium; see draft standard IEEE P1528-2011 for details. * When zoom scan is required and the <i>reported</i> SAR from the area scan based 1-g SAR estimation procedures of KDB 447498 is ≤ 1.4 W/kg, ≤ 8 mm, ≤ 7 mm and ≤ 5 mm zoom scan resolution may be applied, respectively, for 2 GHz to 3 GHz, 3 GHz to 4 GHz and 4 GHz to 6 GHz.				

9.3 WCDMA Measurement Procedures for SAR

The following procedures are applicable to WCDMA handsets operating under 3GPP Release99, Release 5 and Release 6. The default test configuration is to measure SAR with an established radio link between the DUT and a communication test set using a 12.2kbps RMC (reference measurement channel) configured in Test Loop Mode 1. SAR is selectively confirmed for other physical channel configurations (DPCCH & DPDCH_n), HSDPA and HSPA (HSUPA/HSDPA) modes according to output power, exposure conditions and device operating capabilities. Both uplink and downlink should be configured with the same RMC or AMR, when required. SAR for Release 5 HSDPA and Release 6 HSPA are measured using the applicable FRC (fixed reference channel) and E-DCH reference channel configurations. Maximum output power is verified according to applicable versions of 3GPP TS 34.121 and SAR must be measured according to these maximum output conditions. When Maximum Power Reduction (MPR) is not implemented according to Cubic Metric (CM) requirements for Release 6 HSPA, the following procedures do not apply.

For Release 5 HSDPA Data Devices:

Sub-test	β_c	β_d	β_d (SF)	β_c / β_d	β_{hs}	CM/dB
1	2/15	15/15	64	2/15	4/15	0.0
2	12/15	15/15	64	12/15	24/25	1.0
3	15/15	8/15	64	15/8	30/15	1.5
4	15/15	4/15	64	15/4	30/15	1.5

For Release 6 HSPA Data Devices

Sub-test	β_c	β_d	β_d (SF)	β_c / β_d	β_{hs}	β_{ec}	β_{ed}	β_{ed} (SF)	β_{ed} (codes)	CM (dB)	MPR (dB)	AG Index	E-TFCI
1	11/15	15/15	64	11/15	22/15	209/225	1039/225	4	1	1.5	1.5	20	75
2	6/15	15/15	64	6/15	12/15	12/15	12/15	4	1	1.5	1.5	12	67
3	15/15	9/15	64	15/9	30/15	30/15	$\beta_{ed1}:47/15$ $\beta_{ed2}:47/15$	4	2	1.5	1.5	15	92
4	2/15	15/15	64	2/15	4/15	4/15	56/75	4	1	1.5	1.5	17	71
5	15/15	15/15	64	15/15	24/15	30/15	134/15	4	1	1.5	1.5	21	81

Rel.8 DC-HSDPA (Cat 24)

SAR test exclusion for Rel.8 DC-HSDPA must satisfy the SAR test exclusion requirements of Rel.5 HSDPA. SAR test exclusion for DC-HSDPA devices is determined by power measurements according to the H-Set 12, Fixed Reference Channel (FRC) configuration in Table C.8.1.12 of 3GPP TS 34.121-1. A primary and a secondary serving HS-DSCH Cell are required to perform the power measurement and for the results to qualify for SAR test exclusion.

9.4 SAR Measurement for LTE

SAR tests for LTE are performed with a base station simulator, Rohde & Schwarz CMW500. Closed loop power control was used so the UE transmits with maximum output power during SAR testing. All powers were measured with the CMW 500.

It is performed for conducted power and SAR based on the KDB941225 D05.

SAR is evaluated separately according to the following procedures for the different test positions in each exposure condition – head, body, body-worn accessories and other use conditions. The procedures in the following subsections are applied separately to test each LTE frequency band.

1) QPSK with 1 RB allocation

Start with the largest channel bandwidth and measure SAR for QPSK with 1 RB allocation, using the RB offset and required test channel combination with the highest maximum output power among RB offsets at the upper edge, middle and lower edge of each required test channel. When the reported SAR is ≤ 0.8 W/kg, testing of the remaining RB offset configurations and required test channels is not required for 1 RB allocation; otherwise, SAR is required for the remaining required test channels and only for the RB offset configuration with the highest output power for that channel. When the reported SAR of a required test channel is > 1.45 W/kg, SAR is required for all three RB offset configurations for that required test channel.

2) QPSK with 50% RB allocation

The procedures required for 1 RB allocation in 1) are applied to measure the SAR for QPSK with 50% RB allocation.

3) QPSK with 100% RB allocation

For QPSK with 100% RB allocation, SAR is not required when the highest maximum output power for 100 % RB allocation is less than the highest maximum output power in 50% and 1 RB allocations and the highest reported SAR for 1 RB and 50% RB allocation in 1) and 2) are ≤ 0.8 W/kg. Otherwise, SAR is measured for the highest output power channel; and if the reported SAR is > 1.45 W/kg, the remaining required test channels must also be tested.

9.5 Bluetooth & Wi-Fi Measurement Procedures for SAR

Normal network operating configurations are not suitable for measuring the SAR of 802.11 transmitters in general. Unpredictable fluctuations in network traffic and antenna diversity conditions can introduce undesirable variations in SAR results. The SAR for these devices should be measured using chipset based test mode software to ensure that the results are consistent and reliable.

Chipset based test mode software is hardware dependent and generally varies among manufacturers. The device operating parameters established in a test mode for SAR measurements must be identical to those programmed in production units, including output power levels, amplifier gain settings and other RF performance tuning parameters. The test frequencies should correspond to actual channel frequencies defined for domestic use. SAR for devices with switched diversity should be measured with only one antenna transmitting at a time during each SAR measurement, according to a fixed modulation and data rate. The same data pattern should be used for all measurements.



No.I21Z60772-SEM01

9.6 Power Drift

To control the output power stability during the SAR test, DASY5 system calculates the power drift by measuring the E-field at the same location at the beginning and at the end of the measurement for each test position. These drift values can be found in section14 labeled as: (Power Drift [dB]). This ensures that the power drift during one measurement is within 5%.

10 Area Scan Based 1-g SAR

10.1 Requirement of KDB

According to the KDB447498 D01 v06, when the implementation is based the specific polynomial fit algorithm as presented at the 29th Bioelectromagnetics Society meeting (2007) and the estimated 1-gSAR is ≤ 1.2 W/kg, a zoom scan measurement is not required provided it is also not needed for any other purpose; for example, if the peak SAR location required for simultaneous transmission SAR test exclusion can be determined accurately by the SAR system or manually to discriminate between distinctive peaks and scattered noisy SAR distributions from area scans.

There must not be any warning or alert messages due to various measurement concerns identified by the SAR system; for example, noise in measurements, peaks too close to scan boundary, peaks are too sharp, spatial resolution and uncertainty issues etc. The SAR system verification must also demonstrate that the area scan estimated 1-g SAR is within 3% of the zoom scan 1-g SAR (See Annex B). When all the SAR results for each exposure condition in a frequency band and wireless mode are based on estimated 1-g SAR, the 1-g SAR for the highest SAR configuration must be determined by a zoom scan.

10.2 Fast SAR Algorithms

The approach is based on the area scan measurement applying a frequency dependent attenuation parameter. This attenuation parameter was empirically determined by analyzing a large number of phones. The MOTOROLA FAST SAR was developed and validated by the MOTOROLA Research Group in Ft. Lauderdale.

In the initial study, an approximation algorithm based on Linear fit was developed. The accuracy of the algorithm has been demonstrated across a broad frequency range (136-2450 MHz) and for both 1- and 10-g averaged SAR using a sample of 264 SAR measurements from 55 wireless handsets. For the sample size studied, the root-mean-squared errors of the algorithm are 1.2% and 5.8% for 1- and 10-g averaged SAR, respectively. The paper describing the algorithm in detail is expected to be published in August 2004 within the Special Issue of Transactions on MTT.

In the second step, the same research group optimized the fitting algorithm to an Polynomial fit whereby the frequency validity was extended to cover the range 30-6000MHz. Details of this study can be found in the BEMS 2007 Proceedings.

Both algorithms are implemented in DASY software.

11 Conducted Output Power

Table1: Summary of Receiver detection mechanism

Antenna	Receiver on (head scenario)	Receiver off + Hotspot on (Body/other scenario)	Receiver off (Body/other scenario)
Main antenna	Power Level A1	Power Level B1	Power Level C1

11.1 WCDMA Measurement result

Table 11.1-1: The conducted Power for WCDMA- Power Level A1/B1/C1

Item	band	FDDV result			
	ARFCN	4233 (846.6MHz)	4182 (836.4MHz)	4132 (826.4MHz)	Tune up
WCDMA	\	22.39	22.39	22.43	24.00
HSUPA	1	19.85	19.88	19.94	21.00
	2	19.46	19.50	19.55	21.00
	3	20.45	20.46	20.50	22.00
	4	18.98	18.99	19.00	20.50
	5	20.44	20.46	20.48	22.00
HSPA+		20.95	20.99	21.04	22.00
DC-HSDPA	1	21.48	21.48	21.50	23.00
	2	21.46	21.47	21.48	23.00
	3	20.98	20.96	20.99	22.50
	4	20.96	20.95	20.98	22.50

Table 11.1-2: The conducted Power for WCDMA- Power Level A1/C1

Item	band	FDDIV result			
	ARFCN	1513 (1752.6MHz)	1412(1732.4MHz)	1312 (1712.4MHz)	Tune up
WCDMA	\	22.50	22.54	22.53	24.00
HSUPA	1	19.67	20.01	19.64	21.00
	2	19.65	19.65	19.63	21.00
	3	20.62	20.63	20.61	22.00
	4	19.13	19.15	19.12	20.50
	5	20.6	20.62	20.59	22.00
HSPA+		21.15	21.21	21.15	22.50
DC-HSDPA	1	21.59	21.60	21.58	23.00
	2	21.58	21.59	21.58	23.00
	3	21.12	21.14	21.13	22.50
	4	21.1	21.12	21.12	22.50
Item	band	FDDII result			
	ARFCN	9538 (1907.6MHz)	9400 (1880MHz)	9262 (1852.4MHz)	Tune up
WCDMA	\	22.31	22.30	22.28	24.00

HSUPA	1	19.84	19.83	19.83	21.00
	2	19.4	19.44	19.39	21.00
	3	20.37	20.39	20.38	22.00
	4	18.89	18.90	18.88	20.50
	5	20.34	20.36	20.33	22.00
HSPA+		20.93	20.99	20.92	22.00
DC-HSDPA	1	21.43	21.42	21.40	23.00
	2	21.42	21.43	21.40	23.00
	3	20.93	20.92	20.90	22.50
	4	20.92	20.91	20.90	22.50

Table 11.1-3: The conducted Power for WCDMA- Power Level B1

Item	band	FDDIV result			
	ARFCN	1513 (1752.6MHz)	1412(1732.4MHz)	1312 (1712.4MHz)	Tune up
WCDMA	\	20.68	20.72	20.68	22.00
HSUPA	1	18.92	18.93	18.93	19.00
	2	18.55	18.56	18.56	19.00
	3	19.55	19.56	19.58	20.00
	4	18.05	18.07	18.06	18.50
	5	19.54	19.56	19.55	20.00
HSPA+		20.1	20.09	20.02	20.50
DC-HSDPA	1	20.52	20.52	20.56	21.00
	2	20.5	20.51	20.54	21.00
	3	20.02	20.01	20.03	21.00
	4	20.03	20.01	20.02	21.00
Item	band	FDDII result			
	ARFCN	9538 (1907.6MHz)	9400 (1880MHz)	9262 (1852.4MHz)	Tune up
WCDMA	\	18.32	18.38	18.36	20.00
HSUPA	1	16.65	16.69	16.67	17.00
	2	16.31	16.34	16.33	17.00
	3	17.29	17.33	17.32	18.00
	4	15.82	15.86	15.83	16.50
	5	17.26	17.30	17.28	18.00
HSPA+		17.83	17.82	17.83	18.00
DC-HSDPA	1	18.35	18.30	18.30	19.00
	2	18.31	18.30	18.29	19.00
	3	17.88	17.87	17.86	18.50
	4	17.87	17.86	17.86	18.50

11.2 LTE Measurement result

Table 11.2-1: Maximum Power Reduction (MPR) for LTE– Power Level A1/C1

Modulation	Channel bandwidth / Transmission bandwidth configuration [RB]						MPR (dB)
	1.4 MHz	3 MHz	5 MHz	10 MHz	15 MHz	20 MHz	
QPSK	> 5	> 4	> 8	> 12	> 16	> 18	1
16 QAM	≤ 5	≤ 4	≤ 8	≤ 12	≤ 16	≤ 18	1
16 QAM	> 5	> 4	> 8	> 12	> 16	> 18	2
64 QAM	≤ 5	≤ 4	≤ 8	≤ 12	≤ 16	≤ 18	2
64 QAM	> 5	> 4	> 8	> 12	> 16	> 18	3

Table 11.2-2: The tune up for LTE – Power Level A1/C1

Band	Tune up
LTE Band 2	24.5
LTE Band 4	24.5

Table 11.2-3: Maximum Power Reduction (MPR) for LTE– Power Level B1

Modulation	Channel bandwidth / Transmission bandwidth configuration [RB]						MPR (dB)
	1.4 MHz	3 MHz	5 MHz	10 MHz	15 MHz	20 MHz	
QPSK	> 5	> 4	> 8	> 12	> 16	> 18	0
16 QAM	≤ 5	≤ 4	≤ 8	≤ 12	≤ 16	≤ 18	0
16 QAM	> 5	> 4	> 8	> 12	> 16	> 18	0
64 QAM	≤ 5	≤ 4	≤ 8	≤ 12	≤ 16	≤ 18	0
64 QAM	> 5	> 4	> 8	> 12	> 16	> 18	1

Table 11.2-4: The tune up for LTE – Power Level B1

Band	Tune up
LTE Band 2	22.5
LTE Band 4	22.5

Table 11.2-5: Maximum Power Reduction (MPR) for LTE– Power Level A1/B1/C1

Modulation	Channel bandwidth / Transmission bandwidth configuration [RB]						MPR (dB)
	1.4 MHz	3 MHz	5 MHz	10 MHz	15 MHz	20 MHz	
QPSK	> 5	> 4	> 8	> 12	> 16	> 18	1
16 QAM	≤ 5	≤ 4	≤ 8	≤ 12	≤ 16	≤ 18	1
16 QAM	> 5	> 4	> 8	> 12	> 16	> 18	2
64 QAM	≤ 5	≤ 4	≤ 8	≤ 12	≤ 16	≤ 18	2
64 QAM	> 5	> 4	> 8	> 12	> 16	> 18	3

Table 11.2-6: The tune up for LTE – Power Level A1/B1/C1

Band	Tune up
LTE Band 5	25
LTE Band 12	25
LTE Band 14	24

Table 11.2-7: Maximum Power Reduction (MPR) for LTE– Power Level A1

Modulation	Channel bandwidth / Transmission bandwidth configuration [RB]						MPR (dB)
	1.4 MHz	3 MHz	5 MHz	10 MHz	15 MHz	20 MHz	
QPSK	> 5	> 4	> 8	> 12	> 16	> 18	1
16 QAM	≤ 5	≤ 4	≤ 8	≤ 12	≤ 16	≤ 18	1
16 QAM	> 5	> 4	> 8	> 12	> 16	> 18	2
64 QAM	≤ 5	≤ 4	≤ 8	≤ 12	≤ 16	≤ 18	2
64 QAM	> 5	> 4	> 8	> 12	> 16	> 18	3

Table 11.2-8: The tune up for LTE – Power Level A1

Band	Tune up
LTE Band 30	24.5

Table 11.2-9: Maximum Power Reduction (MPR) for LTE– Power Level B1

Modulation	Channel bandwidth / Transmission bandwidth configuration [RB]						MPR (dB)
	1.4 MHz	3 MHz	5 MHz	10 MHz	15 MHz	20 MHz	
QPSK	> 5	> 4	> 8	> 12	> 16	> 18	0
16 QAM	≤ 5	≤ 4	≤ 8	≤ 12	≤ 16	≤ 18	0
16 QAM	> 5	> 4	> 8	> 12	> 16	> 18	0
64 QAM	≤ 5	≤ 4	≤ 8	≤ 12	≤ 16	≤ 18	0
64 QAM	> 5	> 4	> 8	> 12	> 16	> 18	0

Table 11.2-8: The tune up for LTE – Power Level B1

Band	Tune up
LTE Band 30	20

Table 11.2-9: Maximum Power Reduction (MPR) for LTE– Power Level C1

Modulation	Channel bandwidth / Transmission bandwidth configuration [RB]						MPR (dB)
	1.4	3	5	10	15	20	
	MHz	MHz	MHz	MHz	MHz	MHz	
QPSK	> 5	> 4	> 8	> 12	> 16	> 18	0
16 QAM	≤ 5	≤ 4	≤ 8	≤ 12	≤ 16	≤ 18	0
16 QAM	> 5	> 4	> 8	> 12	> 16	> 18	1
64 QAM	≤ 5	≤ 4	≤ 8	≤ 12	≤ 16	≤ 18	1
64 QAM	> 5	> 4	> 8	> 12	> 16	> 18	2

Table 11.2-9: The tune up for LTE – Power Level C1

Band	Tune up
LTE Band 30	23.5

Power Level A1/C1

Band 2						
Bandwidth (MHz)	RB allocation RB offset (Start RB)	Frequency (MHz)	QPSK	16QAM	64QAM	
			Actual output power (dBm)	Actual output power (dBm)	Actual output power (dBm)	
1.4 MHz	1RB High (5)	1909.3	23.30	22.46	21.35	
		1880	23.35	22.57	21.47	
		1850.7	23.39	22.68	21.58	
	1RB Middle (3)	1909.3	23.33	22.48	21.43	
		1880	23.45	22.63	21.50	
		1850.7	23.48	22.74	21.60	
	1RB Low (0)	1909.3	23.30	22.49	21.40	
		1880	23.31	22.60	21.48	
		1850.7	23.39	22.48	21.51	
	3RB High (3)	1909.3	23.41	22.24	21.41	
			1880	23.44	22.41	21.50
			1850.7	23.50	22.41	21.52
		1909.3	23.46	22.37	21.44	
			1880	23.48	22.41	21.55
			1850.7	23.50	22.43	21.58
		3RB Low (0)	1909.3	23.39	22.32	21.42
			1880	23.43	22.42	21.45
			1850.7	23.47	22.44	21.58
	6RB (0)	1909.3	22.47	21.43	20.33	
		1880	22.43	21.46	20.39	
		1850.7	22.46	21.59	20.45	
	3 MHz	1RB High (14)	1908.5	23.45	22.58	21.40
			1880	23.44	22.77	21.60
			1851.5	23.46	22.80	21.59
1RB Middle		1908.5	23.52	22.66	21.56	
		1880	23.53	22.75	21.66	

	(7)	1851.5	23.60	22.80	21.77
	1RB Low (0)	1908.5	23.43	22.62	21.49
		1880	23.42	22.72	21.53
		1851.5	23.48	22.82	21.64
	8RB High (7)	1908.5	22.45	21.46	20.45
		1880	22.41	21.49	20.48
		1851.5	22.49	21.55	20.53
	8RB Middle (4)	1908.5	22.47	21.46	20.45
		1880	22.46	21.49	20.47
		1851.5	22.52	21.57	20.50
	8RB Low (0)	1908.5	22.43	21.43	20.43
		1880	22.43	21.50	20.47
		1851.5	22.48	21.56	20.50
	15RB (0)	1908.5	22.46	21.39	20.43
		1880	22.46	21.44	20.41
1851.5		22.50	21.53	20.46	
5 MHz	1RB High (24)	1907.5	23.46	22.60	21.47
		1880	23.42	22.61	21.61
		1852.5	23.48	22.72	21.61
	1RB Middle (12)	1907.5	23.55	22.72	21.63
		1880	23.59	22.75	21.70
		1852.5	23.64	22.87	21.81
	1RB Low (0)	1907.5	23.41	22.59	21.48
		1880	23.50	22.59	21.57
		1852.5	23.48	22.71	21.59
	12RB High (13)	1907.5	22.42	21.39	20.40
		1880	22.46	21.43	20.47
		1852.5	22.53	21.51	20.54
	12RB Middle (6)	1907.5	22.49	21.40	20.46
		1880	22.52	21.50	20.52
		1852.5	22.58	21.58	20.56
	12RB Low (0)	1907.5	22.47	21.40	20.41
		1880	22.47	21.44	20.45
		1852.5	22.50	21.51	20.51
	25RB (0)	1907.5	22.46	21.41	20.40
		1880	22.48	21.48	20.45
		1852.5	22.54	21.54	20.52
10 MHz	1RB High (49)	1905	23.52	22.69	21.46
		1880	23.50	22.71	21.62
		1855	23.57	22.79	21.67
	1RB Middle (24)	1905	23.57	22.77	21.64
		1880	23.62	22.75	21.70
		1855	23.66	22.88	21.71
	1RB Low (0)	1905	23.52	22.77	21.59
		1880	23.51	22.76	21.63
		1855	23.57	22.88	21.67
	25RB High (25)	1905	22.56	21.48	20.46
1880		22.56	21.54	20.51	

	25RB Middle (12)	1855	22.61	21.60	20.58	
		1905	22.59	21.54	20.52	
		1880	22.61	21.56	20.53	
		1855	22.63	21.62	20.56	
	25RB Low (0)	1905	22.60	21.56	20.53	
		1880	22.59	21.55	20.54	
		1855	22.57	21.57	20.55	
	50RB (0)	1905	22.59	21.52	20.48	
		1880	22.56	21.56	20.51	
		1855	22.61	21.60	20.56	
	15 MHz	1RB High (74)	1902.5	23.62	22.68	21.55
			1880	23.62	22.86	21.65
1857.5			23.65	22.90	21.69	
1RB Middle (37)		1902.5	23.63	22.84	21.67	
		1880	23.65	22.84	21.71	
		1857.5	23.66	22.90	21.76	
1RB Low (0)		1902.5	23.66	22.76	21.63	
		1880	23.63	22.90	21.74	
		1857.5	23.69	22.92	21.78	
36RB High (38)		1902.5	22.69	21.61	20.55	
		1880	22.72	21.65	20.63	
		1857.5	22.75	21.69	20.67	
36RB Middle (19)		1902.5	22.72	21.64	20.61	
		1880	22.73	21.65	20.62	
		1857.5	22.74	21.68	20.66	
36RB Low (0)		1902.5	22.75	21.67	20.62	
		1880	22.72	21.68	20.61	
		1857.5	22.73	21.66	20.67	
75RB (0)		1902.5	22.71	21.66	20.61	
		1880	22.71	21.65	20.60	
		1857.5	22.73	21.70	20.63	
20 MHz		1RB High (99)	1900	23.56	22.70	21.58
			1880	23.55	22.78	21.63
			1860	23.57	22.87	21.70
		1RB Middle (50)	1900	23.72	22.80	21.79
			1880	23.72	22.94	21.83
			1860	23.78	23.01	21.95
	1RB Low (0)	1900	23.60	22.80	21.62	
		1880	23.57	22.93	21.77	
		1860	23.60	22.92	21.76	
	50RB High (50)	1900	22.68	21.65	20.65	
		1880	22.73	21.73	20.69	
		1860	22.76	21.76	20.70	
	50RB Middle (25)	1900	22.76	21.72	20.69	
		1880	22.76	21.77	20.71	
		1860	22.79	21.75	20.74	
	50RB Low (0)	1900	22.86	21.84	20.82	
		1880	22.77	21.78	20.72	

	100RB (0)	1860	22.72	21.71	20.72
		1900	22.72	21.72	20.68
		1880	22.75	21.74	20.70
		1860	22.73	21.72	20.68

Power Level B1

Band 2					
Bandwidth (MHz)	RB allocation RB offset (Start RB)	Frequency (MHz)	QPSK	16QAM	64QAM
			Actual output power (dBm)	Actual output power (dBm)	Actual output power (dBm)
1.4 MHz	1RB High (5)	1909.3	21.53	21.60	21.57
		1880	21.51	21.78	21.68
		1850.7	21.58	21.80	21.74
	1RB Middle (3)	1909.3	21.59	21.74	21.58
		1880	21.59	21.72	21.71
		1850.7	21.63	21.88	21.75
	1RB Low (0)	1909.3	21.50	21.63	21.57
		1880	21.51	21.79	21.65
		1850.7	21.57	21.86	21.72
	3RB High (3)	1909.3	21.59	21.47	21.63
		1880	21.60	21.57	21.55
		1850.7	21.69	21.62	21.76
	3RB Middle (1)	1909.3	21.63	21.54	21.62
		1880	21.61	21.59	21.63
		1850.7	21.70	21.62	21.74
	3RB Low (0)	1909.3	21.59	21.49	21.63
		1880	21.60	21.53	21.71
		1850.7	21.65	21.65	21.76
	6RB (0)	1909.3	21.64	21.63	20.54
		1880	21.60	21.64	20.64
		1850.7	21.62	21.73	20.62
3 MHz	1RB High (14)	1908.5	21.60	21.69	21.63
		1880	21.61	21.85	21.73
		1851.5	21.66	21.89	21.81
	1RB Middle (7)	1908.5	21.73	21.81	21.76
		1880	21.69	21.82	21.85
		1851.5	21.79	22.00	21.90
	1RB Low (0)	1908.5	21.59	21.78	21.67
		1880	21.59	21.91	21.67
		1851.5	21.66	21.98	21.76
	8RB High (7)	1908.5	21.62	21.61	20.59
		1880	21.60	21.59	20.63
		1851.5	21.67	21.73	20.70
	8RB Middle (4)	1908.5	21.63	21.61	20.61
		1880	21.61	21.62	20.64
		1851.5	21.70	21.73	20.71

	8RB Low (0)	1908.5	21.58	21.59	20.58	
		1880	21.58	21.63	20.63	
		1851.5	21.69	21.72	20.67	
	15RB (0)	1908.5	21.61	21.57	20.53	
		1880	21.59	21.63	20.59	
		1851.5	21.68	21.66	20.66	
5 MHz	1RB High (24)	1907.5	21.55	21.64	21.56	
		1880	21.60	21.79	21.63	
		1852.5	21.65	21.93	21.78	
	1RB Middle (12)	1907.5	21.63	21.82	21.77	
		1880	21.73	21.98	21.81	
		1852.5	21.79	21.94	21.93	
	1RB Low (0)	1907.5	21.56	21.69	21.62	
		1880	21.58	21.76	21.73	
		1852.5	21.60	21.81	21.72	
	12RB High (13)	1907.5	21.57	21.51	20.54	
		1880	21.57	21.58	20.61	
		1852.5	21.67	21.64	20.67	
	12RB Middle (6)	1907.5	21.63	21.54	20.59	
		1880	21.65	21.63	20.65	
		1852.5	21.71	21.67	20.70	
	12RB Low (0)	1907.5	21.58	21.51	20.58	
		1880	21.61	21.58	20.62	
		1852.5	21.68	21.63	20.65	
	25RB (0)	1907.5	21.60	21.52	20.55	
		1880	21.62	21.60	20.62	
		1852.5	21.69	21.65	20.67	
	10 MHz	1RB High (49)	1905	21.58	21.70	21.61
			1880	21.62	21.76	21.69
			1855	21.62	21.91	21.72
1RB Middle (24)		1905	21.62	21.79	21.75	
		1880	21.69	21.85	21.77	
		1855	21.73	21.86	21.86	
1RB Low (0)		1905	21.55	21.77	21.73	
		1880	21.60	21.86	21.73	
		1855	21.70	21.85	21.87	
25RB High (25)		1905	21.60	21.55	20.57	
		1880	21.63	21.62	20.61	
		1855	21.69	21.68	20.68	
25RB Middle (12)		1905	21.66	21.62	20.61	
		1880	21.64	21.66	20.63	
		1855	21.74	21.70	20.68	
25RB Low (0)		1905	21.65	21.63	20.64	
		1880	21.64	21.65	20.63	
		1855	21.67	21.65	20.65	
50RB (0)		1905	21.63	21.60	20.62	
		1880	21.64	21.65	20.62	
		1855	21.68	21.66	20.66	

15 MHz	1RB High (74)	1902.5	21.55	21.68	21.64	
		1880	21.57	21.74	21.67	
		1857.5	21.61	21.82	21.74	
	1RB Middle (37)	1902.5	21.57	21.69	21.62	
		1880	21.56	21.82	21.78	
		1857.5	21.64	21.93	21.77	
	1RB Low (0)	1902.5	21.57	21.79	21.71	
		1880	21.58	21.82	21.72	
		1857.5	21.63	21.91	21.83	
	36RB High (38)	1902.5	21.62	21.57	20.58	
		1880	21.67	21.62	20.62	
		1857.5	21.69	21.67	20.69	
	36RB Middle (19)	1902.5	21.65	21.60	20.62	
		1880	21.67	21.65	20.63	
		1857.5	21.68	21.68	20.67	
	36RB Low (0)	1902.5	21.67	21.63	20.64	
		1880	21.66	21.62	20.64	
		1857.5	21.68	21.65	20.65	
	75RB (0)	1902.5	21.65	21.62	20.60	
		1880	21.66	21.65	20.64	
		1857.5	21.69	21.69	20.64	
	20 MHz	1RB High (99)	1900	21.39	21.51	21.44
			1880	21.39	21.51	21.54
			1860	21.41	21.69	21.49
		1RB Middle (50)	1900	21.50	21.77	21.65
			1880	21.55	21.77	21.73
			1860	21.60	21.90	21.77
1RB Low (0)		1900	21.42	21.49	21.47	
		1880	21.43	21.57	21.59	
		1860	21.44	21.69	21.59	
50RB High (50)		1900	21.51	21.50	20.63	
		1880	21.59	21.57	20.54	
		1860	21.60	21.60	20.57	
50RB Middle (25)		1900	21.58	21.56	20.54	
		1880	21.59	21.57	20.57	
		1860	21.61	21.61	20.59	
50RB Low (0)		1900	21.68	21.67	20.64	
		1880	21.63	21.61	20.59	
		1860	21.57	21.60	20.57	
100RB (0)		1900	21.58	21.55	20.57	
		1880	21.58	21.56	20.55	
		1860	21.59	21.58	20.55	

Power Level A1/C1

Band 4						
Bandwidth (MHz)	RB allocation	Frequency (MHz)	Actual output power (dBm)			
	RB offset		QPSK	16QAM	64QAM	
1.4 MHz	1RB_High	1754.3	23.35	22.52	21.50	
		1732.5	23.36	22.70	21.57	
		1710.7	23.43	22.65	21.65	
	1RB_Middle	1754.3	23.42	22.72	21.59	
		1732.5	23.46	22.71	21.64	
		1710.7	23.51	22.76	21.73	
	1RB_Low	1754.3	23.33	22.59	21.59	
		1732.5	23.37	22.61	21.57	
		1710.7	23.42	22.71	21.58	
	3RB_High	1754.3	23.45	22.50	21.51	
		1732.5	23.45	22.44	21.53	
		1710.7	23.55	22.51	21.67	
	3RB_Middle	1754.3	23.49	22.44	21.60	
		1732.5	23.51	22.52	21.59	
		1710.7	23.57	22.52	21.63	
	3RB_Low	1754.3	23.43	22.45	21.53	
		1732.5	23.46	22.49	21.53	
		1710.7	23.53	22.51	21.63	
	6RB	1754.3	22.47	21.55	20.44	
		1732.5	22.46	21.59	20.46	
		1710.7	22.53	21.59	20.56	
	3 MHz	1RB_High	1753.5	23.36	22.60	21.62
			1732.5	23.40	22.73	21.57
			1711.5	23.46	22.78	21.65
		1RB_Middle	1753.5	23.45	22.74	21.72
			1732.5	23.51	22.84	21.73
			1711.5	23.57	22.91	21.81
1RB_Low		1753.5	23.39	22.61	21.58	
		1732.5	23.41	22.66	21.58	
		1711.5	23.47	22.70	21.73	
8RB_High		1753.5	22.41	21.51	20.48	
		1732.5	22.41	21.50	20.53	
		1711.5	22.49	21.59	20.55	
8RB_Middle		1753.5	22.41	21.55	20.51	
		1732.5	22.41	21.50	20.52	
		1711.5	22.52	21.59	20.57	
8RB_Low		1753.5	22.43	21.54	20.46	
		1732.5	22.42	21.51	20.50	
		1711.5	22.50	22.46	20.55	
15RB		1753.5	22.43	21.47	20.44	

		1732.5	22.44	21.47	20.41
		1711.5	22.51	21.51	20.52
5 MHz	1RB_High	1752.5	23.36	22.58	21.51
		1732.5	23.37	22.59	21.61
		1712.5	23.41	22.78	21.67
	1RB_Middle	1752.5	23.42	22.72	21.68
		1732.5	23.51	22.79	21.66
		1712.5	23.58	22.95	21.83
	1RB_Low	1752.5	23.35	22.62	21.54
		1732.5	23.39	22.72	21.60
		1712.5	23.44	22.76	21.75
	12RB_High	1752.5	22.40	21.41	20.43
		1732.5	22.42	21.45	20.49
		1712.5	22.56	21.59	20.55
	12RB_Middle	1752.5	22.46	21.51	20.48
		1732.5	22.47	21.49	20.50
		1712.5	22.54	21.56	20.57
	12RB_Low	1752.5	22.41	21.42	20.43
		1732.5	22.42	21.45	20.45
		1712.5	22.52	21.56	20.53
	25RB	1752.5	22.43	21.45	20.46
		1732.5	22.41	21.46	20.44
		1712.5	22.56	21.60	20.51
10MHz	1RB_High	1750	23.40	23.24	21.59
		1732.5	23.41	22.74	21.48
		1715	23.46	22.79	21.67
	1RB_Middle	1750	23.50	22.78	21.66
		1732.5	23.48	22.67	21.73
		1715	23.55	22.85	21.74
	1RB_Low	1750	23.44	22.74	21.66
		1732.5	23.44	22.70	21.68
		1715	23.49	22.74	21.67
	25RB_High	1750	22.45	21.46	20.43
		1732.5	22.42	21.46	20.46
		1715	22.55	21.56	20.54
	25RB_Middle	1750	22.47	21.50	20.50
		1732.5	22.49	21.52	20.50
		1715	22.53	21.55	20.54
	25RB_Low	1750	22.46	21.49	20.48
		1732.5	22.47	21.52	20.50
		1715	22.47	21.54	20.51
	50RB	1750	22.45	21.46	20.45
		1732.5	22.44	21.50	20.47
		1715	22.52	21.54	20.56
15MHz	1RB_High	1747.5	23.36	22.65	21.52
		1732.5	23.37	22.62	21.62
		1717.5	23.39	22.66	21.59
	1RB_Middle	1747.5	23.40	22.68	21.63

		1732.5	23.38	22.56	21.61
		1717.5	23.50	22.69	21.51
		1747.5	23.35	22.71	21.67
	1RB_Low	1732.5	23.41	22.71	21.63
		1717.5	23.44	22.71	21.72
		1747.5	22.45	21.44	20.48
	36RB_High	1732.5	22.42	21.45	20.47
		1717.5	22.56	21.50	20.55
		1747.5	22.49	21.48	20.50
	36RB_Middle	1732.5	22.49	21.48	20.47
		1717.5	22.53	21.49	20.52
		1747.5	22.50	21.50	20.45
	36RB_Low	1732.5	22.49	21.52	20.52
		1717.5	22.51	21.49	20.51
		1747.5	22.47	21.48	20.45
75RB	1732.5	22.46	21.48	20.46	
	1717.5	22.52	21.52	20.52	
	1745	23.43	22.75	21.67	
20MHz	1RB_High	1732.5	23.44	22.69	21.67
		1720	23.44	22.78	21.66
		1745	23.68	22.93	21.88
	1RB_Middle	1732.5	23.62	22.90	21.84
		1720	23.74	23.07	21.88
		1745	23.53	22.82	21.70
	1RB_Low	1732.5	23.50	22.75	21.73
		1720	23.55	22.77	21.79
		1745	22.68	21.69	20.69
	50RB_High	1732.5	22.60	21.66	20.62
		1720	22.73	21.72	20.73
		1745	22.68	21.69	20.68
	50RB_Middle	1732.5	22.66	21.69	20.68
		1720	22.71	21.72	20.70
		1745	22.70	21.70	20.70
	50RB_Low	1732.5	22.70	21.72	20.69
		1720	22.63	21.62	20.63
		1745	22.70	21.70	20.70
	100RB	1732.5	22.65	21.64	20.64
		1720	22.69	21.68	20.66

Power Level B1

Band 4						
Bandwidth (MHz)	RB allocation	Frequency (MHz)	Actual output power (dBm)			
	RB offset		QPSK	16QAM	64QAM	
1.4 MHz	1RB_High	1754.3	21.49	21.72	21.69	
		1732.5	21.53	21.82	21.64	
		1710.7	21.62	21.92	21.86	
	1RB_Middle	1754.3	21.61	21.80	21.77	
		1732.5	21.61	21.89	21.79	
		1710.7	21.68	21.96	21.83	
	1RB_Low	1754.3	21.50	21.81	21.69	
		1732.5	21.50	21.80	21.68	
		1710.7	21.61	21.95	21.81	
	3RB_High	1754.3	21.64	21.66	21.72	
		1732.5	21.65	21.58	21.69	
		1710.7	21.69	21.65	21.77	
	3RB_Middle	1754.3	21.65	21.64	21.73	
		1732.5	21.66	21.61	21.70	
		1710.7	21.74	21.72	21.78	
	3RB_Low	1754.3	21.61	21.63	21.70	
		1732.5	21.60	21.61	21.73	
		1710.7	21.72	21.70	21.70	
	6RB	1754.3	21.62	21.68	20.58	
		1732.5	21.62	21.72	20.59	
		1710.7	21.71	21.78	20.64	
	3 MHz	1RB_High	1753.5	21.60	21.87	21.67
			1732.5	21.61	21.82	21.79
			1711.5	21.67	21.94	21.83
		1RB_Middle	1753.5	21.65	21.91	21.80
			1732.5	21.73	21.92	21.81
			1711.5	21.73	22.12	21.97
1RB_Low		1753.5	21.56	21.86	21.73	
		1732.5	21.58	21.90	21.69	
		1711.5	21.67	21.97	21.82	
8RB_High		1753.5	21.57	21.62	20.57	
		1732.5	21.59	21.64	20.63	
		1711.5	21.67	21.69	20.65	
8RB_Middle		1753.5	21.62	21.66	20.61	
		1732.5	21.62	21.65	20.65	
		1711.5	21.68	21.74	20.73	
8RB_Low		1753.5	21.59	21.67	20.62	
		1732.5	21.58	21.65	20.55	
		1711.5	21.68	21.72	20.67	
15RB		1753.5	21.60	21.61	20.61	

		1732.5	21.57	21.60	20.56
		1711.5	21.69	21.67	20.63
5 MHz	1RB_High	1752.5	21.57	21.82	21.69
		1732.5	21.61	21.83	21.77
		1712.5	21.65	21.92	21.85
	1RB_Middle	1752.5	21.66	22.00	21.84
		1732.5	21.68	21.97	21.90
		1712.5	21.87	21.96	21.87
	1RB_Low	1752.5	21.56	21.89	21.73
		1732.5	21.60	21.84	21.70
		1712.5	21.66	21.96	21.55
	12RB_High	1752.5	21.61	21.61	20.61
		1732.5	21.61	21.61	20.64
		1712.5	21.72	21.73	20.69
	12RB_Middle	1752.5	21.67	21.67	20.66
		1732.5	21.65	21.64	20.65
		1712.5	21.77	21.72	20.72
	12RB_Low	1752.5	21.61	21.58	20.63
		1732.5	21.63	21.62	20.63
		1712.5	21.72	21.71	20.67
	25RB	1752.5	21.62	21.61	20.61
		1732.5	21.61	21.63	20.61
		1712.5	21.74	21.75	20.68
10MHz	1RB_High	1750	21.65	21.87	21.79
		1732.5	21.64	21.89	21.81
		1715	21.73	21.95	21.87
	1RB_Middle	1750	21.70	21.93	21.90
		1732.5	21.72	21.90	21.88
		1715	21.77	22.10	21.98
	1RB_Low	1750	21.70	22.00	21.80
		1732.5	21.66	21.98	21.76
		1715	21.75	22.02	21.95
	25RB_High	1750	21.67	21.65	20.64
		1732.5	21.62	21.62	20.64
		1715	21.76	21.77	20.77
	25RB_Middle	1750	21.71	21.69	20.72
		1732.5	21.67	21.69	20.69
		1715	21.75	21.74	20.77
	25RB_Low	1750	21.66	21.67	20.65
		1732.5	21.69	21.71	20.69
		1715	21.70	21.73	20.71
	50RB	1750	21.65	21.66	20.65
		1732.5	21.64	21.67	20.62
		1715	21.74	21.73	20.71
15MHz	1RB_High	1747.5	21.57	21.77	21.70
		1732.5	21.62	21.94	21.79
		1717.5	21.63	21.88	21.84
	1RB_Middle	1747.5	21.63	21.96	21.78

		1732.5	21.63	21.85	21.76
		1717.5	21.69	21.98	21.86
		1747.5	21.64	21.96	21.83
	1RB_Low	1732.5	21.65	21.84	21.82
		1717.5	21.68	21.94	21.86
		1747.5	21.71	21.63	20.66
	36RB_High	1732.5	21.68	21.69	20.66
		1717.5	21.79	21.75	20.75
		1747.5	21.72	21.69	20.68
	36RB_Middle	1732.5	21.71	21.67	20.67
		1717.5	21.77	21.72	20.75
		1747.5	21.68	21.68	20.70
	36RB_Low	1732.5	21.72	21.69	20.70
		1717.5	21.75	21.71	20.71
		1747.5	21.72	21.69	20.66
75RB	1732.5	21.66	21.66	20.64	
	1717.5	21.75	21.75	20.70	
	1745	21.33	21.65	21.50	
20MHz	1RB_High	1732.5	21.37	21.67	21.62
		1720	21.37	21.72	21.49
		1745	21.56	21.95	21.64
	1RB_Middle	1732.5	21.59	21.78	21.78
		1720	21.60	21.84	21.82
		1745	21.42	21.78	21.56
	1RB_Low	1732.5	21.42	21.75	21.61
		1720	21.46	21.77	21.64
		1745	21.57	21.57	20.55
	50RB_High	1732.5	21.50	21.55	20.52
		1720	21.61	21.63	20.61
		1745	21.60	21.59	20.59
	50RB_Middle	1732.5	21.57	21.59	20.55
		1720	21.52	21.61	20.61
		1745	21.58	21.59	20.60
	50RB_Low	1732.5	21.59	21.60	20.59
		1720	21.53	21.53	20.55
		1745	21.58	21.57	20.57
	100RB	1732.5	21.53	21.55	20.56
		1720	21.60	21.58	20.55

Power Level A1/B1/C1

Band 5					
Bandwidth (MHz)	RB allocation	Frequency (MHz)	QPSK	16QAM	64QAM
	RB offset (Start RB)		Actual output power (dBm)	Actual output power (dBm)	Actual output power (dBm)
1.4 MHz	1RB High (5)	848.3	23.72	23.03	21.93
		836.5	23.80	23.10	22.00
		824.7	23.85	23.11	22.02
	1RB Middle (3)	848.3	23.86	23.06	22.08
		836.5	23.90	23.25	21.99
		824.7	23.93	23.21	22.07
	1RB Low (0)	848.3	23.78	22.89	21.97
		836.5	23.81	23.17	21.94
		824.7	23.85	23.14	22.05
	3RB High (3)	848.3	23.86	22.82	21.96
		836.5	23.92	22.96	22.03
		824.7	23.92	22.86	22.00
	3RB Middle (1)	848.3	23.90	22.95	21.98
		836.5	23.95	22.99	22.92
		824.7	23.95	23.01	22.06
	3RB Low (0)	848.3	23.88	22.88	21.93
		836.5	23.91	22.93	22.02
		824.7	23.95	22.92	22.05
	6RB (0)	848.3	22.88	21.94	20.88
		836.5	22.96	22.02	20.93
		824.7	22.96	22.03	20.96
3 MHz	1RB High (14)	847.5	23.71	23.03	21.87
		836.5	23.76	23.03	21.99
		825.5	23.80	22.99	21.96
	1RB Middle (7)	847.5	23.85	23.11	22.03
		836.5	23.94	23.10	22.02
		825.5	23.88	23.19	22.04
	1RB Low (0)	847.5	23.74	23.01	21.92
		836.5	23.78	23.10	21.92
		825.5	23.81	23.13	21.94
	8RB High (7)	847.5	22.74	21.78	20.79
		836.5	22.82	21.89	20.86
		825.5	22.87	21.88	20.86
	8RB Middle (4)	847.5	22.76	21.84	20.83
		836.5	22.81	21.86	20.86
		825.5	22.87	21.94	20.90
	8RB Low (0)	847.5	22.78	21.85	20.84
		836.5	22.81	21.90	20.86
		825.5	22.81	21.88	20.87
15RB (0)	847.5	22.77	21.78	20.77	
	836.5	22.80	21.83	20.79	

5 MHz	1RB High (24)	825.5	22.81	21.83	20.82	
		846.5	23.70	22.94	21.90	
		836.5	23.74	23.06	21.94	
		826.5	23.80	23.05	21.98	
	1RB Middle (12)	846.5	23.84	23.01	22.09	
		836.5	23.91	23.19	22.05	
		826.5	23.87	23.22	22.04	
	1RB Low (0)	846.5	23.74	23.03	21.92	
		836.5	23.76	23.08	21.99	
		826.5	23.76	23.10	21.91	
	12RB High (13)	846.5	22.75	21.74	20.77	
		836.5	22.86	21.85	20.89	
		826.5	22.83	21.79	20.84	
	12RB Middle (6)	846.5	22.82	21.79	20.85	
		836.5	22.86	21.83	20.88	
		826.5	22.89	21.89	20.92	
	12RB Low (0)	846.5	22.82	21.80	20.86	
		836.5	23.80	21.78	20.84	
		826.5	22.81	21.81	20.83	
	25RB (0)	846.5	22.82	21.81	20.81	
		836.5	22.85	21.84	20.86	
		826.5	22.84	21.86	20.85	
	10 MHz	1RB High (49)	844	23.84	23.04	21.97
			836.5	23.86	23.06	22.01
829			23.89	23.28	22.89	
1RB Middle (24)		844	23.90	23.25	22.08	
		836.5	23.94	23.29	22.09	
		829	23.99	23.24	22.98	
1RB Low (0)		844	23.90	23.16	22.07	
		836.5	23.93	23.17	22.12	
		829	23.93	23.11	22.93	
25RB High (25)		844	22.87	21.88	20.88	
		836.5	23.08	22.07	21.13	
		829	22.89	21.92	20.89	
25RB Middle (12)		844	22.94	21.94	20.96	
		836.5	22.97	21.98	20.99	
		829	22.99	21.98	20.96	
25RB Low (0)		844	23.00	22.02	21.04	
		836.5	22.98	21.98	21.00	
		829	23.05	22.02	21.01	
50RB (0)		844	22.93	21.95	20.95	
		836.5	23.04	22.04	21.03	
		829	22.96	21.95	20.94	

Band 12						
Bandwidth (MHz)	RB allocation	Frequency (MHz)	QPSK	16QAM	64QAM	
	RB offset (Start RB)		Actual output power (dBm)	Actual output power (dBm)	Actual output power (dBm)	
1.4 MHz	1RB High (5)	715.3	23.93	23.13	22.02	
		707.5	23.94	23.06	22.13	
		699.7	23.97	23.22	22.01	
	1RB Middle (3)	715.3	24.03	23.23	22.14	
		707.5	24.03	23.25	22.22	
		699.7	24.01	23.32	22.08	
	1RB Low (0)	715.3	23.91	23.13	21.99	
		707.5	23.96	23.14	22.08	
		699.7	23.89	23.07	22.04	
	3RB High (3)	715.3	24.00	22.99	22.09	
		707.5	24.02	23.06	22.13	
		699.7	24.04	23.07	22.12	
	3RB Middle (1)	715.3	24.09	23.08	22.12	
		707.5	24.05	23.11	22.18	
		699.7	24.08	23.07	22.15	
	3RB Low (0)	715.3	24.04	22.97	22.10	
		707.5	24.04	23.05	22.11	
		699.7	24.04	23.03	22.07	
	6RB (0)	715.3	23.05	22.07	21.04	
		707.5	23.02	22.13	21.06	
		699.7	23.03	22.14	21.06	
	3 MHz	1RB High (14)	714.5	23.96	23.19	22.10
			707.5	24.00	23.19	22.06
			700.5	24.03	23.27	22.17
		1RB Middle (7)	714.5	24.04	23.34	22.26
			707.5	24.14	23.38	22.20
			700.5	24.18	23.33	22.31
1RB Low (0)		714.5	23.95	23.17	22.09	
		707.5	24.02	23.19	22.14	
		700.5	23.99	23.26	22.08	
8RB High (7)		714.5	23.00	22.08	21.03	
		707.5	23.04	22.11	21.08	
		700.5	23.02	22.12	21.12	
8RB Middle (4)		714.5	23.00	22.04	21.04	
		707.5	23.04	22.08	21.11	
		700.5	23.05	22.13	21.13	
8RB Low (0)		714.5	23.00	22.07	21.07	
		707.5	23.03	22.12	21.13	
		700.5	23.02	22.07	21.76	
15RB (0)		714.5	22.98	21.99	21.02	
		707.5	23.03	22.04	21.07	
		700.5	23.04	22.05	21.05	

5 MHz	1RB High (24)	713.5	24.02	23.16	22.12	
		707.5	23.95	23.17	22.07	
		701.5	23.98	23.19	22.10	
	1RB Middle (12)	713.5	24.10	23.31	22.21	
		707.5	24.15	23.38	22.27	
		701.5	24.15	23.35	22.27	
	1RB Low (0)	713.5	23.99	23.19	22.10	
		707.5	23.98	23.19	22.12	
		701.5	24.01	23.17	22.10	
	12RB High (13)	713.5	22.95	21.93	20.97	
		707.5	23.09	22.06	21.09	
		701.5	22.95	21.95	20.98	
	12RB Middle (6)	713.5	23.07	22.04	21.09	
		707.5	23.09	22.11	21.13	
		701.5	23.08	22.08	21.10	
	12RB Low (0)	713.5	23.09	22.07	21.14	
		707.5	23.12	22.09	21.17	
		701.5	23.04	22.02	21.08	
	25RB (0)	713.5	23.05	22.04	21.06	
		707.5	23.10	22.13	21.14	
		701.5	23.01	22.02	21.02	
	10 MHz	1RB High (49)	711	23.96	23.24	22.08
			707.5	23.97	23.12	22.04
			704	24.00	23.25	22.11
1RB Middle (24)		711	24.10	23.34	22.19	
		707.5	24.08	23.35	22.26	
		704	24.11	23.38	22.23	
1RB Low (0)		711	24.04	23.31	22.15	
		707.5	24.03	23.28	22.13	
		704	24.05	23.30	22.21	
25RB High (25)		711	22.97	21.97	20.97	
		707.5	23.13	22.16	21.18	
		704	23.06	22.08	21.93	
25RB Middle (12)		711	23.08	22.07	21.12	
		707.5	23.11	22.13	21.16	
		704	23.12	22.08	21.91	
25RB Low (0)		711	23.05	22.04	21.06	
		707.5	23.15	22.19	21.22	
		704	23.20	22.20	21.92	
50RB (0)		711	23.00	22.02	21.03	
		707.5	23.18	22.19	21.20	
		704	23.15	22.14	21.20	

Band 14					
Bandwidth (MHz)	RB allocation	Frequency (MHz)	QPSK	16QAM	64QAM
	RB offset (Start RB)		Actual output power (dBm)	Actual output power (dBm)	Actual output power (dBm)
5 MHz	1RB High (24)	795.5	22.82	22.05	20.96
		793	22.83	22.03	21.00
		790.5	22.85	22.10	20.96
	1RB Middle (12)	795.5	23.03	22.26	21.13
		793	22.99	22.22	21.16
		790.5	23.04	22.33	21.16
	1RB Low (0)	795.5	22.85	22.04	21.04
		793	22.89	22.17	21.05
		790.5	22.86	22.20	21.00
	12RB High (13)	795.5	21.83	20.84	19.83
		793	21.87	20.85	19.88
		790.5	21.93	20.93	19.96
	12RB Middle (6)	795.5	21.97	20.96	19.96
		793	21.94	20.96	19.94
		790.5	21.98	20.99	20.00
	12RB Low (0)	795.5	21.95	20.97	19.99
		793	21.96	20.89	19.93
		790.5	21.95	20.93	19.97
	25RB (0)	795.5	21.92	20.93	19.91
		793	21.91	20.93	19.88
		790.5	21.94	20.95	19.94
10 MHz	1RB High (49)	793	22.86	22.01	21.00
	1RB Middle (24)	793	23.01	22.25	21.16
	1RB Low (0)	793	22.95	22.13	21.09
	25RB High (25)	793	21.93	20.91	19.90
	25RB Middle (12)	793	21.98	21.03	19.98
	25RB Low (0)	793	22.02	21.01	20.01
	50RB (0)	793	21.97	20.95	19.96

Power Level A1

Band 30					
Bandwidth (MHz)	RB allocation RB offset (Start RB)	Frequency (MHz)	QPSK	16QAM	64QAM
			Actual output power (dBm)	Actual output power (dBm)	Actual output power (dBm)
5 MHz	1RB High (24)	2312.5	23.58	22.86	21.84
		2310	23.60	22.88	21.83
		2307.5	23.60	22.77	21.75
	1RB Middle (12)	2312.5	23.72	22.98	21.85
		2310	23.73	22.97	21.99
		2307.5	23.77	22.95	21.89
	1RB Low (0)	2312.5	23.59	22.86	21.82
		2310	23.63	22.91	21.82
		2307.5	23.60	22.80	21.70
	12RB High (13)	2312.5	22.72	21.69	20.65
		2310	22.76	21.77	20.62
		2307.5	22.75	21.74	20.76
	12RB Middle (6)	2312.5	22.75	21.73	20.74
		2310	22.73	21.74	20.74
		2307.5	22.73	21.71	20.74
	12RB Low (0)	2312.5	22.70	21.70	20.67
		2310	22.65	21.63	20.62
		2307.5	22.64	21.63	20.63
	25RB (0)	2312.5	22.73	21.71	20.67
		2310	22.70	21.72	20.68
		2307.5	22.71	21.70	20.72
10 MHz	1RB High (49)	2310	23.03	22.34	21.24
	1RB Middle (24)	2310	23.13	22.36	21.32
	1RB Low (0)	2310	23.08	22.38	21.22
	25RB High (25)	2310	22.20	21.19	20.15
	25RB Middle (12)	2310	22.15	21.15	20.14
	25RB Low (0)	2310	22.05	21.07	20.05
	50RB (0)	2310	22.12	21.11	20.10

Power Level B1

Band 30					
Bandwidth (MHz)	RB allocation	Frequency (MHz)	QPSK	16QAM	64QAM
	RB offset (Start RB)		Actual output power (dBm)	Actual output power (dBm)	Actual output power (dBm)
5 MHz	1RB High (24)	2312.5	19.30	19.56	19.55
		2310	19.30	19.62	19.55
		2307.5	19.26	19.54	19.45
	1RB Middle (12)	2312.5	19.43	19.81	19.29
		2310	19.46	19.30	19.58
		2307.5	19.47	19.76	19.65
	1RB Low (0)	2312.5	19.30	19.67	19.48
		2310	19.28	19.56	19.55
		2307.5	19.25	19.59	19.51
	12RB High (13)	2312.5	19.32	19.30	19.32
		2310	19.36	19.40	19.41
		2307.5	19.37	19.37	19.39
	12RB Middle (6)	2312.5	19.41	19.38	19.43
		2310	19.37	19.37	19.39
		2307.5	19.36	19.39	19.38
	12RB Low (0)	2312.5	19.34	19.32	19.33
		2310	19.28	19.29	19.29
		2307.5	19.26	19.24	19.28
	25RB (0)	2312.5	19.32	19.32	19.33
		2310	19.31	19.35	19.33
		2307.5	19.31	19.35	19.33
10 MHz	1RB High (49)	2310	19.34	19.66	19.50
	1RB Middle (24)	2310	19.42	19.71	19.58
	1RB Low (0)	2310	19.36	19.75	19.53
	25RB High (25)	2310	19.38	19.41	19.39
	25RB Middle (12)	2310	19.36	19.36	19.38
	25RB Low (0)	2310	19.24	19.28	19.24
	50RB (0)	2310	19.29	19.32	19.30

Power Level C1

Band 30					
Bandwidth (MHz)	RB allocation RB offset (Start RB)	Frequency (MHz)	QPSK	16QAM	64QAM
			Actual output power (dBm)	Actual output power (dBm)	Actual output power (dBm)
5 MHz	1RB High (24)	2312.5	22.77	22.99	21.96
		2310	22.77	22.99	21.97
		2307.5	22.75	23.01	21.92
	1RB Middle (12)	2312.5	22.90	23.13	22.04
		2310	22.93	23.11	22.03
		2307.5	22.90	23.05	22.18
	1RB Low (0)	2312.5	22.73	22.94	21.93
		2310	22.76	23.03	21.89
		2307.5	22.75	23.00	21.91
	12RB High (13)	2312.5	22.85	21.82	20.82
		2310	22.87	21.89	20.83
		2307.5	22.90	21.86	20.90
	12RB Middle (6)	2312.5	22.88	21.83	20.87
		2310	22.86	21.87	20.87
		2307.5	22.86	21.86	20.86
	12RB Low (0)	2312.5	22.87	21.83	20.82
		2310	22.80	21.77	20.80
		2307.5	22.81	21.76	20.79
	25RB (0)	2312.5	22.86	21.85	20.82
		2310	22.83	21.84	20.80
		2307.5	22.83	21.86	20.83
10 MHz	1RB High (49)	2310	22.79	22.94	21.92
	1RB Middle (24)	2310	22.85	22.96	22.05
	1RB Low (0)	2310	22.80	23.00	21.94
	25RB High (25)	2310	22.90	21.90	20.85
	25RB Middle (12)	2310	22.85	21.87	20.82
	25RB Low (0)	2310	22.77	21.77	20.71
	50RB (0)	2310	22.84	21.84	20.77

11.3 Wi-Fi and BT Measurement result

The maximum output power of BT is 5.63dBm.

The maximum tune up of BT is 6dBm.

The average conducted power for Wi-Fi is as following:

802.11b(dBm)	
Channel\data rate	1Mbps
11(2462MHz)	19.82
6(2437MHz)	20.38
1(2412MHz)	20.23
Tune up	20.50
802.11g(dBm)	
Channel\data rate	6Mbps
11(2462MHz)	17.66
6(2437MHz)	18.14
1(2412MHz)	17.88
Tune up	18.50
802.11n(dBm)-20MHz	
Channel\data rate	MCS0
11(2462MHz)	16.53
6(2437MHz)	17.08
1(2412MHz)	16.90
Tune up	18.00

802.11n(dBm)-40MHz	
Channel\data rate	MCS0
38(5190 MHz)	13.18
46(5230 MHz)	13.39
54(5270 MHz)	13.36
62(5310 MHz)	13.31
102(5510 MHz)	13.36
110(5550 MHz)	13.51
118(5590 MHz)	13.76
126(5630 MHz)	13.71
134(5670 MHz)	13.56
142(5710 MHz)	13.82
151(5755 MHz)	13.67
159(5795 MHz)	13.79
Tune up	15.00

12 Simultaneous TX SAR Considerations

12.1 Transmit Antenna Separation Distances



Picture 12.1 Antenna Locations

12.2 SAR Measurement Positions

According to the KDB941225 D06 Hot Spot SAR v01, the edges with less than 2.5 cm distance to the antennas need to be tested for SAR.

SAR measurement positions						
Mode	Front	Rear	Left edge	Right edge	Top edge	Bottom edge
Main antenna	Yes	Yes	Yes	Yes	No	Yes
WLAN	Yes	Yes	No	Yes	Yes	No

12.3 Standalone SAR Test Exclusion Considerations

Standalone 1-g head or body SAR evaluation by measurement or numerical simulation is not required when the corresponding SAR Exclusion Threshold condition, listed below, is satisfied. The 1-g SAR test exclusion threshold for 100 MHz to 6 GHz at test separation distances ≤ 50 mm are determined by:

$[(\text{max. power of channel, including tune-up tolerance, mW}) / (\text{min. test separation distance, mm})] \cdot [\sqrt{f(\text{GHz})}] \leq 3.0$ for 1-g SAR, where

- $f(\text{GHz})$ is the RF channel transmit frequency in GHz
- Power and distance are rounded to the nearest mW and mm before calculation
- The result is rounded to one decimal place for comparison

Table 12.1: Standalone SAR test exclusion considerations

Band/Mode	F(GHz)	Position	SAR test exclusion threshold(mW)	RF output power		SAR test exclusion
				dBm	mW	
Bluetooth	2.441	Head	9.60	6	3.98	Yes
		Body	19.20	6	3.98	Yes
2.4GHz WLAN	2.45	Head	9.58	20.5	112.20	No
		Body	19.17	20.5	112.20	No
5GHz WLAN	5.2	Head	6.58	15	31.62	No
		Body	13.16	15	31.62	No
	5.3	Head	6.52	15	31.62	No
		Body	13.03	15	31.62	No
	5.6	Head	6.34	15	31.62	No
		Body	12.68	15	31.62	No
	5.8	Head	6.23	15	31.62	No
		Body	12.46	15	31.62	No

13 Evaluation of Simultaneous

Table 13.1: The sum of reported SAR values for main antenna and WiFi2.4G

	Position	Main antenna	WiFi	Sum
Highest reported SAR value for Head	Left hand, Cheek	0.38	0.61	0.99
Highest reported SAR value for Body	Rear 10mm	1.11	0.44	1.55
	Rear 15mm	1.31	0.19	1.50

Table 13.2: The sum of reported SAR values for main antenna and WiFi5G

	Position	Main antenna	WiFi	Sum
Highest reported SAR value for Head	Left hand, Tilt	0.27	0.76	1.03
Highest reported SAR value for Body	Rear 10mm	1.11	0.40	1.51
	Rear 15mm	1.31	0.21	1.52

Table 13.3: The sum of reported SAR values for main antenna + WiFi5G+BT

	Position	Main antenna	WiFi	BT	Sum
Highest reported SAR value for Head	Left hand, Tilt	0.27	0.76	0.17 ^[1]	1.03
Highest reported SAR value for Body	Rear 10mm	1.11	0.40	0.08 ^[1]	1.59
	Rear 15mm	1.31	0.21	0.06 ^[1]	1.58

[1] - Estimated SAR for Bluetooth (see the table 13.3)

Table 13.4: Estimated SAR for Bluetooth

Mode/Band	F (GHz)	Position	Distance (mm)	Upper limit of power *		Estimated _{1g} (W/kg)
				dBm	mW	
Bluetooth	2.441	Head	5	6	4.0	0.17
Bluetooth	2.441	Body	10	6	4.0	0.08
Bluetooth	2.441	Body	15	6	4.0	0.06

* - Maximum possible output power declared by manufacturer

When standalone SAR test exclusion applies to an antenna that transmits simultaneously with other antennas, the standalone SAR must be estimated according to following to determine simultaneous transmission SAR test exclusion:

$(\text{max. power of channel, including tune-up tolerance, mW}) / (\text{min. test separation distance, mm}) \cdot [\sqrt{f(\text{GHz})} / x] \text{ W/kg}$ for test separation distances $\leq 50 \text{ mm}$;

where $x = 7.5$ for 1-g SAR.

When the minimum test separation distance is $< 5 \text{ mm}$, a distance of 5 mm is applied to determine SAR test exclusion

Conclusion:

According to the above tables, the sum of reported SAR values is $< 1.6 \text{ W/kg}$. So the simultaneous transmission SAR with volume scans is not required.

14 SAR Test Result

It is determined by user manual for the distance between the EUT and the phantom bottom. The distance is 10 mm or 15mm and just applied to the condition of body worn accessory.

It is performed for all SAR measurements with area scan based 1-g SAR estimation (Fast SAR). A zoom scan measurement is added when the estimated 1-gSAR is the highest measured SAR in each exposure configuration, wireless mode and frequency band combination or more than 1.2W/kg.

The calculated SAR is obtained by the following formula:

$$\text{Reported SAR} = \text{Measured SAR} \times 10^{(P_{\text{Target}} - P_{\text{Measured}})/10}$$

Where P_{Target} is the power of manufacturing upper limit;

P_{Measured} is the measured power in chapter 11.

Table 14.1: Duty Cycle

Mode	Duty Cycle
WCDMA<E FDD	1:1

14.1 SAR result

Table 14.1-1: SAR Values (WCDMA 1900 MHz Band - Head)

Frequency		Side	Test Position	Figure No.	Conducted Power (dBm)	Max. tune-up Power (dBm)	Measured SAR(10g) (W/kg)	Reported SAR(10g) (W/kg)	Measured SAR(1g) (W/kg)	Reported SAR(1g) (W/kg)	Power Drift (dB)
Ch.	MHz										
9938	1907.6	Left	Touch	/	22.31	24.00	0.098	0.14	0.152	0.22	-0.16
9800	1880	Left	Touch	Fig.1	22.30	24.00	0.164	0.24	0.250	0.37	0.05
9662	1852.4	Left	Touch	/	22.28	24.00	0.099	0.15	0.149	0.22	0.09
9800	1880	Left	Tilt	/	22.30	24.00	0.078	0.12	0.121	0.18	0.04
9800	1880	Right	Touch	/	22.30	24.00	0.150	0.22	0.239	0.35	-0.06
9800	1880	Right	Tilt	/	22.30	24.00	0.062	0.09	0.092	0.14	0.09

Table 14.1-2: SAR Values (WCDMA 1900 MHz Band - Body)

Frequency		Test Position	Figure No.	Conducted Power (dBm)	Max. tune-up Power (dBm)	Measured SAR(10g) (W/kg)	Reported SAR(10g) (W/kg)	Measured SAR(1g) (W/kg)	Reported SAR(1g) (W/kg)	Power Drift (dB)
Ch.	MHz									
9800	1880	Front	/	18.38	20.00	0.181	0.26	0.313	0.45	0.09
9800	1880	Rear	/	18.38	20.00	0.238	0.35	0.435	0.63	0.13
9800	1880	Left	/	18.38	20.00	0.040	0.06	0.076	0.11	-0.11
9800	1880	Right	/	18.38	20.00	0.063	0.09	0.108	0.16	0.15
9938	1907.6	Bottom	/	18.32	20.00	0.328	0.48	0.605	0.89	0.14
9800	1880	Bottom	Fig.2	18.38	20.00	0.341	0.50	0.630	0.91	0.12
9662	1852.4	Bottom	/	18.36	20.00	0.338	0.49	0.624	0.91	0.09

Note1: The distance between the EUT and the phantom bottom is 10mm

Table 14.1-3: SAR Values (WCDMA 1900 MHz Band - Body)

Frequency		Test Position	Figure No.	Conducted Power (dBm)	Max. tune-up Power (dBm)	Measured SAR(10g) (W/kg)	Reported SAR(10g) (W/kg)	Measured SAR(1g) (W/kg)	Reported SAR(1g) (W/kg)	Power Drift (dB)
Ch.	MHz									
9800	1880	Front	/	22.30	24.00	0.292	0.43	0.478	0.71	-0.12
9938	1907.6	Rear	/	22.31	24.00	0.299	0.44	0.517	0.76	0.18
9800	1880	Rear		22.30	24.00	0.350	0.52	0.593	0.88	0.14
9662	1852.4	Rear	Fig.3	22.28	24.00	0.437	0.65	0.742	1.10	-0.09

Note1: The distance between the EUT and the phantom bottom is 15mm

Table 14.1-4: SAR Values (WCDMA 1700 MHz Band - Head)

Frequency		Side	Test Position	Figure No.	Conducted Power (dBm)	Max. tune-up Power (dBm)	Measured SAR(10g) (W/kg)	Reported SAR(10g) (W/kg)	Measured SAR(1g) (W/kg)	Reported SAR(1g) (W/kg)	Power Drift (dB)
Ch.	MHz										
Ambient Temperature: 22.9 °C Liquid Temperature: 22.3°C											
1412	1732.4	Left	Touch	/	22.54	24.00	0.138	0.19	0.204	0.29	0.11
1412	1732.4	Left	Tilt	/	22.54	24.00	0.083	0.12	0.120	0.17	0.05
1513	1752.6	Right	Touch	/	22.50	24.00	0.203	0.29	0.311	0.44	-0.18
1412	1732.4	Right	Touch	/	22.54	24.00	0.189	0.26	0.293	0.41	0.09
1312	1712.4	Right	Touch	Fig.4	22.53	24.00	0.202	0.28	0.312	0.44	-0.14
1412	1732.4	Right	Tilt	/	22.54	24.00	0.053	0.07	0.082	0.11	-0.17

Table 14.1-5: SAR Values (WCDMA 1700 MHz Band - Body)

Frequency		Test Position	Figure No.	Conducted Power (dBm)	Max. tune-up Power (dBm)	Measured SAR(10g) (W/kg)	Reported SAR(10g) (W/kg)	Measured SAR(1g) (W/kg)	Reported SAR(1g) (W/kg)	Power Drift (dB)
Ch.	MHz									
Ambient Temperature: 22.9 °C Liquid Temperature: 22.3°C										
1412	1732.5	Front	/	20.72	22.00	0.255	0.34	0.421	0.57	0.15
1412	1732.5	Rear	/	20.72	22.00	0.299	0.40	0.531	0.71	-0.18
1412	1732.5	Left	/	20.72	22.00	0.054	0.07	0.090	0.12	0.02
1412	1732.5	Right	/	20.72	22.00	0.067	0.09	0.113	0.15	-0.02
1513	1752.6	Bottom	/	20.68	22.00	0.449	0.61	0.811	1.10	-0.17
1412	1732.5	Bottom	/	20.72	22.00	0.463	0.62	0.833	1.12	-0.03
1312	1712.4	Bottom	Fig.5	20.68	22.00	0.474	0.64	0.856	1.16	0.15

Note1: The distance between the EUT and the phantom bottom is 10mm

Table 14.1-6: SAR Values (WCDMA 1700 MHz Band - Body)

Frequency		Test Position	Figure No.	Conducted Power (dBm)	Max. tune-up Power (dBm)	Measured SAR(10g) (W/kg)	Reported SAR(10g) (W/kg)	Measured SAR(1g) (W/kg)	Reported SAR(1g) (W/kg)	Power Drift (dB)
Ch.	MHz									
Ambient Temperature: 22.9 °C Liquid Temperature: 22.3°C										
1412	1732.5	Front	/	22.54	24.00	0.192	0.27	0.307	0.43	-0.10
1513	1752.6	Rear	/	22.50	24.00	0.187	0.26	0.300	0.42	0.15
1412	1732.5	Rear	/	22.54	24.00	0.193	0.27	0.310	0.43	0.17
1312	1712.4	Rear	Fig.6	22.53	24.00	0.209	0.29	0.339	0.48	-0.05

Note1: The distance between the EUT and the phantom bottom is 15mm

Table 14.1-7: SAR Values (WCDMA 850 MHz Band - Head)

Ambient Temperature: 23.2 °C						Liquid Temperature: 22.6 °C					
Frequency		Side	Test Position	Figure No.	Conducted Power (dBm)	Max. tune-up Power (dBm)	Measured SAR(10g) (W/kg)	Reported SAR(10g) (W/kg)	Measured SAR(1g) (W/kg)	Reported SAR(1g) (W/kg)	Power Drift (dB)
Ch.	MHz										
4233	846.6	Left	Touch	/	22.39	24.00	0.168	0.24	0.205	0.30	0.10
4182	836.4	Left	Touch	Fig.7	22.39	24.00	0.190	0.28	0.242	0.35	0.14
4132	826.4	Left	Touch	/	22.43	24.00	0.161	0.23	0.204	0.29	0.12
4182	836.4	Left	Tilt	/	22.39	24.00	0.139	0.20	0.171	0.25	0.10
4182	836.4	Right	Touch	/	22.39	24.00	0.159	0.23	0.201	0.29	-0.07
4182	836.4	Right	Tilt	/	22.39	24.00	0.091	0.13	0.110	0.16	-0.10

Table 14.1-8: SAR Values (WCDMA 850 MHz Band - Body)

Ambient Temperature: 23.2 °C						Liquid Temperature: 22.6 °C				
Frequency		Test Position	Figure No.	Conducted Power (dBm)	Max. tune-up Power (dBm)	Measured SAR(10g) (W/kg)	Reported SAR(10g) (W/kg)	Measured SAR(1g) (W/kg)	Reported SAR(1g) (W/kg)	Power Drift (dB)
Ch.	MHz									
4182	836.4	Front	/	22.39	24.00	0.211	0.31	0.271	0.39	-0.17
4233	846.6	Rear	/	22.39	24.00	0.335	0.49	0.435	0.63	0.11
4182	836.4	Rear	/	22.39	24.00	0.345	0.50	0.449	0.65	-0.08
4132	826.4	Rear	Fig.8	22.43	24.00	0.352	0.51	0.456	0.65	0.07
4182	836.4	Left	/	22.39	24.00	0.234	0.34	0.329	0.48	-0.11
4182	836.4	Right	/	22.39	24.00	0.188	0.27	0.270	0.39	-0.19
4182	836.4	Bottom	/	22.39	24.00	0.043	0.06	0.074	0.11	-0.12

Note: The distance between the EUT and the phantom bottom is 10mm.

Table 14.1-9: SAR Values (LTE Band2 - Head)

Ambient Temperature: 23.1 °C						Liquid Temperature: 22.5 °C						
Frequency		Mode	Side	Test Position	Figure No.	Conducted Power (dBm)	Max. tune-up Power (dBm)	Measured SAR(10g) (W/kg)	Reported SAR(10g) (W/kg)	Measured SAR(1g) (W/kg)	Reported SAR(1g) (W/kg)	Power Drift (dB)
Ch.	MHz											
18700	1860	1RB_Mid	Left	Touch	/	23.78	24.50	0.194	0.23	0.297	0.35	0.13
18700	1860	1RB_Mid	Left	Tilt	/	23.78	24.50	0.138	0.16	0.226	0.27	0.07
18700	1860	1RB_Mid	Right	Touch	Fig.9	23.78	24.50	0.224	0.26	0.357	0.42	0.14
18700	1860	1RB_Mid	Right	Tilt	/	23.78	24.50	0.098	0.12	0.147	0.17	-0.06
18700	1860	50RB_Low	Left	Touch	/	22.86	23.50	0.148	0.17	0.233	0.27	-0.07
18700	1860	50RB_Low	Left	Tilt	/	22.86	23.50	0.101	0.12	0.164	0.19	-0.11
18700	1860	50RB_Low	Right	Touch	/	22.86	23.50	0.160	0.19	0.255	0.30	-0.02
18700	1860	50RB_Low	Right	Tilt	/	22.86	23.50	0.068	0.08	0.102	0.12	0.06

Note1: The LTE mode is QPSK_20MHz.

Table 14.1-10: SAR Values (LTE Band2 - Body)

Frequency		Mode	Test Position	Figure No.	Conduct ed Power (dBm)	Max. tune-up Power (dBm)	Measured SAR(10g) (W/kg)	Reported SAR(10g) (W/kg)	Measured SAR(1g) (W/kg)	Reported SAR(1g) (W/kg)	Power Drift (dB)
Ch.	MHz										
Ambient Temperature: 23.1 °C					Liquid Temperature: 22.5°C						
18700	1860	1RB_Mid	Front	/	21.60	22.50	0.314	0.39	0.555	0.68	-0.07
19100	1900	1RB_Mid	Rear	/	21.50	22.50	0.442	0.56	0.810	1.02	0.08
18900	1880	1RB_Mid	Rear	/	21.55	22.50	0.479	0.60	0.875	1.09	-0.18
18700	1860	1RB_Mid	Rear	/	21.60	22.50	0.491	0.60	0.892	1.10	0.19
18700	1860	1RB_Mid	Left	/	21.60	22.50	0.063	0.08	0.107	0.13	-0.11
18700	1860	1RB_Mid	Right	/	21.60	22.50	0.108	0.13	0.190	0.23	0.00
19100	1900	1RB_Mid	Bottom	/	21.50	22.50	0.483	0.61	0.893	1.12	0.01
18900	1880	1RB_Mid	Bottom	/	21.55	22.50	0.486	0.60	0.893	1.11	-0.03
18700	1860	1RB_Mid	Bottom	/	21.60	22.50	0.479	0.59	0.885	1.09	0.14
18700	1860	50RB_Low	Front	/	21.68	22.50	0.308	0.37	0.545	0.66	0.09
19100	1900	50RB_Low	Rear	/	21.68	22.50	0.499	0.60	0.917	1.11	0.08
18900	1880	50RB_Low	Rear	/	21.63	22.50	0.470	0.57	0.835	1.02	-0.18
18700	1860	50RB_Mid	Rear	/	21.61	22.50	0.458	0.56	0.817	1.00	-0.04
18700	1860	50RB_Low	Left	/	21.68	22.50	0.060	0.07	0.103	0.12	-0.12
18700	1860	50RB_Low	Right	/	21.68	22.50	0.096	0.12	0.168	0.20	0.05
19100	1900	50RB_Low	Bottom	/	21.68	22.50	0.532	0.64	0.992	1.20	-0.01
18900	1880	50RB_Low	Bottom	Fig.10	21.63	22.50	0.547	0.67	1.020	1.25	0.14
18700	1860	50RB_Mid	Bottom	/	21.61	22.50	0.528	0.65	0.983	1.21	0.19
18700	1860	100RB	Rear	/	21.59	22.50	0.458	0.56	0.841	1.04	-0.14
18700	1860	100RB	Bottom	/	21.59	22.50	0.512	0.63	0.955	1.18	0.13
18900	1880	50RB_Low	Bottom	Headset	21.63	22.50	0.521	0.64	0.979	1.20	0.17

Note1: The distance between the EUT and the phantom bottom is 10mm

Note2: The LTE mode is QPSK_20MHz.

Table 14.1-11: SAR Values (LTE Band2 - Body)

Frequency		Mode	Test Position	Figure No.	Conducted Power (dBm)	Max. tune-up Power (dBm)	Measured SAR(10g) (W/kg)	Reported SAR(10g) (W/kg)	Measured SAR(1g) (W/kg)	Reported SAR(1g) (W/kg)	Power Drift (dB)
Ch.	MHz										
Ambient Temperature: 23.1 °C Liquid Temperature: 22.5°C											
18700	1860	1RB_Mid	Front	/	23.78	24.50	0.315	0.37	0.518	0.61	-0.10
19100	1900	1RB_Mid	Rear		23.72	24.50	0.362	0.43	0.617	0.74	-0.15
18900	1880	1RB_Mid	Rear		23.72	24.50	0.393	0.47	0.674	0.81	0.01
18700	1860	1RB_Mid	Rear	Fig.11	23.78	24.50	0.426	0.50	0.733	0.87	0.11
18700	1860	50RB_High	Front	/	22.86	23.50	0.243	0.28	0.400	0.46	0.02
18700	1860	50RB_High	Rear	/	22.86	23.50	0.289	0.33	0.493	0.57	-0.10
18900	1880	100RB	Rear		22.75	23.50	0.294	0.35	0.514	0.61	0.16

Note1: The distance between the EUT and the phantom bottom is 15mm

Note2: The LTE mode is QPSK_20MHz.

Table 14.1-12: SAR Values (LTE Band4 - Head)

Frequency		Mode	Side	Test Position	Figure No.	Conducted Power (dBm)	Max. tune-up Power (dBm)	Measured SAR(10g) (W/kg)	Reported SAR(10g) (W/kg)	Measured SAR(1g) (W/kg)	Reported SAR(1g) (W/kg)	Power Drift (dB)
Ch.	MHz											
Ambient Temperature: 23.1 °C Liquid Temperature: 22.5°C												
20050	1720	1RB_Mid	Left	Touch	/	23.74	24.50	0.085	0.10	0.125	0.15	-0.18
20050	1720	1RB_Mid	Left	Tilt	/	23.74	24.50	0.077	0.09	0.114	0.14	-0.08
20050	1720	1RB_Mid	Right	Touch	Fig.12	23.74	24.50	0.177	0.21	0.273	0.33	-0.13
20050	1720	1RB_Mid	Right	Tilt	/	23.74	24.50	0.059	0.07	0.097	0.12	-0.03
20050	1720	50RB_High	Left	Touch	/	22.73	23.50	0.074	0.09	0.112	0.13	0.11
20050	1720	50RB_High	Left	Tilt	/	22.73	23.50	0.055	0.07	0.086	0.10	0.04
20050	1720	50RB_High	Right	Touch	/	22.73	23.50	0.143	0.17	0.222	0.27	0.13
20050	1720	50RB_High	Right	Tilt	/	22.73	23.50	0.054	0.06	0.085	0.10	0.06

Note1: The LTE mode is QPSK_20MHz.

Table 14.1-13: SAR Values (LTE Band4 - Body)

Frequency		Mode	Test Position	Figure No.	Conducted Power (dBm)	Max. tune-up Power (dBm)	Measured SAR(10g) (W/kg)	Reported SAR(10g) (W/kg)	Measured SAR(1g) (W/kg)	Reported SAR(1g) (W/kg)	Power Drift (dB)
Ch.	MHz										
Ambient Temperature: 23.1 °C Liquid Temperature: 22.5°C											
20050	1720	1RB_Mid	Front	/	21.60	22.50	0.249	0.31	0.398	0.49	-0.07
20050	1720	1RB_Mid	Rear	/	21.60	22.50	0.329	0.40	0.582	0.72	-0.10
20050	1720	1RB_Mid	Left	/	21.60	22.50	0.047	0.06	0.077	0.09	0.13
20050	1720	1RB_Mid	Right	/	21.60	22.50	0.073	0.09	0.117	0.14	-0.06
20300	1745	1RB_Mid	Bottom	/	21.56	22.50	0.445	0.55	0.797	0.99	0.14

20175	1732.5	1RB_Mid	Bottom	/	21.59	22.50	0.465	0.57	0.834	1.03	0.19
20050	1720	1RB_Mid	Bottom	/	21.60	22.50	0.484	0.60	0.866	1.07	-0.14
20050	1720	50RB_High	Front	/	21.61	22.50	0.258	0.32	0.413	0.51	0.10
20050	1720	50RB_High	Rear	/	21.61	22.50	0.337	0.41	0.598	0.73	0.13
20050	1720	50RB_High	Left	/	21.61	22.50	0.051	0.06	0.083	0.10	0.12
20050	1720	50RB_High	Right	/	21.61	22.50	0.078	0.10	0.127	0.16	-0.11
20300	1745	50RB_Mid	Bottom	/	21.60	22.50	0.476	0.59	0.860	1.06	0.14
20175	1732.5	50RB_Low	Bottom	/	21.59	22.50	0.468	0.58	0.844	1.04	-0.16
20050	1720	50RB_High	Bottom	Fig.13	21.61	22.50	0.520	0.64	0.939	1.15	0.17
20050	1720	100RB	Bottom	/	21.60	22.50	0.514	0.63	0.929	1.14	0.06

Note1: The distance between the EUT and the phantom bottom is 10mm

Note2: The LTE mode is QPSK_20MHz.

Table 14.1-14: SAR Values (LTE Band4 - Body)

Ambient Temperature: 23.1 °C						Liquid Temperature: 22.5°C					
Frequency		Mode	Test Position	Figure No.	Conduct ed Power (dBm)	Max. tune-up Power (dBm)	Measured SAR(10g) (W/kg)	Reported SAR(10g) (W/kg)	Measured SAR(1g) (W/kg)	Reported SAR(1g) (W/kg)	Power Drift (dB)
Ch.	MHz										
20050	1720	1RB_Mid	Front	/	23.74	24.50	0.243	0.29	0.382	0.46	0.08
20050	1720	1RB_Mid	Rear	Fig.14	23.74	24.50	0.266	0.32	0.437	0.52	-0.14
20050	1720	50RB_High	Front	/	22.73	23.50	0.198	0.24	0.310	0.37	-0.15
20050	1720	50RB_High	Rear	/	22.73	23.50	0.214	0.26	0.352	0.42	0.03

Table 14.1-15: SAR Values (LTE Band5 - Head)

Ambient Temperature: 23.2°C						Liquid Temperature: 22.6°C						
Frequency		Mode	Side	Test Position	Figure No.	Conduct ed Power (dBm)	Max. tune-up Power (dBm)	Measured SAR(10g) (W/kg)	Reported SAR(10g) (W/kg)	Measured SAR(1g) (W/kg)	Reported SAR(1g) (W/kg)	Power Drift (dB)
Ch.	MHz											
20450	829	1RB_Mid	Left	Touch	Fig.15	23.99	25.00	0.239	0.30	0.304	0.38	0.12
20450	829	1RB_Mid	Left	Tilt	/	23.99	25.00	0.151	0.19	0.186	0.23	0.04
20450	829	1RB_Mid	Right	Touch	/	23.99	25.00	0.186	0.23	0.235	0.30	-0.10
20450	829	1RB_Mid	Right	Tilt	/	23.99	25.00	0.142	0.18	0.172	0.22	-0.07
20525	836.5	25RB_High	Left	Touch	/	23.08	24.00	0.174	0.22	0.220	0.27	-0.06
20525	836.5	25RB_High	Left	Tilt	/	23.08	24.00	0.239	0.30	0.304	0.38	-0.08
20525	836.5	25RB_High	Right	Touch	/	23.08	24.00	0.152	0.19	0.190	0.23	0.03
20525	836.5	25RB_High	Right	Tilt	/	23.08	24.00	0.127	0.16	0.154	0.19	-0.10

Note1: The LTE mode is QPSK_10MHz.

Table 14.1-16: SAR Values (LTE Band5 - Body)

Ambient Temperature: 23.2°C						Liquid Temperature: 22.6°C					
Frequency		Mode	Test Position	Figure No.	Conducted Power (dBm)	Max. tune-up Power (dBm)	Measured SAR(10g) (W/kg)	Reported SAR(10g) (W/kg)	Measured SAR(1g) (W/kg)	Reported SAR(1g) (W/kg)	Power Drift (dB)
Ch.	MHz										
20450	829	1RB_Mid	Front	/	23.99	25.00	0.251	0.32	0.325	0.41	-0.05
20450	829	1RB_Mid	Rear	Fig.16	23.99	25.00	0.426	0.54	0.549	0.69	-0.13
20450	829	1RB_Mid	Left	/	23.99	25.00	0.287	0.36	0.394	0.50	-0.12
20450	829	1RB_Mid	Right	/	23.99	25.00	0.231	0.29	0.319	0.40	-0.04
20450	829	1RB_Mid	Bottom	/	23.99	25.00	0.046	0.06	0.086	0.11	0.02
20525	836.5	25RB_High	Front	/	23.08	24.00	0.216	0.27	0.276	0.34	-0.05
20525	836.5	25RB_High	Rear	/	23.08	24.00	0.290	0.36	0.374	0.46	-0.19
20525	836.5	25RB_High	Left	/	23.08	24.00	0.204	0.25	0.290	0.36	-0.06
20525	836.5	25RB_High	Right	/	23.08	24.00	0.172	0.21	0.241	0.30	0.01
20525	836.5	25RB_High	Bottom	/	23.08	24.00	0.040	0.05	0.077	0.10	-0.03

Note1: The distance between the EUT and the phantom bottom is 10mm.

Note2: The LTE mode is QPSK_10MHz.

Table 14.1-17: SAR Values (LTE Band12 - Head)

Ambient Temperature: 22.8°C						Liquid Temperature: 22.1°C						
Frequency		Mode	Side	Test Position	Figure No.	Conduct ed Power (dBm)	Max. tune-up Power (dBm)	Measured SAR(10g) (W/kg)	Reported SAR(10g) (W/kg)	Measured SAR(1g) (W/kg)	Reported SAR(1g) (W/kg)	Power Drift (dB)
Ch.	MHz											
23060	704	1RB_Mid	Left	Touch	Fig.17	24.11	25.00	0.227	0.28	0.288	0.35	-0.09
23060	704	1RB_Mid	Left	Tilt	/	24.11	25.00	0.137	0.17	0.172	0.21	-0.19
23060	704	1RB_Mid	Right	Touch	/	24.11	25.00	0.173	0.21	0.219	0.27	0.08
23060	704	1RB_Mid	Right	Tilt	/	24.11	25.00	0.138	0.17	0.168	0.21	-0.12
23060	704	25RB_Low	Left	Touch	/	23.20	24.00	0.180	0.22	0.229	0.28	0.07
23060	704	25RB_Low	Left	Tilt	/	23.20	24.00	0.108	0.13	0.133	0.16	-0.05
23060	704	25RB_Low	Right	Touch	/	23.20	24.00	0.138	0.17	0.175	0.21	-0.18
23060	704	25RB_Low	Right	Tilt	/	23.20	24.00	0.109	0.13	0.133	0.16	0.04

Note1: The LTE mode is QPSK_10MHz.

Table 14.1-18: SAR Values (LTE Band12 - Body)

Ambient Temperature: 22.8 °C						Liquid Temperature: 22.1 °C					
Frequency		Mode	Test Position	Figure No.	Conducted Power (dBm)	Max. tune-up Power (dBm)	Measured SAR(10g) (W/kg)	Reported SAR(10g) (W/kg)	Measured SAR(1g) (W/kg)	Reported SAR(1g) (W/kg)	Power Drift (dB)
Ch.	MHz										
23060	704	1RB_Mid	Front	/	24.11	25.00	0.205	0.25	0.263	0.32	-0.07
23060	704	1RB_Mid	Rear	Fig.18	24.11	25.00	0.293	0.36	0.376	0.46	-0.01
23060	704	1RB_Mid	Left	/	24.11	25.00	0.225	0.28	0.311	0.38	0.11
23060	704	1RB_Mid	Right	/	24.11	25.00	0.215	0.26	0.299	0.37	-0.05
23060	704	1RB_Mid	Bottom	/	24.11	25.00	0.045	0.06	0.095	0.12	-0.08
23060	704	25RB_Low	Front	/	23.20	24.00	0.168	0.20	0.215	0.26	-0.03
23060	704	25RB_Low	Rear	/	23.20	24.00	0.244	0.29	0.314	0.38	-0.03
23060	704	25RB_Low	Left	/	23.20	24.00	0.186	0.22	0.257	0.31	0.04
23060	704	25RB_Low	Right	/	23.20	24.00	0.177	0.21	0.247	0.30	0.03
23060	704	25RB_Low	Bottom	/	23.20	24.00	0.033	0.04	0.069	0.08	-0.02

Note1: The distance between the EUT and the phantom bottom is 10mm.

Note2: The LTE mode is QPSK_10MHz.

Table 14.1-19: SAR Values (LTE Band14 - Head)

Ambient Temperature: 22.8 °C						Liquid Temperature: 22.1 °C						
Frequency		Mode	Side	Test Position	Figure No.	Conduct ed Power (dBm)	Max. tune-up Power (dBm)	Measured SAR(10g) (W/kg)	Reported SAR(10g) (W/kg)	Measured SAR(1g) (W/kg)	Reported SAR(1g) (W/kg)	Power Drift (dB)
Ch.	MHz											
23330	793	1RB_Mid	Left	Touch	Fig.19	23.01	24.00	0.177	0.22	0.225	0.28	0.08
23330	793	1RB_Mid	Left	Tilt	/	23.01	24.00	0.095	0.12	0.118	0.15	-0.16
23330	793	1RB_Mid	Right	Touch	/	23.01	24.00	0.153	0.19	0.193	0.24	0.10
23330	793	1RB_Mid	Right	Tilt	/	23.01	24.00	0.102	0.13	0.123	0.15	-0.17
23330	793	25RB_Low	Left	Touch	/	22.02	23.00	0.139	0.17	0.177	0.22	0.07
23330	793	25RB_Low	Left	Tilt	/	22.02	23.00	0.076	0.10	0.094	0.12	0.04
23330	793	25RB_Low	Right	Touch	/	22.02	23.00	0.121	0.15	0.151	0.19	0.07
23330	793	25RB_Low	Right	Tilt	/	22.02	23.00	0.086	0.11	0.102	0.13	-0.13

Note1: The LTE mode is QPSK_10MHz.

Table 14.1-20: SAR Values (LTE Band14 - Body)

Ambient Temperature: 22.8 °C						Liquid Temperature: 22.1 °C					
Frequency		Mode	Test Position	Figure No.	Conducted Power (dBm)	Max. tune-up Power (dBm)	Measured SAR(10g) (W/kg)	Reported SAR(10g) (W/kg)	Measured SAR(1g) (W/kg)	Reported SAR(1g) (W/kg)	Power Drift (dB)
Ch.	MHz										
23330	793	1RB_Mid	Front	/	23.01	24.00	0.189	0.24	0.245	0.31	-0.07
23330	793	1RB_Mid	Rear	Fig.20	23.01	24.00	0.307	0.39	0.396	0.50	0.02
23330	793	1RB_Mid	Left	/	23.01	24.00	0.217	0.27	0.302	0.38	-0.06
23330	793	1RB_Mid	Right	/	23.01	24.00	0.172	0.22	0.239	0.30	0.11
23330	793	1RB_Mid	Bottom	/	23.01	24.00	0.034	0.04	0.062	0.08	-0.07
23330	793	25RB_Low	Front	/	22.02	23.00	0.154	0.19	0.198	0.25	0.10
23330	793	25RB_Low	Rear	/	22.02	23.00	0.252	0.32	0.325	0.41	-0.04
23330	793	25RB_Low	Left	/	22.02	23.00	0.174	0.22	0.242	0.30	0.04
23330	793	25RB_Low	Right	/	22.02	23.00	0.139	0.17	0.194	0.24	-0.15
23330	793	25RB_Low	Bottom	/	22.02	23.00	0.027	0.03	0.049	0.06	-0.12

Note1: The distance between the EUT and the phantom bottom is 10mm.

Note2: The LTE mode is QPSK_10MHz.

Table 14.1-21: SAR Values (LTE Band30 - Head)

Ambient Temperature: 23.1 °C						Liquid Temperature: 22.5 °C						
Frequency		Mode	Side	Test Position	Figure No.	Conduct ed Power (dBm)	Max. tune-up Power (dBm)	Measured SAR(10g) (W/kg)	Reported SAR(10g) (W/kg)	Measured SAR(1g) (W/kg)	Reported SAR(1g) (W/kg)	Power Drift (dB)
Ch.	MHz											
27710	2310	1RB_Mid	Left	Touch	/	23.13	24.50	0.041	0.06	0.074	0.10	0.04
27710	2310	1RB_Mid	Left	Tilt	/	23.13	24.50	0.069	0.09	0.125	0.17	-0.03
27710	2310	1RB_Mid	Right	Touch	Fig.21	23.13	24.50	0.102	0.14	0.189	0.26	-0.15
27710	2310	1RB_Mid	Right	Tilt	/	23.13	24.50	0.032	0.04	0.057	0.08	-0.01
27710	2310	25RB_Mid	Left	Touch	/	22.20	23.50	0.037	0.05	0.062	0.08	0.01
27710	2310	25RB_Mid	Left	Tilt	/	22.20	23.50	0.051	0.07	0.094	0.13	-0.04
27710	2310	25RB_Mid	Right	Touch	/	22.20	23.50	0.078	0.11	0.142	0.19	0.04
27710	2310	25RB_Mid	Right	Tilt	/	22.20	23.50	0.026	0.04	0.046	0.06	-0.03

Note1: The LTE mode is QPSK_10MHz.

Table 14.1-22: SAR Values (LTE Band30 - Body)

Frequency		Mode	Test Position	Figure No.	Conduct ed Power (dBm)	Max. tune-up Power (dBm)	Measured SAR(10g) (W/kg)	Reported SAR(10g) (W/kg)	Measured SAR(1g) (W/kg)	Reported SAR(1g) (W/kg)	Power Drift (dB)	
Ch.	MHz											
		Ambient Temperature: 23.1 °C					Liquid Temperature: 22.5°C					
27710	2310	1RB_Mid	Front	/	19.42	20.00	0.159	0.18	0.295	0.34	0.04	
27710	2310	1RB_Mid	Rear	Fig.22	19.42	20.00	0.460	0.53	0.948	1.08	-0.07	
27710	2310	1RB_Mid	Left	/	19.42	20.00	0.041	0.05	0.069	0.08	0.17	
27710	2310	1RB_Mid	Right	/	19.42	20.00	0.050	0.06	0.083	0.09	-0.14	
27710	2310	1RB_Mid	Bottom	/	19.42	20.00	0.307	0.35	0.601	0.69	0.12	
27710	2310	25RB_Mid	Front	/	19.38	20.00	0.158	0.18	0.283	0.33	-0.04	
27710	2310	25RB_Mid	Rear	/	19.38	20.00	0.451	0.52	0.895	1.03	-0.12	
27710	2310	25RB_Mid	Left	/	19.38	20.00	0.038	0.04	0.063	0.07	-0.06	
27710	2310	25RB_Mid	Right	/	19.38	20.00	0.050	0.06	0.079	0.09	-0.10	
27710	2310	25RB_Mid	Bottom	/	19.38	20.00	0.304	0.35	0.568	0.66	-0.06	
27710	2310	100RB	Rear	/	19.29	20.00	0.442	0.52	0.871	1.03	0.17	
27710	2310	1RB_Mid	Rear	Headset	19.42	20.00	0.429	0.49	0.857	0.98	0.15	

Note1: The distance between the EUT and the phantom bottom is 10mm.

Note2: The LTE mode is QPSK_10MHz.

Table 14.1-23: SAR Values (LTE Band30 - Body)

Frequency		Mode	Test Position	Figure No.	Conduct ed Power (dBm)	Max. tune-up Power (dBm)	Measured SAR(10g) (W/kg)	Reported SAR(10g) (W/kg)	Measured SAR(1g) (W/kg)	Reported SAR(1g) (W/kg)	Power Drift (dB)	
Ch.	MHz											
		Ambient Temperature: 22.9 °C					Liquid Temperature: 22.4°C					
27710	2310	1RB_Mid	Front	/	22.85	23.50	0.220	0.26	0.403	0.47	0.13	
27710	2310	1RB_Mid	Rear	Fig.23	22.85	23.50	0.588	0.68	1.130	1.31	-0.08	
27710	2310	25RB_High	Front	/	22.90	23.50	0.212	0.24	0.385	0.44	0.14	
27710	2310	25RB_High	Rear	/	22.90	23.50	0.576	0.66	1.060	1.22	0.09	
27710	2310	100RB	Rear	/	22.84	23.50	0.561	0.65	1.010	1.18	0.19	
27710	2310	1RB_Mid	Rear	Headset	22.85	23.50	0.566	0.66	1.030	1.20	0.14	

Note1: The distance between the EUT and the phantom bottom is 15mm.

Note2: The LTE mode is QPSK_10MHz.

14.2 SAR results for Standard procedure

There is zoom scan measurement to be added for the highest measured SAR in each exposure configuration/band.

Table 14.2-1: SAR Values (WCDMA 1900 MHz Band - Head)

Frequency		Side	Test Position	Figure No.	Conducted Power (dBm)	Max. tune-up Power (dBm)	Measured SAR(10g) (W/kg)	Reported SAR(10g) (W/kg)	Measured SAR(1g) (W/kg)	Reported SAR(1g) (W/kg)	Power Drift (dB)
Ch.	MHz										
9800	1880	Left	Touch	Fig.1	22.30	24.00	0.164	0.24	0.250	0.37	0.05

Table 14.2-2: SAR Values (WCDMA 1900 MHz Band - Body)

Frequency		Test Position	Figure No.	Conducted Power (dBm)	Max. tune-up Power (dBm)	Measured SAR(10g) (W/kg)	Reported SAR(10g) (W/kg)	Measured SAR(1g) (W/kg)	Reported SAR(1g) (W/kg)	Power Drift (dB)
Ch.	MHz									
9800	1880	Bottom	Fig.2	18.38	20.00	0.341	0.50	0.630	0.91	0.12

Note1: The distance between the EUT and the phantom bottom is 10mm

Table 14.2-3: SAR Values (WCDMA 1900 MHz Band - Body)

Frequency		Test Position	Figure No.	Conducted Power (dBm)	Max. tune-up Power (dBm)	Measured SAR(10g) (W/kg)	Reported SAR(10g) (W/kg)	Measured SAR(1g) (W/kg)	Reported SAR(1g) (W/kg)	Power Drift (dB)
Ch.	MHz									
9662	1852.4	Rear	Fig.3	22.28	24.00	0.437	0.65	0.742	1.10	-0.09

Note1: The distance between the EUT and the phantom bottom is 15mm

Table 14.2-4: SAR Values (WCDMA 1700 MHz Band - Head)

Frequency		Side	Test Position	Figure No.	Conducted Power (dBm)	Max. tune-up Power (dBm)	Measured SAR(10g) (W/kg)	Reported SAR(10g) (W/kg)	Measured SAR(1g) (W/kg)	Reported SAR(1g) (W/kg)	Power Drift (dB)
Ch.	MHz										
1312	1712.4	Right	Touch	Fig.4	22.53	24.00	0.202	0.28	0.312	0.44	-0.14

Table 14.2-5: SAR Values (WCDMA 1700 MHz Band - Body)

Frequency		Test Position	Figure No.	Conducted Power (dBm)	Max. tune-up Power (dBm)	Measured SAR(10g) (W/kg)	Reported SAR(10g) (W/kg)	Measured SAR(1g) (W/kg)	Reported SAR(1g) (W/kg)	Power Drift (dB)
Ch.	MHz									
1312	1712.4	Bottom	Fig.5	20.68	22.00	0.474	0.64	0.856	1.16	0.15

Note1: The distance between the EUT and the phantom bottom is 10mm

Table 14.2-6: SAR Values (WCDMA 1700 MHz Band - Body)

Ambient Temperature: 22.9 °C						Liquid Temperature: 22.3 °C				
Frequency		Test Position	Figure No.	Conducted Power (dBm)	Max. tune-up Power (dBm)	Measured SAR(10g) (W/kg)	Reported SAR(10g) (W/kg)	Measured SAR(1g) (W/kg)	Reported SAR(1g) (W/kg)	Power Drift (dB)
Ch.	MHz									
1312	1712.4	Rear	Fig.6	22.53	24.00	0.209	0.29	0.339	0.48	-0.05

Note1: The distance between the EUT and the phantom bottom is 15mm

Table 14.2-7: SAR Values (WCDMA 850 MHz Band - Head)

Ambient Temperature: 23.2 °C						Liquid Temperature: 22.6 °C					
Frequency		Side	Test Position	Figure No.	Conducted Power (dBm)	Max. tune-up Power (dBm)	Measured SAR(10g) (W/kg)	Reported SAR(10g) (W/kg)	Measured SAR(1g) (W/kg)	Reported SAR(1g) (W/kg)	Power Drift (dB)
Ch.	MHz										
4182	836.4	Left	Touch	Fig.7	22.39	24.00	0.190	0.28	0.242	0.35	0.14

Table 14.2-8: SAR Values (WCDMA 850 MHz Band - Body)

Ambient Temperature: 23.2 °C						Liquid Temperature: 22.6 °C				
Frequency		Test Position	Figure No.	Conducted Power (dBm)	Max. tune-up Power (dBm)	Measured SAR(10g) (W/kg)	Reported SAR(10g) (W/kg)	Measured SAR(1g) (W/kg)	Reported SAR(1g) (W/kg)	Power Drift (dB)
Ch.	MHz									
4132	826.4	Rear	Fig.8	22.43	24.00	0.352	0.51	0.456	0.65	0.07

Note: The distance between the EUT and the phantom bottom is 10mm.

Table 14.2-9: SAR Values (LTE Band2 - Head)

Ambient Temperature: 23.1 °C						Liquid Temperature: 22.5 °C						
Frequency		Mode	Side	Test Position	Figure No.	Conducted Power (dBm)	Max. tune-up Power (dBm)	Measured SAR(10g) (W/kg)	Reported SAR(10g) (W/kg)	Measured SAR(1g) (W/kg)	Reported SAR(1g) (W/kg)	Power Drift (dB)
Ch.	MHz											
18700	1860	1RB_Mid	Right	Touch	Fig.9	23.78	24.50	0.224	0.26	0.357	0.42	0.14

Note1: The LTE mode is QPSK_20MHz.

Table 14.2-10: SAR Values (LTE Band2 - Body)

Ambient Temperature: 23.1 °C						Liquid Temperature: 22.5 °C					
Frequency		Mode	Test Position	Figure No.	Conducted Power (dBm)	Max. tune-up Power (dBm)	Measured SAR(10g) (W/kg)	Reported SAR(10g) (W/kg)	Measured SAR(1g) (W/kg)	Reported SAR(1g) (W/kg)	Power Drift (dB)
Ch.	MHz										
18900	1880	50RB_Low	Bottom	Fig.10	21.63	22.50	0.547	0.67	1.02	1.25	0.14

Note1: The distance between the EUT and the phantom bottom is 10mm

Note2: The LTE mode is QPSK_20MHz.

Table 14.2-11: SAR Values (LTE Band2 - Body)

Frequency		Mode	Test Position	Figure No.	Conducted Power (dBm)	Max. tune-up Power (dBm)	Measured SAR(10g) (W/kg)	Reported SAR(10g) (W/kg)	Measured SAR(1g) (W/kg)	Reported SAR(1g) (W/kg)	Power Drift (dB)
Ch.	MHz										
18700	1860	1RB_Mid	Rear	Fig.11	23.78	24.50	0.426	0.50	0.733	0.87	0.11

Note1: The distance between the EUT and the phantom bottom is 15mm

Note2: The LTE mode is QPSK_20MHz.

Table 14.2-12: SAR Values (LTE Band4 - Head)

Frequency		Mode	Side	Test Position	Figure No.	Conducted Power (dBm)	Max. tune-up Power (dBm)	Measured SAR(10g) (W/kg)	Reported SAR(10g) (W/kg)	Measured SAR(1g) (W/kg)	Reported SAR(1g) (W/kg)	Power Drift (dB)
Ch.	MHz											
20050	1720	1RB_Mid	Right	Touch	Fig.12	23.74	24.50	0.177	0.21	0.273	0.33	-0.13

Note1: The LTE mode is QPSK_20MHz.

Table 14.2-13: SAR Values (LTE Band4 - Body)

Frequency		Mode	Test Position	Figure No.	Conducted Power (dBm)	Max. tune-up Power (dBm)	Measured SAR(10g) (W/kg)	Reported SAR(10g) (W/kg)	Measured SAR(1g) (W/kg)	Reported SAR(1g) (W/kg)	Power Drift (dB)
Ch.	MHz										
20050	1720	50RB_High	Bottom	Fig.13	21.61	22.50	0.520	0.64	0.939	1.15	0.17

Note1: The distance between the EUT and the phantom bottom is 10mm

Note2: The LTE mode is QPSK_20MHz.

Table 14.2-14: SAR Values (LTE Band4 - Body)

Frequency		Mode	Test Position	Figure No.	Conducted Power (dBm)	Max. tune-up Power (dBm)	Measured SAR(10g) (W/kg)	Reported SAR(10g) (W/kg)	Measured SAR(1g) (W/kg)	Reported SAR(1g) (W/kg)	Power Drift (dB)
Ch.	MHz										
20050	1720	1RB_Mid	Rear	Fig.14	23.74	24.50	0.266	0.32	0.437	0.52	-0.14

Table 14.2-15: SAR Values (LTE Band5 - Head)

Ambient Temperature: 23.2°C						Liquid Temperature: 22.6°C						
Frequency		Mode	Side	Test Position	Figure No.	Conducted Power (dBm)	Max. tune-up Power (dBm)	Measured SAR(10g) (W/kg)	Reported SAR(10g) (W/kg)	Measured SAR(1g) (W/kg)	Reported SAR(1g) (W/kg)	Power Drift (dB)
Ch.	MHz											
20450	829	1RB_Mid	Left	Touch	Fig.15	23.99	25.00	0.239	0.30	0.304	0.38	0.12

Note1: The LTE mode is QPSK_10MHz.

Table 14.2-16: SAR Values (LTE Band5 - Body)

Ambient Temperature: 23.2°C						Liquid Temperature: 22.6°C					
Frequency		Mode	Test Position	Figure No.	Conducted Power (dBm)	Max. tune-up Power (dBm)	Measured SAR(10g) (W/kg)	Reported SAR(10g) (W/kg)	Measured SAR(1g) (W/kg)	Reported SAR(1g) (W/kg)	Power Drift (dB)
Ch.	MHz										
20450	829	1RB_Mid	Rear	Fig.16	23.99	25.00	0.426	0.54	0.549	0.69	-0.13

Note1: The distance between the EUT and the phantom bottom is 10mm.

Note2: The LTE mode is QPSK_10MHz.

Table 14.2-17: SAR Values (LTE Band12 - Head)

Ambient Temperature: 22.8 °C						Liquid Temperature: 22.1°C						
Frequency		Mode	Side	Test Position	Figure No.	Conducted Power (dBm)	Max. tune-up Power (dBm)	Measured SAR(10g) (W/kg)	Reported SAR(10g) (W/kg)	Measured SAR(1g) (W/kg)	Reported SAR(1g) (W/kg)	Power Drift (dB)
Ch.	MHz											
23060	704	1RB_Mid	Left	Touch	Fig.17	24.11	25.00	0.227	0.28	0.288	0.35	-0.09

Note1: The LTE mode is QPSK_10MHz.

Table 14.2-18: SAR Values (LTE Band12 - Body)

Ambient Temperature: 22.8 °C						Liquid Temperature: 22.1°C					
Frequency		Mode	Test Position	Figure No.	Conducted Power (dBm)	Max. tune-up Power (dBm)	Measured SAR(10g) (W/kg)	Reported SAR(10g) (W/kg)	Measured SAR(1g) (W/kg)	Reported SAR(1g) (W/kg)	Power Drift (dB)
Ch.	MHz										
23060	704	1RB_Mid	Rear	Fig.18	24.11	25.00	0.293	0.36	0.376	0.46	-0.01

Note1: The distance between the EUT and the phantom bottom is 10mm.

Note2: The LTE mode is QPSK_10MHz.

Table 14.2-19: SAR Values (LTE Band14 - Head)

Frequency		Mode	Side	Test Position	Figure No.	Conducted Power (dBm)	Max. tune-up Power (dBm)	Measured SAR(10g) (W/kg)	Reported SAR(10g) (W/kg)	Measured SAR(1g) (W/kg)	Reported SAR(1g) (W/kg)	Power Drift (dB)
Ch.	MHz											
23330	793	1RB_Mid	Left	Touch	Fig.19	23.01	24.00	0.177	0.22	0.225	0.28	0.08

Note1: The LTE mode is QPSK_10MHz.

Table 14.2-20: SAR Values (LTE Band14 - Body)

Frequency		Mode	Test Position	Figure No.	Conducted Power (dBm)	Max. tune-up Power (dBm)	Measured SAR(10g) (W/kg)	Reported SAR(10g) (W/kg)	Measured SAR(1g) (W/kg)	Reported SAR(1g) (W/kg)	Power Drift (dB)
Ch.	MHz										
23330	793	1RB_Mid	Rear	Fig.20	23.01	24.00	0.307	0.39	0.396	0.50	0.02

Note1: The distance between the EUT and the phantom bottom is 10mm.

Note2: The LTE mode is QPSK_10MHz.

Table 14.2-21: SAR Values (LTE Band30 - Head)

Frequency		Mode	Side	Test Position	Figure No.	Conducted Power (dBm)	Max. tune-up Power (dBm)	Measured SAR(10g) (W/kg)	Reported SAR(10g) (W/kg)	Measured SAR(1g) (W/kg)	Reported SAR(1g) (W/kg)	Power Drift (dB)
Ch.	MHz											
27710	2310	1RB_Mid	Right	Touch	Fig.21	23.13	24.50	0.102	0.14	0.189	0.26	-0.15

Note1: The LTE mode is QPSK_10MHz.

Table 14.2-22: SAR Values (LTE Band30 - Body)

Frequency		Mode	Test Position	Figure No.	Conducted Power (dBm)	Max. tune-up Power (dBm)	Measured SAR(10g) (W/kg)	Reported SAR(10g) (W/kg)	Measured SAR(1g) (W/kg)	Reported SAR(1g) (W/kg)	Power Drift (dB)
Ch.	MHz										
27710	2310	1RB_Mid	Rear	Fig.22	19.42	20.00	0.460	0.53	0.948	1.08	-0.07

Note1: The distance between the EUT and the phantom bottom is 10mm.

Note2: The LTE mode is QPSK_10MHz.

Table 14.2-23: SAR Values (LTE Band30 - Body)

Frequency		Mode	Test Position	Figure No.	Conducted Power (dBm)	Max. tune-up Power (dBm)	Measured SAR(10g) (W/kg)	Reported SAR(10g) (W/kg)	Measured SAR(1g) (W/kg)	Reported SAR(1g) (W/kg)	Power Drift (dB)
Ch.	MHz										
27710	2310	1RB_Mid	Rear	Fig.23	22.85	23.50	0.588	0.68	1.130	1.31	-0.08

Note1: The distance between the EUT and the phantom bottom is 15mm.

Note2: The LTE mode is QPSK_10MHz.

14.3 WLAN Evaluation for 2.4G

According to the KDB248227 D01, SAR is measured for 2.4GHz 802.11b DSSS using the initial test position procedure.

Head Evaluation

Table 14.3-1: SAR Values (WLAN - Head)– 802.11b (Fast SAR)

Frequency		Side	Test Position	Figure No.	Conducted Power (dBm)	Max. tune-up Power (dBm)	Measured SAR(10g) (W/kg)	Reported SAR(10g) (W/kg)	Measured SAR(1g) (W/kg)	Reported SAR(1g) (W/kg)	Power Drift (dB)
MHz	Ch.										
2437	6	Left	Touch	/	20.38	20.50	0.318	0.33	0.583	0.60	0.17
2437	6	Left	Tilt	/	20.38	20.50	0.310	0.32	0.593	0.61	0.02
2437	6	Right	Touch	/	20.38	20.50	0.215	0.22	0.359	0.37	0.13
2437	6	Right	Tilt	/	20.38	20.50	0.171	0.18	0.301	0.31	0.07

As shown above table, the initial test position for head is “Left Tilt”. So the head SAR of WLAN is presented as below:

Table 14.3-2: SAR Values (WLAN - Head)– 802.11b (Full SAR)

Frequency		Side	Test Position	Figure No.	Conducted Power (dBm)	Max. tune-up Power (dBm)	Measured SAR(10g) (W/kg)	Reported SAR(10g) (W/kg)	Measured SAR(1g) (W/kg)	Reported SAR(1g) (W/kg)	Power Drift (dB)
MHz	Ch.										
2437	6	Left	Touch	/	20.38	20.50	0.315	0.32	0.590	0.61	0.17
2437	6	Left	Tilt	Fig.24	20.38	20.50	0.294	0.30	0.613	0.63	0.02

Note1: When the reported SAR of the initial test position is > 0.4 W/kg, SAR is repeated for the 802.11 transmission mode configuration tested in the initial test position using subsequent highest estimated 1-g SAR conditions determined by area scans, on the highest maximum output power channel, until the reported SAR is \leq 0.8 W/kg.

Note2: For all positions/configurations tested using the initial test position and subsequent test positions, when the reported SAR is > 0.8 W/kg, SAR is measured for these test positions/configurations on the subsequent next highest measured output power channel until the reported SAR is \leq 1.2 W/kg or all required channels are tested.

According to the KDB248227 D01, The reported SAR must be scaled to 100% transmission duty factor to determine compliance at the maximum tune-up tolerance limit. The scaled reported SAR is presented as below.

Table 14.3-3: SAR Values (WLAN - Head) – 802.11b (Scaled Reported SAR)

Frequency		Side	Test Position	Actual duty factor	maximum duty factor	Reported SAR (1g)(W/kg)	Scaled reported SAR (1g)(W/kg)
MHz	Ch.						
		Ambient Temperature: 23.2°C		Liquid Temperature: 22.7°C			
2437	6	Left	Tilt	100%	100%	0.63	0.63

SAR is not required for OFDM because the 802.11b adjusted SAR ≤ 1.2 W/kg.

Body Evaluation

Table 14.3-4: SAR Values (WLAN - Body)– 802.11b (Fast SAR)

Frequency		Test Position	Figure No.	Conducted Power (dBm)	Max. tune-up Power (dBm)	Measured SAR(10g) (W/kg)	Reported SAR(10g) (W/kg)	Measured SAR(1g) (W/kg)	Reported SAR(1g)(W/kg)	Power Drift (dB)
MHz	Ch.									
		Ambient Temperature: 23.2°C		Liquid Temperature: 22.7°C						
2437	6	Front	/	20.38	20.50	0.095	0.10	0.167	0.17	0.01
2437	6	Rear	/	20.38	20.50	0.236	0.24	0.442	0.45	-0.12
2437	6	Right	/	20.38	20.50	0.079	0.08	0.150	0.15	0.14
2437	6	Top	/	20.38	20.50	0.051	0.05	0.097	0.10	0.19

As shown above table, the initial test position for body is “Rear”. So the body SAR of WLAN is presented as below:

Table 14.3-5: SAR Values (WLAN - Body)– 802.11b (Full SAR)

Frequency		Test Position	Figure No.	Conducted Power (dBm)	Max. tune-up Power (dBm)	Measured SAR(10g) (W/kg)	Reported SAR(10g) (W/kg)	Measured SAR(1g) (W/kg)	Reported SAR(1g)(W/kg)	Power Drift (dB)
MHz	Ch.									
		Ambient Temperature: 23.2°C		Liquid Temperature: 22.7°C						
2437	6	Front	/	20.38	20.50	0.090	0.09	0.160	0.16	0.01
2437	6	Rear	Fig.25	20.38	20.50	0.219	0.23	0.431	0.44	-0.12
2437	6	Rear	Note4	20.38	20.50	0.098	0.10	0.181	0.19	0.19

Note1: When the reported SAR of the initial test position is > 0.4 W/kg, SAR is repeated for the 802.11 transmission mode configuration tested in the initial test position using subsequent highest estimated 1-g SAR conditions determined by area scans, on the highest maximum output power channel, until the reported SAR is ≤ 0.8 W/kg.

Note2: For all positions/configurations tested using the initial test position and subsequent test positions, when the reported SAR is > 0.8 W/kg, SAR is measured for these test positions/configurations on the subsequent next highest measured output power channel until the reported SAR is ≤ 1.2 W/kg or all required channels are tested.

Note3: The distance between the EUT and the phantom bottom is 10mm.

Note4: The distance between the EUT and the phantom bottom is 15mm.

According to the KDB248227 D01, The reported SAR must be scaled to 100% transmission duty factor to determine compliance at the maximum tune-up tolerance limit. The scaled reported SAR is presented as below.

Table 14.3-6: SAR Values (WLAN - Body) – 802.11b (Scaled Reported SAR)

Frequency		Test Position	Actual duty factor	maximum duty factor	Reported SAR (1g)(W/kg)	Scaled reported SAR (1g)(W/kg)
MHz	Ch.					
2437	6	Rear	100%	100%	0.44	0.44

SAR is not required for OFDM because the 802.11b adjusted SAR ≤ 1.2 W/kg.

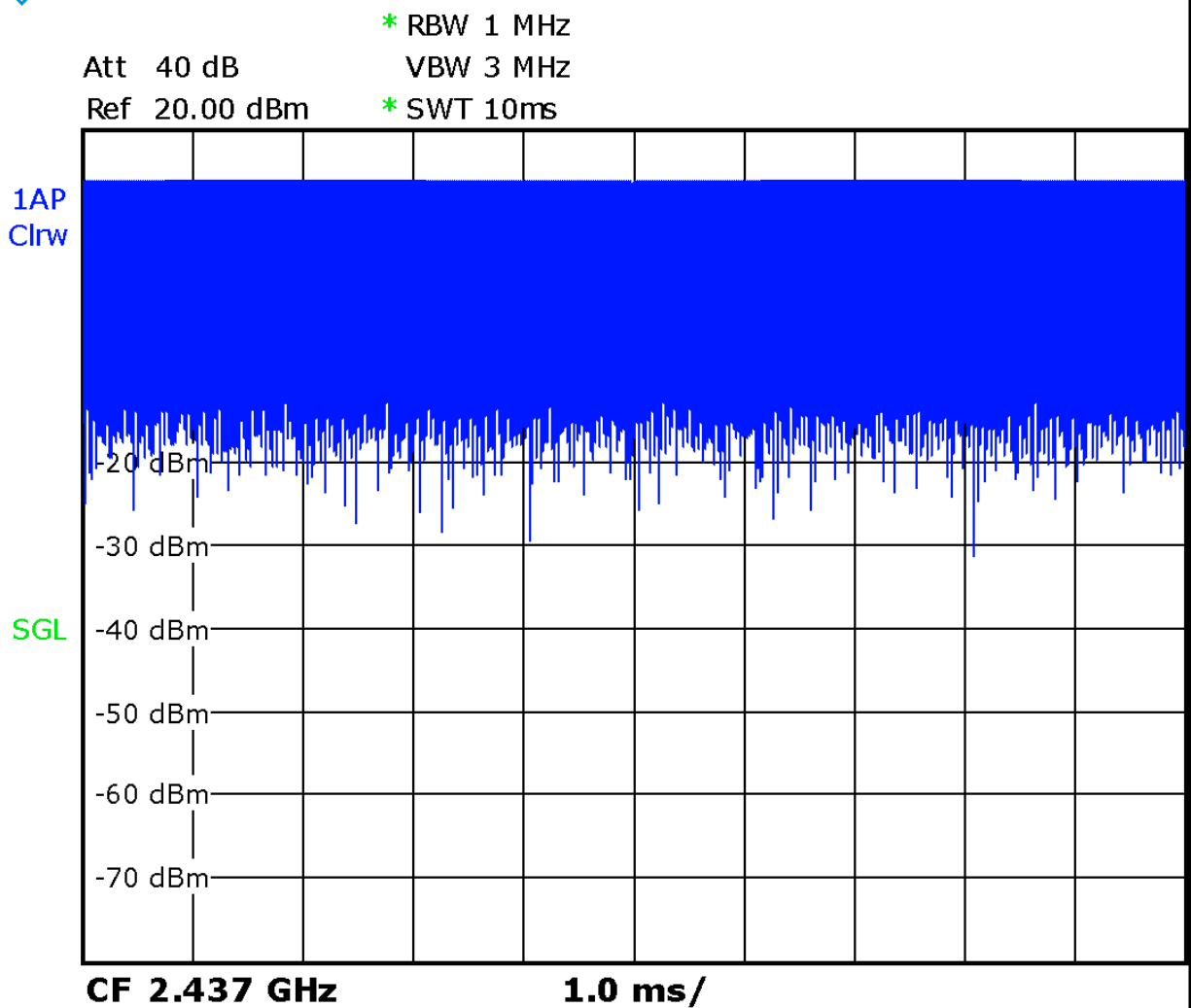

Picture 14.1 Duty factor plot

14.4 WLAN Evaluation For 5G

Table 14.4-1: OFDM mode specified maximum output power of WLAN antenna

802.11 mode	a	g	n		ac			
Ch. BW(MHz)	20	20	20	40	20	40	80	160
U-NII-1	X		X	X				
U-NII-2A	X		X	X				
U-NII-2C	X		X	X				
U-NII-3	X		X	X				
§ 15.247 (5.8 GHz)								

X: maximum(conducted) output power(mW), including tolerance, specified for production units

Table 14.4-2: Maximum output power specified of WLAN antenna

802.11 mode	a	g	n		ac			
Ch. BW(MHz)	20	20	20	40	20	40	80	160
U-NII-1	32		32	32				
U-NII-2A	32		32	32				
U-NII-2C	32		32	32				
U-NII-3	32		32	32				
§ 15.247 (5.8 GHz)								

- The maximum output power specified for production units is the same for all channels, modulations and data rates in each channel bandwidth configuration of the 802.11a/g/n/ac modes.
- The **blue highlighted** cells represent highest output configurations in each standalone or aggregated frequency band, with tune-up tolerance included.

Table 14.4-3: Maximum output power measured of WLAN antenna, for the applicable OFDM configurations according to the default power measurement procedures for selection initial test configurations

802.11 mode	a	n	
BW(MHz)	20	20	40
U-NII-1	36/40/44/48 Lower power	36/40/44/48 Lower power	38/46 21/22
U-NII-2A	52/56/60/64 Lower power	52/56/60/64 Lower power	54/62 22/21
U-NII-2C	100/104/108/112 116/120/124/128 132/136/140/144 Lower power	100/104/108/112 116/132/136/140 Lower power	102/110/118/126/134/142 22/22/24/23/23/24/23
U-NII-3	149/153/157/161/165 Lower power	149/153/157/161/165 Lower power	151/159 23/24

- The **bold numbers** is the maximum output measured power (mW).
- Channels with measured maximum power within 0.25dB are considered to have the same measured output. Channels selected for initial test configuration are **highlighted in yellow**.

Table 14.4-4: Reported SAR of initial test configuration for Head

802.11 mode	a	n	
BW(MHz)	20	20	40
U-NII-1	36/40/44/48	36/40/44/48	38/46 UNII-2A exclusion applied
U-NII-2A	52/56/60/64	52/56/60/64	54/62 0.47
U-NII-2C	100/104/108/112/116/120/124/128/ 132/136/140/144	100/104/108/112 116/132/136/140	102/110/118/126/134/142 0.76
U-NII-3	149/153/157/161/165	149/153/157/161/165	151/159 0.55

Highest measured output power channel tested initially are in **yellow highlight**.

The tune up of UNII-1 is less than UNII-2A. SAR is measured for UNII-2A band first. Adjusted SAR of UNII-2A band is ≤ 1.2 W/kg. SAR is not required for UNII-1 band.

Table 14.4-5: Reported SAR of initial test configuration for Body

802.11 mode	a	n	
BW(MHz)	20	20	40
U-NII-1	36/40/44/48	36/40/44/48	38/46 UNII-2A exclusion applied
U-NII-2A	52/56/60/64	52/56/60/64	54/62 0.23
U-NII-2C	100/104/108/112/116/120/124/128/ 132/136/140/144	100/104/108/112 116/132/136/140	102/110/118/126/134/142 0.44
U-NII-3	149/153/157/161/165	149/153/157/161/165	151/159 0.38

Highest measured output power channel tested initially are in **yellow highlight**.

The tune up of UNII-1 is less than UNII-2A. SAR is measured for UNII-2A band first. Adjusted SAR of UNII-2A band is ≤ 1.2 W/kg. SAR is not required for UNII-1 band.

Table 14.4-6: SAR Values (WLAN - Head)

Frequency		Side	Test Position	Figure No.	Conducted Power (dBm)	Max. tune-up Power (dBm)	Measured SAR(10g) (W/kg)	Reported SAR(10g) (W/kg)	Measured SAR(1g) (W/kg)	Reported SAR(1g) (W/kg)	Power Drift (dB)
MHz	Ch.										
54	5270	Left	Touch	/	13.36	15.00	0.074	0.11	0.274	0.40	0.05
54	5270	Left	Tilt	/	13.36	15.00	0.085	0.12	0.322	0.47	0.17
54	5270	Right	Touch	/	13.36	15.00	0.052	0.08	0.184	0.27	0.13
54	5270	Right	Tilt	/	13.36	15.00	0.063	0.09	0.226	0.33	0.10
118	5590	Left	Touch	/	13.76	15.00	0.100	0.13	0.354	0.47	-0.14
118	5590	Left	Tilt	Fig.26	13.76	15.00	0.153	0.20	0.574	0.76	0.13
118	5590	Right	Touch	/	13.76	15.00	0.084	0.11	0.262	0.35	0.08
118	5590	Right	Tilt	/	13.76	15.00	0.124	0.16	0.398	0.53	0.17
159	5795	Left	Touch	/	13.79	15.00	0.080	0.11	0.295	0.39	0.20
159	5795	Left	Tilt	/	13.79	15.00	0.110	0.15	0.417	0.55	0.17
159	5795	Right	Touch	/	13.79	15.00	0.058	0.08	0.185	0.24	0.11
159	5795	Right	Tilt	/	13.79	15.00	0.071	0.09	0.230	0.30	-0.09

Table 14.4-7: SAR Values (WLAN - Body)

Frequency		Test Position	Figure No.	Conducted Power (dBm)	Max. tune-up Power (dBm)	Measured SAR(10g) (W/kg)	Reported SAR(10g) (W/kg)	Measured SAR(1g) (W/kg)	Reported SAR(1g) (W/kg)	Power Drift (dB)
MHz	Ch.									
54	5270	Front	/	13.36	15.00	0.019	0.03	0.065	0.09	0.06
54	5270	Rear	/	13.36	15.00	0.040	0.06	0.146	0.21	0.09
54	5270	Right	/	13.36	15.00	0.018	0.03	0.055	0.08	0.15
54	5270	Top	/	13.36	15.00	0.045	0.07	0.156	0.23	0.12
118	5590	Front	/	13.76	15.00	0.032	0.04	0.082	0.11	0.14
118	5590	Rear	/	13.76	15.00	0.100	0.13	0.298	0.40	-0.18
118	5590	Right	/	13.76	15.00	0.029	0.04	0.064	0.09	0.11
118	5590	Top	Fig.27	13.76	15.00	0.115	0.15	0.329	0.44	0.04
159	5795	Front	/	13.79	15.00	0.023	0.03	0.063	0.08	0.16
159	5795	Rear	/	13.79	15.00	0.082	0.11	0.234	0.31	-0.18
159	5795	Right	/	13.79	15.00	0.024	0.03	0.055	0.07	0.13
159	5795	Top	/	13.79	15.00	0.100	0.13	0.288	0.38	0.17
118	5590	Rear	Note2	13.76	15.00	0.058	0.08	0.155	0.21	0.14

Note1: The distance between the EUT and the phantom bottom is 10mm.

Note2: The distance between the EUT and the phantom bottom is 15mm.

According to the KDB248227 D01, The reported SAR must be scaled to 100% transmission duty factor to determine compliance at the maximum tune-up tolerance limit. The scaled reported SAR is presented as below.

Table 14.4-8: SAR Values (WLAN - Normal Power Head) - Scaled Reported SAR

Frequency		Side	Test Position	Actual duty factor	maximum duty factor	Reported SAR (1g) (W/kg)	Scaled reported SAR (1g) (W/kg)
MHz	Ch.						
118	5590	Left	Tilt	100%	100%	0.76	0.76

Table 14.4-9: SAR Values (WLAN - Normal Power Body) – Scaled Reported SAR

Frequency		Test Position	D (mm)	Actual duty factor	maximum duty factor	Reported SAR (1g) (W/kg)	Scaled reported SAR (1g) (W/kg)
MHz	Ch.						
118	5590	Top	10	100%	100%	0.44	0.44

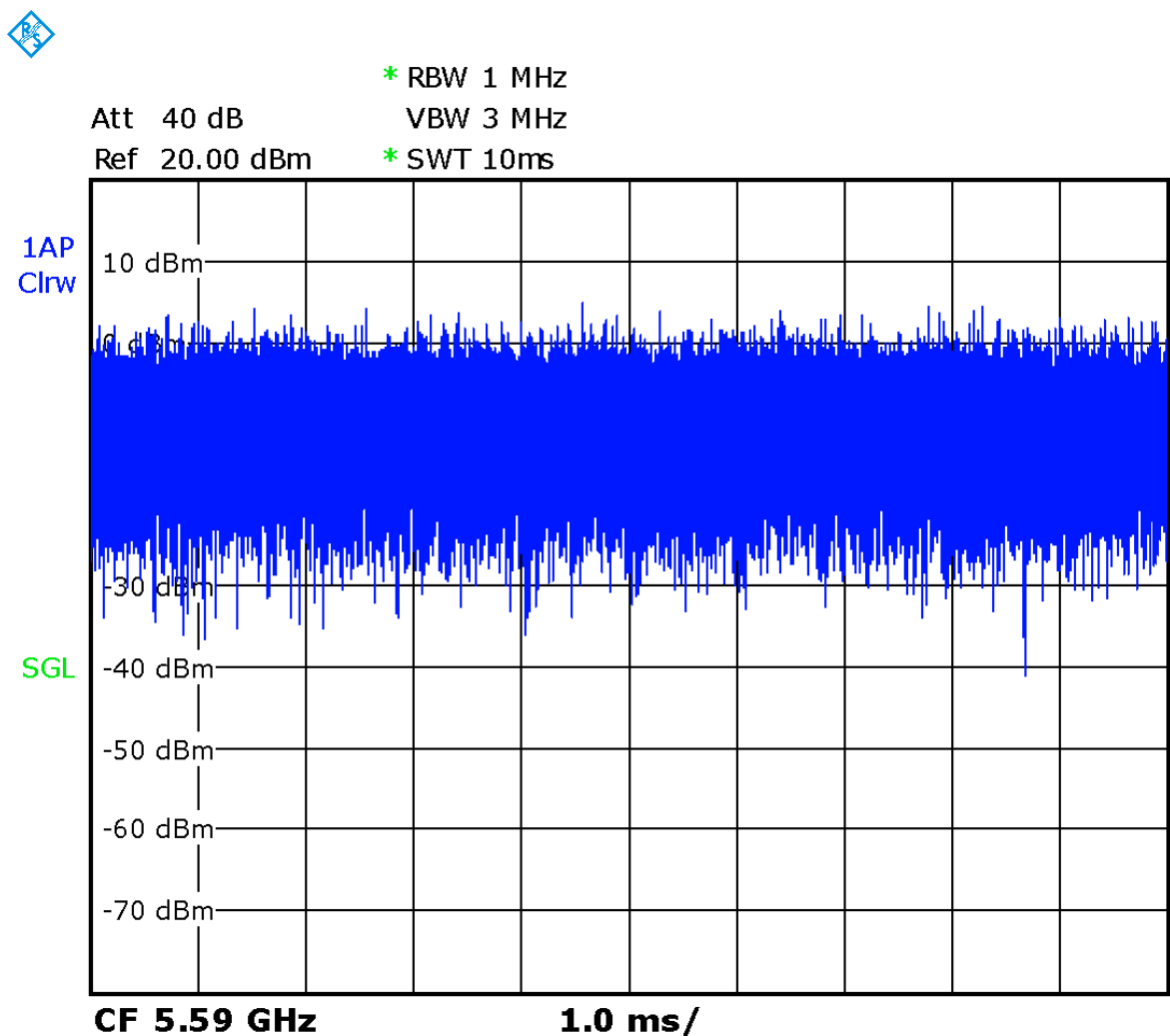

Picture 14.2 The plot of duty factor

14.5 SAR Evaluation for Phablet

According to the KDB648474 D04, for smart phones, with a display diagonal dimension > 15.0 cm or an overall diagonal dimension > 16.0 cm, that can provide similar mobile web access and multimedia support found in mini-tablets or UMPC mini-tablets and support voice calls next to the ear, unless it is confirmed otherwise through KDB inquiries, the following phablet procedures should be applied to evaluate SAR compliance for each applicable wireless modes and frequency band. Devices marketed as phablets, regardless of form factors and operating characteristics must be tested as a phablet to determine SAR compliance.

1. The normally required head and body-worn accessory SAR test procedures for handsets, including hotspot mode, must be applied.
2. The UMPC mini-tablet procedures must also be applied to test the SAR of all surfaces and edges with an antenna located at ≤ 25 mm from that surface or edge, in direct contact with a flat phantom, for 10-g extremity SAR according to the body-equivalent tissue dielectric parameters in KDB Publication 865664 D01 to address interactive hand use exposure conditions. When hotspot mode applies, 10-g extremity SAR is required only for the surfaces and edges with hotspot mode 1-g reported SAR > 1.2 W/kg; however, when power reduction applies to hotspot mode the measured SAR must be scaled to the maximum output power, including tolerance, allowed for phablet modes to compare with the 1.2 W/kg SAR test reduction threshold. The normal tablet procedures in KDB Publication 616217 are required when the overall diagonal dimension of the device is > 20.0 cm. Hotspot mode SAR is not required when normal tablet procedures are applied. Extremity 10-g SAR is also not required for the front (top) surface of larger form factor full size tablets. The more conservative normal tablet SAR results can be used to support phablet mode 10-g extremity SAR.
3. The simultaneous transmission operating configurations applicable to voice and data transmissions for both phone and mini-tablet modes must be taken into consideration separately for 1-g and 10-g SAR to determine the simultaneous transmission SAR test exclusion and measurement requirements for the relevant wireless modes and exposure conditions

For the device of this project, the display diagonal dimension is 13.92 cm (<15.0 cm) and the overall diagonal dimension is 15.94 cm (< 16.0 cm), so this device isn't a phone as "phablet".

15 SAR Measurement Variability

SAR measurement variability must be assessed for each frequency band, which is determined by the SAR probe calibration point and tissue-equivalent medium used for the device measurements. When both head and body tissue-equivalent media are required for SAR measurements in a frequency band, the variability measurement procedures should be applied to the tissue medium with the highest measured SAR, using the highest measured SAR configuration for that tissue-equivalent medium.

The following procedures are applied to determine if repeated measurements are required.

- 1) Repeated measurement is not required when the original highest measured SAR is < 0.80 W/kg; steps 2) through 4) do not apply.
- 2) When the original highest measured SAR is ≥ 0.80 W/kg, repeat that measurement once.
- 3) Perform a second repeated measurement only if the ratio of largest to smallest SAR for the original and first repeated measurements is > 1.20 or when the original or repeated measurement is ≥ 1.45 W/kg ($\sim 10\%$ from the 1-g SAR limit).
- 4) Perform a third repeated measurement only if the original, first or second repeated measurement is ≥ 1.5 W/kg and the ratio of largest to smallest SAR for the original, first and second repeated measurements is > 1.20 .

Table 15.1: SAR Measurement Variability for Body WCDMA1700 (1g)

Frequency		Test Position	Spacing (mm)	Original SAR (W/kg)	First Repeated SAR (W/kg)	The Ratio	Second Repeated SAR (W/kg)
Ch.	MHz						
1312	1712.4	Bottom	10	0.856	0.821	1.04	/

Table 15.2: SAR Measurement Variability for Body LTE B2 (1g)

Frequency		Mode	Test Position	Spacing (mm)	Original SAR (W/kg)	First Repeated SAR (W/kg)	The Ratio	Second Repeated SAR (W/kg)
Ch.	MHz							
18900	1880	50RB_Low	Bottom	10	1.02	0.979	1.04	/

Table 15.3: SAR Measurement Variability for Body LTE B4 (1g)

Frequency		Mode	Test Position	Spacing (mm)	Original SAR (W/kg)	First Repeated SAR (W/kg)	The Ratio	Second Repeated SAR (W/kg)
Ch.	MHz							
20050	1720	50RB_High	Bottom	10	0.939	0.911	1.03	/

Table 15.4: SAR Measurement Variability for Body LTE B30 (1g)

Frequency		Mode	Test Position	Spacing (mm)	Original SAR (W/kg)	First Repeated SAR (W/kg)	The Ratio	Second Repeated SAR (W/kg)
Ch.	MHz							
27710	2310	1RB_Mid	Rear	10	0.948	0.917	1.03	/
27710	2310	1RB_Mid	Rear	15	1.13	1.07	1.06	/

16 Measurement Uncertainty

16.1 Measurement Uncertainty for Normal SAR Tests (300MHz~3GHz)

No.	Error Description	Type	Uncertainty value	Probably Distribution	Div.	(Ci) 1g	(Ci) 10g	Std. Unc. (1g)	Std. Unc. (10g)	Degree of freedom
Measurement system										
1	Probe calibration	B	6.0	N	1	1	1	6.0	6.0	∞
2	Isotropy	B	4.7	R	$\sqrt{3}$	0.7	0.7	1.9	1.9	∞
3	Boundary effect	B	1.0	R	$\sqrt{3}$	1	1	0.6	0.6	∞
4	Linearity	B	4.7	R	$\sqrt{3}$	1	1	2.7	2.7	∞
5	Detection limit	B	1.0	N	1	1	1	0.6	0.6	∞
6	Readout electronics	B	0.3	R	$\sqrt{3}$	1	1	0.3	0.3	∞
7	Response time	B	0.8	R	$\sqrt{3}$	1	1	0.5	0.5	∞
8	Integration time	B	2.6	R	$\sqrt{3}$	1	1	1.5	1.5	∞
9	RF ambient conditions-noise	B	0	R	$\sqrt{3}$	1	1	0	0	∞
10	RFambient conditions-reflection	B	0	R	$\sqrt{3}$	1	1	0	0	∞
11	Probe positioned mech. restrictions	B	0.4	R	$\sqrt{3}$	1	1	0.2	0.2	∞
12	Probe positioning with respect to phantom shell	B	2.9	R	$\sqrt{3}$	1	1	1.7	1.7	∞
13	Post-processing	B	1.0	R	$\sqrt{3}$	1	1	0.6	0.6	∞
Test sample related										
14	Test sample positioning	A	3.3	N	1	1	1	3.3	3.3	71
15	Device holder uncertainty	A	3.4	N	1	1	1	3.4	3.4	5
16	Drift of output power	B	5.0	R	$\sqrt{3}$	1	1	2.9	2.9	∞
Phantom and set-up										
17	Phantom uncertainty	B	4.0	R	$\sqrt{3}$	1	1	2.3	2.3	∞
18	Liquid conductivity (target)	B	5.0	R	$\sqrt{3}$	0.64	0.43	1.8	1.2	∞
19	Liquid conductivity (meas.)	A	2.06	N	1	0.64	0.43	1.32	0.89	43
20	Liquid permittivity (target)	B	5.0	R	$\sqrt{3}$	0.6	0.49	1.7	1.4	∞
21	Liquid permittivity (meas.)	A	1.6	N	1	0.6	0.49	1.0	0.8	521

Combined standard uncertainty	$u_c = \sqrt{\sum_{i=1}^{21} c_i^2 u_i^2}$							9.55	9.43	257
Expanded uncertainty (confidence interval of 95 %)	$u_e = 2u_c$							19.1	18.9	

16.2 Measurement Uncertainty for Normal SAR Tests (3~6GHz)

No.	Error Description	Type	Uncertainty value	Probably Distribution	Div.	(Ci) 1g	(Ci) 10g	Std. Unc. (1g)	Std. Unc. (10g)	Degree of freedom
Measurement system										
1	Probe calibration	B	6.55	N	1	1	1	6.55	6.55	∞
2	Isotropy	B	4.7	R	$\sqrt{3}$	0.7	0.7	1.9	1.9	∞
3	Boundary effect	B	2.0	R	$\sqrt{3}$	1	1	1.2	1.2	∞
4	Linearity	B	4.7	R	$\sqrt{3}$	1	1	2.7	2.7	∞
5	Detection limit	B	1.0	R	$\sqrt{3}$	1	1	0.6	0.6	∞
6	Readout electronics	B	0.3	R	$\sqrt{3}$	1	1	0.3	0.3	∞
7	Response time	B	0.8	R	$\sqrt{3}$	1	1	0.5	0.5	∞
8	Integration time	B	2.6	R	$\sqrt{3}$	1	1	1.5	1.5	∞
9	RF ambient conditions-noise	B	0	R	$\sqrt{3}$	1	1	0	0	∞
10	RFambient conditions-reflection	B	0	R	$\sqrt{3}$	1	1	0	0	∞
11	Probe positioned mech. restrictions	B	0.8	R	$\sqrt{3}$	1	1	0.5	0.5	∞
12	Probe positioning with respect to phantom shell	B	6.7	R	$\sqrt{3}$	1	1	3.9	3.9	∞
13	Post-processing	B	4.0	R	$\sqrt{3}$	1	1	2.3	2.3	∞
Test sample related										
14	Test sample positioning	A	3.3	N	1	1	1	3.3	3.3	71
15	Device holder uncertainty	A	3.4	N	1	1	1	3.4	3.4	5
16	Drift of output power	B	5.0	R	$\sqrt{3}$	1	1	2.9	2.9	∞
Phantom and set-up										
17	Phantom uncertainty	B	4.0	R	$\sqrt{3}$	1	1	2.3	2.3	∞
18	Liquid conductivity (target)	B	5.0	R	$\sqrt{3}$	0.64	0.43	1.8	1.2	∞
19	Liquid conductivity (meas.)	A	2.06	N	1	0.64	0.43	1.32	0.89	43
20	Liquid permittivity	B	5.0	R	$\sqrt{3}$	0.6	0.49	1.7	1.4	∞

	(target)									
21	Liquid permittivity (meas.)	A	1.6	N	1	0.6	0.49	1.0	0.8	521
Combined standard uncertainty		$u_c = \sqrt{\sum_{i=1}^{21} c_i^2 u_i^2}$						10.7	10.6	257
Expanded uncertainty (confidence interval of 95 %)		$u_e = 2u_c$						21.4	21.1	

16.3 Measurement Uncertainty for Fast SAR Tests (300MHz~3GHz)

No.	Error Description	Type	Uncertainty value	Probably Distribution	Div.	(Ci) 1g	(Ci) 10g	Std. Unc. (1g)	Std. Unc. (10g)	Degree of freedom
Measurement system										
1	Probe calibration	B	6.0	N	1	1	1	6.0	6.0	∞
2	Isotropy	B	4.7	R	$\sqrt{3}$	0.7	0.7	1.9	1.9	∞
3	Boundary effect	B	1.0	R	$\sqrt{3}$	1	1	0.6	0.6	∞
4	Linearity	B	4.7	R	$\sqrt{3}$	1	1	2.7	2.7	∞
5	Detection limit	B	1.0	R	$\sqrt{3}$	1	1	0.6	0.6	∞
6	Readout electronics	B	0.3	R	$\sqrt{3}$	1	1	0.3	0.3	∞
7	Response time	B	0.8	R	$\sqrt{3}$	1	1	0.5	0.5	∞
8	Integration time	B	2.6	R	$\sqrt{3}$	1	1	1.5	1.5	∞
9	RF ambient conditions-noise	B	0	R	$\sqrt{3}$	1	1	0	0	∞
10	RFambient conditions-reflection	B	0	R	$\sqrt{3}$	1	1	0	0	∞
11	Probe positioned mech. Restrictions	B	0.4	R	$\sqrt{3}$	1	1	0.2	0.2	∞
12	Probe positioning with respect to phantom shell	B	2.9	R	$\sqrt{3}$	1	1	1.7	1.7	∞
13	Post-processing	B	1.0	R	$\sqrt{3}$	1	1	0.6	0.6	∞
14	Fast SAR z-Approximation	B	7.0	R	$\sqrt{3}$	1	1	4.0	4.0	∞
Test sample related										
15	Test sample positioning	A	3.3	N	1	1	1	3.3	3.3	71
16	Device holder uncertainty	A	3.4	N	1	1	1	3.4	3.4	5
17	Drift of output power	B	5.0	R	$\sqrt{3}$	1	1	2.9	2.9	∞
Phantom and set-up										
18	Phantom uncertainty	B	4.0	R	$\sqrt{3}$	1	1	2.3	2.3	∞

19	Liquid conductivity (target)	B	5.0	R	$\sqrt{3}$	0.64	0.43	1.8	1.2	∞
20	Liquid conductivity (meas.)	A	2.06	N	1	0.64	0.43	1.32	0.89	43
21	Liquid permittivity (target)	B	5.0	R	$\sqrt{3}$	0.6	0.49	1.7	1.4	∞
22	Liquid permittivity (meas.)	A	1.6	N	1	0.6	0.49	1.0	0.8	521
Combined standard uncertainty		$u_c = \sqrt{\sum_{i=1}^{22} c_i^2 u_i^2}$						10.4	10.3	257
Expanded uncertainty (confidence interval of 95 %)		$u_e = 2u_c$						20.8	20.6	

16.4 Measurement Uncertainty for Fast SAR Tests (3~6GHz)

No.	Error Description	Type	Uncertainty value	Probably Distribution	Div.	(Ci) 1g	(Ci) 10g	Std. Unc. (1g)	Std. Unc. (10g)	Degree of freedom
Measurement system										
1	Probe calibration	B	6.55	N	1	1	1	6.55	6.55	∞
2	Isotropy	B	4.7	R	$\sqrt{3}$	0.7	0.7	1.9	1.9	∞
3	Boundary effect	B	2.0	R	$\sqrt{3}$	1	1	1.2	1.2	∞
4	Linearity	B	4.7	R	$\sqrt{3}$	1	1	2.7	2.7	∞
5	Detection limit	B	1.0	R	$\sqrt{3}$	1	1	0.6	0.6	∞
6	Readout electronics	B	0.3	R	$\sqrt{3}$	1	1	0.3	0.3	∞
7	Response time	B	0.8	R	$\sqrt{3}$	1	1	0.5	0.5	∞
8	Integration time	B	2.6	R	$\sqrt{3}$	1	1	1.5	1.5	∞
9	RF ambient conditions-noise	B	0	R	$\sqrt{3}$	1	1	0	0	∞
10	RF ambient conditions-reflection	B	0	R	$\sqrt{3}$	1	1	0	0	∞
11	Probe positioned mech. Restrictions	B	0.8	R	$\sqrt{3}$	1	1	0.5	0.5	∞
12	Probe positioning with respect to phantom shell	B	6.7	R	$\sqrt{3}$	1	1	3.9	3.9	∞
13	Post-processing	B	1.0	R	$\sqrt{3}$	1	1	0.6	0.6	∞
14	Fast SAR z-Approximation	B	14.0	R	$\sqrt{3}$	1	1	8.1	8.1	∞
Test sample related										
15	Test sample positioning	A	3.3	N	1	1	1	3.3	3.3	71

16	Device holder uncertainty	A	3.4	N	1	1	1	3.4	3.4	5
17	Drift of output power	B	5.0	R	$\sqrt{3}$	1	1	2.9	2.9	∞
Phantom and set-up										
18	Phantom uncertainty	B	4.0	R	$\sqrt{3}$	1	1	2.3	2.3	∞
19	Liquid conductivity (target)	B	5.0	R	$\sqrt{3}$	0.64	0.43	1.8	1.2	∞
20	Liquid conductivity (meas.)	A	2.06	N	1	0.64	0.43	1.32	0.89	43
21	Liquid permittivity (target)	B	5.0	R	$\sqrt{3}$	0.6	0.49	1.7	1.4	∞
22	Liquid permittivity (meas.)	A	1.6	N	1	0.6	0.49	1.0	0.8	521
Combined standard uncertainty		$u_c = \sqrt{\sum_{i=1}^{22} c_i^2 u_i^2}$						13.5	13.4	257
Expanded uncertainty (confidence interval of 95 %)		$u_e = 2u_c$						27.0	26.8	

17 MAIN TEST INSTRUMENTS

Table 17.1: List of Main Instruments

No.	Name	Type	Serial Number	Calibration Date	Valid Period
01	Network analyzer	E5071C	MY46110673	January 14, 2021	One year
02	Power meter	NRVD	102083	October 23, 2020	One year
03	Power sensor	NRV-Z5	100542		
04	Signal Generator	E4438C	MY49071430	February 1, 2021	One Year
05	Amplifier	60S1G4	0331848	No Calibration Requested	
06	BTS	CMW500	159890	January 25 2021	One year
07	BTS	CMW500	159889	January 13 2021	One year
08	E-field Probe	SPEAG EX3DV4	7600	November 30, 2020	One year
09	DAE	SPEAG DAE4	1525	September 2, 2020	One year
10	Dipole Validation Kit	SPEAG D750V3	1017	July 24,2020	One year
11	Dipole Validation Kit	SPEAG D835V2	4d069	July 24,,2020	One year
12	Dipole Validation Kit	SPEAG D1750V2	1003	July 24, 2020	One year
13	Dipole Validation Kit	SPEAG D1900V2	5d101	July 28,2020	One year
14	Dipole Validation Kit	SPEAG D2300V2	1018	July 21,2020	One year
15	Dipole Validation Kit	SPEAG D2450V2	853	July 21,2020	One year
16	Dipole Validation Kit	SPEAG D5GHzV2	1060	July 27,2020	One year

END OF REPORT BODY

ANNEX A Graph Results

WCDMA850-BV_CH4183 Right Cheek

Date: 5/20/2021

Electronics: DAE4 Sn1525

Medium: H850

Medium parameters used (interpolated): $f = 836.6$ MHz; $\sigma = 0.852$ S/m; $\epsilon_r = 44.671$; $\rho = 1000$ kg/m³

Ambient Temperature: 23.2oC Liquid Temperature: 22.6oC

Communication System: WCDMA850(B5) Frequency: 836.6 MHz Duty Cycle: 1:1

Probe: EX3DV4 - SN7600 ConvF(10.88, 10.88, 10.88)

Area Scan (81x131x1): Interpolated grid: dx=1.500 mm, dy=1.500 mm

Maximum value of SAR (interpolated) = 0.287 W/kg

Zoom Scan (5x5x7)/Cube 0: Measurement grid: dx=8mm, dy=8mm, dz=5mm

Reference Value = 7.080 V/m; Power Drift = 0.14 dB

Peak SAR (extrapolated) = 0.318 W/kg

SAR(1 g) = 0.242 W/kg; SAR(10 g) = 0.190 W/kg

Maximum value of SAR (measured) = 0.286 W/kg

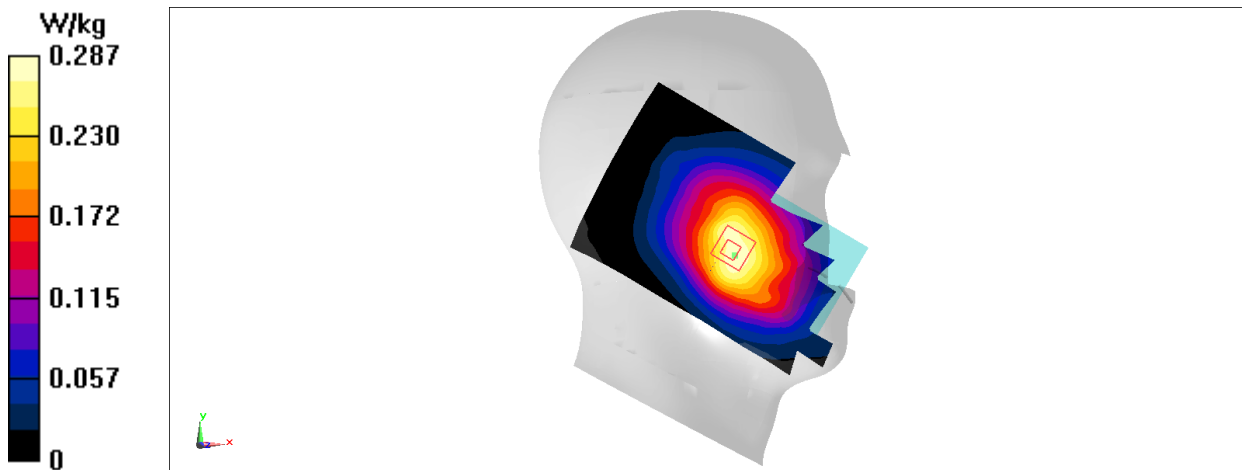

Fig A.1

WCDMA850-BV_CH4132 Rear

Date: 5/20/2021

Electronics: DAE4 Sn1525

Medium: H850

Medium parameters used (interpolated): $f = 826.4$ MHz; $\sigma = 0.848$ S/m; $\epsilon_r = 44.704$; $\rho = 1000$ kg/m³

Ambient Temperature: 23.2oC Liquid Temperature: 22.6oC

Communication System: WCDMA850(B5) Frequency: 826.4 MHz Duty Cycle: 1:1

Probe: EX3DV4 - SN7600 ConvF(10.88, 10.88, 10.88)

Area Scan (81x131x1): Interpolated grid: dx=1.500 mm, dy=1.500 mm

Maximum value of SAR (interpolated) = 0.551 W/kg

Zoom Scan (6x6x7)/Cube 0: Measurement grid: dx=8mm, dy=8mm, dz=5mm

Reference Value = 25.20 V/m; Power Drift = 0.07 dB

Peak SAR (extrapolated) = 0.608 W/kg

SAR(1 g) = 0.456 W/kg; SAR(10 g) = 0.352 W/kg

Maximum value of SAR (measured) = 0.550 W/kg

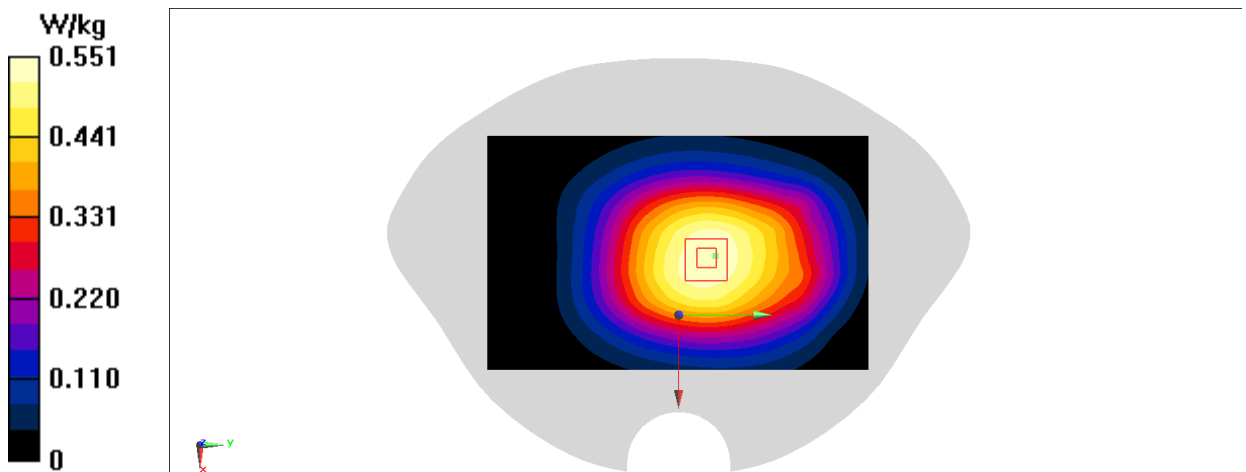
**Fig A.2**

WCDMA1700-BIV_CH1312 Right Cheek

Date: 5/22/2021

Electronics: DAE4 Sn1525

Medium: H1750

Medium parameters used (interpolated): $f = 1712.4$ MHz; $\sigma = 1.358$ S/m; $\epsilon_r = 42.139$; $\rho = 1000$ kg/m³

Ambient Temperature: 22.9°C Liquid Temperature: 22.3°C

Communication System: WCDMA1700(B4) Frequency: 1712.4 MHz Duty Cycle: 1:1

Probe: EX3DV4 - SN7600 ConvF(9.01, 9.01, 9.01)

Area Scan (81x131x1): Interpolated grid: $dx=1.500$ mm, $dy=1.500$ mm

Maximum value of SAR (interpolated) = 0.435 W/kg

Zoom Scan (5x5x7)/Cube 0: Measurement grid: $dx=8$ mm, $dy=8$ mm, $dz=5$ mm

Reference Value = 4.876 V/m; Power Drift = -0.14 dB

Peak SAR (extrapolated) = 0.469 W/kg

SAR(1 g) = 0.312 W/kg; SAR(10 g) = 0.202 W/kg

Maximum value of SAR (measured) = 0.415 W/kg

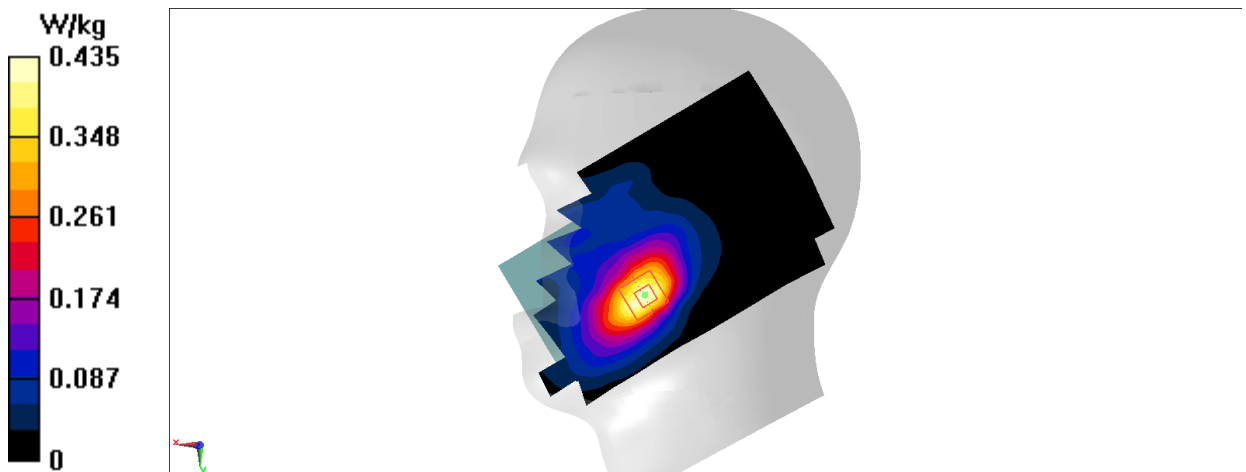
**Fig A.3**

WCDMA1700-BIV_CH1312 Bottom

Date: 5/22/2021

Electronics: DAE4 Sn1525

Medium: H1750

Medium parameters used (interpolated): $f = 1712.4$ MHz; $\sigma = 1.358$ S/m; $\epsilon_r = 42.139$; $\rho = 1000$ kg/m³

Ambient Temperature: 22.9oC Liquid Temperature: 22.3oC

Communication System: WCDMA1700(B4) Frequency: 1712.4 MHz Duty Cycle: 1:1

Probe: EX3DV4 - SN7600 ConvF(9.01, 9.01, 9.01)

Area Scan (91x141x1): Interpolated grid: dx=1.500 mm, dy=1.500 mm

Maximum value of SAR (interpolated) = 1.28 W/kg

Zoom Scan (6x5x7)/Cube 0: Measurement grid: dx=8mm, dy=8mm, dz=5mm

Reference Value = 13.52 V/m; Power Drift = 0.15 dB

Peak SAR (extrapolated) = 1.53 W/kg

SAR(1 g) = 0.856 W/kg; SAR(10 g) = 0.474 W/kg

Maximum value of SAR (measured) = 1.28 W/kg

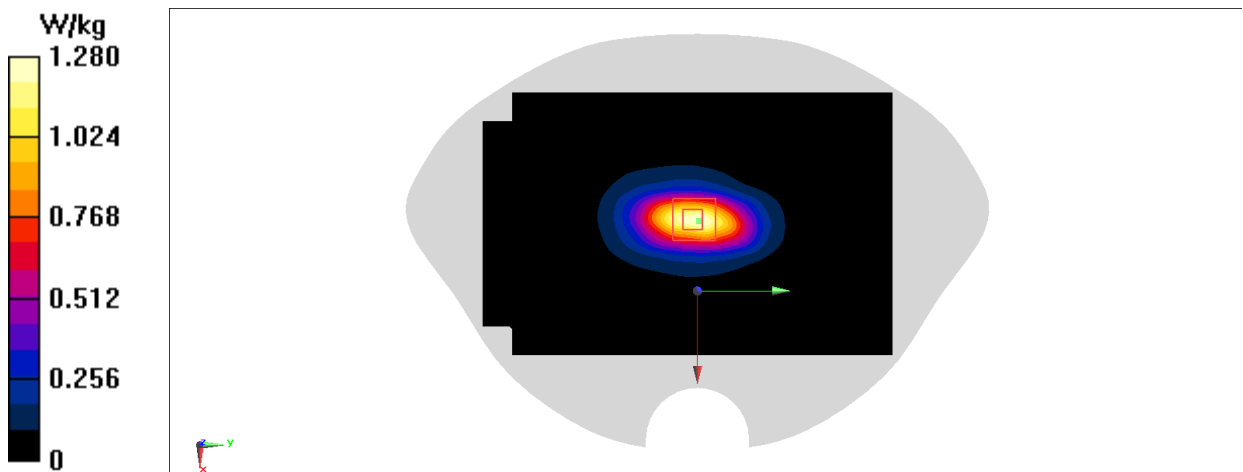
**Fig A.4**

WCDMA1700-BIV_CH1312 Rear

Date: 5/22/2021

Electronics: DAE4 Sn1525

Medium: H1750

Medium parameters used (interpolated): $f = 1712.4$ MHz; $\sigma = 1.358$ S/m; $\epsilon_r = 42.139$; $\rho = 1000$ kg/m³

Ambient Temperature: 22.9oC Liquid Temperature: 22.3oC

Communication System: WCDMA1700(B4) Frequency: 1712.4 MHz Duty Cycle: 1:1

Probe: EX3DV4 - SN7600 ConvF(9.01, 9.01, 9.01)

Area Scan (81x131x1): Interpolated grid: dx=1.500 mm, dy=1.500 mm

Maximum value of SAR (interpolated) = 0.455 W/kg

Zoom Scan (5x5x7)/Cube 0: Measurement grid: dx=8mm, dy=8mm, dz=5mm

Reference Value = 8.957 V/m; Power Drift = -0.05 dB

Peak SAR (extrapolated) = 0.548 W/kg

SAR(1 g) = 0.339 W/kg; SAR(10 g) = 0.209 W/kg

Maximum value of SAR (measured) = 0.461 W/kg

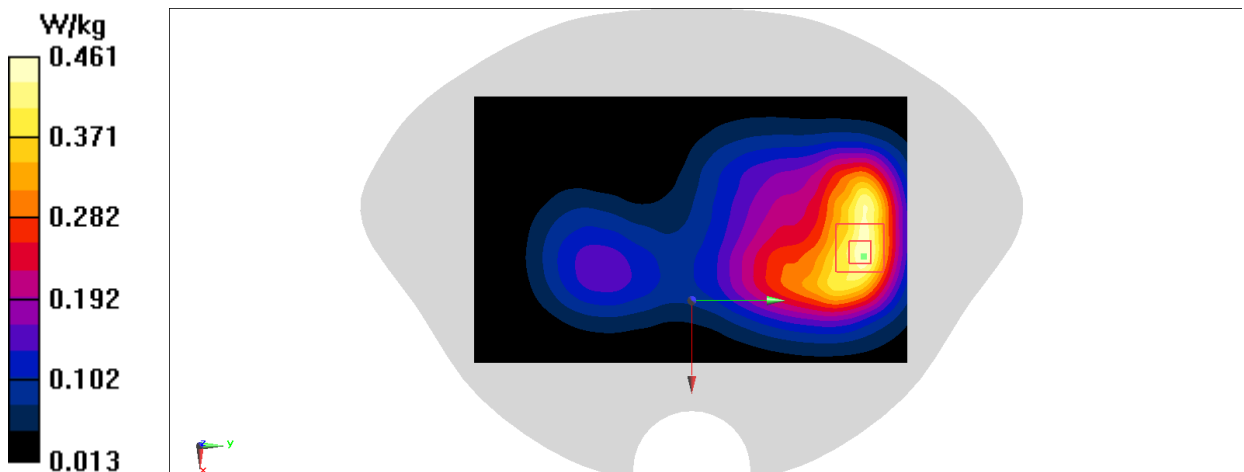
**Fig A.5**

WCDMA1900-BII_CH9400 Left Cheek

Date: 5/22/2021

Electronics: DAE4 Sn1525

Medium: H1900

Medium parameters used: $f = 1880$ MHz; $\sigma = 1.429$ S/m; $\epsilon_r = 41.968$; $\rho = 1000$ kg/m³

Ambient Temperature: 22.9oC Liquid Temperature: 22.3oC

Communication System: WCDMA1900(B2) Frequency: 1880 MHz Duty Cycle: 1:1

Probe: EX3DV4 - SN7600 ConvF(8.7, 8.7, 8.7)

Area Scan (81x131x1): Interpolated grid: dx=1.500 mm, dy=1.500 mm

Maximum value of SAR (interpolated) = 0.344 W/kg

Zoom Scan (5x5x7)/Cube 0: Measurement grid: dx=8mm, dy=8mm, dz=5mm

Reference Value = 5.262 V/m; Power Drift = 0.05 dB

Peak SAR (extrapolated) = 0.375 W/kg

SAR(1 g) = 0.250 W/kg; SAR(10 g) = 0.164 W/kg

Maximum value of SAR (measured) = 0.328 W/kg

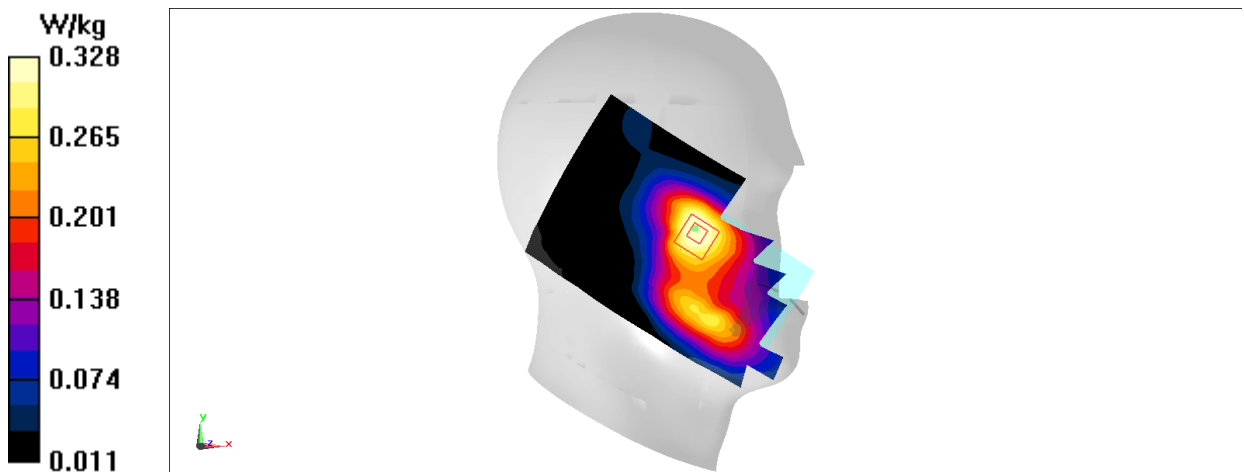
**Fig A.6**

WCDMA1900-BII_CH9400 Bottom

Date: 5/22/2021

Electronics: DAE4 Sn1525

Medium: H1900

Medium parameters used: $f = 1880$ MHz; $\sigma = 1.429$ S/m; $\epsilon_r = 41.968$; $\rho = 1000$ kg/m³

Ambient Temperature: 22.9oC Liquid Temperature: 22.3oC

Communication System: WCDMA1900(B2) Frequency: 1880 MHz Duty Cycle: 1:1

Probe: EX3DV4 - SN7600 ConvF(8.7, 8.7, 8.7)

Area Scan (81x131x1): Interpolated grid: dx=1.500 mm, dy=1.500 mm

Maximum value of SAR (interpolated) = 0.937 W/kg

Zoom Scan (5x5x7)/Cube 0: Measurement grid: dx=8mm, dy=8mm, dz=5mm

Reference Value = 24.49 V/m; Power Drift = 0.12 dB

Peak SAR (extrapolated) = 1.14 W/kg

SAR(1 g) = 0.630 W/kg; SAR(10 g) = 0.341 W/kg

Maximum value of SAR (measured) = 0.946 W/kg

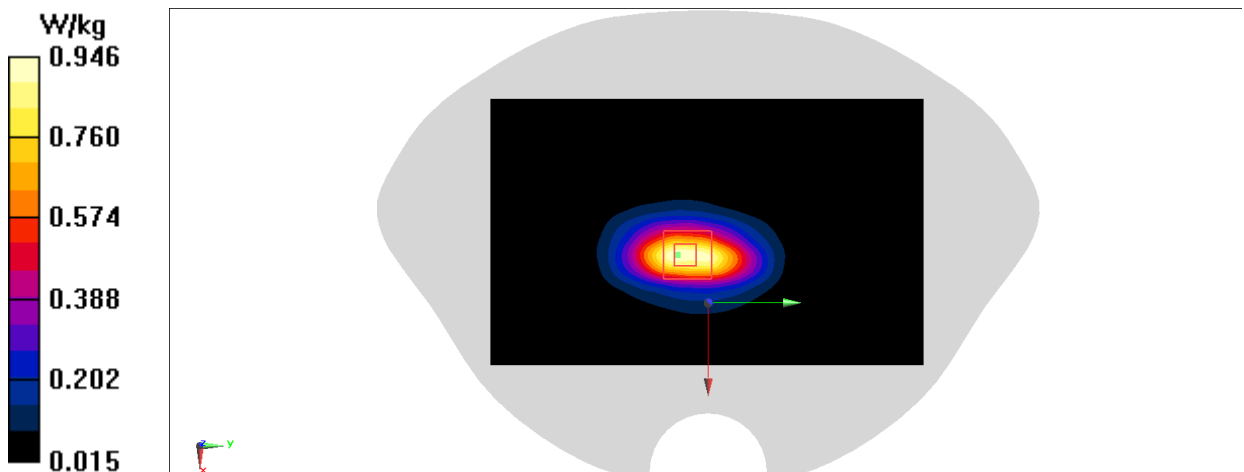
**Fig A.7**

WCDMA1900-BII_CH9262 Rear

Date: 5/22/2021

Electronics: DAE4 Sn1525

Medium: H1900

Medium parameters used (interpolated): $f = 1852.4$ MHz; $\sigma = 1.415$ S/m; $\epsilon_r = 41.897$; $\rho = 1000$ kg/m³

Ambient Temperature: 22.9oC Liquid Temperature: 22.3oC

Communication System: WCDMA1900(B2) Frequency: 1852.4 MHz Duty Cycle: 1:1

Probe: EX3DV4 - SN7600 ConvF(8.7, 8.7, 8.7)

Area Scan (81x131x1): Interpolated grid: dx=1.500 mm, dy=1.500 mm

Maximum value of SAR (interpolated) = 1.04 W/kg

Zoom Scan (5x5x7)/Cube 0: Measurement grid: dx=8mm, dy=8mm, dz=5mm

Reference Value = 9.139 V/m; Power Drift = -0.09 dB

Peak SAR (extrapolated) = 1.24 W/kg

SAR(1 g) = 0.742 W/kg; SAR(10 g) = 0.437 W/kg

Maximum value of SAR (measured) = 1.03 W/kg

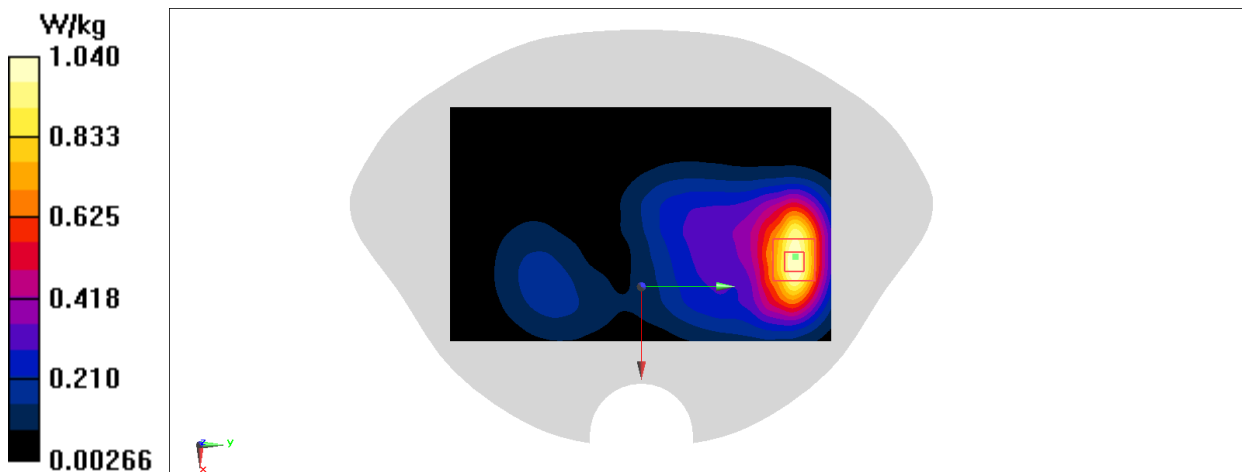
**Fig A.8**

LTE1900-FDD2_CH18700 Right Cheek

Date: 5/23/2021

Electronics: DAE4 Sn1525

Medium: H1900

Medium parameters used: $f = 1860$ MHz; $\sigma = 1.418$ S/m; $\epsilon_r = 41.913$; $\rho = 1000$ kg/m³

Ambient Temperature: 23.1oC Liquid Temperature: 22.5oC

Communication System: LTE Band2 Frequency: 1860 MHz Duty Cycle: 1:1

Probe: EX3DV4 - SN7600 ConvF(8.7, 8.7, 8.7)

Area Scan (81x131x1): Interpolated grid: dx=1.500 mm, dy=1.500 mm

Maximum value of SAR (interpolated) = 0.483 W/kg

Zoom Scan (5x5x7)/Cube 0: Measurement grid: dx=8mm, dy=8mm, dz=5mm

Reference Value = 6.601 V/m; Power Drift = 0.14 dB

Peak SAR (extrapolated) = 0.546 W/kg

SAR(1 g) = 0.357 W/kg; SAR(10 g) = 0.224 W/kg

Maximum value of SAR (measured) = 0.481 W/kg

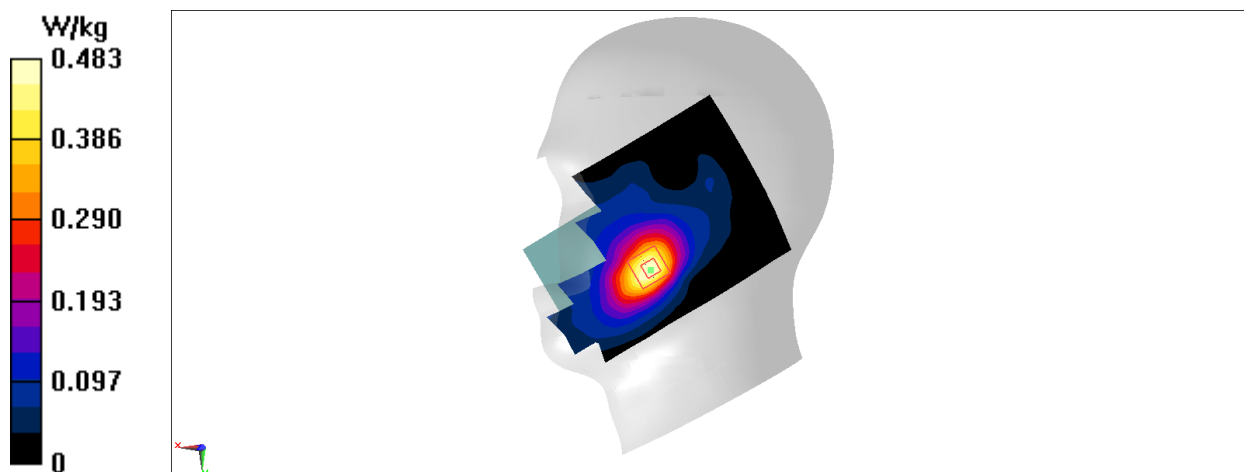
**Fig A.9**

LTE1900-FDD2_CH18900 Bottom

Date: 5/23/2021

Electronics: DAE4 Sn1525

Medium: H1900

Medium parameters used: $f = 1880$ MHz; $\sigma = 1.429$ S/m; $\epsilon_r = 41.968$; $\rho = 1000$ kg/m³

Ambient Temperature: 23.1oC Liquid Temperature: 22.5oC

Communication System: LTE Band2 Frequency: 1880 MHz Duty Cycle: 1:1

Probe: EX3DV4 - SN7600 ConvF(8.7, 8.7, 8.7)

Area Scan (91x141x1): Interpolated grid: dx=1.500 mm, dy=1.500 mm

Maximum value of SAR (interpolated) = 1.60 W/kg

Zoom Scan (6x6x7)/Cube 0: Measurement grid: dx=8mm, dy=8mm, dz=5mm

Reference Value = 20.97 V/m; Power Drift = 0.14 dB

Peak SAR (extrapolated) = 1.86 W/kg

SAR(1 g) = 1.02 W/kg; SAR(10 g) = 0.547 W/kg

Maximum value of SAR (measured) = 1.53 W/kg

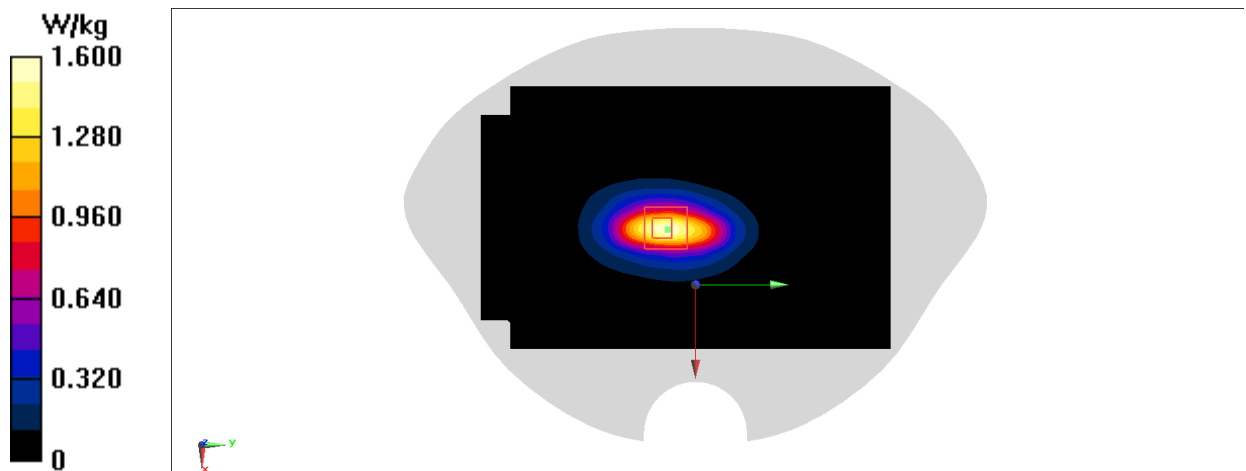
**Fig A.10**

LTE1900-FDD2_CH18700 Rear

Date: 5/23/2021

Electronics: DAE4 Sn1525

Medium: H1900

Medium parameters used: $f = 1860$ MHz; $\sigma = 1.418$ S/m; $\epsilon_r = 41.913$; $\rho = 1000$ kg/m³

Ambient Temperature: 23.1oC Liquid Temperature: 22.5oC

Communication System: LTE Band2 Frequency: 1860 MHz Duty Cycle: 1:1

Probe: EX3DV4 - SN7600 ConvF(8.7, 8.7, 8.7)

Area Scan (91x141x1): Interpolated grid: dx=1.500 mm, dy=1.500 mm

Maximum value of SAR (interpolated) = 1.05 W/kg

Zoom Scan (5x5x7)/Cube 0: Measurement grid: dx=8mm, dy=8mm, dz=5mm

Reference Value = 7.750 V/m; Power Drift = 0.11 dB

Peak SAR (extrapolated) = 1.23 W/kg

SAR(1 g) = 0.733 W/kg; SAR(10 g) = 0.426 W/kg

Maximum value of SAR (measured) = 1.04 W/kg

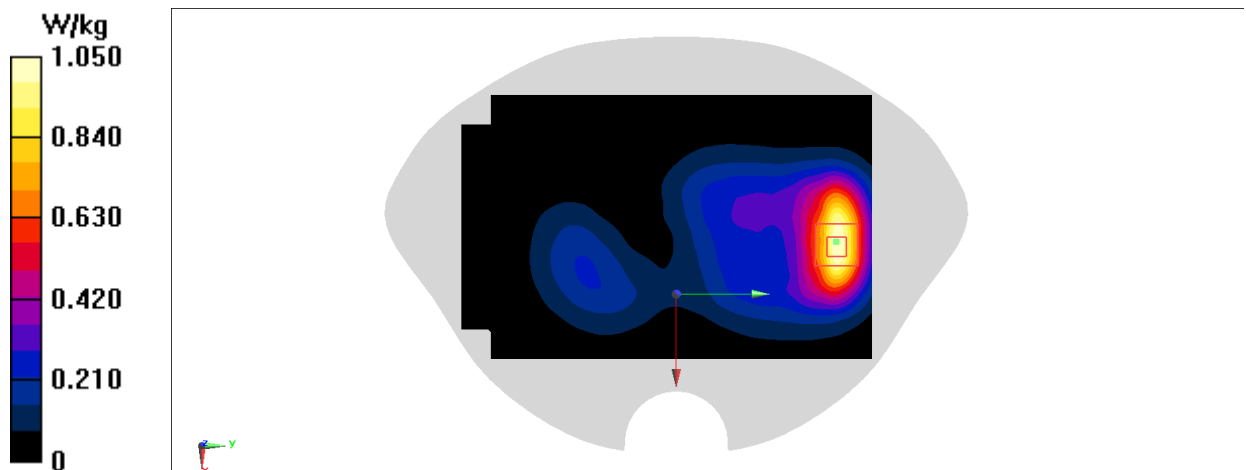

Fig A.11

LTE1750-FDD4_CH20050 Right Cheek

Date: 5/23/2021

Electronics: DAE4 Sn1525

Medium: H1750

Medium parameters used: $f = 1720$ MHz; $\sigma = 1.362$ S/m; $\epsilon_r = 42.111$; $\rho = 1000$ kg/m³

Ambient Temperature: 23.1oC Liquid Temperature: 22.5oC

Communication System: LTE Band4 Frequency: 1720 MHz Duty Cycle: 1:1

Probe: EX3DV4 - SN7600 ConvF(9.01, 9.01, 9.01)

Area Scan (81x131x1): Interpolated grid: dx=1.500 mm, dy=1.500 mm

Maximum value of SAR (interpolated) = 0.378 W/kg

Zoom Scan (5x5x7)/Cube 0: Measurement grid: dx=8mm, dy=8mm, dz=5mm

Reference Value = 6.612 V/m; Power Drift = -0.13 dB

Peak SAR (extrapolated) = 0.419 W/kg

SAR(1 g) = 0.273 W/kg; SAR(10 g) = 0.177 W/kg

Maximum value of SAR (measured) = 0.365 W/kg

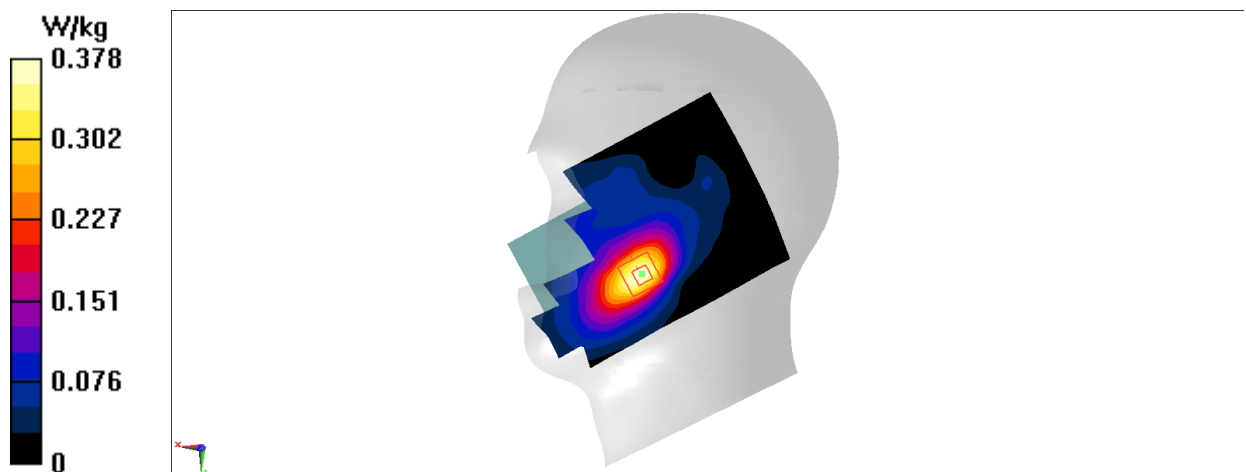

Fig A.12

LTE1750-FDD4_CH20050 Bottom

Date: 5/23/2021

Electronics: DAE4 Sn1525

Medium: H1750

Medium parameters used: $f = 1720$ MHz; $\sigma = 1.362$ S/m; $\epsilon_r = 42.111$; $\rho = 1000$ kg/m³

Ambient Temperature: 23.1oC Liquid Temperature: 22.5oC

Communication System: LTE Band4 Frequency: 1720 MHz Duty Cycle: 1:1

Probe: EX3DV4 - SN7600 ConvF(9.01, 9.01, 9.01)

Area Scan (91x141x1): Interpolated grid: dx=1.500 mm, dy=1.500 mm

Maximum value of SAR (interpolated) = 1.45 W/kg

Zoom Scan (6x6x7)/Cube 0: Measurement grid: dx=8mm, dy=8mm, dz=5mm

Reference Value = 21.86 V/m; Power Drift = 0.17 dB

Peak SAR (extrapolated) = 1.69 W/kg

SAR(1 g) = 0.939 W/kg; SAR(10 g) = 0.520 W/kg

Maximum value of SAR (measured) = 1.40 W/kg

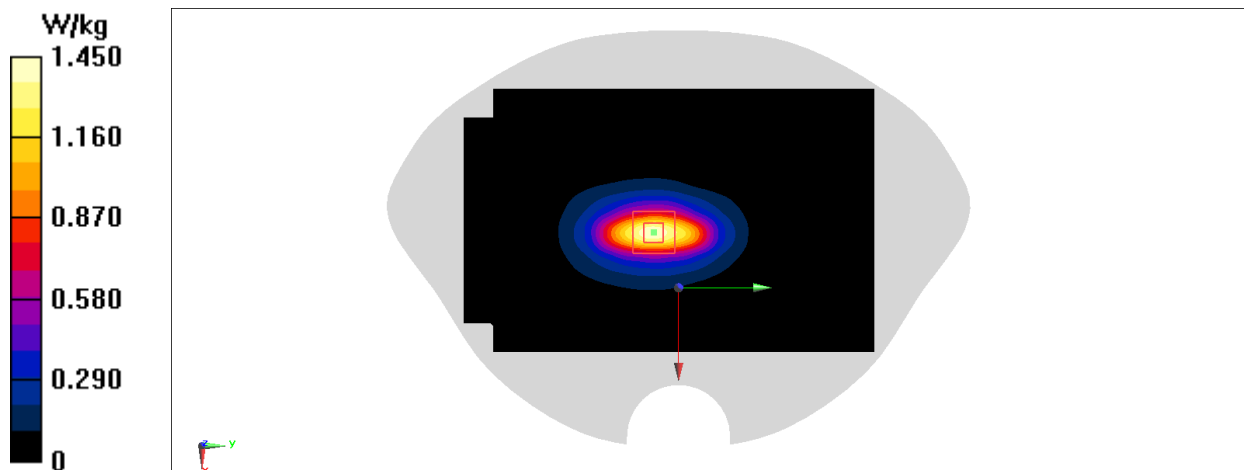

Fig A.13

LTE1750-FDD4_CH20050 Rear

Date: 5/23/2021

Electronics: DAE4 Sn1525

Medium: H1750

Medium parameters used: $f = 1720$ MHz; $\sigma = 1.362$ S/m; $\epsilon_r = 42.111$; $\rho = 1000$ kg/m³

Ambient Temperature: 23.1°C Liquid Temperature: 22.5°C

Communication System: LTE Band4 Frequency: 1720 MHz Duty Cycle: 1:1

Probe: EX3DV4 - SN7600 ConvF(9.01, 9.01, 9.01)

Area Scan (91x141x1): Interpolated grid: $dx=1.500$ mm, $dy=1.500$ mm
Maximum value of SAR (interpolated) = 0.571 W/kg

Zoom Scan (6x6x7)/Cube 0: Measurement grid: $dx=8$ mm, $dy=8$ mm, $dz=5$ mm
Reference Value = 8.814 V/m; Power Drift = -0.14 dB
Peak SAR (extrapolated) = 0.716 W/kg
SAR(1 g) = 0.437 W/kg; SAR(10 g) = 0.266 W/kg
Maximum value of SAR (measured) = 0.603 W/kg

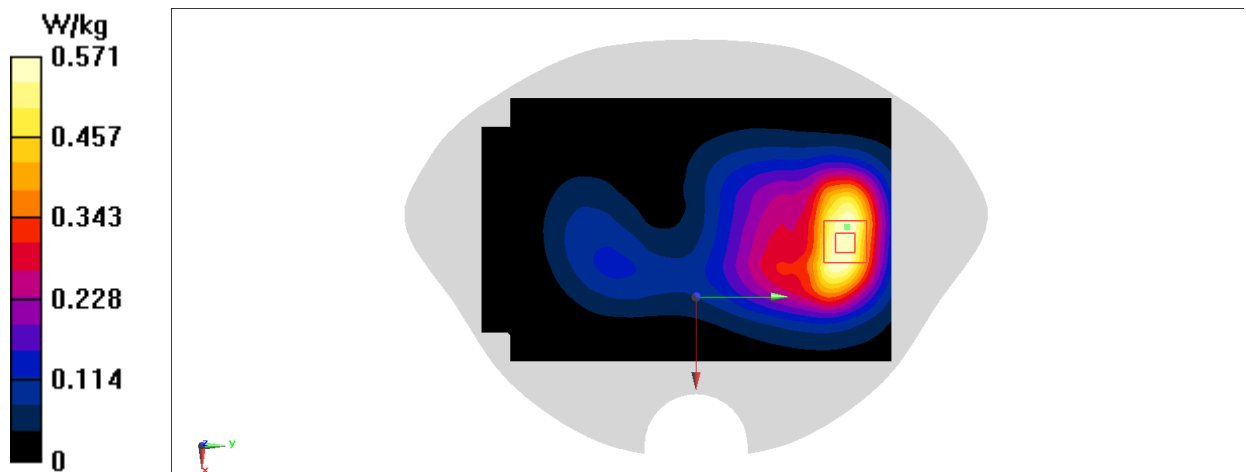

Fig A.14

LTE850-FDD5_CH20450 Left Cheek

Date: 5/20/2021

Electronics: DAE4 Sn1525

Medium: H850

Medium parameters used (interpolated): $f = 829$ MHz; $\sigma = 0.849$ S/m; $\epsilon_r = 44.695$;
 $\rho = 1000$ kg/m³

Ambient Temperature: 23.2oC

Liquid Temperature: 22.6oC

Communication System: LTE Band5 Frequency: 829 MHz Duty Cycle: 1:1

Probe: EX3DV4 - SN7600 ConvF(10.88, 10.88, 10.88)

Area Scan (81x131x1): Interpolated grid: dx=1.500 mm, dy=1.500 mm

Maximum value of SAR (interpolated) = 0.357 W/kg

Zoom Scan (5x5x7)/Cube 0: Measurement grid: dx=8mm, dy=8mm, dz=5mm

Reference Value = 7.055 V/m; Power Drift = 0.12 dB

Peak SAR (extrapolated) = 0.394 W/kg

SAR(1 g) = 0.304 W/kg; SAR(10 g) = 0.239 W/kg

Maximum value of SAR (measured) = 0.355 W/kg

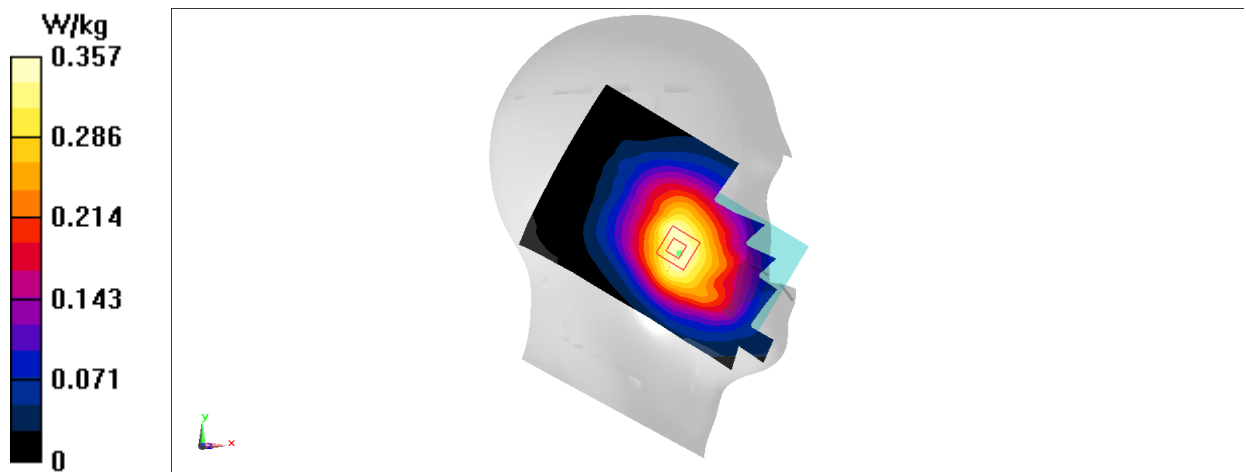

Fig A.15

LTE850-FDD5_CH20450 Rear

Date: 5/20/2021

Electronics: DAE4 Sn1525

Medium: H850

Medium parameters used (interpolated): $f = 829$ MHz; $\sigma = 0.849$ S/m; $\epsilon_r = 44.695$;
 $\rho = 1000$ kg/m³

Ambient Temperature: 23.20C

Liquid Temperature: 22.60C

Communication System: LTE Band5 Frequency: 829 MHz Duty Cycle: 1:1

Probe: EX3DV4 - SN7600 ConvF(10.88, 10.88, 10.88)

Area Scan (81x131x1): Interpolated grid: dx=1.500 mm, dy=1.500 mm
Maximum value of SAR (interpolated) = 0.665 W/kgZoom Scan (5x5x7)/Cube 0: Measurement grid: dx=8mm, dy=8mm, dz=5mm
Reference Value = 28.98 V/m; Power Drift = -0.13 dB
Peak SAR (extrapolated) = 0.734 W/kg
SAR(1 g) = 0.549 W/kg; SAR(10 g) = 0.426 W/kg
Maximum value of SAR (measured) = 0.665 W/kg

Fig A.16

LTE750-FDD12_CH23060 Left Cheek

Date: 5/21/2021

Electronics: DAE4 Sn1525

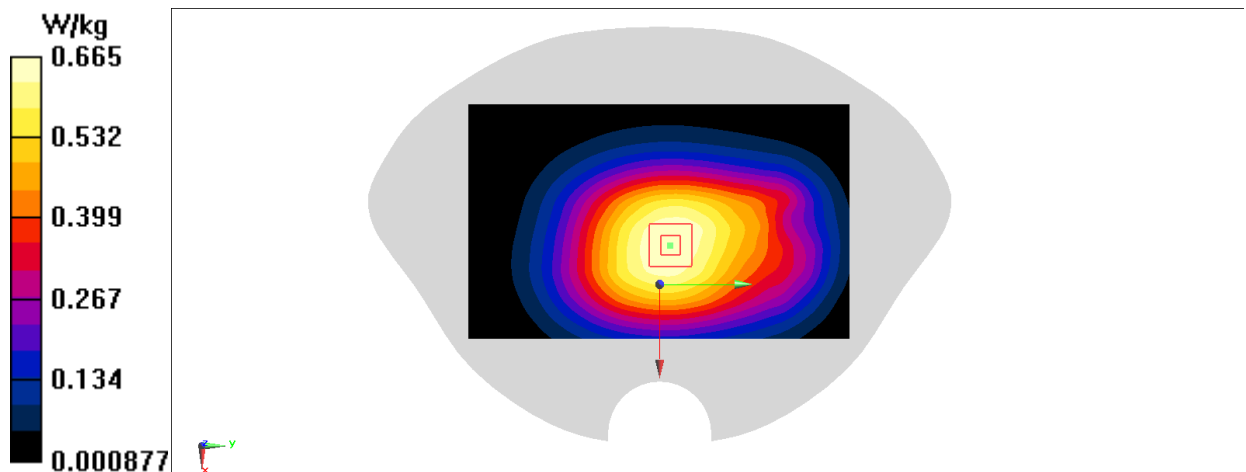
Medium: H750

Medium parameters used (interpolated): $f = 704$ MHz; $\sigma = 0.811$ S/m; $\epsilon_r = 44.061$;
 $\rho = 1000$ kg/m³

Ambient Temperature: 22.80C Liquid Temperature: 22.10C

Communication System: LTE Band12 Frequency: 704 MHz Duty Cycle: 1:1

Probe: EX3DV4 - SN7600 ConvF(10.88, 10.88, 10.88)

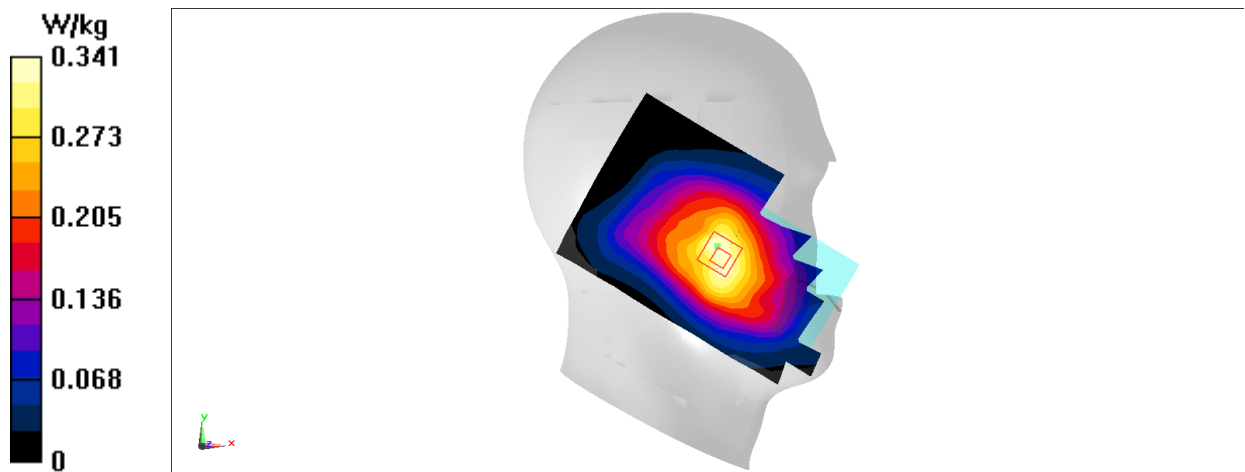
Area Scan (81x131x1): Interpolated grid: dx=1.500 mm, dy=1.500 mm
Maximum value of SAR (interpolated) = 0.341 W/kgZoom Scan (5x5x7)/Cube 0: Measurement grid: dx=8mm, dy=8mm, dz=5mm
Reference Value = 11.63 V/m; Power Drift = -0.09 dB
Peak SAR (extrapolated) = 0.372 W/kg
SAR(1 g) = 0.288 W/kg; SAR(10 g) = 0.227 W/kg
Maximum value of SAR (measured) = 0.343 W/kg**Fig A.17**

LTE750-FDD12_CH23060 Rear

Date: 5/21/2021

Electronics: DAE4 Sn1525

Medium: H750

Medium parameters used (interpolated): $f = 704$ MHz; $\sigma = 0.811$ S/m; $\epsilon_r = 44.061$;
 $\rho = 1000$ kg/m³

Ambient Temperature: 22.8°C Liquid Temperature: 22.1°C

Communication System: LTE Band12 Frequency: 704 MHz Duty Cycle: 1:1

Probe: EX3DV4 - SN7600 ConvF(10.88, 10.88, 10.88)

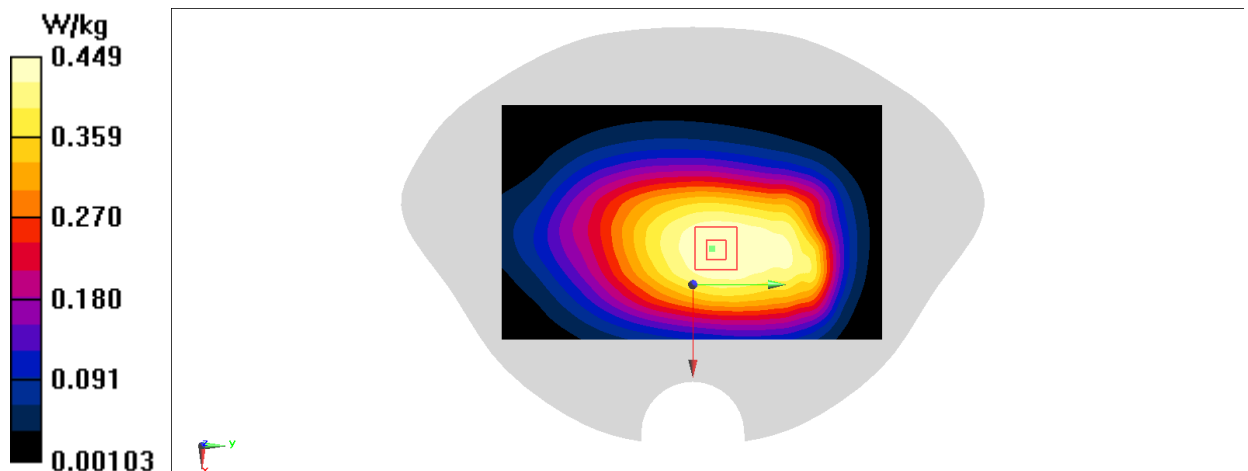
Area Scan (81x131x1): Interpolated grid: dx=1.500 mm, dy=1.500 mm
Maximum value of SAR (interpolated) = 0.449 W/kgZoom Scan (5x5x7)/Cube 0: Measurement grid: dx=8mm, dy=8mm, dz=5mm
Reference Value = 23.93 V/m; Power Drift = -0.01 dB
Peak SAR (extrapolated) = 0.505 W/kg
SAR(1 g) = 0.376 W/kg; SAR(10 g) = 0.293 W/kg
Maximum value of SAR (measured) = 0.455 W/kg**Fig A.18**

LTE750-FDD14_CH23330 Left Cheek

Date: 5/21/2021

Electronics: DAE4 Sn1525

Medium: H750

Medium parameters used (interpolated): $f = 793$ MHz; $\sigma = 0.832$ S/m; $\epsilon_r = 44.835$;
 $\rho = 1000$ kg/m³

Ambient Temperature: 22.80C Liquid Temperature: 22.10C

Communication System: UID 0, LTE Band14 (0) Frequency: 793 MHz Duty Cycle: 1:1

Probe: EX3DV4 - SN7600 ConvF(10.88, 10.88, 10.88)

Area Scan (81x131x1): Interpolated grid: dx=1.500 mm, dy=1.500 mm

Maximum value of SAR (interpolated) = 0.262 W/kg

Zoom Scan (5x5x7)/Cube 0: Measurement grid: dx=8mm, dy=8mm, dz=5mm

Reference Value = 7.351 V/m; Power Drift = 0.08 dB

Peak SAR (extrapolated) = 0.292 W/kg

SAR(1 g) = 0.225 W/kg; SAR(10 g) = 0.177 W/kg

Maximum value of SAR (measured) = 0.264 W/kg

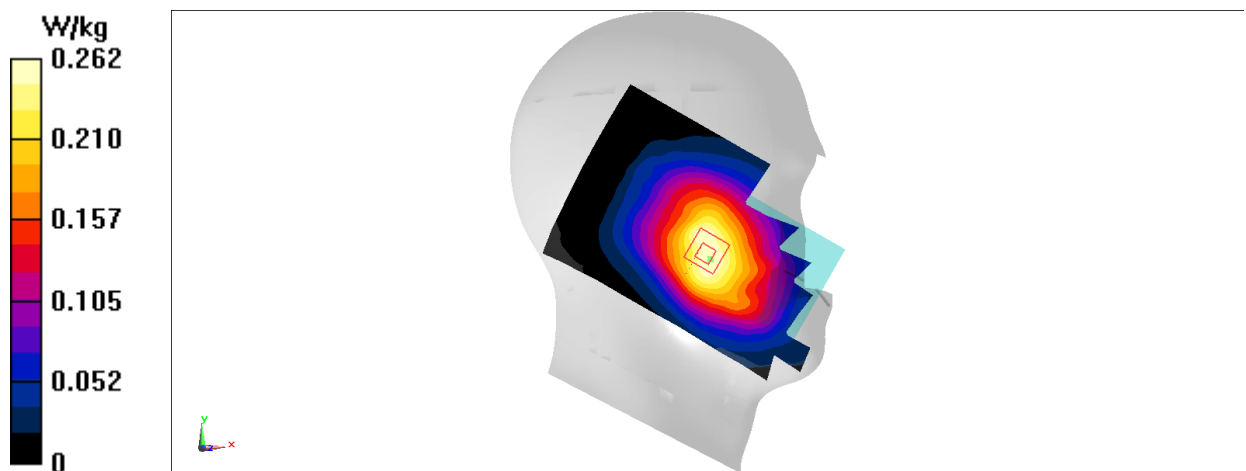
**Fig A.19**

LTE750-FDD14_CH23330 Rear

Date: 5/21/2021

Electronics: DAE4 Sn1525

Medium: H750

Medium parameters used (interpolated): $f = 793 \text{ MHz}$; $\sigma = 0.832 \text{ S/m}$; $\epsilon_r = 44.835$;
 $\rho = 1000 \text{ kg/m}^3$

Ambient Temperature: 22.80C Liquid Temperature: 22.10C

Communication System: LTE Band14 Frequency: 793 MHz Duty Cycle: 1:1

Probe: EX3DV4 - SN7600 ConvF(10.88, 10.88, 10.88)

Area Scan (81x131x1): Interpolated grid: $dx=1.500 \text{ mm}$, $dy=1.500 \text{ mm}$
 Maximum value of SAR (interpolated) = 0.476 W/kg

Zoom Scan (5x5x7)/Cube 0: Measurement grid: $dx=8\text{mm}$, $dy=8\text{mm}$, $dz=5\text{mm}$
 Reference Value = 24.35 V/m; Power Drift = 0.02 dB
 Peak SAR (extrapolated) = 0.535 W/kg
 SAR(1 g) = 0.396 W/kg; SAR(10 g) = 0.307 W/kg
 Maximum value of SAR (measured) = 0.482 W/kg

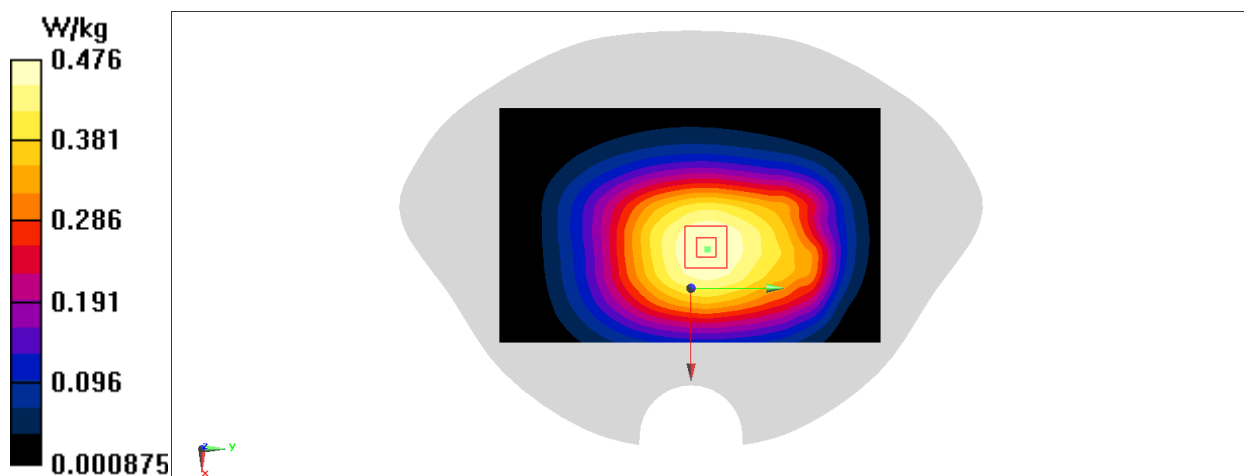

Fig A.20

LTE2300-FDD30_CH27710 Right Cheek

Date: 5/23/2021

Electronics: DAE4 Sn1525

Medium: H2300

Medium parameters used: $f = 2310$ MHz; $\sigma = 1.813$ S/m; $\epsilon_r = 41.039$; $\rho = 1000$ kg/m³

Ambient Temperature: 23.1oC

Liquid Temperature: 22.5oC

Communication System: LTE Band30 Frequency: 2310 MHz Duty Cycle: 1:1

Probe: EX3DV4 - SN7600 ConvF(8.19, 8.19, 8.19)

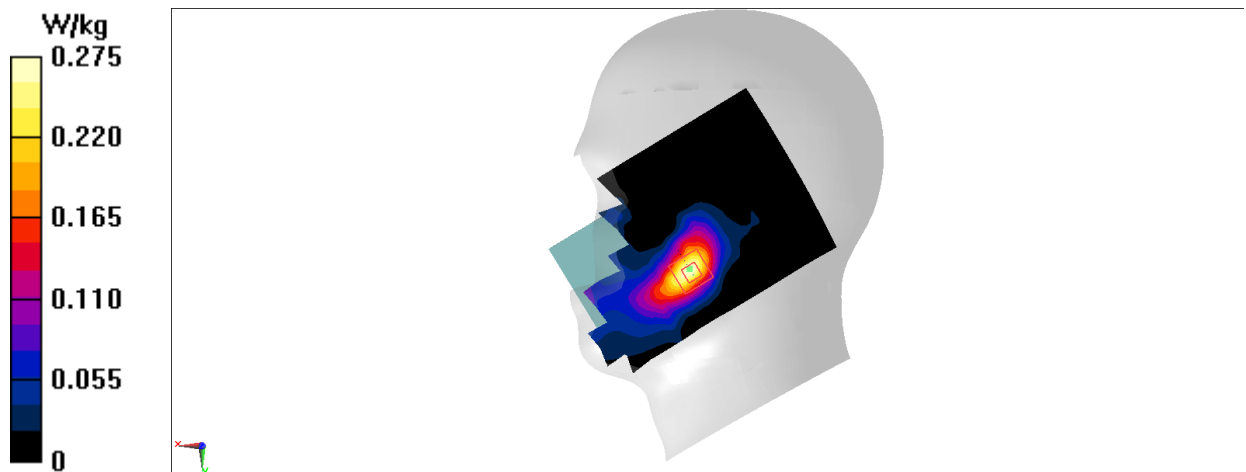
Area Scan (101x161x1): Interpolated grid: dx=1.200 mm, dy=1.200 mm
Maximum value of SAR (interpolated) = 0.275 W/kgZoom Scan (7x7x7)/Cube 0: Measurement grid: dx=5mm, dy=5mm, dz=5mm
Reference Value = 2.504 V/m; Power Drift = -0.15 dB
Peak SAR (extrapolated) = 0.333 W/kg
SAR(1 g) = 0.189 W/kg; SAR(10 g) = 0.102 W/kg
Maximum value of SAR (measured) = 0.278 W/kg**Fig A.21**

LTE2300-FDD30_CH27710 Rear

Date: 5/23/2021

Electronics: DAE4 Sn1525

Medium: H2300

Medium parameters used: $f = 2310$ MHz; $\sigma = 1.813$ S/m; $\epsilon_r = 41.039$; $\rho = 1000$ kg/m³

Ambient Temperature: 23.1oC

Liquid Temperature: 22.5oC

Communication System: LTE Band30 Frequency: 2310 MHz Duty Cycle: 1:1

Probe: EX3DV4 - SN7600 ConvF(8.19, 8.19, 8.19)

Area Scan (101x161x1): Interpolated grid: $dx=1.200$ mm, $dy=1.200$ mm
Maximum value of SAR (interpolated) = 1.51 W/kg

Zoom Scan (7x7x7)/Cube 0: Measurement grid: $dx=5$ mm, $dy=5$ mm, $dz=5$ mm
Reference Value = 6.042 V/m; Power Drift = -0.07 dB
Peak SAR (extrapolated) = 1.97 W/kg
SAR(1 g) = 0.948 W/kg; SAR(10 g) = 0.460 W/kg
Maximum value of SAR (measured) = 1.59 W/kg

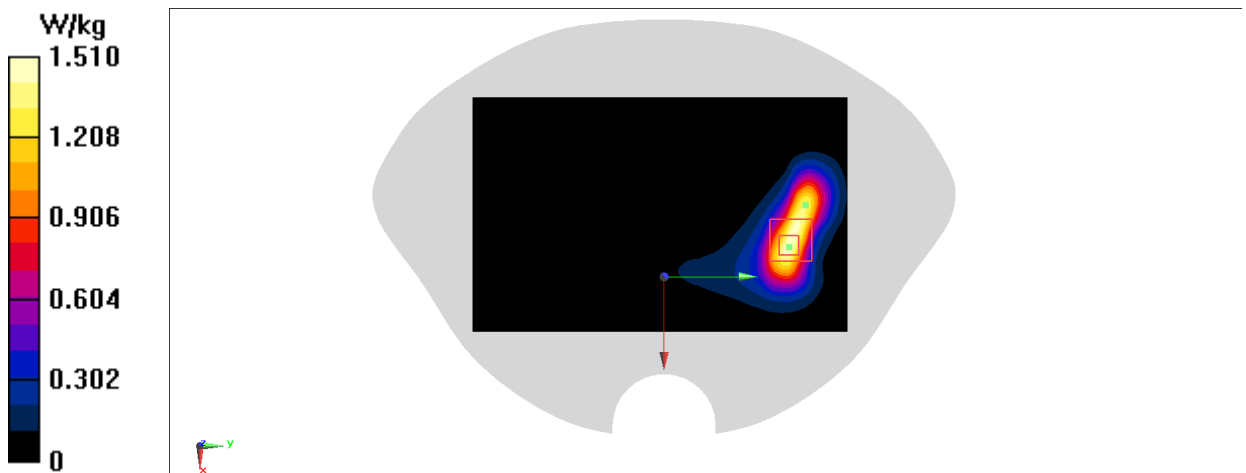
**Fig A.22**

LTE2300-FDD30_CH27710 Rear

Date: 5/28/2021

Electronics: DAE4 Sn1525

Medium: H700-6000 2021-May-21

Medium parameters used: $f = 2310$ MHz; $\sigma = 1.778$ S/m; $\epsilon_r = 39.405$; $\rho = 1000$ kg/m³

Ambient Temperature: 22.9°C

Liquid Temperature: 22.4°C

Communication System: LTE Band30 Frequency: 2310 MHz Duty Cycle: 1:1

Probe: EX3DV4 - SN7600 ConvF(8.19, 8.19, 8.19)

Area Scan (101x161x1): Interpolated grid: $dx=1.200$ mm, $dy=1.200$ mm
Maximum value of SAR (interpolated) = 1.78 W/kg

Zoom Scan (7x9x7)/Cube 0: Measurement grid: $dx=5$ mm, $dy=5$ mm, $dz=5$ mm
Reference Value = 7.084 V/m; Power Drift = -0.08 dB
Peak SAR (extrapolated) = 2.17 W/kg
SAR(1 g) = 1.13 W/kg; SAR(10 g) = 0.588 W/kg
Maximum value of SAR (measured) = 1.77 W/kg

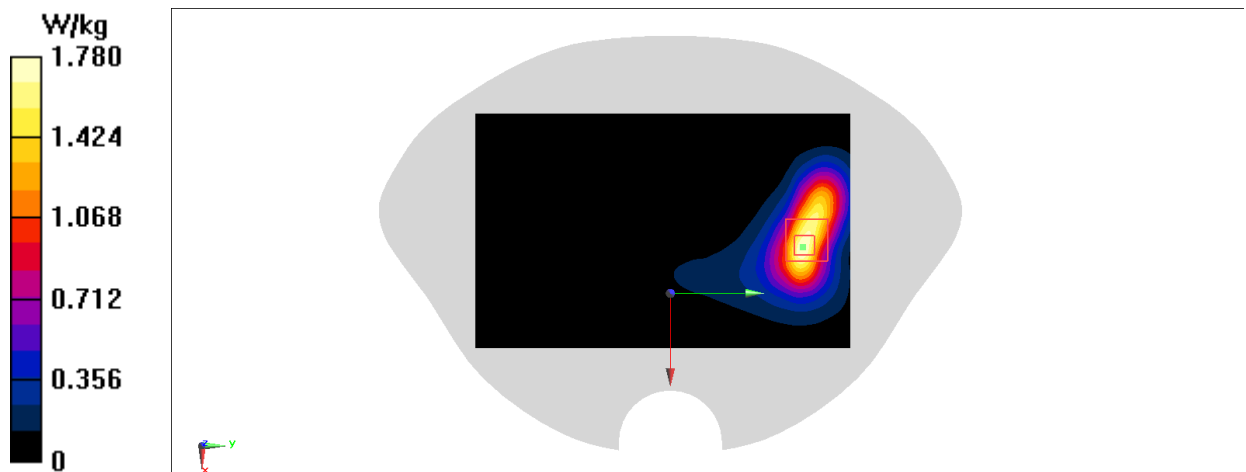

Fig A.23

WLAN2450_CH6 Left Tilt

Date: 5/26/2021

Electronics: DAE4 Sn1525

Medium: H2450

Medium parameters used (interpolated): $f = 2437$ MHz; $\sigma = 1.911$ S/m; $\epsilon_r = 40.758$;
 $\rho = 1000$ kg/m³

Ambient Temperature: 23.2oC

Liquid Temperature: 22.7oC

Communication System: WIFI 2450 Frequency: 2437 MHz Duty Cycle: 1:1

Probe: EX3DV4 - SN7600 ConvF(7.79, 7.79, 7.79)

Area Scan (101x161x1): Interpolated grid: dx=1.200 mm, dy=1.200 mm
 Maximum value of SAR (interpolated) = 1.01 W/kg

Zoom Scan (8x8x7)/Cube 0: Measurement grid: dx=5mm, dy=5mm, dz=5mm
 Reference Value = 12.42 V/m; Power Drift = 0.02 dB
 Peak SAR (extrapolated) = 1.50 W/kg
 SAR(1 g) = 0.613 W/kg; SAR(10 g) = 0.294 W/kg
 Maximum value of SAR (measured) = 1.09 W/kg

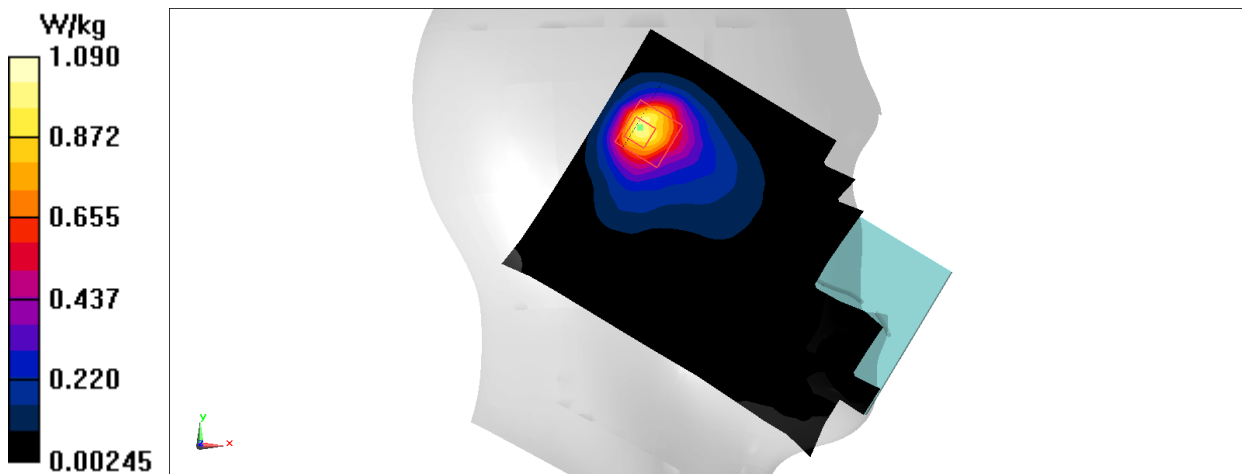

Fig A.24

WLAN2450_CH6 Rear

Date: 5/26/2021

Electronics: DAE4 Sn1525

Medium: H2450

Medium parameters used (interpolated): $f = 2437$ MHz; $\sigma = 1.911$ S/m; $\epsilon_r = 40.758$;
 $\rho = 1000$ kg/m³

Ambient Temperature:23.2oC

Liquid Temperature: 22.7oC

Communication System: WIFI 2450 Frequency: 2437 MHz Duty Cycle: 1:1

Probe: EX3DV4 - SN7600 ConvF(7.79, 7.79, 7.79)

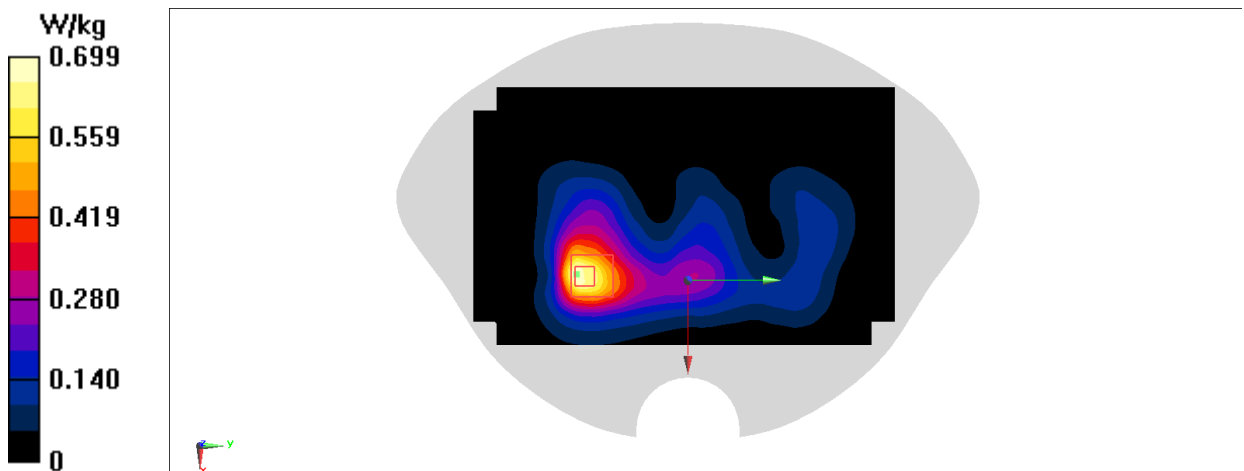
Area Scan (111x181x1): Interpolated grid: dx=1.200 mm, dy=1.200 mm
Maximum value of SAR (interpolated) = 0.699 W/kgZoom Scan (8x8x7)/Cube 0: Measurement grid: dx=5mm, dy=5mm, dz=5mm
Reference Value = 10.13 V/m; Power Drift = -0.12 dB
Peak SAR (extrapolated) = 0.943 W/kg
SAR(1 g) = 0.431 W/kg; SAR(10 g) = 0.219 W/kg
Maximum value of SAR (measured) = 0.720 W/kg**Fig A.25**

WLAN5G_CH118 Left Tilt

Date: 6/3/2021

Electronics: DAE4 Sn1525

Medium: H5G

Medium parameters used: $f = 5590$ MHz; $\sigma = 5.138$ S/m; $\epsilon_r = 34.106$; $\rho = 1000$ kg/m³

Ambient Temperature: 23.9°C

Liquid Temperature: 22.5°C

Communication System: WLAN 11n 40M Frequency: 5590 MHz Duty Cycle: 1:1

Probe: EX3DV4 - SN7600 ConvF(5.11, 5.11, 5.11)

Area Scan (121x201x1): Interpolated grid: dx=1.000 mm, dy=1.000 mm

Maximum value of SAR (interpolated) = 1.52 W/kg

Zoom Scan (10x10x7)/Cube 0: Measurement grid: dx=4mm, dy=4mm, dz=1.4mm

Reference Value = 2.430 V/m; Power Drift = 0.13 dB

Peak SAR (extrapolated) = 2.52 W/kg

SAR(1 g) = 0.574 W/kg; SAR(10 g) = 0.153 W/kg

Maximum value of SAR (measured) = 1.46 W/kg

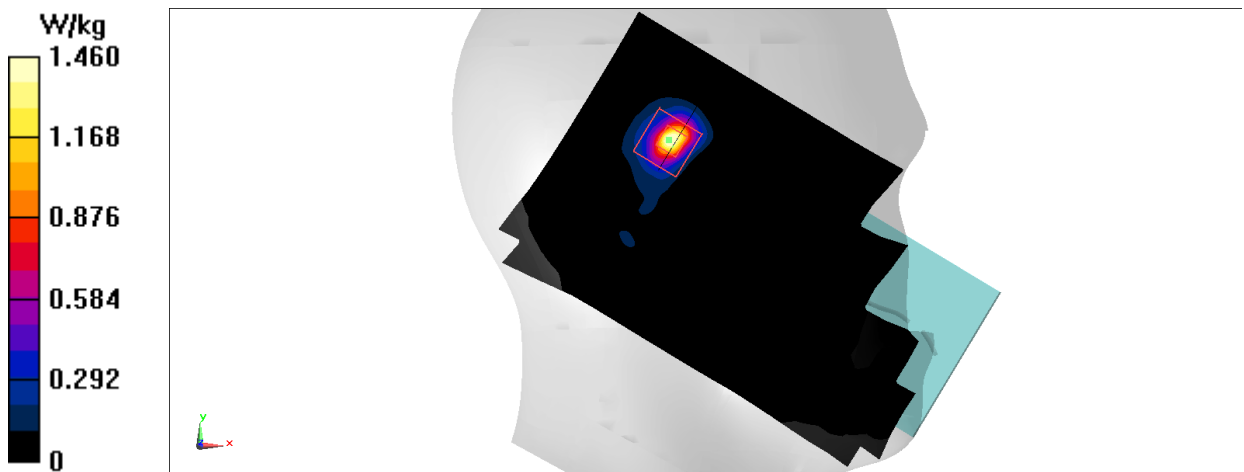
**Fig A.26**

WLAN5G_CH118 Top

Date: 6/3/2021

Electronics: DAE4 Sn1525

Medium: H5G

Medium parameters used: $f = 5590$ MHz; $\sigma = 5.138$ S/m; $\epsilon_r = 34.106$; $\rho = 1000$ kg/m³

Ambient Temperature: 23.9°C

Liquid Temperature: 22.5°C

Communication System: WLAN 11n 40M Frequency: 5590 MHz Duty Cycle: 1:1

Probe: EX3DV4 - SN7600 ConvF(5.11, 5.11, 5.11)

Area Scan (121x201x1): Interpolated grid: dx=1.000 mm, dy=1.000 mm

Maximum value of SAR (interpolated) = 0.804 W/kg

Zoom Scan (10x10x7)/Cube 0: Measurement grid: dx=4mm, dy=4mm, dz=1.4mm

Reference Value = 1.522 V/m; Power Drift = 4.00 dB

Peak SAR (extrapolated) = 1.38 W/kg

SAR(1 g) = 0.329 W/kg; SAR(10 g) = 0.115 W/kg

Maximum value of SAR (measured) = 0.785 W/kg

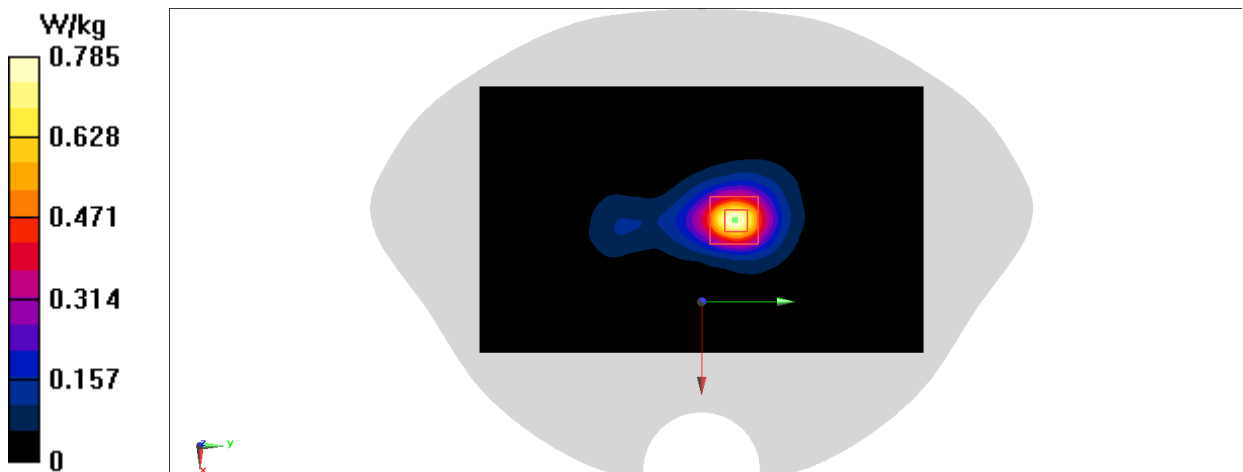

Fig A.27

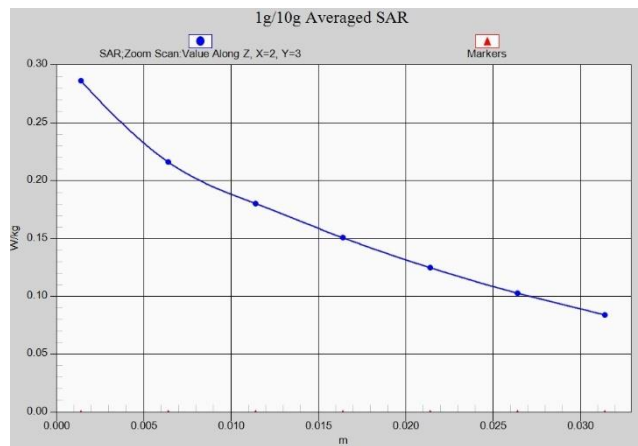

Fig. 1-1 Z-Scan at power reference point (WCDMA850)



Fig. 1-2 Z-Scan at power reference point (WCDMA850)

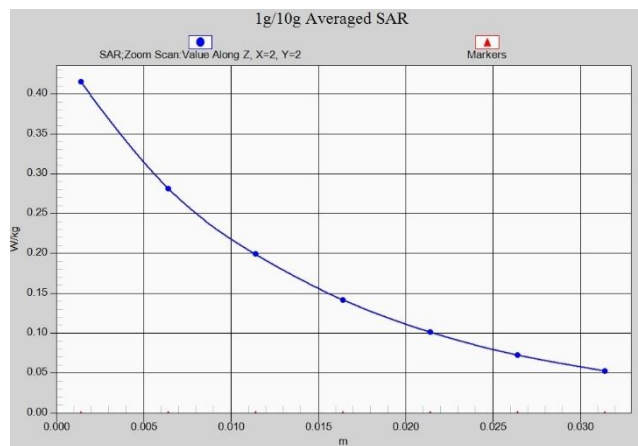

Fig. 1-3 Z-Scan at power reference point (WCDMA1700)

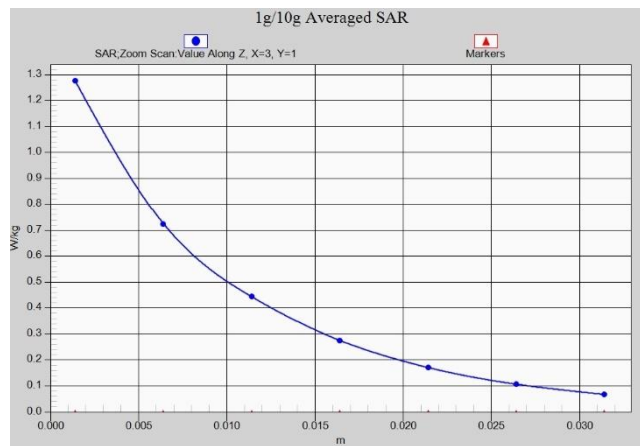

Fig. 1-4 Z-Scan at power reference point (WCDMA1700)

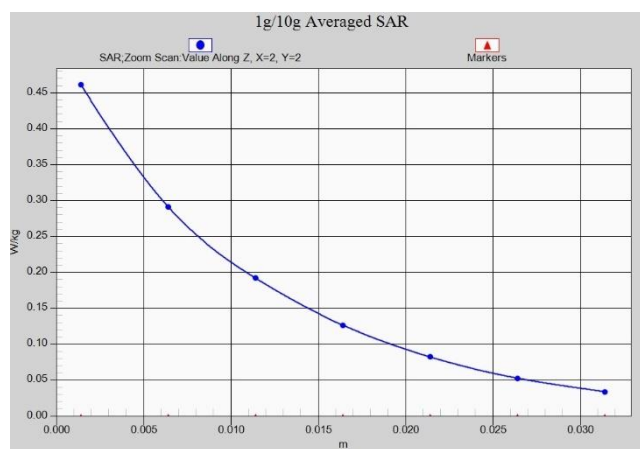

Fig. 1-5 Z-Scan at power reference point (WCDMA1700)

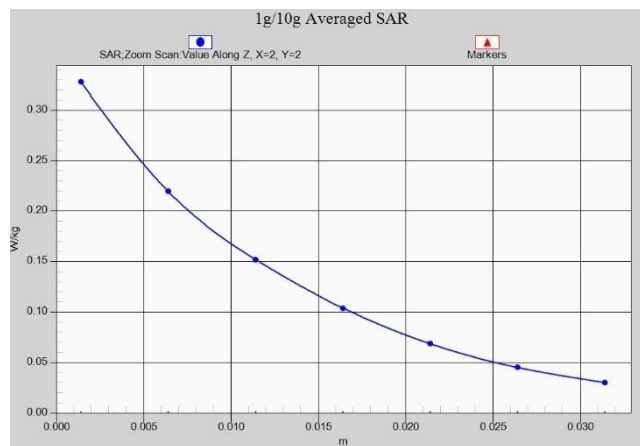

Fig. 1-6 Z-Scan at power reference point (WCDMA1900)

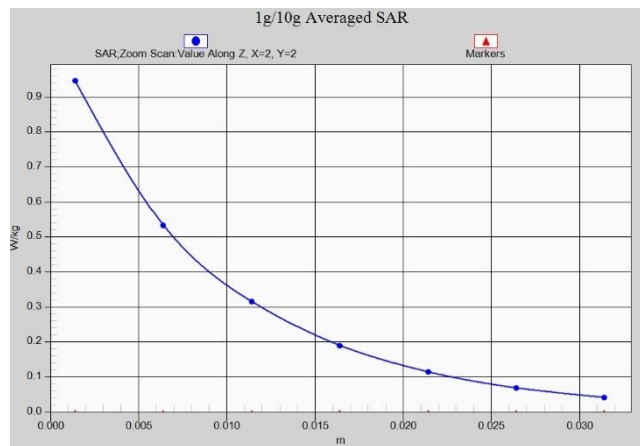

Fig. 1-7 Z-Scan at power reference point (WCDMA1900)



Fig. 1-8 Z-Scan at power reference point (WCDMA1900)

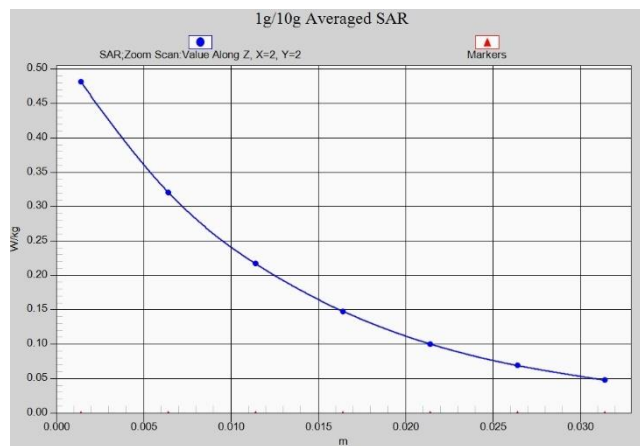

Fig. 1-9 Z-Scan at power reference point (LTE Band2)

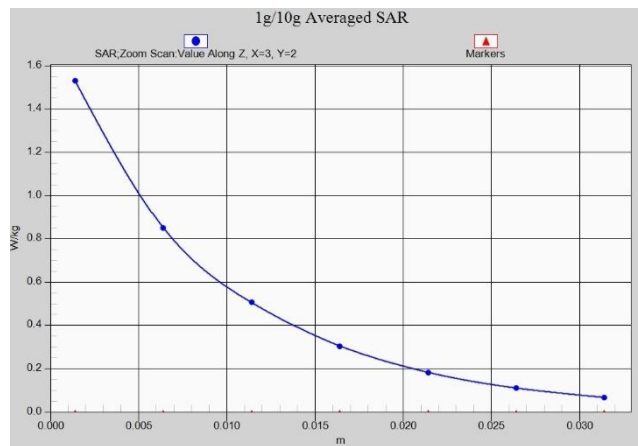

Fig. 1-10 Z-Scan at power reference point (LTE Band2)

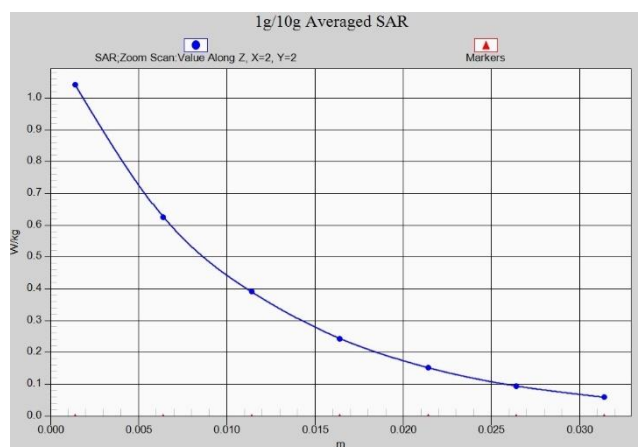

Fig. 1-11 Z-Scan at power reference point (LTE Band2)

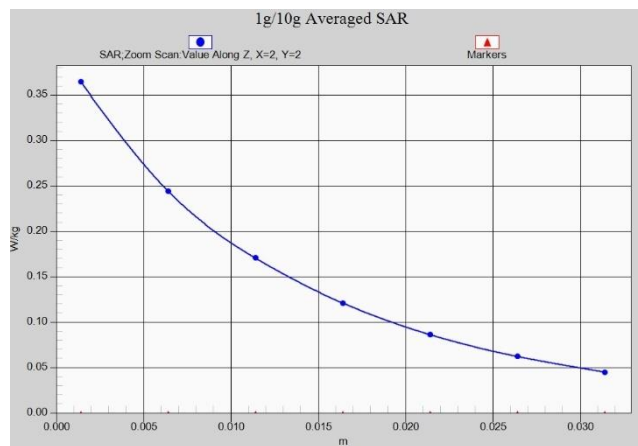

Fig. 1-12 Z-Scan at power reference point (LTE Band 4)

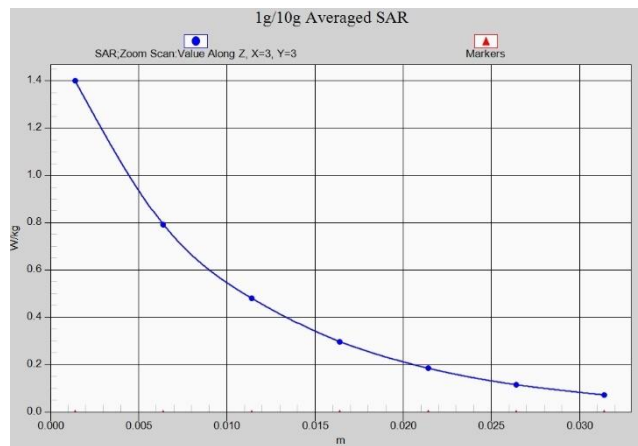

Fig. 1-13 Z-Scan at power reference point (LTE Band 4)

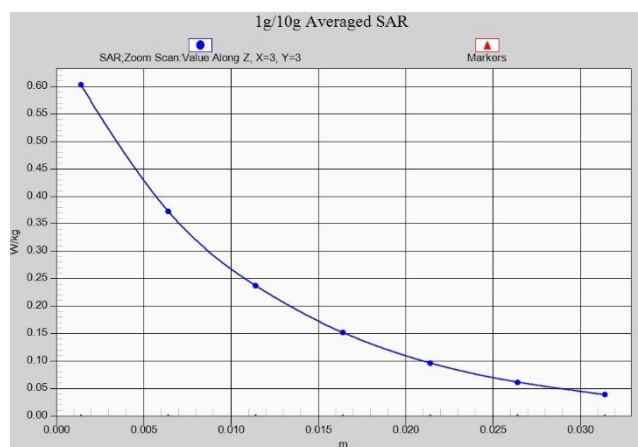

Fig. 1-14 Z-Scan at power reference point (LTE Band 4)

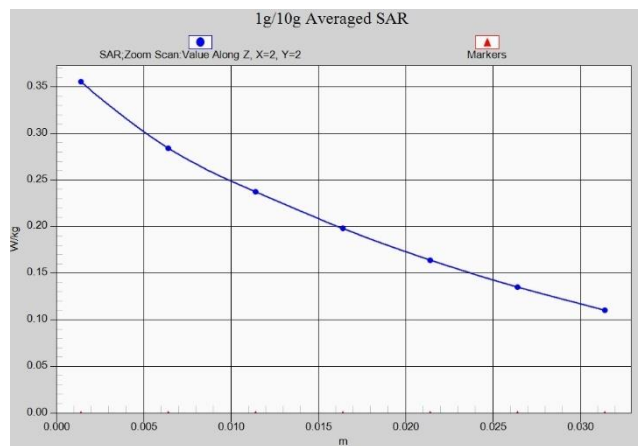

Fig. 1-15 Z-Scan at power reference point (LTE Band 5)

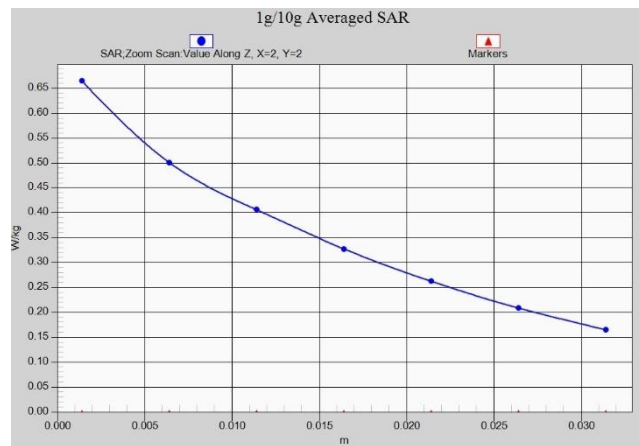

Fig. 1-16 Z-Scan at power reference point (LTE Band 5)

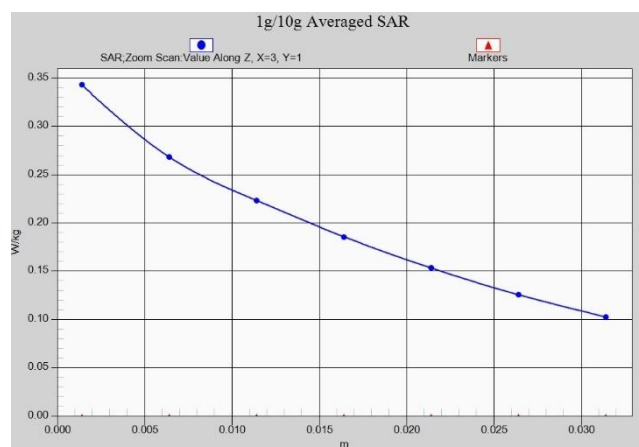

Fig. 1-17 Z-Scan at power reference point (LTE Band 12)

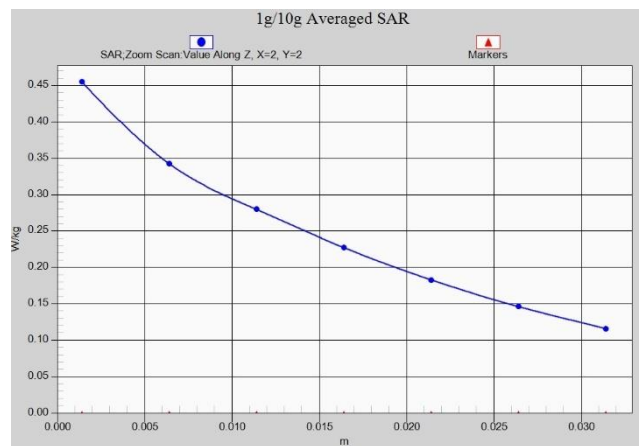

Fig. 1-18 Z-Scan at power reference point (LTE Band 12)

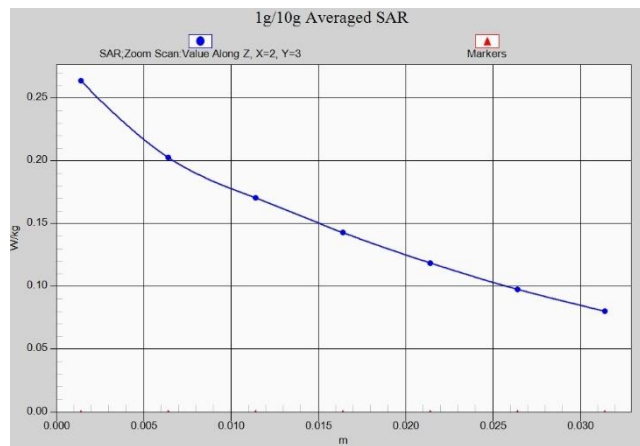

Fig. 1-19 Z-Scan at power reference point (LTE Band14)

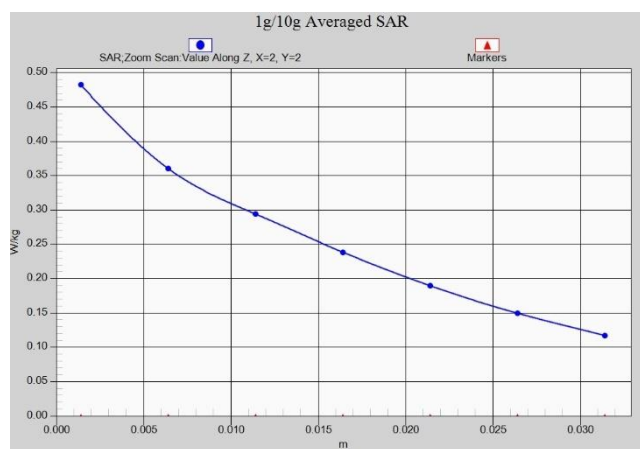

Fig. 1-20 Z-Scan at power reference point (LTE Band14)

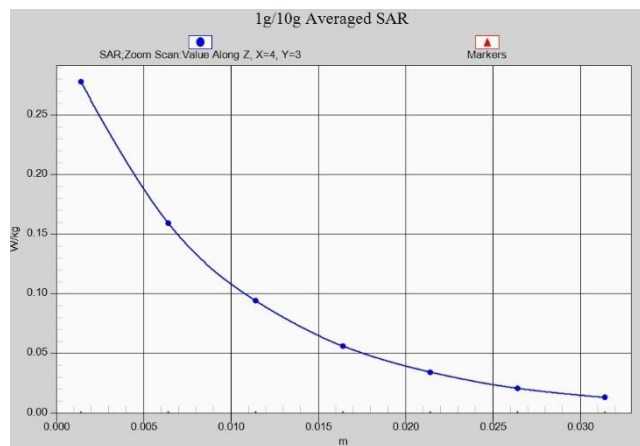

Fig. 1-24 Z-Scan at power reference point (LTE Band30)

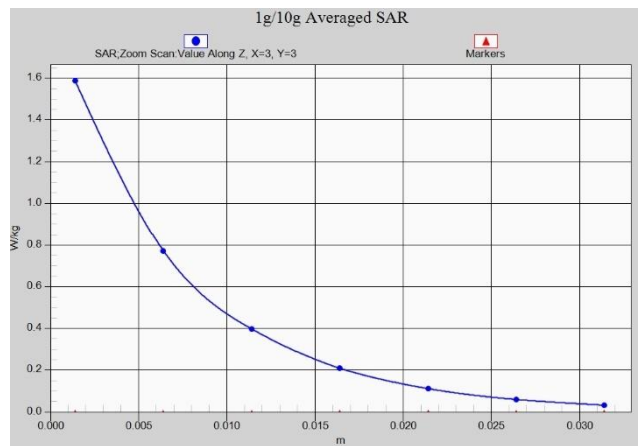

Fig. 1-22 Z-Scan at power reference point (LTE Band30)

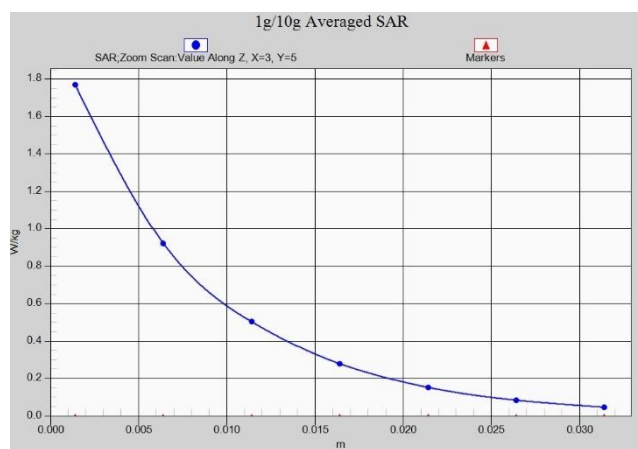

Fig. 1-23 Z-Scan at power reference point (LTE Band30)

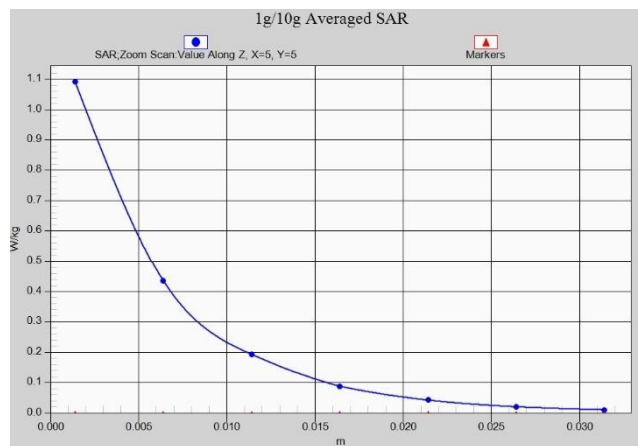

Fig. 1-24 Z-Scan at power reference point (2450 MHz)

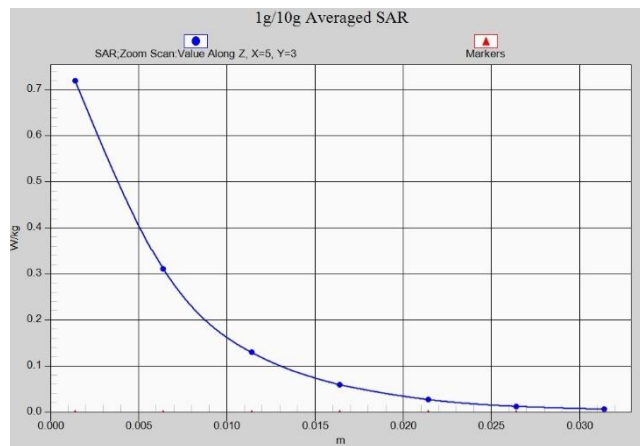

Fig. 1-25 Z-Scan at power reference point (2450 MHz)

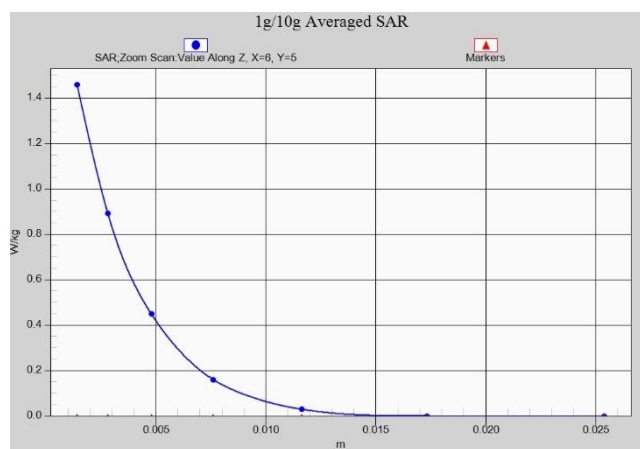

Fig. 1-26 Z-Scan at power reference point (5G)

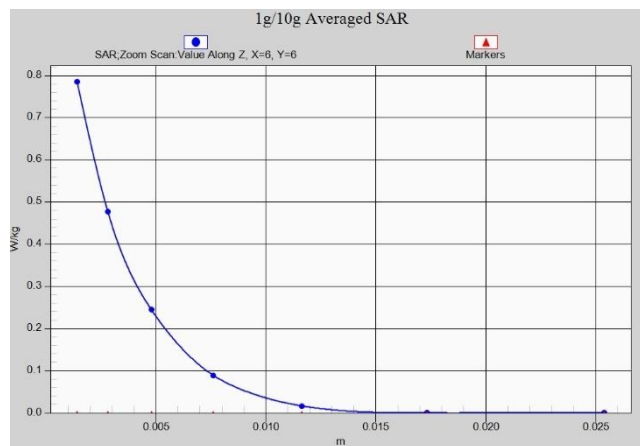

Fig. 1-27 Z-Scan at power reference point (5G)

ANNEX B System Verification Results

750 MHz

Date: 5/21/2021

Electronics: DAE4 Sn1525

Medium: H750

Medium parameters used: $f = 750 \text{ MHz}$; $\sigma = 0.831 \text{ S/m}$; $\epsilon_r = 43.891$; $\rho = 1000 \text{ kg/m}^3$

Ambient Temperature: 22.8oC Liquid Temperature: 22.1oC

Communication System: CW Frequency: 750 MHz Duty Cycle: 1:1

Probe: EX3DV4 - SN7600 ConvF(10.88, 10.88, 10.88)

Area Scan (51x141x1): Interpolated grid: $dx=1.500 \text{ mm}$, $dy=1.500 \text{ mm}$

Reference Value = 43.88 V/m; Power Drift = 0.15 dB

Fast SAR: SAR(1 g) = 2.21 W/kg; SAR(10 g) = 1.48 W/kg

Maximum value of SAR (interpolated) = 2.87 W/kg

Zoom Scan (5x5x7)/Cube 0: Measurement grid: $dx=8\text{mm}$, $dy=8\text{mm}$, $dz=5\text{mm}$

Reference Value = 43.88 V/m; Power Drift = 0.15 dB

Peak SAR (extrapolated) = 3.43 W/kg

SAR(1 g) = 2.15 W/kg; SAR(10 g) = 1.43 W/kg

Maximum value of SAR (measured) = 2.92 W/kg

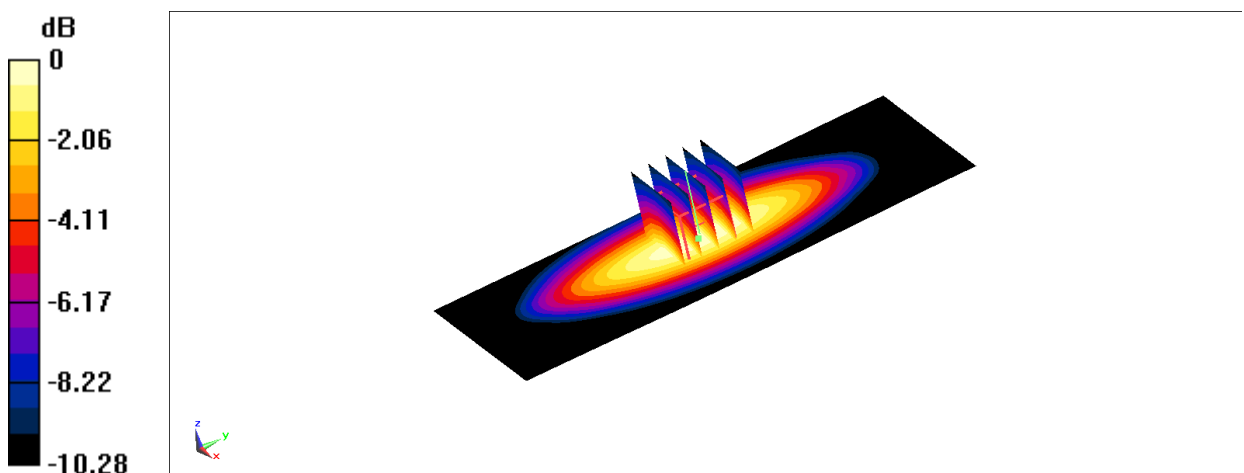

$$0 \text{ dB} = 2.92 \text{ W/kg} = 4.65 \text{ dBW/kg}$$

$$0 \text{ dB} = 2.86 \text{ W/kg} = 4.56 \text{ dB W/kg}$$

Fig.B.1 validation 750 MHz 250mW

750 MHz

Date: 5/21/2021

Electronics: DAE4 Sn1525

Medium: H750

Medium parameters used: $f = 750$ MHz; $\sigma = 0.815$ S/m; $\epsilon_r = 44.991$; $\rho = 1000$ kg/m³

Ambient Temperature: 22.8°C Liquid Temperature: 22.1°C

Communication System: CW Frequency: 750 MHz Duty Cycle: 1:1

Probe: EX3DV4 - SN7600 ConvF(10.88, 10.88, 10.88)

Area Scan (51x141x1): Interpolated grid: dx=1.500 mm, dy=1.500 mm

Reference Value = 43.42 V/m; Power Drift = 0.17 dB

Fast SAR: SAR(1 g) = 2.19 W/kg; SAR(10 g) = 1.41 W/kg

Maximum value of SAR (interpolated) = 2.81 W/kg

Zoom Scan (5x5x7)/Cube 0: Measurement grid: dx=8mm, dy=8mm, dz=5mm

Reference Value = 43.42 V/m; Power Drift = 0.17 dB

Peak SAR (extrapolated) = 3.24 W/kg

SAR(1 g) = 2.02 W/kg; SAR(10 g) = 1.34 W/kg

Maximum value of SAR (measured) = 2.75 W/kg

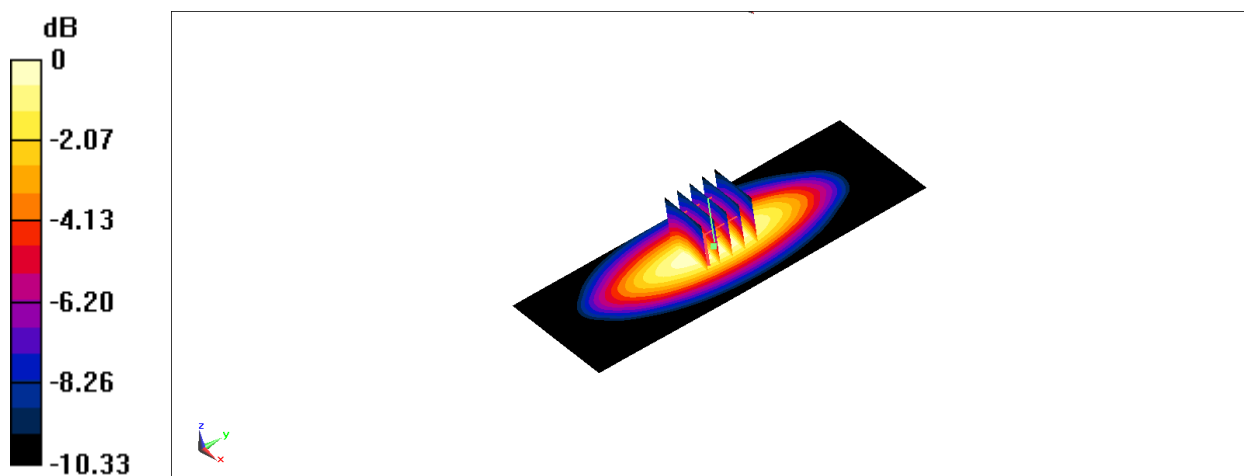

0 dB = 2.75 W/kg = 4.39 dBW/kg

Fig.B.2 validation 750 MHz 250mW

835 MHz

Date: 5/20/2021

Electronics: DAE4 Sn1525

Medium: H835

Medium parameters used: $f = 835$ MHz; $\sigma = 0.852$ S/m; $\epsilon_r = 44.676$; $\rho = 1000$ kg/m³

Ambient Temperature: 23.2°C Liquid Temperature: 22.6°C

Communication System: CW Frequency: 835 MHz Duty Cycle: 1:1

Probe: EX3DV4 - SN7600 ConvF(10.88, 10.88, 10.88)

Area Scan (51x141x1): Interpolated grid: dx=1.500 mm, dy=1.500 mm

Reference Value = 47.26 V/m; Power Drift = 0.19 dB

Fast SAR: SAR(1 g) = 2.28 W/kg; SAR(10 g) = 1.5 W/kg

Maximum value of SAR (interpolated) = 2.95 W/kg

Zoom Scan (5x5x7)/Cube 0: Measurement grid: dx=8mm, dy=8mm, dz=5mm

Reference Value = 47.26 V/m; Power Drift = 0.19 dB

Peak SAR (extrapolated) = 3.61 W/kg

SAR(1 g) = 2.31 W/kg; SAR(10 g) = 1.52 W/kg

Maximum value of SAR (measured) = 3.08 W/kg

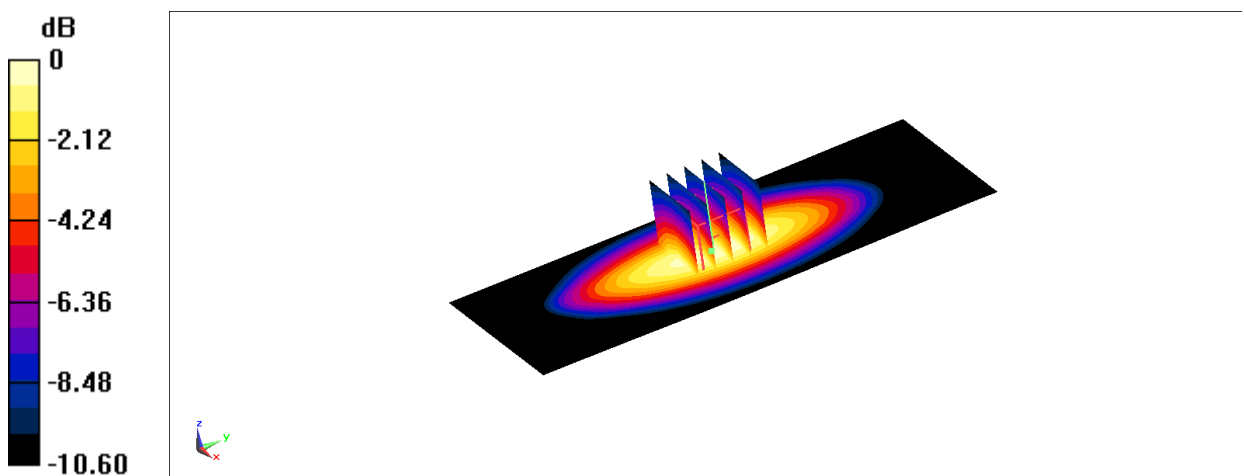

0 dB = 3.08 W/kg = 4.89 dBW/kg

Fig.B.3 validation 835 MHz 250mW

1750 MHz

Date: 5/22/2021

Electronics: DAE4 Sn1525

Medium: H1750

Medium parameters used: $f = 1750$ MHz; $\sigma = 1.377$ S/m; $\epsilon_r = 42.022$; $\rho = 1000$ kg/m³

Ambient Temperature: 22.9°C Liquid Temperature: 22.3°C

Communication System: CW Frequency: 1750 MHz Duty Cycle: 1:1

Probe: EX3DV4 - SN7600 ConvF(9.01, 9.01, 9.01)

Area Scan (51x141x1): Interpolated grid: dx=1.500 mm, dy=1.500 mm

Reference Value = 56.03 V/m; Power Drift = 0.19 dB

Fast SAR: SAR(1 g) = 9.8 W/kg; SAR(10 g) = 5.2 W/kg

Maximum value of SAR (interpolated) = 14.8 W/kg

Zoom Scan (5x5x7)/Cube 0: Measurement grid: dx=8mm, dy=8mm, dz=5mm

Reference Value = 56.03 V/m; Power Drift = 0.19 dB

Peak SAR (extrapolated) = 18.0 W/kg

SAR(1 g) = 9.6 W/kg; SAR(10 g) = 5.06 W/kg

Maximum value of SAR (measured) = 14.5 W/kg

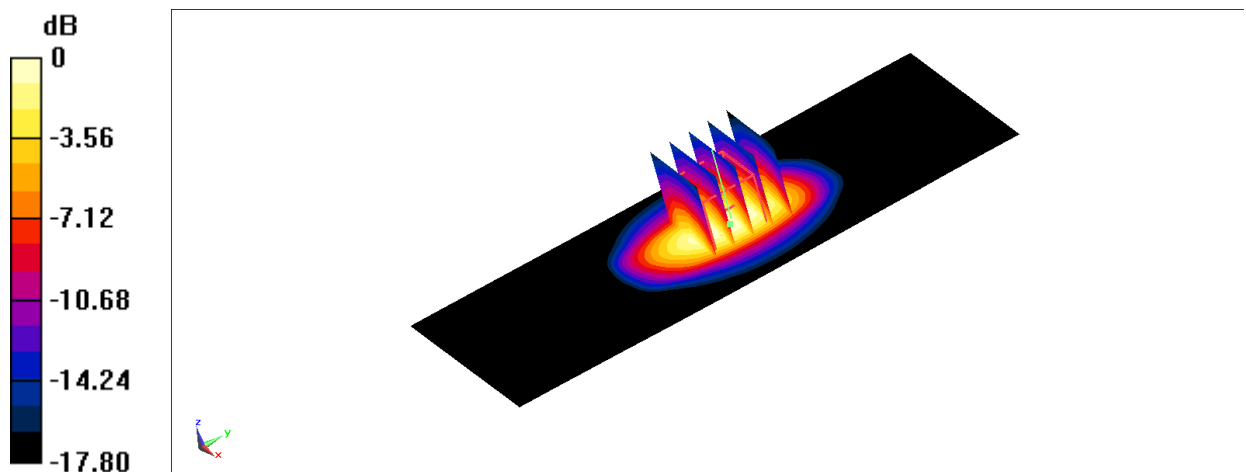

0 dB = 14.5 W/kg = 11.61 dBW/kg

Fig.B.4 validation 1750 MHz 250mW

1750 MHz

Date: 5/23/2021

Electronics: DAE4 Sn1525

Medium: H1750

Medium parameters used: $f = 1750$ MHz; $\sigma = 1.377$ S/m; $\epsilon_r = 42.022$; $\rho = 1000$ kg/m³

Ambient Temperature: 23.10C

Liquid Temperature: 22.50C

Communication System: CW Frequency: 1750 MHz Duty Cycle: 1:1

Probe: EX3DV4 - SN7600 ConvF(9.01, 9.01, 9.01)

Area Scan (51x141x1): Interpolated grid: dx=1.500 mm, dy=1.500 mm

Reference Value = 55.36 V/m; Power Drift = 0.13 dB

Fast SAR: SAR(1 g) = 9.79 W/kg; SAR(10 g) = 5.19 W/kg

Maximum value of SAR (interpolated) = 14.8 W/kg

Zoom Scan (5x5x7)/Cube 0: Measurement grid: dx=8mm, dy=8mm, dz=5mm

Reference Value = 55.36 V/m; Power Drift = 0.13 dB

Peak SAR (extrapolated) = 18.4 W/kg

SAR(1 g) = 9.73 W/kg; SAR(10 g) = 5.14 W/kg

Maximum value of SAR (measured) = 14.8 W/kg

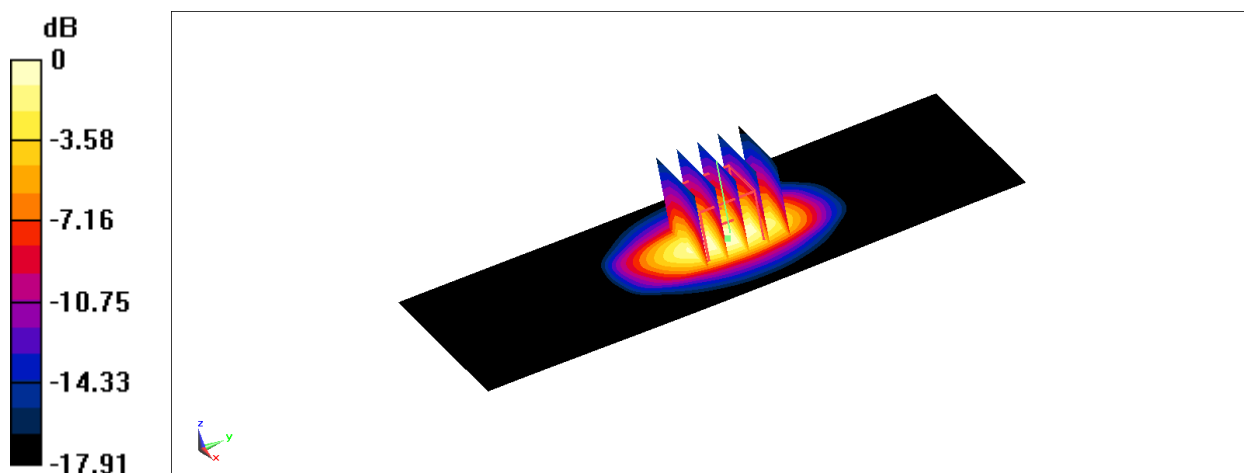

0 dB = 14.8 W/kg = 11.70 dBW/kg

Fig.B.5 validation 1750 MHz 250mW

1900 MHz

Date: 5/22/2021

Electronics: DAE4 Sn1525

Medium: H700-6000(21-1) 2021-May-18

Medium parameters used: $f = 1900$ MHz; $\sigma = 1.443$ S/m; $\epsilon_r = 42.028$; $\rho = 1000$ kg/m³

Ambient Temperature: 22.90C

Liquid Temperature: 22.30C

Communication System: CW Frequency: 1900 MHz Duty Cycle: 1:1

Probe: EX3DV4 - SN7600 ConvF(8.7, 8.7, 8.7)

Area Scan (51x141x1): Interpolated grid: dx=1.500 mm, dy=1.500 mm

Reference Value = 38.78 V/m; Power Drift = 0.12 dB

Fast SAR: SAR(1 g) = 9.41 W/kg; SAR(10 g) = 4.67 W/kg

Maximum value of SAR (interpolated) = 14.3 W/kg

Zoom Scan (5x5x7)/Cube 0: Measurement grid: dx=8mm, dy=8mm, dz=5mm

Reference Value = 38.78 V/m; Power Drift = 0.12 dB

Peak SAR (extrapolated) = 18.0 W/kg

SAR(1 g) = 9.52 W/kg; SAR(10 g) = 4.89 W/kg

Maximum value of SAR (measured) = 14.5 W/kg

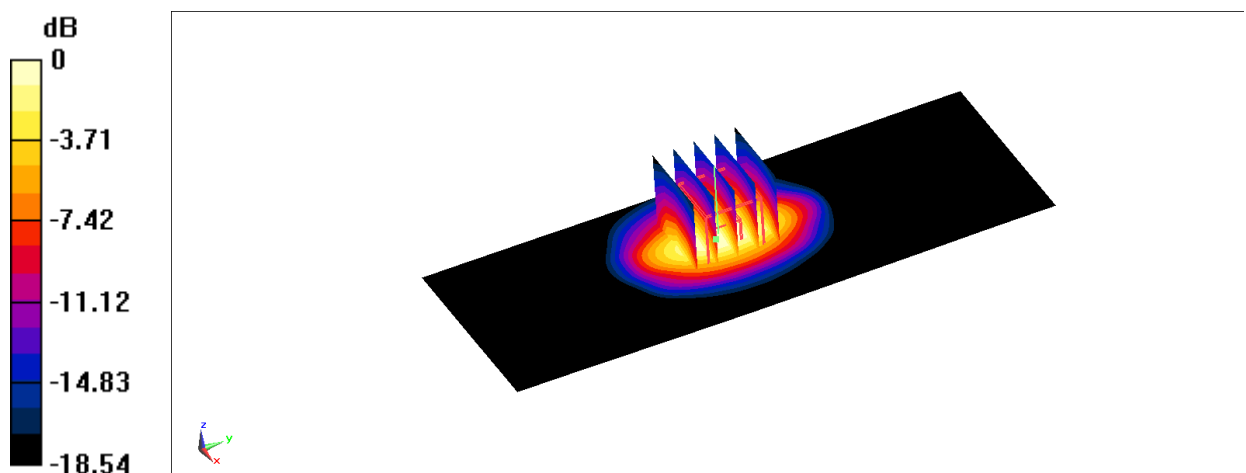

0 dB = 14.5 W/kg = 11.61 dBW/kg

Fig.B.6 validation 1900 MHz 250mW

1900 MHz

Date: 5/23/2021

Electronics: DAE4 Sn1525

Medium: H1900

Medium parameters used: $f = 1900$ MHz; $\sigma = 1.443$ S/m; $\epsilon_r = 42.028$; $\rho = 1000$ kg/m³

Ambient Temperature: 23.10C

Liquid Temperature: 22.50C

Communication System: UID 0, CW (0) Frequency: 1900 MHz Duty Cycle: 1:1

Probe: EX3DV4 - SN7600 ConvF(8.7, 8.7, 8.7)

Area Scan (51x141x1): Interpolated grid: $dx=1.500$ mm, $dy=1.500$ mm

Reference Value = 38.09 V/m; Power Drift = 0.19 dB

Fast SAR: SAR(1 g) = 10.1 W/kg; SAR(10 g) = 5 W/kg

Maximum value of SAR (interpolated) = 15.3 W/kg

Zoom Scan (5x5x7)/Cube 0: Measurement grid: $dx=8$ mm, $dy=8$ mm, $dz=5$ mm

Reference Value = 38.09 V/m; Power Drift = 0.19 dB

Peak SAR (extrapolated) = 19.9 W/kg

SAR(1 g) = 10.4 W/kg; SAR(10 g) = 5.37 W/kg

Maximum value of SAR (measured) = 15.8 W/kg

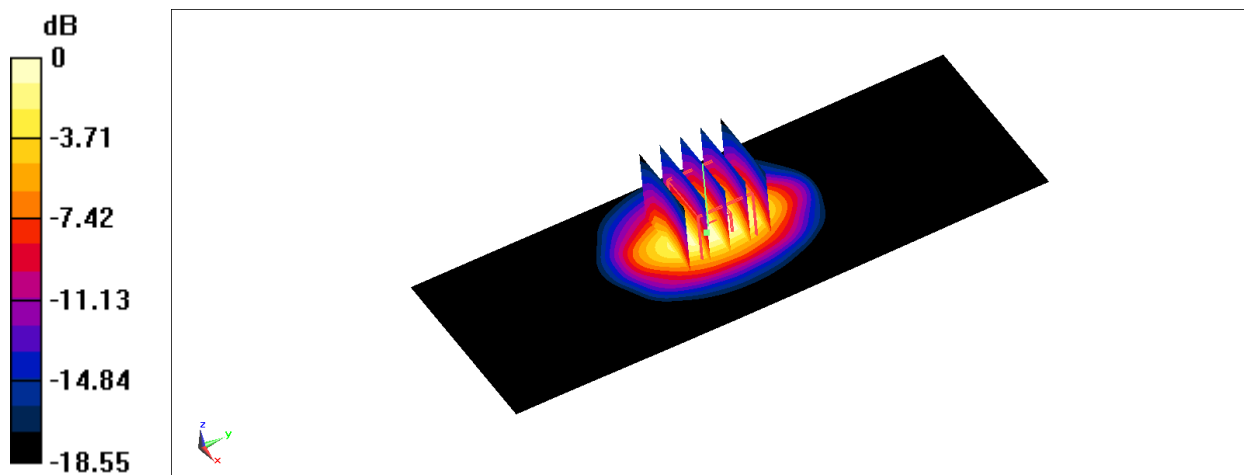

0 dB = 15.8 W/kg = 11.99 dBW/kg

Fig.B.7 validation 1900 MHz 250mW

2300 MHz

Date: 5/23/2021

Electronics: DAE4 Sn1525

Medium: H2300

Medium parameters used: $f = 2300$ MHz; $\sigma = 1.805$ S/m; $\epsilon_r = 41.066$; $\rho = 1000$ kg/m³

Ambient Temperature: 23.10C

Liquid Temperature: 22.50C

Communication System: CW Frequency: 2300 MHz Duty Cycle: 1:1

Probe: EX3DV4 - SN7600 ConvF(8.19, 8.19, 8.19)

Area Scan (61x171x1): Interpolated grid: $dx=1.200$ mm, $dy=1.200$ mm

Reference Value = 46.11 V/m; Power Drift = 0.18 dB

Fast SAR: SAR(1 g) = 12.56 W/kg; SAR(10 g) = 5.93 W/kg

Maximum value of SAR (interpolated) = 20.2 W/kg

Zoom Scan (7x7x7)/Cube 0: Measurement grid: $dx=5$ mm, $dy=5$ mm, $dz=5$ mm

Reference Value = 46.11 V/m; Power Drift = 0.18 dB

Peak SAR (extrapolated) = 25.2 W/kg

SAR(1 g) = 12.2 W/kg; SAR(10 g) = 5.74 W/kg

Maximum value of SAR (measured) = 19.7 W/kg

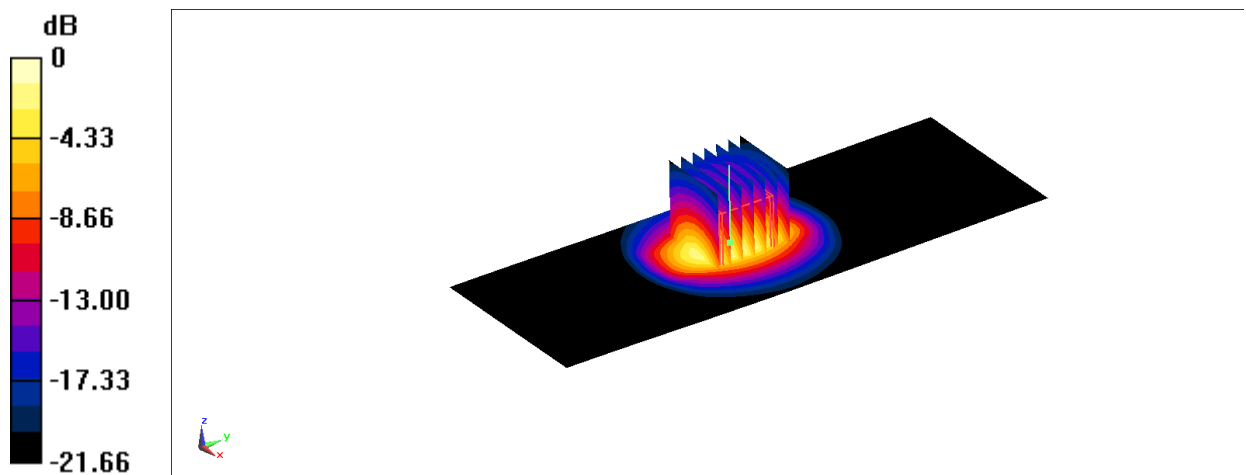

0 dB = 19.7 W/kg = 12.94 dBW/kg

Fig.B.8 validation 2300 MHz 250mW

2300 MHz

Date: 5/28/2021

Electronics: DAE4 Sn1525

Medium: H2300

Medium parameters used: $f = 2300$ MHz; $\sigma = 1.769$ S/m; $\epsilon_r = 39.425$; $\rho = 1000$ kg/m³

Ambient Temperature: 22.9°C

Liquid Temperature: 22.4°C

Communication System: CW Frequency: 2300 MHz Duty Cycle: 1:1

Probe: EX3DV4 - SN7600 ConvF(8.19, 8.19, 8.19)

Area Scan (61x121x1): Interpolated grid: $dx=1.200$ mm, $dy=1.200$ mm

Reference Value = 81.13 V/m; Power Drift = 0.15 dB

Fast SAR: SAR(1 g) = 12.66 W/kg; SAR(10 g) = 5.98 W/kg

Maximum value of SAR (interpolated) = 20.1 W/kg

Zoom Scan (7x7x7)/Cube 0: Measurement grid: $dx=5$ mm, $dy=5$ mm, $dz=5$ mm

Reference Value = 81.13 V/m; Power Drift = 0.15 dB

Peak SAR (extrapolated) = 26.1 W/kg

SAR(1 g) = 12.3 W/kg; SAR(10 g) = 5.8 W/kg

Maximum value of SAR (measured) = 20.2 W/kg

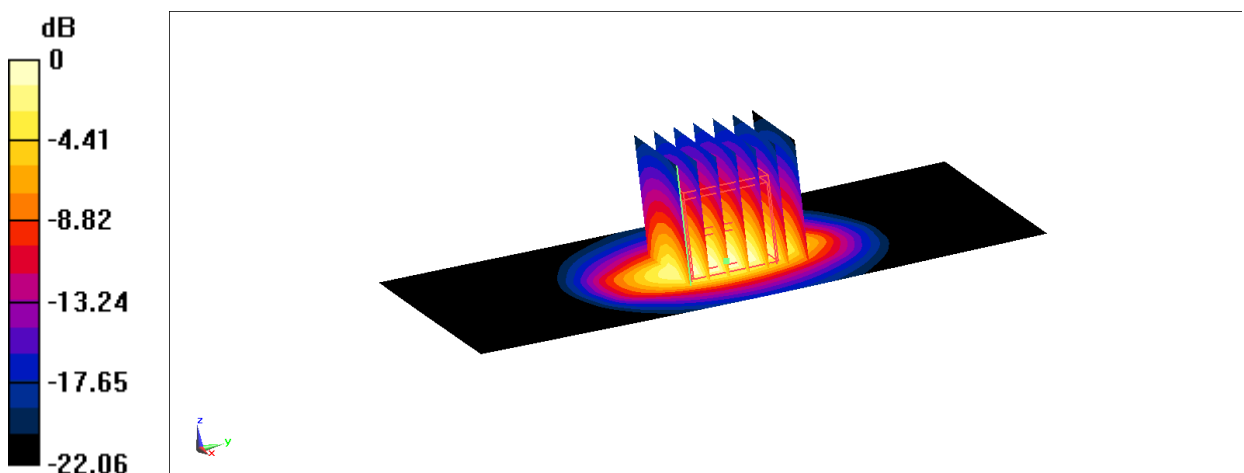

0 dB = 20.2 W/kg = 13.05 dBW/kg

Fig.B.8 validation 2300 MHz 250mW

2450 MHz

Date: 5/26/2021

Electronics: DAE4 Sn1525

Medium: H2450

Medium parameters used: $f = 2450$ MHz; $\sigma = 1.921$ S/m; $\epsilon_r = 40.738$; $\rho = 1000$ kg/m³

Ambient Temperature: 23.20C

Liquid Temperature: 22.70C

Communication System: UID 0, CW (0) Frequency: 2450 MHz Duty Cycle: 1:1

Probe: EX3DV4 - SN7600 ConvF(7.79, 7.79, 7.79)

Area Scan (61x171x1): Interpolated grid: dx=1.200 mm, dy=1.200 mm

Reference Value = 102.5 V/m; Power Drift = 0.11 dB

Fast SAR: SAR(1 g) = 13 W/kg; SAR(10 g) = 5.91 W/kg

Maximum value of SAR (interpolated) = 21.2 W/kg

Zoom Scan (7x7x7)/Cube 0: Measurement grid: dx=5mm, dy=5mm, dz=5mm

Reference Value = 102.5 V/m; Power Drift = 0.11 dB

Peak SAR (extrapolated) = 28.9 W/kg

SAR(1 g) = 13.4 W/kg; SAR(10 g) = 6.08 W/kg

Maximum value of SAR (measured) = 22.7 W/kg

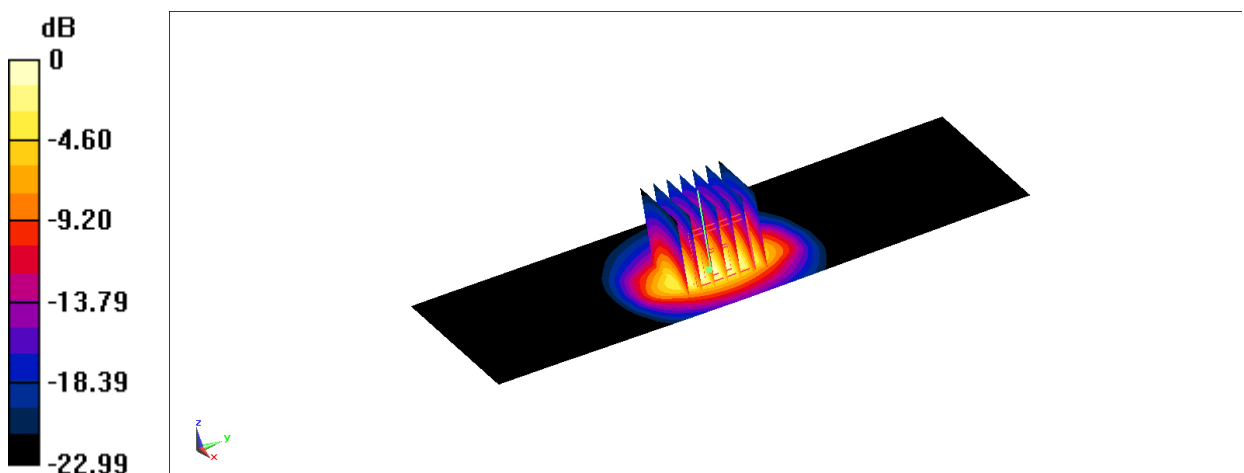

0 dB = 22.7 W/kg = 13.56 dBW/kg

Fig.B.9 validation 2450 MHz 250mW

5250 MHz

Date: 6/3/2021

Electronics: DAE4 Sn1525

Medium: H5G

Medium parameters used: $f = 5250$ MHz; $\sigma = 4.765$ S/m; $\epsilon_r = 34.779$; $\rho = 1000$ kg/m³

Ambient Temperature: 22.8°C

Liquid Temperature: 22.2°C

Communication System: CW Frequency: 5250 MHz Duty Cycle: 1:1

Probe: EX3DV4 - SN7600 ConvF(5.68, 5.68, 5.68)

Area Scan (91x91x1): Interpolated grid: $dx=1.000$ mm, $dy=1.000$ mm

Maximum value of SAR (interpolated) = 19.1 W/kg

Zoom Scan (4x4x1.4mm, graded), $dist=1.4$ mm (8x8x7)/Cube 0: Measurement grid: $dx=4$ mm, $dy=4$ mm, $dz=1.4$ mm

Reference Value = 31.86 V/m; Power Drift = 0.11 dB

Peak SAR (extrapolated) = 35.0 W/kg

SAR(1 g) = 8.04 W/kg; SAR(10 g) = 2.25 W/kg

Maximum value of SAR (measured) = 19.8 W/kg

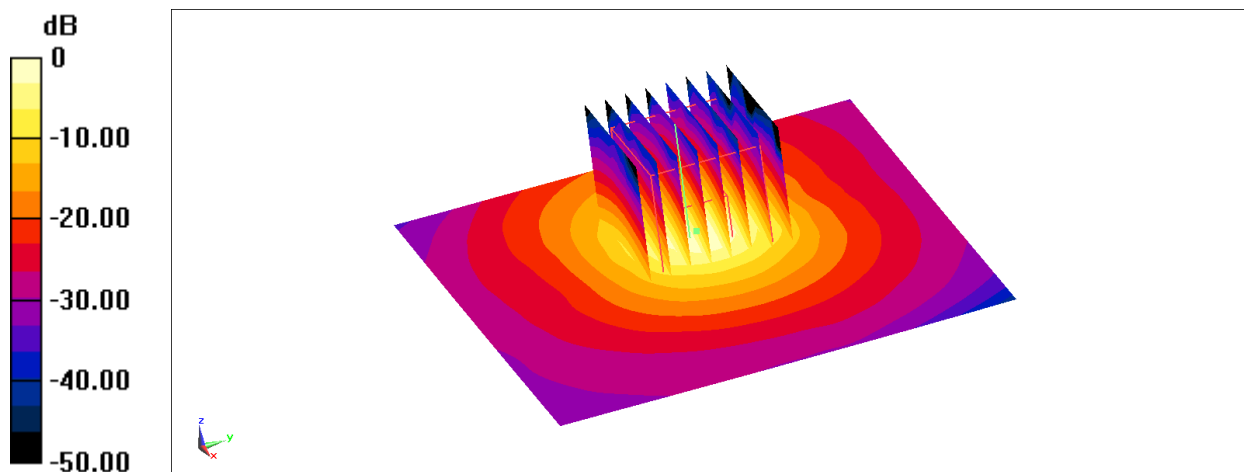

0 dB = 19.8 W/kg = 12.97 dBW/kg

Fig.B.10 validation 5250 MHz 100mW

5600 MHz

Date: 6/3/2021

Electronics: DAE4 Sn1525

Medium: H5G

Medium parameters used: $f = 5600$ MHz; $\sigma = 5.149$ S/m; $\epsilon_r = 34.088$; $\rho = 1000$ kg/m³

Ambient Temperature: 22.8°C

Liquid Temperature: 22.2°C

Communication System: CW Frequency: 5600 MHz Duty Cycle: 1:1

Probe: EX3DV4 - SN7600 ConvF(5.11, 5.11, 5.11)

Area Scan (91x91x1): Interpolated grid: dx=1.000 mm, dy=1.000 mm

Maximum value of SAR (interpolated) = 21.3 W/kg

Zoom Scan (4x4x1.4mm, graded), dist=1.4mm (8x8x7)/Cube 0: Measurement grid: dx=4mm, dy=4mm, dz=1.4mm

Reference Value = 27.97 V/m; Power Drift = 0.19 dB

Peak SAR (extrapolated) = 40.0 W/kg

SAR(1 g) = 8.58 W/kg; SAR(10 g) = 2.4 W/kg

Maximum value of SAR (measured) = 21.8 W/kg

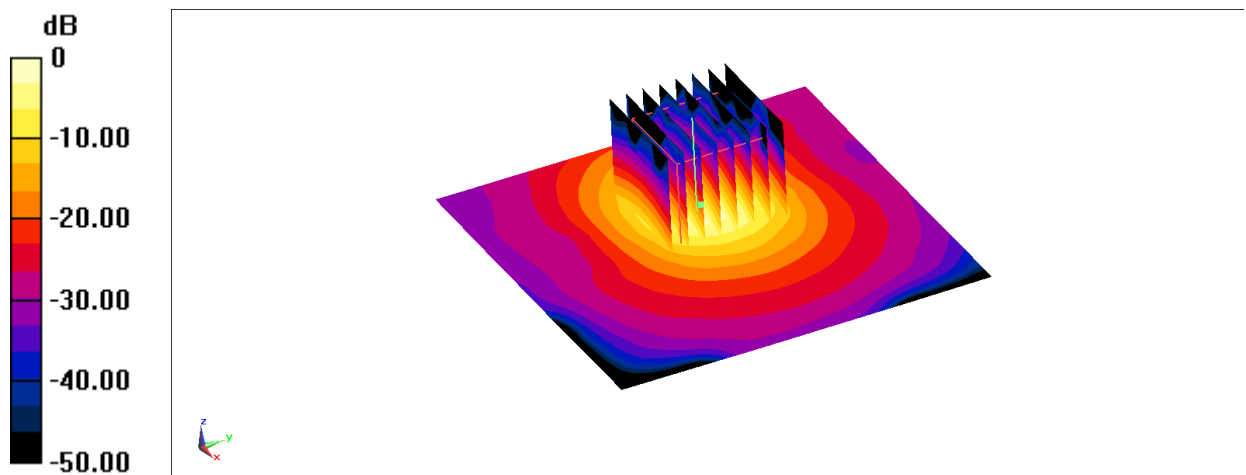

0 dB = 21.8 W/kg = 13.38 dBW/kg

Fig.B.11 validation 5600 MHz 100mW

5750 MHz

Date: 6/3/2021

Electronics: DAE4 Sn1525

Medium: H5G

Medium parameters used: $f = 5750$ MHz; $\sigma = 5.321$ S/m; $\epsilon_r = 33.798$; $\rho = 1000$ kg/m³

Ambient Temperature: 22.8°C

Liquid Temperature: 22.2°C

Communication System: CW Frequency: 5750 MHz Duty Cycle: 1:1

Probe: EX3DV4 - SN7600 ConvF(5.07, 5.07, 5.07)

Area Scan (91x91x1): Interpolated grid: dx=1.000 mm, dy=1.000 mm

Maximum value of SAR (interpolated) = 22.6 W/kg

Zoom Scan (4x4x1.4mm, graded), dist=1.4mm (8x8x7)/Cube 0: Measurement grid: dx=4mm, dy=4mm, dz=1.4mm

Reference Value = 30.21 V/m; Power Drift = 0.11 dB

Peak SAR (extrapolated) = 39.3 W/kg

SAR(1 g) = 8.1 W/kg; SAR(10 g) = 2.27 W/kg

Maximum value of SAR (measured) = 20.9 W/kg

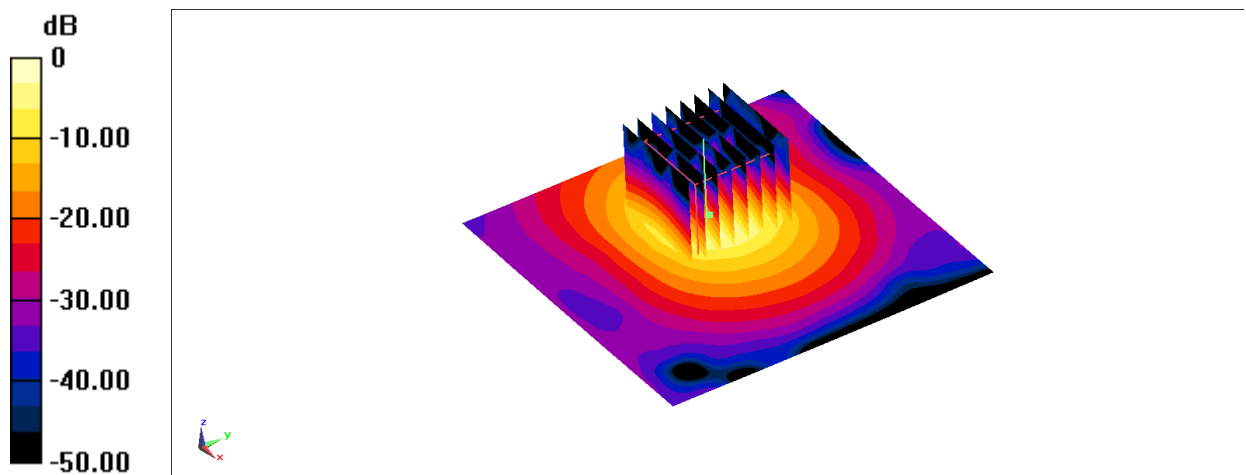

0 dB = 20.9 W/kg = 13.20 dBW/kg

Fig.B.12 validation 5750 MHz 100mW

The SAR system verification must be required that the area scan estimated 1-g SAR is within 3% of the zoom scan 1-g SAR.

Table B.1 Comparison between area scan and zoom scan for system verification

Date	Band	Position	Area scan (1g)	Zoom scan (1g)	Drift (%)
2021/5/21	750 MHz	Head	2.21	2.15	2.79
2021/5/21	750 MHz	Head	2.08	2.02	2.97
2021/5/20	835 MHz	Head	2.28	2.31	-1.30
2021/5/22	1750 MHz	Head	9.8	9.6	2.08
2021/5/23	1750 MHz	Head	9.79	9.73	0.62
2021/5/22	1900 MHz	Head	9.41	9.52	-1.16
2021/5/23	1900 MHz	Head	10.1	10.4	-2.88
2021/5/23	2300 MHz	Head	12.56	12.2	2.95
2021/5/28	2300 MHz	Head	12.66	12.3	2.93
2021/5/26	2450 MHz	Head	13	13.4	-2.99

ANNEX C SAR Measurement Setup

C.1 Measurement Set-up

The Dasy4 or DASY5 system for performing compliance tests is illustrated above graphically. This system consists of the following items:

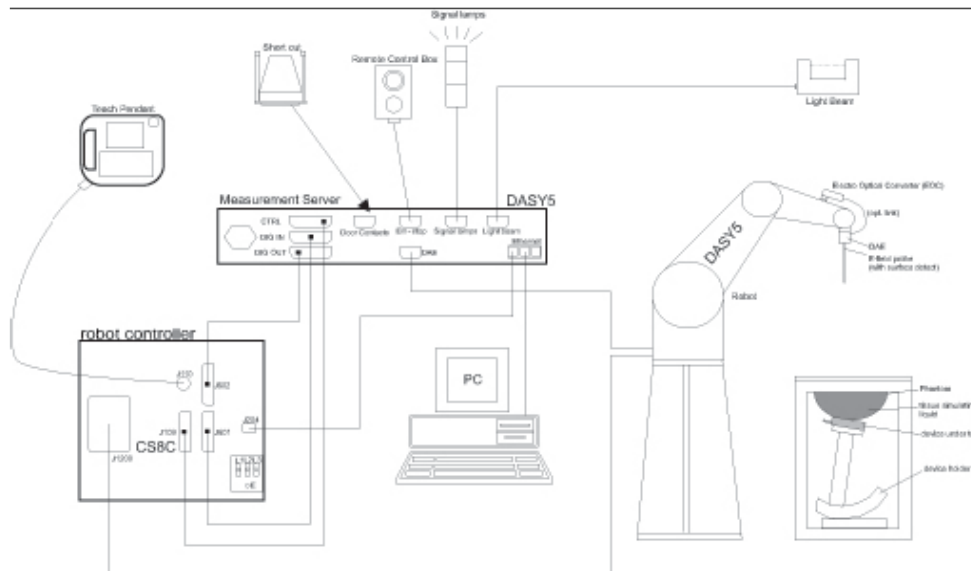

Picture C.1 SAR Lab Test Measurement Set-up

- A standard high precision 6-axis robot (StäubliTX=RX family) with controller, teach pendant and software. An arm extension for accommodating the data acquisition electronics (DAE).
- An isotropic field probe optimized and calibrated for the targeted measurement.
- A data acquisition electronics (DAE) which performs the signal amplification, signal multiplexing, AD-conversion, offset measurements, mechanical surface detection, collision detection, etc. The unit is battery powered with standard or rechargeable batteries. The signal is optically transmitted to the EOC.
- The Electro-optical converter (EOC) performs the conversion from optical to electrical signals for the digital communication to the DAE. To use optical surface detection, a special version of the EOC is required. The EOC signal is transmitted to the measurement server.
- The function of the measurement server is to perform the time critical tasks such as signal filtering, control of the robot operation and fast movement interrupts.
- The Light Beam used is for probe alignment. This improves the (absolute) accuracy of the probe positioning.
- A computer running WinXP and the DASY4 or DASY5 software.
- Remote control and teach pendant as well as additional circuitry for robot safety such as
- warning lamps, etc.
- The phantom, the device holder and other accessories according to the targeted measurement.

C.2 Dasy4 or DASY5 E-field Probe System

The SAR measurements were conducted with the dosimetric probe designed in the classical triangular configuration and optimized for dosimetric evaluation. The probe is constructed using the thick film technique; with printed resistive lines on ceramic substrates. The probe is equipped with an optical multifiber line ending at the front of the probe tip. It is connected to the EOC box on the robot arm and provides an automatic detection of the phantom surface. Half of the fibers are connected to a pulsed infrared transmitter, the other half to a synchronized receiver. As the probe approaches the surface, the reflection from the surface produces a coupling from the transmitting to the receiving fibers. This reflection increases first during the approach, reaches maximum and then decreases. If the probe is flatly touching the surface, the coupling is zero. The distance of the coupling maximum to the surface is independent of the surface reflectivity and largely independent of the surface to probe angle. The DASY4 or DASY5 software reads the reflection during a software approach and looks for the maximum using 2nd order curve fitting. The approach is stopped at reaching the maximum.

Probe Specifications:

Model:	ES3DV3, EX3DV4
Frequency	10MHz — 6.0GHz(EX3DV4)
Range:	10MHz — 4GHz(ES3DV3)
Calibration:	In head and body simulating tissue at Frequencies from 835 up to 5800MHz
Linearity:	± 0.2 dB(30 MHz to 6 GHz) for EX3DV4 ± 0.2 dB(30 MHz to 4 GHz) for ES3DV3
DynamicRange:	10 mW/kg — 100W/kg
Probe Length:	330 mm
Probe Tip	
Length:	20 mm
Body Diameter:	12 mm
Tip Diameter:	2.5 mm (3.9 mm for ES3DV3)
Tip-Center:	1 mm (2.0mm for ES3DV3)
Application:	SAR Dosimetry Testing Compliance tests of mobile phones Dosimetry in strong gradient fields



Picture C.2 Near-field Probe



Picture C.3 E-field Probe

C.3 E-field Probe Calibration

Each E-Probe/Probe Amplifier combination has unique calibration parameters. A TEM cell calibration procedure is conducted to determine the proper amplifier settings to enter in the probe parameters. The amplifier settings are determined for a given frequency by subjecting the probe to a known E-field density (1 mW/cm^2) using an RF Signal generator, TEM cell, and RF Power Meter.

The free space E-field from amplified probe outputs is determined in a test chamber. This calibration can be performed in a TEM cell if the frequency is below 1 GHz and in a waveguide or

other methodologies above 1 GHz for free space. For the free space calibration, the probe is placed in the volumetric center of the cavity and at the proper orientation with the field. The probe is then rotated 360 degrees until the three channels show the maximum reading. The power density readings equates to 1 mW/cm².

E-field temperature correlation calibration is performed in a flat phantom filled with the appropriate simulated brain tissue. The E-field in the medium correlates with the temperature rise in the dielectric medium. For temperature correlation calibration a RF transparent thermistor-based temperature probe is used in conjunction with the E-field probe.

$$SAR = C \frac{\Delta T}{\Delta t}$$

Where:

Δt = Exposure time (30 seconds),

C = Heat capacity of tissue (brain or muscle),

ΔT = Temperature increase due to RF exposure.

$$SAR = \frac{|E|^2 \cdot \sigma}{\rho}$$

Where:

σ = Simulated tissue conductivity,

ρ = Tissue density (kg/m³).

C.4 Other Test Equipment

C.4.1 Data Acquisition Electronics(DAE)

The data acquisition electronics consist of a highly sensitive electrometer-grade preamplifier with auto-zeroing, a channel and gain-switching multiplexer, a fast 16 bit AD-converter and a command decoder with a control logic unit. Transmission to the measurement server is accomplished through an optical downlink for data and status information, as well as an optical uplink for commands and the clock.

The mechanical probe mounting device includes two different sensor systems for frontal and sideways probe contacts. They are used for mechanical surface detection and probe collision detection.

The input impedance of the DAE is 200 MOhm; the inputs are symmetrical and floating. Common mode rejection is above 80 dB.



PictureC.4: DAE

C.4.2 Robot

The SPEAG DASY system uses the high precision robots (DASY4: RX90XL; DASY5: RX160L) type from Stäubli SA (France). For the 6-axis controller system, the robot controller version from Stäubli is used. The Stäubli robot series have many features that are important for our application:

- High precision (repeatability 0.02mm)
- High reliability (industrial design)
- Low maintenance costs (virtually maintenance free due to direct drive gears; no belt drives)
- Jerk-free straight movements (brushless synchron motors; no stepper motors)
- Low ELF interference (motor control fields shielded via the closed metallic construction shields)



Picture C.5DASY 4



Picture C.6DASY 5

C.4.3 Measurement Server

The Measurement server is based on a PC/104 CPU board with CPU (dasy4: 166 MHz, Intel Pentium; DASY5: 400 MHz, Intel Celeron), chipdisk (DASY4: 32 MB; DASY5: 128MB), RAM (DASY4: 64 MB, DASY5: 128MB). The necessary circuits for communication with the DAE electronic box, as well as the 16 bit AD converter system for optical detection and digital I/O interface are contained on the DASY I/O board, which is directly connected to the PC/104 bus of the CPU board.

The measurement server performs all real-time data evaluation of field measurements and surface detection, controls robot movements and handles safety operation. The PC operating system cannot interfere with these time critical processes. All connections are supervised by a watchdog, and disconnection of any of the cables to the measurement server will automatically disarm the robot and disable all program-controlled robot movements. Furthermore, the measurement server is equipped with an expansion port which is reserved for future applications. Please note that this expansion port does not have a standardized pinout, and therefore only devices provided by SPEAG can be connected. Devices from any other supplier could seriously damage the measurement server.



Picture C.7 Server for DASY 4



Picture C.8 Server for DASY 5

C.4.4 Device Holder for Phantom

The SAR in the phantom is approximately inversely proportional to the square of the distance between the source and the liquid surface. For a source at 5mm distance, a positioning uncertainty of $\pm 0.5\text{mm}$ would produce a SAR uncertainty of $\pm 20\%$. Accurate device positioning is therefore crucial for accurate and repeatable measurements. The positions in which the devices must be measured are defined by the standards.

The DASY device holder is designed to cope with the different positions given in the standard. It has two scales for device rotation (with respect to the body axis) and device inclination (with respect to the line between the ear reference points). The rotation centers for both scales are the ear reference point (ERP). Thus the device needs no repositioning when changing the angles.

The DASY device holder is constructed of low-loss POM material having the following dielectric parameters: relative permittivity $\epsilon = 3$ and loss tangent $\delta = 0.02$. The amount of dielectric material has been reduced in the closest vicinity of the device, since measurements have suggested that the influence of the clamp on the test results could thus be lowered.

<Laptop Extension Kit>

The extension is lightweight and made of POM, acrylic glass and foam. It fits easily on the upper part of the Mounting Device in place of the phone positioner. The extension is fully compatible with the Twin-SAM and ELI phantoms.



Picture C.9-1: Device Holder

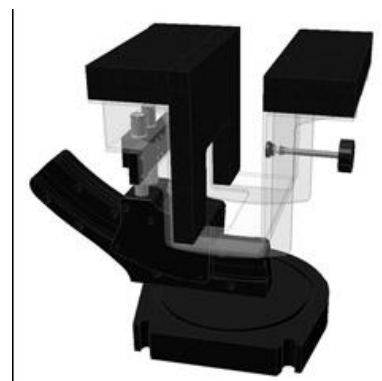

Picture C.9-2: Laptop Extension Kit

C.4.5 Phantom

The SAM Twin Phantom V4.0 is constructed of a fiberglass shell integrated in a table. The shape of the shell is based on data from an anatomical study designed to represent the 90th percentile of the population. The phantom enables the dissymmetric evaluation

of SAR for both left and right handed handset usage, as well as body-worn usage using the flat phantom region. Reference markings on the Phantom allow the complete setup of all predefined phantom positions and measurement grids by manually teaching three points in the robot. The shell phantom has a 2mm shell thickness (except the ear region where shell thickness increases to 6 mm).

Shell Thickness: 2 ± 0.2 mm

Filling Volume: Approx. 25 liters

Dimensions: 810 x 1000 x 500 mm (H x L x W)

Available: Special



Picture C.10: SAM Twin Phantom

ANNEX D Position of the wireless device in relation to the phantom

D.1 General considerations

This standard specifies two handset test positions against the head phantom – the “cheek” position and the “tilt” position.

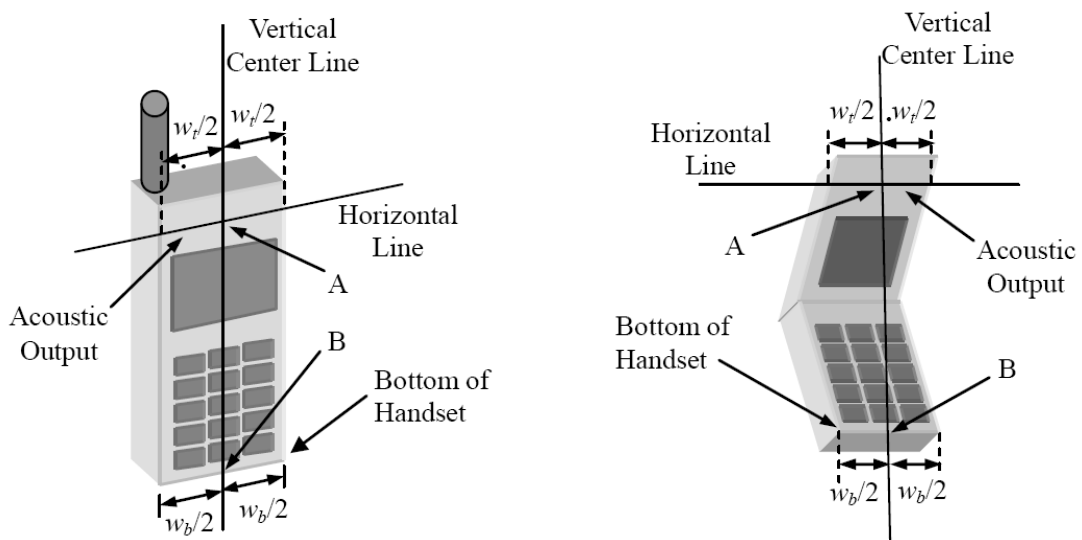

- w_t Width of the handset at the level of the acoustic
- w_b Width of the bottom of the handset
- A Midpoint of the width w_t of the handset at the level of the acoustic output
- B Midpoint of the width w_b of the bottom of the handset

Picture D.1-a Typical “fixed” case handset Picture D.1-b Typical “clam-shell” case handset

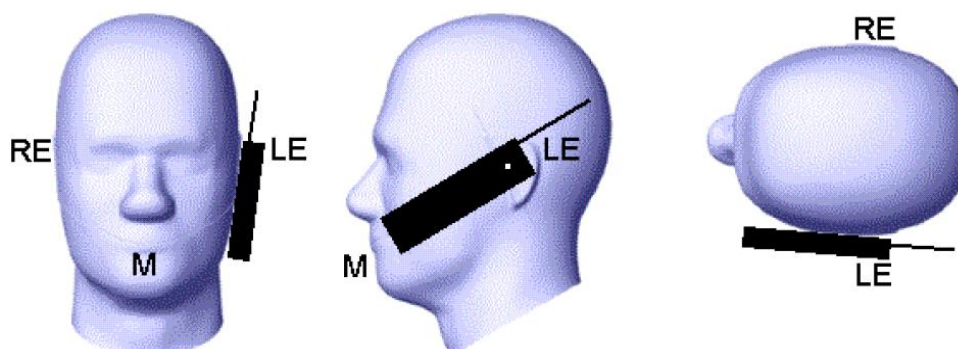

Picture D.2 Cheek position of the wireless device on the left side of SAM