

DFS Test Report

Report No.: RF191105E04A-2

FCC ID: XCNUBC1326

Test Model: UBC1326

Received Date: July 21, 2020

Test Date: Aug. 05 to 12, 2020

Issued Date: Aug. 25, 2020

Applicant: Ubee Interactive Corp.

Address: 10F-1, No. 5, Taiyuan 1st St. Zhubei City, Hsinchu County 302, Taiwan ,
R.O.C.

Issued By: Bureau Veritas Consumer Products Services (H.K.) Ltd., Taoyuan Branch
Hsin Chu Laboratory

Lab Address: E-2, No.1, Li Hsin 1st Road, Hsinchu Science Park, Hsinchu City 300,
Taiwan

Test Location: E-2, No.1, Li Hsin 1st Road, Hsinchu Science Park, Hsinchu City 300,
Taiwan

**FCC Registration /
Designation Number:** 723255 / TW2022



This report is for your exclusive use. Any copying or replication of this report to or for any other person or entity, or use of our name or trademark, is permitted only with our prior written permission. This report sets forth our findings solely with respect to the test samples identified herein. The results set forth in this report are not indicative or representative of the quality or characteristics of the lot from which a test sample was taken or any similar or identical product unless specifically and expressly noted. Our report includes all of the tests requested by you and the results thereof based upon the information that you provided to us. You have 60 days from date of issuance of this report to notify us of any material error or omission caused by our negligence, provided, however, that such notice shall be in writing and shall specifically address the issue you wish to raise. A failure to raise such issue within the prescribed time shall constitute your unqualified acceptance of the completeness of this report, the tests conducted and the correctness of the report contents. Unless specific mention, the uncertainty of measurement has been explicitly taken into account to declare the compliance or non-compliance to the specification.

Table of Contents

Release Control Record	3
1 Certificate of Conformity	4
2 EUT Information	5
2.1 Operating Frequency Bands and Mode of EUT.....	5
2.2 EUT Firmware Version.....	5
2.3 Description of Available Antennas to the EUT.....	5
2.4 EUT Maximum and Minimum Conducted Power.....	6
2.5 EUT Maximum and Minimum EIRP Power.....	6
2.6 Transmit Power Control (TPC).....	7
2.7 Statement of Manufacturer.....	7
3. U-NII DFS Rule Requirements	8
3.1 Working Modes and Required Test Items.....	8
3.2 Test Limits and Radar Signal Parameters.....	9
4. Test & Support Equipment List	12
4.1 Test Instruments.....	12
4.2 Description of Support Units.....	12
5. Test Procedure	13
5.1 DFS Measurement System.....	13
5.2 Calibration of DFS Detection Threshold Level.....	14
5.3 Deviation from Test Standard.....	14
5.4 Radiated Test Setup Configuration.....	15
6. Test Results	16
6.1 Summary of Test Results.....	16
6.2 Test Results.....	17
6.2.1 Test Mode: Device Operating in Master Mode.....	17
6.2.2 U-NII Detection Bandwidth.....	22
6.2.3 Channel Availability Check Time.....	32
6.2.4 Channel Closing Transmission and Channel Move Time.....	34
6.2.5 Non- Occupancy Period.....	69
7. Information of the Testing Laboratories	71
3 APPENDIX-A	72

Release Control Record

Issue No.	Description	Date Issued
RF191105E04A-2	Original release.	Aug. 25, 2020

1 Certificate of Conformity

Product: Wireless eMTA

Brand: Ubee

Test Model: UBC1326

Applicant: Ubee Interactive Corp.

Test Date: Aug. 05 to 12, 2020

Standard: FCC Part 15, Subpart E (Section 15.407)

References Test Guidance: KDB 905462 D02 UNII DFS Compliance Procedures New Rules v02

The above equipment has been tested by **Bureau Veritas Consumer Products Services (H.K.) Ltd., Taoyuan Branch**, and found compliance with the requirement of the above standards. The test record, data evaluation & Equipment Under Test (EUT) configurations represented herein are true and accurate accounts of the measurements of the sample's EMC characteristics under the conditions specified in this report.

Prepared by :

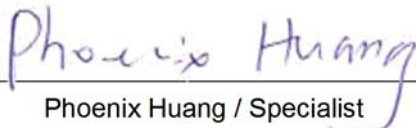
Phoenix Huang / Specialist

Date:

Aug. 25, 2020

Approved by :



Clark Lin / Technical Manager

Date:

Aug. 25, 2020

2 EUT Information

2.1 Operating Frequency Bands and Mode of EUT

Table 1: Operating Frequency Bands and Mode of EUT

Operational Mode	Operating Frequency Range	
	5250~5350MHz	5470~5725MHz
Master	✓	✓

2.2 EUT Firmware Version

Table 2: The EUT Firmware Version

No.	Product	Model No.	Firmware Version
1	Wireless eMTA	UBC1326	17.10.77.15

2.3 Description of Available Antennas to the EUT

Table 3: Antenna List

Antenna No.	RF Chain No.	Antenna Net Gain (dBi)	Frequency Range	Antenna Type	Connector Type	Cable Length (mm)
WiFi 1	Chain1/2	3.9/4.14	2.4GHz/5GHz	PCB	i-pex(MHF)	155
WiFi 2	Chain2/1	3.97/4.84	2.4GHz/5GHz	PCB	i-pex(MHF)	87
WiFi 3	Chain0/3	3.9/3.85	2.4GHz/5GHz	PCB	i-pex(MHF)	75
WiFi 4	Chain3/0	3.08/3.59	2.4GHz/5GHz	PCB	i-pex(MHF)	100

Note: The above Antenna information is declared by manufacturer and for more detailed features description, please refer to the manufacturer's specifications, the laboratory shall not be held responsible.

2.4 EUT Maximum and Minimum Conducted Power

Table 4: The Measured Conducted Output Power

CDD Mode

Frequency Band (MHz)	MAX. Power		MIN. Power	
	Output Power (mW)	Output Power (dBm)	Output Power (mW)	Output Power (dBm)
5250~5350	187.652	22.73	47.098	16.73
5470~5725	249.634	23.97	62.661	17.97

Beamforming Mode

Frequency Band (MHz)	MAX. Power		MIN. Power	
	Output Power (mW)	Output Power (dBm)	Output Power (mW)	Output Power (dBm)
5250~5350	94.886	19.77	23.823	13.77
5470~5725	95.381	19.79	23.933	13.79

2.5 EUT Maximum and Minimum EIRP Power

Table 5: The EIRP Output Power List

CDD Mode

Frequency Band (MHz)	MAX. EIRP Power		MIN. EIRP Power	
	Output Power (mW)	Output Power (dBm)	Output Power (mW)	Output Power (dBm)
5250~5350	571.479	27.57	143.549	21.57
5470~5725	760.326	28.81	190.985	22.81

Beamforming Mode

Frequency Band (MHz)	MAX. EIRP Power		MIN. EIRP Power	
	Output Power (mW)	Output Power (dBm)	Output Power (mW)	Output Power (dBm)
5250~5350	979.49	29.91	246.037	23.91
5470~5725	984.011	29.93	247.172	23.93

2.6 Transmit Power Control (TPC)

U-NII devices operating in the 5.25-5.35 GHz band and the 5.47-5.725 GHz band shall employ a TPC mechanism. The U-NII device is required to have the capability to operate at least 6 dB below the mean EIRP value of 30 dBm. A TPC mechanism is not required for systems with an e.i.r.p. of less than 500 mW.

Applicable	EIRP	FCC 15.407 (h)(1)
√	>500mW	The TPC mechanism is required for system with an EIRP of above 500mW
	<500mW	The TPC mechanism is not required for system with an EIRP of less 500mW

The UUT can adjust a transmitter's output power based on the signal level present at the receiver. TPC is auto controlled by software.

2.7 Statement of Manufacturer

Manufacturer statement confirming that information regarding the parameters of the detected Radar Waveforms is not available to the end user.

3. U-NII DFS Rule Requirements

3.1 Working Modes and Required Test Items

The manufacturer shall state whether the UUT is capable of operating as a Master and/or a Client. If the UUT is capable of operating in more than one operating mode then each operating mode shall be tested separately. See tables 6 and 7 for the applicability of DFS requirements for each of the operational modes.

Table 6: Applicability of DFS Requirements Prior to Use a Channel

Requirement	Operational Mode		
	Master	Client without radar detection	Client with radar detection
Non-Occupancy Period	✓	✓ note	✓
DFS Detection Threshold	✓	Not required	✓
Channel Availability Check Time	✓	Not required	Not required
U-NII Detection Bandwidth	✓	Not required	✓

Note: Per KDB 905462 D03 UNII Clients Without Radar Detection New Rules v01r02 section (b)(5/6), If the client moves with the master, the device is considered compliant if nothing appears in the client non-occupancy period test. For devices that shut down (rather than moving channels), no beacons should appear. An analyzer plot that contains a single 30-minute sweep on the original channel.

Table 7: Applicability of DFS Requirements during Normal Operation

Requirement	Operational Mode	
	Master or Client with radar detection	Client without radar detection
DFS Detection Threshold	✓	Not required
Channel Closing Transmission Time	✓	✓
Channel Move Time	✓	✓
U-NII Detection Bandwidth	✓	Not required

Additional requirements for devices with multiple bandwidth modes	Master or Client with radar detection	Client without radar detection
U-NII Detection Bandwidth and Statistical Performance Check	All BW modes must be tested	Not required
Channel Move Time and Channel Closing Transmission Time	Test using widest BW mode available	Test using the widest BW mode available for the link
All other tests	Any single BW mode	Not required

Note: Frequencies selected for statistical performance check (Section 7.8.4) should include several frequencies within the radar detection bandwidth and frequencies near the edge of the radar detection bandwidth. For 802.11 devices it is suggested to select frequencies in each of the bonded 20 MHz channels and the channel center frequency.

3.2 Test Limits and Radar Signal Parameters

Detection Threshold Values

Table 8: DFS Detection Thresholds for Master Devices and Client Devices with Radar Detection

Maximum Transmit Power	Value (See Notes 1, 2, and 3)
EIRP \geq 200 milliwatt	-64 dBm
EIRP < 200 milliwatt and power spectral density < 10 dBm/MHz	-62 dBm
EIRP < 200 milliwatt that do not meet the power spectral density requirement	-64 dBm

Note 1: This is the level at the input of the receiver assuming a 0 dBi receive antenna.
 Note 2: Throughout these test procedures an additional 1 dB has been added to the amplitude of the test transmission waveforms to account for variations in measurement equipment. This will ensure that the test signal is at or above the detection threshold level to trigger a DFS response.
 Note 3: EIRP is based on the highest antenna gain. For MIMO devices refer to KDB Publication 662911 D01.

Table 9: DFS Response Requirement Values

Parameter	Value
Non-occupancy period	Minimum 30 minutes
Channel Availability Check Time	60 seconds
Channel Move Time	10 seconds See Note 1.
Channel Closing Transmission Time	200 milliseconds + an aggregate of 60 milliseconds over remaining 10 second period. See Notes 1 and 2.
U-NII Detection Bandwidth	Minimum 100% of the U-NII 99% transmission power bandwidth. See Note 3

Note 1: Channel Move Time and the Channel Closing Transmission Time should be performed with Radar Type 0. The measurement timing begins at the end of the Radar Type 0 burst.
 Note 2: The Channel Closing Transmission Time is comprised of 200 milliseconds starting at the beginning of the Channel Move Time plus any additional intermittent control signals required to facilitate a Channel move (an aggregate of 60 milliseconds) during the remainder of the 10 second period. The aggregate duration of control signals will not count quiet periods in between transmissions.
 Note 3: During the U-NII Detection Bandwidth detection test, radar type 0 should be used. For each frequency step the minimum percentage of detection is 90 percent. Measurements are performed with no data traffic.

Parameters of DFS Test Signals

Step intervals of 0.1 microsecond for Pulse Width, 1 microsecond for PRI, 1 MHz for chirp width and 1 for the number of pulses will be utilized for the random determination of specific test waveforms.

Table 10: Short Pulse Radar Test Waveforms

Radar Type	Pulse Width (μsec)	PRI (μsec)	Number of Pulses	Minimum Percentage of Successful Detection	Minimum Number of Trials
0	1	1428	18	See Note 1	See Note 1
1	1	Test A 15 unique PRI values randomly selected from the list of 23 PRI values	Roundup $\left\{ \left(\frac{1}{360} \right) \cdot \left(\frac{19 \cdot 10^6}{\text{PRI}_{\mu\text{sec}}} \right) \right\}$	60%	30
		15 unique PRI values randomly selected within the range of 518~3066μsec with a minimum of 1μsec, excluding PRI values selected in Test A			
2	1-5	150-230	23-29	60%	30
3	6-10	200-500	16-18	60%	30
4	11-20	200-500	12-16	60%	30
Aggregate (Radar Types 1-4)				80%	120
Note 1: Short Pulse Radar Type 0 should be used for the detection bandwidth test, channel move time, and channel closing time tests.					

Table 11: Long Pulse Radar Test Waveform

Radar Type	Pulse Width (µsec)	Chirp Width (MHz)	PRI (µsec)	Number of Pulses Per Burst	Number of Bursts	Minimum Percentage of Successful Detection	Minimum Number of Trials
5	50-100	5-20	1000-2000	1-3	8-20	80%	30

Three subsets of trials will be performed with a minimum of ten trials per subset. The subset of trials differ in where the Long Pulse Type 5 Signal is tuned in frequency.

- a) the Channel center frequency
- b) tuned frequencies such that 90% of the Long Pulse Type 5 frequency modulation is within the low edge of the UUT Occupied Bandwidth
- c) tuned frequencies such that 90% of the Long Pulse Type 5 frequency modulation is within the high edge of the UUT Occupied Bandwidth

It include 10 trails for every subset, the formula as below,

For subset case 1: the center frequency of the signal generator will remain fixed at the center of the UUT Channel.

For subset case 2: to retain 90% frequency overlap between the radar signal and the UUT Occupied Bandwidth, the center frequency of the signal generator will vary for each of the ten trials in subset case 2. The center frequency of the signal generator for each trial is calculated by:

$$FL + (0.4 * \text{Chirp Width [in MHz]})$$

For subset case 3: to retain 90% frequency overlap between the radar signal and the UUT Occupied Bandwidth, the center frequency of the signal generator will vary for each of the ten trials in subset case 3. The center frequency of the signal generator for each trial is calculated by:

$$FH - (0.4 * \text{Chirp Width [in MHz]})$$

Table 12: Frequency Hopping Radar Test Waveform

Radar Type	Pulse Width (µsec)	PRI (µsec)	Pulses per Hop	Hopping Rate (kHz)	Hopping Sequence Length (msec)	Minimum Percentage of Successful Detection	Minimum Number of Trials
6	1	333	9	0.333	300	70%	30

4. Test & Support Equipment List

4.1 Test Instruments

Table 13: Test Instruments List

DESCRIPTION & MANUFACTURER	MODEL NO.	SERIAL NO.	CALIBRATED DATE	CALIBRATED UNTIL
Spectrum Analyzer R&S	ESR	102026	Apr. 22, 2020	Apr. 21, 2021
Vector Signal Generator Agilent	N5182B	MY53052700	July 14, 2020	July 13, 2021
Horn_Antenna FT-RF	HA-07M18G- NF	0000220091110	Nov. 24, 2019	Nov. 23, 2020
DFS Control Box	BV-DFS-CB	002	Dec. 02, 2019	Dec. 01, 2020

- NOTE:**
1. The test was performed in DFS-2 room.
 2. The calibration interval of the above test instruments is 12 months and the calibrations are traceable to NML/ROC and NIST/USA.
 3. Tested Date: Aug. 05 to 12, 2020

4.2 Description of Support Units

Table 14: Support Unit Information

No.	Product	Brand	Model No.	FCC ID	Spec
1	Intel® Wi-Fi 6 AX200	Intel	AX200NGW	PD9AX200NG	

Note: This device was functioned as a Master Slave device during the DFS test.

Table 15: Software/Firmware Information

No.	Product	Model No.	Software/Firmware Version
1	Intel® Wi-Fi 6 AX200	AX200NGW	21.80.2.1

5. Test Procedure

5.1 DFS Measurement System

A complete DFS Measurement System consists of two subsystems: (1) the Radar Signal Generating system and (2) the Traffic Monitoring system. The control PC is necessary for generating the Radar waveforms in Table 10, 11 and 12. The traffic monitoring subsystem is specified to the type of unit under test (UUT).

Radiated Setup Configuration of DFS Measurement System

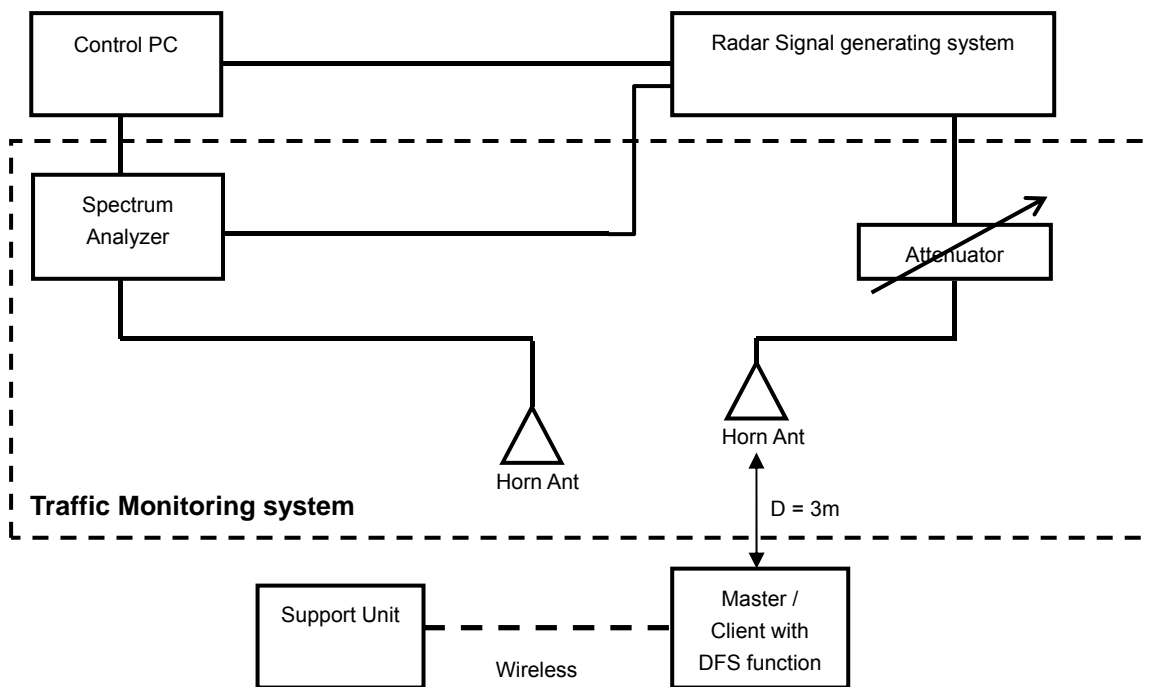

Channel Loading

System testing will be performed with channel-loading using means appropriate to the data types that are used by the unlicensed device. The following requirements apply:

a)	The data file must be of a type that is typical for the device (i.e., MPEG-2, MPEG-4, WAV, MP3, MP4, AVI, etc.) and must generally be transmitting in a streaming mode.	
b)	Software to ping the client is permitted to simulate data transfer but must have random ping intervals.	
c)	Timing plots are required with calculations demonstrating a minimum channel loading of approximately 17% or greater.	✓
d)	Unicast or Multicast protocols are preferable but other protocols may be used. The appropriate protocol used must be described in the test procedures.	

5.2 Calibration of DFS Detection Threshold Level

The measured channel is chosen from the operating channels of the UUT within the 5250-5350MHz or 5470-5725MHz and using the all bandwidth mode available for the link. The radar signal was the same as transmitted channels, and injected into the antenna of AP (master) or Client Device with Radar Detection, measured the channel closing transmission time and channel move time.

Radiated setup configuration of Calibration of DFS Detection Threshold Level

The radar signal generate system is generating waveform pattern of radar types. The amplitude of the radar signal generator system is adjusted to yield a level of -64 dBm as measured on the spectrum analyzer. The interference detection threshold level is lower than -64dBm hence it provides margin to the limit.

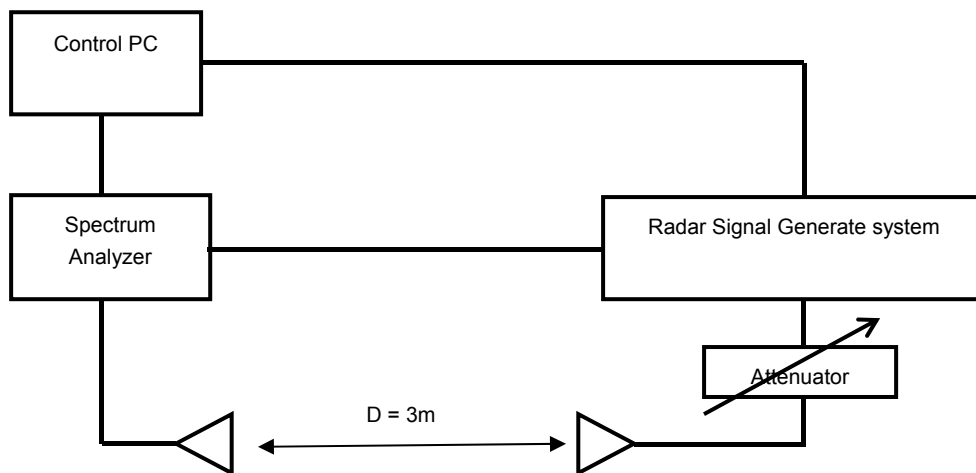

5.3 Deviation from Test Standard

No deviation.

5.4 Radiated Test Setup Configuration

Master mode

The EUT is a U-NII Device operating in Master mode. The radar test signals are injected into the Master Device.

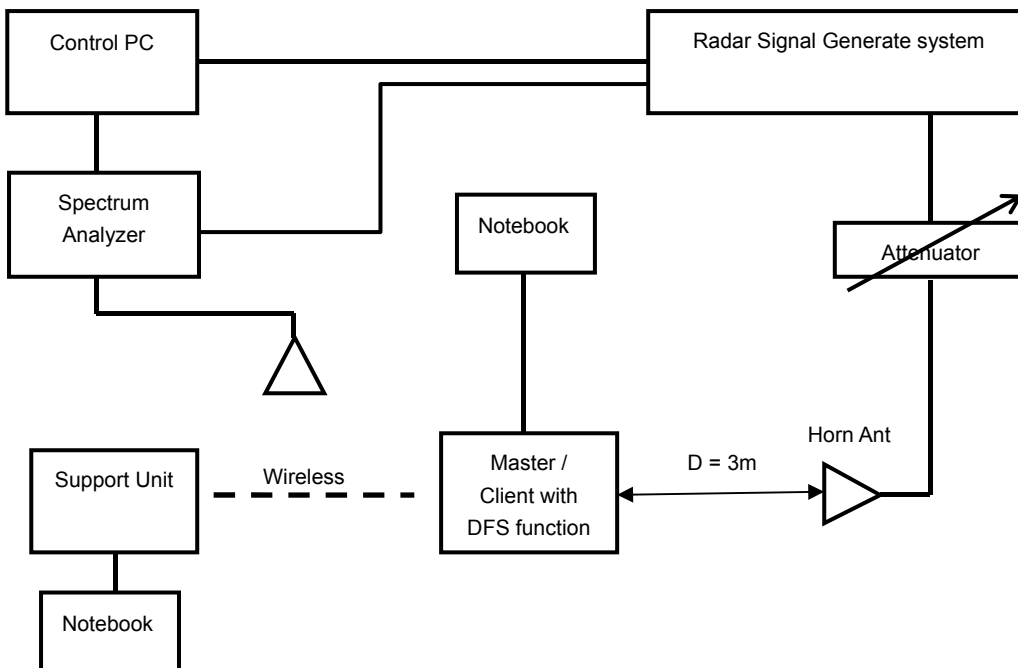

Note: The UUT main beam of the antenna is directly toward the radar emitter during testing.

6. Test Results

6.1 Summary of Test Results

Clause	Test Parameter	Remarks	Pass/Fail
15.407	DFS Detection Threshold	Applicable	Pass
15.407	Channel Availability Check Time	Applicable	Pass
15.407	Channel Move Time	Applicable	Pass
15.407	Channel Closing Transmission Time	Applicable	Pass
15.407	Non- Occupancy Period	Applicable	Pass
15.407	U-NII Detection Bandwidth and Statistical Performance Check	Applicable	Pass

Note: This device does not support "802.11ax Channel Puncturing" function.

6.2 Test Results

6.2.1 Test Mode: Device Operating in Master Mode

The radar test waveforms are injected into the Master.
This test was investigated for different bandwidth (20MHz · 40MHz · 80MHz · 160MHz).
The following plots was done on 160MHz as a representative

DFS Detection Threshold

For detection threshold level of -64dBm, the tested level is lower than required level for 1dB, hence it provides margin to the limit.

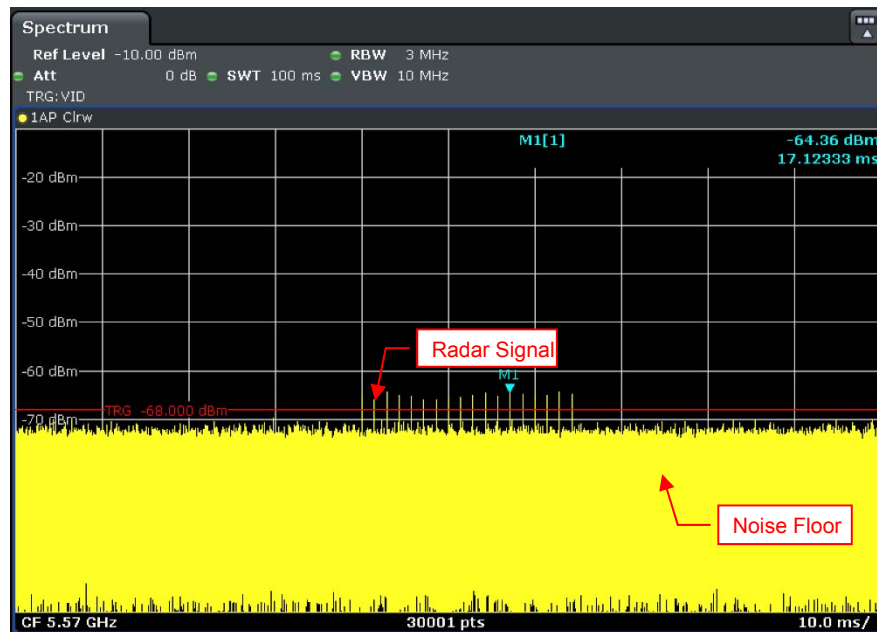

Radar Signal 0

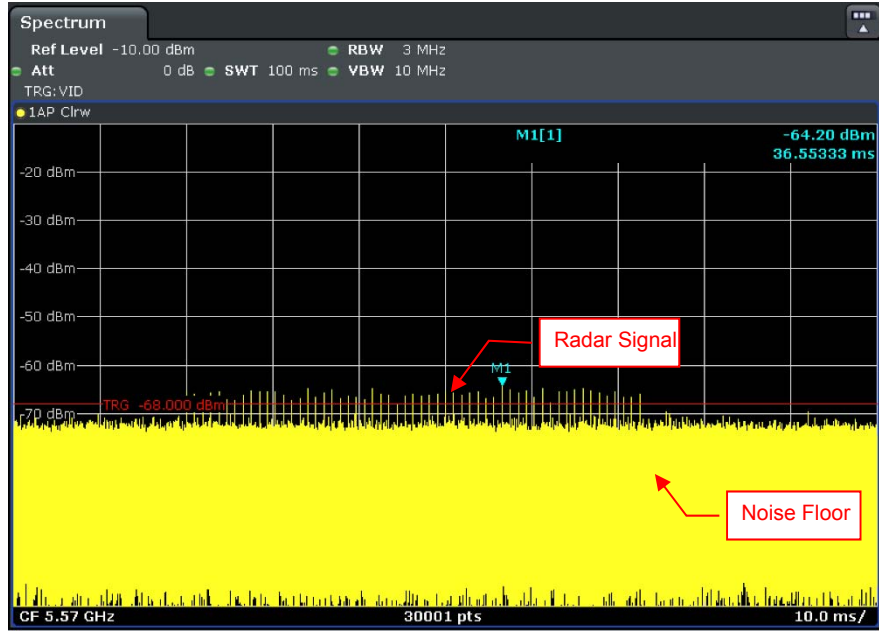

Radar Signal 1 (Test A)

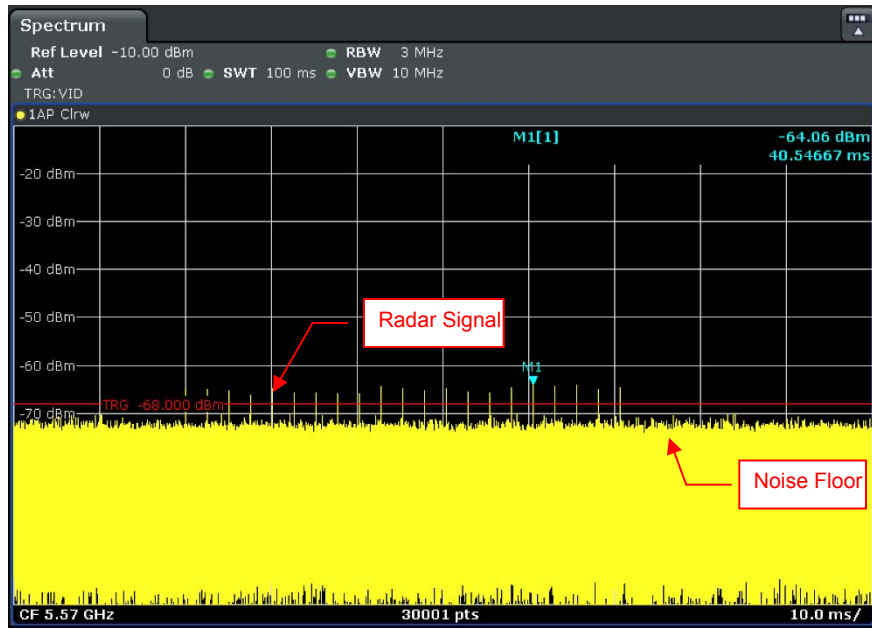

Radar Signal 1 (Test B)

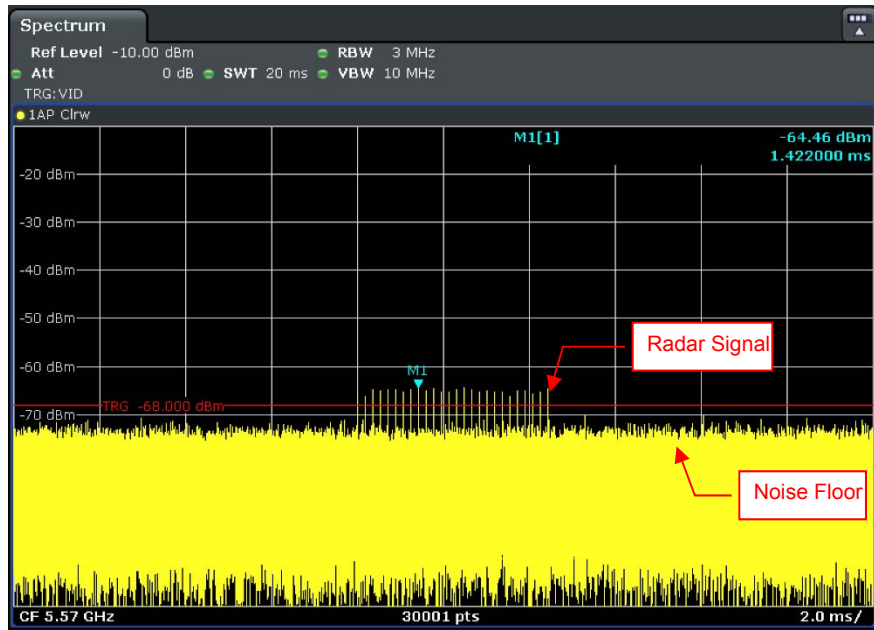

Radar Signal 2

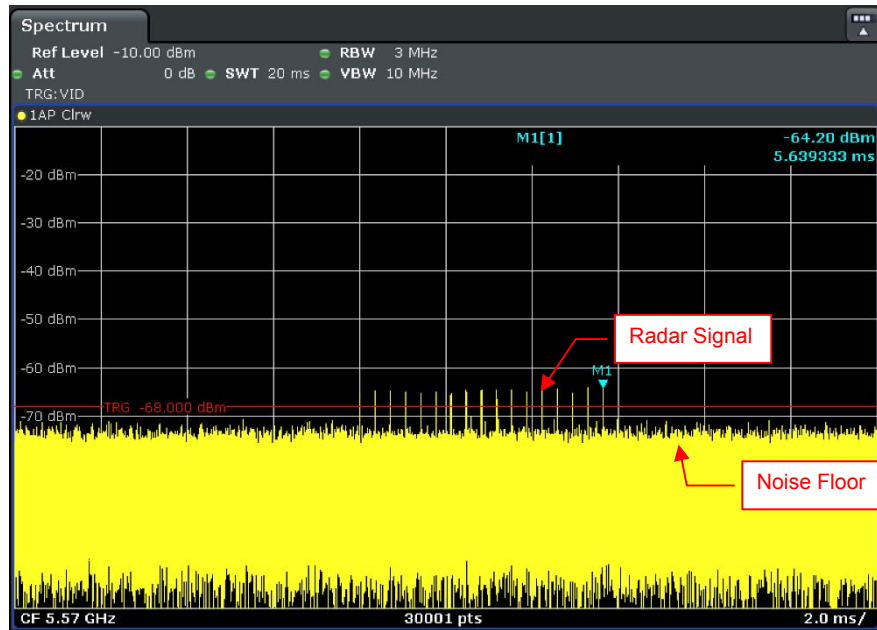

Radar Signal 3

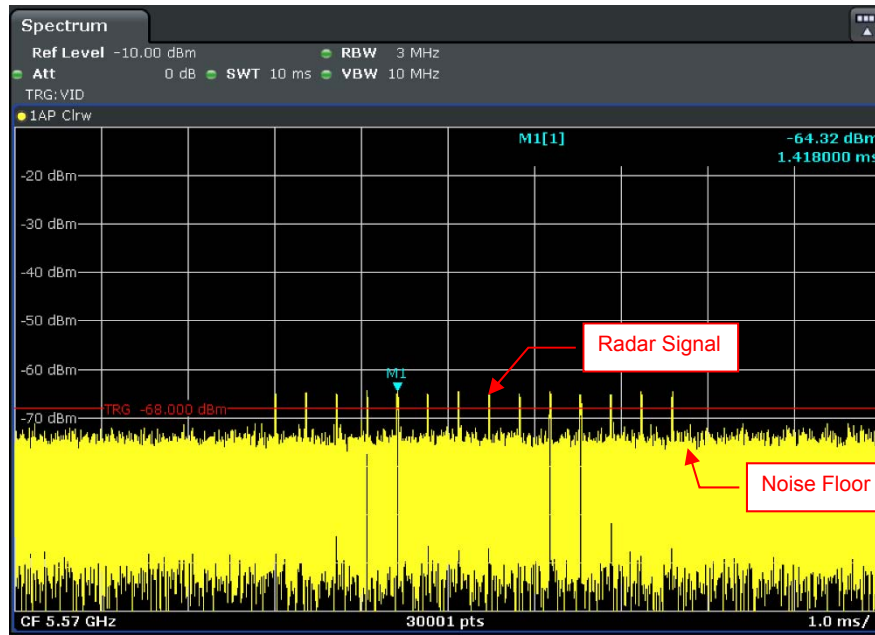

Single Burst of Radar Signal 4

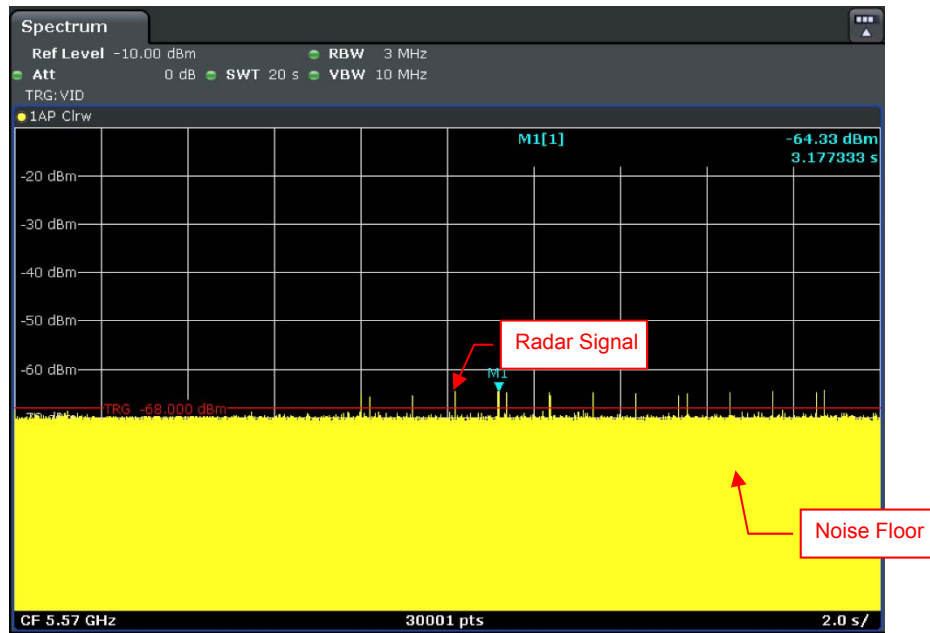

Radar Signal 5

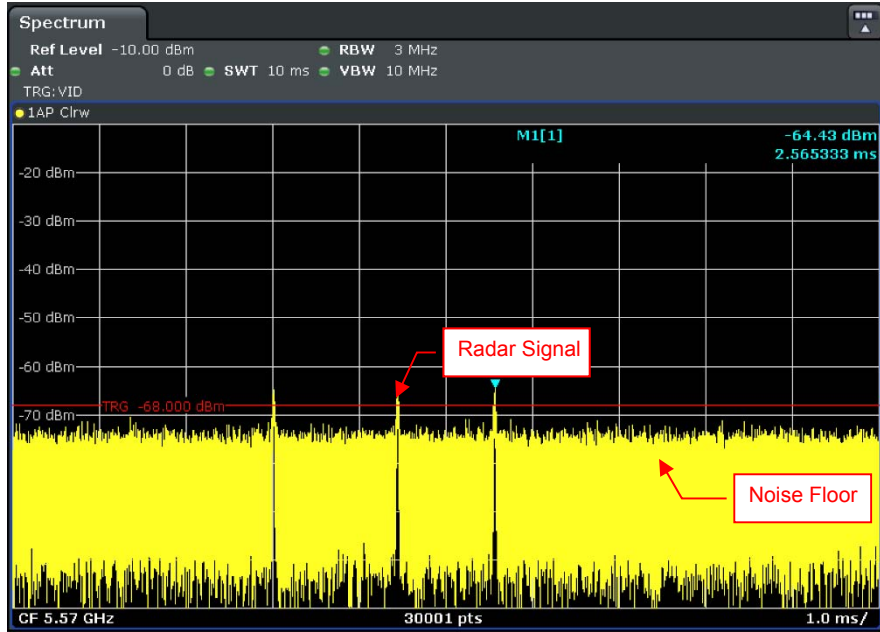

Single Burst of Radar Signal 5

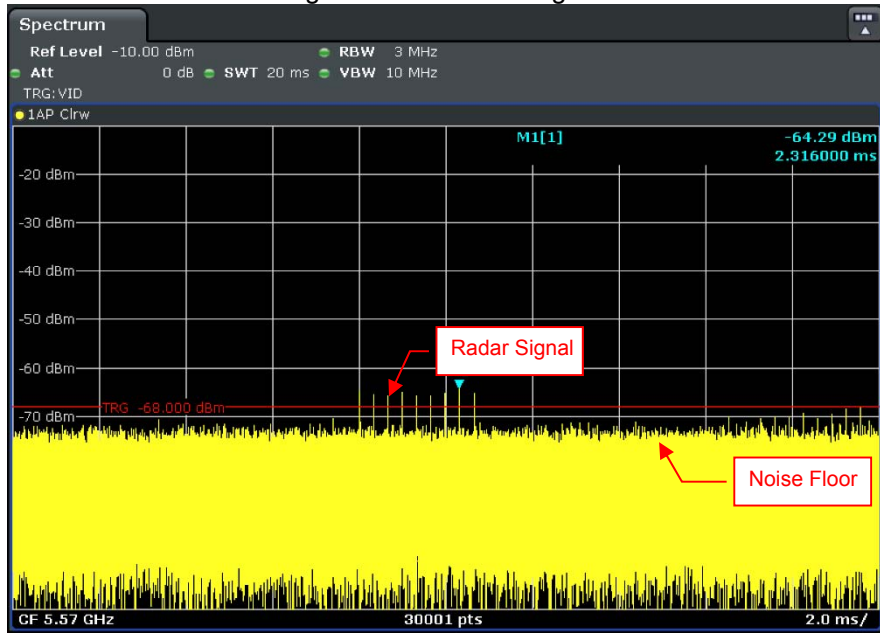

Radar Signal 6

6.2.2 U-NII Detection Bandwidth

802.11ax (HE20)

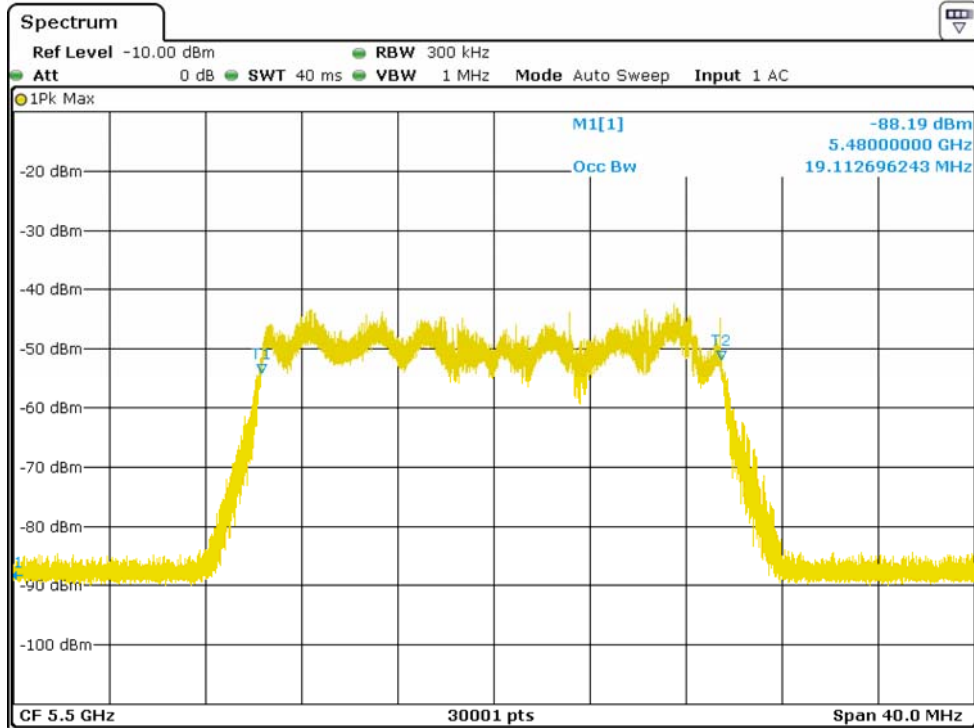

U-NII 99% Channel bandwidth

802.11ax (HE40)

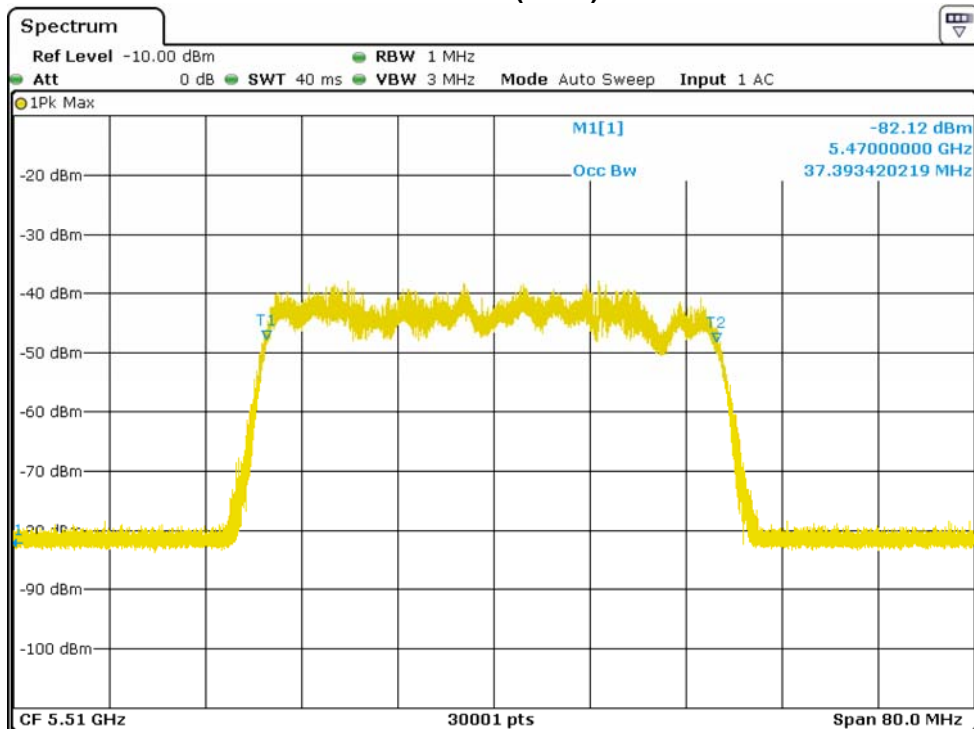

U-NII 99% Channel bandwidth

802.11ax (HE80)

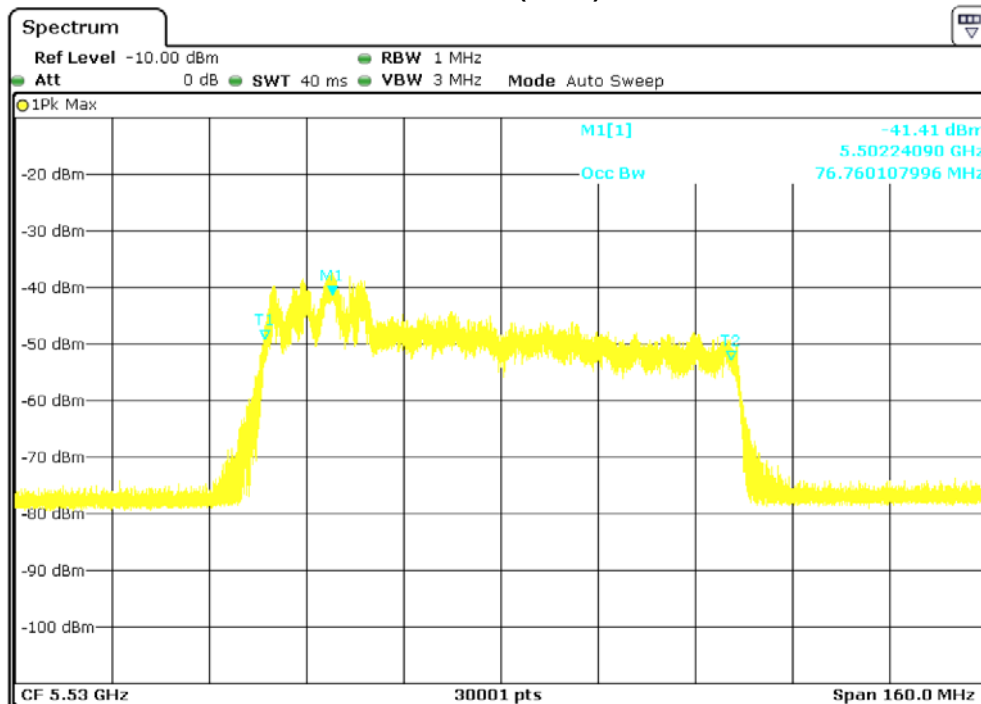

U-NII 99% Channel bandwidth

802.11ax (HE160)

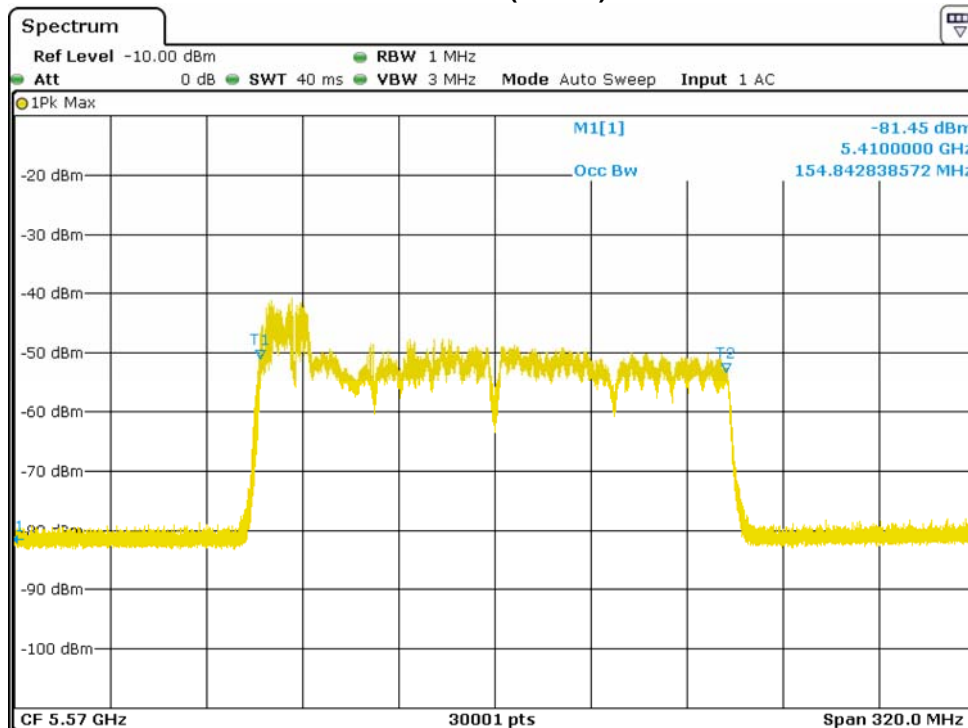

U-NII 99% Channel bandwidth

Detection Bandwidth Test - 802.11ax (HE20)											
Radar Type 0											
EUT Frequency: 5500MHz											
EUT 99% Power bandwidth: 19.112MHz											
Detection bandwidth limit (100% of EUT 99% Power bandwidth): 19.112MHz											
Detection bandwidth (5510(FH) – 5490(FL)) : 20MHz											
Test Result : PASS											
Radar Frequency (MHz)	Trial Number / Detection										Detection Rate (%)
	1	2	3	4	5	6	7	8	9	10	
5490(FL)	Yes	Yes	Yes	Yes	Yes	Yes	Yes	Yes	Yes	Yes	100
5491	Yes	Yes	Yes	Yes	Yes	Yes	Yes	Yes	Yes	Yes	100
5492	Yes	Yes	Yes	Yes	Yes	Yes	Yes	Yes	Yes	Yes	100
5493	Yes	Yes	Yes	Yes	Yes	Yes	Yes	Yes	Yes	Yes	100
5494	Yes	Yes	Yes	Yes	Yes	Yes	Yes	Yes	Yes	Yes	100
5495	Yes	Yes	Yes	Yes	Yes	Yes	Yes	Yes	Yes	Yes	100
5496	Yes	Yes	Yes	Yes	Yes	Yes	Yes	Yes	Yes	Yes	100
5497	Yes	Yes	Yes	Yes	Yes	Yes	Yes	Yes	Yes	Yes	100
5498	Yes	Yes	Yes	Yes	Yes	Yes	Yes	Yes	Yes	Yes	100
5499	Yes	Yes	Yes	Yes	Yes	Yes	Yes	Yes	Yes	Yes	100
5500	Yes	Yes	Yes	Yes	Yes	Yes	Yes	Yes	Yes	Yes	100
5501	Yes	Yes	Yes	Yes	Yes	Yes	Yes	Yes	Yes	Yes	100
5502	Yes	Yes	Yes	Yes	Yes	Yes	Yes	Yes	Yes	Yes	100
5503	Yes	Yes	Yes	Yes	Yes	Yes	Yes	Yes	Yes	Yes	100
5504	Yes	Yes	Yes	Yes	Yes	Yes	Yes	Yes	Yes	Yes	100
5505	Yes	Yes	Yes	Yes	Yes	Yes	Yes	Yes	Yes	Yes	100
5506	Yes	Yes	Yes	Yes	Yes	Yes	Yes	Yes	Yes	Yes	100
5507	Yes	Yes	Yes	Yes	Yes	Yes	Yes	Yes	Yes	Yes	100
5508	Yes	Yes	Yes	Yes	Yes	Yes	Yes	Yes	Yes	Yes	100
5509	Yes	Yes	Yes	Yes	Yes	Yes	Yes	Yes	Yes	Yes	100
5510(FH)	Yes	Yes	Yes	Yes	Yes	Yes	Yes	Yes	Yes	Yes	100

Detection Bandwidth Test - **802.11ax (HE40)**
 Radar Type 0
 EUT Frequency: 5510MHz
 EUT 99% Power bandwidth: 37.393MHz
 Detection bandwidth limit (100% of EUT 99% Power bandwidth): 37.393MHz
 Detection bandwidth (5529(FH) – 5491(FL)) : 38MHz
 Test Result : PASS

Radar Frequency (MHz)	Trial Number / Detection										Detection Rate (%)
	1	2	3	4	5	6	7	8	9	10	
5491(FL)	Yes	Yes	Yes	Yes	Yes	Yes	Yes	Yes	Yes	Yes	100
5492	Yes	Yes	Yes	Yes	Yes	Yes	Yes	Yes	Yes	Yes	100
5493	Yes	Yes	Yes	Yes	Yes	Yes	Yes	Yes	Yes	Yes	100
5494	Yes	Yes	Yes	Yes	Yes	Yes	Yes	Yes	Yes	Yes	100
5495	Yes	Yes	Yes	Yes	Yes	Yes	Yes	Yes	Yes	Yes	100
5496	Yes	Yes	Yes	Yes	Yes	Yes	Yes	Yes	Yes	Yes	100
5497	Yes	Yes	Yes	Yes	Yes	Yes	Yes	Yes	Yes	Yes	100
5498	Yes	Yes	Yes	Yes	Yes	Yes	Yes	Yes	Yes	Yes	100
5499	Yes	Yes	Yes	Yes	Yes	Yes	Yes	Yes	Yes	Yes	100
5500	Yes	Yes	Yes	Yes	Yes	Yes	Yes	Yes	Yes	Yes	100
5501	Yes	Yes	Yes	Yes	Yes	Yes	Yes	Yes	Yes	Yes	100
5502	Yes	Yes	Yes	No	Yes	Yes	Yes	Yes	Yes	Yes	90
5503	Yes	Yes	Yes	Yes	Yes	Yes	Yes	Yes	Yes	Yes	100
5504	Yes	Yes	Yes	Yes	Yes	Yes	Yes	Yes	Yes	Yes	100
5505	Yes	Yes	Yes	Yes	Yes	Yes	Yes	Yes	Yes	Yes	100
5506	Yes	Yes	Yes	Yes	Yes	Yes	Yes	Yes	Yes	Yes	100
5507	Yes	Yes	Yes	Yes	Yes	Yes	Yes	Yes	Yes	Yes	100
5508	Yes	Yes	Yes	Yes	Yes	Yes	Yes	Yes	Yes	Yes	100
5509	Yes	Yes	Yes	Yes	Yes	Yes	Yes	Yes	Yes	Yes	100
5510	Yes	Yes	Yes	Yes	Yes	Yes	Yes	Yes	Yes	Yes	100
5511	Yes	Yes	Yes	Yes	Yes	Yes	Yes	Yes	Yes	Yes	100
5512	Yes	Yes	Yes	Yes	Yes	Yes	Yes	Yes	Yes	Yes	100
5513	Yes	Yes	Yes	Yes	Yes	Yes	Yes	Yes	Yes	Yes	100
5514	Yes	Yes	Yes	Yes	Yes	Yes	Yes	Yes	Yes	Yes	100
5515	Yes	Yes	Yes	Yes	Yes	Yes	Yes	Yes	Yes	Yes	100
5516	Yes	Yes	Yes	Yes	Yes	Yes	Yes	Yes	Yes	Yes	100
5517	Yes	Yes	Yes	Yes	Yes	Yes	Yes	Yes	Yes	Yes	100
5518	Yes	Yes	Yes	Yes	Yes	Yes	Yes	Yes	Yes	Yes	100
5519	Yes	Yes	Yes	Yes	Yes	Yes	Yes	Yes	Yes	Yes	100
5520	Yes	Yes	Yes	Yes	Yes	Yes	Yes	Yes	Yes	Yes	100
5521	Yes	Yes	Yes	Yes	Yes	Yes	Yes	Yes	Yes	Yes	100
5522	Yes	Yes	Yes	Yes	Yes	Yes	Yes	Yes	Yes	Yes	100
5523	Yes	Yes	Yes	Yes	Yes	Yes	Yes	Yes	Yes	Yes	100
5524	Yes	Yes	Yes	Yes	Yes	Yes	Yes	Yes	Yes	Yes	100
5525	Yes	Yes	Yes	Yes	Yes	Yes	Yes	Yes	Yes	Yes	100
5526	Yes	Yes	Yes	Yes	Yes	Yes	Yes	Yes	Yes	Yes	100
5527	Yes	Yes	Yes	Yes	Yes	Yes	Yes	Yes	Yes	Yes	100
5528	Yes	Yes	Yes	Yes	Yes	Yes	Yes	Yes	Yes	Yes	100
5529(FH)	Yes	Yes	Yes	No	Yes	Yes	Yes	Yes	Yes	Yes	90

Detection Bandwidth Test - **802.11ax (HE80)**
 Radar Type 0
 EUT Frequency: 5530MHz
 EUT 99% Power bandwidth: 76.76MHz
 Detection bandwidth limit (100% of EUT 99% Power bandwidth): 76.76MHz
 Detection bandwidth (5569(FH) – 5491(FL)) : 78MHz
 Test Result : PASS

Radar Frequency (MHz)	Trial Number / Detection										Detection Rate (%)
	1	2	3	4	5	6	7	8	9	10	
5491(FL)	Yes	Yes	Yes	Yes	Yes	Yes	Yes	Yes	Yes	Yes	100
5492	Yes	Yes	Yes	Yes	Yes	Yes	Yes	Yes	Yes	Yes	100
5493	Yes	Yes	Yes	Yes	Yes	Yes	Yes	Yes	Yes	Yes	100
5494	Yes	Yes	Yes	Yes	Yes	Yes	Yes	Yes	Yes	Yes	100
5495	Yes	Yes	Yes	Yes	Yes	Yes	Yes	Yes	Yes	Yes	100
5496	Yes	Yes	Yes	Yes	Yes	Yes	Yes	Yes	Yes	Yes	100
5497	Yes	Yes	Yes	Yes	Yes	Yes	Yes	Yes	Yes	Yes	100
5498	Yes	Yes	Yes	Yes	Yes	Yes	Yes	Yes	Yes	Yes	100
5499	Yes	Yes	Yes	Yes	Yes	Yes	Yes	Yes	Yes	Yes	100
5500	Yes	Yes	Yes	Yes	Yes	Yes	Yes	Yes	Yes	Yes	100
5501	Yes	Yes	Yes	Yes	Yes	Yes	Yes	Yes	Yes	Yes	100
5502	Yes	Yes	Yes	Yes	Yes	Yes	Yes	Yes	Yes	Yes	100
5503	Yes	Yes	Yes	Yes	Yes	Yes	Yes	Yes	Yes	Yes	100
5504	Yes	Yes	Yes	Yes	Yes	Yes	Yes	Yes	Yes	Yes	100
5505	Yes	Yes	Yes	Yes	Yes	Yes	Yes	Yes	Yes	Yes	100
5506	Yes	Yes	Yes	Yes	Yes	Yes	Yes	Yes	Yes	Yes	100
5507	Yes	Yes	Yes	Yes	Yes	Yes	Yes	Yes	Yes	Yes	100
5508	Yes	Yes	Yes	Yes	Yes	Yes	Yes	Yes	Yes	Yes	100
5509	Yes	Yes	Yes	Yes	Yes	Yes	Yes	Yes	Yes	Yes	100
5510	Yes	Yes	Yes	Yes	Yes	Yes	Yes	Yes	Yes	Yes	100
5511	Yes	Yes	Yes	Yes	Yes	Yes	Yes	Yes	Yes	Yes	100
5512	Yes	Yes	Yes	Yes	Yes	Yes	Yes	Yes	Yes	Yes	100
5513	Yes	Yes	Yes	Yes	Yes	Yes	Yes	Yes	Yes	Yes	100
5514	Yes	Yes	Yes	Yes	Yes	Yes	Yes	Yes	Yes	Yes	100
5515	Yes	Yes	Yes	Yes	Yes	Yes	Yes	Yes	Yes	Yes	100
5516	Yes	Yes	Yes	Yes	Yes	Yes	Yes	Yes	Yes	Yes	100
5517	Yes	Yes	Yes	Yes	Yes	Yes	Yes	Yes	Yes	Yes	100
5518	Yes	Yes	Yes	Yes	Yes	Yes	Yes	Yes	Yes	Yes	100
5519	Yes	Yes	Yes	Yes	Yes	Yes	Yes	Yes	Yes	Yes	100
5520	Yes	Yes	Yes	Yes	Yes	Yes	Yes	Yes	Yes	Yes	100
5521	Yes	Yes	Yes	Yes	Yes	Yes	Yes	Yes	Yes	Yes	100
5522	Yes	Yes	Yes	Yes	Yes	Yes	Yes	Yes	Yes	Yes	100
5523	Yes	Yes	Yes	Yes	Yes	Yes	Yes	Yes	Yes	Yes	100
5524	Yes	Yes	Yes	Yes	Yes	Yes	Yes	Yes	Yes	Yes	100
5525	Yes	Yes	Yes	Yes	Yes	Yes	Yes	Yes	Yes	Yes	100
5526	Yes	Yes	Yes	Yes	Yes	Yes	Yes	Yes	Yes	Yes	100
5527	Yes	Yes	Yes	Yes	Yes	Yes	Yes	Yes	Yes	Yes	100
5528	Yes	Yes	Yes	Yes	Yes	Yes	Yes	Yes	Yes	Yes	100
5529	Yes	Yes	Yes	Yes	Yes	Yes	Yes	Yes	Yes	Yes	100
5530	Yes	Yes	Yes	Yes	Yes	Yes	Yes	Yes	Yes	Yes	100
5531	Yes	Yes	Yes	Yes	Yes	Yes	Yes	Yes	Yes	Yes	100
5532	Yes	Yes	Yes	Yes	Yes	Yes	Yes	Yes	Yes	Yes	100
5533	Yes	Yes	Yes	Yes	Yes	Yes	Yes	Yes	Yes	Yes	100



5534	Yes	Yes	Yes	Yes	Yes	Yes	Yes	Yes	Yes	Yes	100
5535	Yes	Yes	Yes	Yes	Yes	Yes	Yes	Yes	Yes	Yes	100
5536	Yes	Yes	Yes	Yes	Yes	Yes	Yes	Yes	Yes	Yes	100
5537	Yes	Yes	Yes	Yes	Yes	Yes	Yes	Yes	Yes	Yes	100
5538	Yes	Yes	Yes	Yes	Yes	Yes	Yes	Yes	Yes	Yes	100
5539	Yes	Yes	Yes	Yes	Yes	Yes	Yes	Yes	Yes	Yes	100
5540	Yes	Yes	Yes	Yes	Yes	Yes	Yes	Yes	Yes	Yes	100
5541	Yes	Yes	Yes	Yes	Yes	Yes	Yes	Yes	Yes	Yes	100
5542	Yes	Yes	Yes	Yes	Yes	Yes	Yes	Yes	Yes	Yes	100
5543	Yes	Yes	Yes	Yes	Yes	Yes	Yes	Yes	Yes	Yes	100
5544	Yes	Yes	Yes	Yes	Yes	Yes	Yes	Yes	Yes	Yes	100
5545	Yes	Yes	Yes	Yes	Yes	Yes	Yes	Yes	Yes	Yes	100
5546	Yes	Yes	Yes	Yes	Yes	Yes	Yes	Yes	Yes	Yes	100
5547	Yes	Yes	Yes	Yes	Yes	Yes	Yes	Yes	Yes	Yes	100
5548	Yes	Yes	Yes	Yes	Yes	Yes	Yes	Yes	Yes	Yes	100
5549	Yes	Yes	Yes	Yes	Yes	Yes	Yes	Yes	Yes	Yes	100
5550	Yes	Yes	Yes	Yes	Yes	Yes	Yes	Yes	Yes	Yes	100
5551	Yes	Yes	Yes	Yes	Yes	Yes	Yes	Yes	Yes	Yes	100
5552	Yes	Yes	Yes	Yes	Yes	Yes	Yes	Yes	Yes	Yes	100
5553	Yes	Yes	Yes	Yes	Yes	Yes	Yes	Yes	Yes	Yes	100
5554	Yes	Yes	Yes	Yes	Yes	Yes	Yes	Yes	Yes	Yes	100
5555	Yes	Yes	Yes	Yes	Yes	Yes	Yes	Yes	Yes	Yes	100
5556	Yes	Yes	Yes	Yes	Yes	Yes	Yes	Yes	Yes	Yes	100
5557	Yes	Yes	Yes	Yes	Yes	Yes	Yes	Yes	Yes	Yes	100
5558	Yes	Yes	Yes	Yes	Yes	Yes	Yes	Yes	Yes	Yes	100
5559	Yes	Yes	Yes	Yes	Yes	Yes	Yes	Yes	Yes	Yes	100
5560	Yes	Yes	Yes	Yes	Yes	Yes	Yes	Yes	Yes	Yes	100
5561	Yes	Yes	Yes	Yes	Yes	Yes	Yes	Yes	Yes	Yes	100
5562	Yes	Yes	Yes	Yes	Yes	Yes	Yes	Yes	Yes	Yes	100
5563	Yes	Yes	Yes	Yes	Yes	Yes	Yes	Yes	Yes	Yes	100
5564	Yes	Yes	Yes	Yes	Yes	Yes	Yes	Yes	Yes	Yes	100
5565	Yes	Yes	Yes	Yes	Yes	Yes	Yes	Yes	Yes	Yes	100
5566	Yes	Yes	Yes	Yes	Yes	Yes	Yes	Yes	Yes	Yes	100
5567	Yes	Yes	Yes	Yes	Yes	Yes	Yes	Yes	Yes	Yes	100
5568	Yes	Yes	Yes	Yes	Yes	Yes	Yes	Yes	Yes	Yes	100
5569(FH)	Yes	Yes	Yes	Yes	Yes	Yes	Yes	Yes	Yes	Yes	100

Detection Bandwidth Test - **802.11ax (HE160)**
 Radar Type 0
 EUT Frequency: 5570MHz
 EUT 99% Power bandwidth: 154.842MHz
 Detection bandwidth limit (100% of EUT 99% Power bandwidth): 154.842MHz
 Detection bandwidth (5648(FH) – 5492(FL)) : 156MHz
 Test Result : PASS

Radar Frequency (MHz)	Trial Number / Detection										Detection Rate (%)
	1	2	3	4	5	6	7	8	9	10	
5492 (FL)	Yes	Yes	Yes	Yes	Yes	Yes	Yes	Yes	Yes	Yes	100
5493	Yes	Yes	Yes	Yes	Yes	Yes	Yes	Yes	Yes	Yes	100
5494	Yes	Yes	Yes	Yes	Yes	Yes	Yes	Yes	Yes	Yes	100
5495	Yes	Yes	Yes	Yes	Yes	Yes	Yes	Yes	Yes	Yes	100
5496	Yes	Yes	Yes	Yes	Yes	Yes	Yes	Yes	Yes	Yes	100
5497	Yes	Yes	Yes	Yes	Yes	Yes	Yes	Yes	Yes	Yes	100
5498	Yes	Yes	Yes	Yes	Yes	Yes	Yes	Yes	Yes	Yes	100
5499	Yes	Yes	Yes	Yes	Yes	Yes	Yes	Yes	Yes	Yes	100
5500	Yes	Yes	Yes	Yes	Yes	Yes	Yes	Yes	Yes	Yes	100
5501	Yes	Yes	Yes	Yes	Yes	Yes	Yes	Yes	Yes	Yes	100
5502	Yes	Yes	Yes	Yes	Yes	Yes	Yes	Yes	Yes	Yes	100
5503	Yes	Yes	Yes	Yes	Yes	Yes	Yes	Yes	Yes	Yes	100
5504	Yes	Yes	Yes	Yes	Yes	Yes	Yes	Yes	Yes	Yes	100
5505	Yes	Yes	Yes	Yes	Yes	Yes	Yes	Yes	Yes	Yes	100
5506	Yes	Yes	Yes	Yes	Yes	Yes	Yes	Yes	Yes	Yes	100
5507	Yes	Yes	Yes	Yes	Yes	Yes	Yes	Yes	Yes	Yes	100
5508	Yes	Yes	Yes	Yes	Yes	Yes	Yes	Yes	Yes	Yes	100
5509	Yes	Yes	Yes	Yes	Yes	Yes	Yes	Yes	Yes	Yes	100
5510	Yes	Yes	Yes	Yes	Yes	Yes	Yes	Yes	Yes	Yes	100
5511	Yes	Yes	Yes	Yes	Yes	Yes	Yes	Yes	Yes	Yes	100
5512	No	Yes	Yes	Yes	Yes	Yes	Yes	Yes	Yes	Yes	90
5513	Yes	Yes	Yes	Yes	Yes	Yes	Yes	Yes	Yes	Yes	100
5514	Yes	Yes	Yes	Yes	Yes	Yes	Yes	Yes	Yes	Yes	100
5515	Yes	Yes	Yes	Yes	Yes	Yes	Yes	Yes	Yes	Yes	100
5516	Yes	Yes	Yes	Yes	Yes	Yes	Yes	Yes	Yes	Yes	100
5517	Yes	Yes	Yes	Yes	Yes	Yes	Yes	Yes	Yes	Yes	100
5518	Yes	Yes	Yes	Yes	Yes	Yes	Yes	Yes	Yes	Yes	100
5519	Yes	Yes	Yes	Yes	Yes	Yes	Yes	Yes	Yes	Yes	100
5520	Yes	Yes	Yes	Yes	Yes	Yes	Yes	Yes	Yes	Yes	100
5521	Yes	Yes	Yes	Yes	Yes	Yes	Yes	Yes	Yes	Yes	100
5522	Yes	Yes	Yes	Yes	Yes	Yes	Yes	Yes	Yes	Yes	100
5523	Yes	Yes	Yes	Yes	Yes	Yes	Yes	Yes	Yes	Yes	100
5524	Yes	Yes	Yes	Yes	Yes	Yes	Yes	Yes	Yes	Yes	100
5525	Yes	Yes	Yes	Yes	Yes	Yes	Yes	Yes	Yes	Yes	100
5526	Yes	Yes	Yes	Yes	Yes	Yes	Yes	Yes	Yes	Yes	100
5527	Yes	Yes	Yes	Yes	Yes	Yes	Yes	Yes	Yes	Yes	100
5528	Yes	Yes	Yes	Yes	Yes	Yes	Yes	Yes	Yes	Yes	100
5529	Yes	Yes	Yes	Yes	Yes	Yes	Yes	Yes	Yes	Yes	100
5530	Yes	Yes	Yes	Yes	Yes	Yes	Yes	Yes	Yes	Yes	100
5531	Yes	Yes	Yes	Yes	Yes	Yes	Yes	Yes	Yes	Yes	100
5532	Yes	Yes	Yes	Yes	Yes	Yes	Yes	Yes	Yes	Yes	100
5533	Yes	Yes	Yes	Yes	Yes	Yes	Yes	Yes	Yes	Yes	100
5534	Yes	Yes	Yes	Yes	Yes	Yes	Yes	Yes	Yes	Yes	100



5535	Yes	Yes	Yes	Yes	Yes	Yes	Yes	Yes	Yes	Yes	100
5536	Yes	Yes	Yes	Yes	Yes	Yes	Yes	Yes	Yes	Yes	100
5537	Yes	Yes	Yes	Yes	Yes	Yes	Yes	Yes	Yes	Yes	100
5538	Yes	Yes	Yes	Yes	Yes	Yes	Yes	Yes	Yes	Yes	100
5539	Yes	Yes	Yes	Yes	Yes	Yes	Yes	Yes	Yes	Yes	100
5540	Yes	Yes	Yes	Yes	Yes	Yes	Yes	Yes	Yes	Yes	100
5541	Yes	Yes	Yes	Yes	Yes	Yes	Yes	Yes	Yes	Yes	100
5542	Yes	Yes	Yes	Yes	Yes	Yes	Yes	Yes	Yes	Yes	100
5543	Yes	Yes	Yes	Yes	Yes	Yes	Yes	Yes	Yes	Yes	100
5544	Yes	Yes	Yes	Yes	Yes	Yes	Yes	Yes	Yes	Yes	100
5545	Yes	Yes	Yes	Yes	Yes	Yes	Yes	Yes	Yes	Yes	100
5546	Yes	Yes	Yes	Yes	Yes	Yes	Yes	Yes	Yes	Yes	100
5547	Yes	Yes	Yes	Yes	Yes	Yes	Yes	Yes	Yes	Yes	100
5548	Yes	Yes	Yes	Yes	Yes	Yes	Yes	Yes	Yes	Yes	100
5549	Yes	Yes	Yes	Yes	Yes	Yes	Yes	Yes	Yes	Yes	100
5550	Yes	Yes	Yes	Yes	Yes	Yes	Yes	Yes	Yes	Yes	100
5551	Yes	Yes	Yes	Yes	Yes	Yes	Yes	Yes	Yes	Yes	100
5552	Yes	Yes	Yes	Yes	Yes	Yes	Yes	Yes	Yes	Yes	100
5553	Yes	Yes	Yes	Yes	Yes	Yes	Yes	Yes	Yes	Yes	100
5554	Yes	Yes	Yes	Yes	Yes	Yes	Yes	Yes	Yes	Yes	100
5555	Yes	Yes	Yes	Yes	Yes	Yes	Yes	Yes	Yes	Yes	100
5556	Yes	Yes	Yes	Yes	Yes	Yes	Yes	Yes	Yes	Yes	100
5557	Yes	Yes	Yes	Yes	Yes	Yes	Yes	Yes	Yes	Yes	100
5558	Yes	Yes	Yes	Yes	Yes	Yes	Yes	Yes	Yes	Yes	100
5559	Yes	Yes	Yes	Yes	Yes	Yes	Yes	Yes	Yes	Yes	100
5560	Yes	Yes	Yes	Yes	Yes	Yes	Yes	Yes	Yes	Yes	100
5561	Yes	Yes	Yes	Yes	Yes	Yes	Yes	Yes	Yes	Yes	100
5562	Yes	Yes	Yes	Yes	Yes	Yes	Yes	Yes	Yes	Yes	100
5563	Yes	Yes	Yes	Yes	Yes	Yes	Yes	Yes	Yes	Yes	100
5564	Yes	Yes	Yes	Yes	Yes	Yes	Yes	Yes	Yes	Yes	100
5565	Yes	Yes	Yes	Yes	Yes	Yes	Yes	Yes	Yes	Yes	100
5566	Yes	Yes	Yes	Yes	Yes	Yes	Yes	Yes	Yes	Yes	100
5567	Yes	Yes	Yes	Yes	Yes	Yes	Yes	Yes	Yes	Yes	100
5568	Yes	Yes	Yes	Yes	Yes	Yes	Yes	Yes	Yes	Yes	100
5569	Yes	Yes	Yes	Yes	Yes	Yes	No	Yes	Yes	Yes	90
5570	Yes	Yes	Yes	Yes	Yes	Yes	Yes	Yes	Yes	Yes	100
5571	Yes	Yes	Yes	Yes	Yes	Yes	Yes	Yes	Yes	Yes	100
5572	Yes	Yes	Yes	Yes	Yes	Yes	Yes	Yes	Yes	Yes	100
5573	Yes	Yes	Yes	Yes	Yes	Yes	Yes	Yes	Yes	Yes	100
5574	Yes	Yes	Yes	Yes	Yes	Yes	Yes	Yes	Yes	Yes	100
5575	Yes	Yes	Yes	Yes	Yes	Yes	Yes	Yes	Yes	Yes	100
5576	Yes	No	Yes	Yes	Yes	Yes	Yes	Yes	Yes	Yes	90
5577	Yes	Yes	Yes	Yes	Yes	Yes	Yes	Yes	Yes	Yes	100
5578	Yes	Yes	Yes	Yes	Yes	Yes	Yes	Yes	Yes	Yes	100
5579	Yes	Yes	Yes	Yes	Yes	Yes	Yes	Yes	Yes	Yes	100
5580	Yes	Yes	Yes	Yes	Yes	Yes	Yes	Yes	Yes	Yes	100
5581	Yes	Yes	Yes	Yes	Yes	Yes	Yes	Yes	Yes	Yes	100
5582	Yes	Yes	Yes	Yes	Yes	Yes	Yes	Yes	Yes	Yes	100
5583	Yes	Yes	Yes	Yes	Yes	Yes	Yes	Yes	Yes	Yes	100
5584	Yes	Yes	Yes	Yes	Yes	Yes	Yes	Yes	Yes	Yes	100
5585	Yes	Yes	Yes	Yes	Yes	Yes	Yes	Yes	Yes	Yes	100
5586	Yes	Yes	Yes	Yes	Yes	Yes	Yes	Yes	Yes	Yes	100
5587	Yes	Yes	Yes	Yes	Yes	Yes	Yes	Yes	Yes	Yes	100



5588	Yes	Yes	Yes	Yes	Yes	Yes	Yes	Yes	Yes	Yes	100
5589	Yes	Yes	Yes	Yes	Yes	Yes	Yes	Yes	Yes	Yes	100
5590	Yes	Yes	Yes	Yes	Yes	Yes	Yes	Yes	Yes	Yes	100
5591	Yes	Yes	Yes	Yes	Yes	Yes	Yes	Yes	Yes	Yes	100
5592	Yes	Yes	Yes	Yes	Yes	Yes	Yes	Yes	Yes	Yes	100
5593	Yes	Yes	Yes	Yes	Yes	Yes	Yes	Yes	Yes	Yes	100
5594	Yes	Yes	Yes	Yes	Yes	Yes	Yes	Yes	Yes	Yes	100
5595	Yes	Yes	Yes	Yes	Yes	Yes	Yes	Yes	Yes	Yes	100
5596	Yes	Yes	Yes	Yes	Yes	Yes	Yes	Yes	Yes	Yes	100
5597	Yes	Yes	Yes	Yes	Yes	Yes	Yes	Yes	Yes	Yes	100
5598	Yes	Yes	Yes	Yes	Yes	Yes	Yes	Yes	Yes	Yes	100
5599	Yes	Yes	Yes	Yes	Yes	Yes	Yes	Yes	Yes	Yes	100
5600	Yes	Yes	Yes	Yes	Yes	Yes	Yes	Yes	Yes	Yes	100
5601	Yes	Yes	Yes	Yes	Yes	Yes	Yes	Yes	Yes	Yes	100
5602	Yes	Yes	Yes	Yes	Yes	Yes	Yes	Yes	Yes	Yes	100
5603	Yes	Yes	Yes	Yes	Yes	Yes	Yes	Yes	Yes	Yes	100
5604	Yes	Yes	Yes	Yes	Yes	Yes	Yes	Yes	Yes	Yes	100
5605	Yes	Yes	Yes	Yes	Yes	Yes	Yes	Yes	Yes	Yes	100
5606	Yes	Yes	Yes	Yes	Yes	Yes	Yes	Yes	Yes	Yes	100
5607	Yes	Yes	Yes	Yes	Yes	Yes	Yes	Yes	Yes	Yes	100
5608	Yes	Yes	Yes	Yes	Yes	Yes	Yes	Yes	Yes	Yes	100
5609	Yes	Yes	Yes	Yes	Yes	Yes	Yes	Yes	Yes	Yes	100
5610	Yes	Yes	Yes	Yes	Yes	Yes	Yes	Yes	Yes	Yes	100
5611	Yes	Yes	Yes	Yes	Yes	Yes	Yes	Yes	Yes	Yes	100
5612	Yes	Yes	Yes	Yes	Yes	Yes	Yes	Yes	Yes	Yes	100
5613	Yes	Yes	Yes	Yes	Yes	Yes	Yes	Yes	Yes	Yes	100
5614	Yes	Yes	Yes	Yes	Yes	Yes	Yes	Yes	Yes	Yes	100
5615	Yes	Yes	Yes	Yes	Yes	Yes	Yes	Yes	Yes	Yes	100
5616	Yes	Yes	Yes	Yes	Yes	Yes	Yes	Yes	Yes	Yes	100
5617	Yes	Yes	Yes	Yes	Yes	Yes	Yes	Yes	Yes	Yes	100
5618	Yes	Yes	Yes	Yes	Yes	Yes	Yes	Yes	Yes	Yes	100
5619	Yes	Yes	Yes	Yes	Yes	Yes	Yes	Yes	Yes	Yes	100
5620	Yes	Yes	Yes	Yes	Yes	Yes	Yes	Yes	Yes	Yes	100
5621	Yes	Yes	Yes	Yes	Yes	Yes	Yes	Yes	Yes	Yes	100
5622	Yes	Yes	Yes	Yes	Yes	Yes	Yes	Yes	Yes	Yes	100
5623	Yes	Yes	Yes	Yes	Yes	Yes	Yes	Yes	Yes	Yes	100
5624	Yes	Yes	Yes	Yes	Yes	Yes	Yes	Yes	Yes	Yes	100
5625	Yes	Yes	Yes	Yes	Yes	Yes	Yes	Yes	Yes	Yes	100
5626	Yes	Yes	Yes	Yes	Yes	Yes	Yes	Yes	Yes	Yes	100
5627	Yes	Yes	Yes	Yes	Yes	Yes	Yes	Yes	Yes	Yes	100
5628	Yes	Yes	Yes	Yes	Yes	Yes	Yes	Yes	Yes	Yes	100
5629	Yes	Yes	Yes	Yes	Yes	Yes	Yes	Yes	Yes	Yes	100
5630	Yes	Yes	Yes	Yes	Yes	Yes	Yes	Yes	Yes	Yes	100
5631	Yes	Yes	Yes	Yes	Yes	Yes	Yes	Yes	Yes	Yes	100
5632	Yes	Yes	Yes	Yes	Yes	Yes	Yes	Yes	Yes	Yes	100
5633	Yes	Yes	Yes	Yes	Yes	Yes	Yes	Yes	Yes	Yes	100
5634	Yes	Yes	Yes	Yes	Yes	Yes	Yes	Yes	Yes	Yes	100
5635	Yes	Yes	Yes	Yes	Yes	Yes	Yes	Yes	Yes	Yes	100
5636	Yes	Yes	Yes	Yes	Yes	Yes	Yes	Yes	Yes	Yes	100
5637	Yes	Yes	Yes	Yes	Yes	Yes	Yes	Yes	Yes	Yes	100
5638	Yes	Yes	Yes	Yes	Yes	Yes	Yes	Yes	Yes	Yes	100
5639	Yes	Yes	Yes	Yes	Yes	Yes	Yes	Yes	Yes	No	90



5640	Yes	Yes	Yes	Yes	Yes	Yes	Yes	Yes	Yes	Yes	100
5641	Yes	Yes	Yes	Yes	Yes	Yes	Yes	Yes	Yes	Yes	100
5642	Yes	Yes	Yes	Yes	Yes	Yes	Yes	Yes	Yes	Yes	100
5643	Yes	Yes	Yes	Yes	Yes	Yes	Yes	Yes	Yes	Yes	100
5644	Yes	Yes	Yes	Yes	Yes	Yes	Yes	Yes	Yes	Yes	100
5645	Yes	Yes	Yes	Yes	Yes	Yes	Yes	Yes	Yes	Yes	100
5646	Yes	Yes	Yes	Yes	Yes	Yes	Yes	Yes	Yes	Yes	100
5647	Yes	Yes	Yes	Yes	Yes	Yes	Yes	Yes	Yes	Yes	100
5648(FH)	Yes	Yes	Yes	Yes	Yes	Yes	Yes	Yes	Yes	Yes	100

6.2.3 Channel Availability Check Time

If the EUT successfully detected the radar burst, it should be observed as the EUT has no transmissions occurred until the EUT starts transmitting on another channel.

Timing of Radar Signal	Observation	
	EUT	Spectrum Analyzer
Within 1 to 6 second	Detected	No transmissions
Within 54 to 60 second	Detected	No transmissions

Initial Channel Availability Check Time

Channel Availability Check @ CH114 - 5570MHz

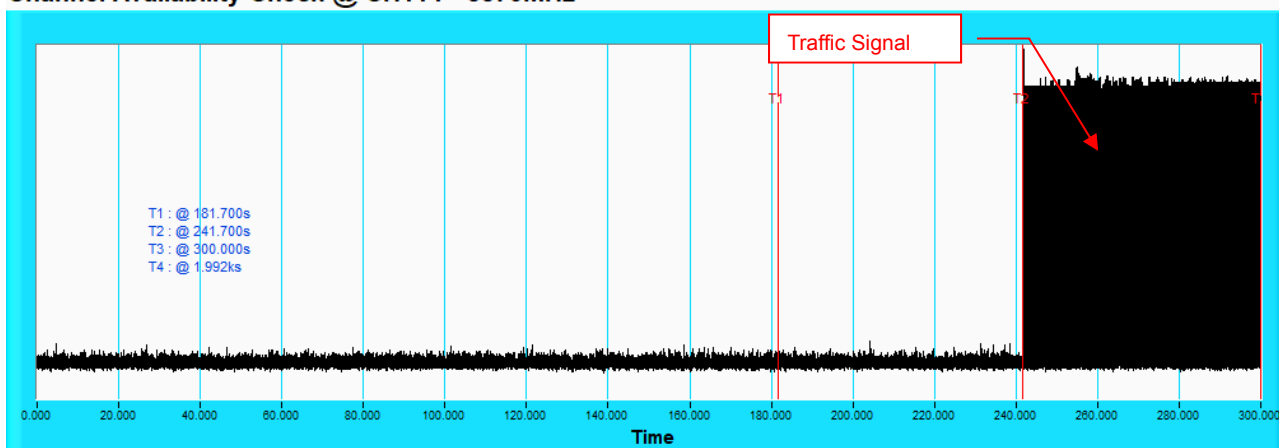

NOTE: T1 denotes the end of power-up time period is 181.7th second. T2 denotes the end of Channel Availability Check time is 241.7th second. Channel Availability Check time is equal to (T2 – T1) 60 seconds.

Radar Burst at the Beginning of the Channel Availability Check Time

Channel Availability Check @ CH114 - 5570MHz

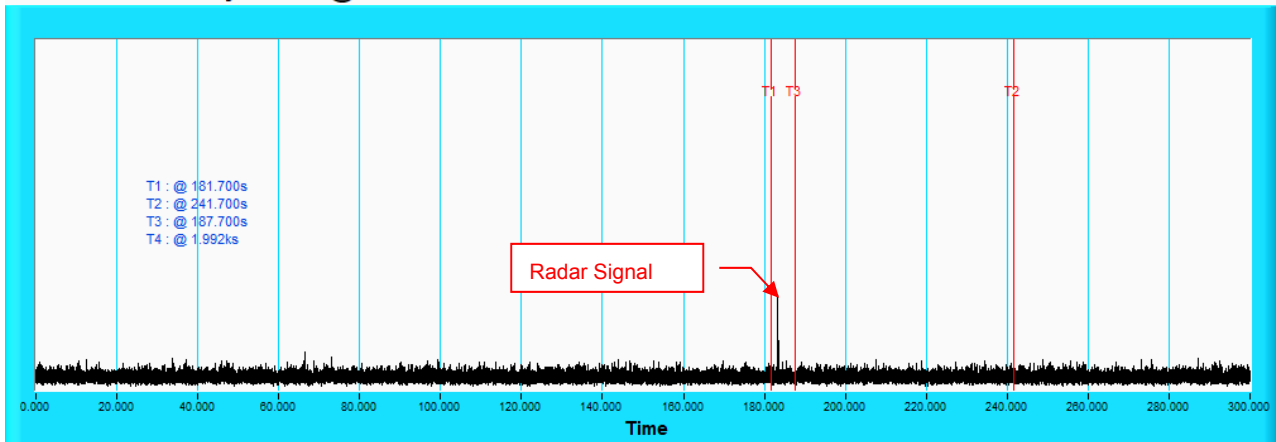

NOTE: T1 denotes the end of power up time period is 181.7th second. T3 denotes 187.7th second and the radar burst was commenced within a 6 second window starting from the end of power-up sequence. T2 denotes the 241.7th second.

Radar Burst at the End of the Channel Availability Check Time

Channel Availability Check @ CH114 - 5570MHz

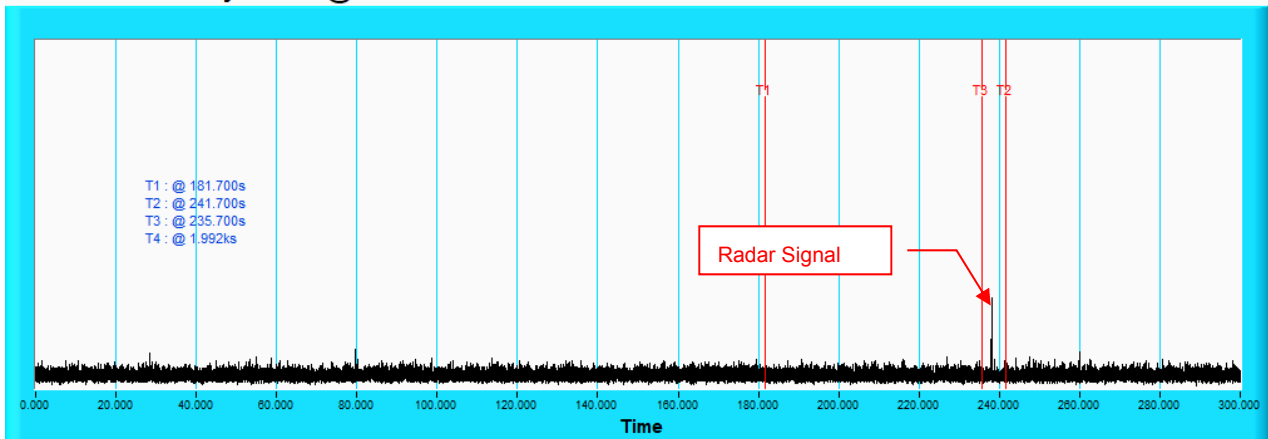

NOTE: T1 denotes the end of power up time period is 181.7th second. T3 denotes 235.7th second and the radar burst was commenced within 54th second to 60th second window starting from the end of power-up sequence. T2 denotes the 241.7th second.

6.2.4 Channel Closing Transmission and Channel Move Time

Wireless Traffic Loading

802.11ax (HE20)

Duty Cycle

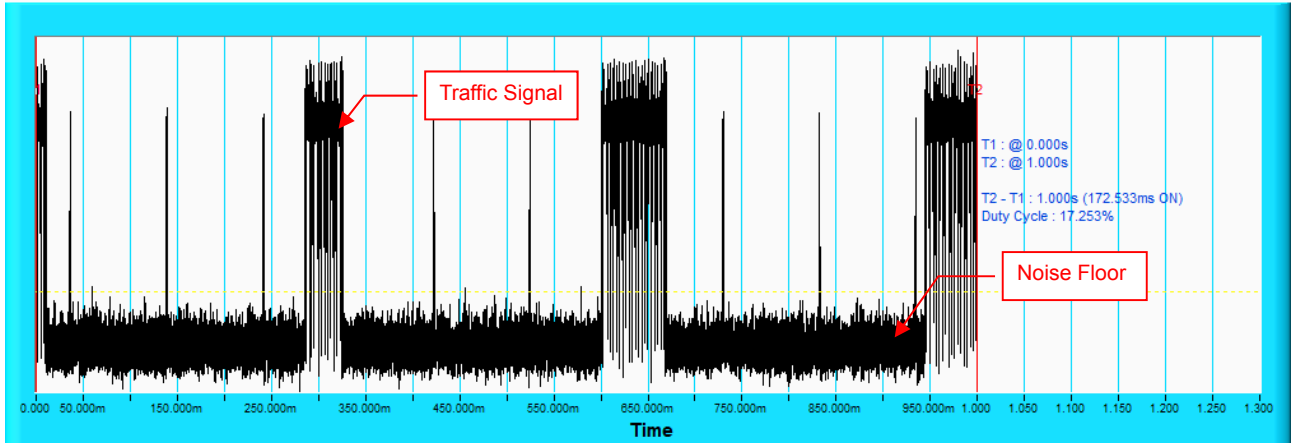

802.11ax (HE40)

Duty Cycle

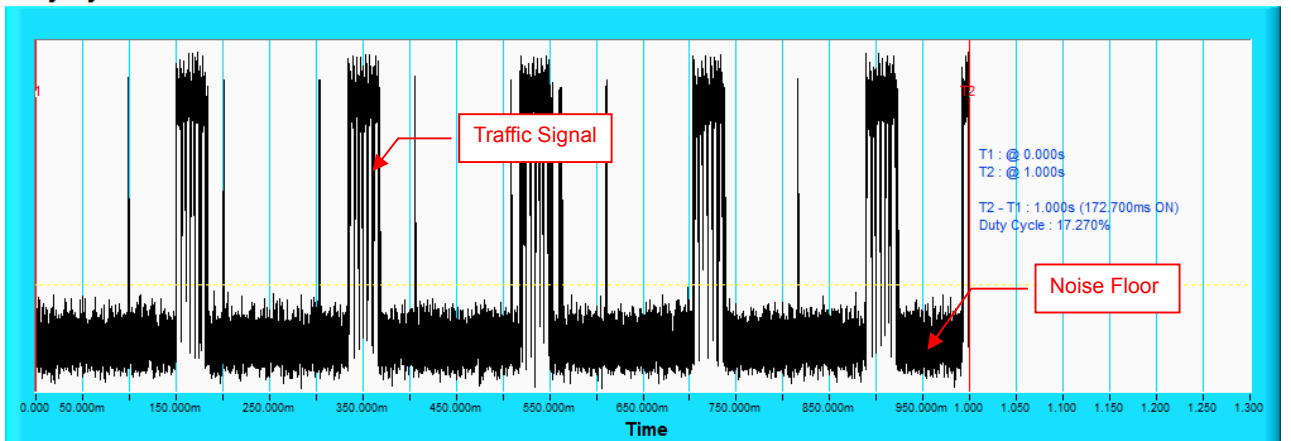

802.11ax (HE80)

Duty Cycle

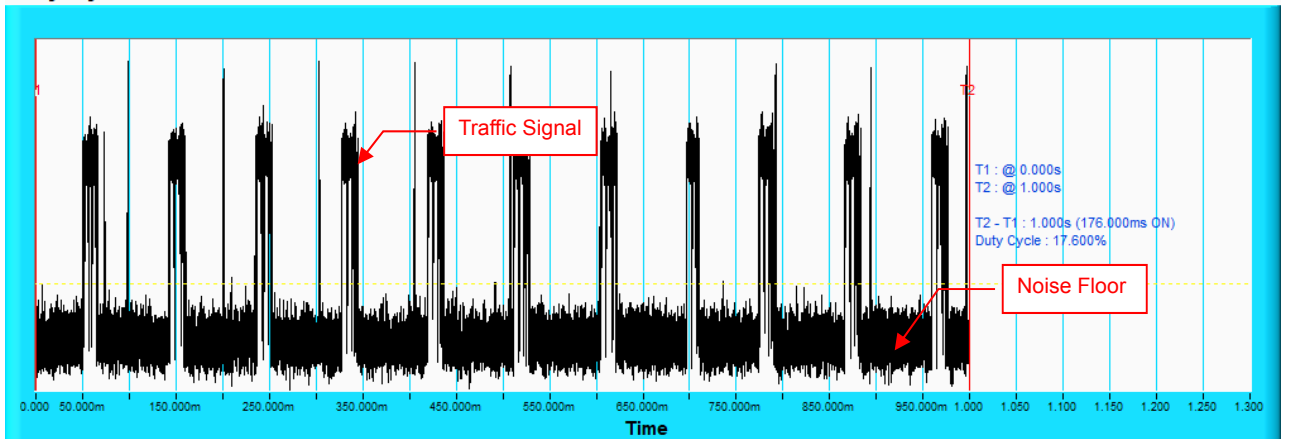



802.11ax (HE160)

Duty Cycle

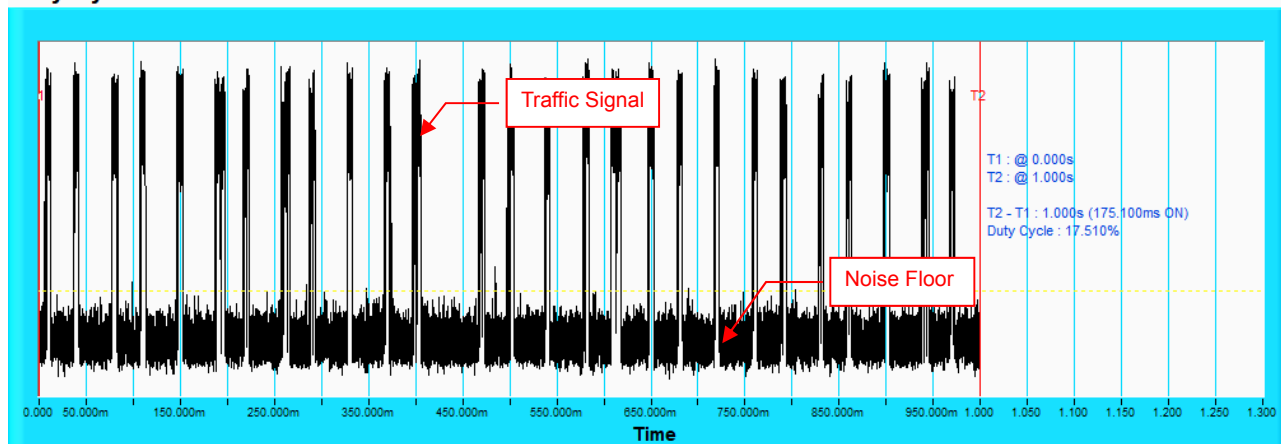

802.11ax (HE20)

Table 1: Short Pulse Radar Test Waveforms

Radar Type	Pulse Width (μsec)	PRI (μsec)	Number of Pulses	Number of Trials(Times)	Percentage of Successful Detection (%)
1	Test A 15 unique PRI values randomly selected from the list of 23 PRI values	Roundup $\left\{ \left\lceil \frac{1}{360} \cdot \left(\frac{19 \cdot 10^6}{\text{PRI}_{\mu\text{sec}}} \right) \right\rceil \right\}$	18	30	93.3
	15 unique PRI values randomly selected within the range of 518~3066μsec with a minimum of 1μsec,excluding PRI values selected in Test A				
2	1-5	150-230	23-29	30	80
3	6-10	200-500	16-18	30	86.7
4	11-20	200-500	12-16	30	76.7
Aggregate (Radar Types 1-4)				120	84.2

Table 2: Long Pulse Radar Test Waveform

Radar Type	Pulse Width (μsec)	Chirp Width (MHz)	PRI (μsec)	Number of Pulses per Burst	Number of Bursts	Number of Trials(Times)	Percentage of Successful Detection (%)
5	50-100	5-20	1000-2000	1-3	8-20	30	86.7

Table 3: Frequency Hopping Radar Test Waveform

Radar Type	Pulse Width (μsec)	PRI (μsec)	Pulses per Hop	Hopping Rate (kHz)	Hopping Sequence Length (msec)	Number of Trials(Times)	Percentage of Successful Detection (%)
6	1	333	9	0.333	300	30	93.3

802.11ax (HE40)

Table 1: Short Pulse Radar Test Waveforms

Radar Type	Pulse Width (μsec)	PRI (μsec)	Number of Pulses	Number of Trials(Times)	Percentage of Successful Detection (%)
1	Test A 15 unique PRI values randomly selected from the list of 23 PRI values	Roundup $\left\{ \left\lfloor \frac{1}{360} \cdot \right\rfloor \right\}$ $\left\{ \left\lfloor \frac{19 \cdot 10^6}{PRI_{\mu sec}} \right\rfloor \right\}$	18	30	83.3
	15 unique PRI values randomly selected within the range of 518~3066μsec with a minimum of 1μsec, excluding PRI values selected in Test A				
2	1-5	150-230	23-29	30	66.7
3	6-10	200-500	16-18	30	86.7
4	11-20	200-500	12-16	30	86.7
Aggregate (Radar Types 1-4)				120	80.9

Table 2: Long Pulse Radar Test Waveform

Radar Type	Pulse Width (μsec)	Chirp Width (MHz)	PRI (μsec)	Number of Pulses per Burst	Number of Bursts	Number of Trials(Times)	Percentage of Successful Detection (%)
5	50-100	5-20	1000-2000	1-3	8-20	30	90

Table 3: Frequency Hopping Radar Test Waveform

Radar Type	Pulse Width (μsec)	PRI (μsec)	Pulses per Hop	Hopping Rate (kHz)	Hopping Sequence Length (msec)	Number of Trials(Times)	Percentage of Successful Detection (%)
6	1	333	9	0.333	300	30	86.7

802.11ax (HE80)

Table 1: Short Pulse Radar Test Waveforms

Radar Type	Pulse Width (μsec)	PRI (μsec)	Number of Pulses	Number of Trials(Times)	Percentage of Successful Detection (%)
1	Test A 15 unique PRI values randomly selected from the list of 23 PRI values	Roundup $\left\{ \left\lceil \frac{1}{360} \cdot \left(\frac{19 \cdot 10^6}{\text{PRI}_{\mu\text{sec}}} \right) \right\rceil \right\}$	18	30	90
	15 unique PRI values randomly selected within the range of 518~3066μsec with a minimum of 1μsec,excluding PRI values selected in Test A				
2	1-5	150-230	23-29	30	86.7
3	6-10	200-500	16-18	30	80
4	11-20	200-500	12-16	30	86.7
Aggregate (Radar Types 1-4)				120	85.9

Table 2: Long Pulse Radar Test Waveform

Radar Type	Pulse Width (μsec)	Chirp Width (MHz)	PRI (μsec)	Number of Pulses per Burst	Number of Bursts	Number of Trials(Times)	Percentage of Successful Detection (%)
5	50-100	5-20	1000-2000	1-3	8-20	30	86.7

Table 3: Frequency Hopping Radar Test Waveform

Radar Type	Pulse Width (μsec)	PRI (μsec)	Pulses per Hop	Hopping Rate (kHz)	Hopping Sequence Length (msec)	Number of Trials(Times)	Percentage of Successful Detection (%)
6	1	333	9	0.333	300	30	90

802.11ax (HE160)

Table 1: Short Pulse Radar Test Waveforms

Radar Type	Pulse Width (μsec)	PRI (μsec)	Number of Pulses	Number of Trials(Times)	Percentage of Successful Detection (%)
1	Test A 15 unique PRI values randomly selected from the list of 23 PRI values	Roundup $\left\{ \left\{ \frac{1}{360} \right\} \cdot \left\{ \frac{19 \cdot 10^6}{\text{PRI}_{\mu\text{sec}}} \right\} \right\}$	18	30	90
	15 unique PRI values randomly selected within the range of 518~3066μsec with a minimum of 1μsec,excluding PRI values selected in Test A				
2	1-5	150-230	23-29	30	80
3	6-10	200-500	16-18	30	76.7
4	11-20	200-500	12-16	30	76.7
Aggregate (Radar Types 1-4)				120	80.9

Table 2: Long Pulse Radar Test Waveform

Radar Type	Pulse Width (μsec)	Chirp Width (MHz)	PRI (μsec)	Number of Pulses per Burst	Number of Bursts	Number of Trials(Times)	Percentage of Successful Detection (%)
5	50-100	5-20	1000-2000	1-3	8-20	30	80

Table 3: Frequency Hopping Radar Test Waveform

Radar Type	Pulse Width (μsec)	PRI (μsec)	Pulses per Hop	Hopping Rate (kHz)	Hopping Sequence Length (msec)	Number of Trials(Times)	Percentage of Successful Detection (%)
6	1	333	9	0.333	300	30	90

Radar signal 0

802.11ax (HE160)

Channel Closing Transmission Time & Channel Move Time @ CH114 - 5570 MHz

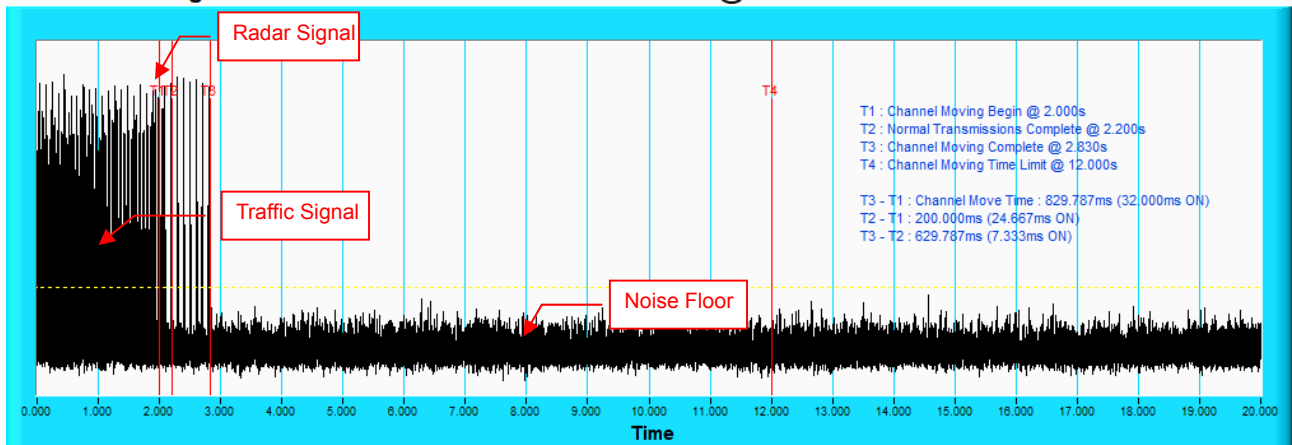

NOTE: T1 denotes the start of Channel Move Time upon the end of the last Radar burst. T2 denotes the data transmission time of 200ms from T1. T3 denotes the end of Channel Move Time. T4 denotes the 10 second from T1 to observe the aggregate duration of transmissions.

Channel Closing Transmission Time & Channel Move Time @ CH114 - 5570 MHz

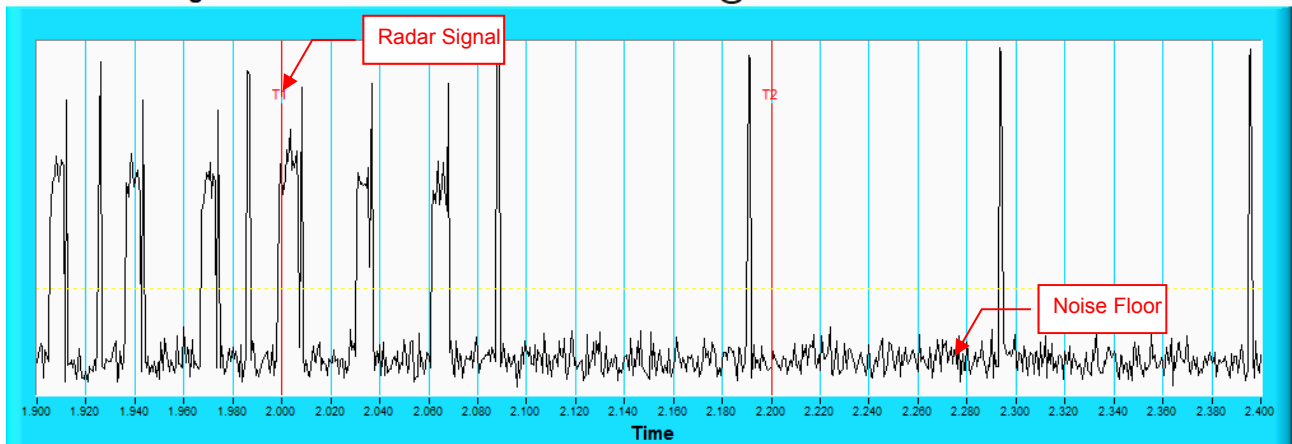

NOTE: Zoom in of the first 500ms after radar signal applied.

Radar signal 1

802.11ax (HE160)

Channel Closing Transmission Time & Channel Move Time @ CH114 - 5570MHZ

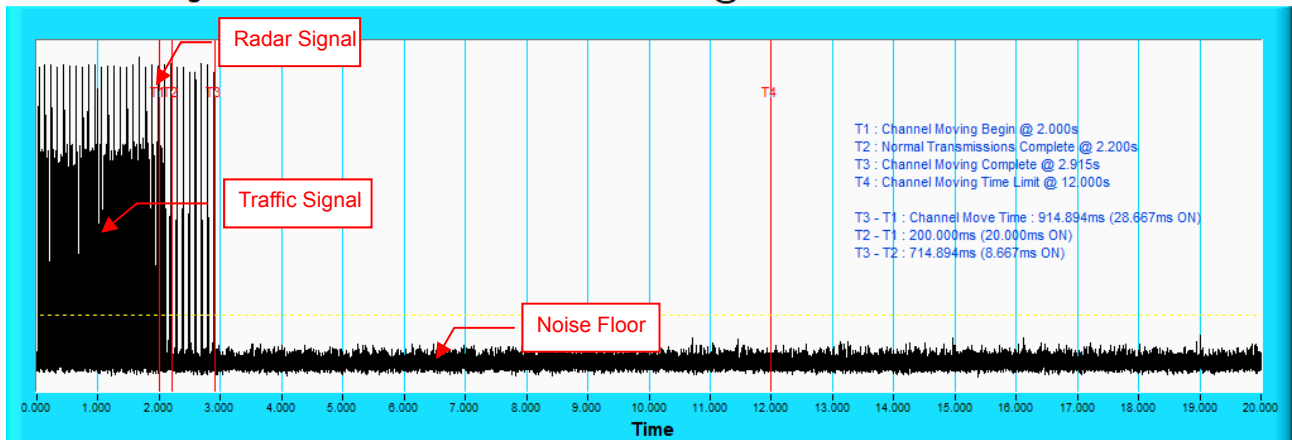

NOTE: T1 denotes the start of Channel Move Time upon the end of the last Radar burst. T2 denotes the data transmission time of 200ms from T1. T3 denotes the end of Channel Move Time. T4 denotes the 10 second from T1 to observe the aggregate duration of transmissions.

Channel Closing Transmission Time & Channel Move Time @ CH114 - 5570MHZ

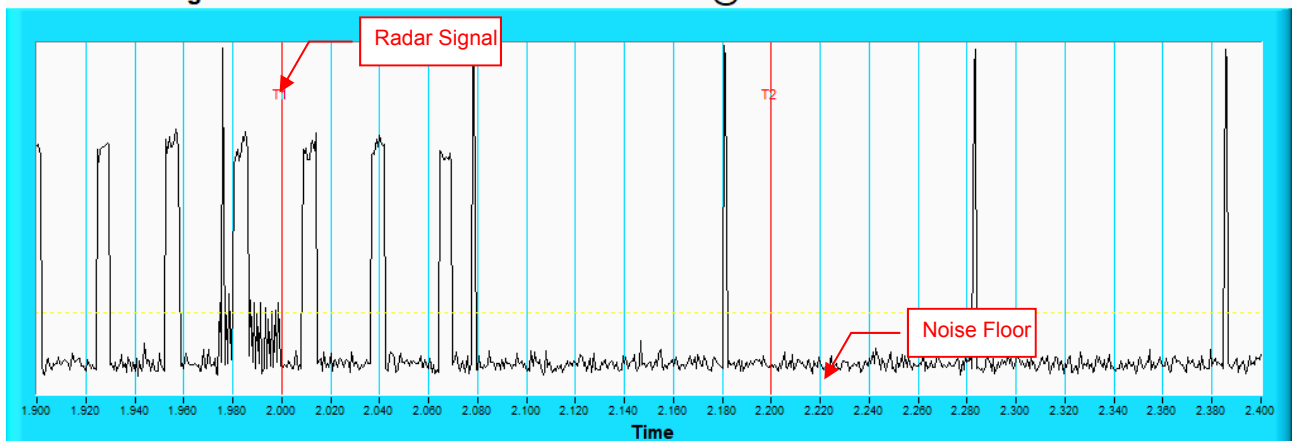

NOTE: Zoom in of the first 500ms after radar signal applied.

Radar signal 2

802.11ax (HE160)

Channel Closing Transmission Time & Channel Move Time @ CH114 - 5570 MHz

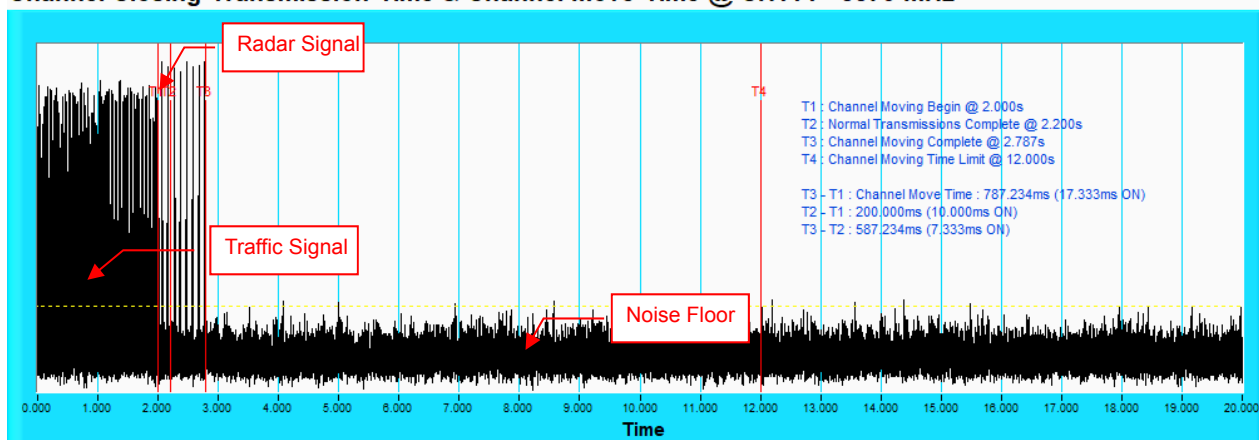

NOTE: T1 denotes the start of Channel Move Time upon the end of the last Radar burst. T2 denotes the data transmission time of 200ms from T1. T3 denotes the end of Channel Move Time. T4 denotes the 10 second from T1 to observe the aggregate duration of transmissions.

Channel Closing Transmission Time & Channel Move Time @ CH114 - 5570 MHz

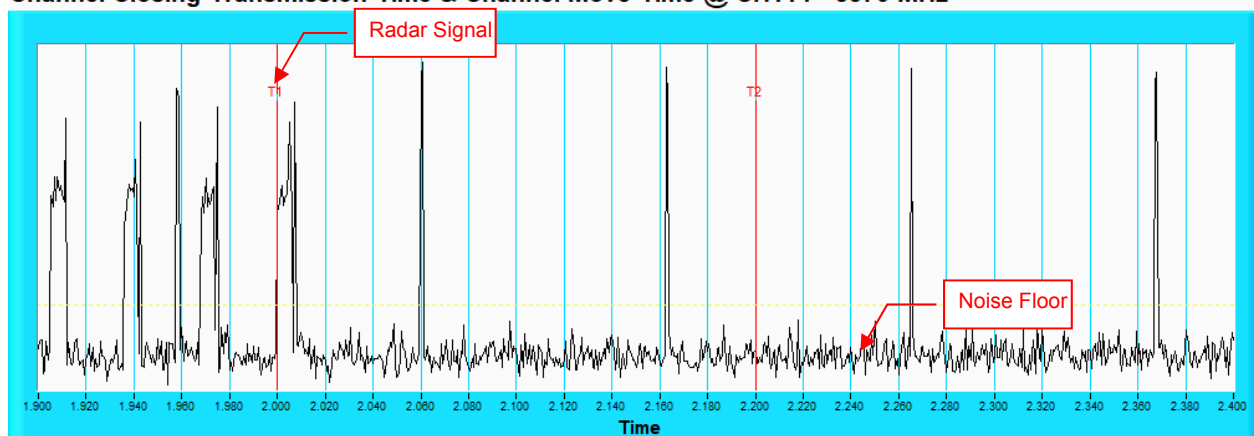

NOTE: Zoom in of the first 500ms after radar signal applied.

Radar signal 3

802.11ax (HE160)

Channel Closing Transmission Time & Channel Move Time @ CH114 - 5570 MHz

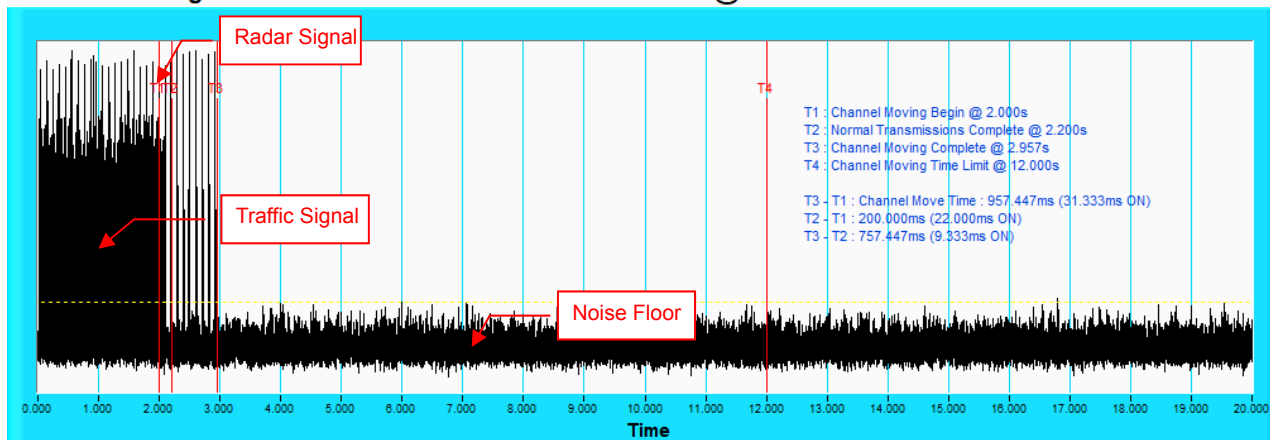

NOTE: T1 denotes the start of Channel Move Time upon the end of the last Radar burst. T2 denotes the data transmission time of 200ms from T1. T3 denotes the end of Channel Move Time. T4 denotes the 10 second from T1 to observe the aggregate duration of transmissions.

Channel Closing Transmission Time & Channel Move Time @ CH114 - 5570 MHz

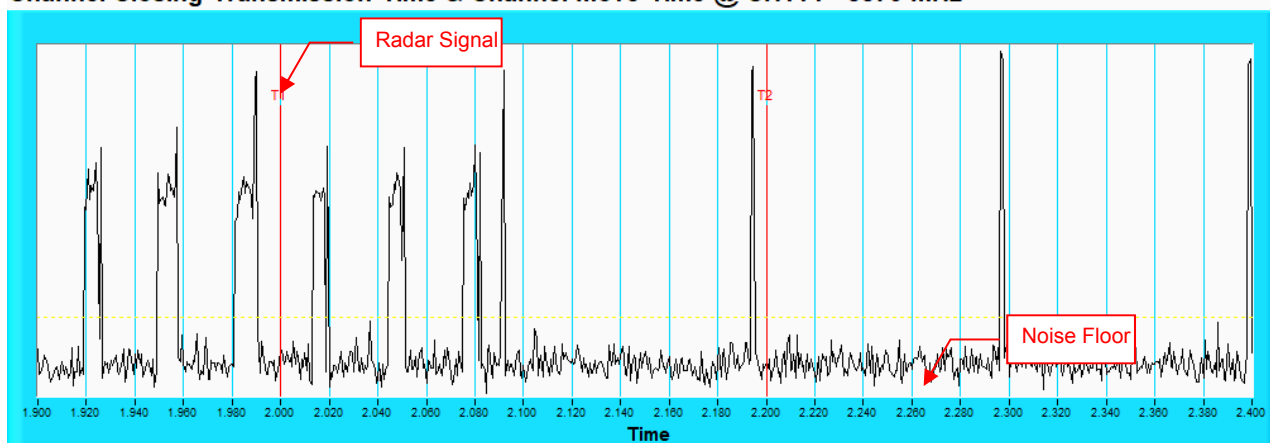

NOTE: Zoom in of the first 500ms after radar signal applied.

Radar signal 4

802.11ax (HE160)

Channel Closing Transmission Time & Channel Move Time @ CH114 - 5570 MHz

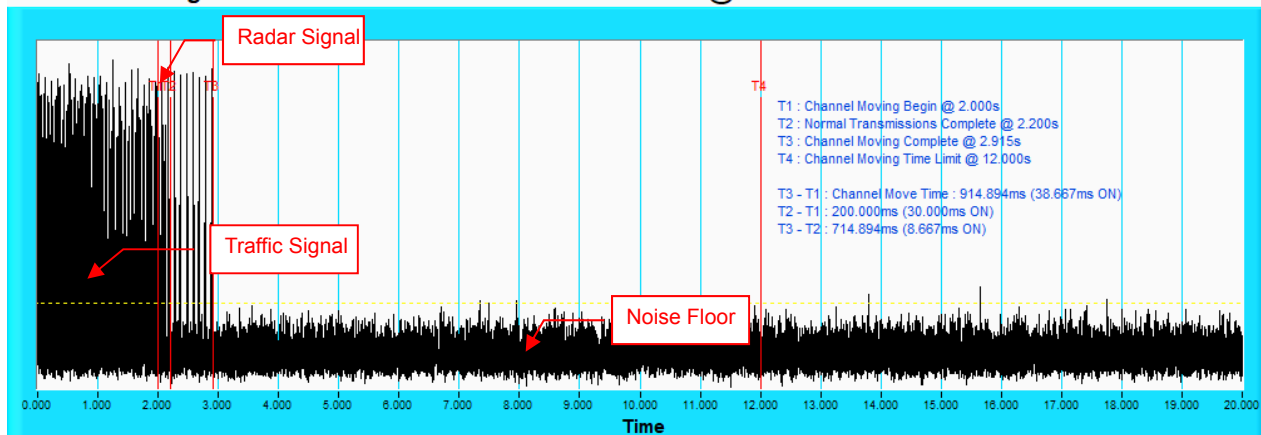

NOTE: T1 denotes the start of Channel Move Time upon the end of the last Radar burst. T2 denotes the data transmission time of 200ms from T1. T3 denotes the end of Channel Move Time. T4 denotes the 10 second from T1 to observe the aggregate duration of transmissions.

Channel Closing Transmission Time & Channel Move Time @ CH114 - 5570 MHz

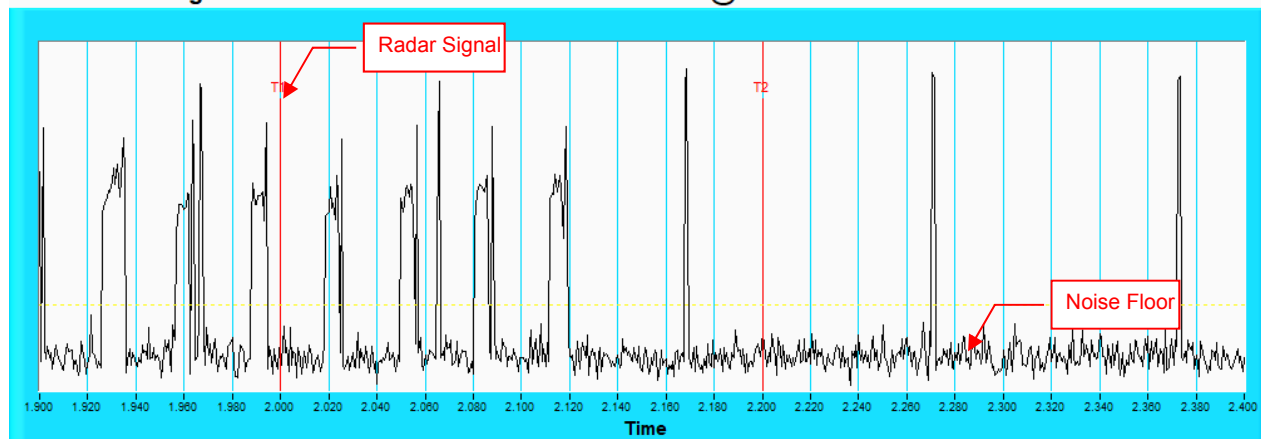

NOTE: Zoom in of the first 500ms after radar signal applied.

802.11ax (HE20)

Type 1 Radar Statistical Performances

Trial #	Test Frequency (MHz)	Pulse Repetition Frequency Number (1 to 23)	Pulse Repetition Frequency (pps)	Pulses per Burst	Pulse Repetition Interval (µsec)	Detection
1	5500	15	1253.1	67	798	Yes
2	5495	16	1222.5	65	818	Yes
3	5502	4	1730.1	92	578	Yes
4	5491	11	1392.8	74	718	Yes
5	5501	22	1066.1	57	938	Yes
6	5492	7	1567.4	83	638	Yes
7	5501	2	1858.7	99	538	Yes
8	5493	8	1519.8	81	658	Yes
9	5505	1	1930.5	102	518	Yes
10	5502	19	1139	61	878	Yes
11	5502	21	1089.3	58	918	Yes
12	5495	23	326.2	18	3066	Yes
13	5507	9	1474.9	78	678	Yes
14	5509	5	1672.2	89	598	No
15	5497	6	1618.1	86	618	Yes
16	5505	-	1111.1	59	900	Yes
17	5495	-	1023.5	55	977	Yes
18	5493	-	625.8	34	1598	Yes
19	5508	-	730.5	39	1369	Yes
20	5494	-	1180.6	63	847	Yes
21	5508	-	400.6	22	2496	Yes
22	5491	-	529.4	28	1889	Yes
23	5497	-	347.6	19	2877	Yes
24	5500	-	641.4	34	1559	Yes
25	5493	-	508.9	27	1965	No
26	5507	-	345.4	19	2895	Yes
27	5498	-	580.7	31	1722	Yes
28	5498	-	786.8	42	1271	Yes
29	5504	-	808.4	43	1237	Yes
30	5494	-	517.1	28	1934	Yes

Detection Rate : 93.3%

Note. " - " : 15 unique PRI values randomly selected within the range of 518-3066 µsec, with a minimum increment of 1µsec, excluding PRI values selected in Test A



802.11ax (HE20)

Type 2 Radar Statistical Performances

Trial #	Test Frequency (MHz)	Pulses per Burst	Pulse Width(us)	PRI(us)	Detection
1	5500	24	1.7	174	No
2	5504	27	3.8	176	Yes
3	5506	28	4	161	Yes
4	5506	28	4.3	226	No
5	5505	24	1.9	193	Yes
6	5508	23	1.1	230	Yes
7	5491	29	4.5	198	Yes
8	5497	26	2.9	227	Yes
9	5501	26	2.8	171	Yes
10	5507	27	3.6	221	No
11	5504	23	1.1	180	Yes
12	5499	23	1.3	189	Yes
13	5494	25	2.5	204	Yes
14	5510	29	4.5	203	Yes
15	5501	29	5	170	Yes
16	5497	26	3.1	201	No
17	5497	24	2.1	218	Yes
18	5509	25	2.6	208	Yes
19	5493	24	1.8	223	No
20	5509	23	1.2	220	Yes
21	5496	26	2.9	224	Yes
22	5493	28	4	160	Yes
23	5496	25	2.5	209	Yes
24	5505	23	1	205	Yes
25	5502	27	3.7	151	Yes
26	5497	25	2.5	186	No
27	5509	23	1.5	190	Yes
28	5496	23	1.3	185	Yes
29	5508	23	1.2	175	Yes
30	5492	24	1.7	216	Yes

Detection Rate : 80%

802.11ax (HE20)

Type 3 Radar Statistical Performances					
Trial #	Test Frequency (MHz)	Pulses per Burst	Pulse Width(us)	PRI(us)	Detection
1	5500	16	6.7	467	Yes
2	5499	18	8.8	304	Yes
3	5505	18	9	316	Yes
4	5503	18	9.3	439	Yes
5	5510	16	6.9	420	Yes
6	5498	16	6.1	249	Yes
7	5502	18	9.5	463	Yes
8	5493	17	7.9	258	No
9	5499	17	7.8	212	Yes
10	5502	17	8.6	236	Yes
11	5494	16	6.1	474	Yes
12	5505	16	6.3	461	Yes
13	5506	17	7.5	437	Yes
14	5506	18	9.5	287	Yes
15	5506	18	10	395	Yes
16	5504	17	8.1	322	Yes
17	5505	16	7.1	468	No
18	5501	17	7.6	255	Yes
19	5499	16	6.8	423	Yes
20	5505	16	6.2	456	No
21	5505	17	7.9	351	Yes
22	5508	18	9	411	Yes
23	5499	17	7.5	279	Yes
24	5494	16	6	431	Yes
25	5505	17	8.7	324	Yes
26	5505	17	7.5	419	Yes
27	5491	16	6.5	447	No
28	5496	16	6.3	481	Yes
29	5491	16	6.2	438	Yes
30	5508	16	6.7	270	Yes
				Detection Rate : 86.7%	

802.11ax (HE20)
Type 4 Radar Statistical Performances

Trial #	Test Frequency (MHz)	Pulses per Burst	Pulse Width(us)	PRI(us)	Detection
1	5500	12	12.5	467	No
2	5501	15	17.2	304	Yes
3	5503	15	17.8	316	Yes
4	5505	16	18.5	439	No
5	5495	13	13.1	420	Yes
6	5509	12	11.3	249	No
7	5497	16	18.8	463	Yes
8	5499	14	15.3	258	Yes
9	5506	14	15.1	212	Yes
10	5493	15	16.9	236	Yes
11	5509	12	11.2	474	Yes
12	5500	12	11.7	461	Yes
13	5498	13	14.4	437	Yes
14	5492	16	18.9	287	Yes
15	5498	16	19.9	395	Yes
16	5495	14	15.7	322	Yes
17	5507	13	13.4	468	Yes
18	5496	13	14.5	255	Yes
19	5507	13	12.9	423	Yes
20	5496	12	11.5	456	Yes
21	5491	14	15.3	351	Yes
22	5506	15	17.8	411	Yes
23	5509	13	14.3	279	No
24	5509	12	11.1	431	Yes
25	5501	15	17	324	Yes
26	5499	13	14.5	419	Yes
27	5497	12	12.1	447	No
28	5497	12	11.7	481	Yes
29	5500	12	11.6	438	No
30	5492	12	12.7	270	No
Detection Rate : 76.7%					



802.11ax (HE20)

Type 5 Radar Statistical Performances				
Trial #	Minimum Chirp Width(MHz)	Chirp Center Frequency(MHz)	Test Signal Name	Detection
1	9	5500	LP_Signal_01	Yes
2	9	5500	LP_Signal_02	No
3	5	5500	LP_Signal_03	Yes
4	5	5500	LP_Signal_04	Yes
5	8	5500	LP_Signal_05	Yes
6	5	5500	LP_Signal_06	Yes
7	8	5500	LP_Signal_07	Yes
8	6	5500	LP_Signal_08	No
9	20	5500	LP_Signal_09	Yes
10	5	5500	LP_Signal_10	Yes
11	13	5495	LP_Signal_11	Yes
12	14	5496	LP_Signal_12	Yes
13	18	5497	LP_Signal_13	No
14	9	5494	LP_Signal_14	Yes
15	6	5492	LP_Signal_15	Yes
16	8	5493	LP_Signal_16	Yes
17	6	5492	LP_Signal_17	Yes
18	5	5492	LP_Signal_18	Yes
19	8	5493	LP_Signal_19	Yes
20	14	5496	LP_Signal_20	Yes
21	7	5507	LP_Signal_21	Yes
22	16	5504	LP_Signal_22	Yes
23	12	5505	LP_Signal_23	Yes
24	20	5502	LP_Signal_24	Yes
25	6	5508	LP_Signal_25	Yes
26	18	5503	LP_Signal_26	No
27	12	5505	LP_Signal_27	Yes
28	15	5504	LP_Signal_28	Yes
29	5	5508	LP_Signal_29	Yes
30	6	5508	LP_Signal_30	Yes

Detection Rate : 86.7%

Note: The Long Pulse Radar pattern shown in Appendix A.1



802.11ax (HE20)

Type 6 Radar Statistical Performances

Trial #	Pulses per Burst	Pulse Width(us)	PRI(us)	Hopping Frequency Sequence Name	Detection
1	9	1	333.3	HOP_FREQ_SEQ_01	Yes
2	9	1	333.3	HOP_FREQ_SEQ_02	Yes
3	9	1	333.3	HOP_FREQ_SEQ_03	Yes
4	9	1	333.3	HOP_FREQ_SEQ_04	Yes
5	9	1	333.3	HOP_FREQ_SEQ_05	Yes
6	9	1	333.3	HOP_FREQ_SEQ_06	Yes
7	9	1	333.3	HOP_FREQ_SEQ_07	Yes
8	9	1	333.3	HOP_FREQ_SEQ_08	Yes
9	9	1	333.3	HOP_FREQ_SEQ_09	Yes
10	9	1	333.3	HOP_FREQ_SEQ_10	Yes
11	9	1	333.3	HOP_FREQ_SEQ_11	Yes
12	9	1	333.3	HOP_FREQ_SEQ_12	Yes
13	9	1	333.3	HOP_FREQ_SEQ_13	Yes
14	9	1	333.3	HOP_FREQ_SEQ_14	Yes
15	9	1	333.3	HOP_FREQ_SEQ_15	Yes
16	9	1	333.3	HOP_FREQ_SEQ_16	Yes
17	9	1	333.3	HOP_FREQ_SEQ_17	Yes
18	9	1	333.3	HOP_FREQ_SEQ_18	Yes
19	9	1	333.3	HOP_FREQ_SEQ_19	Yes
20	9	1	333.3	HOP_FREQ_SEQ_20	No
21	9	1	333.3	HOP_FREQ_SEQ_21	Yes
22	9	1	333.3	HOP_FREQ_SEQ_22	Yes
23	9	1	333.3	HOP_FREQ_SEQ_23	Yes
24	9	1	333.3	HOP_FREQ_SEQ_24	No
25	9	1	333.3	HOP_FREQ_SEQ_25	Yes
26	9	1	333.3	HOP_FREQ_SEQ_26	Yes
27	9	1	333.3	HOP_FREQ_SEQ_27	Yes
28	9	1	333.3	HOP_FREQ_SEQ_28	Yes
29	9	1	333.3	HOP_FREQ_SEQ_29	Yes
30	9	1	333.3	HOP_FREQ_SEQ_30	Yes

Detection Rate : 93.3%

Note: The Frequency Hopping Radar pattern shown in Appendix A.2

802.11ax (HE40)

Type 1 Radar Statistical Performances

Trial #	Test Frequency (MHz)	Pulse Repetition Frequency Number (1 to 23)	Pulse Repetition Frequency (pps)	Pulses per Burst	Pulse Repetition Interval (µsec)	Detection
1	5510	15	1253.1	67	798	Yes
2	5520	16	1222.5	65	818	Yes
3	5500	4	1730.1	92	578	No
4	5500	11	1392.8	74	718	Yes
5	5497	22	1066.1	57	938	No
6	5519	7	1567.4	83	638	Yes
7	5506	2	1858.7	99	538	Yes
8	5515	8	1519.8	81	658	Yes
9	5500	1	1930.5	102	518	Yes
10	5499	19	1139	61	878	Yes
11	5506	21	1089.3	58	918	Yes
12	5506	23	326.2	18	3066	No
13	5498	9	1474.9	78	678	Yes
14	5506	5	1672.2	89	598	Yes
15	5493	6	1618.1	86	618	Yes
16	5510	-	1111.1	59	900	Yes
17	5491	-	1023.5	55	977	Yes
18	5514	-	625.8	34	1598	Yes
19	5492	-	730.5	39	1369	Yes
20	5496	-	1180.6	63	847	Yes
21	5506	-	400.6	22	2496	No
22	5511	-	529.4	28	1889	No
23	5517	-	347.6	19	2877	Yes
24	5507	-	641.4	34	1559	Yes
25	5520	-	508.9	27	1965	Yes
26	5502	-	345.4	19	2895	Yes
27	5503	-	580.7	31	1722	Yes
28	5492	-	786.8	42	1271	Yes
29	5526	-	808.4	43	1237	Yes
30	5497	-	517.1	28	1934	Yes

Detection Rate : 83.3%

Note. " - " : 15 unique PRI values randomly selected within the range of 518-3066 µsec, with a minimum increment of 1µsec, excluding PRI values selected in Test A



802.11ax (HE40)

Type 2 Radar Statistical Performances

Trial #	Test Frequency (MHz)	Pulses per Burst	Pulse Width(us)	PRI(us)	Detection
1	5510	24	1.7	174	Yes
2	5520	27	3.8	176	Yes
3	5500	28	4	161	No
4	5502	28	4.3	226	Yes
5	5495	24	1.9	193	Yes
6	5523	23	1.1	230	Yes
7	5521	29	4.5	198	Yes
8	5491	26	2.9	227	Yes
9	5528	26	2.8	171	No
10	5514	27	3.6	221	Yes
11	5498	23	1.1	180	Yes
12	5500	23	1.3	189	No
13	5519	25	2.5	204	Yes
14	5515	29	4.5	203	No
15	5528	29	5	170	Yes
16	5530	26	3.1	201	No
17	5513	24	2.1	218	Yes
18	5516	25	2.6	208	Yes
19	5519	24	1.8	223	No
20	5518	23	1.2	220	Yes
21	5514	26	2.9	224	No
22	5518	28	4	160	Yes
23	5491	25	2.5	209	Yes
24	5512	23	1	205	Yes
25	5492	27	3.7	151	No
26	5527	25	2.5	186	No
27	5504	23	1.5	190	Yes
28	5518	23	1.3	185	No
29	5529	23	1.2	175	Yes
30	5529	24	1.7	216	Yes

Detection Rate : 66.7%

802.11ax (HE40)

Type 3 Radar Statistical Performances					
Trial #	Test Frequency (MHz)	Pulses per Burst	Pulse Width(us)	PRI(us)	Detection
1	5510	16	6.7	467	Yes
2	5520	18	8.8	304	Yes
3	5500	18	9	316	Yes
4	5527	18	9.3	439	Yes
5	5492	16	6.9	420	No
6	5514	16	6.1	249	Yes
7	5504	18	9.5	463	Yes
8	5509	17	7.9	258	Yes
9	5508	17	7.8	212	Yes
10	5526	17	8.6	236	No
11	5528	16	6.1	474	Yes
12	5508	16	6.3	461	Yes
13	5529	17	7.5	437	Yes
14	5518	18	9.5	287	Yes
15	5515	18	10	395	Yes
16	5498	17	8.1	322	Yes
17	5530	16	7.1	468	Yes
18	5516	17	7.6	255	Yes
19	5499	16	6.8	423	Yes
20	5528	16	6.2	456	Yes
21	5502	17	7.9	351	No
22	5523	18	9	411	Yes
23	5506	17	7.5	279	Yes
24	5510	16	6	431	Yes
25	5516	17	8.7	324	No
26	5529	17	7.5	419	Yes
27	5517	16	6.5	447	Yes
28	5524	16	6.3	481	Yes
29	5521	16	6.2	438	Yes
30	5491	16	6.7	270	Yes
Detection Rate : 86.7%					



802.11ax (HE40)

Type 4 Radar Statistical Performances

Trial #	Test Frequency (MHz)	Pulses per Burst	Pulse Width(us)	PRI(us)	Detection
1	5510	Pulse per burst	pulse width	PRI	Yes
2	5520	12	12.5	467	Yes
3	5500	15	17.2	304	Yes
4	5491	15	17.8	316	No
5	5519	16	18.5	439	Yes
6	5495	13	13.1	420	Yes
7	5501	12	11.3	249	Yes
8	5527	16	18.8	463	Yes
9	5499	14	15.3	258	Yes
10	5515	14	15.1	212	Yes
11	5522	15	16.9	236	No
12	5492	12	11.2	474	Yes
13	5514	12	11.7	461	Yes
14	5496	13	14.4	437	Yes
15	5507	16	18.9	287	Yes
16	5491	16	19.9	395	Yes
17	5502	14	15.7	322	Yes
18	5499	13	13.4	468	No
19	5510	13	14.5	255	Yes
20	5519	13	12.9	423	Yes
21	5505	12	11.5	456	Yes
22	5528	14	15.3	351	Yes
23	5505	15	17.8	411	Yes
24	5507	13	14.3	279	Yes
25	5517	12	11.1	431	Yes
26	5525	15	17	324	No
27	5496	13	14.5	419	Yes
28	5494	12	12.1	447	Yes
29	5522	12	11.7	481	Yes
30	5508	12	11.6	438	Yes

Detection Rate : 86.7%



802.11ax (HE40)

Type 5 Radar Statistical Performances				
Trial #	Minimum Chirp Width(MHz)	Chirp Center Frequency(MHz)	Test Signal Name	Detection
1	20	5510	LP_Signal_01	Yes
2	17	5510	LP_Signal_02	Yes
3	18	5510	LP_Signal_03	Yes
4	14	5510	LP_Signal_04	Yes
5	12	5510	LP_Signal_05	Yes
6	13	5510	LP_Signal_06	Yes
7	12	5510	LP_Signal_07	Yes
8	12	5510	LP_Signal_08	Yes
9	18	5510	LP_Signal_09	Yes
10	8	5510	LP_Signal_10	Yes
11	20	5499	LP_Signal_11	Yes
12	8	5494	LP_Signal_12	Yes
13	12	5496	LP_Signal_13	Yes
14	10	5495	LP_Signal_14	No
15	16	5497	LP_Signal_15	Yes
16	8	5494	LP_Signal_16	Yes
17	7	5494	LP_Signal_17	Yes
18	11	5495	LP_Signal_18	Yes
19	6	5493	LP_Signal_19	Yes
20	14	5497	LP_Signal_20	Yes
21	13	5524	LP_Signal_21	Yes
22	19	5521	LP_Signal_22	Yes
23	6	5527	LP_Signal_23	Yes
24	7	5526	LP_Signal_24	Yes
25	6	5527	LP_Signal_25	No
26	13	5524	LP_Signal_26	Yes
27	18	5522	LP_Signal_27	Yes
28	7	5526	LP_Signal_28	Yes
29	20	5521	LP_Signal_29	No
30	7	5526	LP_Signal_30	Yes

Detection Rate : 90%

Note: The Long Pulse Radar pattern shown in Appendix A.1

802.11ax (HE40)

Type 6 Radar Statistical Performances

Trial #	Pulses per Burst	Pulse Width(us)	PRI(us)	Hopping Frequency Sequence Name	Detection
1	9	1	333.3	HOP_FREQ_SEQ_01	Yes
2	9	1	333.3	HOP_FREQ_SEQ_02	Yes
3	9	1	333.3	HOP_FREQ_SEQ_03	Yes
4	9	1	333.3	HOP_FREQ_SEQ_04	Yes
5	9	1	333.3	HOP_FREQ_SEQ_05	Yes
6	9	1	333.3	HOP_FREQ_SEQ_06	Yes
7	9	1	333.3	HOP_FREQ_SEQ_07	Yes
8	9	1	333.3	HOP_FREQ_SEQ_08	Yes
9	9	1	333.3	HOP_FREQ_SEQ_09	Yes
10	9	1	333.3	HOP_FREQ_SEQ_10	Yes
11	9	1	333.3	HOP_FREQ_SEQ_11	Yes
12	9	1	333.3	HOP_FREQ_SEQ_12	Yes
13	9	1	333.3	HOP_FREQ_SEQ_13	Yes
14	9	1	333.3	HOP_FREQ_SEQ_14	No
15	9	1	333.3	HOP_FREQ_SEQ_15	Yes
16	9	1	333.3	HOP_FREQ_SEQ_16	Yes
17	9	1	333.3	HOP_FREQ_SEQ_17	Yes
18	9	1	333.3	HOP_FREQ_SEQ_18	Yes
19	9	1	333.3	HOP_FREQ_SEQ_19	No
20	9	1	333.3	HOP_FREQ_SEQ_20	Yes
21	9	1	333.3	HOP_FREQ_SEQ_21	No
22	9	1	333.3	HOP_FREQ_SEQ_22	Yes
23	9	1	333.3	HOP_FREQ_SEQ_23	Yes
24	9	1	333.3	HOP_FREQ_SEQ_24	Yes
25	9	1	333.3	HOP_FREQ_SEQ_25	No
26	9	1	333.3	HOP_FREQ_SEQ_26	Yes
27	9	1	333.3	HOP_FREQ_SEQ_27	Yes
28	9	1	333.3	HOP_FREQ_SEQ_28	Yes
29	9	1	333.3	HOP_FREQ_SEQ_29	Yes
30	9	1	333.3	HOP_FREQ_SEQ_30	Yes

Detection Rate : 86.7%

Note: The Frequency Hopping Radar pattern shown in Appendix A.2

802.11ax (HE80)

Type 1 Radar Statistical Performances

Trial #	Test Frequency (MHz)	Pulse Repetition Frequency Number (1 to 23)	Pulse Repetition Frequency (pps)	Pulses per Burst	Pulse Repetition Interval (µsec)	Detection
1	5530	15	1253.1	67	798	No
2	5540	16	1222.5	65	818	Yes
3	5560	4	1730.1	92	578	Yes
4	5520	11	1392.8	74	718	Yes
5	5500	22	1066.1	57	938	Yes
6	5532	7	1567.4	83	638	Yes
7	5526	2	1858.7	99	538	Yes
8	5521	8	1519.8	81	658	Yes
9	5501	1	1930.5	102	518	Yes
10	5528	19	1139	61	878	Yes
11	5503	21	1089.3	58	918	Yes
12	5506	23	326.2	18	3066	Yes
13	5494	9	1474.9	78	678	Yes
14	5494	5	1672.2	89	598	No
15	5520	6	1618.1	86	618	Yes
16	5505	-	1111.1	59	900	Yes
17	5509	-	1023.5	55	977	Yes
18	5525	-	625.8	34	1598	Yes
19	5514	-	730.5	39	1369	Yes
20	5516	-	1180.6	63	847	Yes
21	5557	-	400.6	22	2496	Yes
22	5565	-	529.4	28	1889	Yes
23	5564	-	347.6	19	2877	Yes
24	5541	-	641.4	34	1559	No
25	5525	-	508.9	27	1965	Yes
26	5560	-	345.4	19	2895	Yes
27	5563	-	580.7	31	1722	Yes
28	5533	-	786.8	42	1271	Yes
29	5504	-	808.4	43	1237	Yes
30	5509	-	517.1	28	1934	Yes

Detection Rate : 90%

Note. " - " : 15 unique PRI values randomly selected within the range of 518-3066 µsec, with a minimum increment of 1µsec, excluding PRI values selected in Test A



802.11ax (HE80)

Type 2 Radar Statistical Performances

Trial #	Test Frequency (MHz)	Pulses per Burst	Pulse Width(us)	PRI(us)	Detection
1	5530	24	1.7	174	Yes
2	5540	27	3.8	176	Yes
3	5560	28	4	161	Yes
4	5520	28	4.3	226	Yes
5	5500	24	1.9	193	Yes
6	5505	23	1.1	230	Yes
7	5561	29	4.5	198	No
8	5492	26	2.9	227	Yes
9	5531	26	2.8	171	Yes
10	5531	27	3.6	221	Yes
11	5540	23	1.1	180	Yes
12	5504	23	1.3	189	Yes
13	5555	25	2.5	204	Yes
14	5538	29	4.5	203	Yes
15	5548	29	5	170	Yes
16	5530	26	3.1	201	No
17	5504	24	2.1	218	Yes
18	5541	25	2.6	208	Yes
19	5503	24	1.8	223	Yes
20	5550	23	1.2	220	No
21	5521	26	2.9	224	Yes
22	5563	28	4	160	No
23	5568	25	2.5	209	Yes
24	5530	23	1	205	Yes
25	5534	27	3.7	151	Yes
26	5536	25	2.5	186	Yes
27	5560	23	1.5	190	Yes
28	5513	23	1.3	185	Yes
29	5541	23	1.2	175	Yes
30	5544	24	1.7	216	Yes

Detection Rate : 86.7%

802.11ax (HE80)

Type 3 Radar Statistical Performances					
Trial #	Test Frequency (MHz)	Pulses per Burst	Pulse Width(us)	PRI(us)	Detection
1	5530	16	6.7	467	Yes
2	5540	18	8.8	304	Yes
3	5560	18	9	316	No
4	5520	18	9.3	439	Yes
5	5500	16	6.9	420	Yes
6	5499	16	6.1	249	No
7	5514	18	9.5	463	Yes
8	5551	17	7.9	258	No
9	5501	17	7.8	212	No
10	5521	17	8.6	236	Yes
11	5521	16	6.1	474	Yes
12	5526	16	6.3	461	No
13	5500	17	7.5	437	Yes
14	5496	18	9.5	287	Yes
15	5498	18	10	395	Yes
16	5542	17	8.1	322	Yes
17	5503	16	7.1	468	Yes
18	5566	17	7.6	255	Yes
19	5510	16	6.8	423	Yes
20	5522	16	6.2	456	Yes
21	5563	17	7.9	351	Yes
22	5557	18	9	411	Yes
23	5527	17	7.5	279	Yes
24	5557	16	6	431	Yes
25	5514	17	8.7	324	No
26	5561	17	7.5	419	Yes
27	5541	16	6.5	447	Yes
28	5555	16	6.3	481	Yes
29	5521	16	6.2	438	Yes
30	5566	16	6.7	270	Yes
Detection Rate : 80%					



802.11ax (HE80)

Type 4 Radar Statistical Performances

Trial #	Test Frequency (MHz)	Pulses per Burst	Pulse Width(us)	PRI(us)	Detection
1	5530	12	12.5	467	Yes
2	5540	15	17.2	304	Yes
3	5560	15	17.8	316	Yes
4	5520	16	18.5	439	No
5	5500	13	13.1	420	Yes
6	5530	12	11.3	249	Yes
7	5524	16	18.8	463	Yes
8	5523	14	15.3	258	Yes
9	5558	14	15.1	212	Yes
10	5559	15	16.9	236	Yes
11	5568	12	11.2	474	No
12	5494	12	11.7	461	Yes
13	5547	13	14.4	437	Yes
14	5561	16	18.9	287	Yes
15	5528	16	19.9	395	Yes
16	5557	14	15.7	322	Yes
17	5496	13	13.4	468	Yes
18	5528	13	14.5	255	Yes
19	5547	13	12.9	423	Yes
20	5521	12	11.5	456	Yes
21	5551	14	15.3	351	No
22	5532	15	17.8	411	Yes
23	5496	13	14.3	279	Yes
24	5565	12	11.1	431	Yes
25	5520	15	17	324	Yes
26	5517	13	14.5	419	Yes
27	5548	12	12.1	447	Yes
28	5553	12	11.7	481	Yes
29	5554	12	11.6	438	No
30	5546	12	12.7	270	Yes

Detection Rate : 86.7%



802.11ax (HE80)

Type 5 Radar Statistical Performances				
Trial #	Minimum Chirp Width(MHz)	Chirp Center Frequency(MHz)	Test Signal Name	Detection
1	15	5530	LP_Signal_01	Yes
2	11	5530	LP_Signal_02	No
3	12	5530	LP_Signal_03	Yes
4	10	5530	LP_Signal_04	Yes
5	18	5530	LP_Signal_05	Yes
6	14	5530	LP_Signal_06	Yes
7	17	5530	LP_Signal_07	Yes
8	10	5530	LP_Signal_08	Yes
9	12	5530	LP_Signal_09	Yes
10	19	5530	LP_Signal_10	Yes
11	7	5494	LP_Signal_11	Yes
12	15	5497	LP_Signal_12	Yes
13	7	5494	LP_Signal_13	Yes
14	20	5499	LP_Signal_14	Yes
15	18	5498	LP_Signal_15	Yes
16	19	5499	LP_Signal_16	No
17	13	5496	LP_Signal_17	Yes
18	12	5496	LP_Signal_18	Yes
19	15	5497	LP_Signal_19	Yes
20	9	5495	LP_Signal_20	No
21	5	5567	LP_Signal_21	Yes
22	18	5562	LP_Signal_22	Yes
23	7	5566	LP_Signal_23	No
24	18	5562	LP_Signal_24	Yes
25	9	5565	LP_Signal_25	Yes
26	11	5565	LP_Signal_26	Yes
27	11	5565	LP_Signal_27	Yes
28	11	5565	LP_Signal_28	Yes
29	15	5563	LP_Signal_29	Yes
30	7	5566	LP_Signal_30	Yes

Detection Rate : 86.7%

Note: The Long Pulse Radar pattern shown in Appendix A.1

802.11ax (HE80)

Type 6 Radar Statistical Performances

Trial #	Pulses per Burst	Pulse Width(us)	PRI(us)	Hopping Frequency Sequence Name	Detection
1	9	1	333.3	HOP_FREQ_SEQ_01	Yes
2	9	1	333.3	HOP_FREQ_SEQ_02	Yes
3	9	1	333.3	HOP_FREQ_SEQ_03	No
4	9	1	333.3	HOP_FREQ_SEQ_04	Yes
5	9	1	333.3	HOP_FREQ_SEQ_05	Yes
6	9	1	333.3	HOP_FREQ_SEQ_06	Yes
7	9	1	333.3	HOP_FREQ_SEQ_07	Yes
8	9	1	333.3	HOP_FREQ_SEQ_08	No
9	9	1	333.3	HOP_FREQ_SEQ_09	Yes
10	9	1	333.3	HOP_FREQ_SEQ_10	Yes
11	9	1	333.3	HOP_FREQ_SEQ_11	Yes
12	9	1	333.3	HOP_FREQ_SEQ_12	Yes
13	9	1	333.3	HOP_FREQ_SEQ_13	Yes
14	9	1	333.3	HOP_FREQ_SEQ_14	Yes
15	9	1	333.3	HOP_FREQ_SEQ_15	Yes
16	9	1	333.3	HOP_FREQ_SEQ_16	Yes
17	9	1	333.3	HOP_FREQ_SEQ_17	No
18	9	1	333.3	HOP_FREQ_SEQ_18	Yes
19	9	1	333.3	HOP_FREQ_SEQ_19	Yes
20	9	1	333.3	HOP_FREQ_SEQ_20	Yes
21	9	1	333.3	HOP_FREQ_SEQ_21	Yes
22	9	1	333.3	HOP_FREQ_SEQ_22	Yes
23	9	1	333.3	HOP_FREQ_SEQ_23	Yes
24	9	1	333.3	HOP_FREQ_SEQ_24	Yes
25	9	1	333.3	HOP_FREQ_SEQ_25	Yes
26	9	1	333.3	HOP_FREQ_SEQ_26	Yes
27	9	1	333.3	HOP_FREQ_SEQ_27	Yes
28	9	1	333.3	HOP_FREQ_SEQ_28	Yes
29	9	1	333.3	HOP_FREQ_SEQ_29	Yes
30	9	1	333.3	HOP_FREQ_SEQ_30	Yes
Detection Rate : 90%					

Note: The Frequency Hopping Radar pattern shown in Appendix A.2

802.11ax (HE160)

Type 1 Radar Statistical Performances

Trial #	Test Frequency (MHz)	Pulse Repetition Frequency Number (1 to 23)	Pulse Repetition Frequency (pps)	Pulses per Burst	Pulse Repetition Interval (µsec)	Detection
1	5570	15	1253.1	67	798	Yes
2	5580	16	1222.5	65	818	Yes
3	5600	4	1730.1	92	578	Yes
4	5560	11	1392.8	74	718	Yes
5	5540	22	1066.1	57	938	Yes
6	5551	7	1567.4	83	638	Yes
7	5600	2	1858.7	99	538	Yes
8	5510	8	1519.8	81	658	Yes
9	5545	1	1930.5	102	518	Yes
10	5526	19	1139	61	878	No
11	5526	21	1089.3	58	918	Yes
12	5613	23	326.2	18	3066	Yes
13	5618	9	1474.9	78	678	Yes
14	5512	5	1672.2	89	598	Yes
15	5588	6	1618.1	86	618	Yes
16	5518	-	1111.1	59	900	Yes
17	5591	-	1023.5	55	977	Yes
18	5534	-	625.8	34	1598	Yes
19	5528	-	730.5	39	1369	No
20	5518	-	1180.6	63	847	No
21	5568	-	400.6	22	2496	Yes
22	5598	-	529.4	28	1889	Yes
23	5509	-	347.6	19	2877	Yes
24	5642	-	641.4	34	1559	Yes
25	5624	-	508.9	27	1965	Yes
26	5612	-	345.4	19	2895	Yes
27	5615	-	580.7	31	1722	Yes
28	5637	-	786.8	42	1271	Yes
29	5638	-	808.4	43	1237	Yes
30	5527	-	517.1	28	1934	Yes

Detection Rate : 90%

Note. " - " : 15 unique PRI values randomly selected within the range of 518-3066 µsec, with a minimum increment of 1µsec, excluding PRI values selected in Test A



802.11ax (HE160)

Type 2 Radar Statistical Performances

Trial #	Test Frequency (MHz)	Pulses per Burst	Pulse Width(us)	PRI(us)	Detection
1	5570	24	1.7	174	Yes
2	5580	27	3.8	176	No
3	5600	28	4	161	Yes
4	5560	28	4.3	226	Yes
5	5540	24	1.9	193	Yes
6	5551	23	1.1	230	Yes
7	5600	29	4.5	198	Yes
8	5510	26	2.9	227	Yes
9	5545	26	2.8	171	Yes
10	5526	27	3.6	221	Yes
11	5526	23	1.1	180	Yes
12	5613	23	1.3	189	No
13	5618	25	2.5	204	Yes
14	5512	29	4.5	203	Yes
15	5588	29	5	170	Yes
16	5518	26	3.1	201	Yes
17	5591	24	2.1	218	Yes
18	5534	25	2.6	208	Yes
19	5528	24	1.8	223	Yes
20	5518	23	1.2	220	No
21	5568	26	2.9	224	No
22	5598	28	4	160	Yes
23	5509	25	2.5	209	Yes
24	5642	23	1	205	Yes
25	5624	27	3.7	151	Yes
26	5612	25	2.5	186	Yes
27	5615	23	1.5	190	No
28	5637	23	1.3	185	Yes
29	5638	23	1.2	175	Yes
30	5527	24	1.7	216	No

Detection Rate : 80%



802.11ax (HE160)

Type 3 Radar Statistical Performances

Trial #	Test Frequency (MHz)	Pulses per Burst	Pulse Width(us)	PRI(us)	Detection
1	5570	16	6.7	467	Yes
2	5580	18	8.8	304	No
3	5600	18	9	316	Yes
4	5560	18	9.3	439	Yes
5	5540	16	6.9	420	Yes
6	5551	16	6.1	249	No
7	5600	18	9.5	463	Yes
8	5510	17	7.9	258	Yes
9	5545	17	7.8	212	Yes
10	5526	17	8.6	236	Yes
11	5526	16	6.1	474	Yes
12	5613	16	6.3	461	No
13	5618	17	7.5	437	Yes
14	5512	18	9.5	287	Yes
15	5588	18	10	395	Yes
16	5518	17	8.1	322	No
17	5591	16	7.1	468	Yes
18	5534	17	7.6	255	Yes
19	5528	16	6.8	423	Yes
20	5518	16	6.2	456	Yes
21	5568	17	7.9	351	Yes
22	5598	18	9	411	Yes
23	5509	17	7.5	279	No
24	5642	16	6	431	No
25	5624	17	8.7	324	Yes
26	5612	17	7.5	419	Yes
27	5615	16	6.5	447	No
28	5637	16	6.3	481	Yes
29	5638	16	6.2	438	Yes
30	5527	16	6.7	270	Yes

Detection Rate : 76.7%

802.11ax (HE160)

Type 4 Radar Statistical Performances					
Trial #	Test Frequency (MHz)	Pulses per Burst	Pulse Width(us)	PRI(us)	Detection
1	5570	12	12.5	467	Yes
2	5580	15	17.2	304	Yes
3	5600	15	17.8	316	No
4	5560	16	18.5	439	Yes
5	5540	13	13.1	420	No
6	5551	12	11.3	249	Yes
7	5600	16	18.8	463	No
8	5510	14	15.3	258	Yes
9	5545	14	15.1	212	Yes
10	5526	15	16.9	236	No
11	5526	12	11.2	474	Yes
12	5613	12	11.7	461	Yes
13	5618	13	14.4	437	Yes
14	5512	16	18.9	287	Yes
15	5588	16	19.9	395	Yes
16	5518	14	15.7	322	Yes
17	5591	13	13.4	468	No
18	5534	13	14.5	255	Yes
19	5528	13	12.9	423	Yes
20	5518	12	11.5	456	Yes
21	5568	14	15.3	351	Yes
22	5598	15	17.8	411	Yes
23	5509	13	14.3	279	Yes
24	5642	12	11.1	431	No
25	5624	15	17	324	Yes
26	5612	13	14.5	419	Yes
27	5615	12	12.1	447	Yes
28	5637	12	11.7	481	No
29	5638	12	11.6	438	Yes
30	5527	12	12.7	270	Yes
					Detection Rate : 76.7%

802.11ax (HE160)

Type 5 Radar Statistical Performances				
Trial #	Minimum Chirp Width(MHz)	Chirp Center Frequency(MHz)	Test Signal Name	Detection
1	7	5570	LP_Signal_01	Yes
2	15	5570	LP_Signal_02	Yes
3	16	5570	LP_Signal_03	Yes
4	18	5570	LP_Signal_04	Yes
5	8	5570	LP_Signal_05	Yes
6	5	5570	LP_Signal_06	No
7	18	5570	LP_Signal_07	Yes
8	12	5570	LP_Signal_08	No
9	12	5570	LP_Signal_09	Yes
10	15	5570	LP_Signal_10	Yes
11	5	5494	LP_Signal_11	Yes
12	6	5494	LP_Signal_12	Yes
13	11	5496	LP_Signal_13	Yes
14	18	5499	LP_Signal_14	No
15	20	5500	LP_Signal_15	No
16	13	5497	LP_Signal_16	Yes
17	9	5496	LP_Signal_17	Yes
18	11	5496	LP_Signal_18	No
19	8	5495	LP_Signal_19	Yes
20	5	5494	LP_Signal_20	Yes
21	12	5643	LP_Signal_21	Yes
22	17	5641	LP_Signal_22	Yes
23	10	5644	LP_Signal_23	Yes
24	5	5646	LP_Signal_24	Yes
25	15	5642	LP_Signal_25	Yes
26	11	5644	LP_Signal_26	Yes
27	7	5645	LP_Signal_27	Yes
28	6	5646	LP_Signal_28	No
29	6	5646	LP_Signal_29	Yes
30	8	5645	LP_Signal_30	Yes
				Detection Rate : 80%

Note: The Long Pulse Radar pattern shown in Appendix A.1

802.11ax (HE160)

Type 6 Radar Statistical Performances

Trial #	Pulses per Burst	Pulse Width(us)	PRI(us)	Hopping Frequency Sequence Name	Detection
1	9	1	333.3	HOP_FREQ_SEQ_01	Yes
2	9	1	333.3	HOP_FREQ_SEQ_02	No
3	9	1	333.3	HOP_FREQ_SEQ_03	Yes
4	9	1	333.3	HOP_FREQ_SEQ_04	Yes
5	9	1	333.3	HOP_FREQ_SEQ_05	Yes
6	9	1	333.3	HOP_FREQ_SEQ_06	Yes
7	9	1	333.3	HOP_FREQ_SEQ_07	Yes
8	9	1	333.3	HOP_FREQ_SEQ_08	Yes
9	9	1	333.3	HOP_FREQ_SEQ_09	No
10	9	1	333.3	HOP_FREQ_SEQ_10	Yes
11	9	1	333.3	HOP_FREQ_SEQ_11	Yes
12	9	1	333.3	HOP_FREQ_SEQ_12	Yes
13	9	1	333.3	HOP_FREQ_SEQ_13	Yes
14	9	1	333.3	HOP_FREQ_SEQ_14	Yes
15	9	1	333.3	HOP_FREQ_SEQ_15	No
16	9	1	333.3	HOP_FREQ_SEQ_16	Yes
17	9	1	333.3	HOP_FREQ_SEQ_17	Yes
18	9	1	333.3	HOP_FREQ_SEQ_18	Yes
19	9	1	333.3	HOP_FREQ_SEQ_19	Yes
20	9	1	333.3	HOP_FREQ_SEQ_20	Yes
21	9	1	333.3	HOP_FREQ_SEQ_21	Yes
22	9	1	333.3	HOP_FREQ_SEQ_22	Yes
23	9	1	333.3	HOP_FREQ_SEQ_23	Yes
24	9	1	333.3	HOP_FREQ_SEQ_24	Yes
25	9	1	333.3	HOP_FREQ_SEQ_25	Yes
26	9	1	333.3	HOP_FREQ_SEQ_26	Yes
27	9	1	333.3	HOP_FREQ_SEQ_27	Yes
28	9	1	333.3	HOP_FREQ_SEQ_28	Yes
29	9	1	333.3	HOP_FREQ_SEQ_29	Yes
30	9	1	333.3	HOP_FREQ_SEQ_30	Yes
Detection Rate : 90%					

Note: The Frequency Hopping Radar pattern shown in Appendix A.2

6.2.5 Non- Occupancy Period

1) Test results demonstrating an associated client link is established with the master on a test frequency.

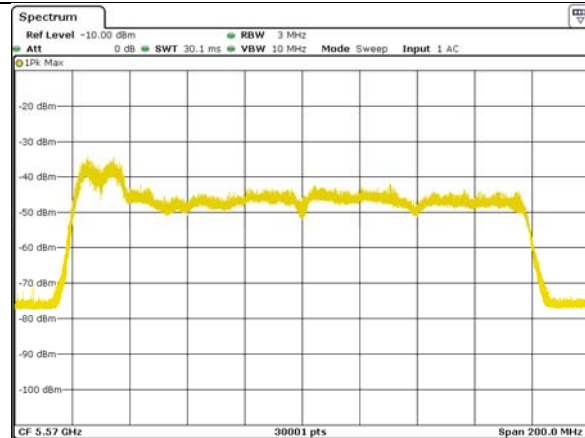

EUT (master) links with Client on 5570MHz

2) The master and DFS-certified client device are associated, and system testing will be performed with channel-loading for a non-occupancy period test.

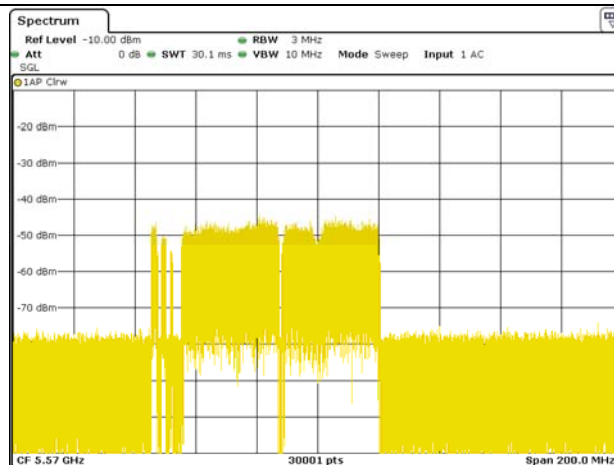

Client performed with channel-loading via master.

3). The device transmits one type of radar as specified in the DFS Order.

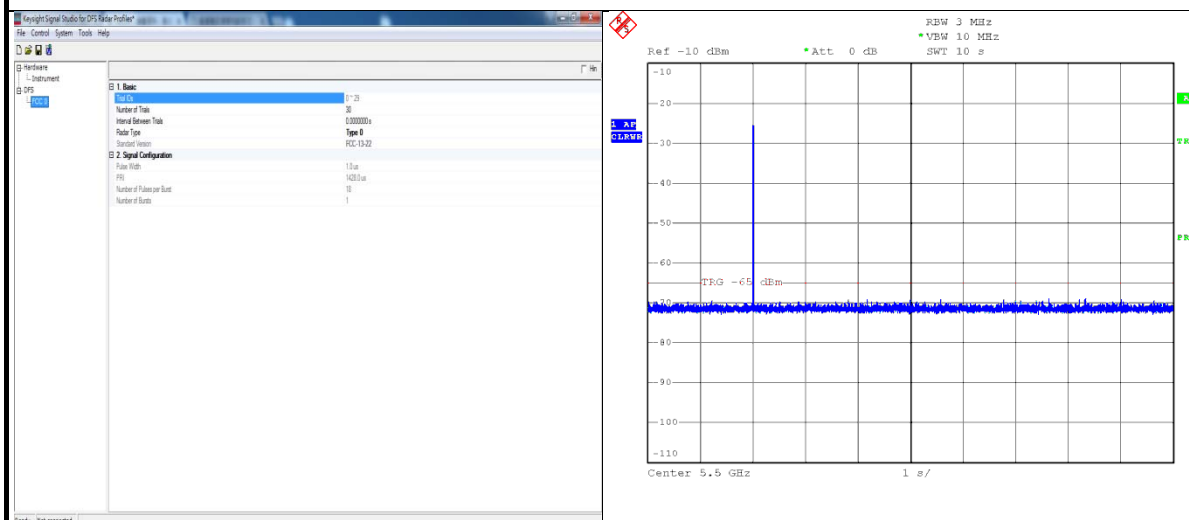

Radar 0 is used to test during DFS testing.

4) The test frequency has been monitored to ensure no transmission of any type has occurred for 30 minutes;

Note: If the client moves with the master, the device is considered compliant if nothing appears in the client non-occupancy period test. For devices that shut down (rather than moving channels), no beacons should appear;

5) An analyzer plot that contains a single 30-minute sweep on the original test frequency.

Non - Occupancy Period

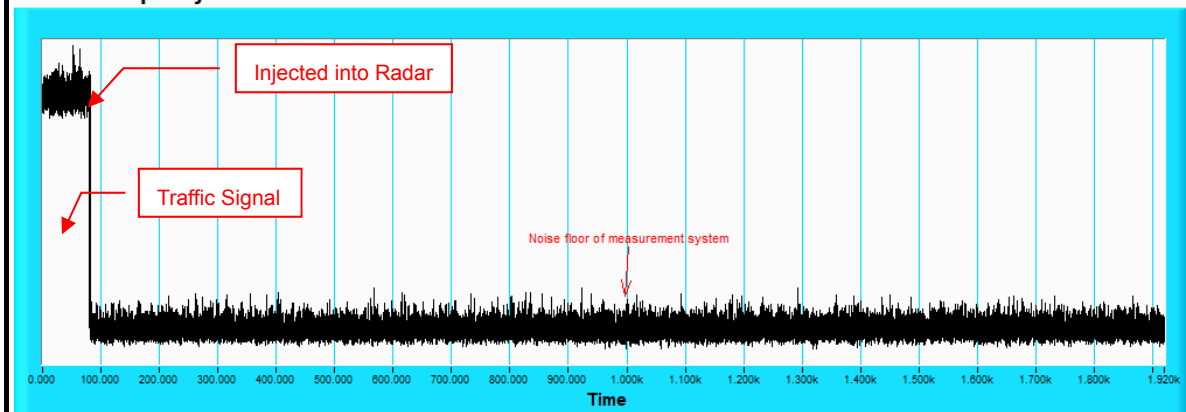

7. Information of the Testing Laboratories

We, Bureau Veritas Consumer Products Services (H.K.) Ltd., Taoyuan Branch, were founded in 1988 to provide our best service in EMC, Radio, Telecom and Safety consultation. Our laboratories are accredited and approved according to ISO/IEC 17025.

If you have any comments, please feel free to contact us at the following:

Lin Kou EMC/RF Lab:

Tel: 886-2-26052180

Fax: 886-2-26051924

Hsin Chu EMC/RF/Telecom Lab:

Tel: 886-3-6668565

Fax: 886-3-6668323

Hwa Ya EMC/RF/Safety Lab:

Tel: 886-3-3183232

Fax: 886-3-3270892

Email: service.adt@tw.bureauveritas.com

Web Site: www.bureauveritas-adt.com

The address and road map of all our labs can be found in our web site also.

3 APPENDIX-A

RADAR TEST SIGNAL

BW20

A.1 The Long Pulse Radar Pattern

Long Pulse Radar Test Signal						
Test Signal Name: LP_Signal_01						
Number of Bursts in Trial: 10						
Burst	Pulses per Burst	Chrip (MHz)	Pulse Width(us)	PRI-1 (us)	PRI-2 (us)	PRI-3 (us)
1	1	9	58.7	1765	-	-
2	3	9	84.3	1452	1398	1571
3	3	9	87.4	1358	1377	1111
4	3	9	91.4	1554	1036	1662
5	1	9	61.8	1828	-	-
6	1	9	51.8	1621	-	-
7	3	9	93.4	1063	1317	1923
8	2	9	73.8	1804	1156	-
9	2	9	72.6	1935	1079	-
10	2	9	82.5	1049	1478	-
11						
12						
13						
14						
15						
16						
17						
18						
19						
20						



Long Pulse Radar Test Signal

Test Signal Name: LP_Signal_02

Number of Bursts in Trial: 16

Burst	Pulses per Burst	Chrip (MHz)	Pulse Width(us)	PRI-1 (us)	PRI-2 (us)	PRI-3 (us)
1	1	9	51.3	1713	-	-
2	1	9	54	1485	-	-
3	2	9	69.1	1043	1750	-
4	3	9	93.8	1665	1844	1155
5	3	9	99.1	1505	1825	1538
6	2	9	76	1866	1508	-
7	1	9	63.5	1889	-	-
8	2	9	69.8	1024	1578	-
9	1	9	60.9	1067	-	-
10	1	9	52.9	1162	-	-
11	2	9	73.7	1211	1581	-
12	3	9	87.8	1516	1753	1473
13	2	9	68.6	1029	1730	-
14	1	9	50.9	1930	-	-
15	2	9	83	1675	1303	-
16	2	9	69.5	1296	1410	-
17						
18						
19						
20						

Long Pulse Radar Test Signal

Test Signal Name: LP_Signal_03

Number of Bursts in Trial: 17

Burst	Pulses per Burst	Chrip (MHz)	Pulse Width(us)	PRI-1 (us)	PRI-2 (us)	PRI-3 (us)
1	1	5	56.4	1603	-	-
2	1	5	53.9	1545	-	-
3	1	5	53.5	1943	-	-
4	1	5	59.4	1206	-	-
5	2	5	78.5	1305	1969	-
6	3	5	86.1	1355	1823	1948
7	2	5	67	1788	1958	-
8	2	5	74.5	1213	1124	-
9	2	5	81.3	1215	1366	-
10	2	5	81.5	1429	1293	-
11	2	5	79.9	1345	1990	-
12	1	5	50.5	1996	-	-
13	3	5	88.4	1871	1121	1723
14	1	5	65.7	1964	-	-
15	3	5	93	1962	1265	1267
16	1	5	63.6	1020	-	-
17	2	5	78.1	1737	1422	-
18						
19						
20						

Long Pulse Radar Test Signal

Test Signal Name: LP_Signal_04

Number of Bursts in Trial: 18

Burst	Pulses per Burst	Chrip (MHz)	Pulse Width(us)	PRI-1 (us)	PRI-2 (us)	PRI-3 (us)
1	2	5	76.8	1105	1462	-
2	2	5	72.6	1668	1188	-
3	2	5	70.4	1321	1820	-
4	1	5	57	1683	-	-
5	3	5	88.6	1721	1611	1967
6	1	5	55	1594	-	-
7	3	5	93.3	1624	1678	1625
8	3	5	86.7	1720	1540	1349
9	3	5	86.7	1816	1617	1754
10	1	5	57.7	1382	-	-
11	2	5	78.1	1561	1416	-
12	1	5	59.9	1734	-	-
13	2	5	71	1677	1220	-
14	1	5	65.7	1497	-	-
15	3	5	86.4	1957	1088	1054
16	1	5	58.3	1104	-	-
17	3	5	92.3	1589	1800	1189
18	3	5	95.4	1147	1801	1748
19						
20						

Long Pulse Radar Test Signal

Test Signal Name: LP_Signal_05

Number of Bursts in Trial: 11

Burst	Pulses per Burst	Chrip (MHz)	Pulse Width(us)	PRI-1 (us)	PRI-2 (us)	PRI-3 (us)
1	3	8	89.4	1574	1736	1023
2	2	8	70.2	1655	1500	-
3	1	8	63.2	1445	-	-
4	1	8	53.9	1098	-	-
5	1	8	65.2	1918	-	-
6	3	8	87.1	1453	1658	1236
7	3	8	94.6	1896	1154	1456
8	1	8	62.4	1646	-	-
9	2	8	67.6	1600	1439	-
10	3	8	96.2	1629	1909	1879
11	1	8	62.9	1793	-	-
12						
13						
14						
15						
16						
17						
18						
19						
20						

Long Pulse Radar Test Signal

Test Signal Name: LP_Signal_06

Number of Bursts in Trial: 8

Burst	Pulses per Burst	Chrip (MHz)	Pulse Width(us)	PRI-1 (us)	PRI-2 (us)	PRI-3 (us)
1	2	5	81.4	1413	1565	-
2	3	5	95.3	1774	1131	1995
3	1	5	60	1160	-	-
4	1	5	60.1	1922	-	-
5	1	5	59.6	1069	-	-
6	3	5	91.8	1259	1810	1477
7	2	5	78.4	1763	1487	-
8	1	5	62.6	1122	-	-
9						
10						
11						
12						
13						
14						
15						
16						
17						
18						
19						
20						



Long Pulse Radar Test Signal

Test Signal Name: LP_Signal_07

Number of Bursts in Trial: 19

Burst	Pulses per Burst	Chrip (MHz)	Pulse Width(us)	PRI-1 (us)	PRI-2 (us)	PRI-3 (us)
1	1	8	62.4	1000	-	-
2	2	8	67.9	1925	1039	-
3	3	8	99	1890	1228	1326
4	1	8	60.3	1210	-	-
5	2	8	72.7	1688	1548	-
6	3	8	91.9	1988	1503	1201
7	2	8	78.3	1309	1198	-
8	3	8	88.9	1080	1399	1115
9	1	8	64.5	1087	-	-
10	1	8	60.3	1133	-	-
11	1	8	65.8	1579	-	-
12	3	8	93.5	1619	1682	1758
13	3	8	92.2	1533	1842	1979
14	3	8	96.2	1672	1744	1971
15	2	8	70.3	1414	1692	-
16	1	8	53.5	1706	-	-
17	3	8	93.4	1870	1242	1395
18	1	8	64.9	1438	-	-
19	2	8	72.9	1239	1817	-
20						



Long Pulse Radar Test Signal

Test Signal Name: LP_Signal_08

Number of Bursts in Trial: 14

Burst	Pulses per Burst	Chrip (MHz)	Pulse Width(us)	PRI-1 (us)	PRI-2 (us)	PRI-3 (us)
1	1	6	57.3	1698	-	-
2	2	6	83.3	1700	1427	-
3	1	6	62.5	1952	-	-
4	2	6	76.1	1612	1397	-
5	3	6	87.5	1139	1901	1400
6	3	6	97.1	1352	1798	1636
7	2	6	73.8	1496	1536	-
8	1	6	55.2	1357	-	-
9	1	6	62.5	1811	-	-
10	2	6	68.1	1251	1843	-
11	3	6	99.9	1819	1057	1017
12	1	6	61.3	1342	-	-
13	2	6	73.9	1725	1872	-
14	1	6	58	1747	-	-
15						
16						
17						
18						
19						
20						

Long Pulse Radar Test Signal

Test Signal Name: LP_Signal_09

Number of Bursts in Trial: 13

Burst	Pulses per Burst	Chrip (MHz)	Pulse Width(us)	PRI-1 (us)	PRI-2 (us)	PRI-3 (us)
1	3	20	95.8	1465	1975	1904
2	2	20	79.9	1764	1174	-
3	2	20	77.4	1235	1584	-
4	3	20	90.4	1114	1974	1027
5	1	20	59.9	1126	-	-
6	3	20	90.5	1275	1985	1845
7	1	20	62	1062	-	-
8	3	20	87	1463	1587	1887
9	3	20	98.3	1586	1187	1651
10	2	20	80.1	1277	1881	-
11	1	20	52.1	1330	-	-
12	1	20	51.7	1333	-	-
13	1	20	52.7	1867	-	-
14						
15						
16						
17						
18						
19						
20						

Long Pulse Radar Test Signal

Test Signal Name: LP_Signal_10

Number of Bursts in Trial: 16

Burst	Pulses per Burst	Chrip (MHz)	Pulse Width(us)	PRI-1 (us)	PRI-2 (us)	PRI-3 (us)
1	2	5	70.7	1934	1731	-
2	3	5	85.3	1179	1751	1711
3	2	5	75	1034	1261	-
4	1	5	56.4	1954	-	-
5	2	5	66.7	1243	1090	-
6	3	5	94.8	1224	1970	1214
7	2	5	68.8	1701	1280	-
8	2	5	71	1563	1537	-
9	2	5	79.4	1525	1389	-
10	3	5	100	1717	1498	1740
11	3	5	91.9	1295	1037	1829
12	1	5	61.5	1949	-	-
13	1	5	63.2	1596	-	-
14	3	5	99	1254	1919	1073
15	3	5	86.6	1606	1849	1202
16	1	5	65.8	1635	-	-
17						
18						
19						
20						

Long Pulse Radar Test Signal

Test Signal Name: LP_Signal_11

Number of Bursts in Trial: 8

Burst	Pulses per Burst	Chrip (MHz)	Pulse Width(us)	PRI-1 (us)	PRI-2 (us)	PRI-3 (us)
1	2	13	70.7	1897	1749	-
2	1	13	64.6	1965	-	-
3	3	13	99	1012	1045	1772
4	3	13	91.9	1583	1466	1549
5	3	13	85.5	1420	1780	1459
6	3	13	96.5	1530	1924	1835
7	1	13	66.2	1550	-	-
8	3	13	92.9	1929	1335	1883
9						
10						
11						
12						
13						
14						
15						
16						
17						
18						
19						
20						

Long Pulse Radar Test Signal

Test Signal Name: LP_Signal_12

Number of Bursts in Trial: 9

Burst	Pulses per Burst	Chrip (MHz)	Pulse Width(us)	PRI-1 (us)	PRI-2 (us)	PRI-3 (us)
1	1	14	63.1	1642	-	-
2	3	14	83.5	1005	1981	1250
3	2	14	74.5	1914	1474	-
4	1	14	60.9	1430	-	-
5	2	14	70.4	1680	1542	-
6	3	14	85.1	1048	1127	1393
7	2	14	82.4	1605	1282	-
8	2	14	74	1108	1691	-
9	3	14	85.7	1486	1976	1212
10						
11						
12						
13						
14						
15						
16						
17						
18						
19						
20						

Long Pulse Radar Test Signal

Test Signal Name: LP_Signal_13

Number of Bursts in Trial: 12

Burst	Pulses per Burst	Chrip (MHz)	Pulse Width(us)	PRI-1 (us)	PRI-2 (us)	PRI-3 (us)
1	3	18	94.4	1385	1336	1376
2	1	18	53	1805	-	-
3	2	18	70	1248	1558	-
4	3	18	87.6	1403	1170	1315
5	1	18	61.7	1042	-	-
6	2	18	83.2	1100	1535	-
7	1	18	66.6	1038	-	-
8	1	18	55.1	1423	-	-
9	3	18	87	1789	1306	1643
10	1	18	66.4	1409	-	-
11	2	18	80	1319	1094	-
12	3	18	85.6	1891	1291	1529
13						
14						
15						
16						
17						
18						
19						
20						



Long Pulse Radar Test Signal

Test Signal Name: LP_Signal_14

Number of Bursts in Trial: 19

Burst	Pulses per Burst	Chrip (MHz)	Pulse Width(us)	PRI-1 (us)	PRI-2 (us)	PRI-3 (us)
1	2	9	78.9	1613	1263	-
2	3	9	96.7	1627	1432	1986
3	3	9	91.5	1472	1759	1784
4	2	9	75.4	1274	1795	-
5	2	9	71.1	1968	1444	-
6	2	9	77.5	1588	1441	-
7	1	9	65.4	1710	-	-
8	1	9	53.1	1419	-	-
9	1	9	59.9	1518	-	-
10	2	9	67.3	1195	1168	-
11	2	9	74.2	1386	1216	-
12	2	9	69	1557	1132	-
13	2	9	82.1	1987	1186	-
14	3	9	93.3	1365	1032	1728
15	2	9	83.3	1103	1568	-
16	2	9	70.3	1699	1281	-
17	1	9	57.9	1285	-	-
18	1	9	50.6	1850	-	-
19	3	9	94.3	1479	1218	1733
20						

Long Pulse Radar Test Signal

Test Signal Name: LP_Signal_15

Number of Bursts in Trial: 20

Burst	Pulses per Burst	Chrip (MHz)	Pulse Width(us)	PRI-1 (us)	PRI-2 (us)	PRI-3 (us)
1	2	6	67.5	1434	1117	-
2	2	6	67.8	1567	1773	-
3	2	6	75.9	1846	1362	-
4	2	6	68.9	1237	1818	-
5	3	6	96	1339	1796	1852
6	1	6	66.6	1289	-	-
7	2	6	78.3	1862	1856	-
8	1	6	58.9	1412	-	-
9	2	6	81.5	1113	1591	-
10	2	6	82.4	1059	1861	-
11	3	6	86.8	1797	1163	1320
12	3	6	98.5	1268	1300	1868
13	2	6	80.1	1086	1482	-
14	3	6	86.3	1860	1407	1998
15	1	6	57.2	1241	-	-
16	3	6	84.3	1808	1873	1628
17	3	6	86.8	1258	1302	1978
18	2	6	83	1690	1378	-
19	3	6	85.6	1327	1956	1311
20	3	6	99.4	1112	1815	1262

Long Pulse Radar Test Signal

Test Signal Name: LP_Signal_16

Number of Bursts in Trial: 14

Burst	Pulses per Burst	Chrip (MHz)	Pulse Width(us)	PRI-1 (us)	PRI-2 (us)	PRI-3 (us)
1	1	8	57.5	1379	-	-
2	2	8	67	1551	1620	-
3	2	8	70.9	1939	1083	-
4	2	8	75.7	1332	1476	-
5	2	8	77.1	1840	1010	-
6	2	8	78.8	1371	1618	-
7	1	8	51	1494	-	-
8	1	8	55.4	1794	-	-
9	2	8	68.5	1590	1266	-
10	3	8	100	1484	1314	1428
11	3	8	96.4	1363	1361	1292
12	3	8	97.2	1694	1480	1446
13	3	8	86.4	1447	1227	1102
14	2	8	72.1	1184	1638	-
15						
16						
17						
18						
19						
20						

Long Pulse Radar Test Signal

Test Signal Name: LP_Signal_17

Number of Bursts in Trial: 11

Burst	Pulses per Burst	Chrip (MHz)	Pulse Width(us)	PRI-1 (us)	PRI-2 (us)	PRI-3 (us)
1	1	6	62.4	1329	-	-
2	2	6	67.8	1364	1937	-
3	1	6	53	1790	-	-
4	2	6	77.8	1546	1906	-
5	3	6	95.6	1145	1743	1499
6	1	6	58.8	1199	-	-
7	3	6	92.8	1424	1408	1381
8	2	6	68.5	1340	1972	-
9	3	6	84	1607	1663	1270
10	2	6	70.8	1468	1760	-
11	2	6	73.1	1869	1515	-
12						
13						
14						
15						
16						
17						
18						
19						
20						



Long Pulse Radar Test Signal

Test Signal Name: LP_Signal_18

Number of Bursts in Trial: 13

Burst	Pulses per Burst	Chrip (MHz)	Pulse Width(us)	PRI-1 (us)	PRI-2 (us)	PRI-3 (us)
1	2	5	68.8	1504	1973	-
2	3	5	94.2	1920	1299	1467
3	2	5	82.7	1003	1351	-
4	2	5	74.8	1597	1457	-
5	1	5	58.9	1874	-	-
6	3	5	96.5	1838	1708	1328
7	3	5	87.3	1405	1271	1687
8	2	5	72.4	1200	1433	-
9	1	5	51.3	1475	-	-
10	3	5	86.8	1159	1652	1942
11	1	5	50.4	1056	-	-
12	3	5	97	1884	1876	1415
13	1	5	50.1	1519	-	-
14						
15						
16						
17						
18						
19						
20						

Long Pulse Radar Test Signal

Test Signal Name: LP_Signal_19

Number of Bursts in Trial: 10

Burst	Pulses per Burst	Chrip (MHz)	Pulse Width(us)	PRI-1 (us)	PRI-2 (us)	PRI-3 (us)
1	3	8	91.9	1301	1337	1645
2	2	8	67.2	1983	1040	-
3	1	8	65.5	1671	-	-
4	2	8	72.8	1489	1016	-
5	3	8	90.5	1552	1180	1064
6	2	8	81.6	1807	1853	-
7	3	8	86	1312	1905	1278
8	3	8	89.6	1152	1068	1832
9	1	8	62.1	1119	-	-
10	1	8	58	1234	-	-
11						
12						
13						
14						
15						
16						
17						
18						
19						
20						

Long Pulse Radar Test Signal

Test Signal Name: LP_Signal_20

Number of Bursts in Trial: 8

Burst	Pulses per Burst	Chrip (MHz)	Pulse Width(us)	PRI-1 (us)	PRI-2 (us)	PRI-3 (us)
1	2	14	73.8	1071	1915	-
2	3	14	89.5	1294	1450	1025
3	2	14	81.2	1144	1146	-
4	1	14	59	1041	-	-
5	3	14	87.5	1096	1941	1018
6	2	14	76.7	1667	1947	-
7	1	14	56.5	1573	-	-
8	3	14	89	1033	1391	1304
9						
10						
11						
12						
13						
14						
15						
16						
17						
18						
19						
20						



Long Pulse Radar Test Signal

Test Signal Name: LP_Signal_21

Number of Bursts in Trial: 14

Burst	Pulses per Burst	Chrip (MHz)	Pulse Width(us)	PRI-1 (us)	PRI-2 (us)	PRI-3 (us)
1	2	7	83.1	1762	1058	-
2	1	7	50	1739	-	-
3	1	7	52.6	1055	-	-
4	1	7	58.2	1704	-	-
5	3	7	84.6	1226	1177	1886
6	2	7	68.3	1269	1851	-
7	2	7	80.6	1814	1074	-
8	1	7	59.5	1009	-	-
9	1	7	53.4	1417	-	-
10	1	7	59.1	1431	-	-
11	2	7	74.8	1002	1394	-
12	3	7	85	1670	1755	1158
13	3	7	85.3	1307	1560	1078
14	1	7	61.9	1197	-	-
15						
16						
17						
18						
19						
20						

Long Pulse Radar Test Signal

Test Signal Name: LP_Signal_22

Number of Bursts in Trial: 17

Burst	Pulses per Burst	Chrip (MHz)	Pulse Width(us)	PRI-1 (us)	PRI-2 (us)	PRI-3 (us)
1	2	16	70.8	1022	1015	-
2	1	16	52.9	1483	-	-
3	3	16	86	1524	1308	1287
4	2	16	78.4	1821	1406	-
5	3	16	93.3	1991	1966	1290
6	2	16	70	1858	1471	-
7	2	16	78.1	1507	1705	-
8	1	16	52.4	1060	-	-
9	3	16	84.8	1859	1839	1993
10	3	16	83.5	1150	1492	1443
11	1	16	56.7	1208	-	-
12	3	16	86.2	1674	1125	1053
13	1	16	58.8	1436	-	-
14	3	16	85.4	1686	1509	1577
15	2	16	77.7	1297	1298	-
16	3	16	87.4	1649	1894	1075
17	3	16	99.8	1185	1167	1616
18						
19						
20						



Long Pulse Radar Test Signal

Test Signal Name: LP_Signal_23

Number of Bursts in Trial: 12

Burst	Pulses per Burst	Chrip (MHz)	Pulse Width(us)	PRI-1 (us)	PRI-2 (us)	PRI-3 (us)
1	3	12	95.7	1353	1813	1028
2	3	12	94.9	1735	1994	1084
3	3	12	97.9	1354	1792	1418
4	2	12	67.4	1348	1008	-
5	3	12	96.9	1916	1425	1283
6	3	12	97.6	1384	1050	1569
7	3	12	83.6	1231	1219	1194
8	2	12	82.6	1128	1346	-
9	3	12	97.2	1142	1769	1173
10	3	12	92.3	1181	1164	1458
11	2	12	80.9	1222	1756	-
12	2	12	78.1	1190	1999	-
13						
14						
15						
16						
17						
18						
19						
20						



Long Pulse Radar Test Signal

Test Signal Name: LP_Signal_24

Number of Bursts in Trial: 8

Burst	Pulses per Burst	Chrip (MHz)	Pulse Width(us)	PRI-1 (us)	PRI-2 (us)	PRI-3 (us)
1	2	20	76.9	1564	1767	-
2	1	20	64.7	1437	-	-
3	2	20	77.1	1046	1944	-
4	2	20	72.7	1440	1374	-
5	1	20	61.9	1035	-	-
6	2	20	68.6	1205	1892	-
7	2	20	78.3	1047	1273	-
8	2	20	73.1	1426	1863	-
9						
10						
11						
12						
13						
14						
15						
16						
17						
18						
19						
20						



Long Pulse Radar Test Signal

Test Signal Name: LP_Signal_25

Number of Bursts in Trial: 16

Burst	Pulses per Burst	Chrip (MHz)	Pulse Width(us)	PRI-1 (us)	PRI-2 (us)	PRI-3 (us)
1	1	6	59.1	1718	-	-
2	3	6	83.5	1070	1129	1318
3	3	6	86.5	1176	1253	1442
4	1	6	60.8	1209	-	-
5	2	6	80.7	2000	1360	-
6	1	6	65.2	1101	-	-
7	2	6	69.1	1511	1030	-
8	1	6	51.5	1161	-	-
9	3	6	98.5	1061	1951	1812
10	1	6	59.5	1325	-	-
11	3	6	95.3	1284	1650	1169
12	2	6	81.8	1460	1077	-
13	1	6	66	1149	-	-
14	1	6	59.3	1373	-	-
15	2	6	79.2	1836	1534	-
16	3	6	90.2	1455	1738	1490
17						
18						
19						
20						

Long Pulse Radar Test Signal

Test Signal Name: LP_Signal_26

Number of Bursts in Trial: 13

Burst	Pulses per Burst	Chrip (MHz)	Pulse Width(us)	PRI-1 (us)	PRI-2 (us)	PRI-3 (us)
1	3	18	87.5	1343	1331	1313
2	3	18	94.6	1448	1543	1803
3	2	18	73.9	1722	1514	-
4	1	18	55.4	1506	-	-
5	1	18	52.3	1960	-	-
6	3	18	95.8	1240	1380	1252
7	3	18	96.1	1372	1411	1908
8	2	18	77.8	1885	1593	-
9	3	18	97.2	1021	1614	1633
10	2	18	74.3	1582	1097	-
11	1	18	57.9	1031	-	-
12	2	18	68.8	1927	1936	-
13	2	18	79.6	1857	1470	-
14						
15						
16						
17						
18						
19						
20						

Long Pulse Radar Test Signal

Test Signal Name: LP_Signal_27

Number of Bursts in Trial: 9

Burst	Pulses per Burst	Chrip (MHz)	Pulse Width(us)	PRI-1 (us)	PRI-2 (us)	PRI-3 (us)
1	1	12	63.4	1595	-	-
2	3	12	97	1451	1660	1562
3	2	12	66.7	1116	1544	-
4	3	12	99.5	1553	1526	1768
5	1	12	64.3	1107	-	-
6	3	12	90.7	1992	1626	1899
7	1	12	62.1	1630	-	-
8	1	12	58.3	1676	-	-
9	3	12	87	1726	1696	1464
10						
11						
12						
13						
14						
15						
16						
17						
18						
19						
20						

Long Pulse Radar Test Signal

Test Signal Name: LP_Signal_28

Number of Bursts in Trial: 9

Burst	Pulses per Burst	Chrip (MHz)	Pulse Width(us)	PRI-1 (us)	PRI-2 (us)	PRI-3 (us)
1	3	15	86.8	1673	1383	1653
2	2	15	81.7	1841	1911	-
3	2	15	78.4	1900	1229	-
4	2	15	82.1	1527	1072	-
5	3	15	84.1	1893	1742	1491
6	3	15	87.7	1247	1341	1955
7	3	15	97	1559	1685	1572
8	3	15	99.1	1641	1727	1848
9	1	15	62	1245	-	-
10						
11						
12						
13						
14						
15						
16						
17						
18						
19						
20						

Long Pulse Radar Test Signal

Test Signal Name: LP_Signal_29

Number of Bursts in Trial: 8

Burst	Pulses per Burst	Chrip (MHz)	Pulse Width(us)	PRI-1 (us)	PRI-2 (us)	PRI-3 (us)
1	2	5	67.5	1193	1182	-
2	3	5	85.6	1221	1741	1338
3	3	5	86.9	1580	1775	1809
4	3	5	85.3	1082	1854	1095
5	2	5	67.3	1898	1977	-
6	3	5	94.8	1791	1350	1230
7	2	5	72.9	1681	1323	-
8	2	5	70.7	1709	1123	-
9						
10						
11						
12						
13						
14						
15						
16						
17						
18						
19						

Long Pulse Radar Test Signal

Test Signal Name: LP_Signal_30

Number of Bursts in Trial: 10

Burst	Pulses per Burst	Chrip (MHz)	Pulse Width(us)	PRI-1 (us)	PRI-2 (us)	PRI-3 (us)
1	1	6	63.3	1044	-	-
2	3	6	87.4	1945	1602	1203
3	1	6	58.7	1556	-	-
4	1	6	63.6	1598	-	-
5	1	6	56.3	1110	-	-
6	1	6	57.2	1878	-	-
7	1	6	50.3	1659	-	-
8	2	6	71.9	1143	1724	-
9	3	6	85.1	1404	1715	1449
10	1	6	62.5	1276	-	-
11						
12						
13						
14						
15						
16						
17						
18						
19						
20						

BW40

A.1 The Long Pulse Radar Pattern

Long Pulse Radar Test Signal						
Test Signal Name: LP_Signal_01						
Number of Bursts in Trial: 10						
Burst	Pulses per Burst	Chrip (MHz)	Pulse Width(us)	PRI-1 (us)	PRI-2 (us)	PRI-3 (us)
1	1	20	58.7	1765	-	-
2	3	20	84.3	1452	1398	1571
3	3	20	87.4	1358	1377	1111
4	3	20	91.4	1554	1036	1662
5	1	20	61.8	1828	-	-
6	1	20	51.8	1621	-	-
7	3	20	93.4	1063	1317	1923
8	2	20	73.8	1804	1156	-
9	2	20	72.6	1935	1079	-
10	2	20	82.5	1049	1478	-
11						
12						
13						
14						
15						
16						
17						
18						
19						
20						



Long Pulse Radar Test Signal

Test Signal Name: LP_Signal_02

Number of Bursts in Trial: 16

Burst	Pulses per Burst	Chrip (MHz)	Pulse Width(us)	PRI-1 (us)	PRI-2 (us)	PRI-3 (us)
1	1	17	51.3	1713	-	-
2	1	17	54	1485	-	-
3	2	17	69.1	1043	1750	-
4	3	17	93.8	1665	1844	1155
5	3	17	99.1	1505	1825	1538
6	2	17	76	1866	1508	-
7	1	17	63.5	1889	-	-
8	2	17	69.8	1024	1578	-
9	1	17	60.9	1067	-	-
10	1	17	52.9	1162	-	-
11	2	17	73.7	1211	1581	-
12	3	17	87.8	1516	1753	1473
13	2	17	68.6	1029	1730	-
14	1	17	50.9	1930	-	-
15	2	17	83	1675	1303	-
16	2	17	69.5	1296	1410	-
17						
18						
19						
20						



Long Pulse Radar Test Signal

Test Signal Name: LP_Signal_03

Number of Bursts in Trial: 17

Burst	Pulses per Burst	Chrip (MHz)	Pulse Width(us)	PRI-1 (us)	PRI-2 (us)	PRI-3 (us)
1	1	18	56.4	1603	-	-
2	1	18	53.9	1545	-	-
3	1	18	53.5	1943	-	-
4	1	18	59.4	1206	-	-
5	2	18	78.5	1305	1969	-
6	3	18	86.1	1355	1823	1948
7	2	18	67	1788	1958	-
8	2	18	74.5	1213	1124	-
9	2	18	81.3	1215	1366	-
10	2	18	81.5	1429	1293	-
11	2	18	79.9	1345	1990	-
12	1	18	50.5	1996	-	-
13	3	18	88.4	1871	1121	1723
14	1	18	65.7	1964	-	-
15	3	18	93	1962	1265	1267
16	1	18	63.6	1020	-	-
17	2	18	78.1	1737	1422	-
18						
19						
20						

Long Pulse Radar Test Signal

Test Signal Name: LP_Signal_04

Number of Bursts in Trial: 18

Burst	Pulses per Burst	Chrip (MHz)	Pulse Width(us)	PRI-1 (us)	PRI-2 (us)	PRI-3 (us)
1	2	14	76.8	1105	1462	-
2	2	14	72.6	1668	1188	-
3	2	14	70.4	1321	1820	-
4	1	14	57	1683	-	-
5	3	14	88.6	1721	1611	1967
6	1	14	55	1594	-	-
7	3	14	93.3	1624	1678	1625
8	3	14	86.7	1720	1540	1349
9	3	14	86.7	1816	1617	1754
10	1	14	57.7	1382	-	-
11	2	14	78.1	1561	1416	-
12	1	14	59.9	1734	-	-
13	2	14	71	1677	1220	-
14	1	14	65.7	1497	-	-
15	3	14	86.4	1957	1088	1054
16	1	14	58.3	1104	-	-
17	3	14	92.3	1589	1800	1189
18	3	14	95.4	1147	1801	1748
19						
20						

Long Pulse Radar Test Signal

Test Signal Name: LP_Signal_05

Number of Bursts in Trial: 11

Burst	Pulses per Burst	Chrip (MHz)	Pulse Width(us)	PRI-1 (us)	PRI-2 (us)	PRI-3 (us)
1	3	12	89.4	1574	1736	1023
2	2	12	70.2	1655	1500	-
3	1	12	63.2	1445	-	-
4	1	12	53.9	1098	-	-
5	1	12	65.2	1918	-	-
6	3	12	87.1	1453	1658	1236
7	3	12	94.6	1896	1154	1456
8	1	12	62.4	1646	-	-
9	2	12	67.6	1600	1439	-
10	3	12	96.2	1629	1909	1879
11	1	12	62.9	1793	-	-
12						
13						
14						
15						
16						
17						
18						
19						
20						

Long Pulse Radar Test Signal

Test Signal Name: LP_Signal_06

Number of Bursts in Trial: 8

Burst	Pulses per Burst	Chrip (MHz)	Pulse Width(us)	PRI-1 (us)	PRI-2 (us)	PRI-3 (us)
1	2	13	81.4	1413	1565	-
2	3	13	95.3	1774	1131	1995
3	1	13	60	1160	-	-
4	1	13	60.1	1922	-	-
5	1	13	59.6	1069	-	-
6	3	13	91.8	1259	1810	1477
7	2	13	78.4	1763	1487	-
8	1	13	62.6	1122	-	-
9						
10						
11						
12						
13						
14						
15						
16						
17						
18						
19						
20						



Long Pulse Radar Test Signal

Test Signal Name: LP_Signal_07

Number of Bursts in Trial: 19

Burst	Pulses per Burst	Chrip (MHz)	Pulse Width(us)	PRI-1 (us)	PRI-2 (us)	PRI-3 (us)
1	1	12	62.4	1000	-	-
2	2	12	67.9	1925	1039	-
3	3	12	99	1890	1228	1326
4	1	12	60.3	1210	-	-
5	2	12	72.7	1688	1548	-
6	3	12	91.9	1988	1503	1201
7	2	12	78.3	1309	1198	-
8	3	12	88.9	1080	1399	1115
9	1	12	64.5	1087	-	-
10	1	12	60.3	1133	-	-
11	1	12	65.8	1579	-	-
12	3	12	93.5	1619	1682	1758
13	3	12	92.2	1533	1842	1979
14	3	12	96.2	1672	1744	1971
15	2	12	70.3	1414	1692	-
16	1	12	53.5	1706	-	-
17	3	12	93.4	1870	1242	1395
18	1	12	64.9	1438	-	-
19	2	12	72.9	1239	1817	-
20						



Long Pulse Radar Test Signal

Test Signal Name: LP_Signal_08

Number of Bursts in Trial: 14

Burst	Pulses per Burst	Chrip (MHz)	Pulse Width(us)	PRI-1 (us)	PRI-2 (us)	PRI-3 (us)
1	1	12	57.3	1698	-	-
2	2	12	83.3	1700	1427	-
3	1	12	62.5	1952	-	-
4	2	12	76.1	1612	1397	-
5	3	12	87.5	1139	1901	1400
6	3	12	97.1	1352	1798	1636
7	2	12	73.8	1496	1536	-
8	1	12	55.2	1357	-	-
9	1	12	62.5	1811	-	-
10	2	12	68.1	1251	1843	-
11	3	12	99.9	1819	1057	1017
12	1	12	61.3	1342	-	-
13	2	12	73.9	1725	1872	-
14	1	12	58	1747	-	-
15						
16						
17						
18						
19						
20						

Long Pulse Radar Test Signal

Test Signal Name: LP_Signal_09

Number of Bursts in Trial: 13

Burst	Pulses per Burst	Chrip (MHz)	Pulse Width(us)	PRI-1 (us)	PRI-2 (us)	PRI-3 (us)
1	3	18	95.8	1465	1975	1904
2	2	18	79.9	1764	1174	-
3	2	18	77.4	1235	1584	-
4	3	18	90.4	1114	1974	1027
5	1	18	59.9	1126	-	-
6	3	18	90.5	1275	1985	1845
7	1	18	62	1062	-	-
8	3	18	87	1463	1587	1887
9	3	18	98.3	1586	1187	1651
10	2	18	80.1	1277	1881	-
11	1	18	52.1	1330	-	-
12	1	18	51.7	1333	-	-
13	1	18	52.7	1867	-	-
14						
15						
16						
17						
18						
19						
20						

Long Pulse Radar Test Signal

Test Signal Name: LP_Signal_10

Number of Bursts in Trial: 16

Burst	Pulses per Burst	Chrip (MHz)	Pulse Width(us)	PRI-1 (us)	PRI-2 (us)	PRI-3 (us)
1	2	8	70.7	1934	1731	-
2	3	8	85.3	1179	1751	1711
3	2	8	75	1034	1261	-
4	1	8	56.4	1954	-	-
5	2	8	66.7	1243	1090	-
6	3	8	94.8	1224	1970	1214
7	2	8	68.8	1701	1280	-
8	2	8	71	1563	1537	-
9	2	8	79.4	1525	1389	-
10	3	8	100	1717	1498	1740
11	3	8	91.9	1295	1037	1829
12	1	8	61.5	1949	-	-
13	1	8	63.2	1596	-	-
14	3	8	99	1254	1919	1073
15	3	8	86.6	1606	1849	1202
16	1	8	65.8	1635	-	-
17						
18						
19						
20						

Long Pulse Radar Test Signal

Test Signal Name: LP_Signal_11

Number of Bursts in Trial: 8

Burst	Pulses per Burst	Chrip (MHz)	Pulse Width(us)	PRI-1 (us)	PRI-2 (us)	PRI-3 (us)
1	2	20	70.7	1897	1749	-
2	1	20	64.6	1965	-	-
3	3	20	99	1012	1045	1772
4	3	20	91.9	1583	1466	1549
5	3	20	85.5	1420	1780	1459
6	3	20	96.5	1530	1924	1835
7	1	20	66.2	1550	-	-
8	3	20	92.9	1929	1335	1883
9						
10						
11						
12						
13						
14						
15						
16						
17						
18						
19						
20						



Long Pulse Radar Test Signal

Test Signal Name: LP_Signal_12

Number of Bursts in Trial: 9

Burst	Pulses per Burst	Chrip (MHz)	Pulse Width(us)	PRI-1 (us)	PRI-2 (us)	PRI-3 (us)
1	1	8	63.1	1642	-	-
2	3	8	83.5	1005	1981	1250
3	2	8	74.5	1914	1474	-
4	1	8	60.9	1430	-	-
5	2	8	70.4	1680	1542	-
6	3	8	85.1	1048	1127	1393
7	2	8	82.4	1605	1282	-
8	2	8	74	1108	1691	-
9	3	8	85.7	1486	1976	1212
10						
11						
12						
13						
14						
15						
16						
17						
18						
19						
20						



Long Pulse Radar Test Signal

Test Signal Name: LP_Signal_13

Number of Bursts in Trial: 12

Burst	Pulses per Burst	Chrip (MHz)	Pulse Width(us)	PRI-1 (us)	PRI-2 (us)	PRI-3 (us)
1	3	12	94.4	1385	1336	1376
2	1	12	53	1805	-	-
3	2	12	70	1248	1558	-
4	3	12	87.6	1403	1170	1315
5	1	12	61.7	1042	-	-
6	2	12	83.2	1100	1535	-
7	1	12	66.6	1038	-	-
8	1	12	55.1	1423	-	-
9	3	12	87	1789	1306	1643
10	1	12	66.4	1409	-	-
11	2	12	80	1319	1094	-
12	3	12	85.6	1891	1291	1529
13						
14						
15						
16						
17						
18						
19						
20						



Long Pulse Radar Test Signal

Test Signal Name: LP_Signal_14

Number of Bursts in Trial: 19

Burst	Pulses per Burst	Chrip (MHz)	Pulse Width(us)	PRI-1 (us)	PRI-2 (us)	PRI-3 (us)
1	2	10	78.9	1613	1263	-
2	3	10	96.7	1627	1432	1986
3	3	10	91.5	1472	1759	1784
4	2	10	75.4	1274	1795	-
5	2	10	71.1	1968	1444	-
6	2	10	77.5	1588	1441	-
7	1	10	65.4	1710	-	-
8	1	10	53.1	1419	-	-
9	1	10	59.9	1518	-	-
10	2	10	67.3	1195	1168	-
11	2	10	74.2	1386	1216	-
12	2	10	69	1557	1132	-
13	2	10	82.1	1987	1186	-
14	3	10	93.3	1365	1032	1728
15	2	10	83.3	1103	1568	-
16	2	10	70.3	1699	1281	-
17	1	10	57.9	1285	-	-
18	1	10	50.6	1850	-	-
19	3	10	94.3	1479	1218	1733
20						



Long Pulse Radar Test Signal

Test Signal Name: LP_Signal_15

Number of Bursts in Trial: 20

Burst	Pulses per Burst	Chrip (MHz)	Pulse Width(us)	PRI-1 (us)	PRI-2 (us)	PRI-3 (us)
1	2	16	67.5	1434	1117	-
2	2	16	67.8	1567	1773	-
3	2	16	75.9	1846	1362	-
4	2	16	68.9	1237	1818	-
5	3	16	96	1339	1796	1852
6	1	16	66.6	1289	-	-
7	2	16	78.3	1862	1856	-
8	1	16	58.9	1412	-	-
9	2	16	81.5	1113	1591	-
10	2	16	82.4	1059	1861	-
11	3	16	86.8	1797	1163	1320
12	3	16	98.5	1268	1300	1868
13	2	16	80.1	1086	1482	-
14	3	16	86.3	1860	1407	1998
15	1	16	57.2	1241	-	-
16	3	16	84.3	1808	1873	1628
17	3	16	86.8	1258	1302	1978
18	2	16	83	1690	1378	-
19	3	16	85.6	1327	1956	1311
20	3	16	99.4	1112	1815	1262

Long Pulse Radar Test Signal

Test Signal Name: LP_Signal_16

Number of Bursts in Trial: 14

Burst	Pulses per Burst	Chrip (MHz)	Pulse Width(us)	PRI-1 (us)	PRI-2 (us)	PRI-3 (us)
1	1	8	57.5	1379	-	-
2	2	8	67	1551	1620	-
3	2	8	70.9	1939	1083	-
4	2	8	75.7	1332	1476	-
5	2	8	77.1	1840	1010	-
6	2	8	78.8	1371	1618	-
7	1	8	51	1494	-	-
8	1	8	55.4	1794	-	-
9	2	8	68.5	1590	1266	-
10	3	8	100	1484	1314	1428
11	3	8	96.4	1363	1361	1292
12	3	8	97.2	1694	1480	1446
13	3	8	86.4	1447	1227	1102
14	2	8	72.1	1184	1638	-
15						
16						
17						
18						
19						
20						

Long Pulse Radar Test Signal

Test Signal Name: LP_Signal_17

Number of Bursts in Trial: 11

Burst	Pulses per Burst	Chrip (MHz)	Pulse Width(us)	PRI-1 (us)	PRI-2 (us)	PRI-3 (us)
1	1	7	62.4	1329	-	-
2	2	7	67.8	1364	1937	-
3	1	7	53	1790	-	-
4	2	7	77.8	1546	1906	-
5	3	7	95.6	1145	1743	1499
6	1	7	58.8	1199	-	-
7	3	7	92.8	1424	1408	1381
8	2	7	68.5	1340	1972	-
9	3	7	84	1607	1663	1270
10	2	7	70.8	1468	1760	-
11	2	7	73.1	1869	1515	-
12						
13						
14						
15						
16						
17						
18						
19						
20						

Long Pulse Radar Test Signal

Test Signal Name: LP_Signal_18

Number of Bursts in Trial: 13

Burst	Pulses per Burst	Chrip (MHz)	Pulse Width(us)	PRI-1 (us)	PRI-2 (us)	PRI-3 (us)
1	2	11	68.8	1504	1973	-
2	3	11	94.2	1920	1299	1467
3	2	11	82.7	1003	1351	-
4	2	11	74.8	1597	1457	-
5	1	11	58.9	1874	-	-
6	3	11	96.5	1838	1708	1328
7	3	11	87.3	1405	1271	1687
8	2	11	72.4	1200	1433	-
9	1	11	51.3	1475	-	-
10	3	11	86.8	1159	1652	1942
11	1	11	50.4	1056	-	-
12	3	11	97	1884	1876	1415
13	1	11	50.1	1519	-	-
14						
15						
16						
17						
18						
19						
20						

Long Pulse Radar Test Signal

Test Signal Name: LP_Signal_19

Number of Bursts in Trial: 10

Burst	Pulses per Burst	Chrip (MHz)	Pulse Width(us)	PRI-1 (us)	PRI-2 (us)	PRI-3 (us)
1	3	6	91.9	1301	1337	1645
2	2	6	67.2	1983	1040	-
3	1	6	65.5	1671	-	-
4	2	6	72.8	1489	1016	-
5	3	6	90.5	1552	1180	1064
6	2	6	81.6	1807	1853	-
7	3	6	86	1312	1905	1278
8	3	6	89.6	1152	1068	1832
9	1	6	62.1	1119	-	-
10	1	6	58	1234	-	-
11						
12						
13						
14						
15						
16						
17						
18						
19						
20						

Long Pulse Radar Test Signal

Test Signal Name: LP_Signal_20

Number of Bursts in Trial: 8

Burst	Pulses per Burst	Chrip (MHz)	Pulse Width(us)	PRI-1 (us)	PRI-2 (us)	PRI-3 (us)
1	2	14	73.8	1071	1915	-
2	3	14	89.5	1294	1450	1025
3	2	14	81.2	1144	1146	-
4	1	14	59	1041	-	-
5	3	14	87.5	1096	1941	1018
6	2	14	76.7	1667	1947	-
7	1	14	56.5	1573	-	-
8	3	14	89	1033	1391	1304
9						
10						
11						
12						
13						
14						
15						
16						
17						
18						
19						
20						



Long Pulse Radar Test Signal

Test Signal Name: LP_Signal_21

Number of Bursts in Trial: 14

Burst	Pulses per Burst	Chrip (MHz)	Pulse Width(us)	PRI-1 (us)	PRI-2 (us)	PRI-3 (us)
1	2	13	83.1	1762	1058	-
2	1	13	50	1739	-	-
3	1	13	52.6	1055	-	-
4	1	13	58.2	1704	-	-
5	3	13	84.6	1226	1177	1886
6	2	13	68.3	1269	1851	-
7	2	13	80.6	1814	1074	-
8	1	13	59.5	1009	-	-
9	1	13	53.4	1417	-	-
10	1	13	59.1	1431	-	-
11	2	13	74.8	1002	1394	-
12	3	13	85	1670	1755	1158
13	3	13	85.3	1307	1560	1078
14	1	13	61.9	1197	-	-
15						
16						
17						
18						
19						
20						



Long Pulse Radar Test Signal

Test Signal Name: LP_Signal_22

Number of Bursts in Trial: 17

Burst	Pulses per Burst	Chrip (MHz)	Pulse Width(us)	PRI-1 (us)	PRI-2 (us)	PRI-3 (us)
1	2	19	70.8	1022	1015	-
2	1	19	52.9	1483	-	-
3	3	19	86	1524	1308	1287
4	2	19	78.4	1821	1406	-
5	3	19	93.3	1991	1966	1290
6	2	19	70	1858	1471	-
7	2	19	78.1	1507	1705	-
8	1	19	52.4	1060	-	-
9	3	19	84.8	1859	1839	1993
10	3	19	83.5	1150	1492	1443
11	1	19	56.7	1208	-	-
12	3	19	86.2	1674	1125	1053
13	1	19	58.8	1436	-	-
14	3	19	85.4	1686	1509	1577
15	2	19	77.7	1297	1298	-
16	3	19	87.4	1649	1894	1075
17	3	19	99.8	1185	1167	1616
18						
19						
20						



Long Pulse Radar Test Signal

Test Signal Name: LP_Signal_23

Number of Bursts in Trial: 12

Burst	Pulses per Burst	Chrip (MHz)	Pulse Width(us)	PRI-1 (us)	PRI-2 (us)	PRI-3 (us)
1	3	6	95.7	1353	1813	1028
2	3	6	94.9	1735	1994	1084
3	3	6	97.9	1354	1792	1418
4	2	6	67.4	1348	1008	-
5	3	6	96.9	1916	1425	1283
6	3	6	97.6	1384	1050	1569
7	3	6	83.6	1231	1219	1194
8	2	6	82.6	1128	1346	-
9	3	6	97.2	1142	1769	1173
10	3	6	92.3	1181	1164	1458
11	2	6	80.9	1222	1756	-
12	2	6	78.1	1190	1999	-
13						
14						
15						
16						
17						
18						
19						
20						

Long Pulse Radar Test Signal

Test Signal Name: LP_Signal_24

Number of Bursts in Trial: 8

Burst	Pulses per Burst	Chrip (MHz)	Pulse Width(us)	PRI-1 (us)	PRI-2 (us)	PRI-3 (us)
1	2	7	76.9	1564	1767	-
2	1	7	64.7	1437	-	-
3	2	7	77.1	1046	1944	-
4	2	7	72.7	1440	1374	-
5	1	7	61.9	1035	-	-
6	2	7	68.6	1205	1892	-
7	2	7	78.3	1047	1273	-
8	2	7	73.1	1426	1863	-
9						
10						
11						
12						
13						
14						
15						
16						
17						
18						
19						
20						

Long Pulse Radar Test Signal

Test Signal Name: LP_Signal_25

Number of Bursts in Trial: 16

Burst	Pulses per Burst	Chrip (MHz)	Pulse Width(us)	PRI-1 (us)	PRI-2 (us)	PRI-3 (us)
1	1	6	59.1	1718	-	-
2	3	6	83.5	1070	1129	1318
3	3	6	86.5	1176	1253	1442
4	1	6	60.8	1209	-	-
5	2	6	80.7	2000	1360	-
6	1	6	65.2	1101	-	-
7	2	6	69.1	1511	1030	-
8	1	6	51.5	1161	-	-
9	3	6	98.5	1061	1951	1812
10	1	6	59.5	1325	-	-
11	3	6	95.3	1284	1650	1169
12	2	6	81.8	1460	1077	-
13	1	6	66	1149	-	-
14	1	6	59.3	1373	-	-
15	2	6	79.2	1836	1534	-
16	3	6	90.2	1455	1738	1490
17						
18						
19						
20						



Long Pulse Radar Test Signal

Test Signal Name: LP_Signal_26

Number of Bursts in Trial: 13

Burst	Pulses per Burst	Chrip (MHz)	Pulse Width(us)	PRI-1 (us)	PRI-2 (us)	PRI-3 (us)
1	3	13	87.5	1343	1331	1313
2	3	13	94.6	1448	1543	1803
3	2	13	73.9	1722	1514	-
4	1	13	55.4	1506	-	-
5	1	13	52.3	1960	-	-
6	3	13	95.8	1240	1380	1252
7	3	13	96.1	1372	1411	1908
8	2	13	77.8	1885	1593	-
9	3	13	97.2	1021	1614	1633
10	2	13	74.3	1582	1097	-
11	1	13	57.9	1031	-	-
12	2	13	68.8	1927	1936	-
13	2	13	79.6	1857	1470	-
14						
15						
16						
17						
18						
19						
20						

Long Pulse Radar Test Signal

Test Signal Name: LP_Signal_27

Number of Bursts in Trial: 9

Burst	Pulses per Burst	Chrip (MHz)	Pulse Width(us)	PRI-1 (us)	PRI-2 (us)	PRI-3 (us)
1	1	18	63.4	1595	-	-
2	3	18	97	1451	1660	1562
3	2	18	66.7	1116	1544	-
4	3	18	99.5	1553	1526	1768
5	1	18	64.3	1107	-	-
6	3	18	90.7	1992	1626	1899
7	1	18	62.1	1630	-	-
8	1	18	58.3	1676	-	-
9	3	18	87	1726	1696	1464
10						
11						
12						
13						
14						
15						
16						
17						
18						
19						
20						

Long Pulse Radar Test Signal

Test Signal Name: LP_Signal_28

Number of Bursts in Trial: 9

Burst	Pulses per Burst	Chrip (MHz)	Pulse Width(us)	PRI-1 (us)	PRI-2 (us)	PRI-3 (us)
1	3	7	86.8	1673	1383	1653
2	2	7	81.7	1841	1911	-
3	2	7	78.4	1900	1229	-
4	2	7	82.1	1527	1072	-
5	3	7	84.1	1893	1742	1491
6	3	7	87.7	1247	1341	1955
7	3	7	97	1559	1685	1572
8	3	7	99.1	1641	1727	1848
9	1	7	62	1245	-	-
10						
11						
12						
13						
14						
15						
16						
17						
18						
19						
20						

Long Pulse Radar Test Signal

Test Signal Name: LP_Signal_29

Number of Bursts in Trial: 8

Burst	Pulses per Burst	Chrip (MHz)	Pulse Width(us)	PRI-1 (us)	PRI-2 (us)	PRI-3 (us)
1	2	20	67.5	1193	1182	-
2	3	20	85.6	1221	1741	1338
3	3	20	86.9	1580	1775	1809
4	3	20	85.3	1082	1854	1095
5	2	20	67.3	1898	1977	-
6	3	20	94.8	1791	1350	1230
7	2	20	72.9	1681	1323	-
8	2	20	70.7	1709	1123	-
9						
10						
11						
12						
13						
14						
15						
16						
17						
18						
19						



Long Pulse Radar Test Signal

Test Signal Name: LP_Signal_30

Number of Bursts in Trial: 10

Burst	Pulses per Burst	Chrip (MHz)	Pulse Width(us)	PRI-1 (us)	PRI-2 (us)	PRI-3 (us)
1	1	7	63.3	1044	-	-
2	3	7	87.4	1945	1602	1203
3	1	7	58.7	1556	-	-
4	1	7	63.6	1598	-	-
5	1	7	56.3	1110	-	-
6	1	7	57.2	1878	-	-
7	1	7	50.3	1659	-	-
8	2	7	71.9	1143	1724	-
9	3	7	85.1	1404	1715	1449
10	1	7	62.5	1276	-	-
11						
12						
13						
14						
15						
16						
17						
18						
19						
20						

BW80

A.1 The Long Pulse Radar Pattern

Long Pulse Radar Test Signal

Test Signal Name: LP_Signal_01

Number of Bursts in Trial: 10

Burst	Pulses per Burst	Chrip (MHz)	Pulse Width(us)	PRI-1 (us)	PRI-2 (us)	PRI-3 (us)
1	1	15	58.7	1765	-	-
2	3	15	84.3	1452	1398	1571
3	3	15	87.4	1358	1377	1111
4	3	15	91.4	1554	1036	1662
5	1	15	61.8	1828	-	-
6	1	15	51.8	1621	-	-
7	3	15	93.4	1063	1317	1923
8	2	15	73.8	1804	1156	-
9	2	15	72.6	1935	1079	-
10	2	15	82.5	1049	1478	-
11						
12						
13						
14						
15						
16						
17						
18						
19						
20						



Long Pulse Radar Test Signal

Test Signal Name: LP_Signal_02

Number of Bursts in Trial: 16

Burst	Pulses per Burst	Chrip (MHz)	Pulse Width(us)	PRI-1 (us)	PRI-2 (us)	PRI-3 (us)
1	1	11	51.3	1713	-	-
2	1	11	54	1485	-	-
3	2	11	69.1	1043	1750	-
4	3	11	93.8	1665	1844	1155
5	3	11	99.1	1505	1825	1538
6	2	11	76	1866	1508	-
7	1	11	63.5	1889	-	-
8	2	11	69.8	1024	1578	-
9	1	11	60.9	1067	-	-
10	1	11	52.9	1162	-	-
11	2	11	73.7	1211	1581	-
12	3	11	87.8	1516	1753	1473
13	2	11	68.6	1029	1730	-
14	1	11	50.9	1930	-	-
15	2	11	83	1675	1303	-
16	2	11	69.5	1296	1410	-
17						
18						
19						
20						

Long Pulse Radar Test Signal

Test Signal Name: LP_Signal_03

Number of Bursts in Trial: 17

Burst	Pulses per Burst	Chrip (MHz)	Pulse Width(us)	PRI-1 (us)	PRI-2 (us)	PRI-3 (us)
1	1	12	56.4	1603	-	-
2	1	12	53.9	1545	-	-
3	1	12	53.5	1943	-	-
4	1	12	59.4	1206	-	-
5	2	12	78.5	1305	1969	-
6	3	12	86.1	1355	1823	1948
7	2	12	67	1788	1958	-
8	2	12	74.5	1213	1124	-
9	2	12	81.3	1215	1366	-
10	2	12	81.5	1429	1293	-
11	2	12	79.9	1345	1990	-
12	1	12	50.5	1996	-	-
13	3	12	88.4	1871	1121	1723
14	1	12	65.7	1964	-	-
15	3	12	93	1962	1265	1267
16	1	12	63.6	1020	-	-
17	2	12	78.1	1737	1422	-
18						
19						
20						

Long Pulse Radar Test Signal

Test Signal Name: LP_Signal_04

Number of Bursts in Trial: 18

Burst	Pulses per Burst	Chrip (MHz)	Pulse Width(us)	PRI-1 (us)	PRI-2 (us)	PRI-3 (us)
1	2	10	76.8	1105	1462	-
2	2	10	72.6	1668	1188	-
3	2	10	70.4	1321	1820	-
4	1	10	57	1683	-	-
5	3	10	88.6	1721	1611	1967
6	1	10	55	1594	-	-
7	3	10	93.3	1624	1678	1625
8	3	10	86.7	1720	1540	1349
9	3	10	86.7	1816	1617	1754
10	1	10	57.7	1382	-	-
11	2	10	78.1	1561	1416	-
12	1	10	59.9	1734	-	-
13	2	10	71	1677	1220	-
14	1	10	65.7	1497	-	-
15	3	10	86.4	1957	1088	1054
16	1	10	58.3	1104	-	-
17	3	10	92.3	1589	1800	1189
18	3	10	95.4	1147	1801	1748
19						
20						

Long Pulse Radar Test Signal

Test Signal Name: LP_Signal_05

Number of Bursts in Trial: 11

Burst	Pulses per Burst	Chrip (MHz)	Pulse Width(us)	PRI-1 (us)	PRI-2 (us)	PRI-3 (us)
1	3	18	89.4	1574	1736	1023
2	2	18	70.2	1655	1500	-
3	1	18	63.2	1445	-	-
4	1	18	53.9	1098	-	-
5	1	18	65.2	1918	-	-
6	3	18	87.1	1453	1658	1236
7	3	18	94.6	1896	1154	1456
8	1	18	62.4	1646	-	-
9	2	18	67.6	1600	1439	-
10	3	18	96.2	1629	1909	1879
11	1	18	62.9	1793	-	-
12						
13						
14						
15						
16						
17						
18						
19						
20						

Long Pulse Radar Test Signal

Test Signal Name: LP_Signal_06

Number of Bursts in Trial: 8

Burst	Pulses per Burst	Chrip (MHz)	Pulse Width(us)	PRI-1 (us)	PRI-2 (us)	PRI-3 (us)
1	2	14	81.4	1413	1565	-
2	3	14	95.3	1774	1131	1995
3	1	14	60	1160	-	-
4	1	14	60.1	1922	-	-
5	1	14	59.6	1069	-	-
6	3	14	91.8	1259	1810	1477
7	2	14	78.4	1763	1487	-
8	1	14	62.6	1122	-	-
9						
10						
11						
12						
13						
14						
15						
16						
17						
18						
19						
20						

Long Pulse Radar Test Signal

Test Signal Name: LP_Signal_07

Number of Bursts in Trial: 19

Burst	Pulses per Burst	Chrip (MHz)	Pulse Width(us)	PRI-1 (us)	PRI-2 (us)	PRI-3 (us)
1	1	17	62.4	1000	-	-
2	2	17	67.9	1925	1039	-
3	3	17	99	1890	1228	1326
4	1	17	60.3	1210	-	-
5	2	17	72.7	1688	1548	-
6	3	17	91.9	1988	1503	1201
7	2	17	78.3	1309	1198	-
8	3	17	88.9	1080	1399	1115
9	1	17	64.5	1087	-	-
10	1	17	60.3	1133	-	-
11	1	17	65.8	1579	-	-
12	3	17	93.5	1619	1682	1758
13	3	17	92.2	1533	1842	1979
14	3	17	96.2	1672	1744	1971
15	2	17	70.3	1414	1692	-
16	1	17	53.5	1706	-	-
17	3	17	93.4	1870	1242	1395
18	1	17	64.9	1438	-	-
19	2	17	72.9	1239	1817	-
20						

Long Pulse Radar Test Signal

Test Signal Name: LP_Signal_08

Number of Bursts in Trial: 14

Burst	Pulses per Burst	Chrip (MHz)	Pulse Width(us)	PRI-1 (us)	PRI-2 (us)	PRI-3 (us)
1	1	10	57.3	1698	-	-
2	2	10	83.3	1700	1427	-
3	1	10	62.5	1952	-	-
4	2	10	76.1	1612	1397	-
5	3	10	87.5	1139	1901	1400
6	3	10	97.1	1352	1798	1636
7	2	10	73.8	1496	1536	-
8	1	10	55.2	1357	-	-
9	1	10	62.5	1811	-	-
10	2	10	68.1	1251	1843	-
11	3	10	99.9	1819	1057	1017
12	1	10	61.3	1342	-	-
13	2	10	73.9	1725	1872	-
14	1	10	58	1747	-	-
15						
16						
17						
18						
19						
20						

Long Pulse Radar Test Signal

Test Signal Name: LP_Signal_09

Number of Bursts in Trial: 13

Burst	Pulses per Burst	Chrip (MHz)	Pulse Width(us)	PRI-1 (us)	PRI-2 (us)	PRI-3 (us)
1	3	12	95.8	1465	1975	1904
2	2	12	79.9	1764	1174	-
3	2	12	77.4	1235	1584	-
4	3	12	90.4	1114	1974	1027
5	1	12	59.9	1126	-	-
6	3	12	90.5	1275	1985	1845
7	1	12	62	1062	-	-
8	3	12	87	1463	1587	1887
9	3	12	98.3	1586	1187	1651
10	2	12	80.1	1277	1881	-
11	1	12	52.1	1330	-	-
12	1	12	51.7	1333	-	-
13	1	12	52.7	1867	-	-
14						
15						
16						
17						
18						
19						
20						

Long Pulse Radar Test Signal

Test Signal Name: LP_Signal_10

Number of Bursts in Trial: 16

Burst	Pulses per Burst	Chrip (MHz)	Pulse Width(us)	PRI-1 (us)	PRI-2 (us)	PRI-3 (us)
1	2	19	70.7	1934	1731	-
2	3	19	85.3	1179	1751	1711
3	2	19	75	1034	1261	-
4	1	19	56.4	1954	-	-
5	2	19	66.7	1243	1090	-
6	3	19	94.8	1224	1970	1214
7	2	19	68.8	1701	1280	-
8	2	19	71	1563	1537	-
9	2	19	79.4	1525	1389	-
10	3	19	100	1717	1498	1740
11	3	19	91.9	1295	1037	1829
12	1	19	61.5	1949	-	-
13	1	19	63.2	1596	-	-
14	3	19	99	1254	1919	1073
15	3	19	86.6	1606	1849	1202
16	1	19	65.8	1635	-	-
17						
18						
19						
20						

Long Pulse Radar Test Signal

Test Signal Name: LP_Signal_11

Number of Bursts in Trial: 8

Burst	Pulses per Burst	Chrip (MHz)	Pulse Width(us)	PRI-1 (us)	PRI-2 (us)	PRI-3 (us)
1	2	7	70.7	1897	1749	-
2	1	7	64.6	1965	-	-
3	3	7	99	1012	1045	1772
4	3	7	91.9	1583	1466	1549
5	3	7	85.5	1420	1780	1459
6	3	7	96.5	1530	1924	1835
7	1	7	66.2	1550	-	-
8	3	7	92.9	1929	1335	1883
9						
10						
11						
12						
13						
14						
15						
16						
17						
18						
19						
20						

Long Pulse Radar Test Signal

Test Signal Name: LP_Signal_12

Number of Bursts in Trial: 9

Burst	Pulses per Burst	Chrip (MHz)	Pulse Width(us)	PRI-1 (us)	PRI-2 (us)	PRI-3 (us)
1	1	15	63.1	1642	-	-
2	3	15	83.5	1005	1981	1250
3	2	15	74.5	1914	1474	-
4	1	15	60.9	1430	-	-
5	2	15	70.4	1680	1542	-
6	3	15	85.1	1048	1127	1393
7	2	15	82.4	1605	1282	-
8	2	15	74	1108	1691	-
9	3	15	85.7	1486	1976	1212
10						
11						
12						
13						
14						
15						
16						
17						
18						
19						
20						



Long Pulse Radar Test Signal

Test Signal Name: LP_Signal_13

Number of Bursts in Trial: 12

Burst	Pulses per Burst	Chrip (MHz)	Pulse Width(us)	PRI-1 (us)	PRI-2 (us)	PRI-3 (us)
1	3	7	94.4	1385	1336	1376
2	1	7	53	1805	-	-
3	2	7	70	1248	1558	-
4	3	7	87.6	1403	1170	1315
5	1	7	61.7	1042	-	-
6	2	7	83.2	1100	1535	-
7	1	7	66.6	1038	-	-
8	1	7	55.1	1423	-	-
9	3	7	87	1789	1306	1643
10	1	7	66.4	1409	-	-
11	2	7	80	1319	1094	-
12	3	7	85.6	1891	1291	1529
13						
14						
15						
16						
17						
18						
19						
20						

Long Pulse Radar Test Signal

Test Signal Name: LP_Signal_14

Number of Bursts in Trial: 19

Burst	Pulses per Burst	Chrip (MHz)	Pulse Width(us)	PRI-1 (us)	PRI-2 (us)	PRI-3 (us)
1	2	20	78.9	1613	1263	-
2	3	20	96.7	1627	1432	1986
3	3	20	91.5	1472	1759	1784
4	2	20	75.4	1274	1795	-
5	2	20	71.1	1968	1444	-
6	2	20	77.5	1588	1441	-
7	1	20	65.4	1710	-	-
8	1	20	53.1	1419	-	-
9	1	20	59.9	1518	-	-
10	2	20	67.3	1195	1168	-
11	2	20	74.2	1386	1216	-
12	2	20	69	1557	1132	-
13	2	20	82.1	1987	1186	-
14	3	20	93.3	1365	1032	1728
15	2	20	83.3	1103	1568	-
16	2	20	70.3	1699	1281	-
17	1	20	57.9	1285	-	-
18	1	20	50.6	1850	-	-
19	3	20	94.3	1479	1218	1733
20						



Long Pulse Radar Test Signal

Test Signal Name: LP_Signal_15

Number of Bursts in Trial: 20

Burst	Pulses per Burst	Chrip (MHz)	Pulse Width(us)	PRI-1 (us)	PRI-2 (us)	PRI-3 (us)
1	2	18	67.5	1434	1117	-
2	2	18	67.8	1567	1773	-
3	2	18	75.9	1846	1362	-
4	2	18	68.9	1237	1818	-
5	3	18	96	1339	1796	1852
6	1	18	66.6	1289	-	-
7	2	18	78.3	1862	1856	-
8	1	18	58.9	1412	-	-
9	2	18	81.5	1113	1591	-
10	2	18	82.4	1059	1861	-
11	3	18	86.8	1797	1163	1320
12	3	18	98.5	1268	1300	1868
13	2	18	80.1	1086	1482	-
14	3	18	86.3	1860	1407	1998
15	1	18	57.2	1241	-	-
16	3	18	84.3	1808	1873	1628
17	3	18	86.8	1258	1302	1978
18	2	18	83	1690	1378	-
19	3	18	85.6	1327	1956	1311
20	3	18	99.4	1112	1815	1262

Long Pulse Radar Test Signal

Test Signal Name: LP_Signal_16

Number of Bursts in Trial: 14

Burst	Pulses per Burst	Chrip (MHz)	Pulse Width(us)	PRI-1 (us)	PRI-2 (us)	PRI-3 (us)
1	1	19	57.5	1379	-	-
2	2	19	67	1551	1620	-
3	2	19	70.9	1939	1083	-
4	2	19	75.7	1332	1476	-
5	2	19	77.1	1840	1010	-
6	2	19	78.8	1371	1618	-
7	1	19	51	1494	-	-
8	1	19	55.4	1794	-	-
9	2	19	68.5	1590	1266	-
10	3	19	100	1484	1314	1428
11	3	19	96.4	1363	1361	1292
12	3	19	97.2	1694	1480	1446
13	3	19	86.4	1447	1227	1102
14	2	19	72.1	1184	1638	-
15						
16						
17						
18						
19						
20						

Long Pulse Radar Test Signal

Test Signal Name: LP_Signal_17

Number of Bursts in Trial: 11

Burst	Pulses per Burst	Chrip (MHz)	Pulse Width(us)	PRI-1 (us)	PRI-2 (us)	PRI-3 (us)
1	1	13	62.4	1329	-	-
2	2	13	67.8	1364	1937	-
3	1	13	53	1790	-	-
4	2	13	77.8	1546	1906	-
5	3	13	95.6	1145	1743	1499
6	1	13	58.8	1199	-	-
7	3	13	92.8	1424	1408	1381
8	2	13	68.5	1340	1972	-
9	3	13	84	1607	1663	1270
10	2	13	70.8	1468	1760	-
11	2	13	73.1	1869	1515	-
12						
13						
14						
15						
16						
17						
18						
19						
20						

Long Pulse Radar Test Signal

Test Signal Name: LP_Signal_18

Number of Bursts in Trial: 13

Burst	Pulses per Burst	Chrip (MHz)	Pulse Width(us)	PRI-1 (us)	PRI-2 (us)	PRI-3 (us)
1	2	12	68.8	1504	1973	-
2	3	12	94.2	1920	1299	1467
3	2	12	82.7	1003	1351	-
4	2	12	74.8	1597	1457	-
5	1	12	58.9	1874	-	-
6	3	12	96.5	1838	1708	1328
7	3	12	87.3	1405	1271	1687
8	2	12	72.4	1200	1433	-
9	1	12	51.3	1475	-	-
10	3	12	86.8	1159	1652	1942
11	1	12	50.4	1056	-	-
12	3	12	97	1884	1876	1415
13	1	12	50.1	1519	-	-
14						
15						
16						
17						
18						
19						
20						

Long Pulse Radar Test Signal

Test Signal Name: LP_Signal_19

Number of Bursts in Trial: 10

Burst	Pulses per Burst	Chrip (MHz)	Pulse Width(us)	PRI-1 (us)	PRI-2 (us)	PRI-3 (us)
1	3	15	91.9	1301	1337	1645
2	2	15	67.2	1983	1040	-
3	1	15	65.5	1671	-	-
4	2	15	72.8	1489	1016	-
5	3	15	90.5	1552	1180	1064
6	2	15	81.6	1807	1853	-
7	3	15	86	1312	1905	1278
8	3	15	89.6	1152	1068	1832
9	1	15	62.1	1119	-	-
10	1	15	58	1234	-	-
11						
12						
13						
14						
15						
16						
17						
18						
19						
20						

Long Pulse Radar Test Signal

Test Signal Name: LP_Signal_20

Number of Bursts in Trial: 8

Burst	Pulses per Burst	Chrip (MHz)	Pulse Width(us)	PRI-1 (us)	PRI-2 (us)	PRI-3 (us)
1	2	9	73.8	1071	1915	-
2	3	9	89.5	1294	1450	1025
3	2	9	81.2	1144	1146	-
4	1	9	59	1041	-	-
5	3	9	87.5	1096	1941	1018
6	2	9	76.7	1667	1947	-
7	1	9	56.5	1573	-	-
8	3	9	89	1033	1391	1304
9						
10						
11						
12						
13						
14						
15						
16						
17						
18						
19						
20						

Long Pulse Radar Test Signal

Test Signal Name: LP_Signal_21

Number of Bursts in Trial: 14

Burst	Pulses per Burst	Chrip (MHz)	Pulse Width(us)	PRI-1 (us)	PRI-2 (us)	PRI-3 (us)
1	2	5	83.1	1762	1058	-
2	1	5	50	1739	-	-
3	1	5	52.6	1055	-	-
4	1	5	58.2	1704	-	-
5	3	5	84.6	1226	1177	1886
6	2	5	68.3	1269	1851	-
7	2	5	80.6	1814	1074	-
8	1	5	59.5	1009	-	-
9	1	5	53.4	1417	-	-
10	1	5	59.1	1431	-	-
11	2	5	74.8	1002	1394	-
12	3	5	85	1670	1755	1158
13	3	5	85.3	1307	1560	1078
14	1	5	61.9	1197	-	-
15						
16						
17						
18						
19						
20						

Long Pulse Radar Test Signal

Test Signal Name: LP_Signal_22

Number of Bursts in Trial: 17

Burst	Pulses per Burst	Chrip (MHz)	Pulse Width(us)	PRI-1 (us)	PRI-2 (us)	PRI-3 (us)
1	2	18	70.8	1022	1015	-
2	1	18	52.9	1483	-	-
3	3	18	86	1524	1308	1287
4	2	18	78.4	1821	1406	-
5	3	18	93.3	1991	1966	1290
6	2	18	70	1858	1471	-
7	2	18	78.1	1507	1705	-
8	1	18	52.4	1060	-	-
9	3	18	84.8	1859	1839	1993
10	3	18	83.5	1150	1492	1443
11	1	18	56.7	1208	-	-
12	3	18	86.2	1674	1125	1053
13	1	18	58.8	1436	-	-
14	3	18	85.4	1686	1509	1577
15	2	18	77.7	1297	1298	-
16	3	18	87.4	1649	1894	1075
17	3	18	99.8	1185	1167	1616
18						
19						
20						



Long Pulse Radar Test Signal

Test Signal Name: LP_Signal_23

Number of Bursts in Trial: 12

Burst	Pulses per Burst	Chrip (MHz)	Pulse Width(us)	PRI-1 (us)	PRI-2 (us)	PRI-3 (us)
1	3	7	95.7	1353	1813	1028
2	3	7	94.9	1735	1994	1084
3	3	7	97.9	1354	1792	1418
4	2	7	67.4	1348	1008	-
5	3	7	96.9	1916	1425	1283
6	3	7	97.6	1384	1050	1569
7	3	7	83.6	1231	1219	1194
8	2	7	82.6	1128	1346	-
9	3	7	97.2	1142	1769	1173
10	3	7	92.3	1181	1164	1458
11	2	7	80.9	1222	1756	-
12	2	7	78.1	1190	1999	-
13						
14						
15						
16						
17						
18						
19						
20						

Long Pulse Radar Test Signal

Test Signal Name: LP_Signal_24

Number of Bursts in Trial: 8

Burst	Pulses per Burst	Chrip (MHz)	Pulse Width(us)	PRI-1 (us)	PRI-2 (us)	PRI-3 (us)
1	2	18	76.9	1564	1767	-
2	1	18	64.7	1437	-	-
3	2	18	77.1	1046	1944	-
4	2	18	72.7	1440	1374	-
5	1	18	61.9	1035	-	-
6	2	18	68.6	1205	1892	-
7	2	18	78.3	1047	1273	-
8	2	18	73.1	1426	1863	-
9						
10						
11						
12						
13						
14						
15						
16						
17						
18						
19						
20						



Long Pulse Radar Test Signal

Test Signal Name: LP_Signal_25

Number of Bursts in Trial: 16

Burst	Pulses per Burst	Chrip (MHz)	Pulse Width(us)	PRI-1 (us)	PRI-2 (us)	PRI-3 (us)
1	1	9	59.1	1718	-	-
2	3	9	83.5	1070	1129	1318
3	3	9	86.5	1176	1253	1442
4	1	9	60.8	1209	-	-
5	2	9	80.7	2000	1360	-
6	1	9	65.2	1101	-	-
7	2	9	69.1	1511	1030	-
8	1	9	51.5	1161	-	-
9	3	9	98.5	1061	1951	1812
10	1	9	59.5	1325	-	-
11	3	9	95.3	1284	1650	1169
12	2	9	81.8	1460	1077	-
13	1	9	66	1149	-	-
14	1	9	59.3	1373	-	-
15	2	9	79.2	1836	1534	-
16	3	9	90.2	1455	1738	1490
17						
18						
19						
20						



Long Pulse Radar Test Signal

Test Signal Name: LP_Signal_26

Number of Bursts in Trial: 13

Burst	Pulses per Burst	Chrip (MHz)	Pulse Width(us)	PRI-1 (us)	PRI-2 (us)	PRI-3 (us)
1	3	11	87.5	1343	1331	1313
2	3	11	94.6	1448	1543	1803
3	2	11	73.9	1722	1514	-
4	1	11	55.4	1506	-	-
5	1	11	52.3	1960	-	-
6	3	11	95.8	1240	1380	1252
7	3	11	96.1	1372	1411	1908
8	2	11	77.8	1885	1593	-
9	3	11	97.2	1021	1614	1633
10	2	11	74.3	1582	1097	-
11	1	11	57.9	1031	-	-
12	2	11	68.8	1927	1936	-
13	2	11	79.6	1857	1470	-
14						
15						
16						
17						
18						
19						
20						

Long Pulse Radar Test Signal

Test Signal Name: LP_Signal_27

Number of Bursts in Trial: 9

Burst	Pulses per Burst	Chrip (MHz)	Pulse Width(us)	PRI-1 (us)	PRI-2 (us)	PRI-3 (us)
1	1	11	63.4	1595	-	-
2	3	11	97	1451	1660	1562
3	2	11	66.7	1116	1544	-
4	3	11	99.5	1553	1526	1768
5	1	11	64.3	1107	-	-
6	3	11	90.7	1992	1626	1899
7	1	11	62.1	1630	-	-
8	1	11	58.3	1676	-	-
9	3	11	87	1726	1696	1464
10						
11						
12						
13						
14						
15						
16						
17						
18						
19						
20						

Long Pulse Radar Test Signal

Test Signal Name: LP_Signal_28

Number of Bursts in Trial: 9

Burst	Pulses per Burst	Chrip (MHz)	Pulse Width(us)	PRI-1 (us)	PRI-2 (us)	PRI-3 (us)
1	3	11	86.8	1673	1383	1653
2	2	11	81.7	1841	1911	-
3	2	11	78.4	1900	1229	-
4	2	11	82.1	1527	1072	-
5	3	11	84.1	1893	1742	1491
6	3	11	87.7	1247	1341	1955
7	3	11	97	1559	1685	1572
8	3	11	99.1	1641	1727	1848
9	1	11	62	1245	-	-
10						
11						
12						
13						
14						
15						
16						
17						
18						
19						
20						

Long Pulse Radar Test Signal

Test Signal Name: LP_Signal_29

Number of Bursts in Trial: 8

Burst	Pulses per Burst	Chrip (MHz)	Pulse Width(us)	PRI-1 (us)	PRI-2 (us)	PRI-3 (us)
1	2	15	67.5	1193	1182	-
2	3	15	85.6	1221	1741	1338
3	3	15	86.9	1580	1775	1809
4	3	15	85.3	1082	1854	1095
5	2	15	67.3	1898	1977	-
6	3	15	94.8	1791	1350	1230
7	2	15	72.9	1681	1323	-
8	2	15	70.7	1709	1123	-
9						
10						
11						
12						
13						
14						
15						
16						
17						
18						
19						

Long Pulse Radar Test Signal

Test Signal Name: LP_Signal_30

Number of Bursts in Trial: 10

Burst	Pulses per Burst	Chrip (MHz)	Pulse Width(us)	PRI-1 (us)	PRI-2 (us)	PRI-3 (us)
1	1	7	63.3	1044	-	-
2	3	7	87.4	1945	1602	1203
3	1	7	58.7	1556	-	-
4	1	7	63.6	1598	-	-
5	1	7	56.3	1110	-	-
6	1	7	57.2	1878	-	-
7	1	7	50.3	1659	-	-
8	2	7	71.9	1143	1724	-
9	3	7	85.1	1404	1715	1449
10	1	7	62.5	1276	-	-
11						
12						
13						
14						
15						
16						
17						
18						
19						
20						

BW160

A.1 The Long Pulse Radar Pattern

Long Pulse Radar Test Signal						
Test Signal Name: LP_Signal_01						
Number of Bursts in Trial: 10						
Burst	Pulses per Burst	Chrip (MHz)	Pulse Width(us)	PRI-1 (us)	PRI-2 (us)	PRI-3 (us)
1	1	7	58.7	1765	-	-
2	3	7	84.3	1452	1398	1571
3	3	7	87.4	1358	1377	1111
4	3	7	91.4	1554	1036	1662
5	1	7	61.8	1828	-	-
6	1	7	51.8	1621	-	-
7	3	7	93.4	1063	1317	1923
8	2	7	73.8	1804	1156	-
9	2	7	72.6	1935	1079	-
10	2	7	82.5	1049	1478	-
11						
12						
13						
14						
15						
16						
17						
18						
19						
20						

Long Pulse Radar Test Signal

Test Signal Name: LP_Signal_02

Number of Bursts in Trial: 16

Burst	Pulses per Burst	Chrip (MHz)	Pulse Width(us)	PRI-1 (us)	PRI-2 (us)	PRI-3 (us)
1	1	15	51.3	1713	-	-
2	1	15	54	1485	-	-
3	2	15	69.1	1043	1750	-
4	3	15	93.8	1665	1844	1155
5	3	15	99.1	1505	1825	1538
6	2	15	76	1866	1508	-
7	1	15	63.5	1889	-	-
8	2	15	69.8	1024	1578	-
9	1	15	60.9	1067	-	-
10	1	15	52.9	1162	-	-
11	2	15	73.7	1211	1581	-
12	3	15	87.8	1516	1753	1473
13	2	15	68.6	1029	1730	-
14	1	15	50.9	1930	-	-
15	2	15	83	1675	1303	-
16	2	15	69.5	1296	1410	-
17					-	-
18						
19						
20						



Long Pulse Radar Test Signal

Test Signal Name: LP_Signal_03

Number of Bursts in Trial: 17

Burst	Pulses per Burst	Chrip (MHz)	Pulse Width(us)	PRI-1 (us)	PRI-2 (us)	PRI-3 (us)
1	1	16	56.4	1603	-	-
2	1	16	53.9	1545	-	-
3	1	16	53.5	1943	-	-
4	1	16	59.4	1206	-	-
5	2	16	78.5	1305	1969	-
6	3	16	86.1	1355	1823	1948
7	2	16	67	1788	1958	-
8	2	16	74.5	1213	1124	-
9	2	16	81.3	1215	1366	-
10	2	16	81.5	1429	1293	-
11	2	16	79.9	1345	1990	-
12	1	16	50.5	1996	-	-
13	3	16	88.4	1871	1121	1723
14	1	16	65.7	1964	-	-
15	3	16	93	1962	1265	1267
16	1	16	63.6	1020	-	-
17	2	16	78.1	1737	1422	-
18						
19						
20						



Long Pulse Radar Test Signal

Test Signal Name: LP_Signal_04

Number of Bursts in Trial: 18

Burst	Pulses per Burst	Chrip (MHz)	Pulse Width(us)	PRI-1 (us)	PRI-2 (us)	PRI-3 (us)
1	2	18	76.8	1105	1462	-
2	2	18	72.6	1668	1188	-
3	2	18	70.4	1321	1820	-
4	1	18	57	1683	-	-
5	3	18	88.6	1721	1611	1967
6	1	18	55	1594	-	-
7	3	18	93.3	1624	1678	1625
8	3	18	86.7	1720	1540	1349
9	3	18	86.7	1816	1617	1754
10	1	18	57.7	1382	-	-
11	2	18	78.1	1561	1416	-
12	1	18	59.9	1734	-	-
13	2	18	71	1677	1220	-
14	1	18	65.7	1497	-	-
15	3	18	86.4	1957	1088	1054
16	1	18	58.3	1104	-	-
17	3	18	92.3	1589	1800	1189
18	3	18	95.4	1147	1801	1748
19						
20						

Long Pulse Radar Test Signal

Test Signal Name: LP_Signal_05

Number of Bursts in Trial: 11

Burst	Pulses per Burst	Chrip (MHz)	Pulse Width(us)	PRI-1 (us)	PRI-2 (us)	PRI-3 (us)
1	3	8	89.4	1574	1736	1023
2	2	8	70.2	1655	1500	-
3	1	8	63.2	1445	-	-
4	1	8	53.9	1098	-	-
5	1	8	65.2	1918	-	-
6	3	8	87.1	1453	1658	1236
7	3	8	94.6	1896	1154	1456
8	1	8	62.4	1646	-	-
9	2	8	67.6	1600	1439	-
10	3	8	96.2	1629	1909	1879
11	1	8	62.9	1793	-	-
12						
13						
14						
15						
16						
17						
18						
19						
20						

Long Pulse Radar Test Signal

Test Signal Name: LP_Signal_06

Number of Bursts in Trial: 8

Burst	Pulses per Burst	Chrip (MHz)	Pulse Width(us)	PRI-1 (us)	PRI-2 (us)	PRI-3 (us)
1	2	5	81.4	1413	1565	-
2	3	5	95.3	1774	1131	1995
3	1	5	60	1160	-	-
4	1	5	60.1	1922	-	-
5	1	5	59.6	1069	-	-
6	3	5	91.8	1259	1810	1477
7	2	5	78.4	1763	1487	-
8	1	5	62.6	1122	-	-
9						
10						
11						
12						
13						
14						
15						
16						
17						
18						
19						
20						

Long Pulse Radar Test Signal

Test Signal Name: LP_Signal_07

Number of Bursts in Trial: 19

Burst	Pulses per Burst	Chrip (MHz)	Pulse Width(us)	PRI-1 (us)	PRI-2 (us)	PRI-3 (us)
1	1	18	62.4	1000	-	-
2	2	18	67.9	1925	1039	-
3	3	18	99	1890	1228	1326
4	1	18	60.3	1210	-	-
5	2	18	72.7	1688	1548	-
6	3	18	91.9	1988	1503	1201
7	2	18	78.3	1309	1198	-
8	3	18	88.9	1080	1399	1115
9	1	18	64.5	1087	-	-
10	1	18	60.3	1133	-	-
11	1	18	65.8	1579	-	-
12	3	18	93.5	1619	1682	1758
13	3	18	92.2	1533	1842	1979
14	3	18	96.2	1672	1744	1971
15	2	18	70.3	1414	1692	-
16	1	18	53.5	1706	-	-
17	3	18	93.4	1870	1242	1395
18	1	18	64.9	1438	-	-
19	2	18	72.9	1239	1817	-
20						



Long Pulse Radar Test Signal

Test Signal Name: LP_Signal_08

Number of Bursts in Trial: 14

Burst	Pulses per Burst	Chrip (MHz)	Pulse Width(us)	PRI-1 (us)	PRI-2 (us)	PRI-3 (us)
1	1	12	57.3	1698	-	-
2	2	12	83.3	1700	1427	-
3	1	12	62.5	1952	-	-
4	2	12	76.1	1612	1397	-
5	3	12	87.5	1139	1901	1400
6	3	12	97.1	1352	1798	1636
7	2	12	73.8	1496	1536	-
8	1	12	55.2	1357	-	-
9	1	12	62.5	1811	-	-
10	2	12	68.1	1251	1843	-
11	3	12	99.9	1819	1057	1017
12	1	12	61.3	1342	-	-
13	2	12	73.9	1725	1872	-
14	1	12	58	1747	-	-
15						
16						
17						
18						
19						
20						

Long Pulse Radar Test Signal

Test Signal Name: LP_Signal_09

Number of Bursts in Trial: 13

Burst	Pulses per Burst	Chrip (MHz)	Pulse Width(us)	PRI-1 (us)	PRI-2 (us)	PRI-3 (us)
1	3	12	95.8	1465	1975	1904
2	2	12	79.9	1764	1174	-
3	2	12	77.4	1235	1584	-
4	3	12	90.4	1114	1974	1027
5	1	12	59.9	1126	-	-
6	3	12	90.5	1275	1985	1845
7	1	12	62	1062	-	-
8	3	12	87	1463	1587	1887
9	3	12	98.3	1586	1187	1651
10	2	12	80.1	1277	1881	-
11	1	12	52.1	1330	-	-
12	1	12	51.7	1333	-	-
13	1	12	52.7	1867	-	-
14						
15						
16						
17						
18						
19						
20						



Long Pulse Radar Test Signal

Test Signal Name: LP_Signal_10

Number of Bursts in Trial: 16

Burst	Pulses per Burst	Chrip (MHz)	Pulse Width(us)	PRI-1 (us)	PRI-2 (us)	PRI-3 (us)
1	2	15	70.7	1934	1731	-
2	3	15	85.3	1179	1751	1711
3	2	15	75	1034	1261	-
4	1	15	56.4	1954	-	-
5	2	15	66.7	1243	1090	-
6	3	15	94.8	1224	1970	1214
7	2	15	68.8	1701	1280	-
8	2	15	71	1563	1537	-
9	2	15	79.4	1525	1389	-
10	3	15	100	1717	1498	1740
11	3	15	91.9	1295	1037	1829
12	1	15	61.5	1949	-	-
13	1	15	63.2	1596	-	-
14	3	15	99	1254	1919	1073
15	3	15	86.6	1606	1849	1202
16	1	15	65.8	1635	-	-
17						
18						
19						
20						

Long Pulse Radar Test Signal

Test Signal Name: LP_Signal_11

Number of Bursts in Trial: 8

Burst	Pulses per Burst	Chrip (MHz)	Pulse Width(us)	PRI-1 (us)	PRI-2 (us)	PRI-3 (us)
1	2	5	70.7	1897	1749	-
2	1	5	64.6	1965	-	-
3	3	5	99	1012	1045	1772
4	3	5	91.9	1583	1466	1549
5	3	5	85.5	1420	1780	1459
6	3	5	96.5	1530	1924	1835
7	1	5	66.2	1550	-	-
8	3	5	92.9	1929	1335	1883
9						
10						
11						
12						
13						
14						
15						
16						
17						
18						
19						
20						

Long Pulse Radar Test Signal

Test Signal Name: LP_Signal_12

Number of Bursts in Trial: 9

Burst	Pulses per Burst	Chrip (MHz)	Pulse Width(us)	PRI-1 (us)	PRI-2 (us)	PRI-3 (us)
1	1	6	63.1	1642	-	-
2	3	6	83.5	1005	1981	1250
3	2	6	74.5	1914	1474	-
4	1	6	60.9	1430	-	-
5	2	6	70.4	1680	1542	-
6	3	6	85.1	1048	1127	1393
7	2	6	82.4	1605	1282	-
8	2	6	74	1108	1691	-
9	3	6	85.7	1486	1976	1212
10						
11						
12						
13						
14						
15						
16						
17						
18						
19						
20						

Long Pulse Radar Test Signal

Test Signal Name: LP_Signal_13

Number of Bursts in Trial: 12

Burst	Pulses per Burst	Chrip (MHz)	Pulse Width(us)	PRI-1 (us)	PRI-2 (us)	PRI-3 (us)
1	3	11	94.4	1385	1336	1376
2	1	11	53	1805	-	-
3	2	11	70	1248	1558	-
4	3	11	87.6	1403	1170	1315
5	1	11	61.7	1042	-	-
6	2	11	83.2	1100	1535	-
7	1	11	66.6	1038	-	-
8	1	11	55.1	1423	-	-
9	3	11	87	1789	1306	1643
10	1	11	66.4	1409	-	-
11	2	11	80	1319	1094	-
12	3	11	85.6	1891	1291	1529
13						
14						
15						
16						
17						
18						
19						
20						



Long Pulse Radar Test Signal

Test Signal Name: LP_Signal_14

Number of Bursts in Trial: 19

Burst	Pulses per Burst	Chrip (MHz)	Pulse Width(us)	PRI-1 (us)	PRI-2 (us)	PRI-3 (us)
1	2	18	78.9	1613	1263	-
2	3	18	96.7	1627	1432	1986
3	3	18	91.5	1472	1759	1784
4	2	18	75.4	1274	1795	-
5	2	18	71.1	1968	1444	-
6	2	18	77.5	1588	1441	-
7	1	18	65.4	1710	-	-
8	1	18	53.1	1419	-	-
9	1	18	59.9	1518	-	-
10	2	18	67.3	1195	1168	-
11	2	18	74.2	1386	1216	-
12	2	18	69	1557	1132	-
13	2	18	82.1	1987	1186	-
14	3	18	93.3	1365	1032	1728
15	2	18	83.3	1103	1568	-
16	2	18	70.3	1699	1281	-
17	1	18	57.9	1285	-	-
18	1	18	50.6	1850	-	-
19	3	18	94.3	1479	1218	1733
20						

Long Pulse Radar Test Signal

Test Signal Name: LP_Signal_15

Number of Bursts in Trial: 20

Burst	Pulses per Burst	Chrip (MHz)	Pulse Width(us)	PRI-1 (us)	PRI-2 (us)	PRI-3 (us)
1	2	20	67.5	1434	1117	-
2	2	20	67.8	1567	1773	-
3	2	20	75.9	1846	1362	-
4	2	20	68.9	1237	1818	-
5	3	20	96	1339	1796	1852
6	1	20	66.6	1289	-	-
7	2	20	78.3	1862	1856	-
8	1	20	58.9	1412	-	-
9	2	20	81.5	1113	1591	-
10	2	20	82.4	1059	1861	-
11	3	20	86.8	1797	1163	1320
12	3	20	98.5	1268	1300	1868
13	2	20	80.1	1086	1482	-
14	3	20	86.3	1860	1407	1998
15	1	20	57.2	1241	-	-
16	3	20	84.3	1808	1873	1628
17	3	20	86.8	1258	1302	1978
18	2	20	83	1690	1378	-
19	3	20	85.6	1327	1956	1311
20	3	20	99.4	1112	1815	1262

Long Pulse Radar Test Signal

Test Signal Name: LP_Signal_16

Number of Bursts in Trial: 14

Burst	Pulses per Burst	Chrip (MHz)	Pulse Width(us)	PRI-1 (us)	PRI-2 (us)	PRI-3 (us)
1	1	13	57.5	1379	-	-
2	2	13	67	1551	1620	-
3	2	13	70.9	1939	1083	-
4	2	13	75.7	1332	1476	-
5	2	13	77.1	1840	1010	-
6	2	13	78.8	1371	1618	-
7	1	13	51	1494	-	-
8	1	13	55.4	1794	-	-
9	2	13	68.5	1590	1266	-
10	3	13	100	1484	1314	1428
11	3	13	96.4	1363	1361	1292
12	3	13	97.2	1694	1480	1446
13	3	13	86.4	1447	1227	1102
14	2	13	72.1	1184	1638	-
15						
16						
17						
18						
19						
20						



Long Pulse Radar Test Signal

Test Signal Name: LP_Signal_17

Number of Bursts in Trial: 11

Burst	Pulses per Burst	Chrip (MHz)	Pulse Width(us)	PRI-1 (us)	PRI-2 (us)	PRI-3 (us)
1	1	9	62.4	1329	-	-
2	2	9	67.8	1364	1937	-
3	1	9	53	1790	-	-
4	2	9	77.8	1546	1906	-
5	3	9	95.6	1145	1743	1499
6	1	9	58.8	1199	-	-
7	3	9	92.8	1424	1408	1381
8	2	9	68.5	1340	1972	-
9	3	9	84	1607	1663	1270
10	2	9	70.8	1468	1760	-
11	2	9	73.1	1869	1515	-
12						
13						
14						
15						
16						
17						
18						
19						
20						

Long Pulse Radar Test Signal

Test Signal Name: LP_Signal_18

Number of Bursts in Trial: 13

Burst	Pulses per Burst	Chrip (MHz)	Pulse Width(us)	PRI-1 (us)	PRI-2 (us)	PRI-3 (us)
1	2	11	68.8	1504	1973	-
2	3	11	94.2	1920	1299	1467
3	2	11	82.7	1003	1351	-
4	2	11	74.8	1597	1457	-
5	1	11	58.9	1874	-	-
6	3	11	96.5	1838	1708	1328
7	3	11	87.3	1405	1271	1687
8	2	11	72.4	1200	1433	-
9	1	11	51.3	1475	-	-
10	3	11	86.8	1159	1652	1942
11	1	11	50.4	1056	-	-
12	3	11	97	1884	1876	1415
13	1	11	50.1	1519	-	-
14						
15						
16						
17						
18						
19						
20						



Long Pulse Radar Test Signal

Test Signal Name: LP_Signal_19

Number of Bursts in Trial: 10

Burst	Pulses per Burst	Chrip (MHz)	Pulse Width(us)	PRI-1 (us)	PRI-2 (us)	PRI-3 (us)
1	3	8	91.9	1301	1337	1645
2	2	8	67.2	1983	1040	-
3	1	8	65.5	1671	-	-
4	2	8	72.8	1489	1016	-
5	3	8	90.5	1552	1180	1064
6	2	8	81.6	1807	1853	-
7	3	8	86	1312	1905	1278
8	3	8	89.6	1152	1068	1832
9	1	8	62.1	1119	-	-
10	1	8	58	1234	-	-
11						
12						
13						
14						
15						
16						
17						
18						
19						
20						

Long Pulse Radar Test Signal

Test Signal Name: LP_Signal_20

Number of Bursts in Trial: 8

Burst	Pulses per Burst	Chrip (MHz)	Pulse Width(us)	PRI-1 (us)	PRI-2 (us)	PRI-3 (us)
1	2	5	73.8	1071	1915	-
2	3	5	89.5	1294	1450	1025
3	2	5	81.2	1144	1146	-
4	1	5	59	1041	-	-
5	3	5	87.5	1096	1941	1018
6	2	5	76.7	1667	1947	-
7	1	5	56.5	1573	-	-
8	3	5	89	1033	1391	1304
9						
10						
11						
12						
13						
14						
15						
16						
17						
18						
19						
20						



Long Pulse Radar Test Signal

Test Signal Name: LP_Signal_21

Number of Bursts in Trial: 14

Burst	Pulses per Burst	Chrip (MHz)	Pulse Width(us)	PRI-1 (us)	PRI-2 (us)	PRI-3 (us)
1	2	12	83.1	1762	1058	-
2	1	12	50	1739	-	-
3	1	12	52.6	1055	-	-
4	1	12	58.2	1704	-	-
5	3	12	84.6	1226	1177	1886
6	2	12	68.3	1269	1851	-
7	2	12	80.6	1814	1074	-
8	1	12	59.5	1009	-	-
9	1	12	53.4	1417	-	-
10	1	12	59.1	1431	-	-
11	2	12	74.8	1002	1394	-
12	3	12	85	1670	1755	1158
13	3	12	85.3	1307	1560	1078
14	1	12	61.9	1197	-	-
15						
16						
17						
18						
19						
20						



Long Pulse Radar Test Signal

Test Signal Name: LP_Signal_22

Number of Bursts in Trial: 17

Burst	Pulses per Burst	Chrip (MHz)	Pulse Width(us)	PRI-1 (us)	PRI-2 (us)	PRI-3 (us)
1	2	17	70.8	1022	1015	-
2	1	17	52.9	1483	-	-
3	3	17	86	1524	1308	1287
4	2	17	78.4	1821	1406	-
5	3	17	93.3	1991	1966	1290
6	2	17	70	1858	1471	-
7	2	17	78.1	1507	1705	-
8	1	17	52.4	1060	-	-
9	3	17	84.8	1859	1839	1993
10	3	17	83.5	1150	1492	1443
11	1	17	56.7	1208	-	-
12	3	17	86.2	1674	1125	1053
13	1	17	58.8	1436	-	-
14	3	17	85.4	1686	1509	1577
15	2	17	77.7	1297	1298	-
16	3	17	87.4	1649	1894	1075
17	3	17	99.8	1185	1167	1616
18						
19						
20						

Long Pulse Radar Test Signal

Test Signal Name: LP_Signal_23

Number of Bursts in Trial: 12

Burst	Pulses per Burst	Chrip (MHz)	Pulse Width(us)	PRI-1 (us)	PRI-2 (us)	PRI-3 (us)
1	3	10	95.7	1353	1813	1028
2	3	10	94.9	1735	1994	1084
3	3	10	97.9	1354	1792	1418
4	2	10	67.4	1348	1008	-
5	3	10	96.9	1916	1425	1283
6	3	10	97.6	1384	1050	1569
7	3	10	83.6	1231	1219	1194
8	2	10	82.6	1128	1346	-
9	3	10	97.2	1142	1769	1173
10	3	10	92.3	1181	1164	1458
11	2	10	80.9	1222	1756	-
12	2	10	78.1	1190	1999	-
13						
14						
15						
16						
17						
18						
19						
20						

Long Pulse Radar Test Signal

Test Signal Name: LP_Signal_24

Number of Bursts in Trial: 8

Burst	Pulses per Burst	Chrip (MHz)	Pulse Width(us)	PRI-1 (us)	PRI-2 (us)	PRI-3 (us)
1	2	5	76.9	1564	1767	-
2	1	5	64.7	1437	-	-
3	2	5	77.1	1046	1944	-
4	2	5	72.7	1440	1374	-
5	1	5	61.9	1035	-	-
6	2	5	68.6	1205	1892	-
7	2	5	78.3	1047	1273	-
8	2	5	73.1	1426	1863	-
9						
10						
11						
12						
13						
14						
15						
16						
17						
18						
19						
20						

Long Pulse Radar Test Signal

Test Signal Name: LP_Signal_25

Number of Bursts in Trial: 16

Burst	Pulses per Burst	Chrip (MHz)	Pulse Width(us)	PRI-1 (us)	PRI-2 (us)	PRI-3 (us)
1	1	15	59.1	1718	-	-
2	3	15	83.5	1070	1129	1318
3	3	15	86.5	1176	1253	1442
4	1	15	60.8	1209	-	-
5	2	15	80.7	2000	1360	-
6	1	15	65.2	1101	-	-
7	2	15	69.1	1511	1030	-
8	1	15	51.5	1161	-	-
9	3	15	98.5	1061	1951	1812
10	1	15	59.5	1325	-	-
11	3	15	95.3	1284	1650	1169
12	2	15	81.8	1460	1077	-
13	1	15	66	1149	-	-
14	1	15	59.3	1373	-	-
15	2	15	79.2	1836	1534	-
16	3	15	90.2	1455	1738	1490
17						
18						
19						
20						

Long Pulse Radar Test Signal

Test Signal Name: LP_Signal_26

Number of Bursts in Trial: 13

Burst	Pulses per Burst	Chrip (MHz)	Pulse Width(us)	PRI-1 (us)	PRI-2 (us)	PRI-3 (us)
1	3	11	87.5	1343	1331	1313
2	3	11	94.6	1448	1543	1803
3	2	11	73.9	1722	1514	-
4	1	11	55.4	1506	-	-
5	1	11	52.3	1960	-	-
6	3	11	95.8	1240	1380	1252
7	3	11	96.1	1372	1411	1908
8	2	11	77.8	1885	1593	-
9	3	11	97.2	1021	1614	1633
10	2	11	74.3	1582	1097	-
11	1	11	57.9	1031	-	-
12	2	11	68.8	1927	1936	-
13	2	11	79.6	1857	1470	-
14						
15						
16						
17						
18						
19						
20						

Long Pulse Radar Test Signal

Test Signal Name: LP_Signal_27

Number of Bursts in Trial: 9

Burst	Pulses per Burst	Chrip (MHz)	Pulse Width(us)	PRI-1 (us)	PRI-2 (us)	PRI-3 (us)
1	1	7	63.4	1595	-	-
2	3	7	97	1451	1660	1562
3	2	7	66.7	1116	1544	-
4	3	7	99.5	1553	1526	1768
5	1	7	64.3	1107	-	-
6	3	7	90.7	1992	1626	1899
7	1	7	62.1	1630	-	-
8	1	7	58.3	1676	-	-
9	3	7	87	1726	1696	1464
10						
11						
12						
13						
14						
15						
16						
17						
18						
19						
20						

Long Pulse Radar Test Signal

Test Signal Name: LP_Signal_28

Number of Bursts in Trial: 9

Burst	Pulses per Burst	Chrip (MHz)	Pulse Width(us)	PRI-1 (us)	PRI-2 (us)	PRI-3 (us)
1	3	6	86.8	1673	1383	1653
2	2	6	81.7	1841	1911	-
3	2	6	78.4	1900	1229	-
4	2	6	82.1	1527	1072	-
5	3	6	84.1	1893	1742	1491
6	3	6	87.7	1247	1341	1955
7	3	6	97	1559	1685	1572
8	3	6	99.1	1641	1727	1848
9	1	6	62	1245	-	-
10						
11						
12						
13						
14						
15						
16						
17						
18						
19						
20						

Long Pulse Radar Test Signal

Test Signal Name: LP_Signal_29

Number of Bursts in Trial: 8

Burst	Pulses per Burst	Chrip (MHz)	Pulse Width(us)	PRI-1 (us)	PRI-2 (us)	PRI-3 (us)
1	2	6	67.5	1193	1182	-
2	3	6	85.6	1221	1741	1338
3	3	6	86.9	1580	1775	1809
4	3	6	85.3	1082	1854	1095
5	2	6	67.3	1898	1977	-
6	3	6	94.8	1791	1350	1230
7	2	6	72.9	1681	1323	-
8	2	6	70.7	1709	1123	-
9						
10						
11						
12						
13						
14						
15						
16						
17						
18						
19						

Long Pulse Radar Test Signal

Test Signal Name: LP_Signal_30

Number of Bursts in Trial: 10

Burst	Pulses per Burst	Chrip (MHz)	Pulse Width(us)	PRI-1 (us)	PRI-2 (us)	PRI-3 (us)
1	1	8	63.3	1044	-	-
2	3	8	87.4	1945	1602	1203
3	1	8	58.7	1556	-	-
4	1	8	63.6	1598	-	-
5	1	8	56.3	1110	-	-
6	1	8	57.2	1878	-	-
7	1	8	50.3	1659	-	-
8	2	8	71.9	1143	1724	-
9	3	8	85.1	1404	1715	1449
10	1	8	62.5	1276	-	-
11						
12						
13						
14						
15						
16						
17						
18						
19						
20						

A.2 The Frequency Hopping Radar pattern

Hopping Frequency Sequence Name: HOP_FREQ_SEQ_01

Frequency (MHz)	0	1	2	3	4
0	5684	5647	5388	5528	5616
5	5491	5605	5502	5588	5683
10	5313	5430	5420	5521	5622
15	5292	5485	5489	5387	5265
20	5419	5271	5508	5386	5410
25	5494	5600	5471	5711	5584
30	5719	5342	5361	5308	5639
35	5397	5580	5664	5667	5349
40	5290	5541	5665	5322	5585
45	5501	5330	5264	5350	5718
50	5447	5378	5340	5445	5285
55	5389	5252	5368	5469	5713
60	5384	5516	5254	5689	5318
65	5416	5459	5607	5475	5514
70	5630	5542	5263	5379	5455
75	5411	5550	5617	5554	5708
80	5688	5619	5604	5258	5695
85	5559	5301	5690	5596	5537
90	5701	5448	5611	5658	5338
95	5525	5327	5413	5555	5546

Hopping Frequency Sequence Name: HOP_FREQ_SEQ_02

Frequency (MHz)	0	1	2	3	4
0	5464	5411	5324	5689	5458
5	5630	5530	5577	5276	5415
10	5719	5316	5461	5619	5643
15	5380	5612	5592	5432	5554
20	5427	5340	5449	5475	5383
25	5382	5549	5674	5437	5618
30	5286	5706	5318	5523	5595
35	5264	5293	5460	5442	5263
40	5604	5624	5603	5562	5582
45	5430	5310	5347	5311	5296
50	5712	5254	5516	5496	5374
55	5687	5574	5556	5423	5331
60	5581	5487	5379	5723	5285
65	5650	5298	5463	5666	5337
70	5541	5548	5538	5668	5260
75	5526	5677	5586	5376	5669
80	5299	5277	5289	5255	5462
85	5384	5361	5407	5588	5474
90	5681	5395	5482	5396	5670
95	5355	5580	5700	5295	5658



Hopping Frequency Sequence Name: HOP_FREQ_SEQ_03

Frequency (MHz)	0	1	2	3	4
0	5719	5650	5260	5278	5678
5	5672	5552	5652	5439	5622
10	5580	5502	5339	5664	5371
15	5264	5695	5477	5271	5338
20	5506	5487	5467	5356	5648
25	5401	5402	5541	5425	5692
30	5275	5263	5565	5415	5306
35	5384	5256	5595	5540	5707
40	5327	5579	5359	5668	5430
45	5369	5252	5599	5605	5547
50	5560	5510	5518	5269	5280
55	5521	5400	5458	5512	5544
60	5305	5555	5586	5596	5499
65	5412	5689	5607	5344	5620
70	5524	5293	5636	5697	5422
75	5551	5337	5405	5441	5352
80	5610	5365	5701	5324	5429
85	5542	5722	5272	5498	5419
90	5304	5372	5635	5723	5598
95	5274	5286	5564	5281	5589

Hopping Frequency Sequence Name: HOP_FREQ_SEQ_04

Frequency (MHz)	0	1	2	3	4
0	5499	5414	5671	5439	5520
5	5714	5477	5252	5505	5451
10	5484	5369	5543	5534	5685
15	5459	5391	5323	5425	5463
20	5346	5575	5428	5556	5329
25	5536	5350	5605	5645	5686
30	5467	5581	5707	5381	5717
35	5710	5445	5475	5624	5273
40	5663	5379	5412	5479	5470
45	5673	5666	5648	5513	5427
50	5305	5389	5481	5393	5598
55	5649	5711	5365	5457	5709
60	5694	5332	5641	5250	5387
65	5509	5542	5700	5361	5424
70	5622	5314	5510	5296	5336
75	5478	5595	5342	5565	5631
80	5328	5447	5661	5508	5415
85	5724	5330	5640	5287	5297
90	5593	5495	5567	5504	5453
95	5635	5316	5486	5690	5376



Hopping Frequency Sequence Name: HOP_FREQ_SEQ_05

Frequency (MHz)	0	1	2	3	4
0	5657	5653	5607	5600	5265
5	5378	5499	5327	5668	5658
10	5415	5633	5681	5254	5706
15	5547	5421	5329	5470	5655
20	5354	5266	5369	5645	5302
25	5677	5333	5274	5720	5509
30	5664	5596	5491	5433	5584
35	5566	5420	5426	5577	5693
40	5495	5320	5710	5670	5595
45	5628	5388	5358	5276	5260
50	5569	5649	5263	5534	5309
55	5663	5513	5303	5295	5399
60	5316	5335	5488	5523	5310
65	5256	5294	5425	5386	5496
70	5299	5660	5454	5554	5462
75	5708	5612	5580	5460	5442
80	5672	5478	5624	5525	5268
85	5482	5347	5411	5262	5646
90	5290	5701	5510	5390	5503
95	5270	5313	5610	5492	5485

Hopping Frequency Sequence Name: HOP_FREQ_SEQ_06

Frequency (MHz)	0	1	2	3	4
0	5437	5417	5543	5286	5582
5	5420	5424	5402	5356	5390
10	5346	5422	5722	5449	5252
15	5635	5548	5432	5515	5372
20	5265	5335	5407	5637	5275
25	5690	5529	5439	5475	5279
30	5551	5456	5621	5336	5643
35	5253	5626	5657	5691	5676
40	5491	5532	5578	5258	5667
45	5427	5608	5301	5446	5411
50	5541	5611	5270	5700	5352
55	5357	5631	5358	5617	5616
60	5710	5274	5327	5564	5712
65	5623	5636	5531	5724	5259
70	5466	5661	5606	5555	5579
75	5399	5509	5333	5513	5268
80	5485	5570	5698	5361	5638
85	5342	5646	5324	5310	5506
90	5605	5598	5419	5585	5391
95	5516	5302	5534	5520	5325



Hopping Frequency Sequence Name: HOP_FREQ_SEQ_07

Frequency (MHz)	0	1	2	3	4
0	5692	5656	5479	5447	5327
5	5462	5446	5477	5519	5694
10	5655	5308	5288	5547	5273
15	5723	5675	5535	5560	5564
20	5501	5348	5251	5578	5478
25	5642	5579	5313	5690	5345
30	5551	5417	5451	5290	5370
35	5487	5354	5502	5468	5283
40	5671	5618	5664	5356	5588
45	5384	5504	5464	5428	5276
50	5441	5575	5449	5571	5331
55	5529	5720	5456	5254	5657
60	5455	5559	5683	5652	5298
65	5409	5627	5565	5402	5358
70	5309	5472	5615	5605	5422
75	5609	5680	5525	5701	5537
80	5646	5263	5698	5473	5552
85	5667	5556	5619	5361	5562
90	5546	5380	5281	5287	5471
95	5503	5649	5548	5607	5467

Hopping Frequency Sequence Name: HOP_FREQ_SEQ_08

Frequency (MHz)	0	1	2	3	4
0	5472	5420	5415	5608	5644
5	5504	5371	5552	5585	5426
10	5586	5572	5329	5267	5294
15	5714	5327	5638	5508	5281
20	5667	5289	5718	5696	5369
25	5330	5370	5683	5347	5257
30	5709	5535	5669	5569	5271
35	5429	5461	5380	5507	5416
40	5307	5366	5609	5383	5661
45	5285	5568	5467	5465	5517
50	5693	5266	5622	5627	5381
55	5422	5637	5525	5521	5348
60	5594	5419	5602	5287	5385
65	5423	5273	5632	5688	5251
70	5687	5699	5551	5502	5431
75	5584	5250	5468	5652	5260
80	5592	5615	5549	5580	5333
85	5438	5506	5440	5603	5721
90	5625	5395	5444	5655	5651
95	5435	5362	5660	5353	5326



Hopping Frequency Sequence Name: HOP_FREQ_SEQ_09

Frequency (MHz)	0	1	2	3	4
0	5252	5659	5351	5294	5389
5	5643	5393	5627	5273	5633
10	5517	5361	5370	5462	5315
15	5327	5454	5266	5553	5473
20	5667	5261	5332	5669	5257
25	5279	5573	5312	5381	5299
30	5695	5492	5409	5343	5469
35	5568	5552	5651	5282	5330
40	5621	5449	5547	5623	5280
45	5592	5451	5550	5523	5580
50	5617	5323	5378	5716	5679
55	5366	5350	5479	5614	5545
60	5565	5714	5584	5594	5308
65	5466	5571	5581	5340	5618
70	5490	5537	5505	5434	5390
75	5611	5541	5328	5516	5281
80	5612	5452	5519	5510	5306
85	5557	5688	5326	5411	5631
90	5704	5289	5668	5346	5558
95	5429	5521	5657	5436	5339

Hopping Frequency Sequence Name: HOP_FREQ_SEQ_10

Frequency (MHz)	0	1	2	3	4
0	5410	5423	5287	5358	5706
5	5685	5318	5702	5436	5462
10	5351	5625	5411	5657	5336
15	5415	5484	5272	5598	5675
20	5427	5268	5324	5642	5523
25	5606	5301	5513	5438	5584
30	5449	5624	5495	5289	5610
35	5643	5447	5435	5341	5460
40	5532	5485	5388	5277	5521
45	5431	5633	5581	5526	5370
50	5493	5499	5429	5330	5502
55	5688	5538	5433	5329	5364
60	5536	5368	5274	5589	5609
65	5412	5297	5530	5663	5550
70	5413	5293	5465	5620	5605
75	5283	5712	5349	5425	5490
80	5614	5445	5512	5269	5452
85	5361	5356	5271	5511	5461
90	5621	5576	5637	5366	5586
95	5545	5553	5689	5719	5648



Hopping Frequency Sequence Name: HOP_FREQ_SEQ_11

Frequency (MHz)	0	1	2	3	4
0	5665	5662	5698	5519	5451
5	5252	5340	5302	5599	5669
10	5282	5414	5452	5377	5357
15	5503	5611	5375	5643	5479
20	5683	5496	5684	5413	5615
25	5411	5458	5407	5617	5449
30	5480	5473	5406	5364	5269
35	5584	5274	5259	5588	5255
40	5299	5712	5423	5531	5353
45	5716	5542	5579	5257	5369
50	5675	5419	5325	5632	5251
55	5387	5658	5507	5400	5439
60	5534	5355	5435	5358	5498
65	5602	5382	5305	5474	5634
70	5606	5608	5607	5688	5308
75	5394	5513	5595	5570	5553
80	5609	5575	5509	5464	5678
85	5416	5614	5562	5709	5344
90	5266	5468	5410	5702	5600
95	5668	5635	5442	5372	5385

Hopping Frequency Sequence Name: HOP_FREQ_SEQ_12

Frequency (MHz)	0	1	2	3	4
0	5445	5523	5634	5680	5293
5	5294	5265	5377	5665	5401
10	5591	5300	5493	5475	5378
15	5494	5263	5478	5671	5594
20	5662	5722	5405	5588	5677
25	5407	5610	5721	5483	5522
30	5459	5363	5482	5421	5307
35	5413	5447	5611	5644	5710
40	5320	5361	5296	5271	5282
45	5391	5324	5600	5632	5623
50	5376	5531	5605	5479	5439
55	5341	5709	5477	5381	5529
60	5604	5358	5304	5321	5428
65	5638	5689	5575	5277	5706
70	5592	5708	5456	5567	5267
75	5266	5633	5371	5576	5347
80	5561	5334	5676	5506	5659
85	5258	5617	5379	5514	5579
90	5516	5542	5431	5337	5253
95	5519	5655	5395	5349	5647



Hopping Frequency Sequence Name: HOP_FREQ_SEQ_13

Frequency (MHz)	0	1	2	3	4
0	5700	5287	5570	5366	5513
5	5433	5452	5353	5705	5522
10	5564	5631	5670	5399	5582
15	5390	5581	5636	5388	5602
20	5256	5663	5494	5561	5565
25	5259	5338	5350	5517	5661
30	5348	5320	5697	5552	5538
35	5407	5516	5655	5549	5403
40	5677	5536	5268	5686	5371
45	5658	5685	5409	5499	5455
50	5694	5349	5423	5530	5295
55	5424	5674	5352	5294	5659
60	5347	5377	5370	5555	5400
65	5675	5711	5683	5543	5701
70	5710	5278	5514	5557	5502
75	5671	5590	5365	5323	5503
80	5379	5258	5459	5439	5706
85	5447	5567	5633	5362	5596
90	5277	5610	5531	5358	5722
95	5529	5460	5465	5334	5319

Hopping Frequency Sequence Name: HOP_FREQ_SEQ_14

Frequency (MHz)	0	1	2	3	4
0	5383	5526	5506	5527	5355
5	5475	5687	5516	5437	5453
10	5353	5672	5390	5420	5670
15	5517	5684	5681	5580	5610
20	5422	5604	5486	5534	5356
25	5683	5541	5551	5703	5334
30	5277	5347	5325	5594	5629
35	5678	5669	5569	5388	5583
40	5615	5301	5362	5518	5351
45	5490	5619	5263	5674	5375
50	5631	5633	5308	5647	5270
55	5718	5724	5614	5493	5323
60	5312	5459	5466	5423	5485
65	5293	5345	5326	5613	5256
70	5262	5358	5472	5661	5714
75	5532	5519	5660	5582	5398
80	5657	5538	5279	5371	5529
85	5386	5500	5574	5636	5402
90	5412	5521	5406	5560	5286
95	5283	5395	5640	5290	5363



Hopping Frequency Sequence Name: HOP_FREQ_SEQ_15

Frequency (MHz)	0	1	2	3	4
0	5638	5290	5442	5688	5575
5	5517	5709	5602	5679	5644
10	5287	5617	5713	5585	5441
15	5283	5547	5690	5629	5297
20	5521	5491	5545	5507	5719
25	5535	5269	5655	5270	5698
30	5652	5596	5620	5258	5720
35	5571	5444	5483	5702	5666
40	5553	5359	5447	5331	5573
45	5677	5316	5561	5251	5332
50	5684	5397	5470	5689	5431
55	5581	5329	5312	5294	5624
60	5411	5255	5408	5714	5546
65	5275	5649	5466	5532	5636
70	5641	5647	5339	5381	5495
75	5619	5551	5421	5703	5616
80	5531	5319	5627	5693	5449
85	5497	5391	5539	5715	5462
90	5518	5280	5572	5654	5380
95	5451	5289	5342	5277	5274

Hopping Frequency Sequence Name: HOP_FREQ_SEQ_16

Frequency (MHz)	0	1	2	3	4
0	5418	5529	5378	5374	5417
5	5559	5634	5677	5270	5473
10	5693	5406	5279	5305	5462
15	5274	5674	5318	5489	5657
20	5583	5567	5480	5607	5387
25	5375	5284	5619	5409	5587
30	5666	5295	5273	5343	5397
35	5336	5367	5597	5638	5491
40	5684	5356	5689	5656	5260
45	5272	5351	5505	5508	5293
50	5536	5535	5422	5509	5643
55	5314	5562	5709	5282	5369
60	5699	5588	5298	5424	5342
65	5713	5633	5705	5471	5578
70	5520	5541	5371	5308	5332
75	5408	5285	5512	5586	5539
80	5557	5425	5710	5720	5526
85	5427	5616	5392	5286	5400
90	5428	5513	5675	5676	5653
95	5495	5304	5724	5315	5698



Hopping Frequency Sequence Name: HOP_FREQ_SEQ_17

Frequency (MHz)	0	1	2	3	4
0	5673	5293	5314	5535	5637
5	5698	5656	5277	5433	5680
10	5624	5292	5320	5403	5483
15	5362	5326	5421	5719	5681
20	5537	5251	5524	5453	5398
25	5336	5578	5388	5556	5451
30	5573	5623	5510	5522	5638
35	5439	5427	5275	5408	5477
40	5357	5429	5449	5353	5683
45	5669	5264	5696	5325	5713
50	5381	5684	5311	5672	5494
55	5480	5332	5489	5612	5328
60	5614	5602	5479	5301	5394
65	5632	5703	5570	5648	5508
70	5694	5620	5310	5716	5442
75	5457	5350	5392	5661	5417
80	5560	5664	5306	5496	5485
85	5330	5588	5577	5675	5313
90	5419	5395	5523	5455	5412
95	5411	5303	5399	5273	5707

Hopping Frequency Sequence Name: HOP_FREQ_SEQ_18

Frequency (MHz)	0	1	2	3	4
0	5453	5532	5250	5599	5479
5	5265	5581	5352	5596	5412
10	5458	5556	5361	5598	5504
15	5450	5524	5289	5495	5448
20	5417	5465	5648	5426	5286
25	5663	5306	5492	5590	5493
30	5462	5580	5296	5578	5615
35	5531	5525	5322	5316	5537
40	5367	5592	5350	5612	5649
45	5347	5279	5378	5503	5257
50	5385	5362	5317	5327	5520
55	5443	5622	5585	5256	5644
60	5343	5701	5393	5597	5660
65	5340	5586	5423	5702	5445
70	5326	5496	5560	5559	5337
75	5552	5613	5260	5391	5501
80	5345	5338	5522	5553	5374
85	5404	5301	5407	5540	5510
90	5309	5705	5406	5368	5444
95	5294	5313	5275	5519	5654



Hopping Frequency Sequence Name: HOP_FREQ_SEQ_19

Frequency (MHz)	0	1	2	3	4
0	5611	5296	5661	5285	5699
5	5307	5603	5427	5284	5619
10	5389	5345	5402	5318	5525
15	5538	5580	5627	5712	5687
20	5456	5583	5503	5262	5399
25	5552	5612	5509	5693	5624
30	5535	5351	5537	5368	5448
35	5656	5717	5706	5327	5678
40	5711	5630	5620	5305	5357
45	5444	5629	5430	5337	5431
50	5390	5608	5561	5413	5375
55	5615	5271	5708	5397	5517
60	5441	5556	5385	5334	5288
65	5595	5594	5546	5599	5550
70	5381	5701	5551	5688	5545
75	5302	5455	5426	5606	5540
80	5492	5565	5323	5388	5696
85	5655	5411	5617	5421	5582
90	5416	5539	5410	5516	5557
95	5477	5682	5587	5417	5366

Hopping Frequency Sequence Name: HOP_FREQ_SEQ_20

Frequency (MHz)	0	1	2	3	4
0	5391	5535	5597	5446	5444
5	5349	5625	5502	5447	5448
10	5698	5609	5540	5513	5546
15	5529	5610	5633	5282	5404
20	5464	5652	5254	5372	5440
25	5712	5322	5658	5674	5337
30	5494	5583	5697	5476	5381
35	5598	5356	5722	5469	5703
40	5621	5441	5373	5395	5484
45	5655	5387	5262	5438	5593
50	5324	5351	5707	5638	5430
55	5514	5596	5708	5462	5682
60	5320	5495	5635	5382	5651
65	5504	5720	5548	5479	5278
70	5414	5677	5449	5274	5521
75	5269	5675	5482	5369	5483
80	5385	5723	5594	5471	5334
85	5386	5536	5614	5704	5416
90	5318	5443	5574	5620	5461
95	5580	5566	5612	5615	5393



Hopping Frequency Sequence Name: HOP_FREQ_SEQ_21

Frequency (MHz)	0	1	2	3	4
0	5646	5299	5533	5607	5286
5	5488	5550	5577	5513	5655
10	5629	5398	5581	5708	5567
15	5617	5262	5261	5327	5596
20	5375	5343	5385	5345	5706
25	5316	5426	5692	5716	5701
30	5451	5323	5374	5674	5423
35	5413	5394	5606	5636	5405
40	5408	5559	5362	5438	5680
45	5589	5356	5537	5542	5263
50	5515	5650	5639	5512	5305
55	5422	5457	5401	5643	5275
60	5294	5508	5584	5618	5444
65	5574	5592	5543	5685	5317
70	5282	5551	5328	5254	5373
75	5549	5569	5320	5502	5521
80	5310	5546	5285	5626	5436
85	5434	5526	5490	5620	5519
90	5255	5325	5637	5688	5675
95	5478	5448	5338	5556	5605

Hopping Frequency Sequence Name: HOP_FREQ_SEQ_22

Frequency (MHz)	0	1	2	3	4
0	5426	5538	5469	5293	5506
5	5530	5572	5652	5676	5387
10	5560	5662	5622	5331	5588
15	5705	5389	5364	5372	5313
20	5383	5412	5423	5335	5318
25	5594	5265	5546	5251	5283
30	5590	5408	5623	5494	5562
35	5504	5287	5284	5550	5719
40	5491	5497	5505	5435	5609
45	5472	5679	5414	5493	5332
50	5614	5566	5264	5462	5384
55	5700	5259	5612	5276	5675
60	5451	5695	5601	5431	5344
65	5393	5610	5424	5338	5488
70	5486	5268	5651	5555	5518
75	5689	5463	5483	5298	5323
80	5519	5697	5282	5428	5626
85	5278	5621	5694	5541	5632
90	5559	5525	5289	5585	5271
95	5255	5526	5376	5427	5721



Hopping Frequency Sequence Name: HOP_FREQ_SEQ_23

Frequency (MHz)	0	1	2	3	4
0	5584	5302	5405	5454	5348
5	5572	5497	5252	5364	5691
10	5394	5548	5663	5526	5609
15	5318	5516	5467	5320	5505
20	5391	5578	5424	5291	5482
25	5592	5274	5256	5285	5422
30	5576	5365	5656	5300	5692
35	5701	5558	5437	5561	5574
40	5435	5270	5432	5538	5452
45	5287	5472	5546	5694	5393
50	5315	5617	5353	5328	5413
55	5688	5705	5473	5721	5329
60	5616	5640	5433	5257	5573
65	5642	5342	5646	5634	5254
70	5654	5404	5390	5334	5606
75	5464	5550	5386	5672	5279
80	5623	5529	5457	5338	5562
85	5495	5641	5355	5724	5531
90	5380	5722	5310	5510	5371
95	5406	5349	5356	5649	

Hopping Frequency Sequence Name: HOP_FREQ_SEQ_24

Frequency (MHz)	0	1	2	3	4
0	5364	5541	5341	5615	5568
5	5614	5519	5327	5527	5423
10	5325	5337	5704	5721	5630
15	5309	5643	5570	5365	5697
20	5302	5647	5305	5416	5264
25	5273	5477	5360	5319	5464
30	5465	5322	5396	5549	5512
35	5268	5308	5354	5687	5475
40	5397	5657	5373	5510	5526
45	5370	5432	5433	5599	5484
50	5269	5491	5668	5442	5583
55	5650	5601	5642	5420	5292
60	5692	5458	5306	5585	5362
65	5558	5368	5291	5466	5500
70	5569	5252	5715	5279	5253
75	5560	5250	5359	5357	5652
80	5542	5705	5543	5556	5453
85	5276	5440	5534	5517	5546
90	5414	5537	5260	5392	5591
95	5288	5452	5554	5408	5660



Hopping Frequency Sequence Name: HOP_FREQ_SEQ_25

Frequency (MHz)	0	1	2	3	4
0	5619	5305	5277	5679	5410
5	5278	5444	5402	5593	5630
10	5256	5601	5270	5441	5651
15	5397	5673	5576	5511	5310
20	5338	5343	5505	5712	5636
25	5393	5680	5464	5353	5506
30	5451	5279	5611	5701	5710
35	5407	5399	5722	5365	5389
40	5333	5362	5311	5275	5523
45	5299	5412	5453	5491	5652
50	5371	5620	5667	5719	5628
55	5309	5594	5314	5596	5610
60	5586	5663	5587	5471	5627
65	5669	5481	5465	5666	5715
70	5621	5676	5295	5372	5324
75	5323	5282	5577	5536	5684
80	5328	5477	5320	5482	5556
85	5337	5617	5420	5273	5635
90	5432	5376	5480	5625	5395
95	5500	5662	5373	5579	5640

Hopping Frequency Sequence Name: HOP_FREQ_SEQ_26

Frequency (MHz)	0	1	2	3	4
0	5399	5544	5688	5365	5630
5	5320	5466	5477	5281	5459
10	5565	5390	5311	5636	5672
15	5485	5325	5679	5455	5703
20	5318	5407	5284	5497	5685
25	5427	5720	5408	5568	5387
30	5645	5340	5711	5351	5475
35	5530	5546	5490	5518	5400
40	5647	5445	5724	5418	5520
45	5606	5392	5536	5549	5705
50	5496	5368	5295	5717	5607
55	5441	5405	5550	5634	5716
60	5572	5501	5307	5411	5286
65	5657	5508	5662	5553	5493
70	5309	5382	5329	5512	5643
75	5675	5597	5366	5504	5259
80	5666	5593	5306	5483	5648
85	5355	5335	5315	5540	5342
90	5360	5551	5435	5668	5269
95	5646	5706	5394	5610	5395



Hopping Frequency Sequence Name: HOP_FREQ_SEQ_27

Frequency (MHz)	0	1	2	3	4
0	5557	5405	5624	5526	5472
5	5362	5391	5552	5444	5666
10	5496	5654	5352	5259	5693
15	5573	5452	5307	5403	5420
20	5704	5700	5586	5658	5315
25	5669	5514	5294	5421	5687
30	5668	5469	5627	5350	5685
35	5581	5314	5293	5486	5528
40	5662	5517	5535	5372	5619
45	5510	5283	5523	5275	5544
50	5346	5331	5430	5385	5593
55	5407	5515	5602	5508	5273
60	5326	5333	5608	5454	5710
65	5596	5718	5457	5356	5565
70	5295	5653	5488	5505	5644
75	5717	5509	5485	5511	5679
80	5374	5470	5643	5645	5550
85	5713	5632	5503	5437	5703
90	5683	5434	5652	5276	5622
95	5412	5530	5640	5438	5603

Hopping Frequency Sequence Name: HOP_FREQ_SEQ_28

Frequency (MHz)	0	1	2	3	4
0	5337	5644	5560	5687	5692
5	5501	5413	5627	5607	5398
10	5427	5540	5490	5454	5714
15	5564	5579	5410	5448	5612
20	5712	5264	5641	5578	5631
25	5581	5521	5717	5455	5254
30	5690	5625	5684	5401	5548
35	5252	5672	5585	5446	5703
40	5325	5611	5503	5423	5514
45	5367	5255	5702	5568	5313
50	5626	5720	5397	5420	5253
55	5707	5306	5361	5705	5421
60	5479	5402	5491	5462	5262
65	5531	5400	5416	5659	5632
70	5550	5349	5634	5637	5378
75	5485	5502	5464	5516	5362
80	5555	5466	5288	5314	5630
85	5706	5642	5270	5713	5571
90	5563	5629	5556	5359	5686
95	5599	5658	5677	5633	5256



Hopping Frequency Sequence Name: HOP_FREQ_SEQ_29

Frequency (MHz)	0	1	2	3	4
0	5592	5408	5496	5373	5534
5	5543	5338	5702	5673	5261
10	5329	5531	5649	5260	5652
15	5706	5513	5493	5720	5333
20	5679	5667	5604	5469	5470
25	5445	5502	5489	5393	5579
30	5582	5424	5553	5368	5391
35	5385	5478	5599	5714	5639
40	5316	5441	5566	5608	5296
45	5710	5310	5626	5292	5675
50	5421	5448	5509	5454	5651
55	5494	5315	5420	5715	5450
60	5656	5504	5569	5357	5346
65	5617	5571	5285	5619	5437
70	5331	5364	5488	5351	5343
75	5423	5485	5698	5447	5443
80	5411	5701	5294	5562	5616
85	5413	5526	5724	5536	5510
90	5607	5409	5289	5664	5614
95	5418	5268	5446	5640	5464

Hopping Frequency Sequence Name: HOP_FREQ_SEQ_30

Frequency (MHz)	0	1	2	3	4
0	5372	5647	5432	5534	5279
5	5585	5360	5302	5361	5434
10	5667	5593	5572	5369	5281
15	5265	5261	5519	5441	5521
20	5631	5499	5620	5659	5577
25	5357	5322	5648	5606	5523
30	5435	5468	5539	5639	5327
35	5566	5530	5476	5274	5374
40	5628	5575	5399	5379	5331
45	5605	5700	5690	5393	5587
50	5345	5465	5378	5597	5695
55	5277	5498	5682	5269	5513
60	5437	5421	5660	5346	5449
65	5401	5280	5389	5440	5557
70	5607	5592	5414	5715	5403
75	5350	5491	5675	5319	5382
80	5505	5366	5428	5390	5636
85	5282	5255	5586	5404	5561
90	5380	5704	5454	5292	5300
95	5377	5560	5689	5595	5511

--- END ---