

FCC Test Report (DFS Band)

Report No.: RF190218E06A-1

FCC ID: XCNUBC1319

Test Model: UBC1319

Received Date: May 09, 2019

Test Date: July 06 to 22, 2019

Issued Date: Dec. 10, 2019

Applicant: Ubee Interactive Corp.

Address: 10F-1, No. 5, Taiyuan 1st St. Jhubei Ci, Hsinchu County 302, Taiwan ,
R.O.C.

Issued By: Bureau Veritas Consumer Products Services (H.K.) Ltd., Taoyuan Branch
Hsin Chu Laboratory

Lab Address: E-2, No.1, Li Hsin 1st Road, Hsinchu Science Park, Hsinchu City 300,
Taiwan R.O.C.

Test Location: E-2, No.1, Li Hsin 1st Road, Hsinchu Science Park, Hsinchu City 300,
Taiwan R.O.C.

**FCC Registration /
Designation Number:** 723255 / TW2022



This report is for your exclusive use. Any copying or replication of this report to or for any other person or entity, or use of our name or trademark, is permitted only with our prior written permission. This report sets forth our findings solely with respect to the test samples identified herein. The results set forth in this report are not indicative or representative of the quality or characteristics of the lot from which a test sample was taken or any similar or identical product unless specifically and expressly noted. Our report includes all of the tests requested by you and the results thereof based upon the information that you provided to us. You have 60 days from date of issuance of this report to notify us of any material error or omission caused by our negligence, provided, however, that such notice shall be in writing and shall specifically address the issue you wish to raise. A failure to raise such issue within the prescribed time shall constitute your unqualified acceptance of the completeness of this report, the tests conducted and the correctness of the report contents. Unless specific mention, the uncertainty of measurement has been explicitly taken into account to declare the compliance or non-compliance to the specification. The report must not be used by the client to claim product certification, approval, or endorsement by TAF or any government agencies.

Table of Contents

Release Control Record	4
1 Certificate of Conformity	5
2 Summary of Test Results	6
2.1 Measurement Uncertainty	6
2.2 Modification Record	6
3 General Information	7
3.1 General Description of EUT (DFS Band)	7
3.2 Description of Test Modes	10
3.2.1 Test Mode Applicability and Tested Channel Detail	11
3.3 Duty Cycle of Test Signal	13
3.4 Description of Support Units	14
3.4.1 Configuration of System under Test	14
3.5 General Description of Applied Standard	15
4 Test Types and Results	16
4.1 Radiated Emission and Bandedge Measurement	16
4.1.1 Limits of Radiated Emission and Bandedge Measurement	16
4.1.2 Test Instruments	17
4.1.3 Test Procedure	19
4.1.4 Deviation from Test Standard	20
4.1.5 Test Setup	20
4.1.6 EUT Operating Condition	21
4.1.7 Test Results	22
4.2 Conducted Emission Measurement	48
4.2.1 Limits of Conducted Emission Measurement	48
4.2.2 Test Instruments	48
4.2.3 Test Procedure	49
4.2.4 Deviation from Test Standard	49
4.2.5 Test Setup	49
4.2.6 EUT Operating Condition	49
4.2.7 Test Results	50
4.3 Transmit Power Measurement	52
4.3.1 Limits of Transmit Power Measurement	52
4.3.2 Test Setup	52
4.3.3 Test Instruments	53
4.3.4 Test Procedure	53
4.3.5 Deviation from Test Standard	53
4.3.6 EUT Operating Condition	53
4.3.7 Test Result	54
4.4 Occupied Bandwidth Measurement	77
4.4.1 Test Setup	77
4.4.2 Test Instruments	77
4.4.3 Test Procedure	77
4.4.4 Test Results	78
4.5 Peak Power Spectral Density Measurement	83
4.5.1 Limits of Peak Power Spectral Density Measurement	83
4.5.2 Test Setup	83
4.5.3 Test Instruments	83
4.5.4 Test Procedure	83
4.5.5 Deviation from Test Standard	84
4.5.6 EUT Operating Condition	84
4.5.7 Test Results	85
4.6 Frequency Stability Measurement	92
4.6.1 Limits of Frequency Stability Measurement	92

4.6.2	Test Setup.....	92
4.6.3	Test Instruments	92
4.6.4	Test Procedure	92
4.6.5	Deviation from Test Standard	92
4.6.6	EUT Operating Condition	92
4.6.7	Test Results (Mode 1).....	93
4.7	6dB Bandwidth Measurement	94
4.7.1	Limits of 6dB Bandwidth Measurement.....	94
4.7.2	Test Setup.....	94
4.7.3	Test Instruments	94
4.7.4	Test Procedure	94
4.7.5	Deviation from Test Standard	94
4.7.6	EUT Operating Condition	94
4.7.7	Test Results	95
5	Pictures of Test Arrangements.....	97
	Appendix – Information of the Testing Laboratories	98

Release Control Record

Issue No.	Description	Date Issued
RF190218E06A-1	Original release.	Dec. 10, 2019

1 Certificate of Conformity

Product: DOCSIS 3.0 Wireless eMTA

Brand: Ubee

Test Model: UBC1319

Applicant: Ubee Interactive Corp.

Test Date: July 06 to 22, 2019

Standard: 47 CFR FCC Part 15, Subpart E (Section 15.407)
ANSI C63.10: 2013

The above equipment has been tested by **Bureau Veritas Consumer Products Services (H.K.) Ltd., Taoyuan Branch**, and found compliance with the requirement of the above standards. The test record, data evaluation & Equipment Under Test (EUT) configurations represented herein are true and accurate accounts of the measurements of the sample's EMC characteristics under the conditions specified in this report.

Prepared by :

Joyce Kuo / Specialist

, **Date:** Dec. 10, 2019

Approved by :

Clark Lin / Technical Manager

, **Date:** Dec. 10, 2019

2 Summary of Test Results

47 CFR FCC Part 15, Subpart E (Section 15.407)			
FCC Clause	Test Item	Result	Remarks
15.407(b)(6)	AC Power Conducted Emissions	Pass	Meet the requirement of limit. Minimum passing margin is -16.77dB at 8.70703MHz.
15.407(b) (1/2/3/4(i/ii)/6)	Radiated Emissions & Band Edge Measurement	Pass	Meet the requirement of limit. Minimum passing margin is -0.2dB at 5350.00MHz.
15.407(a)(1/2/3)	Max Average Transmit Power	Pass	Meet the requirement of limit.
---	Occupied Bandwidth Measurement	-	Reference only.
15.407(a)(1/2/3)	Peak Power Spectral Density	Pass	Meet the requirement of limit.
15.407(e)	6dB bandwidth	Pass	Meet the requirement of limit. (U-NII-3 Band only)
15.407(g)	Frequency Stability	Pass	Meet the requirement of limit.
15.203	Antenna Requirement	Pass	Antenna connector is i-Pex not a standard connector.

Note:

Determining compliance based on the results of the compliance measurement, not taking into account measurement instrumentation uncertainty.

2.1 Measurement Uncertainty

Where relevant, the following measurement uncertainty levels have been estimated for tests performed on the EUT as specified in CISPR 16-4-2:

Measurement	Frequency	Expanded Uncertainty (k=2) (\pm)
Conducted Emissions at mains ports	150kHz ~ 30MHz	1.8 dB
Radiated Emissions up to 1 GHz	30MHz ~ 1GHz	4.9 dB
Radiated Emissions above 1 GHz	1GHz ~ 6GHz	5.1 dB
	6GHz ~ 18GHz	4.9 dB
	18GHz ~ 40GHz	5.2 dB

2.2 Modification Record

There were no modifications required for compliance.

3 General Information

3.1 General Description of EUT (DFS Band)

Product	DOCSIS 3.0 Wireless eMTA
Brand	Ubee
Test Model	UBC1319
Power Supply Rating	12Vdc from power adapter
Modulation Type	64QAM, 16QAM, QPSK, BPSK for OFDM 256QAM for OFDM in 11ac mode
Modulation Technology	OFDM
Transfer Rate	802.11a: up to 54Mbps 802.11n: up to 600Mbps 802.11ac: up to 1733.3Mbps
Operating Frequency	5.26 ~ 5.32GHz, 5.5 ~ 5.72GHz
Number of Channel	802.11a, 802.11n (HT20), 802.11ac (VHT20): 16 802.11n (HT40), 802.11ac (VHT40): 8 802.11ac (VHT80): 4
Output Power	CDD Mode: 5.26 ~ 5.32GHz: 236.051mW 5.5 ~ 5.72GHz: 239.7mW Beamforming Mode: 5.26 ~ 5.32GHz: 118.693mW 5.5 ~ 5.72GHz: 120.268mW
Antenna Type	Refer to Note
Antenna Connector	Refer to Note
Accessory Device	Adapter x1 Base top x 1
Data Cable Supplied	NA

Note:

- This report is prepared for FCC class II permissive change. The difference compared with the Report No.: RF190218E06-1 as the following:
 - ◆ Add shielding case for CPU.
 - ◆ Add DFS band <5.26 ~ 5.32GHz, 5.5 ~ 5.72GHz>
- According to above condition, for DFS band, the all test items need to be performed. And all data were verified to meet the requirements.
- The EUT has below radios as following table:

Radio 1	Radio 2
WLAN (2.4GHz)	WLAN (5GHz)

- Simultaneously transmission condition.

Condition	Technology	
1	WLAN (2.4GHz)	WLAN (5GHz)

Note: The emission of the simultaneous operation has been evaluated and no non-compliance was found.

- The EUT must be supplied with a power adapter as following table:

Brand	Model No.	Spec.
LEADER ELECTRONICS INC	MU30AY120250-A1	AC Input: 100-240V, 0.8A, 50/60Hz DC Output: 12V, 2.5A DC Output cable: 1.8m, Unshielded

- The antennas provided to the EUT, please refer to the following table:

Antenna No	Transmitter Circuit	Antenna Net Gain (dBi)	Frequency Range (GHz)	Antenna Type	Connector Type	Cable Length (mm)
1	5GHz: Chain 0	2.93	5.15~5.25	Dipole	i-Pex	71
		2.5	5.25~5.35			
		2.04	5.47~5.725			
		2.04	5.725~5.85			
2	2.4GHz: Chain 2 5GHz: Chain 1	1.67	2.4~2.4825	Dipole	i-Pex	132
		1.99	5.15~5.25			
		3.2	5.25~5.35			
		2.99	5.47~5.725			
3	2.4GHz: Chain 1 5GHz: Chain 2	3.17	5.725~5.85	Dipole	i-Pex	110
		2.47	2.4~2.4825			
		4.22	5.15~5.25			
		3.52	5.25~5.35			
4	2.4GHz: Chain 0 5GHz: Chain 3	3.59	5.47~5.725	Dipole	i-Pex	90
		4.54	5.725~5.85			
		2.49	2.4~2.4825			
		3.82	5.15~5.25			
		2.88	5.25~5.35			
		3.64	5.47~5.725			
		3.64	5.725~5.85			

7. The EUT incorporates a MIMO function:

2.4GHz Band		
MODULATION MODE	TX & RX CONFIGURATION	
802.11b	3TX	3RX
802.11g	3TX	3RX
802.11n (HT20)	3TX	3RX
802.11n (HT40)	3TX	3RX
VHT20	3TX	3RX
VHT40	3TX	3RX
5GHz Band		
MODULATION MODE	TX & RX CONFIGURATION	
802.11a	4TX	4RX
802.11n (HT20)	4TX	4RX
802.11n (HT40)	4TX	4RX
802.11ac (VHT20)	4TX	4RX
802.11ac (VHT40)	4TX	4RX
802.11ac (VHT80)	4TX	4RX

Note:

1. All of modulation mode support beamforming function except 802.11a/b/g modulation mode.
 2. The EUT support Beamforming and CDD mode, therefore both mode were investigated and the worst case scenario was identified. The worst case data were presented in test report.
 3. The modulation and bandwidth are similar for 802.11n mode for 20MHz (40MHz) and 802.11ac mode for 20MHz (40MHz), therefore investigated worst case to representative mode in test report.
8. The above EUT information is declared by manufacturer and for more detailed features description, please refers to the manufacturer's specifications or user's manual.

3.2 Description of Test Modes

FOR 5260 ~ 5320MHz

4 channels are provided for 802.11a, 802.11n (HT20), 802.11ac (VHT20):

Channel	Frequency	Channel	Frequency
52	5260 MHz	60	5300 MHz
56	5280 MHz	64	5320 MHz

2 channels are provided for 802.11n (HT40), 802.11ac (VHT40):

Channel	Frequency	Channel	Frequency
54	5270 MHz	62	5310 MHz

1 channel is provided for 802.11ac (VHT80):

Channel	Frequency
58	5290 MHz

FOR 5500 ~ 5720MHz

12 channels are provided for 802.11a, 802.11n (HT20):

Channel	Frequency	Channel	Frequency
100	5500 MHz	124	5620 MHz
104	5520 MHz	128	5640 MHz
108	5540 MHz	132	5660 MHz
112	5560 MHz	136	5680 MHz
116	5580 MHz	140	5700 MHz
120	5600 MHz	144	5720 MHz

6 channels are provided for 802.11n (HT40):

Channel	Frequency	Channel	Frequency
102	5510 MHz	126	5630 MHz
110	5550 MHz	134	5670 MHz
118	5590 MHz	142	5710 MHz

3 channels are provided for 802.11ac (VHT80):

Channel	Frequency	Channel	Frequency
106	5530 MHz	138	5690 MHz
122	5610 MHz		

3.2.1 Test Mode Applicability and Tested Channel Detail

EUT Configure Mode	Applicable To				Description
	RE≥1G	RE<1G	PLC	APCM	
-	√	√	√	√	-

Where **RE≥1G**: Radiated Emission above 1GHz **RE<1G**: Radiated Emission below 1GHz
PLC: Power Line Conducted Emission **APCM**: Antenna Port Conducted Measurement

Radiated Emission Test (Above 1GHz):

- Pre-Scan has been conducted to determine the worst-case mode from all possible combinations between available modulations, data rates and antenna ports (if EUT with antenna diversity architecture).
- Following channel(s) was (were) selected for the final test as listed below.

CDD Mode						
Mode	FREQ. Band (MHz)	Available Channel	Tested Channel	Modulation Technology	Modulation Type	Data Rate (Mbps)
802.11a	5260-5320	52 to 64	52, 60, 64	OFDM	BPSK	6
802.11ac (VHT20)		52 to 64	52, 60, 64	OFDM	BPSK	6.5
802.11ac (VHT40)		54 to 62	54, 62	OFDM	BPSK	13.5
802.11ac (VHT80)		58	58	OFDM	BPSK	29.3
802.11a	5500-5720	100 to 144	100, 116, 140, 144	OFDM	BPSK	6
802.11ac (VHT20)		100 to 144	100, 116, 140, 144	OFDM	BPSK	6.5
802.11ac (VHT40)		102 to 142	102, 110, 134, 142	OFDM	BPSK	13.5
802.11ac (VHT80)		106 to 138	106, 122, 138	OFDM	BPSK	29.3

Radiated Emission Test (Below 1GHz):

- Pre-Scan has been conducted to determine the worst-case mode from all possible combinations between available modulations, data rates and antenna ports (if EUT with antenna diversity architecture).
- Following channel(s) was (were) selected for the final test as listed below.

CDD Mode						
Mode	FREQ. Band (MHz)	Available Channel	Tested Channel	Modulation Technology	Modulation Type	Data Rate (Mbps)
802.11ac (VHT80)	5260-5320 5500-5720	58 106 to 138	122	OFDM	BPSK	29.3

Power Line Conducted Emission Test:

- Pre-Scan has been conducted to determine the worst-case mode from all possible combinations between available modulations, data rates and antenna ports (if EUT with antenna diversity architecture).
- Following channel(s) was (were) selected for the final test as listed below.

CDD Mode						
Mode	FREQ. Band (MHz)	Available Channel	Tested Channel	Modulation Technology	Modulation Type	Data Rate (Mbps)
802.11ac (VHT80)	5260-5320 5500-5720	58 106 to 138	122	OFDM	BPSK	29.3

Antenna Port Conducted Measurement:

- This item includes all test value of each mode, but only includes spectrum plot of worst value of each mode.
- Pre-Scan has been conducted to determine the worst-case mode from all possible combinations between available modulations, data rates and antenna ports (if EUT with antenna diversity architecture).
- Following channel(s) was (were) selected for the final test as listed below.

CDD Mode						
Mode	FREQ. Band (MHz)	Available Channel	Tested Channel	Modulation Technology	Modulation Type	Data Rate (Mbps)
802.11a	5260-5320	52 to 64	52, 60, 64	OFDM	BPSK	6
802.11ac (VHT20)		52 to 64	52, 60, 64	OFDM	BPSK	6.5
802.11ac (VHT40)		54 to 62	54, 62	OFDM	BPSK	13.5
802.11ac (VHT80)		58	58	OFDM	BPSK	29.3
802.11a	5500-5720	100 to 144	100, 116, 140, 144	OFDM	BPSK	6
802.11ac (VHT20)		100 to 144	100, 116, 140, 144	OFDM	BPSK	6.5
802.11ac (VHT40)		102 to 142	102, 110, 134, 142	OFDM	BPSK	13.5
802.11ac (VHT80)		106 to 138	106, 122, 138	OFDM	BPSK	29.3
Beamforming Mode (output power only)						
Mode	FREQ. Band (MHz)	Available Channel	Tested Channel	Modulation Technology	Modulation Type	Data Rate (Mbps)
802.11ac (VHT20)	5260-5320	52 to 64	52, 60, 64	OFDM	BPSK	6.5
802.11ac (VHT40)		54 to 62	54, 62	OFDM	BPSK	13.5
802.11ac (VHT80)		58	58	OFDM	BPSK	29.3
802.11ac (VHT20)	5500-5720	100 to 144	100, 116, 140, 144	OFDM	BPSK	6.5
802.11ac (VHT40)		102 to 142	102, 110, 134, 142	OFDM	BPSK	13.5
802.11ac (VHT80)		106 to 138	106, 122, 138	OFDM	BPSK	29.3

Test Condition:

Applicable To	Environmental Conditions	Input Power	Tested By
RE \geq 1G	25deg. C, 65%RH	120Vac, 60Hz	Chris Lin
RE $<$ 1G	21deg. C, 64%RH	120Vac, 60Hz	Robert Cheng
PLC	25deg. C, 75%RH	120Vac, 60Hz	Andy Ho
APCM	25deg. C, 60%RH	120Vac, 60Hz	Jaime Lu

3.3 Duty Cycle of Test Signal

If duty cycle of test signal is $\geq 98\%$, duty factor is not required.

If duty cycle of test signal is $< 98\%$, duty factor shall be considered.

802.11a: Duty cycle = $1.47 \text{ ms} / 1.502 \text{ ms} = 0.979$, Duty factor = $10 * \log (1/\text{Duty cycle}) = 0.09$

802.11ac (VHT20): Duty cycle = $1.471 \text{ ms} / 1.508 \text{ ms} = 0.975$, Duty factor = $10 * \log (1/\text{Duty cycle}) = 0.11$

802.11ac (VHT40): Duty cycle = $1.473 \text{ ms} / 1.5 \text{ ms} = 0.982$

802.11ac (VHT80): Duty cycle = $0.459 \text{ ms} / 0.501 \text{ ms} = 0.916$, Duty factor = $10 * \log (1/\text{Duty cycle}) = 0.38$

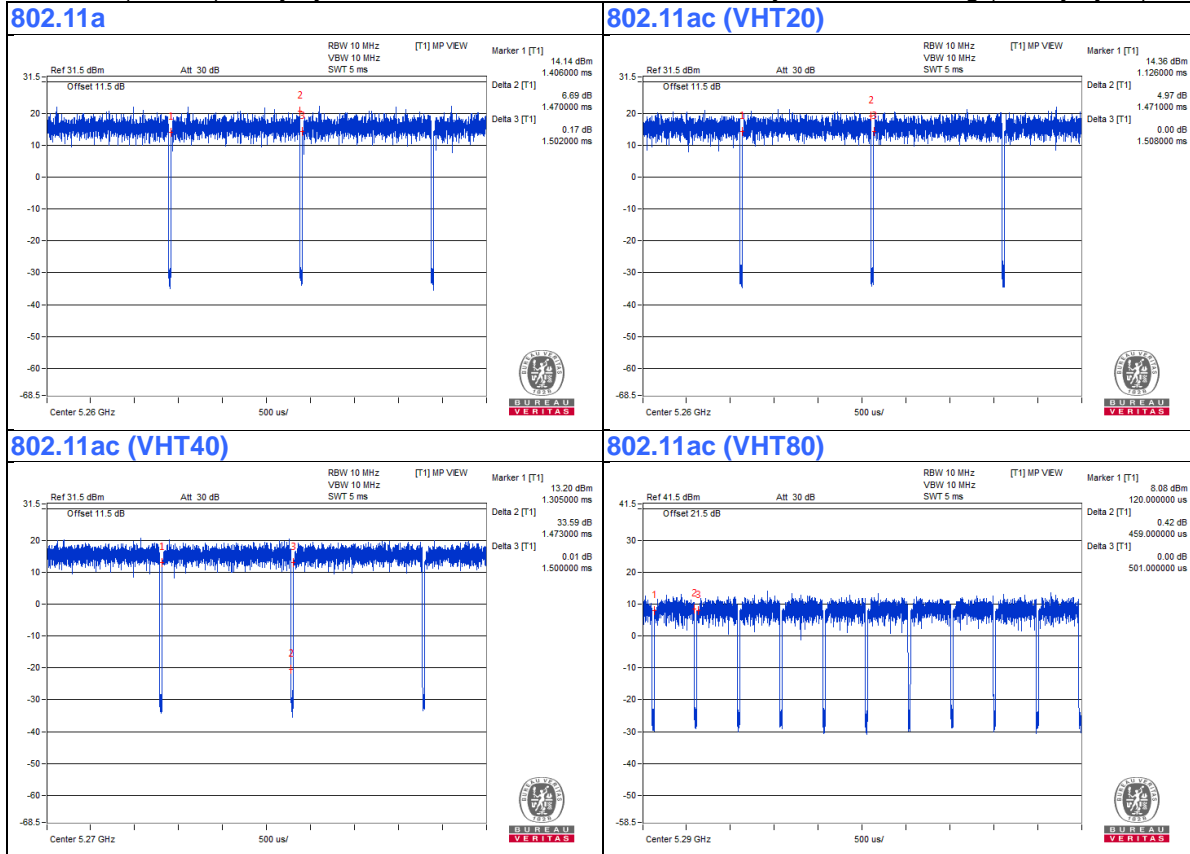

3.4 Description of Support Units

The EUT has been tested as an independent unit together with other necessary accessories or support units. The following support units or accessories were used to form a representative test configuration during the tests.

ID	Product	Brand	Model No.	Serial No.	FCC ID	Remarks
A.	Telephone	WONDER	WD-303	7C17KA 04011	NA	Provided by Lab
B.	Laptop	DELL	E5430	HYV4VY1	FCC DoC	Provided by Lab
C.	iPod	Apple	MC749TA/A	CC4DN25WDFDM	NA	Provided by Lab

Note:

1. All power cords of the above support units are non-shielded (1.8m).

ID	Descriptions	Qty.	Length (m)	Shielding (Yes/No)	Cores (Qty.)	Remarks
1.	DC Cable	1	1.8	No	0	Supplied by client
2.	RJ-11 Cable	1	10	No	0	Provided by Lab
3.	RJ-45 Cable	1	10	No	0	Provided by Lab
4.	Coaxial Cable	1	10	Yes	0	Provided by Lab
5.	USB Cable	1	0.1	Yes	0	Provided by Lab

3.4.1 Configuration of System under Test

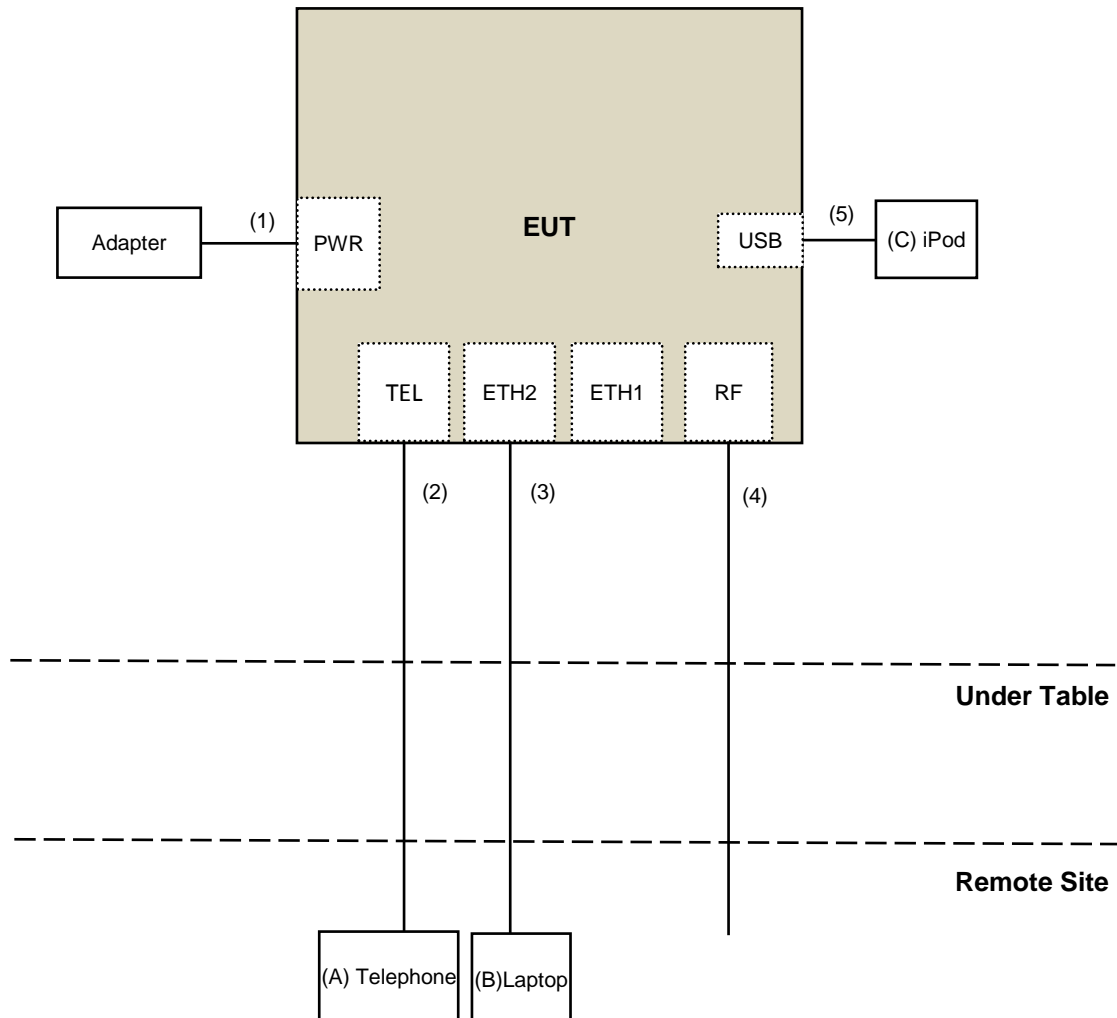

3.5 General Description of Applied Standard

The EUT is a RF Product. According to the specifications of the manufacturer, it must comply with the requirements of the following standards:

FCC Part 15, Subpart E (15.407)
KDB 789033 D02 General UNII Test Procedure New Rules v02r01
KDB 662911 D01 Multiple Transmitter Output v02r01
ANSI C63.10-2013

All test items have been performed and recorded as per the above standards.

4 Test Types and Results

4.1 Radiated Emission and Bandedge Measurement

4.1.1 Limits of Radiated Emission and Bandedge Measurement

Radiated emissions which fall in the restricted bands must comply with the radiated emission limits specified as below table.

Frequencies (MHz)	Field Strength (microvolts/meter)	Measurement Distance (meters)
0.009 ~ 0.490	2400/F(kHz)	300
0.490 ~ 1.705	24000/F(kHz)	30
1.705 ~ 30.0	30	30
30 ~ 88	100	3
88 ~ 216	150	3
216 ~ 960	200	3
Above 960	500	3

NOTE:

- The lower limit shall apply at the transition frequencies.
- Emission level (dBuV/m) = 20 log Emission level (uV/m).
- For frequencies above 1000MHz, the field strength limits are based on average detector, however, the peak field strength of any emission shall not exceed the maximum permitted average limits, specified above by more than 20dB under any condition of modulation.

Limits of unwanted emission out of the restricted bands

Applicable To		Limit	
789033 D02 General UNII Test Procedure New Rules v02r01		Field Strength at 3m	
		PK:74 (dBuV/m)	AV:54 (dBuV/m)
Frequency Band	Applicable To	EIRP Limit	Equivalent Field Strength at 3m
5150~5250 MHz	15.407(b)(1)	PK:-27 (dBm/MHz)	PK:68.2(dBuV/m)
5250~5350 MHz	15.407(b)(2)		
5470~5725 MHz	15.407(b)(3)		
5725~5850 MHz	<input checked="" type="checkbox"/> 15.407(b)(4)(i)	PK:-27 (dBm/MHz) ^{*1} PK:10 (dBm/MHz) ^{*2} PK:15.6 (dBm/MHz) ^{*3} PK:27 (dBm/MHz) ^{*4}	PK: 68.2(dBuV/m) ^{*1} PK:105.2 (dBuV/m) ^{*2} PK: 110.8(dBuV/m) ^{*3} PK:122.2 (dBuV/m) ^{*4}
	<input type="checkbox"/> 15.407(b)(4)(ii)	Emission limits in section 15.247(d)	
^{*1} beyond 75 MHz or more above of the band edge. ^{*3} below the band edge increasing linearly to a level of 15.6 dBm/MHz at 5 MHz above.		^{*2} below the band edge increasing linearly to 10 dBm/MHz at 25 MHz above. ^{*4} from 5 MHz above or below the band edge increasing linearly to a level of 27 dBm/MHz at the band edge.	

Note:

The following formula is used to convert the equipment isotropic radiated power (eirp) to field strength:

$$E = \frac{1000000\sqrt{30P}}{3} \mu\text{V/m, where P is the eirp (Watts).}$$

4.1.2 Test Instruments

DESCRIPTION & MANUFACTURER	MODEL NO.	SERIAL NO.	CALIBRATED DATE	CALIBRATED UNTIL
Test Receiver Keysight	N9038A	MY54450088	July 03, 2019	July 02, 2020
Pre-Amplifier EMCI	EMC001340	980142	Jan. 25, 2019	Jan. 24, 2020
Loop Antenna Electro-Metrics	EM-6879	269	Sep. 07, 2018	Sep. 06, 2019
RF Cable	NA	LOOPCAB-001	Jan. 14, 2019	Jan. 13, 2020
RF Cable	NA	LOOPCAB-002	Jan. 14, 2019	Jan. 13, 2020
Pre-Amplifier Mini-Circuits	ZFL-1000VH2B	AMP-ZFL-01	Oct. 30, 2018	Oct. 29, 2019
Trilog Broadband Antenna SCHWARZBECK	VULB 9168	9168-406	Nov. 22, 2018	Nov. 21, 2019
RF Cable	8D	966-4-1	Mar. 19, 2019	Mar. 18, 2020
RF Cable	8D	966-4-2	Mar. 19, 2019	Mar. 18, 2020
RF Cable	8D	966-4-3	Mar. 19, 2019	Mar. 18, 2020
Fixed attenuator Mini-Circuits	UNAT-5+	PAD-3m-4-01	Sep. 27, 2018	Sep. 26, 2019
Horn_Antenna SCHWARZBECK	BBHA 9120D	9120D-783	Nov. 25, 2018	Nov. 24, 2019
Pre-Amplifier EMCI	EMC12630SE	980385	Aug. 16, 2018	Aug. 15, 2019
RF Cable	EMC104-SM-SM-1200	160923	Jan. 28, 2019	Jan. 27, 2020
RF Cable	104 RF cable	131215	Jan. 10, 2019	Jan. 09, 2020
RF Cable	EMC104-SM-SM-6000	180418	May 03, 2019	May 02, 2020
Pre-Amplifier EMCI	EMC184045SE	980387	Jan. 28, 2019	Jan. 27, 2020
Horn_Antenna SCHWARZBECK	BBHA 9170	BBHA9170519	Nov. 25, 2018	Nov. 24, 2019
RF Cable	EMC102-KM-KM-1200	160924	Jan. 28, 2019	Jan. 27, 2020
RF Cable	EMC102-KM-KM-1200	160925	Jan. 28, 2019	Jan. 27, 2020
Software	ADT_Radiated_V8.7.08	NA	NA	NA
Boresight Antenna Tower & Turn Table Max-Full	MF-7802BS	MF780208530	NA	NA
Spectrum Analyzer R&S	FSV40	100964	June 04, 2019	June 03, 2020
Power meter Anritsu	ML2495A	1014008	May 13, 2019	May 12, 2020
Power sensor Anritsu	MA2411B	0917122	May 13, 2019	May 12, 2020
AC Power Source Extech Electronics	6205	1440452	NA	NA
Temperature & Humidity Chamber Giant Force	GTH-150-40-SP-AR	MAA0812-008	Jan. 09, 2019	Jan. 08, 2020
True RMS Clamp Meter FLUKE	325	31130711WS	May 21, 2019	May 20, 2020
Fixed Attenuator Mini-Circuits	MDCS18N-10	MDCS18N-10-01	Apr. 15, 2019	Apr. 14, 2020

Note:

1. The calibration interval of the above test instruments is 12 months and the calibrations are traceable to NML/ROC and NIST/USA.
2. The test was performed in 966 Chamber No. 4.
3. Loop antenna was used for all emissions below 30 MHz.
4. Tested Date: July 06 to 22, 2019

4.1.3 Test Procedure

For Radiated emission below 30MHz

- a. The EUT was placed on the top of a rotating table 0.8 meters above the ground at a 3 meter chamber room. The table was rotated 360 degrees to determine the position of the highest radiation.
- b. The EUT was set 3 meters away from the interference-receiving antenna, which was mounted on the top of a variable-height antenna tower.
- c. Parallel, perpendicular, and ground-parallel orientations of the antenna are set to make the measurement.
- d. For each suspected emission, the EUT was arranged to its worst case and the rotatable table was turned from 0 degrees to 360 degrees to find the maximum reading.
- e. The test-receiver system was set to Quasi-Peak Detect Function and Specified Bandwidth with Maximum Hold Mode.

NOTE:

1. The resolution bandwidth and video bandwidth of test receiver/spectrum analyzer is 9kHz at frequency below 30MHz.

For Radiated emission above 30MHz

- a. The EUT was placed on the top of a rotating table 0.8 meters (for 30MHz ~ 1GHz) / 1.5 meters (for above 1GHz) above the ground at 3 meter chamber room for test. The table was rotated 360 degrees to determine the position of the highest radiation.
- b. The EUT was set 3 meters away from the interference-receiving antenna, which was mounted on the top of a variable-height antenna tower.
- c. The height of antenna is varied from one meter to four meters above the ground to determine the maximum value of the field strength. Both horizontal and vertical polarizations of the antenna are set to make the measurement.
- d. For each suspected emission, the EUT was arranged to its worst case and then the antenna was tuned to heights from 1 meter to 4 meters and the rotatable table was turned from 0 degrees to 360 degrees to find the maximum reading.
- e. The test-receiver system was set to quasi-peak detect function and specified bandwidth with maximum hold mode when the test frequency is below 1 GHz.
- f. The test-receiver system was set to peak and average detects function and specified bandwidth with maximum hold mode when the test frequency is above 1 GHz. If the peak reading value also meets average limit, measurement with the average detector is unnecessary.

Note:

1. The resolution bandwidth and video bandwidth of test receiver/spectrum analyzer is 120kHz for Quasi-peak detection (QP) at frequency below 1GHz.
2. The resolution bandwidth of test receiver/spectrum analyzer is 1 MHz and the video bandwidth is 3 MHz for Peak detection (PK) at frequency above 1GHz.
3. The resolution bandwidth of test receiver/spectrum analyzer is 1MHz and the video bandwidth is $\geq 1/T$ (Duty cycle < 98%) or 10Hz (Duty cycle $\geq 98\%$) for Average detection (AV) at frequency above 1GHz.
4. All modes of operation were investigated and the worst-case emissions are reported.

4.1.4 Deviation from Test Standard

No deviation.

4.1.5 Test Setup

For Radiated emission below 30MHz

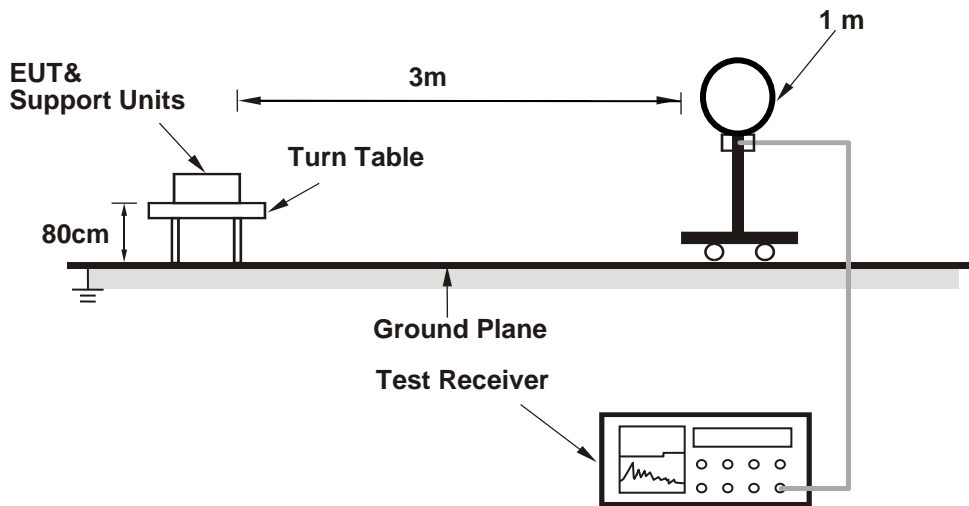

For Radiated emission 30MHz to 1GHz

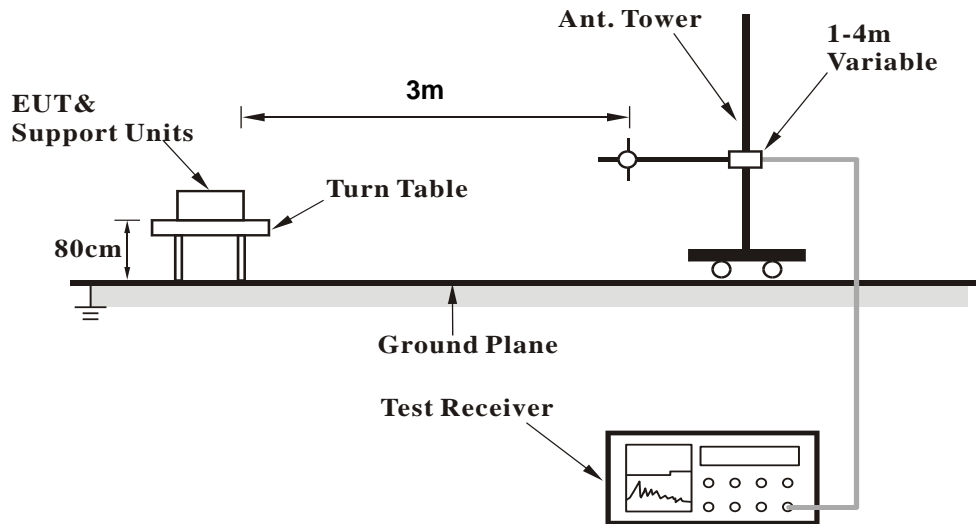

For Radiated emission above 1GHz

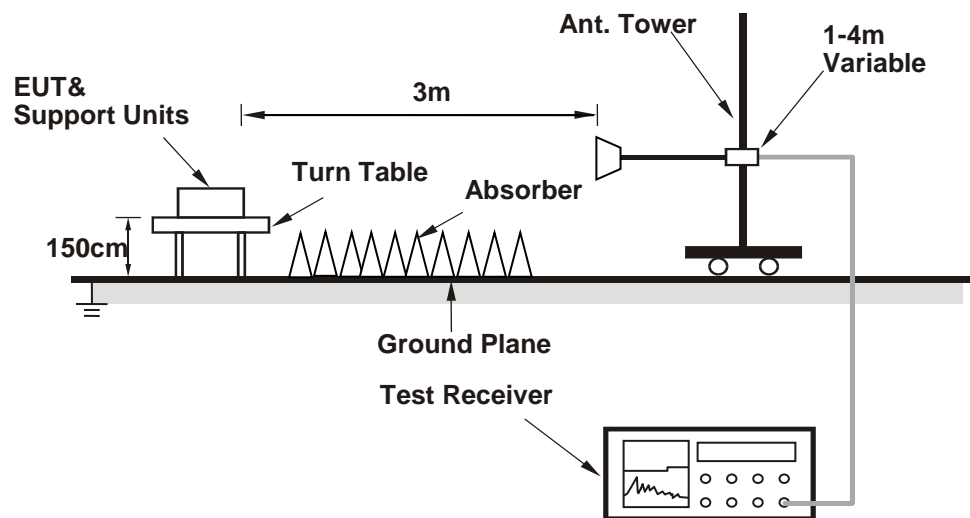

For the actual test configuration, please refer to the attached file (Test Setup Photo).

4.1.6 EUT Operating Condition

- a. Connected the EUT with the Laptop which is placed on remote site.
- b. Controlling software (Mtool 3.0.0.6) has been activated to set the EUT under transmission condition continuously at specific channel frequency.

4.1.7 Test Results

Above 1GHz Data:

802.11a

CHANNEL	TX Channel 52	DETECTOR FUNCTION	Peak (PK)
FREQUENCY RANGE	1GHz ~ 40GHz		Average (AV)

ANTENNA POLARITY & TEST DISTANCE: HORIZONTAL AT 3 M								
NO.	FREQ. (MHz)	EMISSION LEVEL (dBuV/m)	LIMIT (dBuV/m)	MARGIN (dB)	ANTENNA HEIGHT (m)	TABLE ANGLE (Degree)	RAW VALUE (dBuV)	CORRECTION FACTOR (dB/m)
1	5150.00	52.1 PK	74.0	-21.9	1.92 H	2	48.6	3.5
2	5150.00	42.2 AV	54.0	-11.8	1.92 H	2	38.7	3.5
3	*5260.00	111.5 PK			1.92 H	2	108.5	3.0
4	*5260.00	98.9 AV			1.92 H	2	95.9	3.0
5	#10520.00	41.1 PK	68.2	-27.1	1.47 H	296	27.4	13.7
6	15780.00	46.9 PK	74.0	-27.1	3.17 H	116	34.0	12.9
7	15780.00	35.2 AV	54.0	-18.8	3.17 H	116	22.3	12.9
ANTENNA POLARITY & TEST DISTANCE: VERTICAL AT 3 M								
NO.	FREQ. (MHz)	EMISSION LEVEL (dBuV/m)	LIMIT (dBuV/m)	MARGIN (dB)	ANTENNA HEIGHT (m)	TABLE ANGLE (Degree)	RAW VALUE (dBuV)	CORRECTION FACTOR (dB/m)
1	5150.00	49.4 PK	74.0	-24.6	1.69 V	276	45.9	3.5
2	5150.00	39.2 AV	54.0	-14.8	1.69 V	276	35.7	3.5
3	*5260.00	105.4 PK			1.69 V	276	102.4	3.0
4	*5260.00	95.2 AV			1.69 V	276	92.2	3.0
5	#10520.00	41.8 PK	68.2	-26.4	1.65 V	211	28.1	13.7
6	15780.00	47.1 PK	74.0	-26.9	2.65 V	145	34.2	12.9
7	15780.00	36.1 AV	54.0	-17.9	2.65 V	145	23.2	12.9

REMARKS:

1. Emission Level(dBuV/m) = Raw Value(dBuV) + Correction Factor(dB/m)
2. Correction Factor(dB/m) = Antenna Factor(dB/m) + Cable Factor(dB) – Pre-Amplifier Factor(dB)
3. Margin value = Emission Level – Limit value
4. The other emission levels were very low against the limit.
5. " * ": Fundamental frequency.
6. " # ": The radiated frequency is out of the restricted band.

CHANNEL	TX Channel 60	DETECTOR FUNCTION	Peak (PK)
FREQUENCY RANGE	1GHz ~ 40GHz		Average (AV)

ANTENNA POLARITY & TEST DISTANCE: HORIZONTAL AT 3 M

NO.	FREQ. (MHz)	EMISSION LEVEL (dBuV/m)	LIMIT (dBuV/m)	MARGIN (dB)	ANTENNA HEIGHT (m)	TABLE ANGLE (Degree)	RAW VALUE (dBuV)	CORRECTION FACTOR (dB/m)
1	*5300.00	111.4 PK			2.55 H	259	108.3	3.1
2	*5300.00	98.8 AV			2.55 H	259	95.7	3.1
3	10600.00	41.6 PK	74.0	-32.4	1.51 H	312	28.0	13.6
4	10600.00	30.5 AV	54.0	-23.5	1.51 H	312	16.9	13.6
5	15900.00	46.9 PK	74.0	-27.1	2.91 H	126	33.6	13.3
6	15900.00	35.3 AV	54.0	-18.7	2.91 H	126	22.0	13.3

ANTENNA POLARITY & TEST DISTANCE: VERTICAL AT 3 M

NO.	FREQ. (MHz)	EMISSION LEVEL (dBuV/m)	LIMIT (dBuV/m)	MARGIN (dB)	ANTENNA HEIGHT (m)	TABLE ANGLE (Degree)	RAW VALUE (dBuV)	CORRECTION FACTOR (dB/m)
1	*5300.00	104.9 PK			1.70 V	262	101.8	3.1
2	*5300.00	94.9 AV			1.70 V	262	91.8	3.1
3	10600.00	41.4 PK	74.0	-32.6	1.67 V	216	27.8	13.6
4	10600.00	31.0 AV	54.0	-23.0	1.67 V	216	17.4	13.6
5	15900.00	47.5 PK	74.0	-26.5	2.68 V	146	34.2	13.3
6	15900.00	36.6 AV	54.0	-17.4	2.68 V	146	23.3	13.3

REMARKS:

1. Emission Level(dBuV/m) = Raw Value(dBuV) + Correction Factor(dB/m)
2. Correction Factor(dB/m) = Antenna Factor(dB/m) + Cable Factor(dB) – Pre-Amplifier Factor(dB)
3. Margin value = Emission Level – Limit value
4. The other emission levels were very low against the limit.
5. " * ": Fundamental frequency.

CHANNEL	TX Channel 64	DETECTOR FUNCTION	Peak (PK)
FREQUENCY RANGE	1GHz ~ 40GHz		Average (AV)

ANTENNA POLARITY & TEST DISTANCE: HORIZONTAL AT 3 M

NO.	FREQ. (MHz)	EMISSION LEVEL (dBuV/m)	LIMIT (dBuV/m)	MARGIN (dB)	ANTENNA HEIGHT (m)	TABLE ANGLE (Degree)	RAW VALUE (dBuV)	CORRECTION FACTOR (dB/m)
1	*5320.00	112.2 PK			1.40 H	8	109.0	3.2
2	*5320.00	99.2 AV			1.40 H	8	96.0	3.2
3	5350.00	56.6 PK	74.0	-17.4	1.40 H	8	53.3	3.3
4	5350.00	44.6 AV	54.0	-9.4	1.40 H	8	41.3	3.3
5	10640.00	41.9 PK	74.0	-32.1	1.53 H	301	28.2	13.7
6	10640.00	31.1 AV	54.0	-22.9	1.53 H	301	17.4	13.7
7	15960.00	47.5 PK	74.0	-26.5	1.27 H	247	34.0	13.5
8	15960.00	35.8 AV	54.0	-18.2	1.27 H	247	22.3	13.5

ANTENNA POLARITY & TEST DISTANCE: VERTICAL AT 3 M

NO.	FREQ. (MHz)	EMISSION LEVEL (dBuV/m)	LIMIT (dBuV/m)	MARGIN (dB)	ANTENNA HEIGHT (m)	TABLE ANGLE (Degree)	RAW VALUE (dBuV)	CORRECTION FACTOR (dB/m)
1	*5320.00	105.2 PK			1.69 V	270	102.0	3.2
2	*5320.00	94.8 AV			1.69 V	270	91.6	3.2
3	5350.00	49.2 PK	74.0	-24.8	1.69 V	270	45.9	3.3
4	5350.00	38.7 AV	54.0	-15.3	1.69 V	270	35.4	3.3
5	10640.00	41.9 PK	74.0	-32.1	1.71 V	214	28.2	13.7
6	10640.00	31.1 AV	54.0	-22.9	1.71 V	214	17.4	13.7
7	15960.00	46.8 PK	74.0	-27.2	2.65 V	139	33.3	13.5
8	15960.00	35.9 AV	54.0	-18.1	2.65 V	139	22.4	13.5

REMARKS:

1. Emission Level(dBuV/m) = Raw Value(dBuV) + Correction Factor(dB/m)
2. Correction Factor(dB/m) = Antenna Factor(dB/m) + Cable Factor(dB) – Pre-Amplifier Factor(dB)
3. Margin value = Emission Level – Limit value
4. The other emission levels were very low against the limit.
5. " * ": Fundamental frequency.

CHANNEL	TX Channel 100	DETECTOR FUNCTION	Peak (PK)
FREQUENCY RANGE	1GHz ~ 40GHz		Average (AV)

ANTENNA POLARITY & TEST DISTANCE: HORIZONTAL AT 3 M

NO.	FREQ. (MHz)	EMISSION LEVEL (dBuV/m)	LIMIT (dBuV/m)	MARGIN (dB)	ANTENNA HEIGHT (m)	TABLE ANGLE (Degree)	RAW VALUE (dBuV)	CORRECTION FACTOR (dB/m)
1	5460.00	51.8 PK	74.0	-22.2	1.77 H	20	48.1	3.7
2	5460.00	42.1 AV	54.0	-11.9	1.77 H	20	38.4	3.7
3	#5470.00	54.7 PK	68.2	-13.5	1.45 H	169	51.0	3.7
4	*5500.00	112.4 PK			1.77 H	20	108.8	3.6
5	*5500.00	99.5 AV			1.77 H	20	95.9	3.6
6	11000.00	41.4 PK	74.0	-32.6	2.06 H	311	27.0	14.4
7	11000.00	30.8 AV	54.0	-23.2	2.06 H	311	16.4	14.4
8	#16500.00	48.6 PK	68.2	-19.6	1.47 H	226	33.0	15.6

ANTENNA POLARITY & TEST DISTANCE: VERTICAL AT 3 M

NO.	FREQ. (MHz)	EMISSION LEVEL (dBuV/m)	LIMIT (dBuV/m)	MARGIN (dB)	ANTENNA HEIGHT (m)	TABLE ANGLE (Degree)	RAW VALUE (dBuV)	CORRECTION FACTOR (dB/m)
1	5460.00	48.9 PK	74.0	-25.1	1.71 V	264	45.2	3.7
2	5460.00	39.0 AV	54.0	-15.0	1.71 V	264	35.3	3.7
3	#5470.00	51.2 PK	68.2	-17.0	1.71 V	264	47.5	3.7
4	*5500.00	105.2 PK			1.71 V	264	101.6	3.6
5	*5500.00	95.1 AV			1.71 V	264	91.5	3.6
6	11000.00	41.6 PK	74.0	-32.4	1.71 V	200	27.2	14.4
7	11000.00	31.1 AV	54.0	-22.9	1.71 V	200	16.7	14.4
8	#16500.00	47.7 PK	68.2	-20.5	2.65 V	154	32.1	15.6

REMARKS:

1. Emission Level(dBuV/m) = Raw Value(dBuV) + Correction Factor(dB/m)
2. Correction Factor(dB/m) = Antenna Factor(dB/m) + Cable Factor(dB) – Pre-Amplifier Factor(dB)
3. Margin value = Emission Level – Limit value
4. The other emission levels were very low against the limit.
5. " * ": Fundamental frequency.
6. " # ": The radiated frequency is out of the restricted band.

CHANNEL	TX Channel 116	DETECTOR FUNCTION	Peak (PK)
FREQUENCY RANGE	1GHz ~ 40GHz		Average (AV)

ANTENNA POLARITY & TEST DISTANCE: HORIZONTAL AT 3 M

NO.	FREQ. (MHz)	EMISSION LEVEL (dBuV/m)	LIMIT (dBuV/m)	MARGIN (dB)	ANTENNA HEIGHT (m)	TABLE ANGLE (Degree)	RAW VALUE (dBuV)	CORRECTION FACTOR (dB/m)
1	*5580.00	111.4 PK			1.64 H	66	107.7	3.7
2	*5580.00	98.7 AV			1.64 H	66	95.0	3.7
3	11160.00	41.8 PK	74.0	-32.2	1.45 H	305	27.8	14.0
4	11160.00	30.7 AV	54.0	-23.3	1.45 H	305	16.7	14.0
5	#16740.00	49.0 PK	68.2	-19.2	1.55 H	307	31.9	17.1

ANTENNA POLARITY & TEST DISTANCE: VERTICAL AT 3 M

NO.	FREQ. (MHz)	EMISSION LEVEL (dBuV/m)	LIMIT (dBuV/m)	MARGIN (dB)	ANTENNA HEIGHT (m)	TABLE ANGLE (Degree)	RAW VALUE (dBuV)	CORRECTION FACTOR (dB/m)
1	*5580.00	105.3 PK			1.63 V	263	101.6	3.7
2	*5580.00	95.0 AV			1.63 V	263	91.3	3.7
3	11160.00	41.6 PK	74.0	-32.4	1.71 V	218	27.6	14.0
4	11160.00	31.1 AV	54.0	-22.9	1.71 V	218	17.1	14.0
5	#16740.00	47.2 PK	68.2	-21.0	2.61 V	147	30.1	17.1

REMARKS:

1. Emission Level(dBuV/m) = Raw Value(dBuV) + Correction Factor(dB/m)
2. Correction Factor(dB/m) = Antenna Factor(dB/m) + Cable Factor(dB) – Pre-Amplifier Factor(dB)
3. Margin value = Emission Level – Limit value
4. The other emission levels were very low against the limit.
5. " * ": Fundamental frequency.
6. " # ": The radiated frequency is out of the restricted band.

CHANNEL	TX Channel 140	DETECTOR FUNCTION	Peak (PK)
FREQUENCY RANGE	1GHz ~ 40GHz		Average (AV)

ANTENNA POLARITY & TEST DISTANCE: HORIZONTAL AT 3 M

NO.	FREQ. (MHz)	EMISSION LEVEL (dBuV/m)	LIMIT (dBuV/m)	MARGIN (dB)	ANTENNA HEIGHT (m)	TABLE ANGLE (Degree)	RAW VALUE (dBuV)	CORRECTION FACTOR (dB/m)
1	*5700.00	111.6 PK			1.66 H	67	107.7	3.9
2	*5700.00	98.9 AV			1.66 H	67	95.0	3.9
3	#5725.00	60.2 PK	68.2	-8.0	1.66 H	67	56.4	3.8
4	11400.00	41.9 PK	74.0	-32.1	1.36 H	225	27.7	14.2
5	11400.00	31.2 AV	54.0	-22.8	1.36 H	225	17.0	14.2
6	#17100.00	49.6 PK	68.2	-18.6	1.47 H	208	32.7	16.9

ANTENNA POLARITY & TEST DISTANCE: VERTICAL AT 3 M

NO.	FREQ. (MHz)	EMISSION LEVEL (dBuV/m)	LIMIT (dBuV/m)	MARGIN (dB)	ANTENNA HEIGHT (m)	TABLE ANGLE (Degree)	RAW VALUE (dBuV)	CORRECTION FACTOR (dB/m)
1	*5700.00	105.7 PK			1.71 V	290	101.8	3.9
2	*5700.00	95.4 AV			1.71 V	290	91.5	3.9
3	#5725.00	55.3 PK	68.2	-12.9	1.71 V	290	51.5	3.8
4	11400.00	41.9 PK	74.0	-32.1	1.66 V	225	27.7	14.2
5	11400.00	31.4 AV	54.0	-22.6	1.66 V	225	17.2	14.2
6	#17100.00	47.6 PK	68.2	-20.6	2.67 V	158	30.7	16.9

REMARKS:

1. Emission Level(dBuV/m) = Raw Value(dBuV) + Correction Factor(dB/m)
2. Correction Factor(dB/m) = Antenna Factor(dB/m) + Cable Factor(dB) – Pre-Amplifier Factor(dB)
3. Margin value = Emission Level – Limit value
4. The other emission levels were very low against the limit.
5. " * ": Fundamental frequency.
6. " # ": The radiated frequency is out of the restricted band.

CHANNEL	TX Channel 144	DETECTOR FUNCTION	Peak (PK)
FREQUENCY RANGE	1GHz ~ 40GHz		Average (AV)

ANTENNA POLARITY & TEST DISTANCE: HORIZONTAL AT 3 M

NO.	FREQ. (MHz)	EMISSION LEVEL (dBuV/m)	LIMIT (dBuV/m)	MARGIN (dB)	ANTENNA HEIGHT (m)	TABLE ANGLE (Degree)	RAW VALUE (dBuV)	CORRECTION FACTOR (dB/m)
1	*5720.00	111.7 PK			1.65 H	66	107.8	3.9
2	*5720.00	98.9 AV			1.65 H	66	95.0	3.9
3	#5850.00	50.1 PK	68.2	-18.1	1.65 H	66	45.8	4.3
4	11440.00	42.1 PK	74.0	-31.9	1.30 H	227	27.9	14.2
5	11440.00	31.1 AV	54.0	-22.9	1.30 H	227	16.9	14.2
6	#17160.00	49.8 PK	68.2	-18.4	1.41 H	218	32.6	17.2

ANTENNA POLARITY & TEST DISTANCE: VERTICAL AT 3 M

NO.	FREQ. (MHz)	EMISSION LEVEL (dBuV/m)	LIMIT (dBuV/m)	MARGIN (dB)	ANTENNA HEIGHT (m)	TABLE ANGLE (Degree)	RAW VALUE (dBuV)	CORRECTION FACTOR (dB/m)
1	*5720.00	105.7 PK			1.64 V	261	101.8	3.9
2	*5720.00	95.6 AV			1.64 V	261	91.7	3.9
3	#5850.00	50.2 PK	68.2	-18.0	1.64 V	261	45.9	4.3
4	11440.00	41.5 PK	74.0	-32.5	1.68 V	226	27.3	14.2
5	11440.00	31.0 AV	54.0	-23.0	1.68 V	226	16.8	14.2
6	#17160.00	46.9 PK	68.2	-21.3	2.65 V	135	29.7	17.2

REMARKS:

1. Emission Level(dBuV/m) = Raw Value(dBuV) + Correction Factor(dB/m)
2. Correction Factor(dB/m) = Antenna Factor(dB/m) + Cable Factor(dB) – Pre-Amplifier Factor(dB)
3. Margin value = Emission Level – Limit value
4. The other emission levels were very low against the limit.
5. " * ": Fundamental frequency.
6. " # ": The radiated frequency is out of the restricted band.

802.11ac (VHT20)

CHANNEL	TX Channel 52	DETECTOR FUNCTION	Peak (PK)
FREQUENCY RANGE	1GHz ~ 40GHz		Average (AV)

ANTENNA POLARITY & TEST DISTANCE: HORIZONTAL AT 3 M

NO.	FREQ. (MHz)	EMISSION LEVEL (dBuV/m)	LIMIT (dBuV/m)	MARGIN (dB)	ANTENNA HEIGHT (m)	TABLE ANGLE (Degree)	RAW VALUE (dBuV)	CORRECTION FACTOR (dB/m)
1	5150.00	53.4 PK	74.0	-20.6	1.53 H	240	49.9	3.5
2	5150.00	42.7 AV	54.0	-11.3	1.53 H	240	39.2	3.5
3	*5260.00	111.2 PK			1.53 H	240	108.2	3.0
4	*5260.00	98.7 AV			1.53 H	240	95.7	3.0
5	#10520.00	42.1 PK	68.2	-26.1	1.56 H	305	28.4	13.7
6	15780.00	47.8 PK	74.0	-26.2	1.47 H	305	34.9	12.9
7	15780.00	36.3 AV	54.0	-17.7	1.47 H	305	23.4	12.9

ANTENNA POLARITY & TEST DISTANCE: VERTICAL AT 3 M

NO.	FREQ. (MHz)	EMISSION LEVEL (dBuV/m)	LIMIT (dBuV/m)	MARGIN (dB)	ANTENNA HEIGHT (m)	TABLE ANGLE (Degree)	RAW VALUE (dBuV)	CORRECTION FACTOR (dB/m)
1	5150.00	50.0 PK	74.0	-24.0	1.71 V	277	46.5	3.5
2	5150.00	39.6 AV	54.0	-14.4	1.71 V	277	36.1	3.5
3	*5260.00	105.9 PK			1.71 V	277	102.9	3.0
4	*5260.00	95.5 AV			1.71 V	277	92.5	3.0
5	#10520.00	41.9 PK	68.2	-26.3	1.66 V	219	28.2	13.7
6	15780.00	47.1 PK	74.0	-26.9	2.67 V	154	34.2	12.9
7	15780.00	36.2 AV	54.0	-17.8	2.67 V	154	23.3	12.9

REMARKS:

1. Emission Level(dBuV/m) = Raw Value(dBuV) + Correction Factor(dB/m)
2. Correction Factor(dB/m) = Antenna Factor(dB/m) + Cable Factor(dB) – Pre-Amplifier Factor(dB)
3. Margin value = Emission Level – Limit value
4. The other emission levels were very low against the limit.
5. " * ": Fundamental frequency.
6. " # ": The radiated frequency is out of the restricted band.

CHANNEL	TX Channel 60	DETECTOR FUNCTION	Peak (PK)
FREQUENCY RANGE	1GHz ~ 40GHz		Average (AV)

ANTENNA POLARITY & TEST DISTANCE: HORIZONTAL AT 3 M

NO.	FREQ. (MHz)	EMISSION LEVEL (dBuV/m)	LIMIT (dBuV/m)	MARGIN (dB)	ANTENNA HEIGHT (m)	TABLE ANGLE (Degree)	RAW VALUE (dBuV)	CORRECTION FACTOR (dB/m)
1	*5300.00	111.9 PK			1.55 H	11	108.8	3.1
2	*5300.00	99.3 AV			1.55 H	11	96.2	3.1
3	10600.00	41.2 PK	74.0	-32.8	1.62 H	314	27.6	13.6
4	10600.00	30.6 AV	54.0	-23.4	1.62 H	314	17.0	13.6
5	15900.00	47.1 PK	74.0	-26.9	1.47 H	228	33.8	13.3
6	15900.00	35.7 AV	54.0	-18.3	1.47 H	228	22.4	13.3

ANTENNA POLARITY & TEST DISTANCE: VERTICAL AT 3 M

NO.	FREQ. (MHz)	EMISSION LEVEL (dBuV/m)	LIMIT (dBuV/m)	MARGIN (dB)	ANTENNA HEIGHT (m)	TABLE ANGLE (Degree)	RAW VALUE (dBuV)	CORRECTION FACTOR (dB/m)
1	*5300.00	105.2 PK			1.70 V	276	102.1	3.1
2	*5300.00	95.1 AV			1.70 V	276	92.0	3.1
3	10600.00	41.5 PK	74.0	-32.5	1.64 V	214	27.9	13.6
4	10600.00	30.9 AV	54.0	-23.1	1.64 V	214	17.3	13.6
5	15900.00	47.1 PK	74.0	-26.9	2.60 V	158	33.8	13.3
6	15900.00	35.9 AV	54.0	-18.1	2.60 V	158	22.6	13.3

REMARKS:

1. Emission Level(dBuV/m) = Raw Value(dBuV) + Correction Factor(dB/m)
2. Correction Factor(dB/m) = Antenna Factor(dB/m) + Cable Factor(dB) – Pre-Amplifier Factor(dB)
3. Margin value = Emission Level – Limit value
4. The other emission levels were very low against the limit.
5. " * ": Fundamental frequency.

CHANNEL	TX Channel 64	DETECTOR FUNCTION	Peak (PK)
FREQUENCY RANGE	1GHz ~ 40GHz		Average (AV)

ANTENNA POLARITY & TEST DISTANCE: HORIZONTAL AT 3 M

NO.	FREQ. (MHz)	EMISSION LEVEL (dBuV/m)	LIMIT (dBuV/m)	MARGIN (dB)	ANTENNA HEIGHT (m)	TABLE ANGLE (Degree)	RAW VALUE (dBuV)	CORRECTION FACTOR (dB/m)
1	*5320.00	111.4 PK			1.45 H	0	108.2	3.2
2	*5320.00	98.6 AV			1.45 H	0	95.4	3.2
3	5350.00	58.8 PK	74.0	-15.2	1.45 H	0	55.5	3.3
4	5350.00	44.9 AV	54.0	-9.1	1.45 H	0	41.6	3.3
5	10640.00	41.7 PK	74.0	-32.3	1.36 H	305	28.0	13.7
6	10640.00	30.9 AV	54.0	-23.1	1.36 H	305	17.2	13.7
7	15960.00	46.6 PK	74.0	-27.4	2.24 H	158	33.1	13.5
8	15960.00	35.4 AV	54.0	-18.6	2.24 H	158	21.9	13.5

ANTENNA POLARITY & TEST DISTANCE: VERTICAL AT 3 M

NO.	FREQ. (MHz)	EMISSION LEVEL (dBuV/m)	LIMIT (dBuV/m)	MARGIN (dB)	ANTENNA HEIGHT (m)	TABLE ANGLE (Degree)	RAW VALUE (dBuV)	CORRECTION FACTOR (dB/m)
1	*5320.00	106.1 PK			1.70 V	281	102.9	3.2
2	*5320.00	95.7 AV			1.70 V	281	92.5	3.2
3	5350.00	49.9 PK	74.0	-24.1	1.70 V	281	46.6	3.3
4	5350.00	39.5 AV	54.0	-14.5	1.70 V	281	36.2	3.3
5	10640.00	41.4 PK	74.0	-32.6	1.63 V	210	27.7	13.7
6	10640.00	30.7 AV	54.0	-23.3	1.63 V	210	17.0	13.7
7	15960.00	46.8 PK	74.0	-27.2	2.66 V	149	33.3	13.5
8	15960.00	36.0 AV	54.0	-18.0	2.66 V	149	22.5	13.5

REMARKS:

1. Emission Level(dBuV/m) = Raw Value(dBuV) + Correction Factor(dB/m)
2. Correction Factor(dB/m) = Antenna Factor(dB/m) + Cable Factor(dB) – Pre-Amplifier Factor(dB)
3. Margin value = Emission Level – Limit value
4. The other emission levels were very low against the limit.
5. " * ": Fundamental frequency.

CHANNEL	TX Channel 100	DETECTOR FUNCTION	Peak (PK)
FREQUENCY RANGE	1GHz ~ 40GHz		Average (AV)

ANTENNA POLARITY & TEST DISTANCE: HORIZONTAL AT 3 M

NO.	FREQ. (MHz)	EMISSION LEVEL (dBuV/m)	LIMIT (dBuV/m)	MARGIN (dB)	ANTENNA HEIGHT (m)	TABLE ANGLE (Degree)	RAW VALUE (dBuV)	CORRECTION FACTOR (dB/m)
1	5460.00	55.2 PK	74.0	-18.8	1.55 H	20	51.5	3.7
2	5460.00	43.2 AV	54.0	-10.8	1.55 H	20	39.5	3.7
3	#5470.00	62.4 PK	68.2	-5.8	1.55 H	20	58.7	3.7
4	*5500.00	111.3 PK			1.55 H	20	107.7	3.6
5	*5500.00	98.9 AV			1.55 H	20	95.3	3.6
6	11000.00	42.1 PK	74.0	-31.9	1.36 H	205	27.7	14.4
7	11000.00	31.4 AV	54.0	-22.6	1.36 H	205	17.0	14.4
8	#16500.00	49.9 PK	68.2	-18.3	1.55 H	224	34.3	15.6

ANTENNA POLARITY & TEST DISTANCE: VERTICAL AT 3 M

NO.	FREQ. (MHz)	EMISSION LEVEL (dBuV/m)	LIMIT (dBuV/m)	MARGIN (dB)	ANTENNA HEIGHT (m)	TABLE ANGLE (Degree)	RAW VALUE (dBuV)	CORRECTION FACTOR (dB/m)
1	5460.00	49.3 PK	74.0	-24.7	1.71 V	282	45.6	3.7
2	5460.00	39.0 AV	54.0	-15.0	1.71 V	282	35.3	3.7
3	#5470.00	57.3 PK	68.2	-10.9	1.71 V	282	53.6	3.7
4	*5500.00	105.5 PK			1.71 V	282	101.9	3.6
5	*5500.00	95.5 AV			1.71 V	282	91.9	3.6
6	11000.00	41.6 PK	74.0	-32.4	1.61 V	203	27.2	14.4
7	11000.00	30.8 AV	54.0	-23.2	1.61 V	203	16.4	14.4
8	#16500.00	46.7 PK	68.2	-21.5	2.69 V	132	31.1	15.6

REMARKS:

1. Emission Level(dBuV/m) = Raw Value(dBuV) + Correction Factor(dB/m)
2. Correction Factor(dB/m) = Antenna Factor(dB/m) + Cable Factor(dB) – Pre-Amplifier Factor(dB)
3. Margin value = Emission Level – Limit value
4. The other emission levels were very low against the limit.
5. " * ": Fundamental frequency.
6. " # ": The radiated frequency is out of the restricted band.

CHANNEL	TX Channel 116	DETECTOR FUNCTION	Peak (PK)
FREQUENCY RANGE	1GHz ~ 40GHz		Average (AV)

ANTENNA POLARITY & TEST DISTANCE: HORIZONTAL AT 3 M

NO.	FREQ. (MHz)	EMISSION LEVEL (dBuV/m)	LIMIT (dBuV/m)	MARGIN (dB)	ANTENNA HEIGHT (m)	TABLE ANGLE (Degree)	RAW VALUE (dBuV)	CORRECTION FACTOR (dB/m)
1	*5580.00	112.0 PK			1.66 H	254	108.3	3.7
2	*5580.00	99.2 AV			1.66 H	254	95.5	3.7
3	11160.00	42.0 PK	74.0	-32.0	2.06 H	305	28.0	14.0
4	11160.00	31.1 AV	54.0	-22.9	2.06 H	305	17.1	14.0
5	#16740.00	49.6 PK	68.2	-18.6	1.28 H	317	32.5	17.1

ANTENNA POLARITY & TEST DISTANCE: VERTICAL AT 3 M

NO.	FREQ. (MHz)	EMISSION LEVEL (dBuV/m)	LIMIT (dBuV/m)	MARGIN (dB)	ANTENNA HEIGHT (m)	TABLE ANGLE (Degree)	RAW VALUE (dBuV)	CORRECTION FACTOR (dB/m)
1	*5580.00	105.2 PK			1.71 V	274	101.5	3.7
2	*5580.00	94.9 AV			1.71 V	274	91.2	3.7
3	11160.00	41.7 PK	74.0	-32.3	1.66 V	201	27.7	14.0
4	11160.00	31.4 AV	54.0	-22.6	1.66 V	201	17.4	14.0
5	#16740.00	47.3 PK	68.2	-20.9	2.65 V	155	30.2	17.1

REMARKS:

1. Emission Level(dBuV/m) = Raw Value(dBuV) + Correction Factor(dB/m)
2. Correction Factor(dB/m) = Antenna Factor(dB/m) + Cable Factor(dB) – Pre-Amplifier Factor(dB)
3. Margin value = Emission Level – Limit value
4. The other emission levels were very low against the limit.
5. " * ": Fundamental frequency.
6. " # ": The radiated frequency is out of the restricted band.

CHANNEL	TX Channel 140	DETECTOR FUNCTION	Peak (PK)
FREQUENCY RANGE	1GHz ~ 40GHz		Average (AV)

ANTENNA POLARITY & TEST DISTANCE: HORIZONTAL AT 3 M

NO.	FREQ. (MHz)	EMISSION LEVEL (dBuV/m)	LIMIT (dBuV/m)	MARGIN (dB)	ANTENNA HEIGHT (m)	TABLE ANGLE (Degree)	RAW VALUE (dBuV)	CORRECTION FACTOR (dB/m)
1	*5700.00	111.5 PK			1.89 H	165	107.6	3.9
2	*5700.00	99.1 AV			1.89 H	165	95.2	3.9
3	#5725.00	62.3 PK	68.2	-5.9	1.89 H	165	58.5	3.8
4	11400.00	41.6 PK	74.0	-32.4	2.09 H	334	27.4	14.2
5	11400.00	30.8 AV	54.0	-23.2	2.09 H	334	16.6	14.2
6	#17100.00	50.7 PK	68.2	-17.5	1.62 H	224	33.8	16.9

ANTENNA POLARITY & TEST DISTANCE: VERTICAL AT 3 M

NO.	FREQ. (MHz)	EMISSION LEVEL (dBuV/m)	LIMIT (dBuV/m)	MARGIN (dB)	ANTENNA HEIGHT (m)	TABLE ANGLE (Degree)	RAW VALUE (dBuV)	CORRECTION FACTOR (dB/m)
1	*5700.00	105.7 PK			1.67 V	272	101.8	3.9
2	*5700.00	95.4 AV			1.67 V	272	91.5	3.9
3	#5725.00	57.4 PK	68.2	-10.8	1.67 V	272	53.6	3.8
4	11400.00	42.4 PK	74.0	-31.6	1.67 V	211	28.2	14.2
5	11400.00	31.5 AV	54.0	-22.5	1.67 V	211	17.3	14.2
6	#17100.00	47.3 PK	68.2	-20.9	2.60 V	147	30.4	16.9

REMARKS:

1. Emission Level(dBuV/m) = Raw Value(dBuV) + Correction Factor(dB/m)
2. Correction Factor(dB/m) = Antenna Factor(dB/m) + Cable Factor(dB) – Pre-Amplifier Factor(dB)
3. Margin value = Emission Level – Limit value
4. The other emission levels were very low against the limit.
5. " * ": Fundamental frequency.
6. " # ": The radiated frequency is out of the restricted band.

CHANNEL	TX Channel 144	DETECTOR FUNCTION	Peak (PK)
FREQUENCY RANGE	1GHz ~ 40GHz		Average (AV)

ANTENNA POLARITY & TEST DISTANCE: HORIZONTAL AT 3 M

NO.	FREQ. (MHz)	EMISSION LEVEL (dBuV/m)	LIMIT (dBuV/m)	MARGIN (dB)	ANTENNA HEIGHT (m)	TABLE ANGLE (Degree)	RAW VALUE (dBuV)	CORRECTION FACTOR (dB/m)
1	*5720.00	111.4 PK			1.88 H	169	107.5	3.9
2	*5720.00	99.1 AV			1.88 H	169	95.2	3.9
3	#5850.00	49.9 PK	68.2	-18.3	1.88 H	169	45.6	4.3
4	11440.00	42.2 PK	74.0	-31.8	2.06 H	319	28.0	14.2
5	11440.00	31.3 AV	54.0	-22.7	2.06 H	319	17.1	14.2
6	#17160.00	50.9 PK	68.2	-17.3	1.63 H	222	33.7	17.2

ANTENNA POLARITY & TEST DISTANCE: VERTICAL AT 3 M

NO.	FREQ. (MHz)	EMISSION LEVEL (dBuV/m)	LIMIT (dBuV/m)	MARGIN (dB)	ANTENNA HEIGHT (m)	TABLE ANGLE (Degree)	RAW VALUE (dBuV)	CORRECTION FACTOR (dB/m)
1	*5720.00	105.9 PK			1.63 V	257	102.0	3.9
2	*5720.00	95.6 AV			1.63 V	257	91.7	3.9
3	#5850.00	49.8 PK	68.2	-18.4	1.63 V	257	45.5	4.3
4	11440.00	42.4 PK	74.0	-31.6	1.62 V	218	28.2	14.2
5	11440.00	31.7 AV	54.0	-22.3	1.62 V	218	17.5	14.2
6	#17160.00	47.6 PK	68.2	-20.6	2.62 V	145	30.4	17.2

REMARKS:

1. Emission Level(dBuV/m) = Raw Value(dBuV) + Correction Factor(dB/m)
2. Correction Factor(dB/m) = Antenna Factor(dB/m) + Cable Factor(dB) – Pre-Amplifier Factor(dB)
3. Margin value = Emission Level – Limit value
4. The other emission levels were very low against the limit.
5. " * ": Fundamental frequency.
6. " # ": The radiated frequency is out of the restricted band.

802.11ac (VHT40)

CHANNEL	TX Channel 54	DETECTOR FUNCTION	Peak (PK)
FREQUENCY RANGE	1GHz ~ 40GHz		Average (AV)

ANTENNA POLARITY & TEST DISTANCE: HORIZONTAL AT 3 M

NO.	FREQ. (MHz)	EMISSION LEVEL (dBuV/m)	LIMIT (dBuV/m)	MARGIN (dB)	ANTENNA HEIGHT (m)	TABLE ANGLE (Degree)	RAW VALUE (dBuV)	CORRECTION FACTOR (dB/m)
1	5150.00	56.7 PK	74.0	-17.3	1.49 H	0	53.2	3.5
2	5150.00	46.9 AV	54.0	-7.1	1.49 H	0	43.4	3.5
3	*5270.00	111.9 PK			1.49 H	0	108.9	3.0
4	*5270.00	99.1 AV			1.49 H	0	96.1	3.0
5	#10540.00	41.9 PK	68.2	-26.3	1.37 H	214	28.2	13.7
6	15810.00	47.4 PK	74.0	-26.6	1.51 H	305	34.3	13.1
7	15810.00	36.2 AV	54.0	-17.8	1.51 H	305	23.1	13.1

ANTENNA POLARITY & TEST DISTANCE: VERTICAL AT 3 M

NO.	FREQ. (MHz)	EMISSION LEVEL (dBuV/m)	LIMIT (dBuV/m)	MARGIN (dB)	ANTENNA HEIGHT (m)	TABLE ANGLE (Degree)	RAW VALUE (dBuV)	CORRECTION FACTOR (dB/m)
1	5150.00	52.2 PK	74.0	-21.8	1.67 V	286	48.7	3.5
2	5150.00	41.5 AV	54.0	-12.5	1.67 V	286	38.0	3.5
3	*5270.00	105.1 PK			1.67 V	286	102.1	3.0
4	*5270.00	94.9 AV			1.67 V	286	91.9	3.0
5	#10540.00	41.2 PK	68.2	-27.0	1.61 V	193	27.5	13.7
6	15810.00	47.8 PK	74.0	-26.2	2.63 V	158	34.7	13.1
7	15810.00	36.8 AV	54.0	-17.2	2.63 V	158	23.7	13.1

REMARKS:

1. Emission Level(dBuV/m) = Raw Value(dBuV) + Correction Factor(dB/m)
2. Correction Factor(dB/m) = Antenna Factor(dB/m) + Cable Factor(dB) – Pre-Amplifier Factor(dB)
3. Margin value = Emission Level – Limit value
4. The other emission levels were very low against the limit.
5. " * ": Fundamental frequency.
6. " # ": The radiated frequency is out of the restricted band.

CHANNEL	TX Channel 62	DETECTOR FUNCTION	Peak (PK)
FREQUENCY RANGE	1GHz ~ 40GHz		Average (AV)

ANTENNA POLARITY & TEST DISTANCE: HORIZONTAL AT 3 M

NO.	FREQ. (MHz)	EMISSION LEVEL (dBuV/m)	LIMIT (dBuV/m)	MARGIN (dB)	ANTENNA HEIGHT (m)	TABLE ANGLE (Degree)	RAW VALUE (dBuV)	CORRECTION FACTOR (dB/m)
1	*5310.00	112.1 PK			1.37 H	20	108.9	3.2
2	*5310.00	99.4 AV			1.37 H	20	96.2	3.2
3	5350.00	70.4 PK	74.0	-3.6	1.37 H	20	67.1	3.3
4	5350.00	53.4 AV	54.0	-0.6	1.37 H	20	50.1	3.3
5	10620.00	42.3 PK	74.0	-31.7	1.36 H	208	28.7	13.6
6	10620.00	31.4 AV	54.0	-22.6	1.36 H	208	17.8	13.6
7	15930.00	46.8 PK	74.0	-27.2	1.48 H	301	33.5	13.3
8	15930.00	35.7 AV	54.0	-18.3	1.48 H	301	22.4	13.3

ANTENNA POLARITY & TEST DISTANCE: VERTICAL AT 3 M

NO.	FREQ. (MHz)	EMISSION LEVEL (dBuV/m)	LIMIT (dBuV/m)	MARGIN (dB)	ANTENNA HEIGHT (m)	TABLE ANGLE (Degree)	RAW VALUE (dBuV)	CORRECTION FACTOR (dB/m)
1	*5310.00	105.2 PK			1.72 V	269	102.0	3.2
2	*5310.00	95.0 AV			1.72 V	269	91.8	3.2
3	5350.00	66.3 PK	74.0	-7.7	1.72 V	269	63.0	3.3
4	5350.00	49.2 AV	54.0	-4.8	1.72 V	269	45.9	3.3
5	10620.00	42.5 PK	74.0	-31.5	1.71 V	202	28.9	13.6
6	10620.00	31.9 AV	54.0	-22.1	1.71 V	202	18.3	13.6
7	15930.00	47.3 PK	74.0	-26.7	2.63 V	153	34.0	13.3
8	15930.00	36.4 AV	54.0	-17.6	2.63 V	153	23.1	13.3

REMARKS:

1. Emission Level(dBuV/m) = Raw Value(dBuV) + Correction Factor(dB/m)
2. Correction Factor(dB/m) = Antenna Factor(dB/m) + Cable Factor(dB) – Pre-Amplifier Factor(dB)
3. Margin value = Emission Level – Limit value
4. The other emission levels were very low against the limit.
5. " * ": Fundamental frequency.

CHANNEL	TX Channel 102	DETECTOR FUNCTION	Peak (PK)
FREQUENCY RANGE	1GHz ~ 40GHz		Average (AV)

ANTENNA POLARITY & TEST DISTANCE: HORIZONTAL AT 3 M

NO.	FREQ. (MHz)	EMISSION LEVEL (dBuV/m)	LIMIT (dBuV/m)	MARGIN (dB)	ANTENNA HEIGHT (m)	TABLE ANGLE (Degree)	RAW VALUE (dBuV)	CORRECTION FACTOR (dB/m)
1	5460.00	60.7 PK	74.0	-13.3	1.50 H	258	57.0	3.7
2	5460.00	44.6 AV	54.0	-9.4	1.50 H	258	40.9	3.7
3	#5470.00	67.7 PK	68.2	-0.5	1.50 H	258	64.0	3.7
4	*5510.00	110.9 PK			1.50 H	258	107.3	3.6
5	*5510.00	98.1 AV			1.50 H	258	94.5	3.6
6	11020.00	42.1 PK	74.0	-31.9	1.40 H	195	27.8	14.3
7	11020.00	31.2 AV	54.0	-22.8	1.40 H	195	16.9	14.3
8	#16530.00	46.9 PK	68.2	-21.3	1.54 H	292	31.2	15.7

ANTENNA POLARITY & TEST DISTANCE: VERTICAL AT 3 M

NO.	FREQ. (MHz)	EMISSION LEVEL (dBuV/m)	LIMIT (dBuV/m)	MARGIN (dB)	ANTENNA HEIGHT (m)	TABLE ANGLE (Degree)	RAW VALUE (dBuV)	CORRECTION FACTOR (dB/m)
1	5460.00	49.7 PK	74.0	-24.3	1.66 V	282	46.0	3.7
2	5460.00	39.3 AV	54.0	-14.7	1.66 V	282	35.6	3.7
3	#5470.00	63.4 PK	68.2	-4.8	1.66 V	282	59.7	3.7
4	*5510.00	104.2 PK			1.66 V	282	100.6	3.6
5	*5510.00	93.2 AV			1.66 V	282	89.6	3.6
6	11020.00	42.4 PK	74.0	-31.6	1.67 V	196	28.1	14.3
7	11020.00	31.9 AV	54.0	-22.1	1.67 V	196	17.6	14.3
8	#16530.00	47.1 PK	68.2	-21.1	2.70 V	143	31.4	15.7

REMARKS:

1. Emission Level(dBuV/m) = Raw Value(dBuV) + Correction Factor(dB/m)
2. Correction Factor(dB/m) = Antenna Factor(dB/m) + Cable Factor(dB) – Pre-Amplifier Factor(dB)
3. Margin value = Emission Level – Limit value
4. The other emission levels were very low against the limit.
5. " * ": Fundamental frequency.
6. " # ": The radiated frequency is out of the restricted band.

CHANNEL	TX Channel 110	DETECTOR FUNCTION	Peak (PK)
FREQUENCY RANGE	1GHz ~ 40GHz		Average (AV)

ANTENNA POLARITY & TEST DISTANCE: HORIZONTAL AT 3 M

NO.	FREQ. (MHz)	EMISSION LEVEL (dBuV/m)	LIMIT (dBuV/m)	MARGIN (dB)	ANTENNA HEIGHT (m)	TABLE ANGLE (Degree)	RAW VALUE (dBuV)	CORRECTION FACTOR (dB/m)
1	*5550.00	113.5 PK			1.96 H	170	109.8	3.7
2	*5550.00	100.5 AV			1.96 H	170	96.8	3.7
3	11100.00	42.3 PK	74.0	-31.7	1.37 H	207	28.1	14.2
4	11100.00	31.6 AV	54.0	-22.4	1.37 H	207	17.4	14.2
5	#16650.00	46.8 PK	68.2	-21.4	1.48 H	287	30.3	16.5

ANTENNA POLARITY & TEST DISTANCE: VERTICAL AT 3 M

NO.	FREQ. (MHz)	EMISSION LEVEL (dBuV/m)	LIMIT (dBuV/m)	MARGIN (dB)	ANTENNA HEIGHT (m)	TABLE ANGLE (Degree)	RAW VALUE (dBuV)	CORRECTION FACTOR (dB/m)
1	*5550.00	105.5 PK			1.66 V	274	101.8	3.7
2	*5550.00	95.4 AV			1.66 V	274	91.7	3.7
3	11100.00	41.7 PK	74.0	-32.3	1.60 V	212	27.5	14.2
4	11100.00	31.5 AV	54.0	-22.5	1.60 V	212	17.3	14.2
5	#16650.00	46.9 PK	68.2	-21.3	2.64 V	144	30.4	16.5

REMARKS:

1. Emission Level(dBuV/m) = Raw Value(dBuV) + Correction Factor(dB/m)
2. Correction Factor(dB/m) = Antenna Factor(dB/m) + Cable Factor(dB) – Pre-Amplifier Factor(dB)
3. Margin value = Emission Level – Limit value
4. The other emission levels were very low against the limit.
5. " * ": Fundamental frequency.
6. " # ": The radiated frequency is out of the restricted band.

CHANNEL	TX Channel 134	DETECTOR FUNCTION	Peak (PK)
FREQUENCY RANGE	1GHz ~ 40GHz		Average (AV)

ANTENNA POLARITY & TEST DISTANCE: HORIZONTAL AT 3 M

NO.	FREQ. (MHz)	EMISSION LEVEL (dBuV/m)	LIMIT (dBuV/m)	MARGIN (dB)	ANTENNA HEIGHT (m)	TABLE ANGLE (Degree)	RAW VALUE (dBuV)	CORRECTION FACTOR (dB/m)
1	*5670.00	112.5 PK			1.90 H	164	108.8	3.7
2	*5670.00	99.7 AV			1.90 H	164	96.0	3.7
3	#5725.00	60.1 PK	68.2	-8.1	1.90 H	164	56.3	3.8
4	11340.00	48.3 PK	74.0	-25.7	1.26 H	205	34.2	14.1
5	11340.00	36.5 AV	54.0	-17.5	1.26 H	205	22.4	14.1
6	#17010.00	45.5 PK	68.2	-22.7	1.37 H	228	28.4	17.1

ANTENNA POLARITY & TEST DISTANCE: VERTICAL AT 3 M

NO.	FREQ. (MHz)	EMISSION LEVEL (dBuV/m)	LIMIT (dBuV/m)	MARGIN (dB)	ANTENNA HEIGHT (m)	TABLE ANGLE (Degree)	RAW VALUE (dBuV)	CORRECTION FACTOR (dB/m)
1	*5670.00	105.6 PK			1.64 V	268	101.9	3.7
2	*5670.00	95.3 AV			1.64 V	268	91.6	3.7
3	#5725.00	56.2 PK	68.2	-12.0	1.64 V	268	52.4	3.8
4	11340.00	41.7 PK	74.0	-32.3	1.60 V	210	27.6	14.1
5	11340.00	31.3 AV	54.0	-22.7	1.60 V	210	17.2	14.1
6	#17010.00	46.6 PK	68.2	-21.6	2.58 V	145	29.5	17.1

REMARKS:

1. Emission Level(dBuV/m) = Raw Value(dBuV) + Correction Factor(dB/m)
2. Correction Factor(dB/m) = Antenna Factor(dB/m) + Cable Factor(dB) – Pre-Amplifier Factor(dB)
3. Margin value = Emission Level – Limit value
4. The other emission levels were very low against the limit.
5. " * ": Fundamental frequency.
6. " # ": The radiated frequency is out of the restricted band.

CHANNEL	TX Channel 142	DETECTOR FUNCTION	Peak (PK)
FREQUENCY RANGE	1GHz ~ 40GHz		Average (AV)

ANTENNA POLARITY & TEST DISTANCE: HORIZONTAL AT 3 M

NO.	FREQ. (MHz)	EMISSION LEVEL (dBuV/m)	LIMIT (dBuV/m)	MARGIN (dB)	ANTENNA HEIGHT (m)	TABLE ANGLE (Degree)	RAW VALUE (dBuV)	CORRECTION FACTOR (dB/m)
1	*5710.00	112.6 PK			1.91 H	170	108.7	3.9
2	*5710.00	100.0 AV			1.91 H	170	96.1	3.9
3	#5850.00	50.3 PK	68.2	-17.9	1.91 H	170	46.0	4.3
4	11420.00	49.0 PK	74.0	-25.0	1.22 H	201	34.9	14.1
5	11420.00	36.9 AV	54.0	-17.1	1.22 H	201	22.8	14.1
6	#17130.00	45.1 PK	68.2	-23.1	1.38 H	241	28.0	17.1

ANTENNA POLARITY & TEST DISTANCE: VERTICAL AT 3 M

NO.	FREQ. (MHz)	EMISSION LEVEL (dBuV/m)	LIMIT (dBuV/m)	MARGIN (dB)	ANTENNA HEIGHT (m)	TABLE ANGLE (Degree)	RAW VALUE (dBuV)	CORRECTION FACTOR (dB/m)
1	*5710.00	105.0 PK			1.66 V	255	101.1	3.9
2	*5710.00	94.8 AV			1.66 V	255	90.9	3.9
3	#5850.00	50.2 PK	68.2	-18.0	1.66 V	255	45.9	4.3
4	11420.00	42.1 PK	74.0	-31.9	1.58 V	198	28.0	14.1
5	11420.00	31.6 AV	54.0	-22.4	1.58 V	198	17.5	14.1
6	#17130.00	46.4 PK	68.2	-21.8	2.58 V	155	29.3	17.1

REMARKS:

1. Emission Level(dBuV/m) = Raw Value(dBuV) + Correction Factor(dB/m)
2. Correction Factor(dB/m) = Antenna Factor(dB/m) + Cable Factor(dB) – Pre-Amplifier Factor(dB)
3. Margin value = Emission Level – Limit value
4. The other emission levels were very low against the limit.
5. " * ": Fundamental frequency.
6. " # ": The radiated frequency is out of the restricted band.

802.11ac (VHT80)

CHANNEL	TX Channel 58	DETECTOR FUNCTION	Peak (PK)
FREQUENCY RANGE	1GHz ~ 40GHz		Average (AV)

ANTENNA POLARITY & TEST DISTANCE: HORIZONTAL AT 3 M

NO.	FREQ. (MHz)	EMISSION LEVEL (dBuV/m)	LIMIT (dBuV/m)	MARGIN (dB)	ANTENNA HEIGHT (m)	TABLE ANGLE (Degree)	RAW VALUE (dBuV)	CORRECTION FACTOR (dB/m)
1	5150.00	54.6 PK	74.0	-19.4	1.46 H	7	51.1	3.5
2	5150.00	45.1 AV	54.0	-8.9	1.46 H	7	41.6	3.5
3	*5290.00	107.5 PK			1.46 H	7	104.4	3.1
4	*5290.00	95.4 AV			1.46 H	7	92.3	3.1
5	5350.00	68.1 PK	74.0	-5.9	1.46 H	7	64.8	3.3
6	5350.00	53.8 AV	54.0	-0.2	1.46 H	7	50.5	3.3
7	#10580.00	42.4 PK	68.2	-25.8	1.36 H	202	28.8	13.6
8	15870.00	46.2 PK	74.0	-27.8	1.42 H	310	33.0	13.2
9	15870.00	35.2 AV	54.0	-18.8	1.42 H	310	22.0	13.2

ANTENNA POLARITY & TEST DISTANCE: VERTICAL AT 3 M

NO.	FREQ. (MHz)	EMISSION LEVEL (dBuV/m)	LIMIT (dBuV/m)	MARGIN (dB)	ANTENNA HEIGHT (m)	TABLE ANGLE (Degree)	RAW VALUE (dBuV)	CORRECTION FACTOR (dB/m)
1	5150.00	49.4 PK	74.0	-24.6	1.68 V	250	45.9	3.5
2	5150.00	38.9 AV	54.0	-15.1	1.68 V	250	35.4	3.5
3	*5290.00	102.9 PK			1.68 V	250	99.8	3.1
4	*5290.00	90.8 AV			1.68 V	250	87.7	3.1
5	5350.00	62.8 PK	74.0	-11.2	1.68 V	250	59.5	3.3
6	5350.00	48.3 AV	54.0	-5.7	1.68 V	250	45.0	3.3
7	#10580.00	41.9 PK	68.2	-26.3	1.53 V	202	28.3	13.6
8	15870.00	46.2 PK	74.0	-27.8	2.58 V	171	33.0	13.2
9	15870.00	35.4 AV	54.0	-18.6	2.58 V	171	22.2	13.2

REMARKS:

- Emission Level(dBuV/m) = Raw Value(dBuV) + Correction Factor(dB/m)
- Correction Factor(dB/m) = Antenna Factor(dB/m) + Cable Factor(dB) – Pre-Amplifier Factor(dB)
- Margin value = Emission Level – Limit value
- The other emission levels were very low against the limit.
- " * ": Fundamental frequency.
- " # ": The radiated frequency is out of the restricted band.

CHANNEL	TX Channel 106	DETECTOR FUNCTION	Peak (PK)
FREQUENCY RANGE	1GHz ~ 40GHz		Average (AV)

ANTENNA POLARITY & TEST DISTANCE: HORIZONTAL AT 3 M

NO.	FREQ. (MHz)	EMISSION LEVEL (dBuV/m)	LIMIT (dBuV/m)	MARGIN (dB)	ANTENNA HEIGHT (m)	TABLE ANGLE (Degree)	RAW VALUE (dBuV)	CORRECTION FACTOR (dB/m)
1	5460.00	63.4 PK	74.0	-10.6	1.50 H	20	59.7	3.7
2	5460.00	52.1 AV	54.0	-1.9	1.50 H	20	48.4	3.7
3	#5470.00	67.9 PK	68.2	-0.3	1.50 H	20	64.2	3.7
4	*5530.00	106.1 PK			1.50 H	20	102.4	3.7
5	*5530.00	94.2 AV			1.50 H	20	90.5	3.7
6	11060.00	41.7 PK	74.0	-32.3	1.36 H	209	27.4	14.3
7	11060.00	31.0 AV	54.0	-23.0	1.36 H	209	16.7	14.3
8	#16590.00	47.1 PK	68.2	-21.1	1.44 H	302	31.2	15.9

ANTENNA POLARITY & TEST DISTANCE: VERTICAL AT 3 M

NO.	FREQ. (MHz)	EMISSION LEVEL (dBuV/m)	LIMIT (dBuV/m)	MARGIN (dB)	ANTENNA HEIGHT (m)	TABLE ANGLE (Degree)	RAW VALUE (dBuV)	CORRECTION FACTOR (dB/m)
1	5460.00	59.3 PK	74.0	-14.7	1.69 V	267	55.6	3.7
2	5460.00	47.9 AV	54.0	-6.1	1.69 V	267	44.2	3.7
3	#5470.00	63.8 PK	68.2	-4.4	1.69 V	267	60.1	3.7
4	*5530.00	101.6 PK			1.69 V	267	97.9	3.7
5	*5530.00	89.8 AV			1.69 V	267	86.1	3.7
6	11060.00	42.0 PK	74.0	-32.0	1.57 V	213	27.7	14.3
7	11060.00	31.2 AV	54.0	-22.8	1.57 V	213	16.9	14.3
8	#16590.00	45.8 PK	68.2	-22.4	2.61 V	166	29.9	15.9

REMARKS:

1. Emission Level(dBuV/m) = Raw Value(dBuV) + Correction Factor(dB/m)
2. Correction Factor(dB/m) = Antenna Factor(dB/m) + Cable Factor(dB) – Pre-Amplifier Factor(dB)
3. Margin value = Emission Level – Limit value
4. The other emission levels were very low against the limit.
5. " * ": Fundamental frequency.
6. " # ": The radiated frequency is out of the restricted band.

CHANNEL	TX Channel 122	DETECTOR FUNCTION	Peak (PK)
FREQUENCY RANGE	1GHz ~ 40GHz		Average (AV)

ANTENNA POLARITY & TEST DISTANCE: HORIZONTAL AT 3 M

NO.	FREQ. (MHz)	EMISSION LEVEL (dBuV/m)	LIMIT (dBuV/m)	MARGIN (dB)	ANTENNA HEIGHT (m)	TABLE ANGLE (Degree)	RAW VALUE (dBuV)	CORRECTION FACTOR (dB/m)
1	*5610.00	110.3 PK			1.92 H	171	106.6	3.7
2	*5610.00	98.4 AV			1.92 H	171	94.7	3.7
3	#5725.00	59.4 PK	68.2	-8.8	1.91 H	171	55.6	3.8
4	11220.00	41.8 PK	74.0	-32.2	1.36 H	197	28.0	13.8
5	11220.00	31.1 AV	54.0	-22.9	1.36 H	197	17.3	13.8
6	#16830.00	47.0 PK	68.2	-21.2	1.50 H	299	29.7	17.3

ANTENNA POLARITY & TEST DISTANCE: VERTICAL AT 3 M

NO.	FREQ. (MHz)	EMISSION LEVEL (dBuV/m)	LIMIT (dBuV/m)	MARGIN (dB)	ANTENNA HEIGHT (m)	TABLE ANGLE (Degree)	RAW VALUE (dBuV)	CORRECTION FACTOR (dB/m)
1	*5610.00	105.2 PK			1.69 V	255	101.5	3.7
2	*5610.00	93.5 AV			1.69 V	255	89.8	3.7
3	#5725.00	54.3 PK	68.2	-13.9	1.69 V	255	50.5	3.8
4	11220.00	42.6 PK	74.0	-31.4	1.56 V	202	28.8	13.8
5	11220.00	31.9 AV	54.0	-22.1	1.56 V	202	18.1	13.8
6	#16830.00	46.3 PK	68.2	-21.9	2.60 V	143	29.0	17.3

REMARKS:

1. Emission Level(dBuV/m) = Raw Value(dBuV) + Correction Factor(dB/m)
2. Correction Factor(dB/m) = Antenna Factor(dB/m) + Cable Factor(dB) – Pre-Amplifier Factor(dB)
3. Margin value = Emission Level – Limit value
4. The other emission levels were very low against the limit.
5. " * ": Fundamental frequency.
6. " # ": The radiated frequency is out of the restricted band.

CHANNEL	TX Channel 138	DETECTOR FUNCTION	Peak (PK)
FREQUENCY RANGE	1GHz ~ 40GHz		Average (AV)

ANTENNA POLARITY & TEST DISTANCE: HORIZONTAL AT 3 M

NO.	FREQ. (MHz)	EMISSION LEVEL (dBuV/m)	LIMIT (dBuV/m)	MARGIN (dB)	ANTENNA HEIGHT (m)	TABLE ANGLE (Degree)	RAW VALUE (dBuV)	CORRECTION FACTOR (dB/m)
1	*5690.00	109.5 PK			1.88 H	184	105.6	3.9
2	*5690.00	98.1 AV			1.88 H	184	94.2	3.9
3	#5850.00	49.8 PK	68.2	-18.4	1.88 H	184	45.5	4.3
4	11380.00	42.9 PK	74.0	-31.1	1.37 H	194	28.7	14.2
5	11380.00	31.9 AV	54.0	-22.1	1.37 H	194	17.7	14.2
6	#17070.00	46.7 PK	68.2	-21.5	1.53 H	287	29.6	17.1

ANTENNA POLARITY & TEST DISTANCE: VERTICAL AT 3 M

NO.	FREQ. (MHz)	EMISSION LEVEL (dBuV/m)	LIMIT (dBuV/m)	MARGIN (dB)	ANTENNA HEIGHT (m)	TABLE ANGLE (Degree)	RAW VALUE (dBuV)	CORRECTION FACTOR (dB/m)
1	*5690.00	105.9 PK			1.65 V	261	102.0	3.9
2	*5690.00	94.0 AV			1.65 V	261	90.1	3.9
3	#5850.00	49.6 PK	68.2	-18.6	1.65 V	261	45.3	4.3
4	11380.00	41.6 PK	74.0	-32.4	1.57 V	210	27.4	14.2
5	11380.00	31.3 AV	54.0	-22.7	1.57 V	210	17.1	14.2
6	#17070.00	45.8 PK	68.2	-22.4	2.58 V	158	28.7	17.1

REMARKS:

1. Emission Level(dBuV/m) = Raw Value(dBuV) + Correction Factor(dB/m)
2. Correction Factor(dB/m) = Antenna Factor(dB/m) + Cable Factor(dB) – Pre-Amplifier Factor(dB)
3. Margin value = Emission Level – Limit value
4. The other emission levels were very low against the limit.
5. " * ": Fundamental frequency.
6. " # ": The radiated frequency is out of the restricted band.

Below 1GHz Data:

802.11ac (VHT80)

CHANNEL	TX Channel 122	DETECTOR FUNCTION	Quasi-Peak (QP)
FREQUENCY RANGE	9kHz ~ 1GHz		

ANTENNA POLARITY & TEST DISTANCE: HORIZONTAL AT 3 M								
NO.	FREQ. (MHz)	EMISSION LEVEL (dBuV/m)	LIMIT (dBuV/m)	MARGIN (dB)	ANTENNA HEIGHT (m)	TABLE ANGLE (Degree)	RAW VALUE (dBuV)	CORRECTION FACTOR (dB/m)
1	30.72	31.4 QP	40.0	-8.6	1.24 H	166	46.1	-14.7
2	87.82	29.8 QP	40.0	-10.2	1.44 H	100	48.1	-18.3
3	250.03	36.3 QP	46.0	-9.7	1.42 H	77	50.0	-13.7
4	359.92	33.4 QP	46.0	-12.6	1.42 H	71	44.0	-10.6
5	375.11	35.4 QP	46.0	-10.6	1.24 H	80	45.4	-10.0
6	792.10	35.4 QP	46.0	-10.6	1.65 H	80	36.3	-0.9

REMARKS:

1. Emission Level(dBuV/m) = Raw Value(dBuV) + Correction Factor(dB/m)
2. Correction Factor(dB/m) = Antenna Factor(dB/m) + Cable Factor(dB) – Pre-Amplifier Factor(dB)
3. Margin value = Emission Level – Limit value
4. The other emission levels were very low against the limit of frequency range 30MHz~1000MHz.
5. The emission levels were very low against the limit of frequency range 9kHz~30MHz: the amplitude of spurious emissions attenuated more than 20 dB below the permissible value to be report.

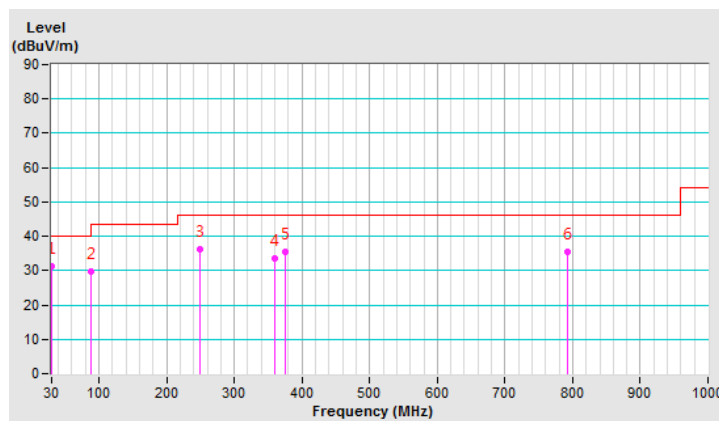

CHANNEL	TX Channel 122	DETECTOR FUNCTION	Quasi-Peak (QP)
FREQUENCY RANGE	9kHz ~ 1GHz		

ANTENNA POLARITY & TEST DISTANCE: VERTICAL AT 3 M

NO.	FREQ. (MHz)	EMISSION LEVEL (dBuV/m)	LIMIT (dBuV/m)	MARGIN (dB)	ANTENNA HEIGHT (m)	TABLE ANGLE (Degree)	RAW VALUE (dBuV)	CORRECTION FACTOR (dB/m)
1	32.91	34.7 QP	40.0	-5.3	1.22 V	175	49.4	-14.7
2	62.75	33.8 QP	40.0	-6.2	1.42 V	166	47.8	-14.0
3	250.06	37.2 QP	46.0	-8.8	1.24 V	311	50.9	-13.7
4	360.34	35.2 QP	46.0	-10.8	1.41 V	80	45.8	-10.6
5	398.97	33.4 QP	46.0	-12.6	1.20 V	175	42.8	-9.4
6	750.06	38.3 QP	46.0	-7.7	1.42 V	50	39.7	-1.4

REMARKS:

1. Emission Level(dBuV/m) = Raw Value(dBuV) + Correction Factor(dB/m)
2. Correction Factor(dB/m) = Antenna Factor(dB/m) + Cable Factor(dB) – Pre-Amplifier Factor(dB)
3. Margin value = Emission Level – Limit value
4. The other emission levels were very low against the limit of frequency range 30MHz~1000MHz.
5. The emission levels were very low against the limit of frequency range 9kHz~30MHz: the amplitude of spurious emissions attenuated more than 20 dB below the permissible value to be report.

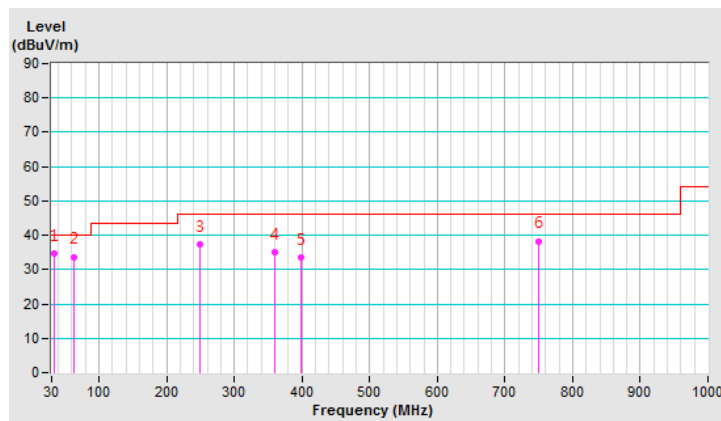

4.2 Conducted Emission Measurement

4.2.1 Limits of Conducted Emission Measurement

Frequency (MHz)	Conducted Limit (dBuV)	
	Quasi-peak	Average
0.15 - 0.5	66 - 56	56 - 46
0.50 - 5.0	56	46
5.0 - 30.0	60	50

Note: 1. The lower limit shall apply at the transition frequencies.

2. The limit decreases in line with the logarithm of the frequency in the range of 0.15 to 0.50MHz.

4.2.2 Test Instruments

DESCRIPTION & MANUFACTURER	MODEL NO.	SERIAL NO.	CALIBRATED DATE	CALIBRATED UNTIL
Test Receiver R&S	ESCS 30	847124/029	Oct. 24, 2018	Oct. 23, 2019
Line-Impedance Stabilization Network (for EUT) R&S	ESH3-Z5	848773/004	Oct. 22, 2018	Oct. 21, 2019
Line-Impedance Stabilization Network (for Peripheral) R&S	ESH3-Z5	835239/001	Mar. 17, 2019	Mar. 16, 2020
50 ohms Terminator	N/A	3	Oct. 22, 2018	Oct. 21, 2019
RF Cable	5D-FB	COCCAB-001	Sep. 28, 2018	Sep. 27, 2019
Fixed attenuator EMCI	STI02-2200-10	003	Mar. 14, 2019	Mar. 13, 2020
Software BVADT	BVADT_Cond_ V7.3.7.4	NA	NA	NA

Note:

1. The calibration interval of the above test instruments are 12 months and the calibrations are traceable to NML/ROC and NIST/USA.
2. The test was performed in Conduction 1.
3. Tested Date: July 10, 2019

4.2.3 Test Procedure

- The EUT was placed 0.4 meters from the conducting wall of the shielded room with EUT being connected to the power mains through a line impedance stabilization network (LISN). Other support units were connected to the power mains through another LISN. The two LISNs provide 50 ohm/ 50uH of coupling impedance for the measuring instrument.
- Both lines of the power mains connected to the EUT were checked for maximum conducted interference.
- The frequency range from 150kHz to 30MHz was searched. Emission levels under (Limit - 20dB) was not recorded.

NOTE: All modes of operation were investigated and the worst-case emissions are reported.

4.2.4 Deviation from Test Standard

No deviation.

4.2.5 Test Setup

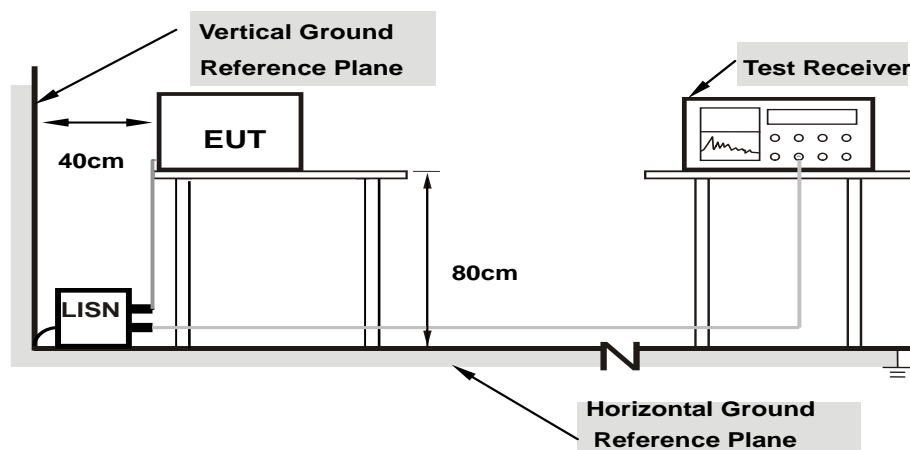

Note: 1.Support units were connected to second LISN.

For the actual test configuration, please refer to the attached file (Test Setup Photo).

4.2.6 EUT Operating Condition

Same as 4.1.6.

4.2.7 Test Results

Phase	Line (L)	Detector Function	Quasi-Peak (QP) / Average (AV)
-------	----------	-------------------	--------------------------------

No	Freq. [MHz]	Corr.	Reading Value		Emission Level		Limit		Margin	
		Factor (dB)	[dB (uV)]		[dB (uV)]		[dB (uV)]		(dB)	
			Q.P.	AV.	Q.P.	AV.	Q.P.	AV.	Q.P.	AV.
1	0.15391	9.96	37.80	23.52	47.76	33.48	65.79	55.79	-18.03	-22.31
2	0.16562	9.96	33.68	20.96	43.64	30.92	65.18	55.18	-21.54	-24.26
3	0.22812	9.97	24.13	12.16	34.10	22.13	62.52	52.52	-28.42	-30.39
4	0.34141	9.98	24.99	20.10	34.97	30.08	59.17	49.17	-24.20	-19.09
5	3.00781	10.19	18.23	8.85	28.42	19.04	56.00	46.00	-27.58	-26.96
6	8.70703	10.56	27.99	22.67	38.55	33.23	60.00	50.00	-21.45	-16.77

REMARKS:

1. Q.P. and AV. are abbreviations of quasi-peak and average individually.
2. The emission levels of other frequencies were very low against the limit.
3. Margin value = Emission level - Limit value
4. Correction factor = Insertion loss + Cable loss
5. Emission Level = Correction Factor + Reading Value.

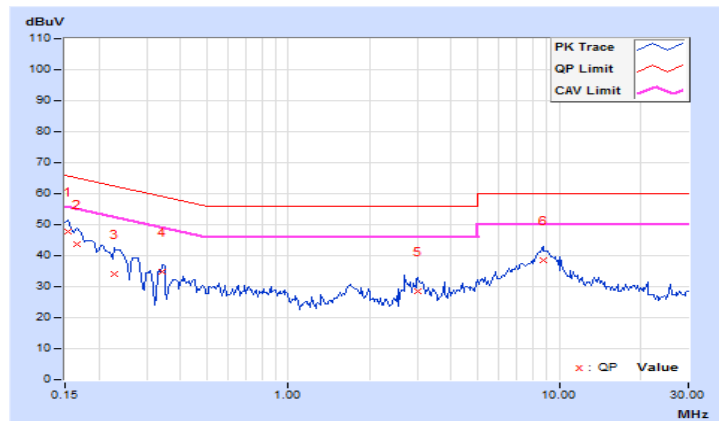

Phase	Neutral (N)	Detector Function	Quasi-Peak (QP) / Average (AV)
-------	-------------	-------------------	--------------------------------

No	Freq. [MHz]	Corr. Factor	Reading Value [dB (uV)]		Emission Level [dB (uV)]		Limit [dB (uV)]		Margin (dB)	
		(dB)	Q.P.	AV.	Q.P.	AV.	Q.P.	AV.	Q.P.	AV.
	1	0.15391	9.94	36.97	20.65	46.91	30.59	65.79	55.79	-18.88
2	0.17344	9.94	35.32	21.84	45.26	31.78	64.79	54.79	-19.53	-23.01
3	0.21250	9.95	28.37	20.14	38.32	30.09	63.11	53.11	-24.79	-23.02
4	0.24375	9.96	27.78	18.96	37.74	28.92	61.97	51.97	-24.23	-23.05
5	3.11328	10.15	18.29	9.78	28.44	19.93	56.00	46.00	-27.56	-26.07
6	8.79297	10.48	25.41	19.10	35.89	29.58	60.00	50.00	-24.11	-20.42

REMARKS:

1. Q.P. and AV. are abbreviations of quasi-peak and average individually.
2. The emission levels of other frequencies were very low against the limit.
3. Margin value = Emission level - Limit value
4. Correction factor = Insertion loss + Cable loss
5. Emission Level = Correction Factor + Reading Value.

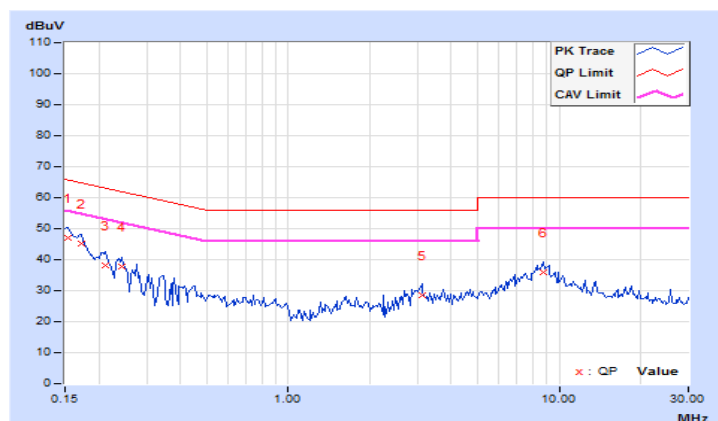

4.3 Transmit Power Measurement

4.3.1 Limits of Transmit Power Measurement

Operation Band	EUT Category		Limit
U-NII-1		Outdoor Access Point	1 Watt (30 dBm) (Max. e.i.r.p \leq 125mW(21 dBm) at any elevation angle above 30 degrees as measured from the horizon)
		Fixed point-to-point Access Point	1 Watt (30 dBm)
		Indoor Access Point	1 Watt (30 dBm)
		Client device	250mW (24 dBm)
U-NII-2A		√	250mW (24 dBm) or 11 dBm+10 log B*
U-NII-2C		√	250mW (24 dBm) or 11 dBm+10 log B*
U-NII-3		√	1 Watt (30 dBm)

*B is the 26 dB emission bandwidth in megahertz

Per KDB 662911 Method of conducted output power measurement on IEEE 802.11 devices,

Array Gain = 0 dB (i.e., no array gain) for $N_{ANT} \leq 4$;

Array Gain = 0 dB (i.e., no array gain) for channel widths ≥ 40 MHz for any N_{ANT} ;

Array Gain = $5 \log(N_{ANT}/N_{SS})$ dB or 3 dB, whichever is less for 20-MHz channel widths with $N_{ANT} \geq 5$.

For power measurements on all other devices: Array Gain = $10 \log(N_{ANT}/N_{SS})$ dB.

4.3.2 Test Setup

FOR POWER OUTPUT MEASUREMENT

For channel straddling 5725MHz:

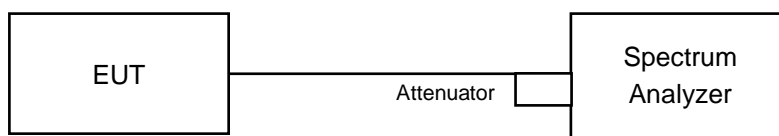

For other channels:

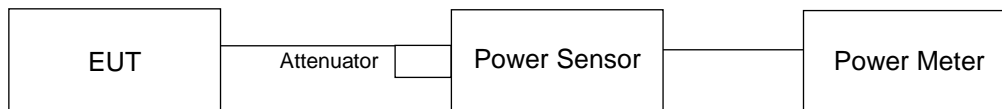

FOR 26dB OCCUPIED BANDWIDTH

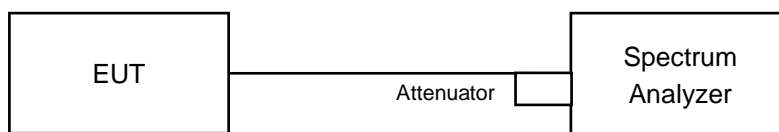

4.3.3 Test Instruments

Refer to section 4.1.2 to get information of above instrument.

4.3.4 Test Procedure

FOR POWER OUTPUT MEASUREMENT

For channel straddling 5725MHz:

802.11ac (VHT40)

Follow FCC KDB 789033 UNII test procedure:

Method SA-1

1. Set span to encompass the entire emission bandwidth (EBW) of the signal.
2. Set RBW = 1MHz.
3. Set the VBW $\geq 3 \times$ RBW.
4. Number of points in sweep ≥ 2 Span / RBW.
5. Sweep time = auto.
6. Set trigger to free run (duty cycle ≥ 98 percent)
7. Detector = RMS.
8. Trace average at least 100 traces in power averaging mode
9. Compute power by integrating the spectrum across the 26 dB EBW of the signal.

802.11a, 802.11ac (VHT20), 802.11ac (VHT80)

Method SA-2

1. Set span to encompass the emission bandwidth (EBW) of the signal.
2. Set RBW = 1MHz.
3. Set the VBW $\geq 3 \times$ RBW.
4. Number of points in sweep ≥ 2 Span / RBW.
5. Sweep time = auto.
6. Detector = RMS.
7. Trace average at least 100 traces in power averaging mode
8. Compute power by integrating the spectrum across the 26 dB EBW of the signal.
9. Duty factor need added to measured value (duty cycle < 98 percent).

For other channels:

Method PM is used to perform output power measurement, trigger and gating function of wide band power meter is enabled to measure max output power of TX on burst. Duty factor is not added to measured value.

FOR 26dB OCCUPIED BANDWIDTH

1. Set RBW = approximately 1% of the emission bandwidth.
2. Set the VBW $>$ RBW.
3. Detector = Peak.
4. Trace mode = max hold.
5. Measure the maximum width of the emission that is 26 dB down from the peak of the emission. Compare this with the RBW setting of the analyzer. Readjust RBW and repeat measurement as needed until the RBW/EBW ratio is approximately 1%.

4.3.5 Deviation from Test Standard

No deviation.

4.3.6 EUT Operating Condition

The software provided by client to enable the EUT under transmission condition continuously at lowest, middle and highest channel frequencies individually.

4.3.7 Test Result

CDD Mode

802.11a

Chan.	Chan. Freq. (MHz)	Maximum Conducted Power (dBm)				Total Power (mW)	Total Power (dBm)	Limit (dBm)	Pass / Fail
		Chain 0	Chain 1	Chain 2	Chain 3				
52	5260	13.71	14.60	14.87	15.07	115.163	20.61	24.00	Pass
60	5300	13.73	14.63	14.91	15.10	115.978	20.64	24.00	Pass
64	5320	13.75	14.69	14.96	15.00	116.114	20.65	24.00	Pass
100	5500	14.79	14.54	14.25	14.89	116.014	20.65	24.00	Pass
116	5580	14.77	14.52	14.31	14.92	116.329	20.66	24.00	Pass
140	5700	14.75	14.62	14.42	14.82	116.835	20.68	24.00	Pass
*144 (UNII-2C Band)	5720	11.00	10.98	9.80	11.44	49.66	16.96	22.97	Pass
*144 (UNII-3 Band)	5720	4.56	4.62	3.68	5.32	11.742	10.70	30.00	Pass

Note: * Test was performed in accordance with Measurement follow FCC KDB 789033 UNII test procedure Method SA-2 and use spectrum analyzer test.

The Total Power for the straddle channel:

Chan.	Chan. Freq. (MHz)	Average Power (mW)	Average Power (dBm)
144	5720	61.402	17.88

Note: The total power was calculated through formula and record the value for reference only.

26dB OCCUPIED BANDWIDTH

Channel	Frequency (MHz)	26dBc Bandwidth (MHz)			
		Chain 0	Chain 1	Chain 2	Chain 3
52	5260	21.90	21.87	21.70	21.67
60	5300	21.83	21.73	21.67	21.63
64	5320	21.82	21.82	21.68	21.66
100	5500	21.87	21.80	21.65	21.50
116	5580	22.83	22.76	22.69	22.81
140	5700	21.86	21.79	21.57	21.64
144 (UNII-2C Band)	5720	16.09	16.03	15.76	15.88

Note: For U_NII-2A, U_NII-2C Band output power limitation is determined based on 26dBc bandwidth.

Power Limit = 11dBm + 10logB < U_NII-2A, U_NII-2C >			
Channel Number	Freq.(MHz)	Min. B(MHz)	Determined Conducted Limit (dBm)
52	5260	21.67	24.35 > 24
60	5300	21.63	24.35 > 24
64	5320	21.66	24.35 > 24
100	5500	21.50	24.32 > 24
116	5580	22.69	24.55 > 24
140	5700	21.57	24.33 > 24
144 (UNII-2C Band)	5720	15.76	22.97 < 24

802.11ac (VHT20)

Chan.	Chan. Freq. (MHz)	Maximum Conducted Power (dBm)				Total Power (mW)	Total Power (dBm)	Limit (dBm)	Pass / Fail
		Chain 0	Chain 1	Chain 2	Chain 3				
52	5260	13.61	14.61	14.79	14.99	113.548	20.55	24.00	Pass
60	5300	13.57	14.66	14.76	14.95	113.177	20.54	24.00	Pass
64	5320	13.71	14.72	14.80	14.98	114.821	20.60	24.00	Pass
100	5500	14.54	14.63	14.58	14.96	117.526	20.70	24.00	Pass
116	5580	14.45	14.72	14.62	14.85	117.031	20.68	24.00	Pass
140	5700	14.39	14.59	14.65	14.79	115.557	20.63	24.00	Pass
*144 (UNII-2C Band)	5720	10.05	9.96	9.62	11.43	44.17	16.45	22.98	Pass
*144 (UNII-3 Band)	5720	3.52	3.52	4.07	5.63	10.976	10.40	30.00	Pass

Note: * Test was performed in accordance with Measurement follow FCC KDB 789033 UNII test procedure Method SA-2 and use spectrum analyzer test.

The Total Power for the straddle channel:

Chan.	Chan. Freq. (MHz)	Average Power (mW)	Average Power (dBm)
144	5720	55.146	17.42

Note: The total power was calculated through formula and record the value for reference only.

26dB OCCUPIED BANDWIDTH

Channel	Frequency (MHz)	26dBc Bandwidth (MHz)			
		Chain 0	Chain 1	Chain 2	Chain 3
52	5260	21.81	21.37	21.93	21.93
60	5300	21.78	21.39	21.75	21.89
64	5320	21.78	21.39	21.86	21.97
100	5500	21.72	21.37	21.76	21.79
116	5580	22.92	22.47	22.78	22.94
140	5700	21.76	21.43	21.81	21.80
144 (UNII-2C Band)	5720	16.03	15.78	15.94	15.94

Note: For U_NII-2A, U_NII-2C Band output power limitation is determined based on 26dBc bandwidth.

Power Limit = 11dBm + 10logB < U_NII-2A, U_NII-2C >			
Channel Number	Freq.(MHz)	Min. B(MHz)	Determined Conducted Limit (dBm)
52	5260	21.37	24.29 > 24
60	5300	21.39	24.3 > 24
64	5320	21.39	24.3 > 24
100	5500	21.37	24.29 > 24
116	5580	22.47	24.51 > 24
140	5700	21.43	24.31 > 24
144 (UNII-2C Band)	5720	15.78	22.98 < 24

802.11ac (VHT40)

Chan.	Chan. Freq. (MHz)	Maximum Conducted Power (dBm)				Total Power (mW)	Total Power (dBm)	Limit (dBm)	Pass / Fail
		Chain 0	Chain 1	Chain 2	Chain 3				
54	5270	16.74	18.11	18.10	17.75	236.051	23.73	24.00	Pass
62	5310	16.75	18.09	18.12	17.71	235.615	23.72	24.00	Pass
102	5510	15.36	14.99	15.01	15.81	135.709	21.33	24.00	Pass
110	5550	17.63	17.45	17.51	18.11	234.611	23.70	24.00	Pass
134	5670	17.72	17.51	17.68	17.99	237.085	23.75	24.00	Pass
*142 (UNII-2C Band)	5710	13.70	13.66	14.47	14.64	103.766	20.16	24.00	Pass
*142 (UNII-3 Band)	5710	4.01	4.12	3.98	4.22	10.242	10.10	30.00	Pass

Note: * Test was performed in accordance with Measurement follow FCC KDB 789033 UNII test procedure Method SA-1 and use spectrum analyzer test.

The Total Power for the straddle channel:

Chan.	Chan. Freq. (MHz)	Average Power (mW)	Average Power (dBm)
142	5710	114.008	20.57

Note: The total power was calculated through formula and record the value for reference only.

26dB BANDWIDTH:

Channel	Frequency (MHz)	26dBc Bandwidth (MHz)			
		Chain 0	Chain 1	Chain 2	Chain 3
54	5270	41.54	41.11	54.52	54.09
62	5310	41.52	41.15	59.26	43.88
102	5510	41.48	41.24	41.45	41.55
110	5550	41.58	41.21	53.42	41.45
134	5670	41.71	41.28	50.10	43.45
142 (UNII-2C Band)	5710	36.04	35.82	37.55	41.02

Note: For U_NII-2A, U_NII-2C Band output power limitation is determined based on 26dBc bandwidth.

Power Limit = 11dBm + 10logB < U_NII-2A, U_NII-2C >			
Channel Number	Freq.(MHz)	Min. B(MHz)	Determined Conducted Limit (dBm)
54	5270	41.11	27.13 > 24
62	5310	41.15	27.14 > 24
102	5510	41.24	27.15 > 24
110	5550	41.21	27.15 > 24
134	5670	41.28	27.15 > 24
142 (UNII-2C Band)	5710	35.82	26.54 > 24

802.11ac (VHT80)

Chan.	Chan. Freq. (MHz)	Maximum Conducted Power (dBm)				Total Power (mW)	Total Power (dBm)	Limit (dBm)	Pass / Fail
		Chain 0	Chain 1	Chain 2	Chain 3				
58	5290	14.24	15.28	15.72	15.83	135.882	21.33	24.00	Pass
106	5530	14.33	14.37	14.29	14.71	110.888	20.45	24.00	Pass
122	5610	18.06	17.93	17.24	17.83	239.7	23.80	24.00	Pass
*138 (UNII-2C Band)	5690	14.68	14.46	14.18	14.41	121.254	20.84	24.00	Pass
*138 (UNII-3 Band)	5690	0.89	0.45	0.36	0.61	4.991	6.98	30.00	Pass

Note: * Test was performed in accordance with Measurement follow FCC KDB 789033 UNII test procedure Method SA-2 and use spectrum analyzer test.

The Total Power for the straddle channel:

Chan.	Chan. Freq. (MHz)	Average Power (mW)	Average Power (dBm)
138	5690	126.245	21.01

Note: The total power was calculated through formula and record the value for reference only.

26dB BANDWIDTH:

Channel	Frequency (MHz)	26dBc Bandwidth (MHz)			
		Chain 0	Chain 1	Chain 2	Chain 3
58	5290	82.81	82.54	82.31	82.05
106	5530	83.22	82.48	82.32	82.12
122	5610	147.42	83.00	82.22	82.63
138 (UNII-2C Band)	5690	105.04	76.77	76.52	76.35

Note: For U_NII-2A, U_NII-2C Band output power limitation is determined based on 26dBc bandwidth.

Power Limit = 11dBm + 10logB < U_NII-2A, U_NII-2C >			
Channel Number	Freq.(MHz)	Min. B(MHz)	Determined Conducted Limit (dBm)
58	5290	82.05	30.14 > 24
106	5530	82.12	30.14 > 24
122	5610	82.22	30.14 > 24
138 (UNII-2C Band)	5690	76.35	29.82 > 24

For channel straddling 5725MHz of Power

CDD Mode

Spectrum Plot Value of Power

802.11a_Chain 0 / CH144 (U-NII-2C Band)

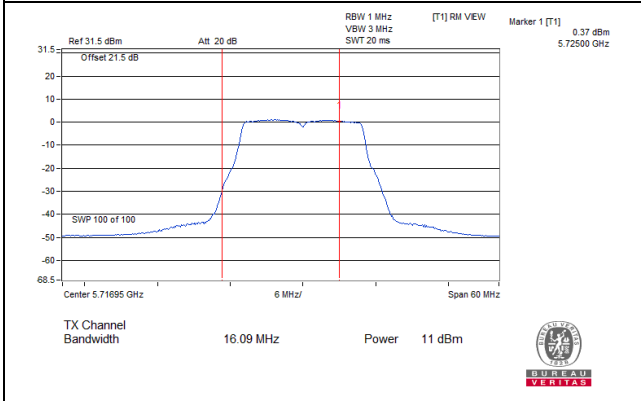

802.11a_Chain 0 / CH144 (U-NII-3 Band)

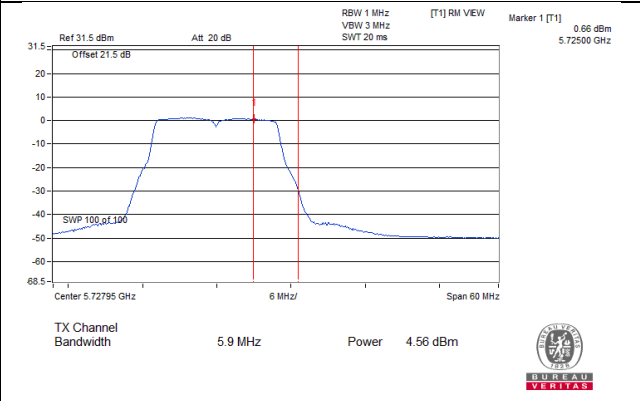

802.11a_Chain 1 / CH144 (U-NII-2C Band)

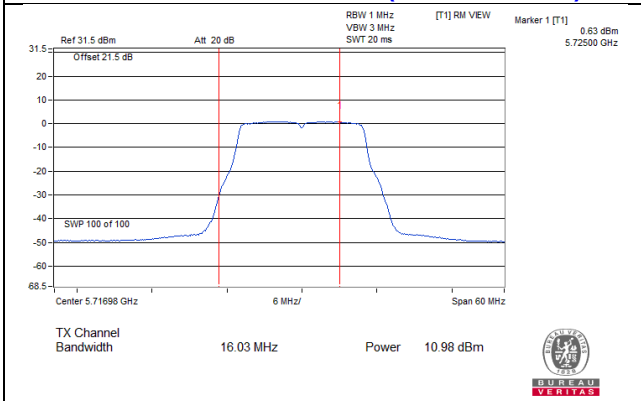

802.11a_Chain 1 / CH144 (U-NII-3 Band)

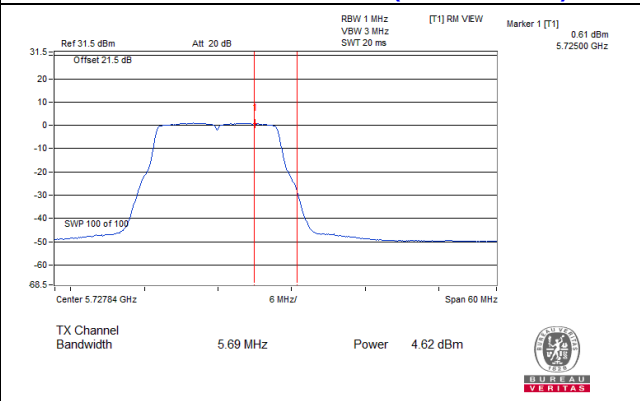

802.11a_Chain 2 / CH144 (U-NII-2C Band)

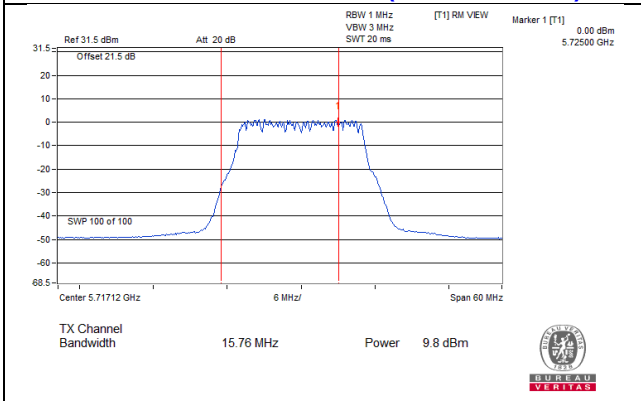

802.11a_Chain 2 / CH144 (U-NII-3 Band)

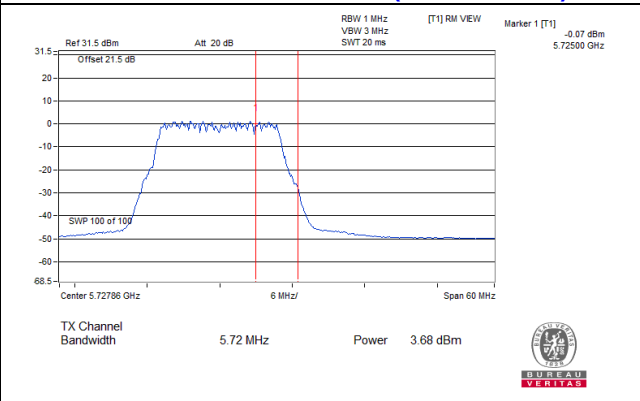

802.11a_Chain 3 / CH144 (U-NII-2C Band)

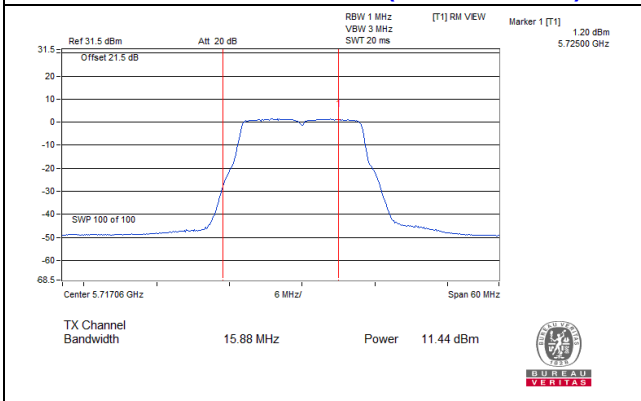

802.11a_Chain 3 / CH144 (U-NII-3 Band)

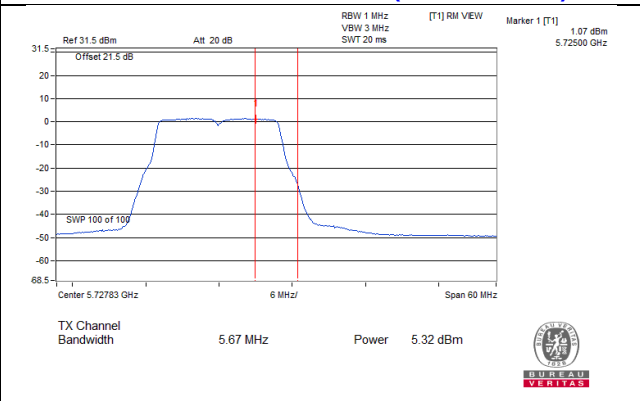

Spectrum Plot Value of Power

802.11ac (VHT20)_Chain 0 / CH144 (U-NII-2C Band)

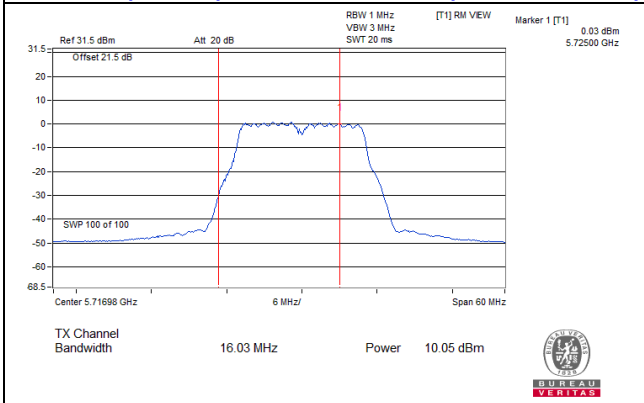

802.11ac (VHT20)_Chain 0 / CH144 (U-NII-3 Band)

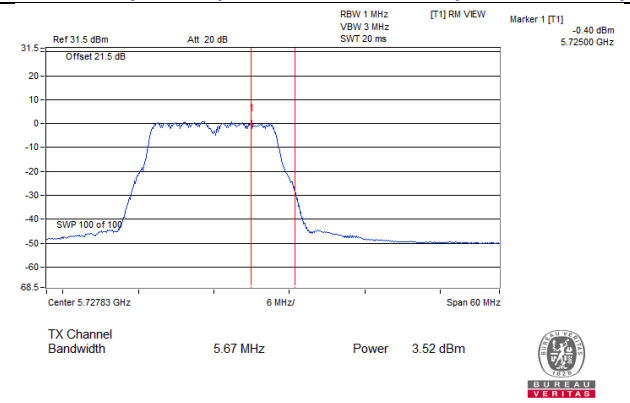

802.11ac (VHT20)_Chain 1 / CH144 (U-NII-2C Band)

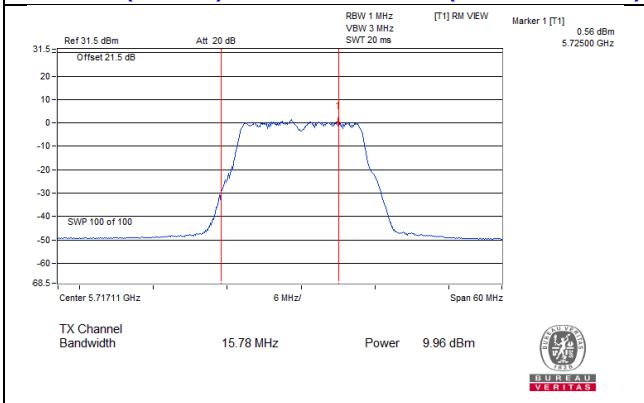

802.11ac (VHT20)_Chain 1 / CH144 (U-NII-3 Band)

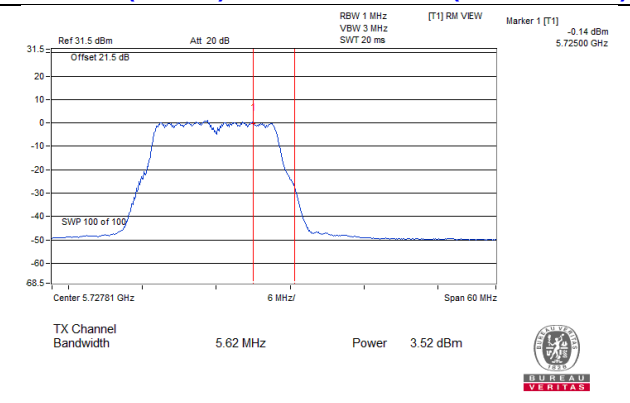

802.11ac (VHT20)_Chain 2 / CH144 (U-NII-2C Band)

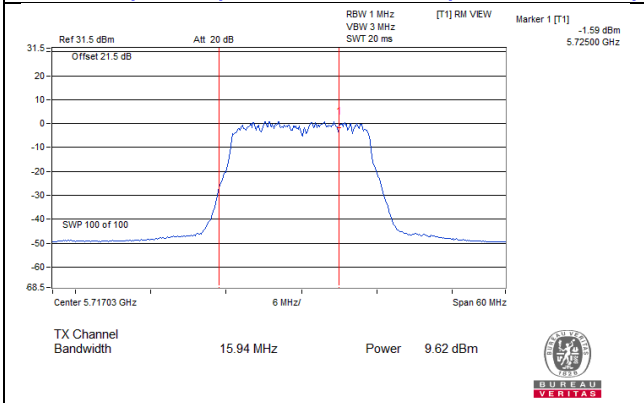

802.11ac (VHT20)_Chain 2 / CH144 (U-NII-3 Band)

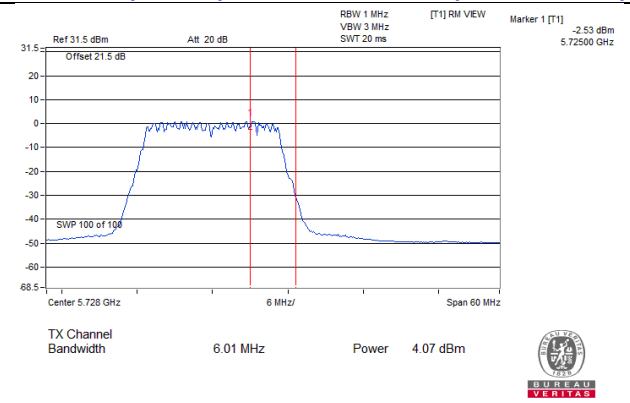

802.11ac (VHT20)_Chain 3 / CH144 (U-NII-2C Band)

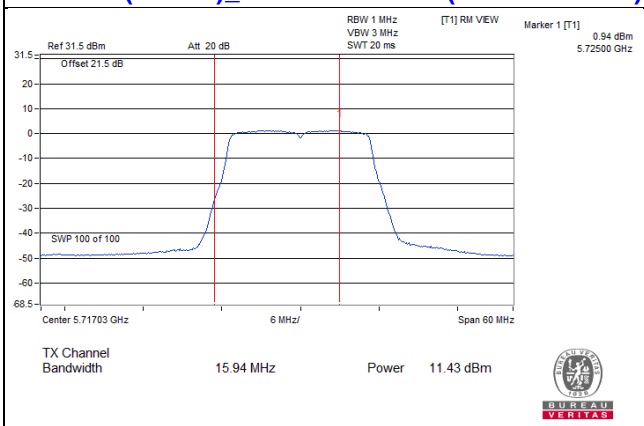

802.11ac (VHT20)_Chain 3 / CH144 (U-NII-3 Band)

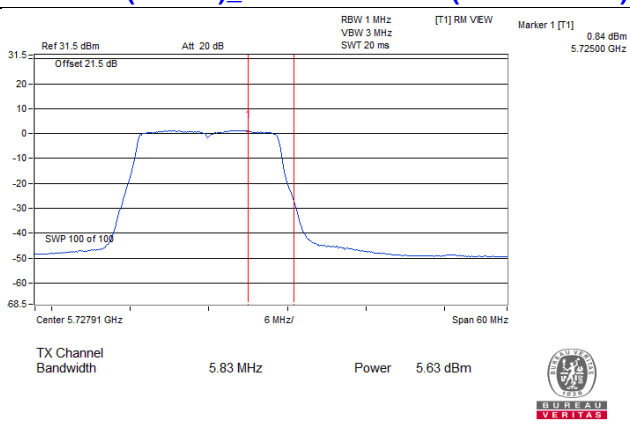

Spectrum Plot Value of Power

802.11ac (VHT40)_Chain 0 / CH142 (U-NII-2C Band)

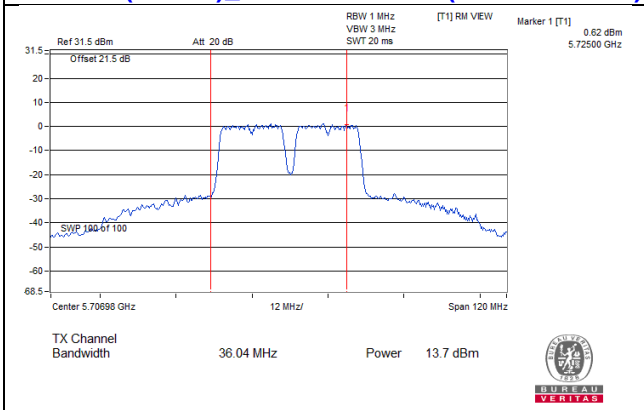

802.11ac (VHT40)_Chain 0 / CH142 (U-NII-3 Band)

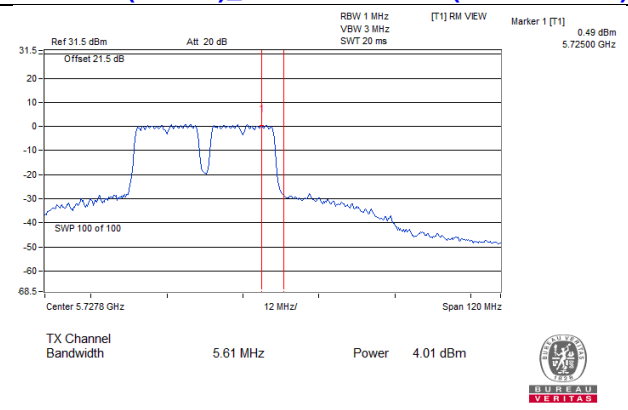

802.11ac (VHT40)_Chain 1 / CH142 (U-NII-2C Band)

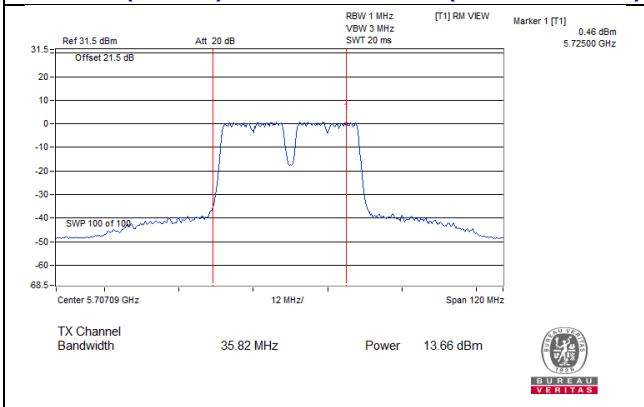

802.11ac (VHT40)_Chain 1 / CH142 (U-NII-3 Band)

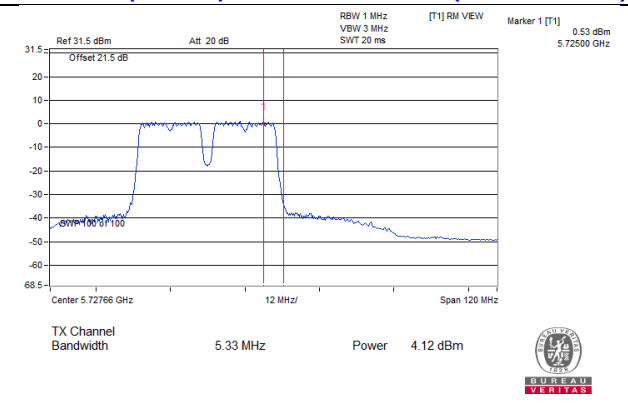

802.11ac (VHT40)_Chain 2 / CH142 (U-NII-2C Band)

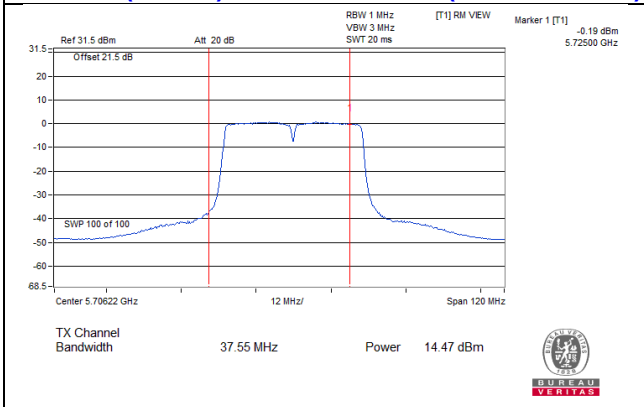

802.11ac (VHT40)_Chain 2 / CH142 (U-NII-3 Band)

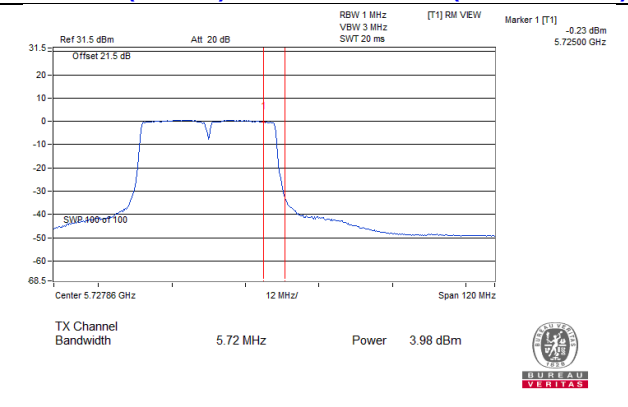

802.11ac (VHT40)_Chain 3 / CH142 (U-NII-2C Band)

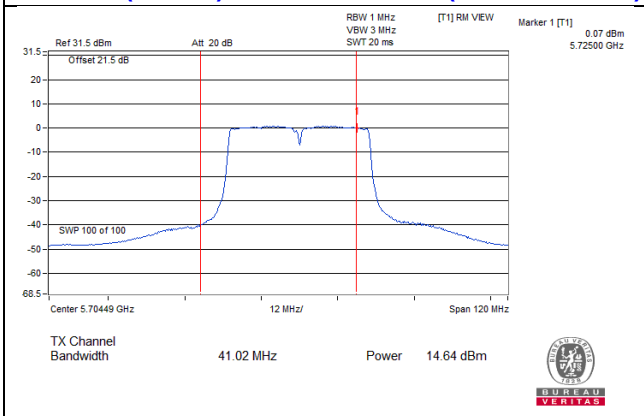

802.11ac (VHT40)_Chain 3 / CH142 (U-NII-3 Band)

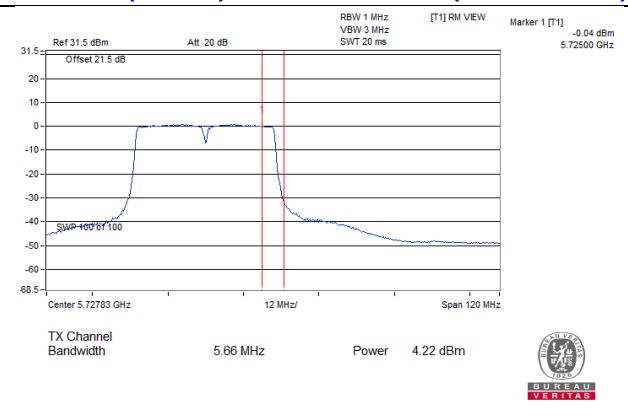

Spectrum Plot Value of Power

802.11ac (VHT80)_Chain 0 / CH138 (U-NII-2C Band)

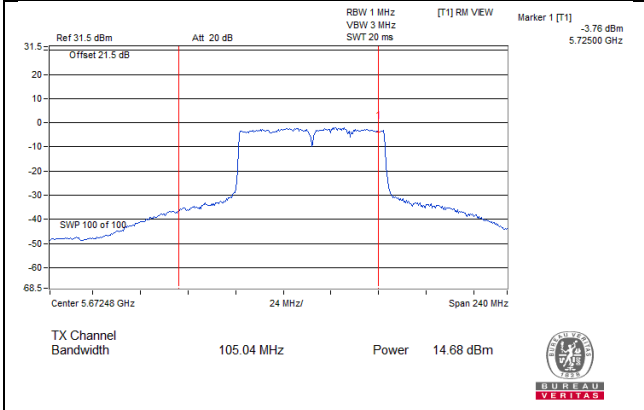

802.11ac (VHT80)_Chain 0 / CH138 (U-NII-3 Band)

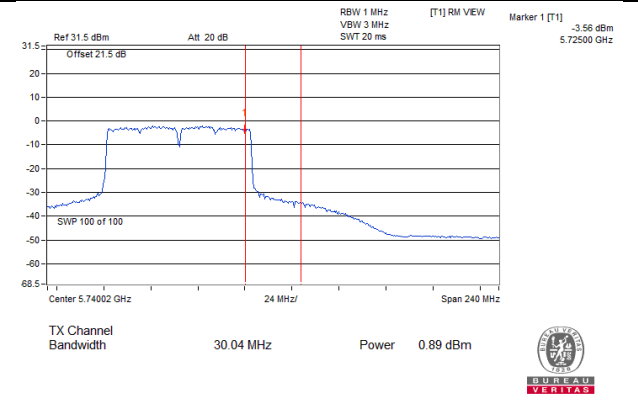

802.11ac (VHT80)_Chain 1 / CH138 (U-NII-2C Band)

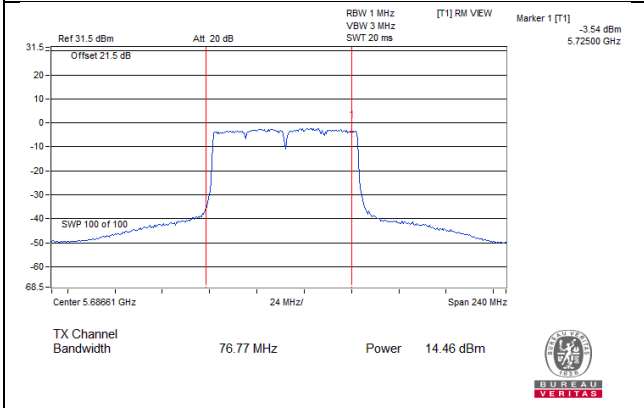

802.11ac (VHT80)_Chain 1 / CH138 (U-NII-3 Band)

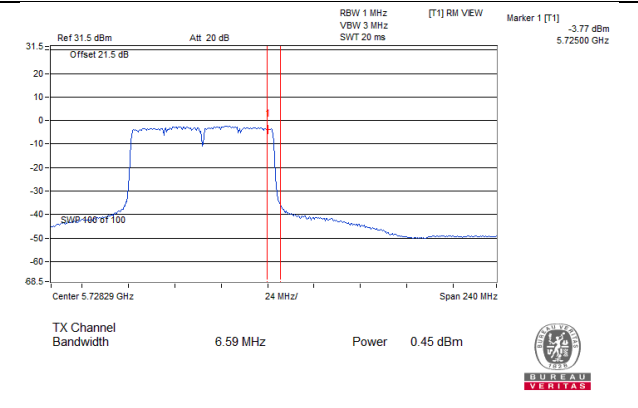

802.11ac (VHT80)_Chain 2 / CH138 (U-NII-2C Band)

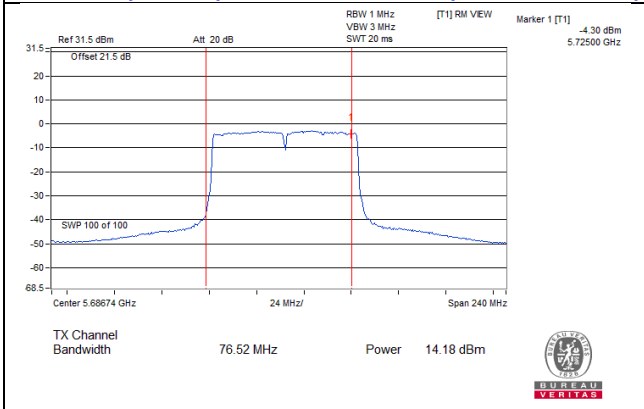

802.11ac (VHT80)_Chain 2 / CH138 (U-NII-3 Band)

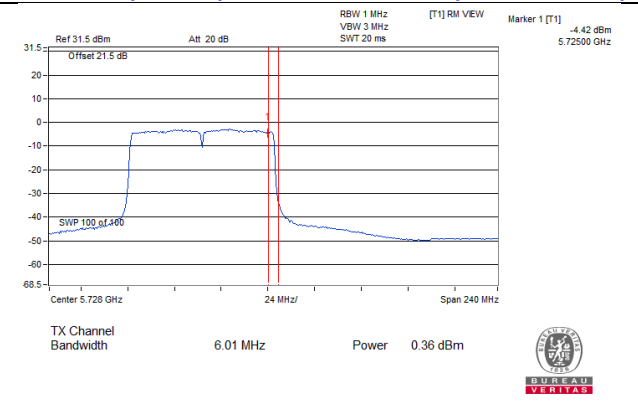

802.11ac (VHT80)_Chain 3 / CH138 (U-NII-2C Band)

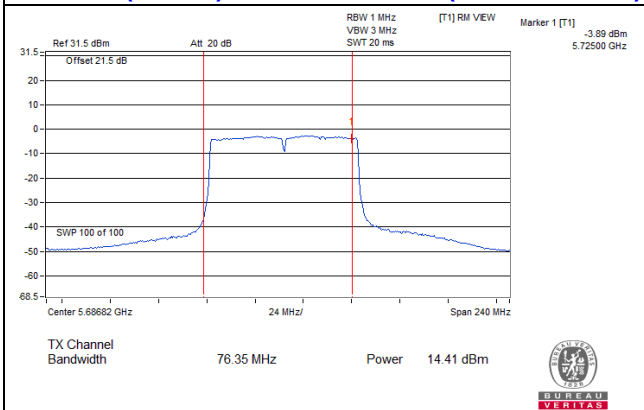

802.11ac (VHT80)_Chain 3 / CH138 (U-NII-3 Band)

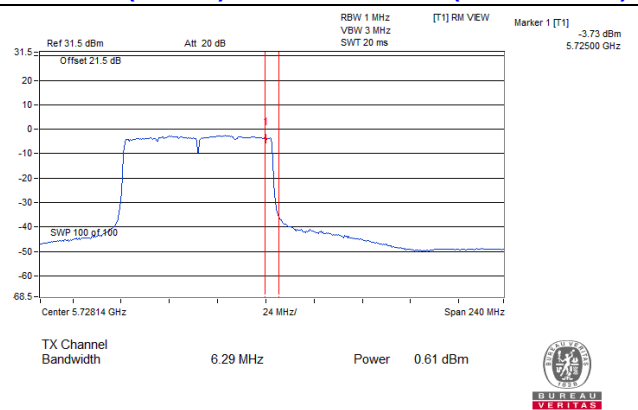

Beamforming Mode

802.11ac (VHT20)

Chan.	Chan. Freq. (MHz)	Maximum Conducted Power (dBm)				Total Power (mW)	Total Power (dBm)	Limit (dBm)	Pass / Fail
		Chain 0	Chain 1	Chain 2	Chain 3				
52	5260	13.61	14.61	14.79	14.99	113.548	20.55	20.95	Pass
60	5300	13.57	14.66	14.76	14.95	113.177	20.54	20.95	Pass
64	5320	13.71	14.72	14.80	14.98	114.821	20.60	20.95	Pass
100	5500	14.54	14.63	14.58	14.96	117.526	20.70	20.89	Pass
116	5580	14.45	14.72	14.62	14.85	117.031	20.68	20.89	Pass
140	5700	14.39	14.59	14.65	14.79	115.557	20.63	20.89	Pass
*144 (UNII-2C Band)	5720	10.47	10.76	10.70	11.46	50.027	16.99	19.87	Pass
*144 (UNII-3 Band)	5720	4.63	4.93	5.09	5.60	13.199	11.21	26.59	Pass

Note: * Test was performed in accordance with Measurement follow FCC KDB 789033 UNII test procedure Method SA-2 and use spectrum analyzer test.

1. For U-NII-2A: The directional gain = $10 \log[(10^{G0/20} + 10^{G1/20} + 10^{G2/20} + 10^{G3/20})^2 / 4] = 9.05\text{dBi} > 6\text{dBi}$, so the power limit shall be reduced to "Determined Conducted Limit-(9.05-6)".
2. For U-NII-2C: The directional gain = $10 \log[(10^{G0/20} + 10^{G1/20} + 10^{G2/20} + 10^{G3/20})^2 / 4] = 9.11\text{dBi} > 6\text{dBi}$, so the power limit shall be reduced to "Determined Conducted Limit-(9.11-6)".
3. For U-NII-3: The directional gain = $10 \log[(10^{G0/20} + 10^{G1/20} + 10^{G2/20} + 10^{G3/20})^2 / 4] = 9.41\text{dBi} > 6\text{dBi}$, so the power limit shall be reduced to $30-(9.41-6) = 26.59\text{dBm}$.

The Total Power for the straddle channel:

Chan.	Chan. Freq. (MHz)	Average Power (mW)	Average Power (dBm)
144	5720	63.226	18.01

Note: The total power was calculated through formula and record the value for reference only.

26dB OCCUPIED BANDWIDTH

Channel	Frequency (MHz)	26dBc Bandwidth (MHz)			
		Chain 0	Chain 1	Chain 2	Chain 3
52	5260	21.81	21.37	21.93	21.93
60	5300	21.78	21.39	21.75	21.89
64	5320	21.78	21.39	21.86	21.97
100	5500	21.72	21.37	21.76	21.79
116	5580	22.92	22.47	22.78	22.94
140	5700	21.76	21.43	21.81	21.80
144 (UNII-2C Band)	5720	16.03	15.78	15.94	15.94

Note: For U_NII-2A, U_NII-2C Band output power limitation is determined based on 26dBc bandwidth.

Power Limit = 11dBm + 10logB < U_NII-2A, U_NII-2C >			
Channel Number	Freq.(MHz)	Min. B(MHz)	Determined Conducted Limit (dBm)
52	5260	21.37	24.29 > 24
60	5300	21.39	24.3 > 24
64	5320	21.39	24.3 > 24
100	5500	21.37	24.29 > 24
116	5580	22.47	24.51 > 24
140	5700	21.43	24.31 > 24
144 (UNII-2C Band)	5720	15.78	22.98 < 24

802.11ac (VHT40)

Chan.	Chan. Freq. (MHz)	Maximum Conducted Power (dBm)				Total Power (mW)	Total Power (dBm)	Limit (dBm)	Pass / Fail
		Chain 0	Chain 1	Chain 2	Chain 3				
54	5270	13.71	15.06	15.07	14.72	117.344	20.69	20.95	Pass
62	5310	13.73	15.02	15.09	14.76	117.582	20.70	20.95	Pass
102	5510	14.82	14.45	14.50	15.30	120.268	20.80	20.89	Pass
110	5550	14.60	14.41	14.49	15.11	116.999	20.68	20.89	Pass
134	5670	14.73	14.53	14.69	14.92	118.586	20.74	20.89	Pass
*142 (UNII-2C Band)	5710	11.69	11.30	11.41	12.23	58.794	17.69	20.89	Pass
*142 (UNII-3 Band)	5710	1.15	0.84	0.90	1.64	5.205	7.16	26.59	Pass

Note: * Test was performed in accordance with Measurement follow FCC KDB 789033 UNII test procedure Method SA-1 and use spectrum analyzer test.

1. For U-NII-2A: The directional gain = $10 \log[(10^{G0/20} + 10^{G1/20} + 10^{G2/20} + 10^{G3/20})^2 / 4] = 9.05\text{dBi} > 6\text{dBi}$, so the power limit shall be reduced to "Determined Conducted Limit-(9.05-6)".

2. For U-NII-2C: The directional gain = $10 \log[(10^{G0/20} + 10^{G1/20} + 10^{G2/20} + 10^{G3/20})^2 / 4] = 9.11\text{dBi} > 6\text{dBi}$, so the power limit shall be reduced to "Determined Conducted Limit-(9.11-6)".

3. For U-NII-3: The directional gain = $10 \log[(10^{G0/20} + 10^{G1/20} + 10^{G2/20} + 10^{G3/20})^2 / 4] = 9.41\text{dBi} > 6\text{dBi}$, so the power limit shall be reduced to $30-(9.41-6) = 26.59\text{dBm}$.

The Total Power for the straddle channel:

Chan.	Chan. Freq. (MHz)	Average Power (mW)	Average Power (dBm)
142	5710	63.999	18.06

Note: The total power was calculated through formula and record the value for reference only.

26dB BANDWIDTH:

Channel	Frequency (MHz)	26dBc Bandwidth (MHz)			
		Chain 0	Chain 1	Chain 2	Chain 3
54	5270	41.54	41.11	54.52	54.09
62	5310	41.52	41.15	59.26	43.88
102	5510	41.48	41.24	41.45	41.55
110	5550	41.58	41.21	53.42	41.45
134	5670	41.71	41.28	50.10	43.45
142 (UNII-2C Band)	5710	36.04	35.82	37.55	41.02

Note: For U_NII-2A, U_NII-2C Band output power limitation is determined based on 26dBc bandwidth.

Power Limit = 11dBm + 10logB < U_NII-2A, U_NII-2C >			
Channel Number	Freq.(MHz)	Min. B(MHz)	Determined Conducted Limit (dBm)
54	5270	41.11	27.13 > 24
62	5310	41.15	27.14 > 24
102	5510	41.24	27.15 > 24
110	5550	41.21	27.15 > 24
134	5670	41.28	27.15 > 24
142 (UNII-2C Band)	5710	35.82	26.54 > 24

802.11ac (VHT80)

Chan.	Chan. Freq. (MHz)	Maximum Conducted Power (dBm)				Total Power (mW)	Total Power (dBm)	Limit (dBm)	Pass / Fail
		Chain 0	Chain 1	Chain 2	Chain 3				
58	5290	13.74	14.64	15.13	15.23	118.693	20.74	20.95	Pass
106	5530	14.33	14.37	14.29	14.71	110.888	20.45	20.89	Pass
122	5610	15.01	14.96	14.20	14.76	119.255	20.76	20.89	Pass
*138 (UNII-2C Band)	5690	12.13	11.71	11.55	11.40	64.67	18.11	20.89	Pass
*138 (UNII-3 Band)	5690	-1.68	-2.04	-2.35	-2.25	2.7093	4.33	26.59	Pass

Note: * Test was performed in accordance with Measurement follow FCC KDB 789033 UNII test procedure Method SA-2 and use spectrum analyzer test.

1. For U-NII-2A: The directional gain = $10 \log[(10^{G0/20} + 10^{G1/20} + 10^{G2/20} + 10^{G3/20})^2 / 4] = 9.05\text{dBi} > 6\text{dBi}$, so the power limit shall be reduced to "Determined Conducted Limit-(9.05-6)".

2. For U-NII-2C: The directional gain = $10 \log[(10^{G0/20} + 10^{G1/20} + 10^{G2/20} + 10^{G3/20})^2 / 4] = 9.11\text{dBi} > 6\text{dBi}$, so the power limit shall be reduced to "Determined Conducted Limit-(9.11-6)".

3. For U-NII-3: The directional gain = $10 \log[(10^{G0/20} + 10^{G1/20} + 10^{G2/20} + 10^{G3/20})^2 / 4] = 9.41\text{dBi} > 6\text{dBi}$, so the power limit shall be reduced to $30 - (9.41 - 6) = 26.59\text{dBm}$.

The Total Power for the straddle channel:

Chan.	Chan. Freq. (MHz)	Average Power (mW)	Average Power (dBm)
138	5690	67.3793	18.29

Note: The total power was calculated through formula and record the value for reference only.

26dB BANDWIDTH:

Channel	Frequency (MHz)	26dBc Bandwidth (MHz)			
		Chain 0	Chain 1	Chain 2	Chain 3
58	5290	82.81	82.54	82.31	82.05
106	5530	83.22	82.48	82.32	82.12
122	5610	147.42	83.00	82.22	82.63
138 (UNII-2C Band)	5690	105.04	76.77	76.52	76.35

Note: For U_NII-2A, U_NII-2C Band output power limitation is determined based on 26dBc bandwidth.

Power Limit = 11dBm + 10logB < U_NII-2A, U_NII-2C >			
Channel Number	Freq.(MHz)	Min. B(MHz)	Determined Conducted Limit (dBm)
58	5290	82.05	30.14 > 24
106	5530	82.12	30.14 > 24
122	5610	82.22	30.14 > 24
138 (UNII-2C Band)	5690	76.35	29.82 > 24

Spectrum Plot of Worst Value

802.11a / Chain 2 - CH144 (UNII-2C Band)

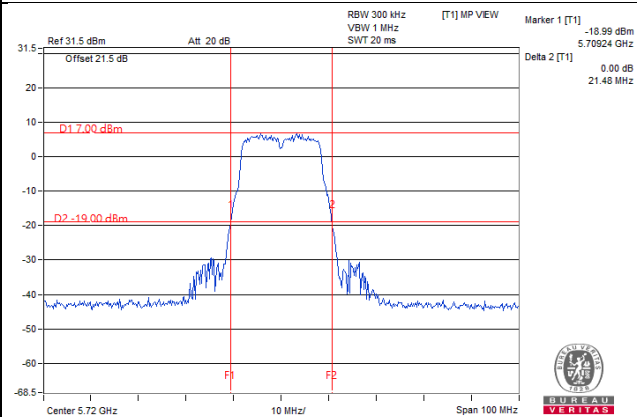

802.11ac (VHT20) / Chain 1 - CH144 (UNII-2C Band)

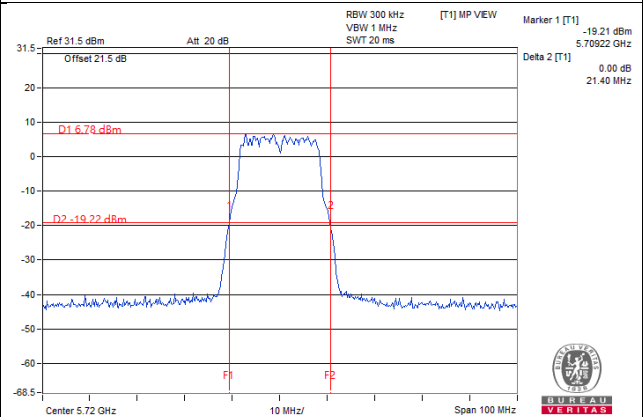

802.11ac (VHT40) / Chain 1 - CH142 (UNII-2C Band)

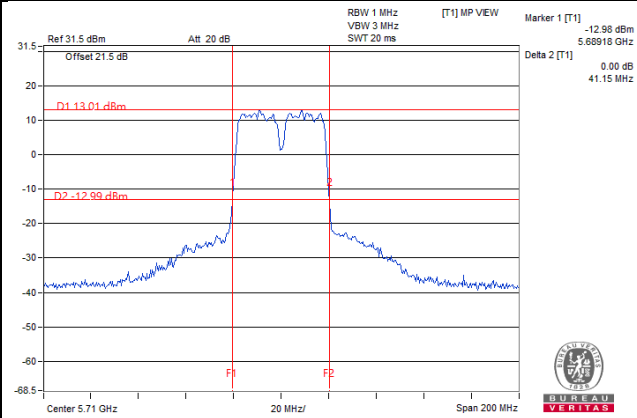

802.11ac (VHT80) / Chain 3 - CH138 (UNII-2C Band)

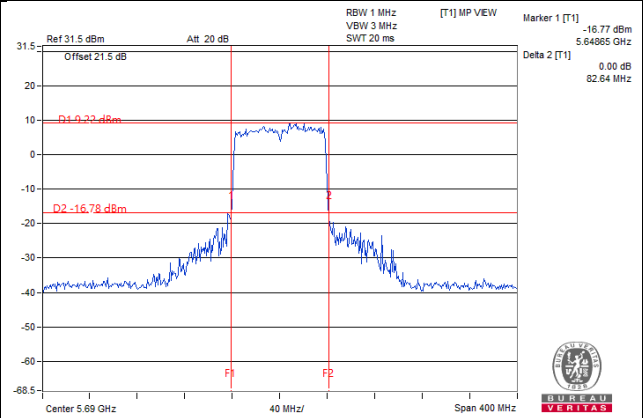

Note:

- For CH144 (U-NII-2C) = 5725MHz - Marker 1
- For CH142 (U-NII-2C) = 5725MHz - Marker 1
- For CH138 (U-NII-2C) = 5725MHz - Marker 1

For channel straddling 5725MHz of Power

Beamforming Mode

Spectrum Plot Value of Power

802.11ac (VHT20)_Chain 0 / CH144 (U-NII-2C Band) 802.11ac (VHT20)_Chain 0 / CH144 (U-NII-3 Band)

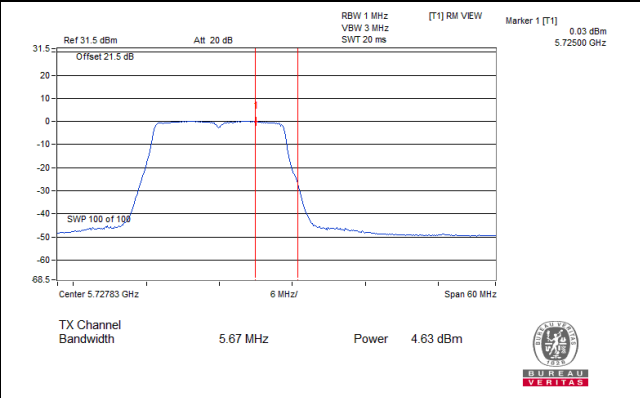
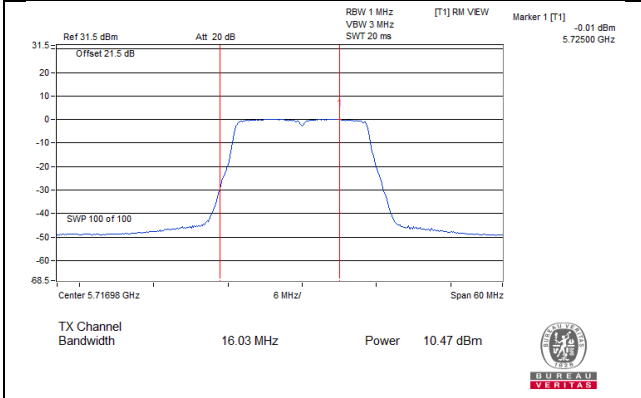

802.11ac (VHT20)_Chain 1 / CH144 (U-NII-2C Band)

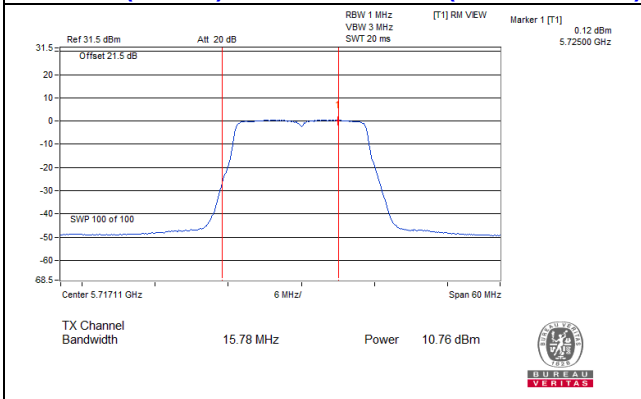

802.11ac (VHT20)_Chain 1 / CH144 (U-NII-3 Band)

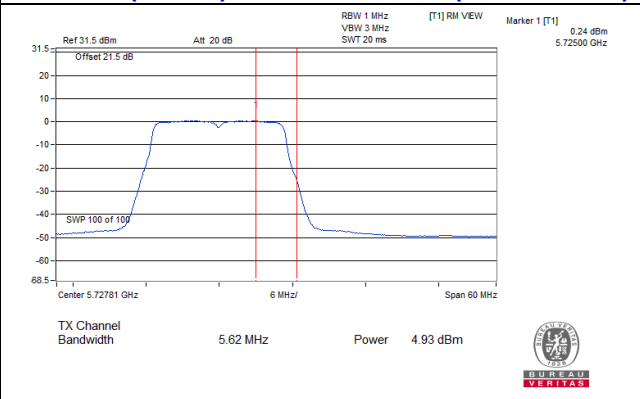

802.11ac (VHT20)_Chain 2 / CH144 (U-NII-2C Band)

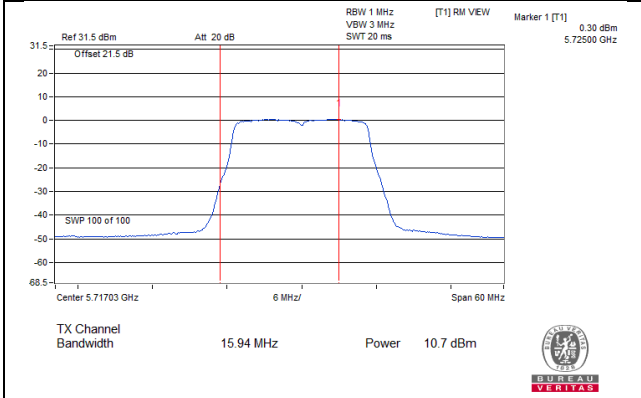

802.11ac (VHT20)_Chain 2 / CH144 (U-NII-3 Band)

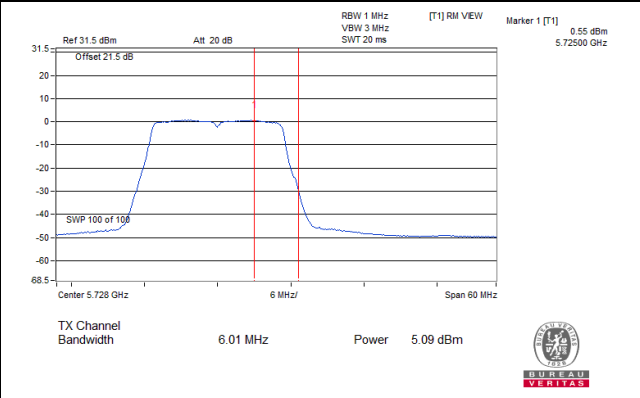

802.11ac (VHT20)_Chain 3 / CH144 (U-NII-2C Band)

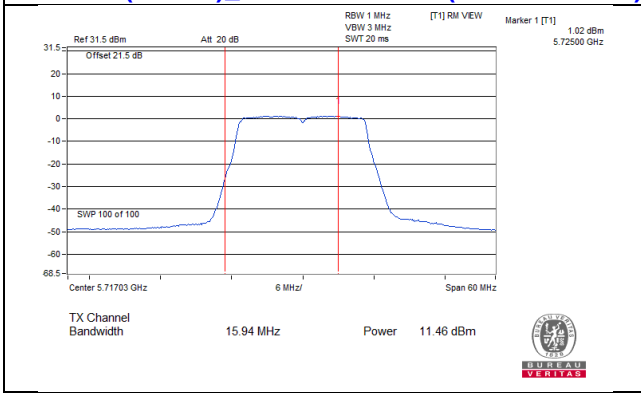

802.11ac (VHT20)_Chain 3 / CH144 (U-NII-3 Band)

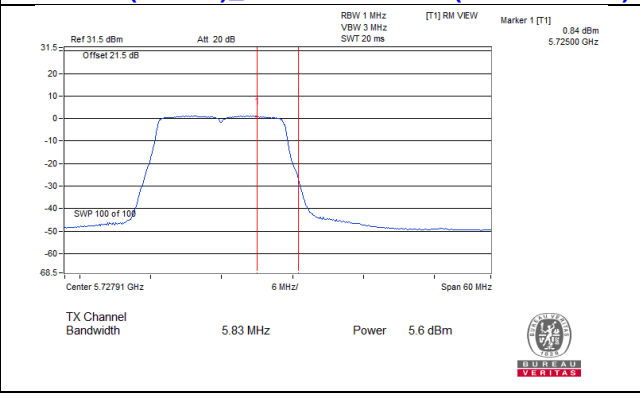

Spectrum Plot Value of Power

802.11ac (VHT40)_Chain 0 / CH142 (U-NII-2C Band)

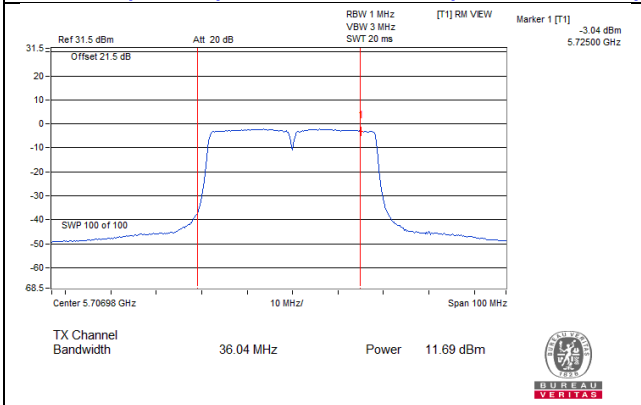

802.11ac (VHT40)_Chain 0 / CH142 (U-NII-3 Band)

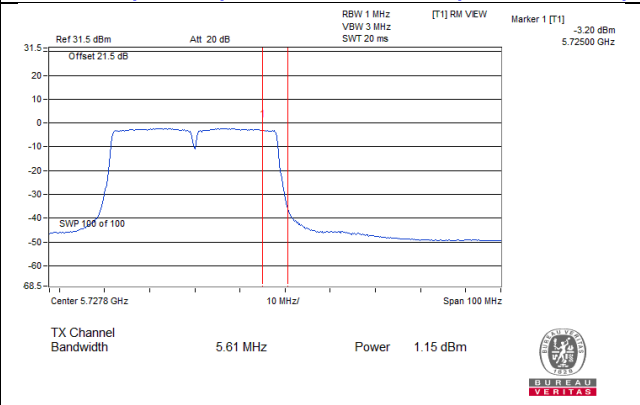

802.11ac (VHT40)_Chain 1 / CH142 (U-NII-2C Band)

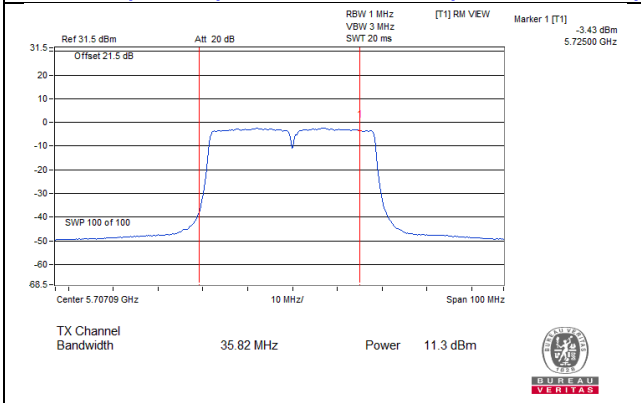

802.11ac (VHT40)_Chain 1 / CH142 (U-NII-3 Band)

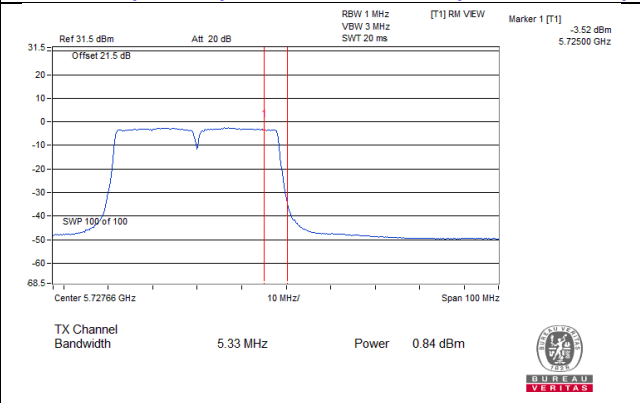

802.11ac (VHT40)_Chain 2 / CH142 (U-NII-2C Band)

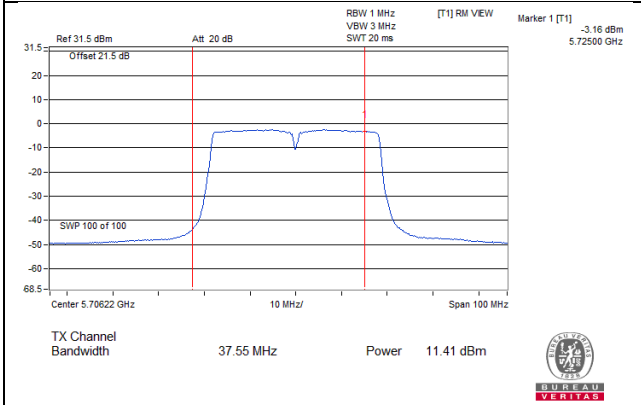

802.11ac (VHT40)_Chain 2 / CH142 (U-NII-3 Band)

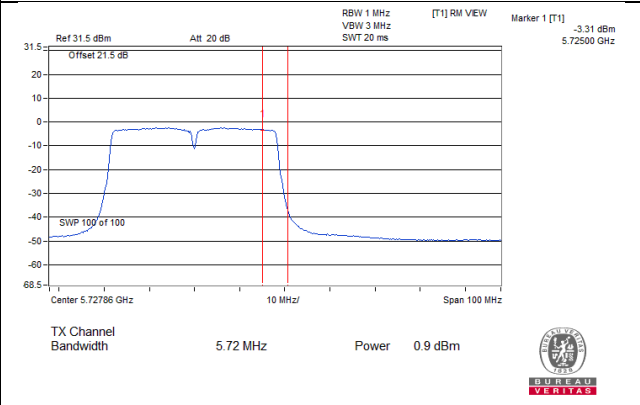

802.11ac (VHT40)_Chain 3 / CH142 (U-NII-2C Band)

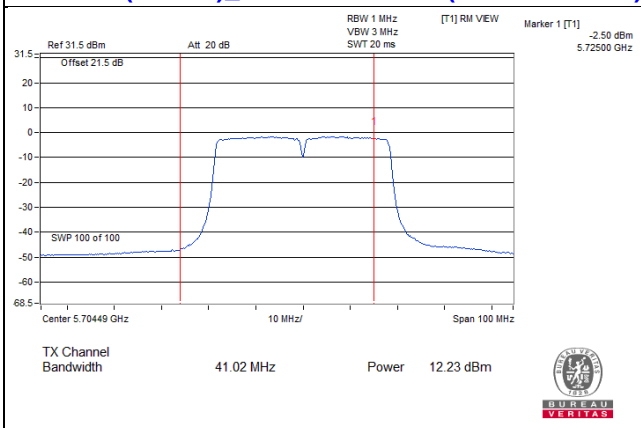

802.11ac (VHT40)_Chain 3 / CH142 (U-NII-3 Band)

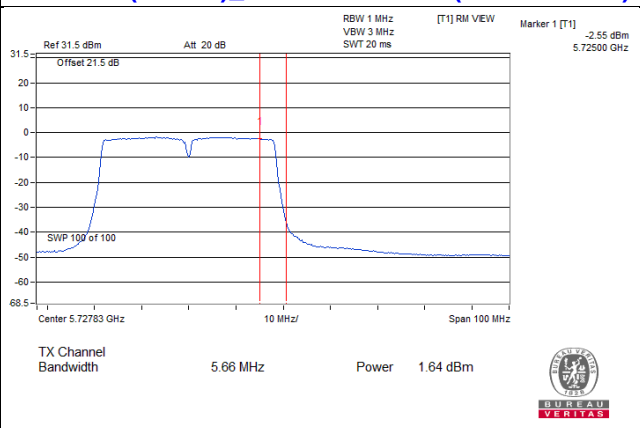

Spectrum Plot Value of Power

802.11ac (VHT80)_Chain 0 / CH138 (U-NII-2C Band)

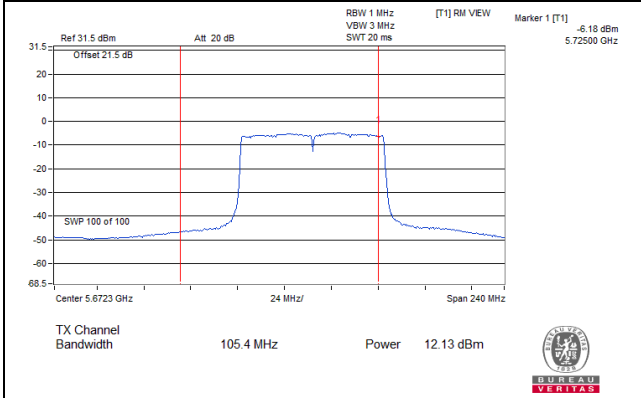

802.11ac (VHT80)_Chain 0 / CH138 (U-NII-3 Band)

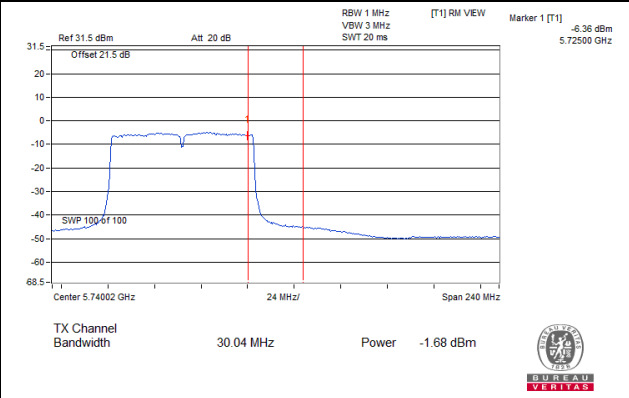

802.11ac (VHT80)_Chain 1 / CH138 (U-NII-2C Band)

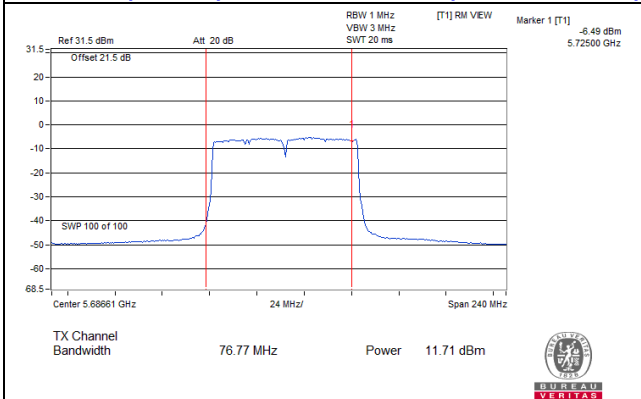

802.11ac (VHT80)_Chain 1 / CH138 (U-NII-3 Band)

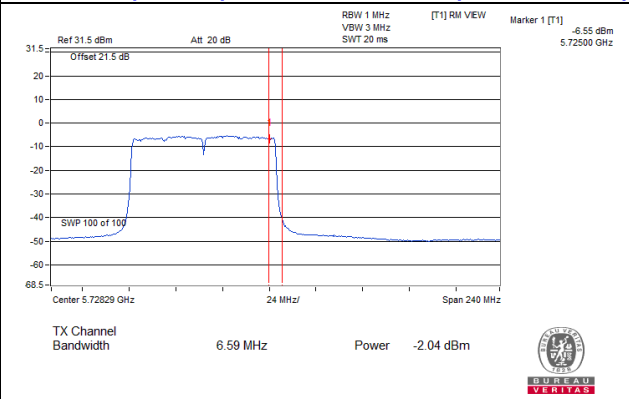

802.11ac (VHT80)_Chain 0 / CH138 (U-NII-2C Band)

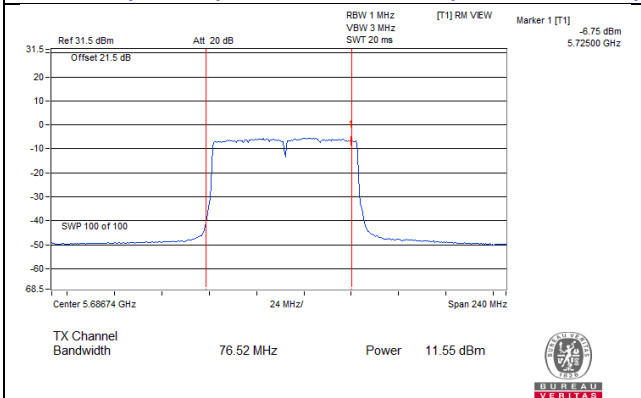

802.11ac (VHT80)_Chain 0 / CH138 (U-NII-3 Band)

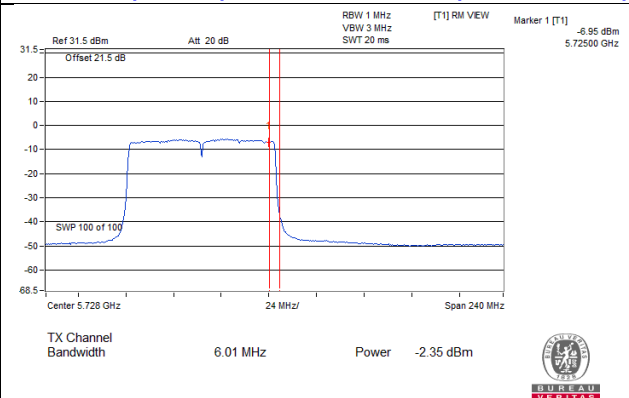

802.11ac (VHT80)_Chain 1 / CH138 (U-NII-2C Band)

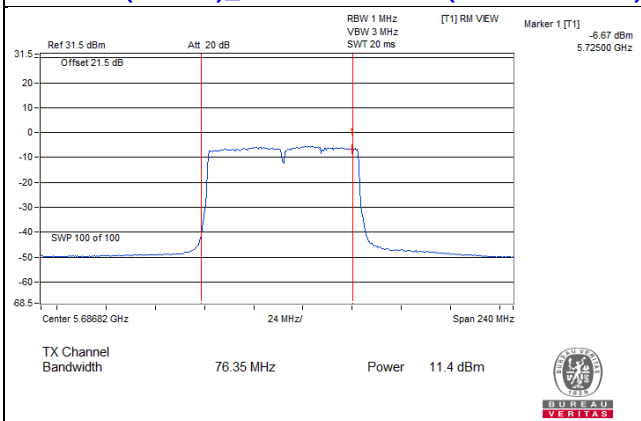

802.11ac (VHT80)_Chain 1 / CH138 (U-NII-3 Band)

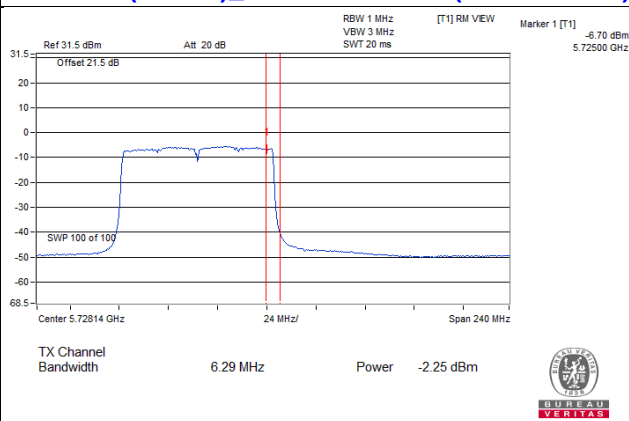

For channel straddling 5725MHz of 26dB BW

Spectrum Plot Value of 26dB BW

802.11a_Chain 0 / CH144 (U-NII-2C Band)

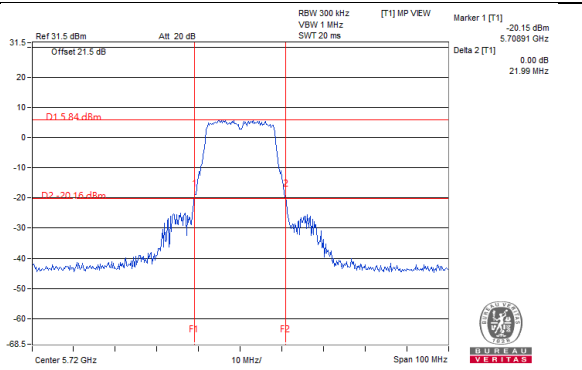

802.11ac (VHT20)_Chain 0 / CH144 (U-NII-2C Band)

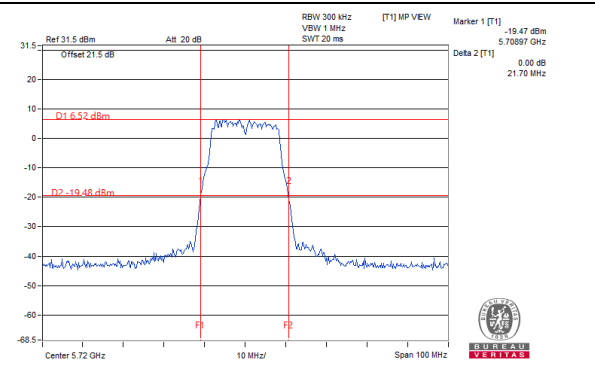

802.11a_Chain 1 / CH144 (U-NII-2C Band)

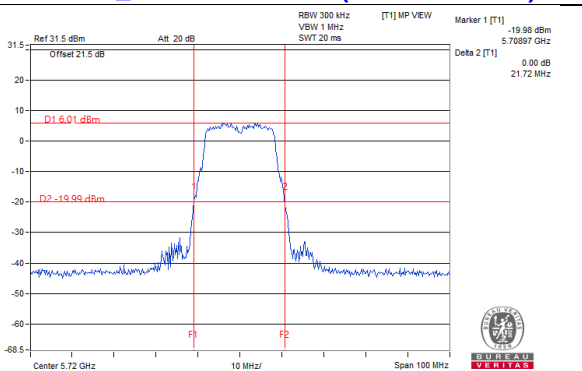

802.11ac (VHT20)_Chain 1 / CH144 (U-NII-2C Band)

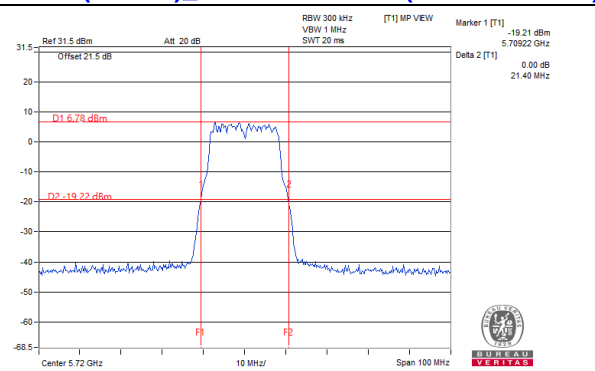

802.11a_Chain 2 / CH144 (U-NII-2C Band)

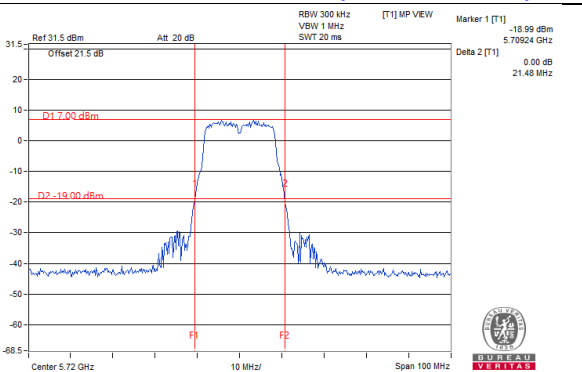

802.11ac (VHT20)_Chain 2 / CH144 (U-NII-2C Band)

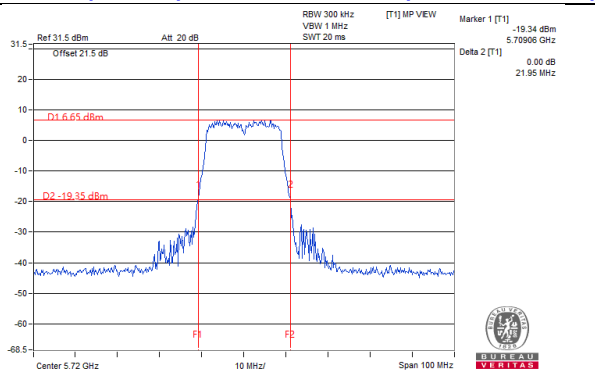

802.11a_Chain 3 / CH144 (U-NII-2C Band)

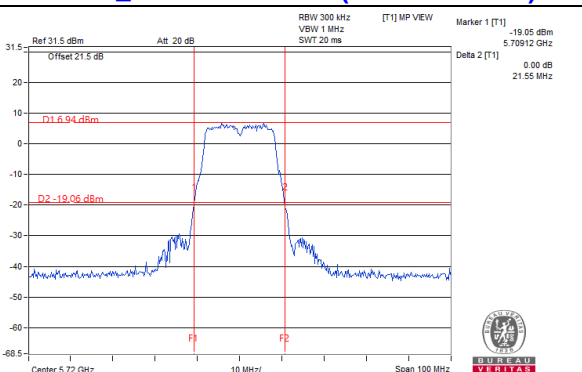

802.11ac (VHT20)_Chain 3 / CH144 (U-NII-2C Band)

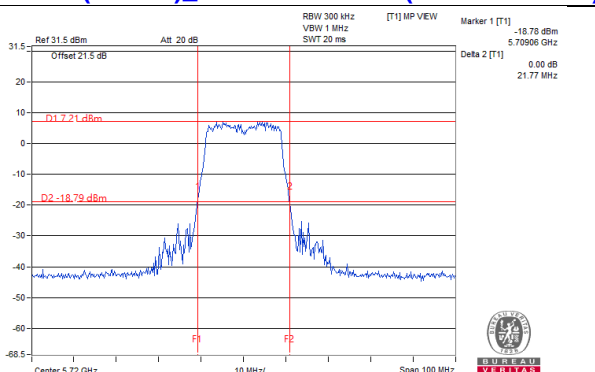

Note:

For CH144 (U-NII-2C) = 5725MHz - Marker 1

Spectrum Plot Value of 26dB BW

802.11ac (VHT40)_Chain 0 / CH142 (U-NII-2C Band) 802.11ac (VHT80)_Chain 0 / CH138 (U-NII-2C Band)

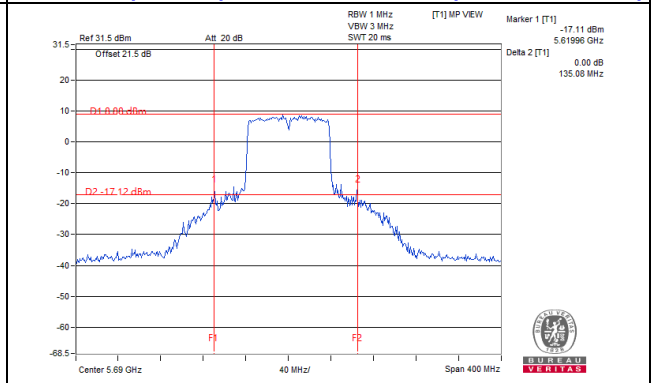
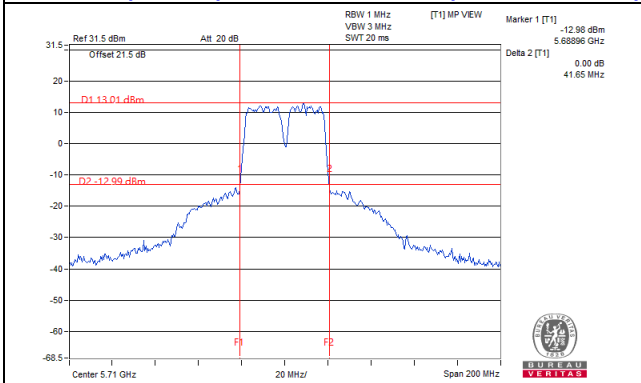

802.11ac (VHT40)_Chain 1 / CH142 (U-NII-2C Band) 802.11ac (VHT80)_Chain 1 / CH138 (U-NII-2C Band)

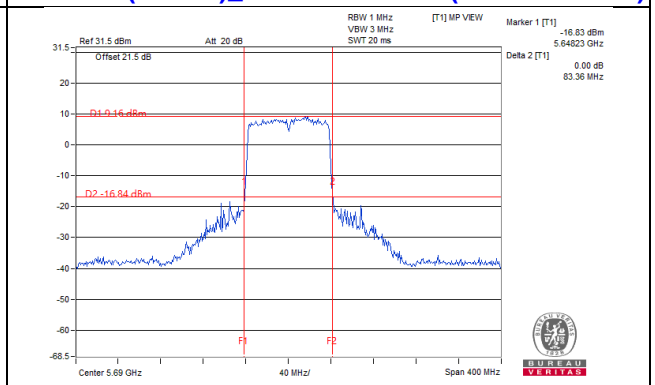
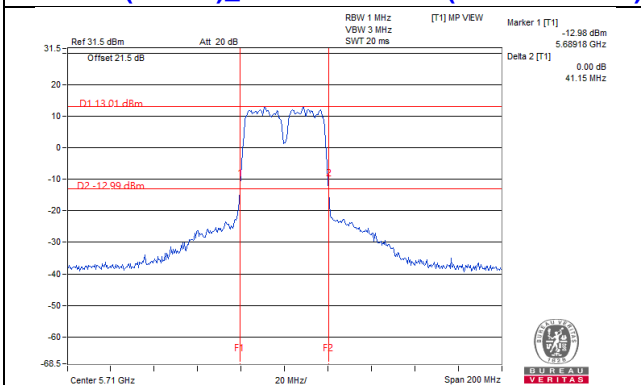

802.11ac (VHT40)_Chain 2 / CH142 (U-NII-2C Band) 802.11ac (VHT80)_Chain 0 / CH138 (U-NII-2C Band)

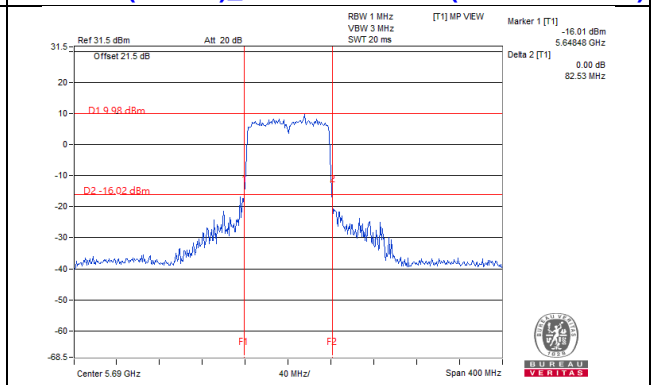
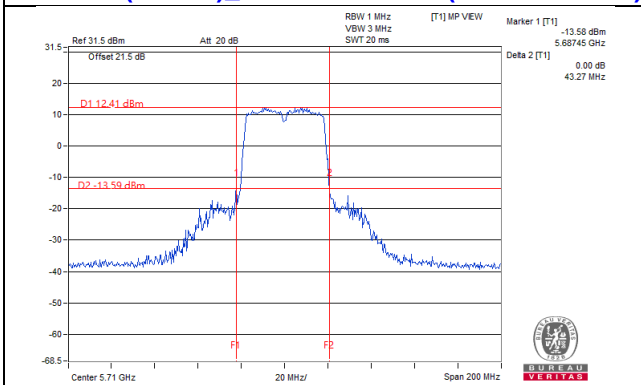

802.11ac (VHT40)_Chain 3 / CH142 (U-NII-2C Band) 802.11ac (VHT80)_Chain 1 / CH138 (U-NII-2C Band)

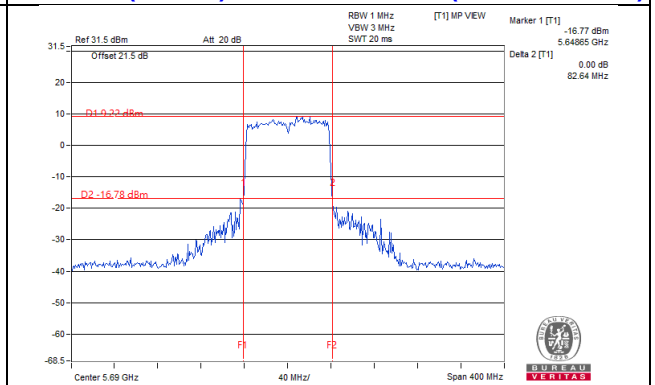
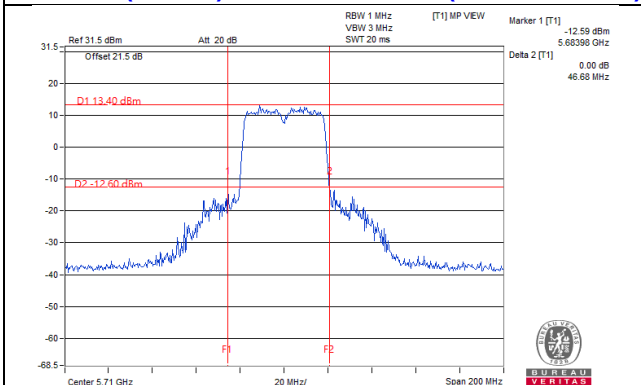

Note:

- For CH144 (U-NII-2C) = 5725MHz - Marker 1
- For CH142 (U-NII-2C) = 5725MHz - Marker 1
- For CH138 (U-NII-2C) = 5725MHz - Marker 1

4.4 Occupied Bandwidth Measurement

4.4.1 Test Setup

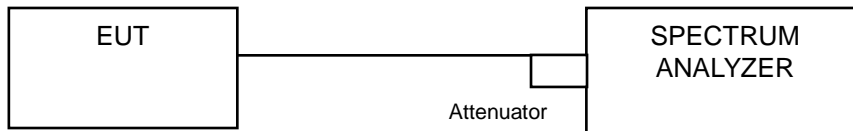

4.4.2 Test Instruments

Refer to section 4.1.2 to get information of above instrument.

4.4.3 Test Procedure

The transmitter output was connected to the spectrum analyzer through an attenuator. The bandwidth of the fundamental frequency was measured by spectrum analyzer with resolution bandwidth in the range of 1% to 5% of the anticipated emission bandwidth, and a video bandwidth at least 3x the resolution bandwidth and set the detector to SAMPLE. The width of a frequency band such that, below the lower and above the upper frequency limits, the mean powers emitted are each equal to a specified percentage 0.5% of the total mean power of a given emission.

4.4.4 Test Results

802.11a

Channel	Channel Frequency (MHz)	Occupied Bandwidth (MHz)			
		Chain 0	Chain 1	Chain 2	Chain 3
52	5260	16.92	17.04	16.80	16.80
60	5300	16.92	16.92	16.92	16.92
64	5320	17.04	16.92	17.04	16.92
100	5500	16.92	16.92	17.04	16.80
116	5580	17.04	17.04	17.04	16.92
140	5700	16.80	16.92	16.92	16.80
144 (U-NII-2C Band)	5720	13.64	13.52	13.64	13.64
144 (U-NII-3 Band)	5720	3.40	3.40	3.28	3.28

802.11ac (VHT20)

Channel	Channel Frequency (MHz)	Occupied Bandwidth (MHz)			
		Chain 0	Chain 1	Chain 2	Chain 3
52	5260	17.04	16.92	18.12	18.00
60	5300	17.16	16.92	18.00	18.00
64	5320	17.04	16.92	18.00	17.88
100	5500	17.28	16.92	18.00	18.00
116	5580	17.04	16.68	18.00	18.12
140	5700	17.16	16.80	18.00	18.00
144 (U-NII-2C Band)	5720	13.76	13.52	14.00	14.12
144 (U-NII-3 Band)	5720	3.40	3.28	3.88	4.00

802.11ac (VHT40)

Channel	Channel Frequency (MHz)	Occupied Bandwidth (MHz)			
		Chain 0	Chain 1	Chain 2	Chain 3
54	5270	36.72	36.72	36.72	36.48
62	5310	36.96	36.72	36.48	36.72
102	5510	36.72	36.72	36.72	36.72
110	5550	36.48	36.72	36.72	36.48
134	5670	36.72	36.72	36.72	36.72
142 (U-NII-2C Band)	5710	33.72	33.48	33.48	33.48
142 (U-NII-3 Band)	5710	3.24	3.24	3.00	3.24

802.11ac (VHT80)

Channel	Channel Frequency (MHz)	Occupied Bandwidth (MHz)			
		Chain 0	Chain 1	Chain 2	Chain 3
58	5290	76.32	76.32	76.32	76.32
106	5530	75.84	75.84	75.84	75.84
122	5610	76.32	76.32	75.84	76.32
138 (U-NII-2C Band)	5690	73.40	73.40	72.92	72.92
138 (U-NII-3 Band)	5690	2.92	2.92	2.92	2.92

Spectrum Plot of Max. Value

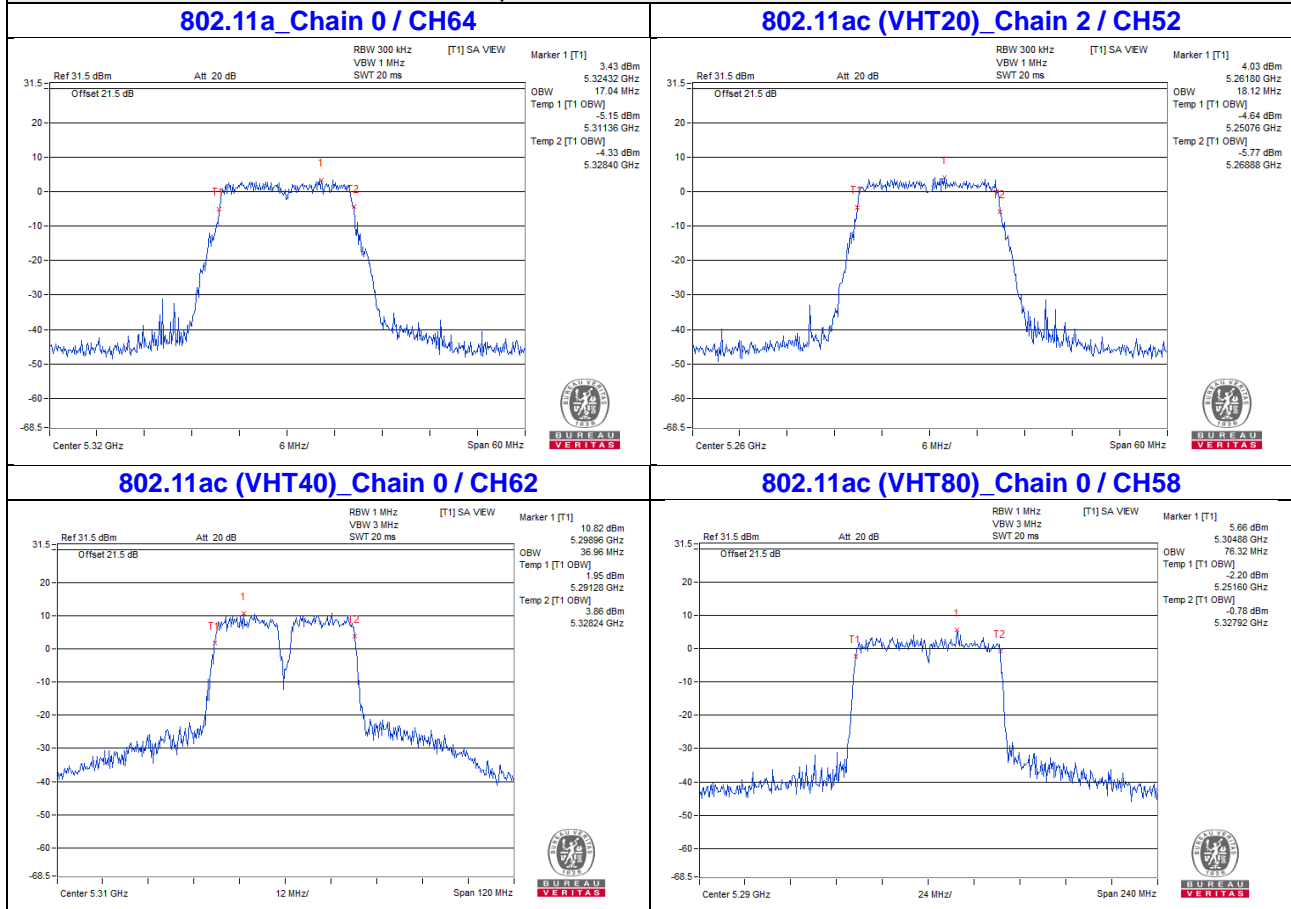

For channel straddling 5725MHz of OCP99 BW

Spectrum Plot Value of channel straddling 5725MHz

802.11a_Chain 0 / CH144

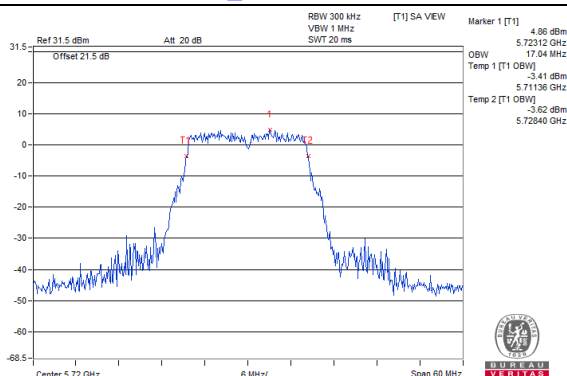

802.11ac (VHT20)_Chain 0 / CH144

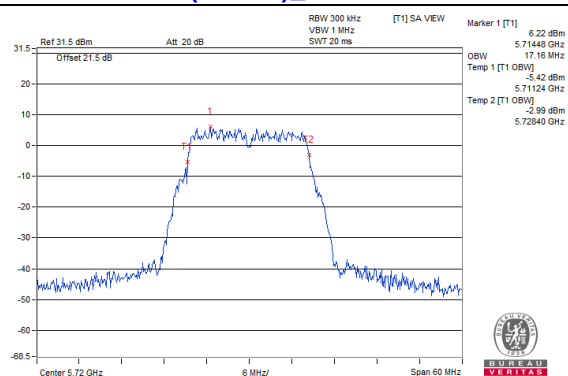

802.11a_Chain 1 / CH144

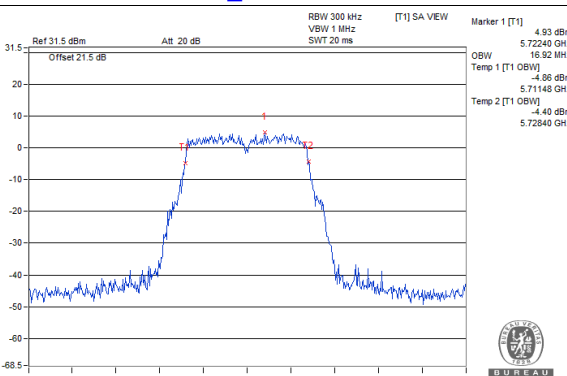

802.11ac (VHT20)_Chain 1 / CH144

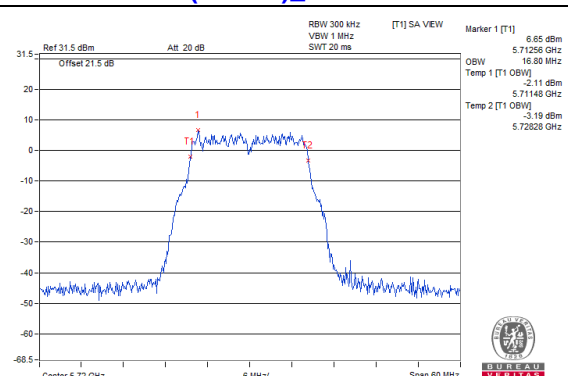

802.11a_Chain 2 / CH144

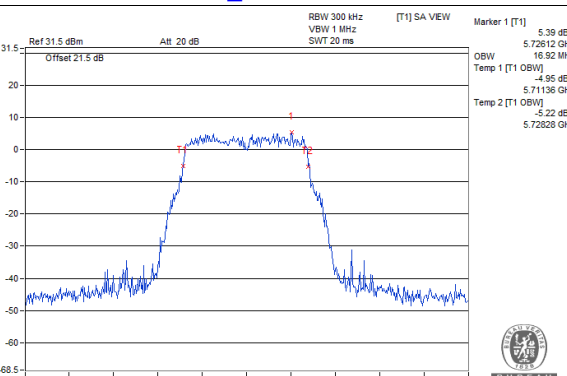

802.11ac (VHT20)_Chain 2 / CH144

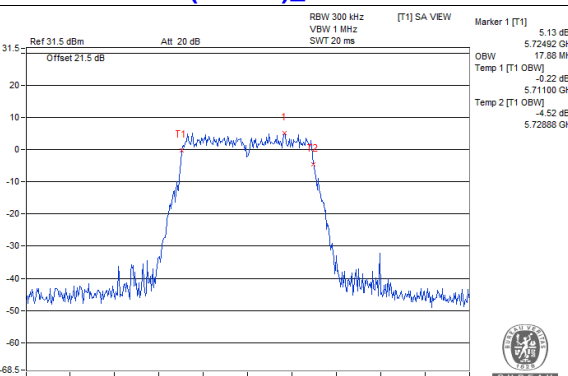

802.11a_Chain 3 / CH144

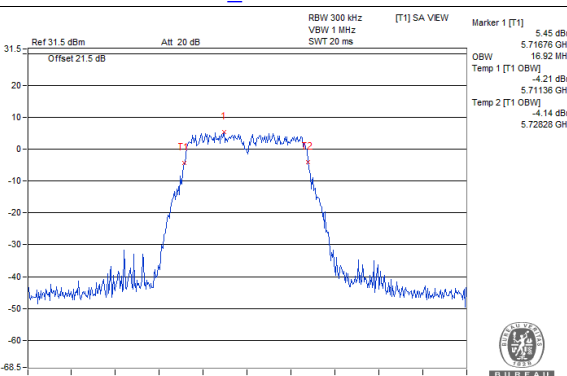

802.11ac (VHT20)_Chain 3 / CH144

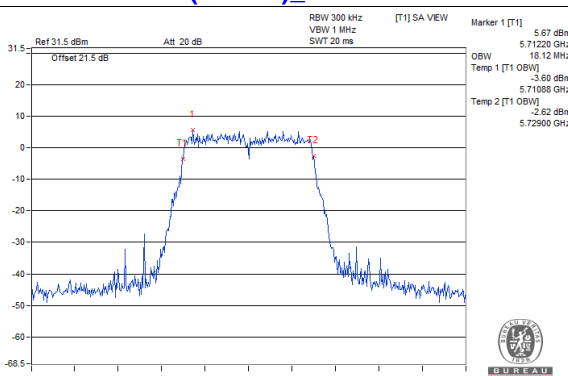

Spectrum Plot Value of channel straddling 5725MHz

802.11ac (VHT40)_Chain 0 / CH142

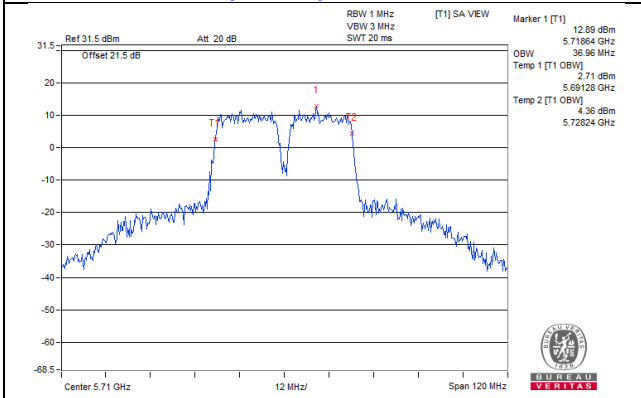

802.11ac (VHT80)_Chain 0 / CH138

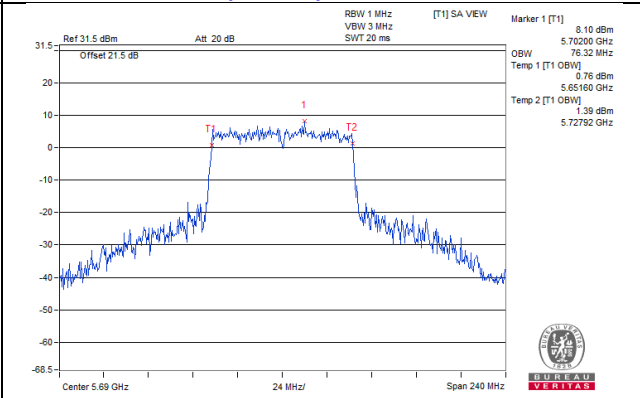

802.11ac (VHT40)_Chain 1 / CH142

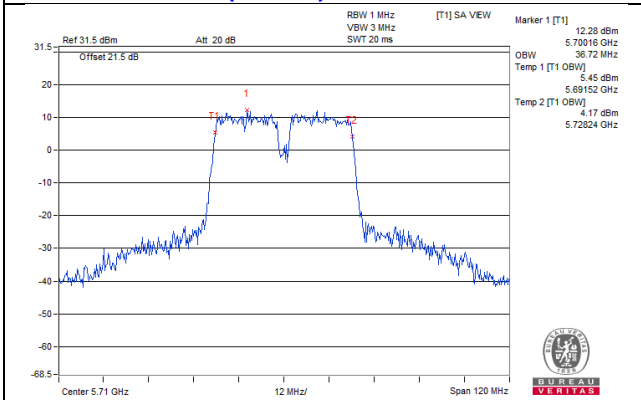

802.11ac (VHT80)_Chain 1 / CH138

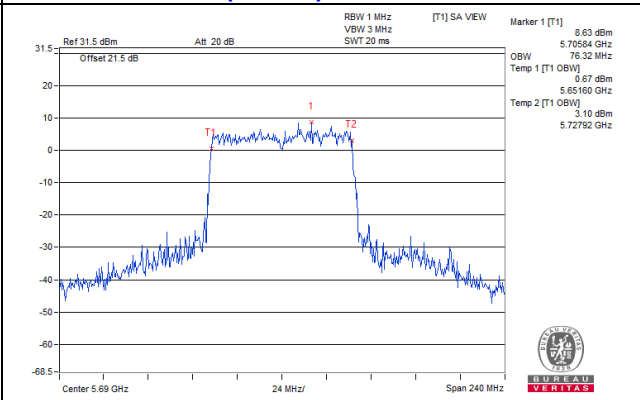

802.11ac (VHT40)_Chain 2 / CH142

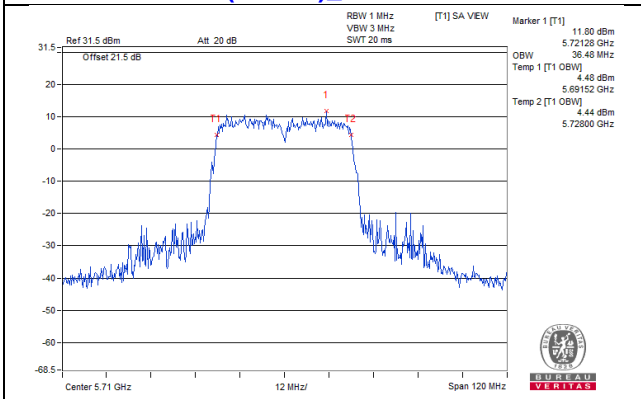

802.11ac (VHT80)_Chain 2 / CH138

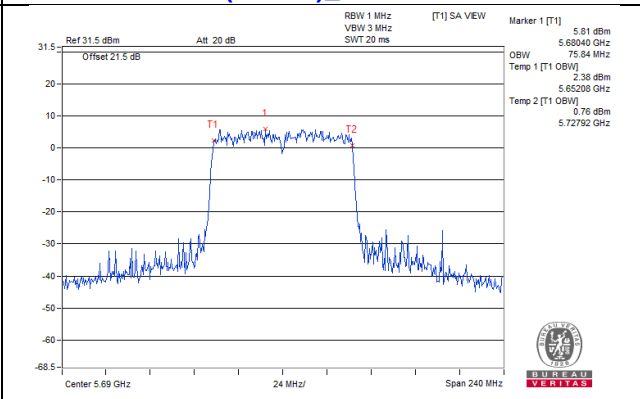

802.11ac (VHT40)_Chain 3 / CH142

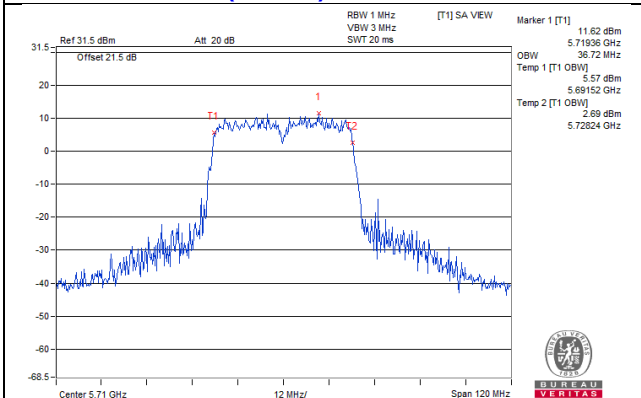

802.11ac (VHT80)_Chain 3 / CH138

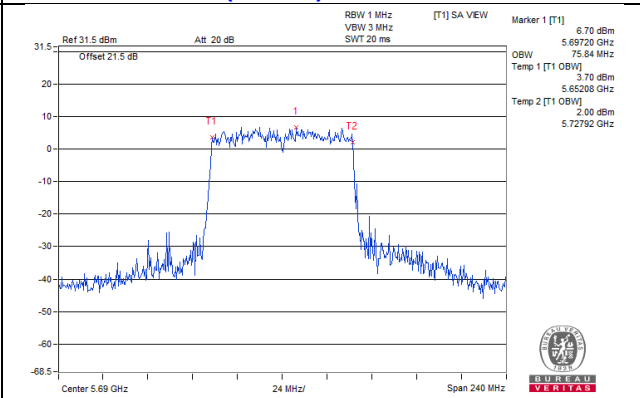

Note:

For CH144 (U-NII-2C) = 5725MHz - Temp 1
For CH142 (U-NII-2C) = 5725MHz - Temp 1
For CH138 (U-NII-2C) = 5725MHz - Temp 1
For CH144 (U-NII-3) = Temp 2 - 5725MHz
For CH142 (U-NII-3) = Temp 2 - 5725MHz
For CH138 (U-NII-3) = Temp 2 - 5725MHz

4.5 Peak Power Spectral Density Measurement

4.5.1 Limits of Peak Power Spectral Density Measurement

Operation Band	EUT Category		Limit
U-NII-1		Outdoor Access Point	17dBm/ MHz
		Fixed point-to-point Access Point	
		Indoor Access Point	
		Client device	11dBm/ MHz
U-NII-2A		√	11dBm/ MHz
U-NII-2C		√	11dBm/ MHz
U-NII-3		√	30dBm/ 500kHz

4.5.2 Test Setup

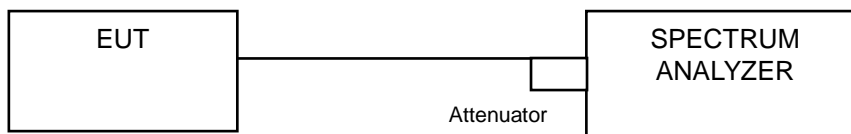

4.5.3 Test Instruments

Refer to section 4.1.2 to get information of above instrument.

4.5.4 Test Procedure

802.11ac (VHT40)

For U-NII-2A, U-NII-2C band:

Using method SA-1

1. Set span to encompass the entire emission bandwidth (EBW) of the signal.
2. Set RBW = 1 MHz, Set VBW ≥ 3 MHz, Detector = RMS
3. Sweep time = auto, trigger set to “free run”.
4. Trace average at least 100 traces in power averaging mode.
5. Record the max value

For U-NII-3:

1. Set span to encompass the entire emission bandwidth (EBW) of the signal.
2. Set RBW = 300 kHz, Set VBW ≥ 1 MHz, Detector = RMS
3. Use the peak marker function to determine the maximum power level in any 300 kHz band segment within the fundamental EBW.
4. Scale the observed power level to an equivalent value in 500 kHz by adjusting (reducing) the measured power by a bandwidth correction factor (BWCF) where $BWCF = 10\log(500\text{ kHz}/300\text{ kHz})$
5. Sweep time = auto, trigger set to “free run”.
6. Trace average at least 100 traces in power averaging mode.
7. Record the max value

802.11a, 802.11ac (VHT20), 802.11ac (VHT80)

For U-NII-2A, U-NII-2C band:

Using method SA-2

1. Set span to encompass the entire emission bandwidth (EBW) of the signal.
2. Set RBW = 1 MHz, Set VBW \geq 3 MHz, Detector = RMS
3. Sweep time = auto, trigger set to "free run".
4. Trace average at least 100 traces in power averaging mode.
5. Record the max value and add $10 \log (1/\text{duty cycle})$

For U-NII-3:

1. Set span to encompass the entire emission bandwidth (EBW) of the signal.
2. Set RBW = 300 kHz, Set VBW \geq 1 MHz, Detector = RMS
3. Use the peak marker function to determine the maximum power level in any 300 kHz band segment within the fundamental EBW.
4. Scale the observed power level to an equivalent value in 500 kHz by adjusting (reducing) the measured power by a bandwidth correction factor (BWCF) where $\text{BWCF} = 10 \log(500 \text{ kHz}/300 \text{ kHz})$
5. Sweep time = auto, trigger set to "free run".
6. Trace average at least 100 traces in power averaging mode.
7. Record the max value and add $10 \log (1/\text{duty cycle})$

4.5.5 Deviation from Test Standard

No deviation.

4.5.6 EUT Operating Condition

Same as Item 4.3.6.

4.5.7 Test Results

For U-NII-2A~2C:

802.11a

Chan.	Chan. Freq. (MHz)	PSD W/O Duty Factor (dBm/MHz)				Duty Factor (dB)	Total PSD With Duty Factor (dBm/MHz)	Max. Limit (dBm/MHz)	Pass / Fail
		Chain 0	Chain 1	Chain 2	Chain 3				
52	5260	0.36	1.71	1.59	1.78	0.09	7.51	7.95	Pass
60	5300	0.19	1.52	1.79	2.04	0.09	7.55	7.95	Pass
64	5320	0.19	1.84	1.82	2.05	0.09	7.65	7.95	Pass
100	5500	1.53	1.48	1.10	2.06	0.09	7.67	7.89	Pass
116	5580	2.01	1.62	1.45	1.39	0.09	7.73	7.89	Pass
140	5700	1.64	1.60	1.23	1.77	0.09	7.68	7.89	Pass
144 (U-NII-2C Band)	5720	1.74	1.61	1.41	1.88	0.09	7.77	7.89	Pass

Note: * Test was performed in accordance with Measurement follow FCC KDB 789033 UNII test procedure Method SA-2 and use spectrum analyzer test.

1. For U-NII-2A: The directional gain = $10 \log[(10^{G0/20} + 10^{G1/20} + 10^{G2/20} + 10^{G3/20})^2 / 4] = 9.05\text{dBi} > 6\text{dBi}$, so the power density limit shall be reduced to $11-(9.05-6) = 7.95\text{dBm}$
2. For U-NII-2C: The directional gain = $10 \log[(10^{G0/20} + 10^{G1/20} + 10^{G2/20} + 10^{G3/20})^2 / 4] = 9.11\text{dBi} > 6\text{dBi}$, so the power density limit shall be reduced to $11-(9.11-6) = 7.89\text{dBm}$.
3. Refer to section 3.3 for duty cycle spectrum plot.

802.11ac (VHT20)

Chan.	Chan. Freq. (MHz)	PSD W/O Duty Factor (dBm/MHz)				Duty Factor (dB)	Total PSD With Duty Factor (dBm/MHz)	Max. Limit (dBm/MHz)	Pass / Fail
		Chain 0	Chain 1	Chain 2	Chain 3				
52	5260	0.58	1.18	1.52	1.51	0.11	7.34	7.95	Pass
60	5300	0.42	1.30	1.59	1.52	0.11	7.36	7.95	Pass
64	5320	0.24	1.35	1.61	1.57	0.11	7.36	7.95	Pass
100	5500	1.61	1.08	0.98	2.14	0.11	7.61	7.89	Pass
116	5580	1.77	1.47	1.43	1.46	0.11	7.67	7.89	Pass
140	5700	0.65	1.46	1.26	1.40	0.11	7.33	7.89	Pass
144 (U-NII-2C Band)	5720	0.73	1.41	1.18	1.55	0.11	7.36	7.89	Pass

Note: * Test was performed in accordance with Measurement follow FCC KDB 789033 UNII test procedure Method SA-2 and use spectrum analyzer test.

1. For U-NII-2A: The directional gain = $10 \log[(10^{G0/20} + 10^{G1/20} + 10^{G2/20} + 10^{G3/20})^2 / 4] = 9.05\text{dBi} > 6\text{dBi}$, so the power density limit shall be reduced to $11-(9.05-6) = 7.95\text{dBm}$

2. For U-NII-2C: The directional gain = $10 \log[(10^{G0/20} + 10^{G1/20} + 10^{G2/20} + 10^{G3/20})^2 / 4] = 9.11\text{dBi} > 6\text{dBi}$, so the power density limit shall be reduced to $11-(9.11-6) = 7.89\text{dBm}$.

802.11ac (VHT40)

Chan.	Chan. Freq. (MHz)	PSD (dBm/MHz)				Total Power Density (dBm/MHz)	MAX. Limit (dBm/MHz)	Pass / Fail
		Chain 0	Chain 1	Chain 2	Chain 3			
54	5270	-0.19	1.98	1.78	0.98	7.24	7.95	Pass
62	5310	0.32	1.90	1.69	1.00	7.29	7.95	Pass
102	5510	-1.22	-1.93	-2.00	-1.67	4.33	7.89	Pass
110	5550	1.36	1.08	1.14	1.76	7.36	7.89	Pass
134	5670	1.30	1.40	0.92	1.46	7.30	7.89	Pass
142 (U-NII-2C Band)	5710	1.20	1.18	0.90	1.71	7.28	7.89	Pass

Note: * Test was performed in accordance with Measurement follow FCC KDB 789033 UNII test procedure Method SA-2 and use spectrum analyzer test.

1. For U-NII-2A: The directional gain = $10 \log[(10^{G0/20} + 10^{G1/20} + 10^{G2/20} + 10^{G3/20})^2 / 4] = 9.05\text{dBi} > 6\text{dBi}$, so the power density limit shall be reduced to $11-(9.05-6) = 7.95\text{dBm}$

2. For U-NII-2C: The directional gain = $10 \log[(10^{G0/20} + 10^{G1/20} + 10^{G2/20} + 10^{G3/20})^2 / 4] = 9.11\text{dBi} > 6\text{dBi}$, so the power density limit shall be reduced to $11-(9.11-6) = 7.89\text{dBm}$.

3. Refer to section 3.3 for duty cycle spectrum plot.

802.11ac (VHT80)

Chan.	Chan. Freq. (MHz)	PSD W/O Duty Factor (dBm/MHz)				Duty Factor (dB)	Total PSD With Duty Factor (dBm/MHz)	Max. Limit (dBm/MHz)	Pass / Fail
		Chain 0	Chain 1	Chain 2	Chain 3				
58	5290	-5.48	-6.00	-5.11	-4.45	0.38	1.18	7.95	Pass
106	5530	-5.99	-6.17	-6.01	-4.99	0.38	0.64	7.89	Pass
122	5610	-2.66	-2.47	-3.39	-2.99	0.38	3.54	7.89	Pass
138 (U-NII-2C Band)	5690	-2.34	-2.61	-2.98	-2.70	0.38	3.75	7.89	Pass

Note: * Test was performed in accordance with Measurement follow FCC KDB 789033 UNII test procedure Method SA-2 and use spectrum analyzer test.

1. For U-NII-2A: The directional gain = $10 \log[(10^{G0/20} + 10^{G1/20} + 10^{G2/20} + 10^{G3/20})^2 / 4] = 9.05\text{dBi} > 6\text{dBi}$, so the power density limit shall be reduced to $11-(9.05-6) = 7.95\text{dBm}$
2. For U-NII-2C: The directional gain = $10 \log[(10^{G0/20} + 10^{G1/20} + 10^{G2/20} + 10^{G3/20})^2 / 4] = 9.11\text{dBi} > 6\text{dBi}$, so the power density limit shall be reduced to $11-(9.11-6) = 7.89\text{dBm}$.
3. Refer to section 3.3 for duty cycle spectrum plot.

Spectrum Plot of Worst Value

802.11a_Chain 3 / CH100

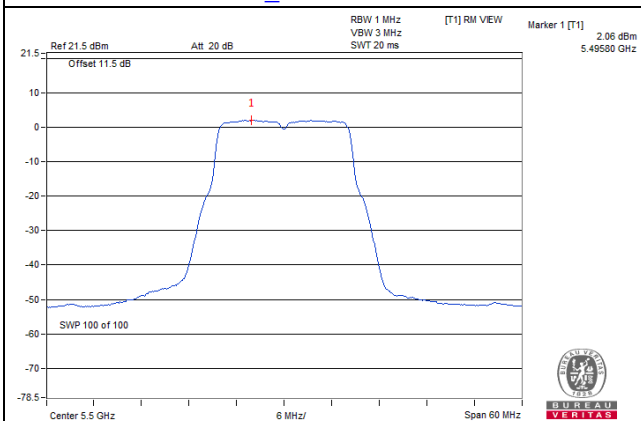

802.11ac (VHT20)_Chain 3 / CH100

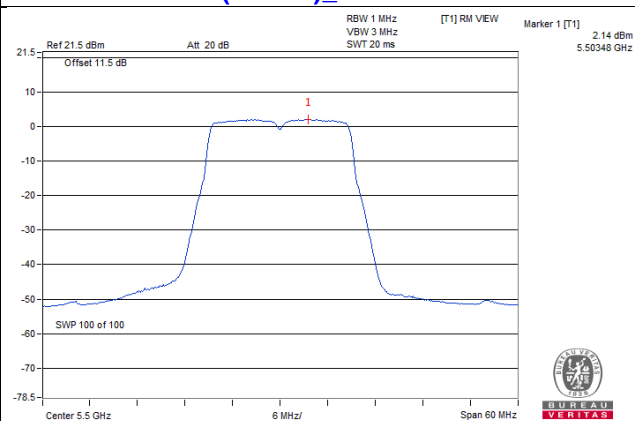

802.11ac (VHT40)_Chain 1 / CH54

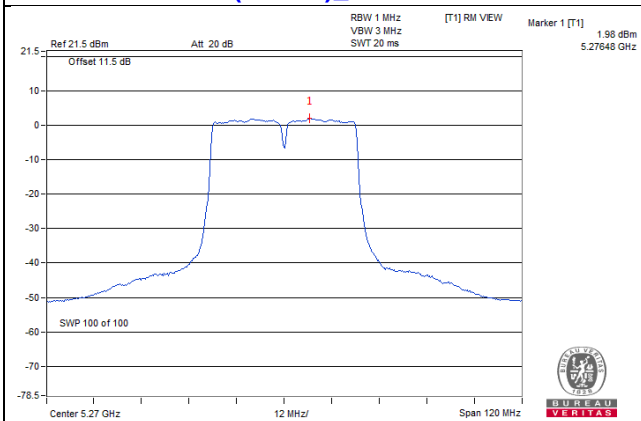

802.11ac (VHT80)_Chain 0 / CH138 (U-NII-2C)

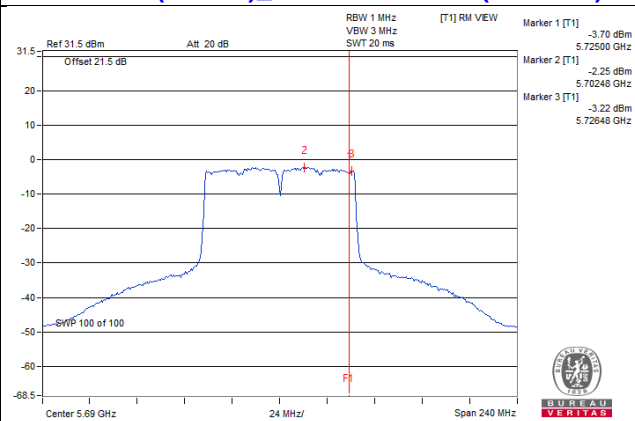

For U-NII-3:

802.11a

Chan.	Freq. (MHz)	PSD W/O Duty Factor (dBm/300kHz)				Duty Factor (dB)	Total PSD With Duty Factor		Total PSD With Duty Factor (dBm/500kHz)	Limit (dBm/500kHz)	Pass /Fail
		Chain 0	Chain 1	Chain 2	Chain 3		mW/300 kHz	dBm/300kHz			
144 (U-NII-3 Band)	5720	-7.43	-7.15	-7.40	-6.85	0.09	0.7786	-1.09	1.13	26.59	Pass

- Note: 1. Method b) Measure and sum spectral maxima across the outputs of KDB 662911 is using for calculating total power density.
 2. The directional gain = $10 \log[(10^{G0/20} + 10^{G1/20} + 10^{G2/20} + 10^{G3/20})^2 / 4]$ = 9.41 dBi > 6dBi, so the power density limit shall be reduced to 30-(9.41-6) = 26.59dBm.
 3. Refer to section 3.3 for duty cycle spectrum plot.

802.11ac (VHT20)

Chan.	Freq. (MHz)	PSD W/O Duty Factor (dBm/300kHz)				Duty Factor (dB)	Total PSD With Duty Factor		Total PSD With Duty Factor (dBm/500kHz)	Limit (dBm/500kHz)	Pass /Fail
		Chain 0	Chain 1	Chain 2	Chain 3		mW/300 kHz	dBm/300kHz			
144 (U-NII-3 Band)	5720	-8.20	-7.43	-7.55	-7.47	0.11	0.7042	-1.52	0.70	26.59	Pass

- Note: 1. Method b) Measure and sum spectral maxima across the outputs of KDB 662911 is using for calculating total power density.
 2. The directional gain = $10 \log[(10^{G0/20} + 10^{G1/20} + 10^{G2/20} + 10^{G3/20})^2 / 4]$ = 9.41 dBi > 6dBi, so the power density limit shall be reduced to 30-(9.41-6) = 26.59dBm.
 3. Refer to section 3.3 for duty cycle spectrum plot.

802.11ac (VHT40)

Chan.	Freq. (MHz)	PSD (dBm/300kHz)				Total PSD		Total PSD (dBm/500kHz)	Limit (dBm/500kHz)	Pass /Fail
		Chain 0	Chain 1	Chain 2	Chain 3	mW/300kHz	dBm/300kHz			
142 (U-NII-3 Band)	5710	-8.66	-8.84	-8.90	-7.71	0.565	-2.48	-0.26	26.59	Pass

- Note: 1. Method b) Measure and sum spectral maxima across the outputs of KDB 662911 is using for calculating total power density.
 2. The directional gain = $10 \log[(10^{G0/20} + 10^{G1/20} + 10^{G2/20} + 10^{G3/20})^2 / 4]$ = 9.41 dBi > 6dBi, so the power density limit shall be reduced to 30-(9.41-6) = 26.59dBm.

802.11ac (VHT80)

Chan.	Freq. (MHz)	PSD W/O Duty Factor (dBm/300kHz)				Duty Factor (dB)	Total PSD With Duty Factor		Total PSD With Duty Factor (dBm/500kHz)	Limit (dBm/500kHz)	Pass /Fail
		Chain 0	Chain 1	Chain 2	Chain 3		mW/300 kHz	dBm/300kHz			
138 (U-NII-3 Band)	5690	-11.59	-11.30	-12.65	-12.11	0.38	0.28304	-5.48	-3.26	26.59	Pass

Note: 1. Method b) Measure and sum spectral maxima across the outputs of KDB 662911 is using for calculating total power density.

2. The directional gain = $10 \log[(10^{G0/20} + 10^{G1/20} + 10^{G2/20} + 10^{G3/20})^2 / 4] = 9.41 \text{ dBi} > 6 \text{ dBi}$, so the power density limit shall be reduced to $30 - (9.41 - 6) = 26.59 \text{ dBm}$.

3. Refer to section 3.3 for duty cycle spectrum plot.

Spectrum Plot of Worst Value

802.11a_Chain 3 / CH144 (U-NII-3)

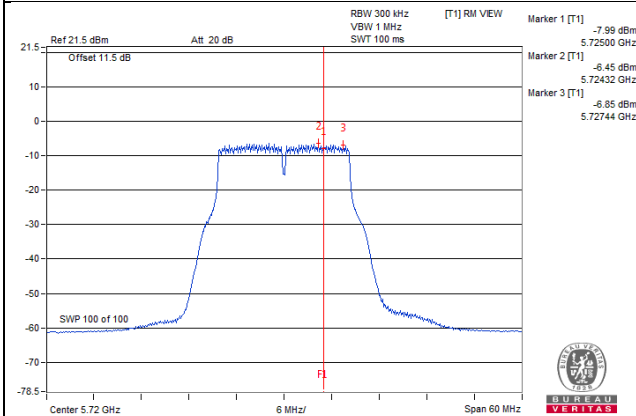

802.11ac (VHT20)_Chain 1 / CH144 (U-NII-3)

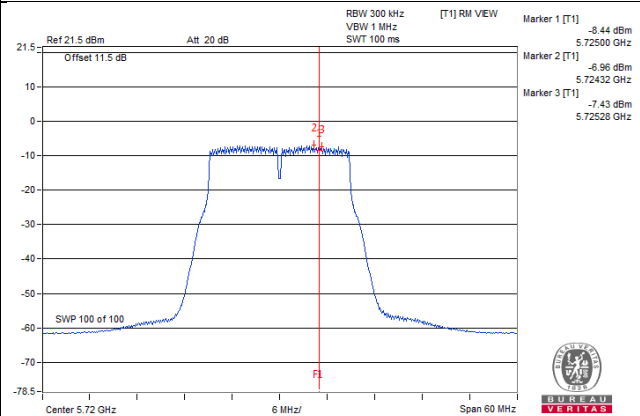

802.11ac (VHT40)_Chain 3 / CH142 (U-NII-3)

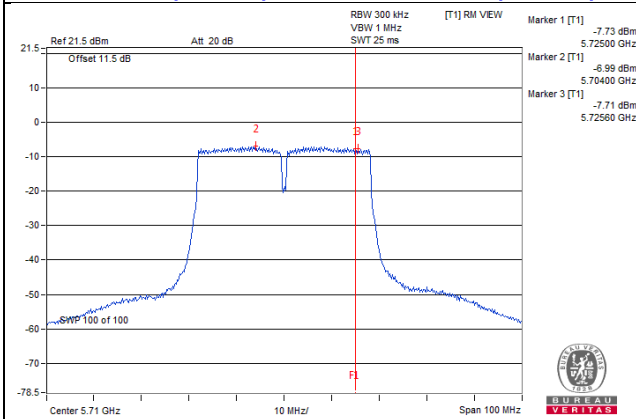

802.11ac (VHT80)_Chain 1 / CH138 (U-NII-3)

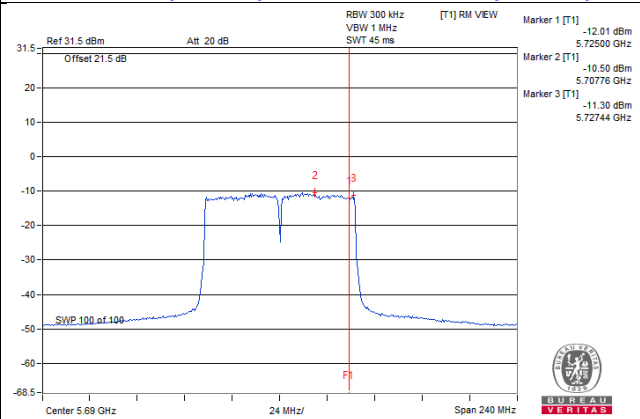

4.6 Frequency Stability Measurement

4.6.1 Limits of Frequency Stability Measurement

The frequency of the carrier signal shall be maintained within band of operation

4.6.2 Test Setup

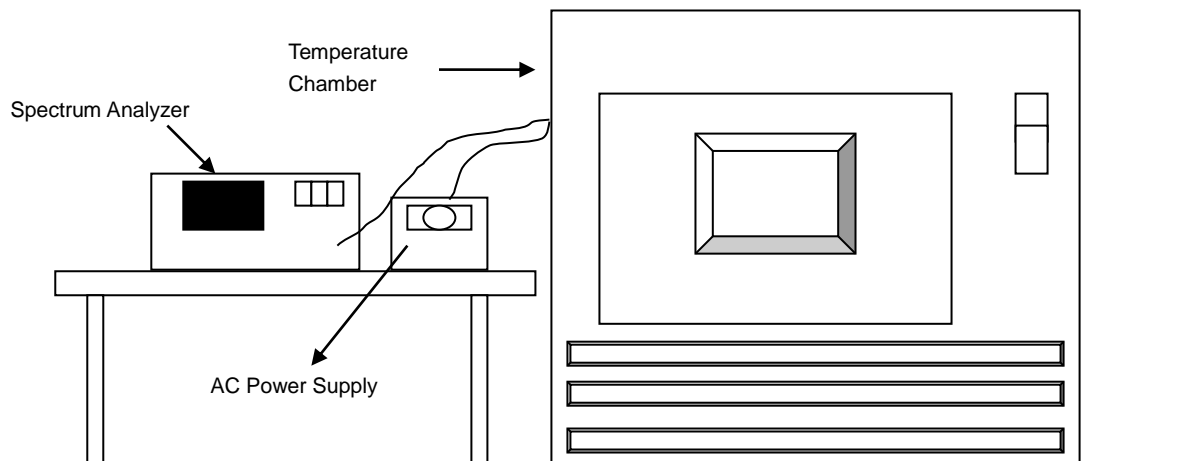

4.6.3 Test Instruments

Refer to section 4.1.2 to get information of above instrument.

4.6.4 Test Procedure

- The EUT was placed inside the environmental test chamber and powered by nominal AC voltage.
- Turn the EUT on and couple its output to a spectrum analyzer.
- Turn the EUT off and set the chamber to the highest temperature specified.
- Allow sufficient time (approximately 30 min) for the temperature of the chamber to stabilize, turn the EUT on and measure the operating frequency after 2, 5, and 10 Minutes.
- Repeat step (d) with the temperature chamber set to the next desired temperature until measurements down to the lowest specified temperature have been completed.
- The test chamber was allowed to stabilize at +20 degree C for a minimum of 30 Minutes. The supply voltage was then adjusted on the EUT from 85% to 115% and the frequency record.

4.6.5 Deviation from Test Standard

No deviation.

4.6.6 EUT Operating Condition

Set the EUT transmit at un-modulation mode to test frequency stability.

4.6.7 Test Results (Mode 1)

Frequency Stability Versus Temp.									
Operating Frequency: 5260 MHz									
TEMP. (°C)	Power Supply (Vac)	0 Minute		2 Minutes		5 Minutes		10 Minutes	
		Measured Frequency (MHz)	Pass/Fail	Measured Frequency (MHz)	Pass/Fail	Measured Frequency (MHz)	Pass/Fail	Measured Frequency (MHz)	Pass/Fail
50	120	5260.0116	PASS	5260.0117	PASS	5260.0135	PASS	5260.0156	PASS
40	120	5259.9927	PASS	5259.993	PASS	5259.9899	PASS	5259.9895	PASS
30	120	5259.9811	PASS	5259.9779	PASS	5259.9788	PASS	5259.9771	PASS
20	120	5259.9751	PASS	5259.9748	PASS	5259.9769	PASS	5259.9742	PASS
10	120	5259.9972	PASS	5259.9943	PASS	5259.9976	PASS	5259.9974	PASS
0	120	5259.9885	PASS	5259.9861	PASS	5259.988	PASS	5259.9872	PASS
-10	120	5259.9992	PASS	5259.9995	PASS	5260.0026	PASS	5259.9983	PASS
-20	120	5259.9793	PASS	5259.9813	PASS	5259.9801	PASS	5259.9768	PASS
-30	120	5260.0112	PASS	5260.0108	PASS	5260.0117	PASS	5260.0136	PASS

Frequency Stability Versus Voltage									
Operating Frequency: 5260 MHz									
TEMP. (°C)	Power Supply (Vac)	0 Minute		2 Minutes		5 Minutes		10 Minutes	
		Measured Frequency (MHz)	Pass/Fail	Measured Frequency (MHz)	Pass/Fail	Measured Frequency (MHz)	Pass/Fail	Measured Frequency (MHz)	Pass/Fail
20	138	5259.9743	PASS	5259.9756	PASS	5259.9766	PASS	5259.9746	PASS
	120	5259.9751	PASS	5259.9748	PASS	5259.9769	PASS	5259.9742	PASS
	102	5259.9759	PASS	5259.9754	PASS	5259.9778	PASS	5259.9748	PASS

4.7 6dB Bandwidth Measurement

4.7.1 Limits of 6dB Bandwidth Measurement

The minimum of 6dB Bandwidth Measurement is 0.5MHz.

4.7.2 Test Setup

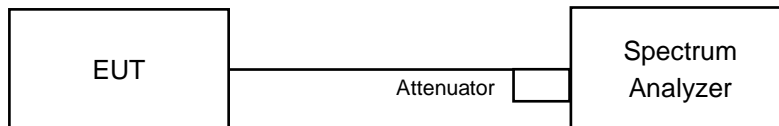

4.7.3 Test Instruments

Refer to section 4.1.2 to get information of above instrument.

4.7.4 Test Procedure

MEASUREMENT PROCEDURE REF

- Set resolution bandwidth (RBW) = 100kHz
- Set the video bandwidth (VBW) $\geq 3 \times$ RBW, Detector = Peak.
- Trace mode = max hold.
- Sweep = auto couple.
- Measure the maximum width of the emission that is constrained by the frequencies associated with the two amplitude points (upper and lower) that are attenuated by 6 dB relative to the maximum level measured in the fundamental emission

4.7.5 Deviation from Test Standard

No deviation.

4.7.6 EUT Operating Condition

The software provided by client to enable the EUT under transmission condition continuously at lowest, middle and highest channel frequencies individually.

4.7.7 Test Results

802.11a

Channel	Frequency (MHz)	6dB Bandwidth (MHz)				Minimum Limit (MHz)	Pass / Fail
		Chain 0	Chain 1	Chain 2	Chain 3		
144 (U-NII-3 Band)	5720	3.13	3.14	3.13	3.14	0.5	Pass

802.11ac (VHT20)

Channel	Frequency (MHz)	6dB Bandwidth (MHz)				Minimum Limit (MHz)	Pass / Fail
		Chain 0	Chain 1	Chain 2	Chain 3		
144 (U-NII-3 Band)	5720	3.12	3.12	3.77	3.77	0.5	Pass

802.11ac (VHT40)

Channel	Frequency (MHz)	6dB Bandwidth (MHz)				Minimum Limit (MHz)	Pass / Fail
		Chain 0	Chain 1	Chain 2	Chain 3		
142 (U-NII-3 Band)	5710	3.15	3.17	3.16	3.19	0.5	Pass

802.11ac (VHT80)

Channel	Frequency (MHz)	6dB Bandwidth (MHz)				Minimum Limit (MHz)	Pass / Fail
		Chain 0	Chain 1	Chain 2	Chain 3		
138 (U-NII-3 Band)	5690	3.05	3.25	3.18	3.23	0.5	Pass

Spectrum Plot of Worst Value

802.11a_Chain 0 / CH144 (U-NII-3)

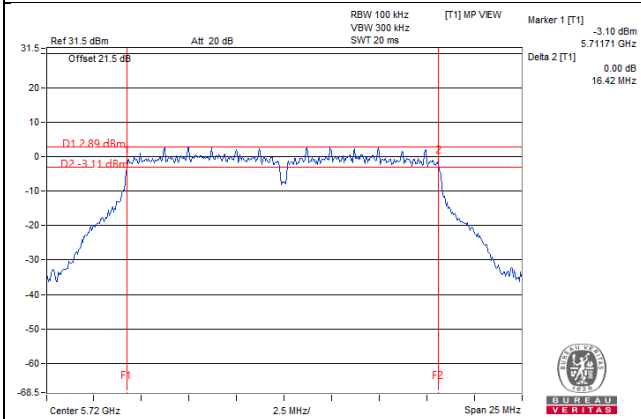

802.11ac (VHT20)_Chain 0 / CH144 (U-NII-3)

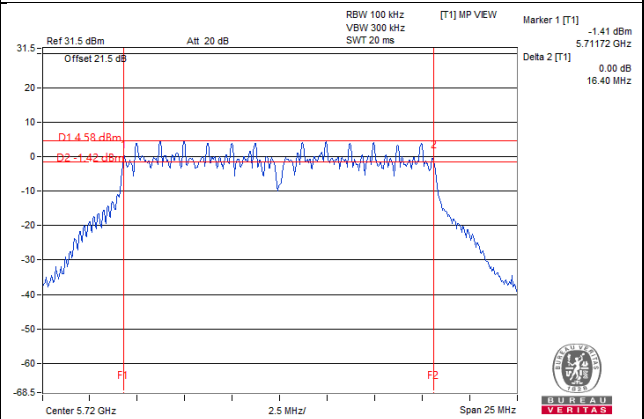

802.11ac (VHT40)_Chain 0 / CH142 (U-NII-3)

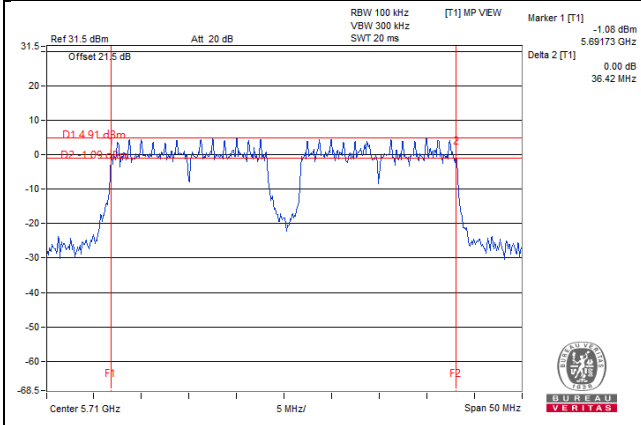

802.11ac (VHT80)_Chain 0 / CH138 (U-NII-3)

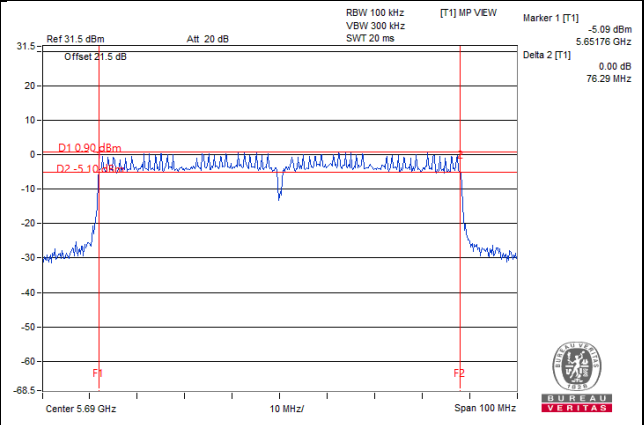

Note: The 6dB bandwidth above 5725MHz = Marker 1 + Delta 2 - 5725MHz

5 Pictures of Test Arrangements

Please refer to the attached file (Test Setup Photo).

Appendix – Information of the Testing Laboratories

We, Bureau Veritas Consumer Products Services (H.K.) Ltd., Taoyuan Branch, were founded in 1988 to provide our best service in EMC, Radio, Telecom and Safety consultation. Our laboratories are FCC recognized accredited test firms and accredited according to ISO/IEC 17025.

If you have any comments, please feel free to contact us at the following:

Lin kou EMC/RF Lab

Tel: 886-2-26052180

Fax: 886-2-26051924

Hsin Chu EMC/RF/Telecom Lab

Tel: 886-3-6668565

Fax: 886-3-6668323

Hwa Ya EMC/RF/Safety Lab

Tel: 886-3-3183232

Fax: 886-3-3270892

Email: service.adt@tw.bureauveritas.com

Web Site: www.bureauveritas-adt.com

The address and road map of all our labs can be found in our web site also.

--- END ---