

Label position

VER.	MARK	DCR/ECN NO.	DATE	UPDATE DESCRIPTION	SIGNATURE
0	N/A	N/A	2019/03/14	First Release	Yong-feng Li

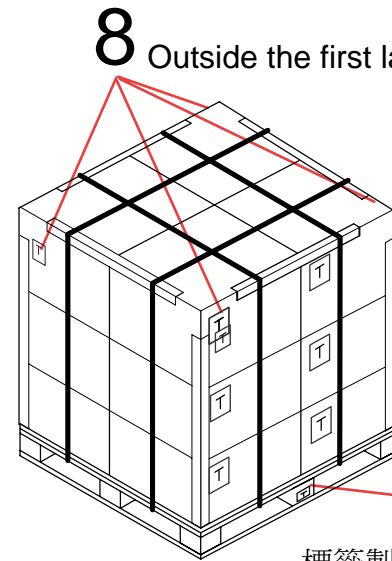
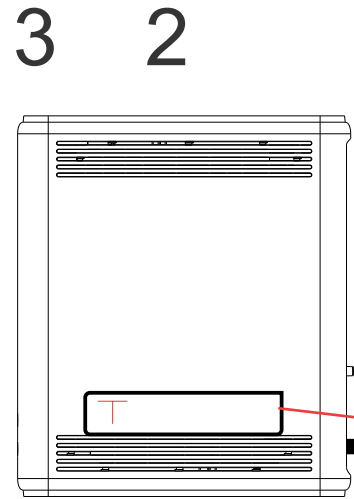
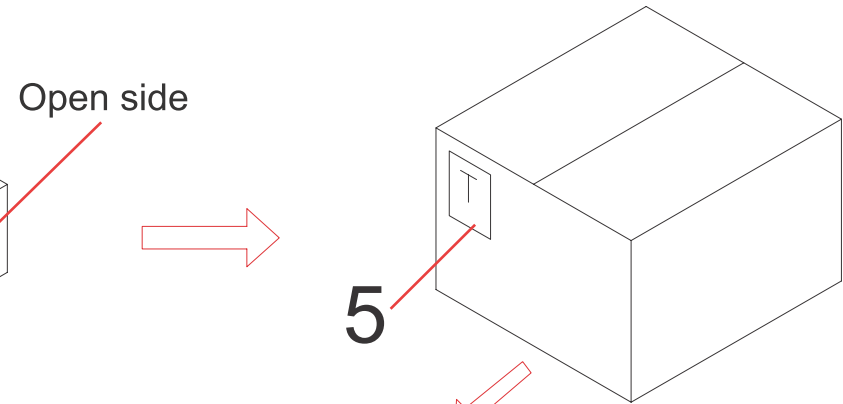
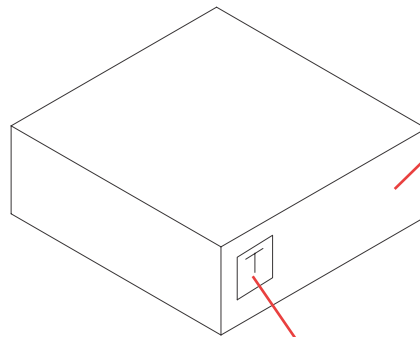
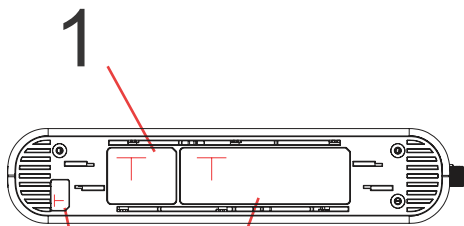

6 Paste opposite

標籤製作黏貼方式 /U10C142.00/01/1 OF 10

8	Altice Pallet label	503.01500.005	4 /144
7	E911 label	504.01651.005	1
6	Pallet label	503.00089.005	2/144
5	Carton label	503.00519.005	1/12
4	Giftbox label	503.01330.005	1
3	Warranty label	503.01512.005	1
2	Device Label	503.01518.005	1
1	PTT label	500.02349.005	1
Item	Description	Foxconn PN	QTY

MATERIAL (SPEC.)										SCALE		FOXCONN HON HAI PRECISION IND. CO., LTD CNSBG			
FINISH										SHEET 1/1		PART NAME			
UNIT mm										SIZE A4		Label position			
MODEL U10C142.00										PART NO.		DESIGNED			
CUSTOMER MODEL N/A										CUSTOMER PART NO.		APPROVED			
DRAFT TOLERANCE ±0.2°										N/A		Bailey Tan			
Select Dim.	tol.	A	B	C	EPS	EPE	BAG	CTN	V LABEL	USR					
0~6		0.05	0.05	0.10					0.20	0.05					
6~30		0.10	0.15	0.20	0.50	0.50	3.00		0.20	0.05					
30~120		0.15	0.20	0.30	0.50	0.50	5.00	2.00	0.25	0.10					
120~300		0.20	0.30	0.40	1.00	1.00	10.00	3.00	0.30	0.15					
300~450		0.25	0.40	0.50	2.00	2.00	15.00	5.00	0.50	0.20					
450~600		0.30	0.50	0.60	3.00	3.00	20.00	5.00	0.80	0.20					
DRAFT TOLERANCE ±0.2°										CRITICAL DIM. MARK					

VER.	MARK	DCR/ECN NO.	DATE	UPDATE DESCRIPTION	SIGNATURE
0	N/A	N/A	2019/03/14	First Release	Yong-feng Li



Vendor code

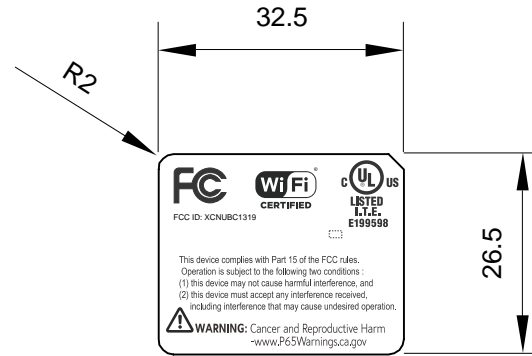
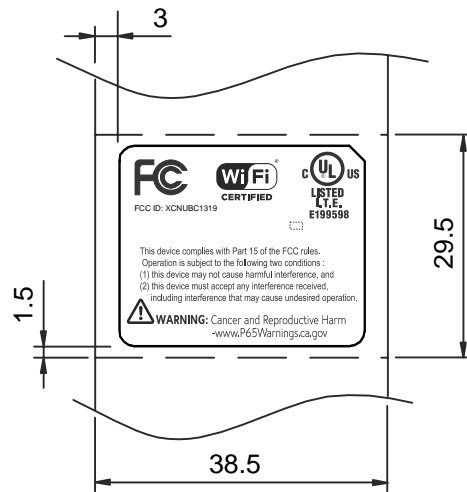

NOTES:

- Surface Material color:white
- Printing color is as color defined in artwork
- Adhesive:Acrylic
- Adhesive thickness:0.025+/-0.003mm
- Adhesion to steel(180°磨钢粘着力):1.8+/-0.3 kg/25mm
- Initial Tack (初期力) : 4 #/boll
- Relese Power(90°剥离力):5 g/25mm
- Holding Power(持粘力测试法):1 hr/kg/20mm²
- Shipment method: Roll
- This part must comply with RoHS.
- Test condition :
 - Soak alcohol(99.7%) at first trial and repeat to soak every 50 times
 - Push force:250g
 - Speed:30 times/min
 - Move back and forth 100 times,printing was not removed

標籤製作黏貼方式 /U10C142.00/01/2 OF 10

MATERIAL (SPEC.)										SCALE		FOXCONN HON HAI PRECISION IND. CO., LTD CNSBG		
50# Mylar(matte)										1:1				
FINISH										SHEET		PART NAME		
膠面咬花										1/1				
Select Dim.	lot	A	B	C	EPS	EPE	BAG	CTN	V	USR	UNIT	PTT label		
0~6		0.05	0.05	0.10					0.20	0.05	mm			
6~30		0.10	0.15	0.20	0.50	0.50	3.00		0.20	0.05	A4	MODEL	PART NO.	DESIGNED
30~120		0.15	0.20	0.30	0.50	0.50	5.00	2.00	0.25	0.10		U10C142.00	500.02349.005	Yong-feng Li
120~300		0.20	0.30	0.40	1.00	1.00	10.00	3.00	0.30	0.15		CUSTOMER MODEL	CUSTOMER PART NO.	APPROVED
300~450		0.25	0.40	0.50	2.00	2.00	15.00	5.00	0.50	0.20		N/A	N/A	Bailey Tan
450~600		0.30	0.50	0.60	3.00	3.00	20.00	5.00	0.80	0.20	DRAFT TOLERANCE ±0.2° CRITICAL DIM. MARK *			

VER.	MARK	DCR/ECN NO.	DATE	UPDATE DESCRIPTION	SIGNATURE
0	N/A	N/A	2019/03/01	First Release	Yong-feng Li
1	N/A	N/A	2019/03/11	Update label wording	Yong-feng Li

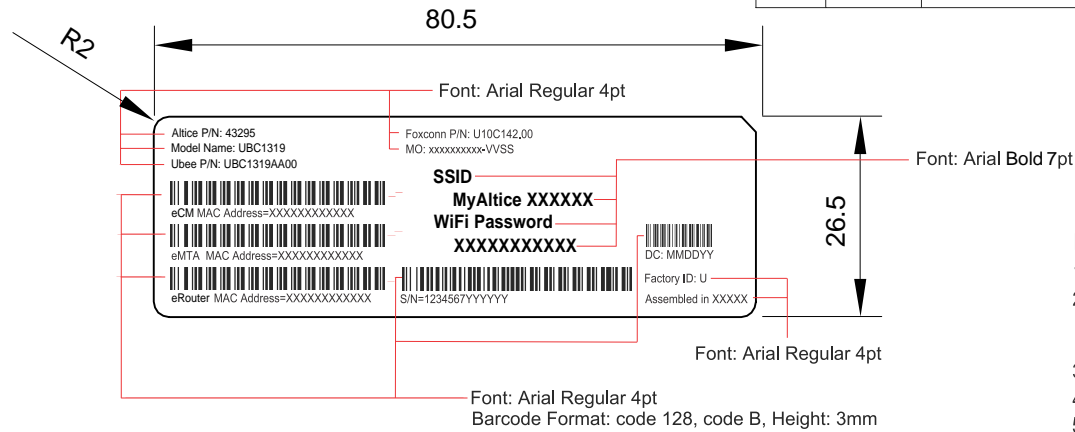

NOTES:

- All of the barcode range and SN definition please refer to the test spec
- SSID: MyAltice XXXXXX
SSID name is "MyAltice" concatenated with a space and the last 6 digits of Router "WAN" MAC (lowercase characters, no spaces or additional separation characters)
- WiFi Password: refer to the test spec
- Assembled in XXXXX (XXXXX:Country of Manufacture, base on the manufacture factory)
- DC (Date Code), in MMDDYY format: MM表示月, DD表示天, YY表示年
- Foxconn P/N: U10C142.00, U10C142.00 is FOXCONN P/N,
Version: VVSS,
VV: the engineering version (refer to Foxconn label Rev. column in the cover of the MFG document)
SS: the version of A300/A400 product (refer to FDoc Rev. in the cover of MFG document)
- MO: xxxxxxxx is FOXCONN MO Number.

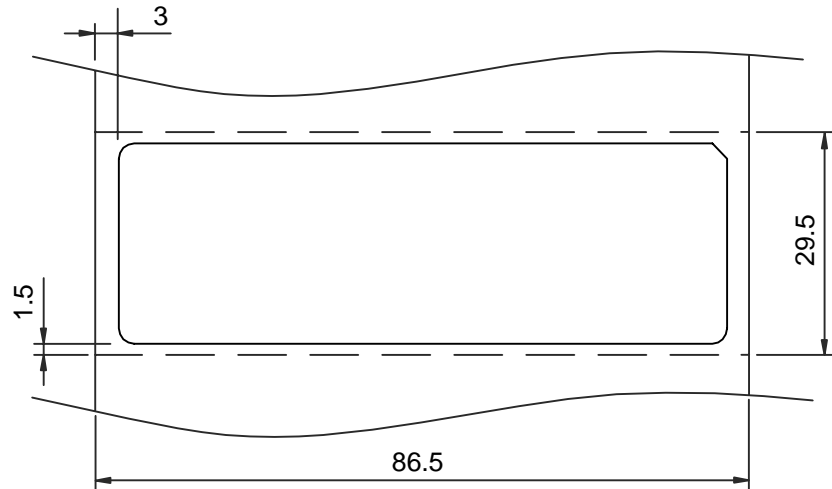

NOTES:

- Surface Material color:white
- Printing color is as color defined in artwork
- Adhesive:Acrylic
- Adhesive thickness:0.025+/-0.003mm
- Adhesion to steel(180°磨钢粘着力):1.8+/-0.3 kg/25mm
- Initial Tack (初期力) : 4 #/boll
- Relese Power(90°剥离力):5 g/25mm
- Holding Power(持粘力测试法):1 hr/kg/20mm²
- Shipment method: Roll
- This part must comply with RoHS.
- Test condition :
 - Soak alcohol(99.7%) at first trial and repeat to soak every 50 times
 - Push force:250g
 - Speed:30 times/min
 - Move back and forth 100 times,printing was not removed

標籤製作黏貼方式 /U10C142.00/01/3 OF 10

MATERIAL (SPEC.)		SCALE	FOXCONN HON HAI PRECISION IND. CO., LTD CNSBG												
50# Mylar(matte)		1:1													
FINISH		SHEET	PART NAME												
膠面咬花		1/1													
Select Dim.	Lot	A	B	C	EPS	EPE	BAG	CTN	V LABEL	USR	UNIT	Device label			
0~6		0.05	0.05	0.10						0.20	0.05	mm	PART NAME		
6~30		0.10	0.15	0.20	0.50	0.50	3.00			0.20	0.05	A4	MODEL	PART NO.	DESIGNED
30~120		0.15	0.20	0.30	0.50	0.50	5.00	2.00	0.25	0.10	0.10		U10C142.00	503.01518.005	Yong-feng Li
120~300		0.20	0.30	0.40	1.00	1.00	10.00	3.00	0.30	0.15	0.15	A4	CUSTOMER MODEL	CUSTOMER PART NO.	APPROVED
300~450		0.25	0.40	0.50	2.00	2.00	15.00	5.00	0.50	0.20	0.20		N/A	N/A	Bailey Tan
450~600		0.30	0.50	0.60	3.00	3.00	20.00	5.00	0.80	0.20	0.20	DRAFT TOLERANCE ±0.2° CRITICAL DIM. MARK *			

VER.	MARK	DCR/ECN NO.	DATE	UPDATE DESCRIPTION	SIGNATURE
0	N/A	N/A	2018/08/10	First Release	Yong-feng Li

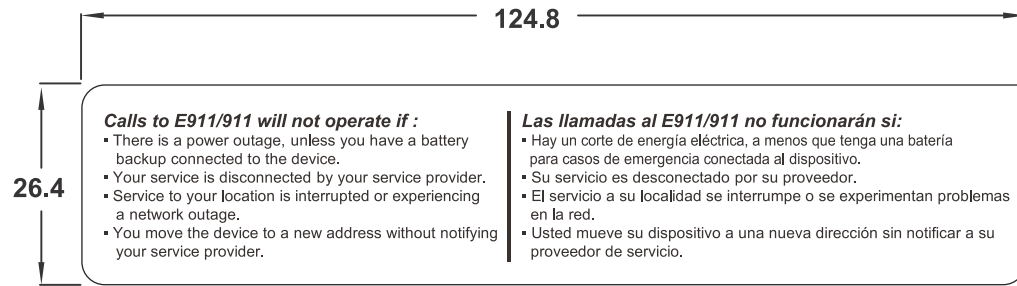

Vendor supply

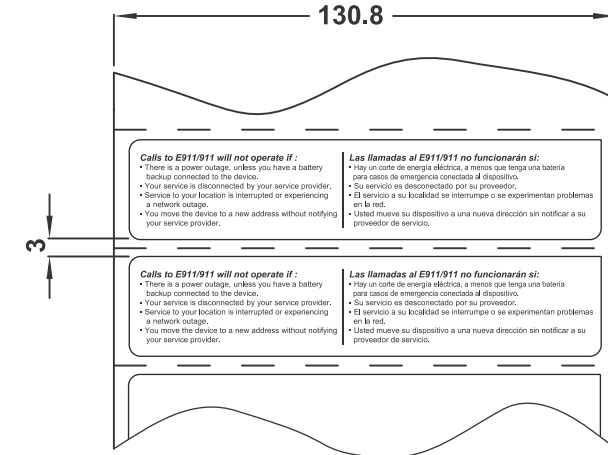

NOTES:

- Surface Material color:white
- Printing color is as color defined in artwork
- Thickness: 0.12+/-0.003mm
- Adhesive:Acrylic
- Adhesive thickness:0.025+/-0.003mm
- Adhesion to steel(180°磨钢粘着力):1.8+/-0.3 kg/25mm
- Initial Tack (初期力) : 4 #/boll
- Relese Power(90°剥离力):5 g/25mm²
- Holding Power(持粘力测试法):1 hr/kg/20mm²
- Shipment method: Roll
- This part must comply with RoHS.
- Test condition :
 - Soak alcohol(99.7%) at first trial and repeat to soak every 50 times
 - Push force:250g
 - Speed:30 times/min
 - Move back and forth 100 times,printing was not removed

標籤製作黏貼方式 /U10C142.00/01/4 OF 10

MATERIAL (SPEC.)										SCALE	FOXCONN HON HAI PRECISION IND. CO., LTD CNSBG			
FINISH										SHEET				
MZ0333										1:1				
Matt PP										1/1				
Select Dim.	tol.	A	B	C	EPS	EPE	BAG	CTN	V LABEL	USR	UNIT	PART NAME		
0~6		0.05	0.05	0.10					0.20	0.05	mm	E911 label		
6~30		0.10	0.15	0.20	0.50	0.50	3.00		0.20	0.05	SIZE A4	MODEL	PART NO.	DESIGNED
30~120		0.15	0.20	0.30	0.50	0.50	5.00	2.00	0.25	0.10		U10C142.00	504.01651.005	Yong-feng Li
120~300		0.20	0.30	0.40	1.00	1.00	10.00	3.00	0.30	0.15				
300~450		0.25	0.40	0.50	2.00	2.00	15.00	5.00	0.50	0.20		CUSTOMER MODEL	CUSTOMER PART NO.	APPROVED
450~600		0.30	0.50	0.60	3.00	3.00	20.00	5.00	0.80	0.20		N/A	N/A	Bailey Tan
DRAFT TOLERANCE ±0.2°										CRITICAL DIM. MARK				

REV.	MARK.	ECN NO.	DATE	UPDATE DESCRIPTIONS	SIGNATURE
0			2018.7.10	First release	Catheirne
0.1			2018.7.13	change material	Catheirne

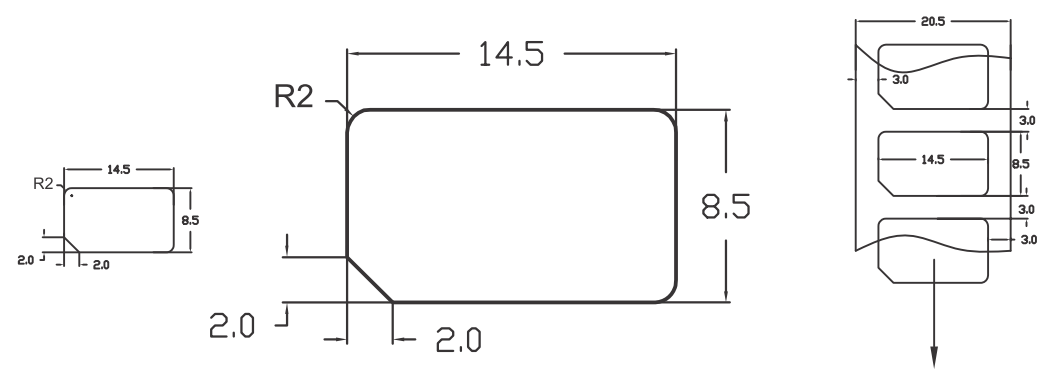

vendor supply
scale 3:1

package style

NOTES:

- 1. Surface Material:25#消銀龍防偽VOID(陽版, 被貼物留有VOID字樣)
- * 2. Surface Material tolerance:0.025±0.001mm
- 3. Surface Material color:Matt silver
- 4. printing color is as color defined
- 5. Adhesive base:Acrylic
- * 6. Adhesive thickness:0.015+/-0.002mm
- * 7. Initial Tack:minimum 6#
- * 8. Adhesion to steel:1+/-0.3 kg/25mm
- * 9. Holding Power:minimum 1hr/kg*20mm²
- 10. Package Style:Reel or sheet
- 11. This part must comply with ROHs
- 12. size tolerance:
0~30mm, ±0.2mm
30~120mm, ±0.25mm

標籤製作黏貼方式 /U10C142.00/01/5 OF 10

MATERIAL (SPEC.):				SCALE 1:1	FOXCONN HON HAI PRECISION IND. CO., LTD CNSBG			
FINISH:				SHEET 1/1				
DIM. TOLERANCES		WARPAGE		UNIT mm	PART NAME warranty label			DESIGNED Catheirne
DIM.	TOL.	D(MAX.) =0.2%L		SIZE A4	MODEL U10C142.00	PART NO. 503.01512.005	REV.	CHECKED Cun
0~6	±0.05							
6~30	±0.10	ANGLE TOLERANCES						
30~120	±0.15	ANGLE	TOL.					
120~300	±0.20	X°	±0.20°					
300~	±0.25	.X°	±0.10°		CUSTOMER MODEL	CUSTOMER PART NO.		APPROVED
CRITICAL DIM. MARK "*"								

D		C		B		A
VER.	MARK	DCR/ECN NO.	DATE	UPDATE	DESCRIPTION	SIGNATURE
0	N/A	N/A	2019/01/12		First Release	Yong-feng Li

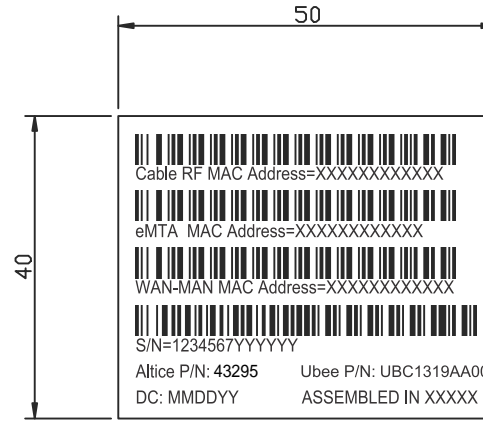
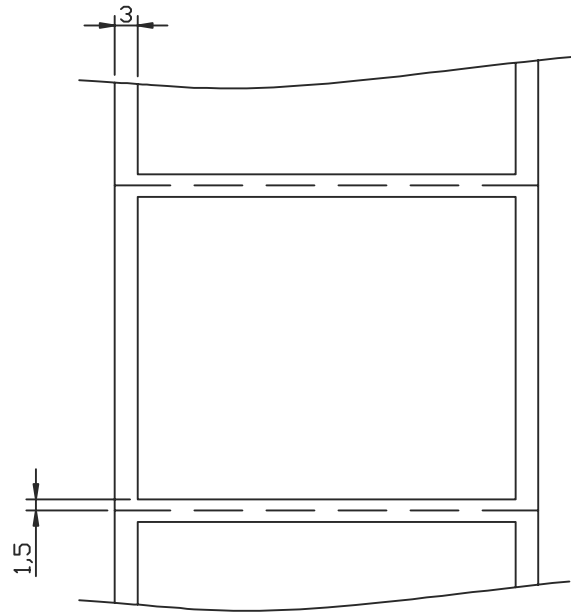

Font: Arial Regular 6pt
Barcode format: code 128, Height: 4mm





























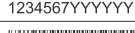

NOTES:

- All of the barcode range please refer to the test spec.
- DC (Date Code), in MMDDYY format: MM表示月, DD表示天, YY表示年
- ASSEMBLED IN XXXXX (XXXXX:Country of Manufacture, base on the manufacture factory)

標籤製作黏貼方式 /U10C142.00/01/6 OF 10

MATERIAL (SPEC.)		Art Paper		SCALE		1:1		FOXCONN HON HAI PRECISION IND. CO., LTD CNSBG						
FINISH				SHEET		1/1								
Select Dim.	Lot	A	B	C	EPS	EPE	BAG	CTN	V LABEL	USR	UNIT	PART NAME		
0~6		0.05	0.05	0.10					0.20	0.05	mm	Kraftbox label		
6~30		0.10	0.15	0.20	0.50	0.50	3.00		0.20	0.05	SIZE	MODEL	PART NO.	DESIGNED
30~120		0.15	0.20	0.30	0.50	0.50	5.00	2.00	0.25	0.10		A4	U10C142.00	503.01330.005
120~300		0.20	0.30	0.40	1.00	1.00	10.00	3.00	0.30	0.15		CUSTOMER MODEL	CUSTOMER PART NO.	APPROVED
300~450		0.25	0.40	0.50	2.00	2.00	15.00	5.00	0.50	0.20		N/A	N/A	Bailey Tan
450~600		0.30	0.50	0.60	3.00	3.00	20.00	5.00	0.80	0.20	DRAFT TOLERANCE ±0.2° CRITICAL DIM. MARK *			

REV.	MARK.	ECN NO.	DATE	UPDATE DESCRIPTIONS	SIGNATURE
0			2019/01/12	First Release	Yong-feng Li

Product:  Altice P/N: 43295		Qty: 12 	
 Ubee P/N: UBC1319AA00		Assembled in DATE: MM/DD/YY XXXXXX TIME: HH:MM	
 Foxconn P/N: U10C142.00			
Carton ID:  CXXXXXXXXXX			
Serial Number	Cable RF MAC Address	eMTA MAC Address	WAN-MAN MAC Address
 1234567YYYYYY	XXXXXXXXXXXX	 XXXXXXXXXXXX	XXXXXXXXXXXX
 1234567YYYYYY	XXXXXXXXXXXX	 XXXXXXXXXXXX	XXXXXXXXXXXX
 1234567YYYYYY	XXXXXXXXXXXX	 XXXXXXXXXXXX	XXXXXXXXXXXX
 1234567YYYYYY	XXXXXXXXXXXX	 XXXXXXXXXXXX	XXXXXXXXXXXX
 1234567YYYYYY	XXXXXXXXXXXX	 XXXXXXXXXXXX	XXXXXXXXXXXX
 1234567YYYYYY	XXXXXXXXXXXX	 XXXXXXXXXXXX	XXXXXXXXXXXX
 1234567YYYYYY	XXXXXXXXXXXX	 XXXXXXXXXXXX	XXXXXXXXXXXX
 1234567YYYYYY	XXXXXXXXXXXX	 XXXXXXXXXXXX	XXXXXXXXXXXX
 1234567YYYYYY	XXXXXXXXXXXX	 XXXXXXXXXXXX	XXXXXXXXXXXX
 1234567YYYYYY	XXXXXXXXXXXX	 XXXXXXXXXXXX	XXXXXXXXXXXX
 1234567YYYYYY	XXXXXXXXXXXX	 XXXXXXXXXXXX	XXXXXXXXXXXX
 1234567YYYYYY	XXXXXXXXXXXX	 XXXXXXXXXXXX	XXXXXXXXXXXX
 1234567YYYYYY	XXXXXXXXXXXX	 XXXXXXXXXXXX	XXXXXXXXXXXX
THIS PRODUCT CONTAINS ENCRYPTION AND MAY REQUIRE U.S. AND/OR LOCAL GOVERNMENT AUTHORIZATION PRIOR TO EXPORT OR IMPORT TO ANOTHER COUNTRY			

160mm

135mm

Notes:

1. Background color: White
2. Printing color: Black
3. Material: art paper
4. Carton ID: follow Foxconn rule
5. DATE/TIME (Variable) that modem was assembled
According to the actual manufacturing time to print
DATE: MM/DD/YY (e.g.: DATE: 07/25/12)
TIME: HH:MM (e.g.: TIME: 21:30)
6. Assembled in XXXXXX: Country of Manufacture
(base on the manufacture factory)
7. MAC and SN range please refer to the test spec.
8. Stick position please refer to ASY document

Barcode format: code 128 , Height :3mm
Font: Arial

標籤製作黏貼方式 /U10C142.00/01/7 OF 10

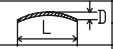
1	ITEM	CNSBG P/N	CUSTOMER P/N	DESCRIPTIONS	QT'Y	REMARKS			
	MATERIAL (SPEC.)	Art Paper		SCALE 1:1	FOXCONN HON HAI PRECISION IND. CO., LTD CNSBG				
	FINISH:			SHEET 1/1					
	DIM. TOLERANCES	WARPAGE		UNIT mm	PART NAME Carton Label	DESIGNED Yong-feng Li			
	DIM.	TOL.	D(MAX.)		SIZE A3	MODEL U10C142.00	PART NO. 503.00519.005	REV. 0	CHECKED Bailey Tan
	0~6	±0.05	=0.2%L		ANGLE TOLERANCES	CUSTOMER MODEL	CUSTOMER PART NO.	APPROVED	
	6~30	±0.10		ANGLE					
	30~120	±0.15		TOL.					
	120~300	±0.20		X°					
	300~	±0.25		.X°					
	CRITICAL DIM. MARK *X*								

產地編號明細

LOCATION	LOCATIONNAME
0	Hsinchu
1	Zhongshan
2	Futian
3	Tucheng
4	Taiyoung
5	Jingyang
6	Guangchuan
7	Taibiao
8	Hongju
9	Xinjin
A	Hongkong
B	Guolian
C	Chongqing CBT
D	Dummy Lable
E	Ambit
F	Longhua E5 database
G	Longhua E5A database
H	Longhua E6 database
I	RESERVE
J	RESERVE
K	Nanning
L	Huandian
M	EASTAR
N	Mexico
P	Longhua RMA
Q	Chongqing CPEI
R	Shanghai RMA
S	Shanghai CPEII
T	Yantai(S-customer)
U	Vietnam(Bac Ninh,CMB)
V	Yantai(RTT-customer)
Y	Vietnam(Bac Giang)
Z	Vietnam(Bac Ninh,CPEII)

REV.	MARK.	ECN NO.	DATE	UPDATE DESCRIPTIONS	SIGNATURE
0			2019/01/12	First release	Yong-feng Li

Size:110mm*36mm

P/N:U10C142.00

Barcode and words description:

barcode 1: UBC1319AA00

barcode 2: PIPPYWWSSSS

1. PIPPYWWSSSS:

P:Pallet,

I:Location name,refer to reference

PP:Line name,

Y:Year,

WW:Week,

SSSS:Serial number (0001-ZZZZ, reset to 0001 every week)

2. Rev:VVSS:Product manufacturing document revision

VV:the engineering version(refer to Foxconn label Rev column in the cover of the MFG document)

SS:the version of A300/A400 product(refer to Doc Rev. in the cover of MFG document)



標籤製作黏貼方式 /U10C142.00/01/8 OF 10

MATERIAL (SPEC.):			SCALE 1:1	FOXCONN HDN HAI PRECISION IND. CO., LTD CNSBG				
FINISH:			SHEET 1/1					
DIM. TOLERANCES		WARPAGE		UNIT mm	PART NAME Pallet Label		DESIGNED Yong-feng Li	
DIM.	TOL.	D(MAX.) =0.2%L		SIZE A4	MODEL	PART NO.	REV.	CHECKED
0~6	±0.05	ANGLE TOLERANCES			U10C142.00	503.00089.005	0	Bailey Tan
6~30	±0.10	ANGLE	TOL.	CUSTOMER MODEL		CUSTOMER PART NO.		APPROVED
30~120	±0.15	X°	±0.20°					
120~300	±0.20	X°	±0.10°					
300~	±0.25	X°	±0.10°					
CRITICAL DIM. MARK "*"								

REV.	MARK.	ECN NO.	DATE	UPDATE DESCRIPTIONS	SIGNATURE
0			2019/01/12	First Release	Yong-feng Li

Altice 43295



Pallet ID: AMMYWWSSSS

Quantity	XXX PCS
Product Description	WeMTA D3.0-11AC
Ubee Part Number	UBC1319AA00
Vendor	Ubee Interactive Inc

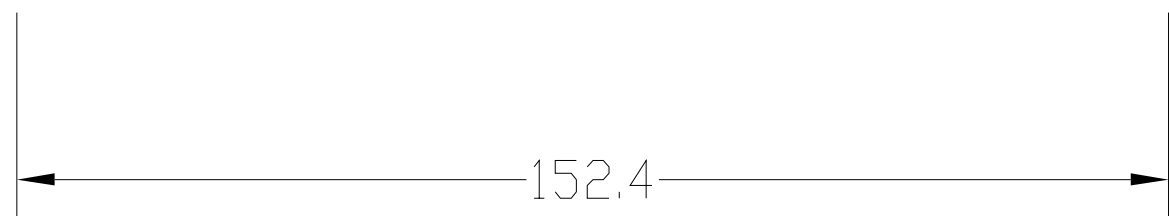
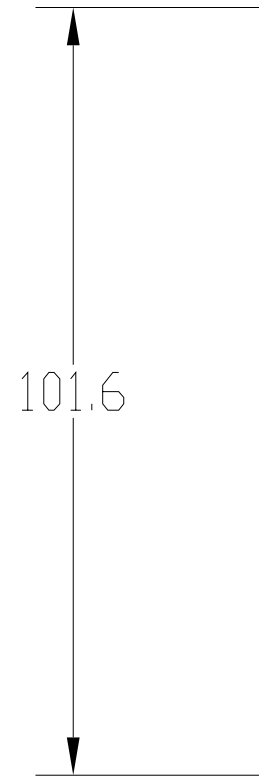

Barcode and words description:

Barcode: AMMYWWSSSS

1. AMMYWWSSSS:

A:Altice, fixed

MM:Model index in Ubee, UBC1319AA00 is 02

01	UBC1322BA00
02	UBC1319AA00
03	UBC1326AA00

YY:Year, e.g: 2018>18

WW:Week,

SSSS:Serial number (0001-9999, reset to 0001 every week by model)

Barcode format: code 128, code B

Font: Arial

標籤製作黏貼方式 /U10C142.00/01/9 OF 10

1	ITEM	CNSBG P/N	CUSTOMER P/N	DESCRIPTIONS	QT'Y	REMARKS
	MATERIAL (SPEC.:	Art Paper		SCALE 1:1		FOXCONN HON HAI PRECISION IND. CO., LTD CNSBG
	FINISH:			SHEET 1/1		
	DIM. TOLERANCES	WARPAGE		UNIT mm	PART NAME Altice Pallet Label	
	DIM.	TOL.	D(MAX.)	SIZE A3	MODEL	DESIGNED Yong-feng Li
	0~6	±0.05	=0.2%L		U10C142.00	
	6~30	±0.10	ANGLE		PART NO.	CHECKED Bailey Tan
	30~120	±0.15	ANGLE		503.01500.005	REV. 0
	120~300	±0.20	X°		CUSTOMER MODEL	CHECKED
	300~	±0.25	.X°		CUSTOMER PART NO.	APPROVED
	CRITICAL DIM. MARK "*"					

Modification list

Date	Version	Description
2018/12/25	V1	Update device label format.
2019/01/10	V2	Add E 911 label and Altice pallet label
2019/01/12	V3	Update label position and add Altice P/N
2019/01/15	V4	Update SSID
2019/02/01	V6	Update giftbox label position
2019/03/01	V7	Update device label
2019/03/08	V8	Update "Wi-fi Pre-Shared Key" to "Wi-Fi Password" and exchange of "SSID" and "Wi-Fi Password"
2019/03/11	V9	Update device label wording:Wi-Fi to WiFi
2019/03/14	V10	Update label position;Update UL logo