

## FCC Test Report

**Report No.:** RF180502E08-1

**FCC ID:** XCNUBC1310

**Test Model:** UBC1310

**Received Date:** May 02, 2018

**Test Date:** May 25 to June 06, 2018

**Issued Date:** June 26, 2018

**Applicant:** Ubee Interactive Corp.

**Address:** 10F-1, No. 5, Taiyuan 1st St. Jhubei Ci, Hsinchu County 302, Taiwan ,  
R.O.C.

**Issued By:** Bureau Veritas Consumer Products Services (H.K.) Ltd., Taoyuan Branch  
Hsin Chu Laboratory

**Lab Address:** E-2, No.1, Li Hsin 1st Road, Hsinchu Science Park, Hsinchu City 300,  
Taiwan R.O.C.

**Test Location:** E-2, No.1, Li Hsin 1st Road, Hsinchu Science Park, Hsinchu City 300,  
Taiwan R.O.C.

**FCC Registration /  
Designation Number:** 723255 / TW2022



This report is for your exclusive use. Any copying or replication of this report to or for any other person or entity, or use of our name or trademark, is permitted only with our prior written permission. This report sets forth our findings solely with respect to the test samples identified herein. The results set forth in this report are not indicative or representative of the quality or characteristics of the lot from which a test sample was taken or any similar or identical product unless specifically and expressly noted. Our report includes all of the tests requested by you and the results thereof based upon the information that you provided to us. You have 60 days from date of issuance of this report to notify us of any material error or omission caused by our negligence, provided, however, that such notice shall be in writing and shall specifically address the issue you wish to raise. A failure to raise such issue within the prescribed time shall constitute your unqualified acceptance of the completeness of this report, the tests conducted and the correctness of the report contents. Unless specific mention, the uncertainty of measurement has been explicitly taken into account to declare the compliance or non-compliance to the specification. The report must not be used by the client to claim product certification, approval, or endorsement by TAF or any government agencies.

## Table of Contents

<b>Release Control Record</b> .....	<b>4</b>
<b>1 Certificate of Conformity</b> .....	<b>5</b>
<b>2 Summary of Test Results</b> .....	<b>6</b>
2.1 Measurement Uncertainty .....	6
2.2 Modification Record .....	6
<b>3 General Information</b> .....	<b>7</b>
3.1 General Description of EUT .....	7
3.2 Description of Test Modes .....	9
3.2.1 Test Mode Applicability and Tested Channel Detail .....	10
3.3 Duty Cycle of Test Signal .....	12
3.4 Description of Support Units .....	13
3.4.1 Configuration of System under Test .....	13
3.5 General Description of Applied Standard .....	14
<b>4 Test Types and Results</b> .....	<b>15</b>
4.1 Radiated Emission and Bandedge Measurement .....	15
4.1.1 Limits of Radiated Emission and Bandedge Measurement .....	15
4.1.2 Test Instruments .....	16
4.1.3 Test Procedure .....	18
4.1.4 Deviation from Test Standard .....	19
4.1.5 Test Setup .....	19
4.1.6 EUT Operating Condition .....	20
4.1.7 Test Results .....	21
4.2 Conducted Emission Measurement .....	40
4.2.1 Limits of Conducted Emission Measurement .....	40
4.2.2 Test Instruments .....	40
4.2.3 Test Procedure .....	41
4.2.4 Deviation from Test Standard .....	41
4.2.5 Test Setup .....	41
4.2.6 EUT Operating Condition .....	41
4.2.7 Test Results (Mode 1) .....	42
4.2.8 Test Results (Mode 2) .....	44
4.3 Transmit Power Measurement .....	46
4.3.1 Limits of Transmit Power Measurement .....	46
4.3.2 Test Setup .....	46
4.3.3 Test Instruments .....	46
4.3.4 Test Procedure .....	46
4.3.5 Deviation from Test Standard .....	46
4.3.6 EUT Operating Condition .....	46
4.3.7 Test Result .....	47
4.4 Occupied Bandwidth Measurement .....	49
4.4.1 Test Setup .....	49
4.4.2 Test Instruments .....	49
4.4.3 Test Procedure .....	49
4.4.4 Test Results .....	50
4.5 Peak Power Spectral Density Measurement .....	56
4.5.1 Limits of Peak Power Spectral Density Measurement .....	56
4.5.2 Test Setup .....	56
4.5.3 Test Instruments .....	56
4.5.4 Test Procedure .....	57
4.5.5 Deviation from Test Standard .....	57
4.5.6 EUT Operating Condition .....	57
4.5.7 Test Results .....	58
4.6 Frequency Stability Measurement .....	64

4.6.1	Limits of Frequency Stability Measurement .....	64
4.6.2	Test Setup.....	64
4.6.3	Test Instruments .....	64
4.6.4	Test Procedure .....	64
4.6.5	Deviation from Test Standard .....	64
4.6.6	EUT Operating Condition .....	64
4.6.7	Test Results .....	65
4.7	6dB Bandwidth Measurement .....	66
4.7.1	Limits of 6dB Bandwidth Measurement.....	66
4.7.2	Test Setup.....	66
4.7.3	Test Instruments .....	66
4.7.4	Test Procedure .....	66
4.7.5	Deviation from Test Standard .....	66
4.7.6	EUT Operating Condition .....	66
4.7.7	Test Results .....	67
<b>5</b>	<b>Pictures of Test Arrangements.....</b>	<b>69</b>
	<b>Annex A- Radiated Out of Band Emission (OOBE) Measurement (For U-NII-3 band) .....</b>	<b>70</b>
	<b>Appendix – Information on the Testing Laboratories .....</b>	<b>73</b>

### Release Control Record

Issue No.	Description	Date Issued
RF180502E08-1	Original release.	June 26, 2018

## 1 Certificate of Conformity

**Product:** Cable modem

**Brand:** Ubee

**Test Model:** UBC1310

**Applicant:** Ubee Interactive Corp.

**Test Date:** May 25 to June 06, 2018

**Standard:** 47 CFR FCC Part 15, Subpart E (Section 15.407)  
ANSI C63.10: 2013

The above equipment has been tested by **Bureau Veritas Consumer Products Services (H.K.) Ltd., Taoyuan Branch**, and found compliance with the requirement of the above standards. The test record, data evaluation & Equipment Under Test (EUT) configurations represented herein are true and accurate accounts of the measurements of the sample's EMC characteristics under the conditions specified in this report.

**Prepared by :** Wendy Wu , **Date:** June 26, 2018  
Wendy Wu / Specialist

**Approved by :** May Chen , **Date:** June 26, 2018  
May Chen / Manager

## 2 Summary of Test Results

47 CFR FCC Part 15, Subpart E (Section 15.407)			
FCC Clause	Test Item	Result	Remarks
15.407(b)(6)	AC Power Conducted Emissions	Pass	Meet the requirement of limit. Minimum passing margin is -14.9dB at 0.16172MHz.
15.407(b) (1/2/3/4(i/ii)/6)	Radiated Emissions & Band Edge Measurement*	Pass	Meet the requirement of limit. Minimum passing margin is -0.1dB at 5150.00MHz.
15.407(a)(1/2/3)	Max Average Transmit Power	Pass	Meet the requirement of limit.
---	Occupied Bandwidth Measurement	-	Reference only.
15.407(a)(1/2/3)	Peak Power Spectral Density	Pass	Meet the requirement of limit.
15.407(e)	6dB bandwidth	Pass	Meet the requirement of limit. (U-NII-3 Band only)
15.407(g)	Frequency Stability	Pass	Meet the requirement of limit.
15.203	Antenna Requirement	PASS	Antenna connector is i-pex(MHF) not a standard connector.

\*For U-NII-3 band compliance with rule part 15.407(b)(4)(i), the OOB test plots were recorded in Annex A.

### 2.1 Measurement Uncertainty

Where relevant, the following measurement uncertainty levels have been estimated for tests performed on the EUT as specified in CISPR 16-4-2:

Measurement	Frequency	Expanded Uncertainty (k=2) (±)
Conducted Emissions at mains ports	150kHz ~ 30MHz	1.84 dB
Radiated Emissions up to 1 GHz	30MHz ~ 1GHz	5.53 dB
Radiated Emissions above 1 GHz	1GHz ~ 6GHz	5.08 dB
	6GHz ~ 18GHz	4.98 dB
	18GHz ~ 40GHz	5.19 dB

### 2.2 Modification Record

There were no modifications required for compliance.

### 3 General Information

#### 3.1 General Description of EUT

Product	Cable modem
Brand	Ubee
Test Model	UBC1310
Power Supply Rating	DC 12V from power adapter
Modulation Type	CCK, DQPSK, DBPSK for DSSS 64QAM, 16QAM, QPSK, BPSK for OFDM 256QAM for OFDM in 11ac mode
Modulation Technology	DSSS, OFDM
Transfer Rate	802.11b: up to 11Mbps 802.11a/g: up to 54Mbps 802.11n: up to 450Mbps 802.11ac: up to 1300Mbps
Operating Frequency	<b>2.4GHz:</b> 2.412 ~ 2.462GHz <b>5GHz:</b> 5.18~ 5.24GHz, 5.745 ~ 5.825GHz
Number of Channel	<b>2.4GHz:</b> 802.11b, 802.11g, 802.11n (HT20): 11 802.11n (HT40): 7 <b>5GHz:</b> 802.11a, 802.11n (HT20), 802.11ac (VHT20): 9 802.11n (HT40), 802.11ac (VHT40): 4 802.11ac (VHT80): 2
Output Power	<b>2.4GHz:</b> 532.874mW <b>5GHz:</b> <b>CDD Mode:</b> <b>5.18 ~ 5.24GHz:</b> 603.7mW <b>5.745 ~ 5.825GHz:</b> 947.881mW <b>Beamforming Mode:</b> <b>5.18 ~ 5.24GHz:</b> 603.7mW <b>5.745 ~ 5.825GHz:</b> 608.726mW
Antenna Type	Refer to Note
Antenna Connector	Refer to Note
Accessory Device	Adapter x1
Data Cable Supplied	NA

Note:

1. Simultaneously transmission condition.

Condition	Technology	
1	WLAN 2.4GHz	WLAN 5GHz

Note: The emission of the simultaneous operation has been evaluated and no non-compliance was found.

2. The EUT must be supplied one power adapter and following different models could be chosen as following table:

No.	Brand	Model No.	Part Number	Spec.
1	Lerader	MU30AY120250-A1	MU30AY1120-A10S-F	Input: 100-240Vac, 800mA, 50-60Hz Output: 12V, 2.5A DC Output cable: Unshielded, 1.4m
2	DVE	DSA-30PFG-12 FAR 120250	DSA-30PFG-12 FAR 120250	Input: 100-240Vac, 800mA, 50-60Hz Output: 12V, 2.5A DC Output cable: Unshielded, 1.4m

From the above adapters, the worse radiated emissions was found in Adapter 1. Therefore only the test data of the mode was recorded in this report.

3. The antennas provided to the EUT, please refer to the following table:

Antenna Set.	Chain No.	Brand	Model No.	Antenna Net Gain (dBi)	Frequency Range (GHz)	Antenna Type	Connector Type	Cable Length (mm)
1	0	WHA YU	C107-511273-A	3.9	2.4~2.5	PCB	i-pex(MHF)	45+-3
				3.6	5.05~5.825			
	1	WHA YU	C107-511272-A	4.1	2.4~2.5	PCB	i-pex(MHF)	45+-3
				3.1	5.05~5.825			
	2	WHA YU	C107-511271-A	3.3	2.4~2.5	PCB	i-pex(MHF)	80+-3
				3.4	5.05~5.825			

4. The EUT incorporates a MIMO function:

2.4GHz Band			
MODULATION MODE	DATA RATE (MCS)	TX & RX CONFIGURATION	
802.11b	1 ~ 11Mbps	3TX	3RX
802.11g	6 ~ 54Mbps	3TX	3RX
802.11n (HT20)	MCS 0~7	3TX	3RX
	MCS 8~15	3TX	3RX
	MCS 16~23	3TX	3RX
802.11n (HT40)	MCS 0~7	3TX	3RX
	MCS 8~15	3TX	3RX
	MCS 16~23	3TX	3RX
5GHz Band			
MODULATION MODE	DATA RATE (MCS)	TX & RX CONFIGURATION	
802.11a	6 ~ 54Mbps	3TX	3RX
802.11n (HT20)	MCS 0~7	3TX	3RX
	MCS 8~15	3TX	3RX
	MCS 16~23	3TX	3RX
802.11n (HT40)	MCS 0~7	3TX	3RX
	MCS 8~15	3TX	3RX
	MCS 16~23	3TX	3RX
802.11ac (VHT20)	MCS 0~8, Nss=1	3TX	3RX
	MCS 0~8, Nss=2	3TX	3RX
	MCS 0~9, Nss=3	3TX	3RX
802.11ac (VHT40)	MCS 0~9, Nss=1	3TX	3RX
	MCS 0~9, Nss=2	3TX	3RX
	MCS 0~9, Nss=3	3TX	3RX
802.11ac (VHT80)	MCS 0~9, Nss=1	3TX	3RX
	MCS 0~9, Nss=2	3TX	3RX
	MCS 0~9, Nss=3	3TX	3RX

Note:

- All of modulation mode support beamforming function except 2.4GHz and 802.11a modulation mode.
- The EUT support Beamforming and CDD mode, therefore both mode were investigated and the worst case scenario was identified. The worst case data were presented in test report.

5. The above EUT information is declared by manufacturer and for more detailed features description, please refer to the manufacturer's specifications or user's manual.



### 3.2 Description of Test Modes

#### FOR 5180 ~ 5240MHz

4 channels are provided for 802.11a, 802.11n (HT20), 802.11ac (VHT20):

Channel	Frequency	Channel	Frequency
36	5180MHz	44	5220MHz
40	5200MHz	48	5240MHz

2 channels are provided for 802.11n (HT40), 802.11ac (VHT40):

Channel	Frequency	Channel	Frequency
38	5190MHz	46	5230MHz

1 channel is provided for 802.11ac (VHT80):

Channel	Frequency
42	5210MHz

#### FOR 5745 ~ 5825MHz:

5 channels are provided for 802.11a, 802.11n (HT20), 802.11ac (VHT20):

Channel	Frequency	Channel	Frequency
149	5745MHz	161	5805MHz
153	5765MHz	165	5825MHz
157	5785MHz		

2 channels are provided for 802.11n (HT40), 802.11ac (VHT40):

Channel	Frequency	Channel	Frequency
151	5755MHz	159	5795MHz

1 channel is provided for 802.11ac (VHT80):

Channel	Frequency
155	5775MHz

### 3.2.1 Test Mode Applicability and Tested Channel Detail

EUT Configure Mode	Applicable To				Description
	RE $\geq$ 1G	RE $<$ 1G	PLC	APCM	
1	√	√	√	√	Power from adapter 1
2	-	-	√	-	Power from adapter 2

Where **RE $\geq$ 1G**: Radiated Emission above 1GHz      **RE $<$ 1G**: Radiated Emission below 1GHz  
**PLC**: Power Line Conducted Emission      **APCM**: Antenna Port Conducted Measurement

**NOTE:** "-" means no effect.

#### **Radiated Emission Test (Above 1GHz):**

- Pre-Scan has been conducted to determine the worst-case mode from all possible combinations between available modulations, data rates and antenna ports (if EUT with antenna diversity architecture).
- Following channel(s) was (were) selected for the final test as listed below.

CDD Mode						
Mode	FREQ. Band (MHz)	Available Channel	Tested Channel	Modulation Technology	Modulation Type	Data Rate (Mbps)
802.11a	5180-5240	36 to 48	36, 40, 48	OFDM	BPSK	6
802.11ac (VHT20)		36 to 48	36, 40, 48	OFDM	BPSK	6.5
802.11ac (VHT40)		38 to 46	38, 46	OFDM	BPSK	13.5
802.11ac (VHT80)		42	42	OFDM	BPSK	29.3
802.11a	5745-5825	149 to 165	149, 157, 165	OFDM	BPSK	6
802.11ac (VHT20)		149 to 165	149, 157, 165	OFDM	BPSK	6.5
802.11ac (VHT40)		151 to 159	151, 159	OFDM	BPSK	13.5
802.11ac (VHT80)		155	155	OFDM	BPSK	29.3

#### **Radiated Emission Test (Below 1GHz):**

- Pre-Scan has been conducted to determine the worst-case mode from all possible combinations between available modulations, data rates and antenna ports (if EUT with antenna diversity architecture).
- Following channel(s) was (were) selected for the final test as listed below.

CDD Mode						
Mode	FREQ. Band (MHz)	Available Channel	Tested Channel	Modulation Technology	Modulation Type	Data Rate (Mbps)
802.11ac (VHT40)	5180-5240 5745-5825	38 to 46 151 to 159	159	OFDM	BPSK	13.5

### Power Line Conducted Emission Test:

- Pre-Scan has been conducted to determine the worst-case mode from all possible combinations between available modulations, data rates and antenna ports (if EUT with antenna diversity architecture).
- Following channel(s) was (were) selected for the final test as listed below.

CDD Mode						
Mode	FREQ. Band (MHz)	Available Channel	Tested Channel	Modulation Technology	Modulation Type	Data Rate (Mbps)
802.11ac (VHT40)	5180-5240 5745-5825	38 to 46 151 to 159	159	OFDM	BPSK	13.5

### Antenna Port Conducted Measurement:

- This item includes all test value of each mode, but only includes spectrum plot of worst value of each mode.
- Pre-Scan has been conducted to determine the worst-case mode from all possible combinations between available modulations, data rates and antenna ports (if EUT with antenna diversity architecture).
- Following channel(s) was (were) selected for the final test as listed below.

CDD Mode						
Mode	FREQ. Band (MHz)	Available Channel	Tested Channel	Modulation Technology	Modulation Type	Data Rate (Mbps)
802.11a	5180-5240	36 to 48	36, 40, 48	OFDM	BPSK	6
802.11ac (VHT20)		36 to 48	36, 40, 48	OFDM	BPSK	6.5
802.11ac (VHT40)		38 to 46	38, 46	OFDM	BPSK	13.5
802.11ac (VHT80)		42	42	OFDM	BPSK	29.3
802.11a	5745-5825	149 to 165	149, 157, 165	OFDM	BPSK	6
802.11ac (VHT20)		149 to 165	149, 157, 165	OFDM	BPSK	6.5
802.11ac (VHT40)		151 to 159	151, 159	OFDM	BPSK	13.5
802.11ac (VHT80)		155	155	OFDM	BPSK	29.3
Beamforming Mode (output power only)						
Mode	FREQ. Band (MHz)	Available Channel	Tested Channel	Modulation Technology	Modulation Type	Data Rate (Mbps)
802.11ac (VHT20)	5180-5240	36 to 48	36, 40, 48	OFDM	BPSK	6.5
802.11ac (VHT40)		38 to 46	38, 46	OFDM	BPSK	13.5
802.11ac (VHT80)		42	42	OFDM	BPSK	29.3
802.11ac (VHT20)	5745-5825	149 to 165	149, 157, 165	OFDM	BPSK	6.5
802.11ac (VHT40)		151 to 159	151, 159	OFDM	BPSK	13.5
802.11ac (VHT80)		155	155	OFDM	BPSK	29.3

### Test Condition:

Applicable To	Environmental Conditions	Input Power	Tested By
RE≥1G	25deg. C, 65%RH	120Vac, 60Hz	Eason Tseng
RE<1G	25deg. C, 65%RH	120Vac, 60Hz	Andy Ho
PLC	25deg. C, 68%RH	120Vac, 60Hz	Andy Ho
APCM	21deg. C, 60%RH	120Vac, 60Hz	Jyunchun Lin

### 3.3 Duty Cycle of Test Signal

If duty cycle of test signal is  $\geq 98\%$ , duty factor is not required.

If duty cycle of test signal is  $< 98\%$ , duty factor shall be considered.

**802.11a:** Duty cycle =  $2.061 \text{ ms} / 2.102 \text{ ms} = 0.98$

**802.11ac (VHT20):** Duty cycle =  $1.927 \text{ ms} / 1.947 \text{ ms} = 0.99$

**802.11ac (VHT40):** Duty cycle =  $0.951 \text{ ms} / 0.97 \text{ ms} = 0.98$

**802.11ac (VHT80):** Duty cycle =  $0.459 \text{ ms} / 0.478 \text{ ms} = 0.96$ , Duty factor =  $10 * \log(1/0.96) = 0.18$

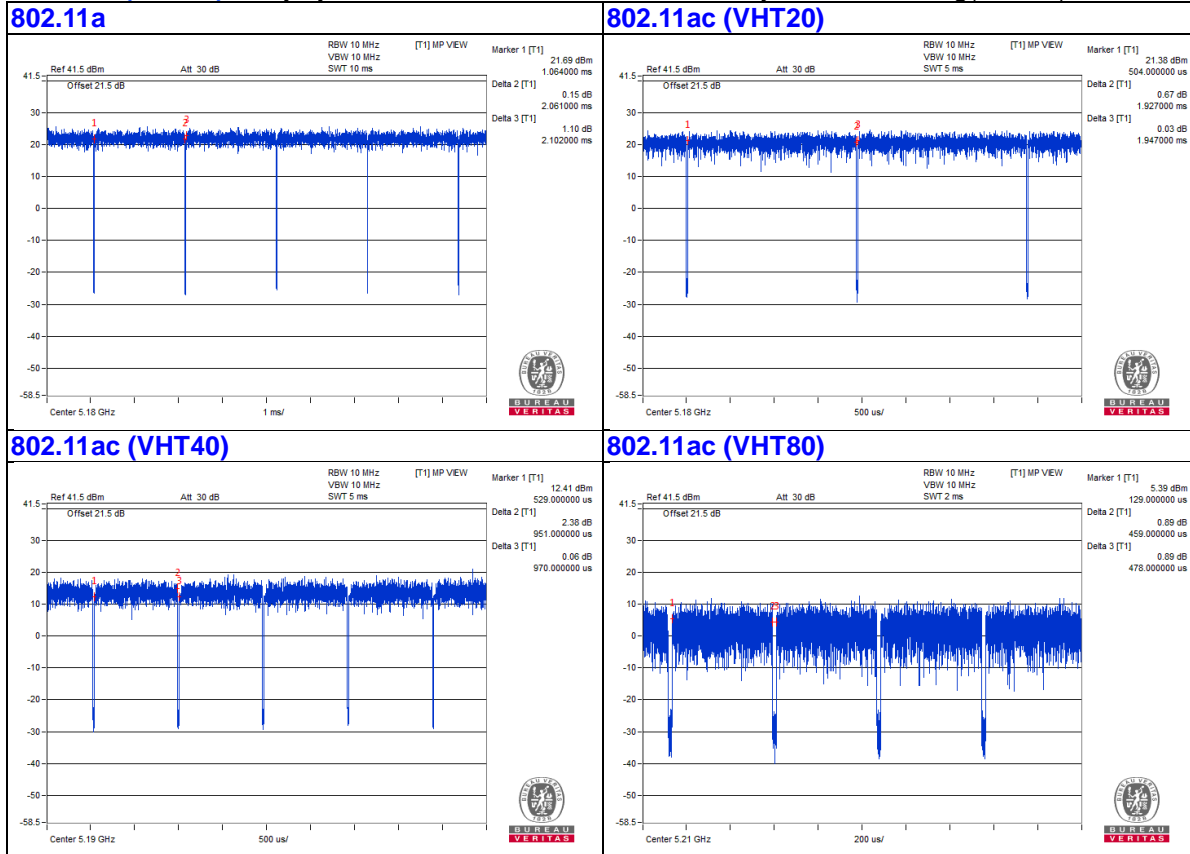

### 3.4 Description of Support Units

The EUT has been tested as an independent unit together with other necessary accessories or support units. The following support units or accessories were used to form a representative test configuration during the tests.

ID	Product	Brand	Model No.	Serial No.	FCC ID	Remarks
A.	Telephone	WONDER	WD-303	7C17KA 04011	NA	Provided by Lab
B.	Laptop	DELL	E5430	HYV4VY1	FCC DoC	Provided by Lab

Note:

1. All power cords of the above support units are non-shielded (1.8m).

ID	Descriptions	Qty.	Length (m)	Shielding (Yes/No)	Cores (Qty.)	Remarks
1.	DC Cable	1	1.4	No	0	Supplied by client
2.	RJ-11 Cable	1	10	No	0	Provided by Lab
3.	RJ-45 Cable	1	10	No	0	Provided by Lab
4.	Coaxial Cable	1	10	Yes	0	Provided by Lab

Note: The core(s) is(are) originally attached to the cable(s).

#### 3.4.1 Configuration of System under Test

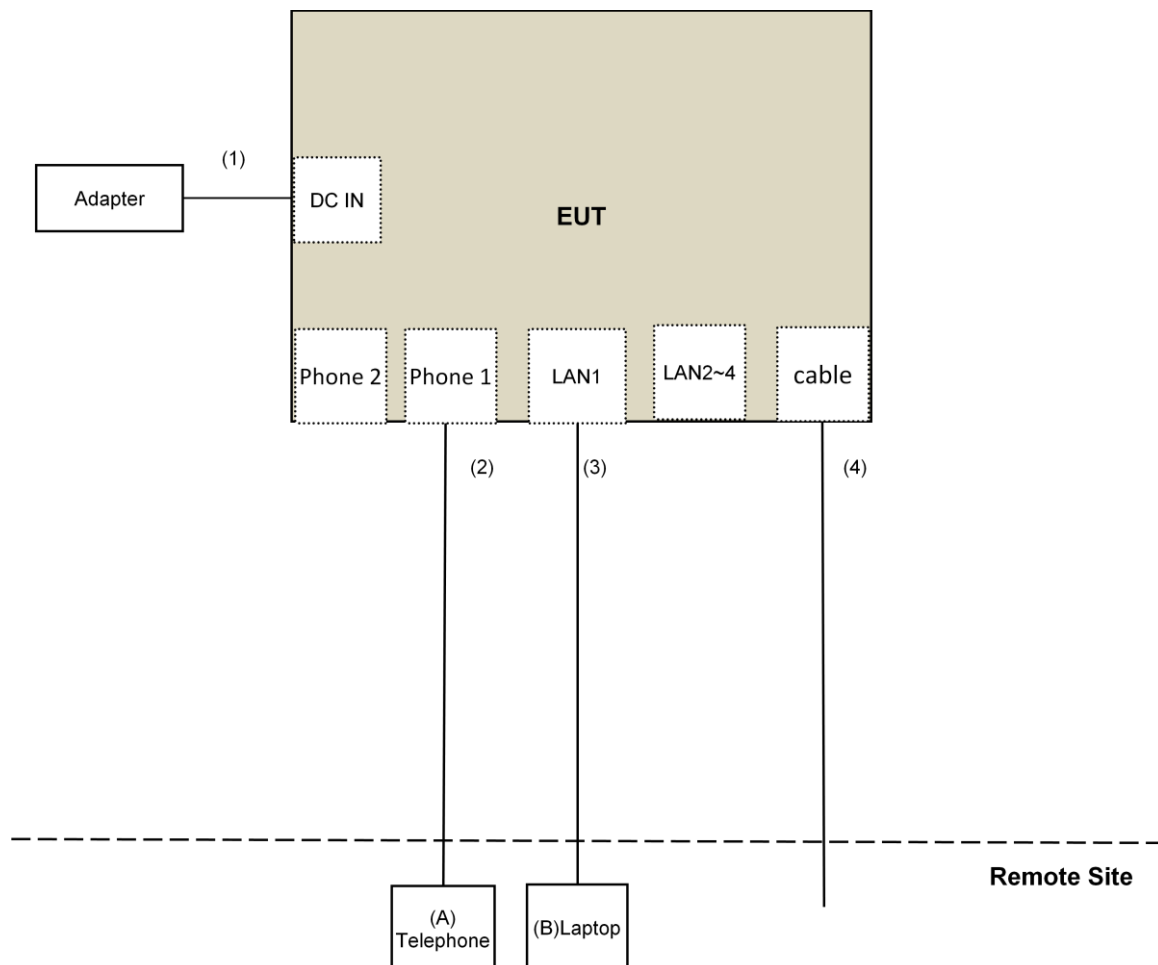

### 3.5 General Description of Applied Standard

The EUT is a RF Product. According to the specifications of the manufacturer, it must comply with the requirements of the following standards:

**FCC Part 15, Subpart E (15.407)**

**KDB 789033 D02 General UNII Test Procedure New Rules v02r01**

**KDB 662911 D01 Multiple Transmitter Output v02r01**

**ANSI C63.10-2013**

All test items have been performed and recorded as per the above standards.

## 4 Test Types and Results

### 4.1 Radiated Emission and Bandedge Measurement

#### 4.1.1 Limits of Radiated Emission and Bandedge Measurement

Radiated emissions which fall in the restricted bands must comply with the radiated emission limits specified as below table.

Frequencies (MHz)	Field Strength (microvolts/meter)	Measurement Distance (meters)
0.009 ~ 0.490	2400/F(kHz)	300
0.490 ~ 1.705	24000/F(kHz)	30
1.705 ~ 30.0	30	30
30 ~ 88	100	3
88 ~ 216	150	3
216 ~ 960	200	3
Above 960	500	3

#### NOTE:

1. The lower limit shall apply at the transition frequencies.
2. Emission level (dBuV/m) = 20 log Emission level (uV/m).
3. For frequencies above 1000MHz, the field strength limits are based on average detector, however, the peak field strength of any emission shall not exceed the maximum permitted average limits, specified above by more than 20dB under any condition of modulation.

Limits of unwanted emission out of the restricted bands

Applicable To		Limit	
789033 D02 General UNII Test Procedure New Rules v02r01		Field Strength at 3m	
		PK:74 (dBuV/m)	AV:54 (dBuV/m)
Frequency Band	Applicable To	EIRP Limit	Equivalent Field Strength at 3m
5150~5250 MHz	15.407(b)(1)	PK:-27 (dBm/MHz)	PK:68.2(dBuV/m)
5250~5350 MHz	15.407(b)(2)		
5470~5725 MHz	15.407(b)(3)		
5725~5850 MHz	<input checked="" type="checkbox"/> 15.407(b)(4)(i)	PK:-27 (dBm/MHz) <sup>*1</sup> PK:10 (dBm/MHz) <sup>*2</sup> PK:15.6 (dBm/MHz) <sup>*3</sup> PK:27 (dBm/MHz) <sup>*4</sup>	PK: 68.2(dBuV/m) <sup>*1</sup> PK:105.2 (dBuV/m) <sup>*2</sup> PK: 110.8(dBuV/m) <sup>*3</sup> PK:122.2 (dBuV/m) <sup>*4</sup>
	<input type="checkbox"/> 15.407(b)(4)(ii)	Emission limits in section 15.247(d)	
<sup>*1</sup> beyond 75 MHz or more above of the band edge.		<sup>*2</sup> below the band edge increasing linearly to 10 dBm/MHz at 25 MHz above.	
<sup>*3</sup> below the band edge increasing linearly to a level of 15.6 dBm/MHz at 5 MHz above.		<sup>*4</sup> from 5 MHz above or below the band edge increasing linearly to a level of 27 dBm/MHz at the band edge.	

#### Note:

The following formula is used to convert the equipment isotropic radiated power (eirp) to field strength:

$$E = \frac{1000000\sqrt{30P}}{3} \mu\text{V/m, where P is the eirp (Watts).}$$

## 4.1.2 Test Instruments

DESCRIPTION & MANUFACTURER	MODEL NO.	SERIAL NO.	CALIBRATED DATE	CALIBRATED UNTIL
Test Receiver Agilent	N9038A	MY50010156	July 12, 2017	July 11, 2018
Pre-Amplifier EMCI	EMC001340	980142	Feb. 09, 2018	Feb. 08, 2019
Loop Antenna <sup>(*)</sup> Electro-Metrics	EM-6879	264	Dec. 16, 2016	Dec. 15, 2018
RF Cable	NA	LOOPCAB-001 LOOPCAB-002	Jan. 15, 2018	Jan. 14, 2019
Pre-Amplifier Mini-Circuits	ZFL-1000VH2B	AMP-ZFL-05	May 05, 2018	May 04, 2019
Trilog Broadband Antenna SCHWARZBECK	VULB 9168	9168-361	Nov. 29, 2017	Nov. 28, 2018
RF Cable	8D	966-3-1 966-3-2 966-3-3	Mar. 20, 2018	Mar. 19, 2019
Fixed attenuator Mini-Circuits	UNAT-5+	PAD-3m-3-01	Oct. 03, 2017	Oct. 02, 2018
Horn_Antenna SCHWARZBECK	BBHA9120-D	9120D-406	Dec. 12, 2017	Dec. 11, 2018
Pre-Amplifier EMCI	EMC12630SE	980384	Jan. 29, 2018	Jan. 28, 2019
RF Cable	EMC104-SM-SM-1200 EMC104-SM-SM-2000 EMC104-SM-SM-5000	160922 150317 150322	Jan. 29, 2018	Jan. 28, 2019
Spectrum Analyzer Keysight	N9030A	MY54490679	July 25, 2017	July 24, 2018
Pre-Amplifier EMCI	EMC184045SE	980386	Jan. 29, 2018	Jan. 28, 2019
Horn_Antenna SCHWARZBECK	BBHA 9170	BBHA9170608	Dec. 14, 2017	Dec. 13, 2018
RF Cable	EMC102-KM-KM-1200	160924	Jan. 29, 2018	Jan. 28, 2019
Software	ADT_Radiated_V8.7.08	NA	NA	NA
Antenna Tower & Turn Table Max-Full	MF-7802	MF780208406	NA	NA
Boresight Antenna Fixture	FBA-01	FBA-SIP01	NA	NA
Spectrum Analyzer R&S	FSv40	100964	July 1, 2017	June 30, 2018
Power meter Anritsu	ML2495A	1014008	May 09, 2018	May 08, 2019
Power sensor Anritsu	MA2411B	0917122	May 09, 2018	May 08, 2019
AC Power Source Extech Electronics	6205	1440452	NA	NA
Temperature & Humidity Chamber Giant Force	GTH-150-40-SP-AR	MAA0812-008	Jan. 10, 2018	Jan. 09, 2019
True RMS Clamp Meter FLUKE	325	31130711WS	May 22, 2018	May 21, 2019



**Note:**

1. The calibration interval of the above test instruments is 12 months and the calibrations are traceable to NML/ROC and NIST/USA.
2. \*The calibration interval of the above test instruments is 24 months and the calibrations are traceable to NML/ROC and NIST/USA.
3. The test was performed in 966 Chamber No. 3.
4. The CANADA Site Registration No. is 20331-1
5. Loop antenna was used for all emissions below 30 MHz.
6. Tested Date: May 25 to June 06, 2018

#### 4.1.3 Test Procedure

##### **For Radiated emission below 30MHz**

- a. The EUT was placed on the top of a rotating table 0.8 meters above the ground at a 3 meter chamber room. The table was rotated 360 degrees to determine the position of the highest radiation.
- b. The EUT was set 3 meters away from the interference-receiving antenna, which was mounted on the top of a variable-height antenna tower.
- c. Parallel, perpendicular, and ground-parallel orientations of the antenna are set to make the measurement.
- d. For each suspected emission, the EUT was arranged to its worst case and the rotatable table was turned from 0 degrees to 360 degrees to find the maximum reading.
- e. The test-receiver system was set to Quasi-Peak Detect Function and Specified Bandwidth with Maximum Hold Mode.

##### **NOTE:**

1. The resolution bandwidth and video bandwidth of test receiver/spectrum analyzer is 9kHz at frequency below 30MHz.

##### **For Radiated emission above 30MHz**

- a. The EUT was placed on the top of a rotating table 0.8 meters (for 30MHz ~ 1GHz) / 1.5 meters (for above 1GHz) above the ground at 3 meter chamber room for test. The table was rotated 360 degrees to determine the position of the highest radiation.
- b. The EUT was set 3 meters away from the interference-receiving antenna, which was mounted on the top of a variable-height antenna tower.
- c. The height of antenna is varied from one meter to four meters above the ground to determine the maximum value of the field strength. Both horizontal and vertical polarizations of the antenna are set to make the measurement.
- d. For each suspected emission, the EUT was arranged to its worst case and then the antenna was tuned to heights from 1 meter to 4 meters and the rotatable table was turned from 0 degrees to 360 degrees to find the maximum reading.
- e. The test-receiver system was set to quasi-peak detect function and specified bandwidth with maximum hold mode when the test frequency is below 1 GHz.
- f. The test-receiver system was set to peak and average detects function and specified bandwidth with maximum hold mode when the test frequency is above 1 GHz. If the peak reading value also meets average limit, measurement with the average detector is unnecessary.

##### **Note:**

1. The resolution bandwidth and video bandwidth of test receiver/spectrum analyzer is 120kHz for Quasi-peak detection (QP) at frequency below 1GHz.
2. The resolution bandwidth of test receiver/spectrum analyzer is 1 MHz and the video bandwidth is 3 MHz for Peak detection (PK) at frequency above 1GHz.
3. The resolution bandwidth of test receiver/spectrum analyzer is 1MHz and the video bandwidth is  $\geq 1/T$  (Duty cycle < 98%) or 10Hz (Duty cycle  $\geq 98\%$ ) for Average detection (AV) at frequency above 1GHz.
4. All modes of operation were investigated and the worst-case emissions are reported.

4.1.4 Deviation from Test Standard

No deviation.

4.1.5 Test Setup

**For Radiated emission below 30MHz**

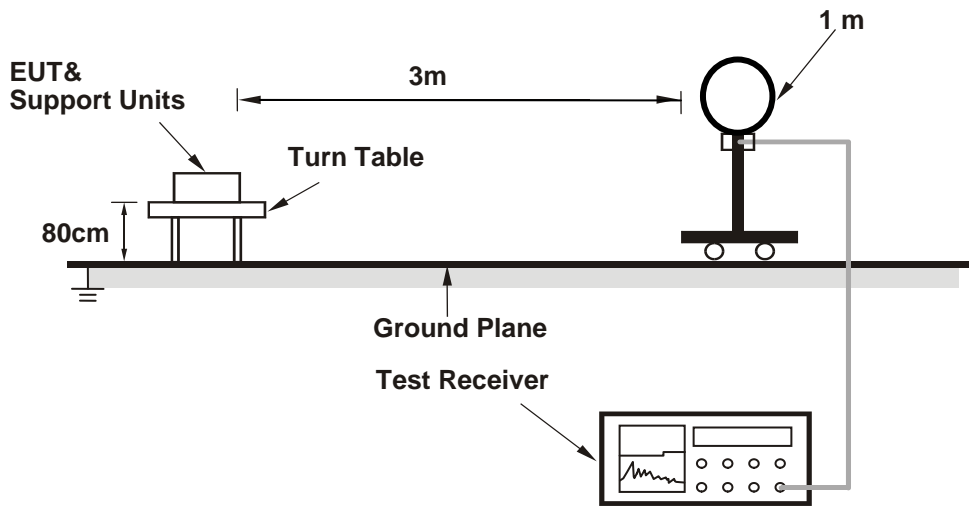

**For Radiated emission 30MHz to 1GHz**

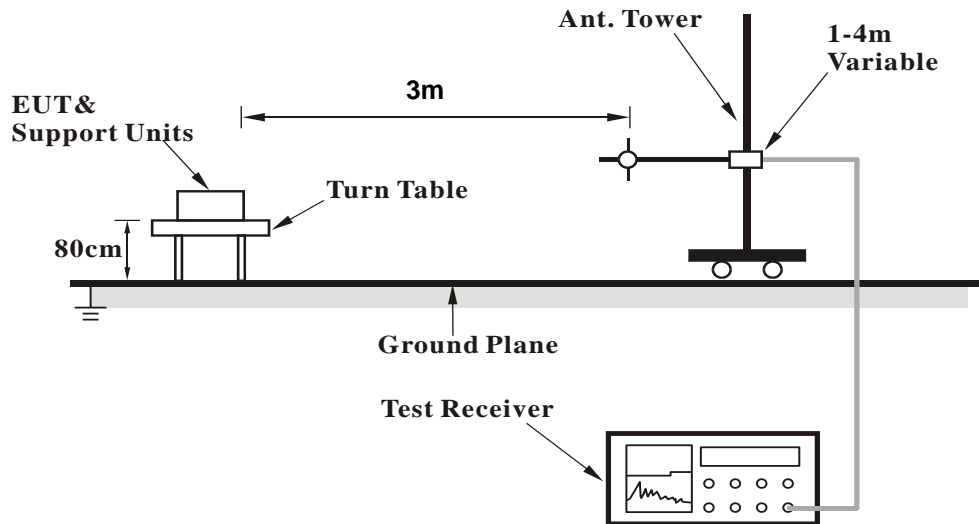

### For Radiated emission above 1GHz

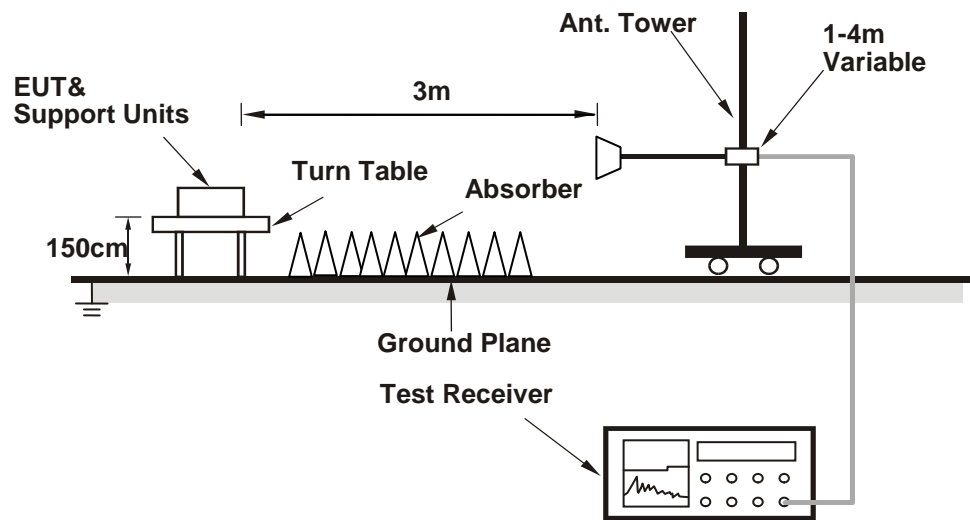

For the actual test configuration, please refer to the attached file (Test Setup Photo).

#### 4.1.6 EUT Operating Condition

- a. Connected the EUT with the Laptop which is placed on remote site.
- b. Controlling software (Mtool 2.0.1.1) has been activated to set the EUT on specific status.

4.1.7 Test Results

Above 1GHz Data:

802.11a

<b>CHANNEL</b>	TX Channel 36	<b>DETECTOR FUNCTION</b>	Peak (PK)
<b>FREQUENCY RANGE</b>	1GHz ~ 40GHz		Average (AV)

ANTENNA POLARITY & TEST DISTANCE: HORIZONTAL AT 3 M								
NO.	FREQ. (MHz)	EMISSION LEVEL (dBuV/m)	LIMIT (dBuV/m)	MARGIN (dB)	ANTENNA HEIGHT (m)	TABLE ANGLE (Degree)	RAW VALUE (dBuV)	CORRECTION FACTOR (dB/m)
1	5150.00	68.2 PK	74.0	-5.8	2.98 H	70	65.2	3.0
2	5150.00	53.9 AV	54.0	-0.1	2.98 H	70	50.9	3.0
3	*5180.00	117.6 PK			2.98 H	70	114.6	3.0
4	*5180.00	107.9 AV			2.98 H	70	104.9	3.0
5	#10360.00	49.2 PK	74.0	-24.8	2.03 H	333	37.0	12.2
6	#10360.00	37.6 AV	54.0	-16.4	2.03 H	333	25.4	12.2
7	15540.00	45.2 PK	74.0	-28.8	1.96 H	178	32.4	12.8
8	15540.00	33.2 AV	54.0	-20.8	1.96 H	178	20.4	12.8
ANTENNA POLARITY & TEST DISTANCE: VERTICAL AT 3 M								
NO.	FREQ. (MHz)	EMISSION LEVEL (dBuV/m)	LIMIT (dBuV/m)	MARGIN (dB)	ANTENNA HEIGHT (m)	TABLE ANGLE (Degree)	RAW VALUE (dBuV)	CORRECTION FACTOR (dB/m)
1	5150.00	67.6 PK	74.0	-6.4	3.56 V	162	64.6	3.0
2	5150.00	53.2 AV	54.0	-0.8	3.56 V	162	50.2	3.0
3	*5180.00	113.6 PK			3.56 V	162	110.6	3.0
4	*5180.00	104.6 AV			3.56 V	162	101.6	3.0
5	#10360.00	50.3 PK	74.0	-23.7	1.41 V	69	38.1	12.2
6	#10360.00	38.9 AV	54.0	-15.1	1.41 V	69	26.7	12.2
7	15540.00	46.1 PK	74.0	-27.9	1.48 V	154	33.3	12.8
8	15540.00	34.2 AV	54.0	-19.8	1.48 V	154	21.4	12.8

REMARKS:

1. Emission Level(dBuV/m) = Raw Value(dBuV) + Correction Factor(dB/m)
2. Correction Factor(dB/m) = Antenna Factor(dB/m) + Cable Factor(dB) – Pre-Amplifier Factor(dB)
3. The other emission levels were very low against the limit.
4. Margin value = Emission Level – Limit value
5. " \* ": Fundamental frequency.
6. " # ": The radiated frequency is out of the restricted band.

<b>CHANNEL</b>	TX Channel 40	<b>DETECTOR FUNCTION</b>	Peak (PK)
<b>FREQUENCY RANGE</b>	1GHz ~ 40GHz		Average (AV)

**ANTENNA POLARITY & TEST DISTANCE: HORIZONTAL AT 3 M**

NO.	FREQ. (MHz)	EMISSION LEVEL (dBuV/m)	LIMIT (dBuV/m)	MARGIN (dB)	ANTENNA HEIGHT (m)	TABLE ANGLE (Degree)	RAW VALUE (dBuV)	CORRECTION FACTOR (dB/m)
1	5150.00	67.4 PK	74.0	-6.6	3.10 H	92	64.4	3.0
2	5150.00	53.2 AV	54.0	-0.8	3.10 H	92	50.2	3.0
3	*5200.00	119.5 PK			3.10 H	92	116.6	2.9
4	*5200.00	110.1 AV			3.10 H	92	107.2	2.9
5	5350.00	48.5 PK	74.0	-25.5	3.10 H	92	45.7	2.8
6	5350.00	41.1 AV	54.0	-12.9	3.10 H	92	38.3	2.8
7	5359.00	60.2 PK	74.0	-13.8	3.07 H	92	57.3	2.9
8	5359.00	51.1 AV	54.0	-2.9	3.07 H	92	48.2	2.9
9	#10400.00	51.3 PK	74.0	-22.7	2.01 H	324	38.9	12.4
10	#10400.00	38.5 AV	54.0	-15.5	2.01 H	324	26.1	12.4
11	15600.00	50.1 PK	74.0	-23.9	1.91 H	182	36.9	13.2
12	15600.00	39.0 AV	54.0	-15.0	1.91 H	182	25.8	13.2

**ANTENNA POLARITY & TEST DISTANCE: VERTICAL AT 3 M**

NO.	FREQ. (MHz)	EMISSION LEVEL (dBuV/m)	LIMIT (dBuV/m)	MARGIN (dB)	ANTENNA HEIGHT (m)	TABLE ANGLE (Degree)	RAW VALUE (dBuV)	CORRECTION FACTOR (dB/m)
1	5150.00	64.7 PK	74.0	-9.3	3.61 V	162	61.7	3.0
2	5150.00	52.8 AV	54.0	-1.2	3.61 V	162	49.8	3.0
3	*5200.00	113.5 PK			3.61 V	162	110.6	2.9
4	*5200.00	104.7 AV			3.61 V	162	101.8	2.9
5	5350.00	47.2 PK	74.0	-26.8	3.61 V	162	44.4	2.8
6	5350.00	40.7 AV	54.0	-13.3	3.61 V	162	37.9	2.8
7	5359.00	59.1 PK	74.0	-14.9	3.61 V	162	56.2	2.9
8	5359.00	49.9 AV	54.0	-4.1	3.61 V	162	47.0	2.9
9	#10400.00	52.2 PK	74.0	-21.8	1.44 V	72	39.8	12.4
10	#10400.00	40.2 AV	54.0	-13.8	1.44 V	72	27.8	12.4
11	15600.00	46.7 PK	74.0	-27.3	1.50 V	158	33.5	13.2
12	15600.00	35.6 AV	54.0	-18.4	1.50 V	158	22.4	13.2

**REMARKS:**

1. Emission Level(dBuV/m) = Raw Value(dBuV) + Correction Factor(dB/m)
2. Correction Factor(dB/m) = Antenna Factor(dB/m) + Cable Factor(dB) – Pre-Amplifier Factor(dB)
3. The other emission levels were very low against the limit.
4. Margin value = Emission Level – Limit value
5. " \* ": Fundamental frequency.
6. " # ": The radiated frequency is out of the restricted band.

<b>CHANNEL</b>	TX Channel 48	<b>DETECTOR FUNCTION</b>	Peak (PK)
<b>FREQUENCY RANGE</b>	1GHz ~ 40GHz		Average (AV)

**ANTENNA POLARITY & TEST DISTANCE: HORIZONTAL AT 3 M**

NO.	FREQ. (MHz)	EMISSION LEVEL (dBuV/m)	LIMIT (dBuV/m)	MARGIN (dB)	ANTENNA HEIGHT (m)	TABLE ANGLE (Degree)	RAW VALUE (dBuV)	CORRECTION FACTOR (dB/m)
1	*5240.00	118.3 PK			3.07 H	90	115.6	2.7
2	*5240.00	108.9 AV			3.07 H	90	106.2	2.7
3	5350.00	49.6 PK	74.0	-24.4	3.07 H	90	46.8	2.8
4	5350.00	42.4 AV	54.0	-11.6	3.07 H	90	39.6	2.8
5	5399.00	60.2 PK	74.0	-13.8	3.07 H	90	57.2	3.0
6	5399.00	49.6 AV	54.0	-4.4	3.07 H	90	46.6	3.0
7	#10480.00	50.5 PK	74.0	-23.5	2.01 H	338	37.8	12.7
8	#10480.00	38.6 AV	54.0	-15.4	2.01 H	338	25.9	12.7
9	15720.00	50.1 PK	74.0	-23.9	1.95 H	166	37.8	12.3
10	15720.00	38.1 AV	54.0	-15.9	1.95 H	166	25.8	12.3

**ANTENNA POLARITY & TEST DISTANCE: VERTICAL AT 3 M**

NO.	FREQ. (MHz)	EMISSION LEVEL (dBuV/m)	LIMIT (dBuV/m)	MARGIN (dB)	ANTENNA HEIGHT (m)	TABLE ANGLE (Degree)	RAW VALUE (dBuV)	CORRECTION FACTOR (dB/m)
1	*5240.00	114.3 PK			3.56 V	163	111.6	2.7
2	*5240.00	105.6 AV			3.56 V	163	102.9	2.7
3	5350.00	48.3 PK	74.0	-25.7	3.56 V	163	45.5	2.8
4	5350.00	41.2 AV	54.0	-12.8	3.56 V	163	38.4	2.8
5	5399.00	59.2 PK	74.0	-14.8	3.56 V	163	56.2	3.0
6	5399.00	48.6 AV	54.0	-5.4	3.56 V	163	45.6	3.0
7	#10480.00	51.4 PK	74.0	-22.6	1.50 V	56	38.7	12.7
8	#10480.00	39.3 AV	54.0	-14.7	1.50 V	56	26.6	12.7
9	15720.00	46.3 PK	74.0	-27.7	1.54 V	160	34.0	12.3
10	15720.00	34.6 AV	54.0	-19.4	1.54 V	160	22.3	12.3

**REMARKS:**

1. Emission Level(dBuV/m) = Raw Value(dBuV) + Correction Factor(dB/m)
2. Correction Factor(dB/m) = Antenna Factor(dB/m) + Cable Factor(dB) – Pre-Amplifier Factor(dB)
3. The other emission levels were very low against the limit.
4. Margin value = Emission Level – Limit value
5. " \* ": Fundamental frequency.
6. " # ": The radiated frequency is out of the restricted band.

<b>CHANNEL</b>	TX Channel 149	<b>DETECTOR FUNCTION</b>	Peak (PK)
<b>FREQUENCY RANGE</b>	1GHz ~ 40GHz		Average (AV)

**ANTENNA POLARITY & TEST DISTANCE: HORIZONTAL AT 3 M**

NO.	FREQ. (MHz)	EMISSION LEVEL (dBuV/m)	LIMIT (dBuV/m)	MARGIN (dB)	ANTENNA HEIGHT (m)	TABLE ANGLE (Degree)	RAW VALUE (dBuV)	CORRECTION FACTOR (dB/m)
1	#5590.02	60.8 PK	68.2	-7.4	2.48 H	109	57.5	3.3
2	*5745.00	119.5 PK			2.48 H	109	116.1	3.4
3	*5745.00	110.2 AV			2.48 H	109	106.8	3.4
4	#5982.12	60.0 PK	68.2	-8.2	2.48 H	109	56.3	3.7
5	11490.00	51.9 PK	74.0	-22.1	1.60 H	315	39.2	12.7
6	11490.00	38.5 AV	54.0	-15.5	1.60 H	315	25.8	12.7
7	#17235.00	48.2 PK	74.0	-25.8	1.93 H	265	32.5	15.7
8	#17235.00	36.4 AV	54.0	-17.6	1.93 H	265	20.7	15.7

**ANTENNA POLARITY & TEST DISTANCE: VERTICAL AT 3 M**

NO.	FREQ. (MHz)	EMISSION LEVEL (dBuV/m)	LIMIT (dBuV/m)	MARGIN (dB)	ANTENNA HEIGHT (m)	TABLE ANGLE (Degree)	RAW VALUE (dBuV)	CORRECTION FACTOR (dB/m)
1	#5583.53	57.7 PK	68.2	-10.5	1.74 V	216	54.5	3.2
2	*5745.00	113.6 PK			1.74 V	216	110.2	3.4
3	*5745.00	103.3 AV			1.74 V	216	99.9	3.4
4	#5983.90	57.2 PK	68.2	-11.0	1.74 V	216	53.5	3.7
5	11490.00	52.1 PK	74.0	-21.9	1.49 V	61	39.4	12.7
6	11490.00	39.3 AV	54.0	-14.7	1.49 V	61	26.6	12.7
7	#17235.00	49.1 PK	74.0	-24.9	1.46 V	138	33.4	15.7
8	#17235.00	37.0 AV	54.0	-17.0	1.46 V	138	21.3	15.7

**REMARKS:**

1. Emission Level(dBuV/m) = Raw Value(dBuV) + Correction Factor(dB/m)
2. Correction Factor(dB/m) = Antenna Factor(dB/m) + Cable Factor(dB) – Pre-Amplifier Factor(dB)
3. The other emission levels were very low against the limit.
4. Margin value = Emission Level – Limit value
5. " \* ": Fundamental frequency.
6. " # ": The radiated frequency is out of the restricted band.



<b>CHANNEL</b>	TX Channel 157	<b>DETECTOR FUNCTION</b>	Peak (PK)
<b>FREQUENCY RANGE</b>	1GHz ~ 40GHz		Average (AV)

**ANTENNA POLARITY & TEST DISTANCE: HORIZONTAL AT 3 M**

NO.	FREQ. (MHz)	EMISSION LEVEL (dBuV/m)	LIMIT (dBuV/m)	MARGIN (dB)	ANTENNA HEIGHT (m)	TABLE ANGLE (Degree)	RAW VALUE (dBuV)	CORRECTION FACTOR (dB/m)
1	#5624.25	61.6 PK	68.2	-6.6	2.50 H	92	58.3	3.3
2	*5785.00	120.9 PK			2.50 H	92	117.3	3.6
3	*5785.00	111.3 AV			2.50 H	92	107.7	3.6
4	#5952.84	60.8 PK	68.2	-7.4	2.50 H	92	57.1	3.7
5	11570.00	50.6 PK	74.0	-23.4	1.62 H	326	37.7	12.9
6	11570.00	39.5 AV	54.0	-14.5	1.62 H	326	26.6	12.9
7	#17355.00	49.8 PK	74.0	-24.2	1.89 H	276	33.3	16.5
8	#17355.00	37.6 AV	54.0	-16.4	1.89 H	276	21.1	16.5

**ANTENNA POLARITY & TEST DISTANCE: VERTICAL AT 3 M**

NO.	FREQ. (MHz)	EMISSION LEVEL (dBuV/m)	LIMIT (dBuV/m)	MARGIN (dB)	ANTENNA HEIGHT (m)	TABLE ANGLE (Degree)	RAW VALUE (dBuV)	CORRECTION FACTOR (dB/m)
1	#5550.38	56.2 PK	68.2	-12.0	1.30 V	214	53.1	3.1
2	*5785.00	114.3 PK			1.30 V	214	110.7	3.6
3	*5785.00	104.6 AV			1.30 V	214	101.0	3.6
4	#5952.80	55.8 PK	68.2	-12.4	1.30 V	214	52.1	3.7
5	11570.00	53.1 PK	74.0	-20.9	1.46 V	61	40.2	12.9
6	11570.00	40.8 AV	54.0	-13.2	1.46 V	61	27.9	12.9
7	#17355.00	50.2 PK	74.0	-23.8	1.50 V	143	33.7	16.5
8	#17355.00	38.2 AV	54.0	-15.8	1.50 V	143	21.7	16.5

**REMARKS:**

1. Emission Level(dBuV/m) = Raw Value(dBuV) + Correction Factor(dB/m)
2. Correction Factor(dB/m) = Antenna Factor(dB/m) + Cable Factor(dB) – Pre-Amplifier Factor(dB)
3. The other emission levels were very low against the limit.
4. Margin value = Emission Level – Limit value
5. " \* ": Fundamental frequency.
6. " # ": The radiated frequency is out of the restricted band.

<b>CHANNEL</b>	TX Channel 165	<b>DETECTOR FUNCTION</b>	Peak (PK)
<b>FREQUENCY RANGE</b>	1GHz ~ 40GHz		Average (AV)

**ANTENNA POLARITY & TEST DISTANCE: HORIZONTAL AT 3 M**

NO.	FREQ. (MHz)	EMISSION LEVEL (dBuV/m)	LIMIT (dBuV/m)	MARGIN (dB)	ANTENNA HEIGHT (m)	TABLE ANGLE (Degree)	RAW VALUE (dBuV)	CORRECTION FACTOR (dB/m)
1	#5583.78	60.3 PK	68.2	-7.9	2.41 H	94	57.1	3.2
2	*5825.00	120.6 PK			2.41 H	94	116.9	3.7
3	*5825.00	110.9 AV			2.41 H	94	107.2	3.7
4	#5985.92	61.6 PK	68.2	-6.6	2.41 H	94	57.9	3.7
5	11650.00	50.4 PK	74.0	-23.6	1.65 H	313	37.5	12.9
6	11650.00	39.4 AV	54.0	-14.6	1.65 H	313	26.5	12.9
7	#17475.00	49.6 PK	74.0	-24.4	1.86 H	276	31.7	17.9
8	#17475.00	37.2 AV	54.0	-16.8	1.86 H	276	19.3	17.9

**ANTENNA POLARITY & TEST DISTANCE: VERTICAL AT 3 M**

NO.	FREQ. (MHz)	EMISSION LEVEL (dBuV/m)	LIMIT (dBuV/m)	MARGIN (dB)	ANTENNA HEIGHT (m)	TABLE ANGLE (Degree)	RAW VALUE (dBuV)	CORRECTION FACTOR (dB/m)
1	#5578.20	55.0 PK	68.2	-13.2	1.40 V	211	51.8	3.2
2	*5825.00	113.9 PK			1.40 V	211	110.2	3.7
3	*5825.00	104.3 AV			1.40 V	211	100.6	3.7
4	#5983.71	57.5 PK	68.2	-10.7	1.40 V	211	53.8	3.7
5	11650.00	53.2 PK	74.0	-20.8	1.41 V	57	40.3	12.9
6	11650.00	41.1 AV	54.0	-12.9	1.41 V	57	28.2	12.9
7	#17475.00	49.7 PK	74.0	-24.3	1.55 V	129	31.8	17.9
8	#17475.00	38.0 AV	54.0	-16.0	1.55 V	129	20.1	17.9

**REMARKS:**

1. Emission Level(dBuV/m) = Raw Value(dBuV) + Correction Factor(dB/m)
2. Correction Factor(dB/m) = Antenna Factor(dB/m) + Cable Factor(dB) – Pre-Amplifier Factor(dB)
3. The other emission levels were very low against the limit.
4. Margin value = Emission Level – Limit value
5. " \* ": Fundamental frequency.
6. " # ": The radiated frequency is out of the restricted band.

**802.11ac (VHT20)**

<b>CHANNEL</b>	TX Channel 36	<b>DETECTOR FUNCTION</b>	Peak (PK)
<b>FREQUENCY RANGE</b>	1GHz ~ 40GHz		Average (AV)

**ANTENNA POLARITY & TEST DISTANCE: HORIZONTAL AT 3 M**

NO.	FREQ. (MHz)	EMISSION LEVEL (dBuV/m)	LIMIT (dBuV/m)	MARGIN (dB)	ANTENNA HEIGHT (m)	TABLE ANGLE (Degree)	RAW VALUE (dBuV)	CORRECTION FACTOR (dB/m)
1	5150.00	68.6 PK	74.0	-5.4	2.95 H	60	65.6	3.0
2	5150.00	53.8 AV	54.0	-0.2	2.95 H	60	50.8	3.0
3	*5180.00	117.9 PK			2.95 H	60	114.9	3.0
4	*5180.00	108.4 AV			2.95 H	60	105.4	3.0
5	#10360.00	50.1 PK	74.0	-23.9	2.01 H	330	37.9	12.2
6	#10360.00	37.5 AV	54.0	-16.5	2.01 H	330	25.3	12.2
7	15540.00	44.2 PK	74.0	-29.8	2.01 H	166	31.4	12.8
8	15540.00	33.5 AV	54.0	-20.5	2.01 H	166	20.7	12.8

**ANTENNA POLARITY & TEST DISTANCE: VERTICAL AT 3 M**

NO.	FREQ. (MHz)	EMISSION LEVEL (dBuV/m)	LIMIT (dBuV/m)	MARGIN (dB)	ANTENNA HEIGHT (m)	TABLE ANGLE (Degree)	RAW VALUE (dBuV)	CORRECTION FACTOR (dB/m)
1	5150.00	67.8 PK	74.0	-6.2	3.57 V	170	64.8	3.0
2	5150.00	53.4 AV	54.0	-0.6	3.57 V	170	50.4	3.0
3	*5180.00	113.2 PK			3.57 V	170	110.2	3.0
4	*5180.00	104.4 AV			3.57 V	170	101.4	3.0
5	#10360.00	51.2 PK	74.0	-22.8	1.39 V	70	39.0	12.2
6	#10360.00	38.9 AV	54.0	-15.1	1.39 V	70	26.7	12.2
7	15540.00	45.7 PK	74.0	-28.3	1.43 V	151	32.9	12.8
8	15540.00	34.6 AV	54.0	-19.4	1.43 V	151	21.8	12.8

**REMARKS:**

- Emission Level(dBuV/m) = Raw Value(dBuV) + Correction Factor(dB/m)
- Correction Factor(dB/m) = Antenna Factor(dB/m) + Cable Factor(dB) – Pre-Amplifier Factor(dB)
- The other emission levels were very low against the limit.
- Margin value = Emission Level – Limit value
- " \* ": Fundamental frequency.
- " # ": The radiated frequency is out of the restricted band.

<b>CHANNEL</b>	TX Channel 40	<b>DETECTOR FUNCTION</b>	Peak (PK)
<b>FREQUENCY RANGE</b>	1GHz ~ 40GHz		Average (AV)

**ANTENNA POLARITY & TEST DISTANCE: HORIZONTAL AT 3 M**

NO.	FREQ. (MHz)	EMISSION LEVEL (dBuV/m)	LIMIT (dBuV/m)	MARGIN (dB)	ANTENNA HEIGHT (m)	TABLE ANGLE (Degree)	RAW VALUE (dBuV)	CORRECTION FACTOR (dB/m)
1	5150.00	66.6 PK	74.0	-7.4	3.18 H	101	63.6	3.0
2	5150.00	52.8 AV	54.0	-1.2	3.18 H	101	49.8	3.0
3	*5200.00	119.1 PK			3.18 H	101	116.2	2.9
4	*5200.00	110.0 AV			3.18 H	101	107.1	2.9
5	5350.00	47.3 PK	74.0	-26.7	3.15 H	84	44.5	2.8
6	5350.00	40.2 AV	54.0	-13.8	3.15 H	84	37.4	2.8
7	5359.00	59.8 PK	74.0	-14.2	3.14 H	91	56.9	2.9
8	5359.00	50.8 AV	54.0	-3.2	3.14 H	91	47.9	2.9
9	#10400.00	51.7 PK	74.0	-22.3	2.02 H	330	39.3	12.4
10	#10400.00	38.8 AV	54.0	-15.2	2.02 H	330	26.4	12.4
11	15600.00	49.1 PK	74.0	-24.9	1.87 H	191	35.9	13.2
12	15600.00	38.3 AV	54.0	-15.7	1.87 H	191	25.1	13.2

**ANTENNA POLARITY & TEST DISTANCE: VERTICAL AT 3 M**

NO.	FREQ. (MHz)	EMISSION LEVEL (dBuV/m)	LIMIT (dBuV/m)	MARGIN (dB)	ANTENNA HEIGHT (m)	TABLE ANGLE (Degree)	RAW VALUE (dBuV)	CORRECTION FACTOR (dB/m)
1	5150.00	63.2 PK	74.0	-10.8	3.61 V	173	60.2	3.0
2	5150.00	52.4 AV	54.0	-1.6	3.61 V	173	49.4	3.0
3	*5200.00	113.2 PK			3.57 V	149	110.3	2.9
4	*5200.00	104.3 AV			3.57 V	149	101.4	2.9
5	5350.00	46.9 PK	74.0	-27.1	3.57 V	153	44.1	2.8
6	5350.00	40.4 AV	54.0	-13.6	3.57 V	153	37.6	2.8
7	5359.00	58.8 PK	74.0	-15.2	3.56 V	150	55.9	2.9
8	5359.00	49.8 AV	54.0	-4.2	3.56 V	150	46.9	2.9
9	#10400.00	52.5 PK	74.0	-21.5	1.48 V	72	40.1	12.4
10	#10400.00	40.3 AV	54.0	-13.7	1.48 V	72	27.9	12.4
11	15600.00	46.6 PK	74.0	-27.4	1.53 V	163	33.4	13.2
12	15600.00	35.4 AV	54.0	-18.6	1.53 V	163	22.2	13.2

**REMARKS:**

1. Emission Level(dBuV/m) = Raw Value(dBuV) + Correction Factor(dB/m)
2. Correction Factor(dB/m) = Antenna Factor(dB/m) + Cable Factor(dB) – Pre-Amplifier Factor(dB)
3. The other emission levels were very low against the limit.
4. Margin value = Emission Level – Limit value
5. " \* ": Fundamental frequency.
6. " # ": The radiated frequency is out of the restricted band.

<b>CHANNEL</b>	TX Channel 48	<b>DETECTOR FUNCTION</b>	Peak (PK)
<b>FREQUENCY RANGE</b>	1GHz ~ 40GHz		Average (AV)

**ANTENNA POLARITY & TEST DISTANCE: HORIZONTAL AT 3 M**

NO.	FREQ. (MHz)	EMISSION LEVEL (dBuV/m)	LIMIT (dBuV/m)	MARGIN (dB)	ANTENNA HEIGHT (m)	TABLE ANGLE (Degree)	RAW VALUE (dBuV)	CORRECTION FACTOR (dB/m)
1	*5240.00	117.6 PK			3.05 H	95	114.9	2.7
2	*5240.00	108.3 AV			3.05 H	95	105.6	2.7
3	5350.00	49.2 PK	74.0	-24.8	3.05 H	95	46.4	2.8
4	5350.00	41.6 AV	54.0	-12.4	3.05 H	95	38.8	2.8
5	5399.00	58.3 PK	74.0	-15.7	3.05 H	95	55.3	3.0
6	5399.00	48.7 AV	54.0	-5.3	3.05 H	95	45.7	3.0
7	#10480.00	50.5 PK	74.0	-23.5	2.00 H	328	37.8	12.7
8	#10480.00	38.3 AV	54.0	-15.7	2.00 H	328	25.6	12.7
9	15720.00	45.7 PK	74.0	-28.3	1.95 H	162	33.4	12.3
10	15720.00	34.3 AV	54.0	-19.7	1.95 H	162	22.0	12.3

**ANTENNA POLARITY & TEST DISTANCE: VERTICAL AT 3 M**

NO.	FREQ. (MHz)	EMISSION LEVEL (dBuV/m)	LIMIT (dBuV/m)	MARGIN (dB)	ANTENNA HEIGHT (m)	TABLE ANGLE (Degree)	RAW VALUE (dBuV)	CORRECTION FACTOR (dB/m)
1	*5240.00	113.6 PK			3.54 V	148	110.9	2.7
2	*5240.00	104.4 AV			3.54 V	148	101.7	2.7
3	5350.00	48.4 PK	74.0	-25.6	3.54 V	148	45.6	2.8
4	5350.00	40.5 AV	54.0	-13.5	3.54 V	148	37.7	2.8
5	5399.00	57.6 PK	74.0	-16.4	3.54 V	148	54.6	3.0
6	5399.00	47.9 AV	54.0	-6.1	3.54 V	148	44.9	3.0
7	#10480.00	51.6 PK	74.0	-22.4	1.46 V	68	38.9	12.7
8	#10480.00	39.4 AV	54.0	-14.6	1.46 V	68	26.7	12.7
9	15720.00	46.4 PK	74.0	-27.6	1.50 V	150	34.1	12.3
10	15720.00	35.2 AV	54.0	-18.8	1.50 V	150	22.9	12.3

**REMARKS:**

1. Emission Level(dBuV/m) = Raw Value(dBuV) + Correction Factor(dB/m)
2. Correction Factor(dB/m) = Antenna Factor(dB/m) + Cable Factor(dB) – Pre-Amplifier Factor(dB)
3. The other emission levels were very low against the limit.
4. Margin value = Emission Level – Limit value
5. " \* ": Fundamental frequency.
6. " # ": The radiated frequency is out of the restricted band.

<b>CHANNEL</b>	TX Channel 149	<b>DETECTOR FUNCTION</b>	Peak (PK)
<b>FREQUENCY RANGE</b>	1GHz ~ 40GHz		Average (AV)

**ANTENNA POLARITY & TEST DISTANCE: HORIZONTAL AT 3 M**

NO.	FREQ. (MHz)	EMISSION LEVEL (dBuV/m)	LIMIT (dBuV/m)	MARGIN (dB)	ANTENNA HEIGHT (m)	TABLE ANGLE (Degree)	RAW VALUE (dBuV)	CORRECTION FACTOR (dB/m)
1	#5578.05	60.0 PK	68.2	-8.2	2.45 H	66	56.8	3.2
2	*5745.00	117.4 PK			2.45 H	66	114.0	3.4
3	*5745.00	107.8 AV			2.45 H	66	104.4	3.4
4	#5981.42	57.2 PK	68.2	-11.0	2.45 H	66	53.5	3.7
5	11490.00	52.6 PK	74.0	-21.4	1.60 H	314	39.9	12.7
6	11490.00	38.9 AV	54.0	-15.1	1.60 H	314	26.2	12.7
7	#17235.00	48.3 PK	74.0	-25.7	1.92 H	265	32.6	15.7
8	#17235.00	36.5 AV	54.0	-17.5	1.92 H	265	20.8	15.7

**ANTENNA POLARITY & TEST DISTANCE: VERTICAL AT 3 M**

NO.	FREQ. (MHz)	EMISSION LEVEL (dBuV/m)	LIMIT (dBuV/m)	MARGIN (dB)	ANTENNA HEIGHT (m)	TABLE ANGLE (Degree)	RAW VALUE (dBuV)	CORRECTION FACTOR (dB/m)
1	#5582.42	55.8 PK	68.2	-12.4	1.00 V	207	52.6	3.2
2	*5745.00	111.3 PK			1.37 V	207	107.9	3.4
3	*5745.00	101.3 AV			1.37 V	207	97.9	3.4
4	#5977.38	54.6 PK	68.2	-13.6	1.37 V	207	50.9	3.7
5	11490.00	52.2 PK	74.0	-21.8	1.53 V	72	39.5	12.7
6	11490.00	39.5 AV	54.0	-14.5	1.53 V	72	26.8	12.7
7	#17235.00	48.9 PK	74.0	-25.1	1.41 V	125	33.2	15.7
8	#17235.00	36.7 AV	54.0	-17.3	1.41 V	125	21.0	15.7

**REMARKS:**

1. Emission Level(dBuV/m) = Raw Value(dBuV) + Correction Factor(dB/m)
2. Correction Factor(dB/m) = Antenna Factor(dB/m) + Cable Factor(dB) – Pre-Amplifier Factor(dB)
3. The other emission levels were very low against the limit.
4. Margin value = Emission Level – Limit value
5. " \* ": Fundamental frequency.
6. " # ": The radiated frequency is out of the restricted band.

<b>CHANNEL</b>	TX Channel 157	<b>DETECTOR FUNCTION</b>	Peak (PK)
<b>FREQUENCY RANGE</b>	1GHz ~ 40GHz		Average (AV)

**ANTENNA POLARITY & TEST DISTANCE: HORIZONTAL AT 3 M**

NO.	FREQ. (MHz)	EMISSION LEVEL (dBuV/m)	LIMIT (dBuV/m)	MARGIN (dB)	ANTENNA HEIGHT (m)	TABLE ANGLE (Degree)	RAW VALUE (dBuV)	CORRECTION FACTOR (dB/m)
1	#5624.11	62.2 PK	68.2	-6.0	2.47 H	60	58.9	3.3
2	*5785.00	120.6 PK			2.47 H	60	117.0	3.6
3	*5785.00	110.0 AV			2.47 H	60	106.4	3.6
4	#5945.78	60.5 PK	68.2	-7.7	2.47 H	60	56.8	3.7
5	11570.00	49.9 PK	74.0	-24.1	1.66 H	315	37.0	12.9
6	11570.00	38.9 AV	54.0	-15.1	1.66 H	315	26.0	12.9
7	#17355.00	49.6 PK	74.0	-24.4	1.87 H	278	33.1	16.5
8	#17355.00	37.1 AV	54.0	-16.9	1.87 H	278	20.6	16.5

**ANTENNA POLARITY & TEST DISTANCE: VERTICAL AT 3 M**

NO.	FREQ. (MHz)	EMISSION LEVEL (dBuV/m)	LIMIT (dBuV/m)	MARGIN (dB)	ANTENNA HEIGHT (m)	TABLE ANGLE (Degree)	RAW VALUE (dBuV)	CORRECTION FACTOR (dB/m)
1	#5617.24	56.4 PK	68.2	-11.8	1.33 V	177	53.1	3.3
2	*5785.00	112.6 PK			1.33 V	177	109.0	3.6
3	*5785.00	101.9 AV			1.33 V	177	98.3	3.6
4	#5937.28	56.1 PK	68.2	-12.1	1.33 V	177	52.3	3.8
5	11570.00	52.5 PK	74.0	-21.5	1.41 V	59	39.6	12.9
6	11570.00	40.4 AV	54.0	-13.6	1.41 V	59	27.5	12.9
7	#17355.00	49.9 PK	74.0	-24.1	1.47 V	147	33.4	16.5
8	#17355.00	38.0 AV	54.0	-16.0	1.47 V	147	21.5	16.5

**REMARKS:**

1. Emission Level(dBuV/m) = Raw Value(dBuV) + Correction Factor(dB/m)
2. Correction Factor(dB/m) = Antenna Factor(dB/m) + Cable Factor(dB) – Pre-Amplifier Factor(dB)
3. The other emission levels were very low against the limit.
4. Margin value = Emission Level – Limit value
5. " \* ": Fundamental frequency.
6. " # ": The radiated frequency is out of the restricted band.

<b>CHANNEL</b>	TX Channel 165	<b>DETECTOR FUNCTION</b>	Peak (PK)
<b>FREQUENCY RANGE</b>	1GHz ~ 40GHz		Average (AV)

**ANTENNA POLARITY & TEST DISTANCE: HORIZONTAL AT 3 M**

NO.	FREQ. (MHz)	EMISSION LEVEL (dBuV/m)	LIMIT (dBuV/m)	MARGIN (dB)	ANTENNA HEIGHT (m)	TABLE ANGLE (Degree)	RAW VALUE (dBuV)	CORRECTION FACTOR (dB/m)
1	#5578.78	60.0 PK	68.2	-8.2	2.47 H	59	56.8	3.2
2	*5825.00	119.9 PK			2.47 H	59	116.2	3.7
3	*5825.00	109.6 AV			2.47 H	59	105.9	3.7
4	#5946.53	60.0 PK	68.2	-8.2	2.47 H	59	56.3	3.7
5	11650.00	49.9 PK	74.0	-24.1	1.68 H	315	37.0	12.9
6	11650.00	39.2 AV	54.0	-14.8	1.68 H	315	26.3	12.9
7	#17475.00	49.6 PK	74.0	-24.4	1.86 H	276	31.7	17.9
8	#17475.00	37.2 AV	54.0	-16.8	1.86 H	276	19.3	17.9

**ANTENNA POLARITY & TEST DISTANCE: VERTICAL AT 3 M**

NO.	FREQ. (MHz)	EMISSION LEVEL (dBuV/m)	LIMIT (dBuV/m)	MARGIN (dB)	ANTENNA HEIGHT (m)	TABLE ANGLE (Degree)	RAW VALUE (dBuV)	CORRECTION FACTOR (dB/m)
1	#5585.81	57.1 PK	68.2	-11.1	1.30 V	164	53.9	3.2
2	*5825.00	113.3 PK			1.30 V	164	109.6	3.7
3	*5825.00	103.1 AV			1.30 V	164	99.4	3.7
4	#5983.01	57.8 PK	68.2	-10.4	1.30 V	164	54.1	3.7
5	11650.00	52.8 PK	74.0	-21.2	1.41 V	75	39.9	12.9
6	11650.00	40.8 AV	54.0	-13.2	1.41 V	75	27.9	12.9
7	#17475.00	50.3 PK	74.0	-23.7	1.44 V	128	32.4	17.9
8	#17475.00	38.1 AV	54.0	-15.9	1.44 V	128	20.2	17.9

**REMARKS:**

1. Emission Level(dBuV/m) = Raw Value(dBuV) + Correction Factor(dB/m)
2. Correction Factor(dB/m) = Antenna Factor(dB/m) + Cable Factor(dB) – Pre-Amplifier Factor(dB)
3. The other emission levels were very low against the limit.
4. Margin value = Emission Level – Limit value
5. " \* ": Fundamental frequency.
6. " # ": The radiated frequency is out of the restricted band.



802.11ac (VHT40)

<b>CHANNEL</b>	TX Channel 38	<b>DETECTOR FUNCTION</b>	Peak (PK)
<b>FREQUENCY RANGE</b>	1GHz ~ 40GHz		Average (AV)

ANTENNA POLARITY & TEST DISTANCE: HORIZONTAL AT 3 M								
NO.	FREQ. (MHz)	EMISSION LEVEL (dBuV/m)	LIMIT (dBuV/m)	MARGIN (dB)	ANTENNA HEIGHT (m)	TABLE ANGLE (Degree)	RAW VALUE (dBuV)	CORRECTION FACTOR (dB/m)
1	5150.00	68.3 PK	74.0	-5.7	2.78 H	64	65.3	3.0
2	<b>5150.00</b>	<b>53.9 AV</b>	<b>54.0</b>	<b>-0.1</b>	<b>2.78 H</b>	<b>64</b>	<b>50.9</b>	<b>3.0</b>
3	*5190.00	110.6 PK			2.78 H	64	107.6	3.0
4	*5190.00	100.0 AV			2.78 H	64	97.0	3.0
5	5350.00	52.3 PK	74.0	-21.7	2.78 H	64	49.5	2.8
6	5350.00	42.0 AV	54.0	-12.0	2.78 H	64	39.2	2.8
7	#10380.00	52.8 PK	74.0	-21.2	1.64 H	299	40.6	12.2
8	#10380.00	39.0 AV	54.0	-15.0	1.64 H	299	26.8	12.2
9	15570.00	48.6 PK	74.0	-25.4	1.88 H	253	35.7	12.9
10	15570.00	37.0 AV	54.0	-17.0	1.88 H	253	24.1	12.9

ANTENNA POLARITY & TEST DISTANCE: VERTICAL AT 3 M								
NO.	FREQ. (MHz)	EMISSION LEVEL (dBuV/m)	LIMIT (dBuV/m)	MARGIN (dB)	ANTENNA HEIGHT (m)	TABLE ANGLE (Degree)	RAW VALUE (dBuV)	CORRECTION FACTOR (dB/m)
1	5150.00	65.7 PK	74.0	-8.3	1.32 V	210	62.7	3.0
2	5150.00	50.8 AV	54.0	-3.2	1.32 V	210	47.8	3.0
3	*5190.00	106.4 PK			1.32 V	210	103.4	3.0
4	*5190.00	96.1 AV			1.32 V	210	93.1	3.0
5	5350.00	51.9 PK	74.0	-22.1	1.32 V	210	49.1	2.8
6	5350.00	41.5 AV	54.0	-12.5	1.32 V	210	38.7	2.8
7	#10380.00	52.5 PK	74.0	-21.5	1.54 V	69	40.3	12.2
8	#10380.00	39.5 AV	54.0	-14.5	1.54 V	69	27.3	12.2
9	15570.00	48.8 PK	74.0	-25.2	1.35 V	141	35.9	12.9
10	15570.00	36.5 AV	54.0	-17.5	1.35 V	141	23.6	12.9

**REMARKS:**

1. Emission Level(dBuV/m) = Raw Value(dBuV) + Correction Factor(dB/m)
2. Correction Factor(dB/m) = Antenna Factor(dB/m) + Cable Factor(dB) – Pre-Amplifier Factor(dB)
3. The other emission levels were very low against the limit.
4. Margin value = Emission Level – Limit value
5. " \* ": Fundamental frequency.
6. " # ": The radiated frequency is out of the restricted band.

<b>CHANNEL</b>	TX Channel 46	<b>DETECTOR FUNCTION</b>	Peak (PK)
<b>FREQUENCY RANGE</b>	1GHz ~ 40GHz		Average (AV)

**ANTENNA POLARITY & TEST DISTANCE: HORIZONTAL AT 3 M**

NO.	FREQ. (MHz)	EMISSION LEVEL (dBuV/m)	LIMIT (dBuV/m)	MARGIN (dB)	ANTENNA HEIGHT (m)	TABLE ANGLE (Degree)	RAW VALUE (dBuV)	CORRECTION FACTOR (dB/m)
1	*5230.00	113.8 PK			2.69 H	67	111.1	2.7
2	*5230.00	102.4 AV			2.69 H	67	99.7	2.7
3	5350.00	48.6 PK	74.0	-25.4	2.69 H	67	45.8	2.8
4	5350.00	40.2 AV	54.0	-13.8	2.69 H	67	37.4	2.8
5	5383.00	57.2 PK	74.0	-16.8	2.69 H	67	54.3	2.9
6	5383.00	46.9 AV	54.0	-7.1	2.69 H	67	44.0	2.9
7	#10460.00	53.1 PK	74.0	-20.9	1.57 H	298	40.5	12.6
8	#10460.00	39.4 AV	54.0	-14.6	1.57 H	298	26.8	12.6
9	15690.00	48.4 PK	74.0	-25.6	1.93 H	258	35.8	12.6
10	15690.00	36.6 AV	54.0	-17.4	1.93 H	258	24.0	12.6

**ANTENNA POLARITY & TEST DISTANCE: VERTICAL AT 3 M**

NO.	FREQ. (MHz)	EMISSION LEVEL (dBuV/m)	LIMIT (dBuV/m)	MARGIN (dB)	ANTENNA HEIGHT (m)	TABLE ANGLE (Degree)	RAW VALUE (dBuV)	CORRECTION FACTOR (dB/m)
1	*5230.00	110.5 PK			1.34 V	197	107.8	2.7
2	*5230.00	98.5 AV			1.34 V	197	95.8	2.7
3	5350.00	66.4 PK	74.0	-7.6	1.34 V	197	63.6	2.8
4	5350.00	51.2 AV	54.0	-2.8	1.34 V	197	48.4	2.8
5	5383.00	52.3 PK	74.0	-21.7	1.34 V	197	49.4	2.9
6	5383.00	42.1 AV	54.0	-11.9	1.34 V	197	39.2	2.9
7	#10460.00	51.7 PK	74.0	-22.3	1.52 V	61	39.1	12.6
8	#10460.00	39.1 AV	54.0	-14.9	1.52 V	61	26.5	12.6
9	15690.00	48.7 PK	74.0	-25.3	1.41 V	131	36.1	12.6
10	15690.00	36.5 AV	54.0	-17.5	1.41 V	131	23.9	12.6

**REMARKS:**

- Emission Level(dBuV/m) = Raw Value(dBuV) + Correction Factor(dB/m)
- Correction Factor(dB/m) = Antenna Factor(dB/m) + Cable Factor(dB) – Pre-Amplifier Factor(dB)
- The other emission levels were very low against the limit.
- Margin value = Emission Level – Limit value
- " \* ": Fundamental frequency.
- " # ": The radiated frequency is out of the restricted band.

<b>CHANNEL</b>	TX Channel 151	<b>DETECTOR FUNCTION</b>	Peak (PK)
<b>FREQUENCY RANGE</b>	1GHz ~ 40GHz		Average (AV)

**ANTENNA POLARITY & TEST DISTANCE: HORIZONTAL AT 3 M**

NO.	FREQ. (MHz)	EMISSION LEVEL (dBuV/m)	LIMIT (dBuV/m)	MARGIN (dB)	ANTENNA HEIGHT (m)	TABLE ANGLE (Degree)	RAW VALUE (dBuV)	CORRECTION FACTOR (dB/m)
1	#5636.30	63.2 PK	68.2	-5.0	2.44 H	120	60.0	3.2
2	*5755.00	114.3 PK			2.44 H	120	110.8	3.5
3	*5755.00	103.8 AV			2.44 H	120	100.3	3.5
4	#5930.87	58.7 PK	68.2	-9.5	2.44 H	120	54.9	3.8
5	11510.00	50.0 PK	74.0	-24.0	1.67 H	326	37.3	12.7
6	11510.00	38.8 AV	54.0	-15.2	1.67 H	326	26.1	12.7
7	#17265.00	48.9 PK	74.0	-25.1	1.85 H	277	33.1	15.8
8	#17265.00	36.7 AV	54.0	-17.3	1.85 H	277	20.9	15.8

**ANTENNA POLARITY & TEST DISTANCE: VERTICAL AT 3 M**

NO.	FREQ. (MHz)	EMISSION LEVEL (dBuV/m)	LIMIT (dBuV/m)	MARGIN (dB)	ANTENNA HEIGHT (m)	TABLE ANGLE (Degree)	RAW VALUE (dBuV)	CORRECTION FACTOR (dB/m)
1	#5629.82	57.3 PK	68.2	-10.9	1.23 V	152	54.0	3.3
2	*5755.00	110.9 PK			1.23 V	152	107.4	3.5
3	*5755.00	99.2 AV			1.23 V	152	95.7	3.5
4	#5926.97	55.2 PK	68.2	-13.0	1.23 V	152	51.4	3.8
5	11510.00	52.9 PK	74.0	-21.1	1.36 V	64	40.2	12.7
6	11510.00	40.9 AV	54.0	-13.1	1.36 V	64	28.2	12.7
7	#17265.00	49.9 PK	74.0	-24.1	1.45 V	132	34.1	15.8
8	#17265.00	37.9 AV	54.0	-16.1	1.45 V	132	22.1	15.8

**REMARKS:**

1. Emission Level(dBuV/m) = Raw Value(dBuV) + Correction Factor(dB/m)
2. Correction Factor(dB/m) = Antenna Factor(dB/m) + Cable Factor(dB) – Pre-Amplifier Factor(dB)
3. The other emission levels were very low against the limit.
4. Margin value = Emission Level – Limit value
5. " \* ": Fundamental frequency.
6. " # ": The radiated frequency is out of the restricted band.

<b>CHANNEL</b>	TX Channel 159	<b>DETECTOR FUNCTION</b>	Peak (PK)
<b>FREQUENCY RANGE</b>	1GHz ~ 40GHz		Average (AV)

**ANTENNA POLARITY & TEST DISTANCE: HORIZONTAL AT 3 M**

NO.	FREQ. (MHz)	EMISSION LEVEL (dBuV/m)	LIMIT (dBuV/m)	MARGIN (dB)	ANTENNA HEIGHT (m)	TABLE ANGLE (Degree)	RAW VALUE (dBuV)	CORRECTION FACTOR (dB/m)
1	#5639.09	62.5 PK	68.2	-5.7	2.60 H	56	59.3	3.2
2	*5795.00	115.8 PK			2.60 H	56	112.3	3.5
3	*5795.00	105.8 AV			2.60 H	56	102.3	3.5
4	#5930.32	61.5 PK	68.2	-6.7	2.60 H	56	57.7	3.8
5	11590.00	49.7 PK	74.0	-24.3	1.71 H	310	36.7	13.0
6	11590.00	38.5 AV	54.0	-15.5	1.71 H	310	25.5	13.0
7	#17385.00	49.3 PK	74.0	-24.7	1.86 H	263	32.6	16.7
8	#17385.00	36.8 AV	54.0	-17.2	1.86 H	263	20.1	16.7

**ANTENNA POLARITY & TEST DISTANCE: VERTICAL AT 3 M**

NO.	FREQ. (MHz)	EMISSION LEVEL (dBuV/m)	LIMIT (dBuV/m)	MARGIN (dB)	ANTENNA HEIGHT (m)	TABLE ANGLE (Degree)	RAW VALUE (dBuV)	CORRECTION FACTOR (dB/m)
1	#5627.75	57.5 PK	68.2	-10.7	1.12 V	151	54.2	3.3
2	*5795.00	111.5 PK			1.12 V	151	108.0	3.5
3	*5795.00	99.3 AV			1.12 V	151	95.8	3.5
4	#5961.97	55.1 PK	68.2	-13.1	1.12 V	151	51.3	3.8
5	11590.00	52.4 PK	74.0	-21.6	1.36 V	57	39.4	13.0
6	11590.00	40.2 AV	54.0	-13.8	1.36 V	57	27.2	13.0
7	#17385.00	50.6 PK	74.0	-23.4	1.51 V	148	33.9	16.7
8	#17385.00	38.5 AV	54.0	-15.5	1.51 V	148	21.8	16.7

**REMARKS:**

1. Emission Level(dBuV/m) = Raw Value(dBuV) + Correction Factor(dB/m)
2. Correction Factor(dB/m) = Antenna Factor(dB/m) + Cable Factor(dB) – Pre-Amplifier Factor(dB)
3. The other emission levels were very low against the limit.
4. Margin value = Emission Level – Limit value
5. " \* ": Fundamental frequency.
6. " # ": The radiated frequency is out of the restricted band.

**802.11ac (VHT80)**

<b>CHANNEL</b>	TX Channel 42	<b>DETECTOR FUNCTION</b>	Peak (PK)
<b>FREQUENCY RANGE</b>	1GHz ~ 40GHz		Average (AV)

**ANTENNA POLARITY & TEST DISTANCE: HORIZONTAL AT 3 M**

NO.	FREQ. (MHz)	EMISSION LEVEL (dBuV/m)	LIMIT (dBuV/m)	MARGIN (dB)	ANTENNA HEIGHT (m)	TABLE ANGLE (Degree)	RAW VALUE (dBuV)	CORRECTION FACTOR (dB/m)
1	5150.00	63.3 PK	74.0	-10.7	3.09 H	65	60.3	3.0
2	5150.00	53.8 AV	54.0	-0.2	3.09 H	65	50.8	3.0
3	*5210.00	103.7 PK			3.09 H	65	100.8	2.9
4	*5210.00	95.4 AV			3.09 H	65	92.5	2.9
5	5350.00	54.3 PK	74.0	-19.7	3.09 H	65	51.5	2.8
6	5350.00	45.1 AV	54.0	-8.9	3.09 H	65	42.3	2.8
7	#10420.00	47.1 PK	74.0	-26.9	1.67 H	303	34.6	12.5
8	#10420.00	35.6 AV	54.0	-18.4	1.67 H	303	23.1	12.5
9	15630.00	45.3 PK	74.0	-28.7	1.89 H	248	32.3	13.0
10	15630.00	33.6 AV	54.0	-20.4	1.89 H	248	20.6	13.0

**ANTENNA POLARITY & TEST DISTANCE: VERTICAL AT 3 M**

NO.	FREQ. (MHz)	EMISSION LEVEL (dBuV/m)	LIMIT (dBuV/m)	MARGIN (dB)	ANTENNA HEIGHT (m)	TABLE ANGLE (Degree)	RAW VALUE (dBuV)	CORRECTION FACTOR (dB/m)
1	5150.00	64.2 PK	74.0	-9.8	1.29 V	215	61.2	3.0
2	5150.00	49.5 AV	54.0	-4.5	1.29 V	215	46.5	3.0
3	*5210.00	98.5 PK			1.29 V	215	95.6	2.9
4	*5210.00	91.1 AV			1.29 V	215	88.2	2.9
5	5350.00	55.8 PK	74.0	-18.2	1.29 V	215	53.0	2.8
6	5350.00	40.7 AV	54.0	-13.3	1.29 V	215	37.9	2.8
7	#10420.00	49.5 PK	74.0	-24.5	1.49 V	55	37.0	12.5
8	#10420.00	37.3 AV	54.0	-16.7	1.49 V	55	24.8	12.5
9	15630.00	46.1 PK	74.0	-27.9	1.32 V	153	33.1	13.0
10	15630.00	34.5 AV	54.0	-19.5	1.32 V	153	21.5	13.0

**REMARKS:**

- Emission Level(dBuV/m) = Raw Value(dBuV) + Correction Factor(dB/m)
- Correction Factor(dB/m) = Antenna Factor(dB/m) + Cable Factor(dB) – Pre-Amplifier Factor(dB)
- The other emission levels were very low against the limit.
- Margin value = Emission Level – Limit value
- " \* ": Fundamental frequency.
- " # ": The radiated frequency is out of the restricted band.

<b>CHANNEL</b>	TX Channel 155	<b>DETECTOR FUNCTION</b>	Peak (PK)
<b>FREQUENCY RANGE</b>	1GHz ~ 40GHz		Average (AV)

**ANTENNA POLARITY & TEST DISTANCE: HORIZONTAL AT 3 M**

NO.	FREQ. (MHz)	EMISSION LEVEL (dBuV/m)	LIMIT (dBuV/m)	MARGIN (dB)	ANTENNA HEIGHT (m)	TABLE ANGLE (Degree)	RAW VALUE (dBuV)	CORRECTION FACTOR (dB/m)
1	#5619.17	66.8 PK	68.2	-1.4	2.72 H	54	63.5	3.3
2	*5775.00	109.9 PK			2.72 H	54	106.4	3.5
3	*5775.00	101.4 AV			2.72 H	54	97.9	3.5
4	#5946.22	63.7 PK	68.2	-4.5	2.72 H	54	60.0	3.7
5	11550.00	49.2 PK	74.0	-24.8	1.62 H	313	36.3	12.9
6	11550.00	37.8 AV	54.0	-16.2	1.62 H	313	24.9	12.9
7	#17325.00	47.6 PK	74.0	-26.4	1.92 H	266	31.5	16.1
8	#17325.00	35.4 AV	54.0	-18.6	1.92 H	266	19.3	16.1

**ANTENNA POLARITY & TEST DISTANCE: VERTICAL AT 3 M**

NO.	FREQ. (MHz)	EMISSION LEVEL (dBuV/m)	LIMIT (dBuV/m)	MARGIN (dB)	ANTENNA HEIGHT (m)	TABLE ANGLE (Degree)	RAW VALUE (dBuV)	CORRECTION FACTOR (dB/m)
1	#5636.24	62.7 PK	68.2	-5.5	1.06 V	143	59.5	3.2
2	*5775.00	105.9 PK			1.06 V	143	102.4	3.5
3	*5775.00	97.2 AV			1.06 V	143	93.7	3.5
4	#5927.78	58.4 PK	68.2	-9.8	1.06 V	143	54.6	3.8
5	11550.00	51.2 PK	74.0	-22.8	1.31 V	52	38.3	12.9
6	11550.00	39.1 AV	54.0	-14.9	1.31 V	52	26.2	12.9
7	#17325.00	48.2 PK	74.0	-25.8	1.44 V	129	32.1	16.1
8	#17325.00	36.8 AV	54.0	-17.2	1.44 V	129	20.7	16.1

**REMARKS:**

1. Emission Level(dBuV/m) = Raw Value(dBuV) + Correction Factor(dB/m)
2. Correction Factor(dB/m) = Antenna Factor(dB/m) + Cable Factor(dB) – Pre-Amplifier Factor(dB)
3. The other emission levels were very low against the limit.
4. Margin value = Emission Level – Limit value
5. " \* ": Fundamental frequency.
6. " # ": The radiated frequency is out of the restricted band.

**Below 1GHz Data:**

**802.11ac (VHT40)**

<b>CHANNEL</b>	TX Channel 159	<b>DETECTOR FUNCTION</b>	Quasi-Peak (QP)
<b>FREQUENCY RANGE</b>	9kHz ~ 1GHz		

**ANTENNA POLARITY & TEST DISTANCE: HORIZONTAL AT 3 M**

NO.	FREQ. (MHz)	EMISSION LEVEL (dBuV/m)	LIMIT (dBuV/m)	MARGIN (dB)	ANTENNA HEIGHT (m)	TABLE ANGLE (Degree)	RAW VALUE (dBuV)	CORRECTION FACTOR (dB/m)
1	125.05	37.6 QP	43.5	-5.9	2.89 H	253	46.9	-9.3
2	249.22	39.3 QP	46.0	-6.7	3.00 H	143	48.3	-9.0
3	375.32	36.6 QP	46.0	-9.4	2.00 H	287	41.6	-5.0
4	625.58	39.5 QP	46.0	-6.5	1.49 H	211	38.6	0.9
5	749.74	39.9 QP	46.0	-6.1	1.45 H	266	36.6	3.3
6	875.84	39.6 QP	46.0	-6.4	1.00 H	26	35.1	4.5

**ANTENNA POLARITY & TEST DISTANCE: VERTICAL AT 3 M**

NO.	FREQ. (MHz)	EMISSION LEVEL (dBuV/m)	LIMIT (dBuV/m)	MARGIN (dB)	ANTENNA HEIGHT (m)	TABLE ANGLE (Degree)	RAW VALUE (dBuV)	CORRECTION FACTOR (dB/m)
1	73.08	35.4 QP	40.0	-4.6	1.00 V	315	46.2	-10.8
2	125.00	39.6 QP	43.5	-3.9	1.00 V	244	48.9	-9.3
3	250.19	36.9 QP	46.0	-9.1	1.00 V	302	45.8	-8.9
4	399.57	34.5 QP	46.0	-11.5	1.00 V	189	39.0	-4.5
5	624.56	36.8 QP	46.0	-9.2	1.50 V	297	35.9	0.9
6	749.75	35.7 QP	46.0	-10.3	1.00 V	143	32.4	3.3

**REMARKS:**

1. Emission Level(dBuV/m) = Raw Value(dBuV) + Correction Factor(dB/m)
2. Correction Factor(dB/m) = Antenna Factor(dB/m) + Cable Factor(dB) – Pre-Amplifier Factor(dB)
3. The other emission levels were very low against the limit.
4. Margin value = Emission Level – Limit value

## 4.2 Conducted Emission Measurement

### 4.2.1 Limits of Conducted Emission Measurement

Frequency (MHz)	Conducted Limit (dBuV)	
	Quasi-peak	Average
0.15 - 0.5	66 - 56	56 - 46
0.50 - 5.0	56	46
5.0 - 30.0	60	50

Note: 1. The lower limit shall apply at the transition frequencies.

2. The limit decreases in line with the logarithm of the frequency in the range of 0.15 to 0.50MHz.

### 4.2.2 Test Instruments

DESCRIPTION & MANUFACTURER	MODEL NO.	SERIAL NO.	CALIBRATED DATE	CALIBRATED UNTIL
Test Receiver R&S	ESCS 30	847124/029	Nov. 01, 2017	Oct. 31, 2018
Line-Impedance Stabilization Network (for EUT) R&S	ESH3-Z5	848773/004	Nov. 15, 2017	Nov. 14, 2018
Line-Impedance Stabilization Network (for Peripheral) R&S	ENV216	100072	June 03, 2017	June 02, 2018
50 ohms Terminator	N/A	EMC-02	Sep. 22, 2017	Sep. 21, 2018
RF Cable	5D-FB	COCCAB-001	Sep. 29, 2017	Sep. 28, 2018
Fixed attenuator EMEC	STI02-2200-10	003	Mar. 16, 2018	Mar. 15, 2019
Software BVADT	BVADT_Cond_ V7.3.7.4	NA	NA	NA

**Note:**

1. The calibration interval of the above test instruments are 12 months and the calibrations are traceable to NML/ROC and NIST/USA.
2. The test was performed in Conduction 1.
3. Tested Date: May 26 to 29, 2018



#### 4.2.3 Test Procedure

- The EUT was placed 0.4 meters from the conducting wall of the shielded room with EUT being connected to the power mains through a line impedance stabilization network (LISN). Other support units were connected to the power mains through another LISN. The two LISNs provide 50 ohm/ 50uH of coupling impedance for the measuring instrument.
- Both lines of the power mains connected to the EUT were checked for maximum conducted interference.
- The frequency range from 150kHz to 30MHz was searched. Emission levels under (Limit - 20dB) was not recorded.

**NOTE:** All modes of operation were investigated and the worst-case emissions are reported.

#### 4.2.4 Deviation from Test Standard

No deviation.

#### 4.2.5 Test Setup

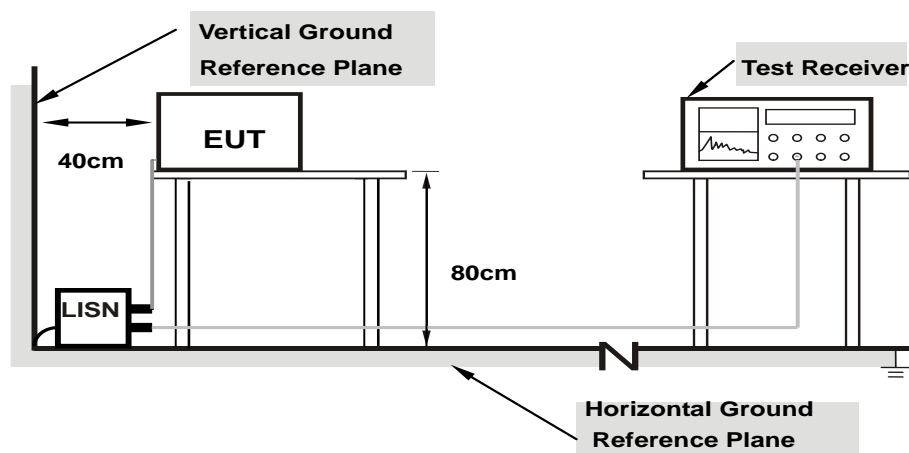

**Note: 1.Support units were connected to second LISN.**

For the actual test configuration, please refer to the attached file (Test Setup Photo).

#### 4.2.6 EUT Operating Condition

Same as 4.1.6.

#### 4.2.7 Test Results (Mode 1)

Phase	Line (L)	Detector Function	Quasi-Peak (QP) / Average (AV)
-------	----------	-------------------	--------------------------------

No	Freq. [MHz]	Corr.	Reading Value		Emission Level		Limit		Margin	
		Factor (dB)	[dB (uV)]		[dB (uV)]		[dB (uV)]		(dB)	
			Q.P.	AV.	Q.P.	AV.	Q.P.	AV.	Q.P.	AV.
1	0.15000	10.05	32.06	18.76	42.11	28.81	66.00	56.00	-23.89	-27.19
2	0.16172	10.05	28.56	13.01	38.61	23.06	65.38	55.38	-26.77	-32.32
3	0.23594	10.08	27.33	22.69	37.41	32.77	62.24	52.24	-24.83	-19.47
4	5.41016	10.43	14.09	7.69	24.52	18.12	60.00	50.00	-35.48	-31.88
5	8.70703	10.63	21.21	15.62	31.84	26.25	60.00	50.00	-28.16	-23.75
6	29.91797	11.61	21.78	14.68	33.39	26.29	60.00	50.00	-26.61	-23.71

#### REMARKS:

1. Q.P. and AV. are abbreviations of quasi-peak and average individually.
2. The emission levels of other frequencies were very low against the limit.
3. Margin value = Emission level - Limit value
4. Correction factor = Insertion loss + Cable loss
5. Emission Level = Correction Factor + Reading Value.

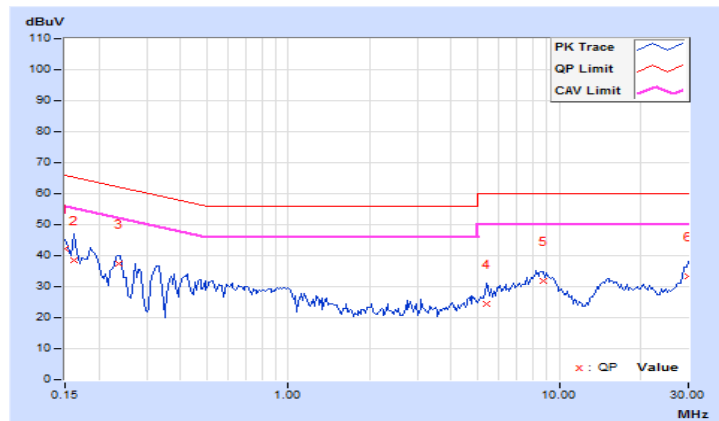

Phase	Neutral (N)	Detector Function	Quasi-Peak (QP) / Average (AV)
-------	-------------	-------------------	--------------------------------

No	Freq. [MHz]	Corr. Factor	Reading Value [dB (uV)]		Emission Level [dB (uV)]		Limit [dB (uV)]		Margin (dB)	
		(dB)	Q.P.	AV.	Q.P.	AV.	Q.P.	AV.	Q.P.	AV.
	1	0.15000	9.95	32.63	18.89	42.58	28.84	66.00	56.00	-23.42
2	0.22031	9.98	22.79	6.37	32.77	16.35	62.81	52.81	-30.04	-36.46
3	0.28313	9.99	25.05	17.27	35.04	27.26	60.72	50.72	-25.68	-23.46
4	2.94531	10.14	15.04	5.71	25.18	15.85	56.00	46.00	-30.82	-30.15
5	8.73047	10.47	20.02	14.50	30.49	24.97	60.00	50.00	-29.51	-25.03
6	29.90625	11.32	20.59	13.04	31.91	24.36	60.00	50.00	-28.09	-25.64

#### REMARKS:

1. Q.P. and AV. are abbreviations of quasi-peak and average individually.
2. The emission levels of other frequencies were very low against the limit.
3. Margin value = Emission level - Limit value
4. Correction factor = Insertion loss + Cable loss
5. Emission Level = Correction Factor + Reading Value.

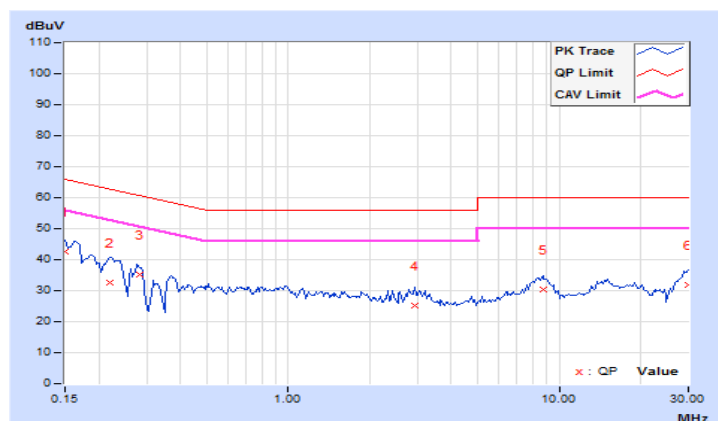

#### 4.2.8 Test Results (Mode 2)

Phase	Line (L)	Detector Function	Quasi-Peak (QP) / Average (AV)
-------	----------	-------------------	--------------------------------

No	Freq.	Corr.	Reading Value		Emission Level		Limit		Margin	
	[MHz]	Factor	[dB (uV)]		[dB (uV)]		[dB (uV)]		(dB)	
		(dB)	Q.P.	AV.	Q.P.	AV.	Q.P.	AV.	Q.P.	AV.
1	0.15000	10.05	35.95	15.36	46.00	25.41	66.00	56.00	-20.00	-30.59
<b>2</b>	<b>0.16172</b>	<b>10.05</b>	<b>40.43</b>	<b>26.65</b>	<b>50.48</b>	<b>36.70</b>	<b>65.38</b>	<b>55.38</b>	<b>-14.90</b>	<b>-18.68</b>
3	0.20859	10.07	34.85	18.97	44.92	29.04	63.26	53.26	-18.34	-24.22
4	3.12500	10.29	21.19	11.91	31.48	22.20	56.00	46.00	-24.52	-23.80
5	13.22656	10.94	19.72	14.38	30.66	25.32	60.00	50.00	-29.34	-24.68
6	21.83594	11.42	15.63	10.73	27.05	22.15	60.00	50.00	-32.95	-27.85

#### REMARKS:

1. Q.P. and AV. are abbreviations of quasi-peak and average individually.
2. The emission levels of other frequencies were very low against the limit.
3. Margin value = Emission level - Limit value
4. Correction factor = Insertion loss + Cable loss
5. Emission Level = Correction Factor + Reading Value.

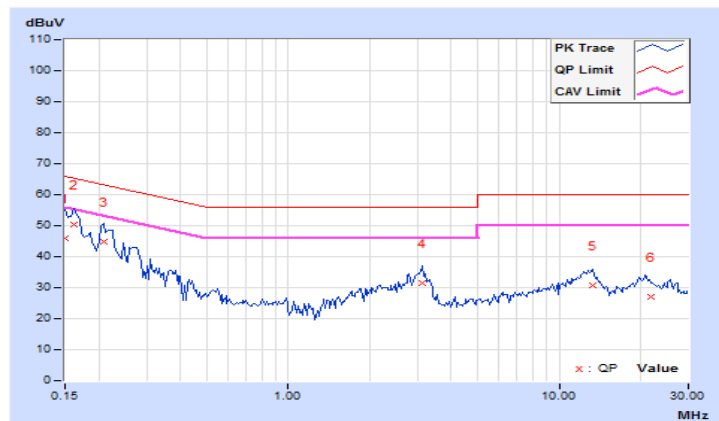

Phase	Neutral (N)	Detector Function	Quasi-Peak (QP) / Average (AV)
-------	-------------	-------------------	--------------------------------

No	Freq. [MHz]	Corr. Factor	Reading Value [dB (uV)]		Emission Level [dB (uV)]		Limit [dB (uV)]		Margin (dB)	
		(dB)	Q.P.	AV.	Q.P.	AV.	Q.P.	AV.	Q.P.	AV.
	1	0.16172	9.96	40.15	26.93	50.11	36.89	65.38	55.38	-15.27
2	0.20469	9.97	32.64	13.21	42.61	23.18	63.42	53.42	-20.81	-30.24
3	0.27891	9.99	26.99	13.45	36.98	23.44	60.85	50.85	-23.87	-27.41
4	0.40391	10.02	15.63	0.14	25.65	10.16	57.77	47.77	-32.12	-37.61
5	3.10938	10.15	19.69	10.53	29.84	20.68	56.00	46.00	-26.16	-25.32
6	13.55078	10.77	20.20	15.87	30.97	26.64	60.00	50.00	-29.03	-23.36

**REMARKS:**

1. Q.P. and AV. are abbreviations of quasi-peak and average individually.
2. The emission levels of other frequencies were very low against the limit.
3. Margin value = Emission level - Limit value
4. Correction factor = Insertion loss + Cable loss
5. Emission Level = Correction Factor + Reading Value.

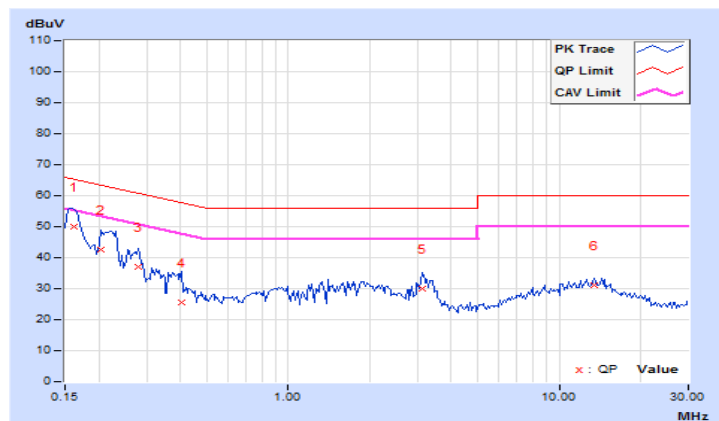

### 4.3 Transmit Power Measurement

#### 4.3.1 Limits of Transmit Power Measurement

Operation Band	EUT Category		Limit
U-NII-1		Outdoor Access Point	1 Watt (30 dBm) (Max. e.i.r.p $\leq$ 125mW(21 dBm) at any elevation angle above 30 degrees as measured from the horizon)
		Fixed point-to-point Access Point	1 Watt (30 dBm)
	√	Indoor Access Point	1 Watt (30 dBm)
		Client device	250mW (24 dBm)
U-NII-2A			250mW (24 dBm) or 11 dBm+10 log B*
U-NII-2C			250mW (24 dBm) or 11 dBm+10 log B*
U-NII-3		√	1 Watt (30 dBm)

\*B is the 26 dB emission bandwidth in megahertz

Per KDB 662911 Method of conducted output power measurement on IEEE 802.11 devices,

Array Gain = 0 dB (i.e., no array gain) for  $N_{ANT} \leq 4$ ;

Array Gain = 0 dB (i.e., no array gain) for channel widths  $\geq 40$  MHz for any  $N_{ANT}$ ;

Array Gain =  $5 \log(N_{ANT}/N_{SS})$  dB or 3 dB, whichever is less for 20-MHz channel widths with  $N_{ANT} \geq 5$ .

For power measurements on all other devices: Array Gain =  $10 \log(N_{ANT}/N_{SS})$  dB.

#### 4.3.2 Test Setup

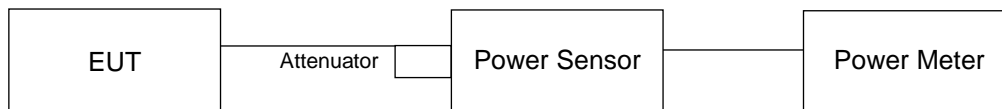

#### 4.3.3 Test Instruments

Refer to section 4.1.2 to get information of above instrument.

#### 4.3.4 Test Procedure

Method PM is used to perform output power measurement, trigger and gating function of wide band power meter is enabled to measure max output power of TX on burst. Duty factor is not added to measured value.

#### 4.3.5 Deviation from Test Standard

No deviation.

#### 4.3.6 EUT Operating Condition

The software provided by client to enable the EUT under transmission condition continuously at lowest, middle and highest channel frequencies individually.

#### 4.3.7 Test Result

#### CDD Mode

#### 802.11a

Chan.	Chan. Freq. (MHz)	Maximum Conducted Power (dBm)			Total Power (mW)	Total Power (dBm)	Limit (dBm)	Pass / Fail
		Chain 0	Chain 1	Chain 2				
36	5180	20.25	21.31	21.01	367.315	25.65	30.00	Pass
40	5200	23.01	23.12	22.89	599.638	27.78	30.00	Pass
48	5240	21.51	22.26	22.03	469.434	26.72	30.00	Pass
149	5745	21.92	22.59	23.98	587.184	27.69	30.00	Pass
157	5785	24.80	24.99	24.12	875.721	29.42	30.00	Pass
165	5825	24.35	25.12	24.22	861.598	29.35	30.00	Pass

#### 802.11ac (VHT20)

Chan.	Chan. Freq. (MHz)	Maximum Conducted Power (dBm)			Total Power (mW)	Total Power (dBm)	Limit (dBm)	Pass / Fail
		Chain 0	Chain 1	Chain 2				
36	5180	20.36	21.15	20.87	361.14	25.58	30.00	Pass
40	5200	23.11	23.02	22.98	603.7	27.81	30.00	Pass
48	5240	21.44	22.17	21.85	457.241	26.60	30.00	Pass
149	5745	22.01	22.53	23.94	585.658	27.68	30.00	Pass
157	5785	24.94	25.15	24.32	909.626	29.59	30.00	Pass
165	5825	24.74	25.01	24.22	879.05	29.44	30.00	Pass

#### 802.11ac (VHT40)

Chan.	Chan. Freq. (MHz)	Maximum Conducted Power (dBm)			Total Power (mW)	Total Power (dBm)	Limit (dBm)	Pass / Fail
		Chain 0	Chain 1	Chain 2				
38	5190	16.40	17.23	16.70	143.271	21.56	30.00	Pass
46	5230	20.66	21.19	21.25	381.287	25.81	30.00	Pass
151	5755	20.63	21.33	21.76	401.41	26.04	30.00	Pass
159	5795	24.89	25.22	24.87	947.881	29.77	30.00	Pass

#### 802.11ac (VHT80)

Chan.	Chan. Freq. (MHz)	Maximum Conducted Power (dBm)			Total Power (mW)	Total Power (dBm)	Limit (dBm)	Pass / Fail
		Chain 0	Chain 1	Chain 2				
42	5210	13.21	13.81	13.76	68.753	18.37	30.00	Pass
155	5775	19.47	20.32	20.45	307.076	24.87	30.00	Pass

## Beamforming Mode

### 802.11ac (VHT20)

Chan.	Chan. Freq. (MHz)	Maximum Conducted Power (dBm)			Total Power (mW)	Total Power (dBm)	Limit (dBm)	Pass / Fail
		Chain 0	Chain 1	Chain 2				
36	5180	20.36	21.15	20.87	361.14	25.58	27.86	Pass
40	5200	23.11	23.02	22.98	603.7	27.81	27.86	Pass
48	5240	21.44	22.17	21.85	457.241	26.60	27.86	Pass
149	5745	22.01	22.53	23.94	585.658	27.68	27.86	Pass
157	5785	23.44	23.12	22.62	608.726	27.84	27.86	Pass
165	5825	23.24	23.10	22.70	601.246	27.79	27.86	Pass

**Note:** 1. Directional gain =  $10 \log[(10^{G0/20} + 10^{G1/20} + 10^{G2/20})^2 / 3] = 8.14\text{dBi} > 6\text{dBi}$ , so the power limit shall be reduced to  $30 - (8.14 - 6) = 27.86\text{dBm}$ .

### 802.11ac (VHT40)

Chan.	Chan. Freq. (MHz)	Maximum Conducted Power (dBm)			Total Power (mW)	Total Power (dBm)	Limit (dBm)	Pass / Fail
		Chain 0	Chain 1	Chain 2				
38	5190	16.40	17.23	16.70	143.271	21.56	27.86	Pass
46	5230	20.66	21.19	21.25	381.287	25.81	27.86	Pass
151	5755	20.63	21.33	21.76	401.41	26.04	27.86	Pass
159	5795	23.12	23.45	22.52	605.074	27.82	27.86	Pass

**Note:** 1. Directional gain =  $10 \log[(10^{G0/20} + 10^{G1/20} + 10^{G2/20})^2 / 3] = 8.14\text{dBi} > 6\text{dBi}$ , so the power limit shall be reduced to  $30 - (8.14 - 6) = 27.86\text{dBm}$ .

### 802.11ac (VHT80)

Chan.	Chan. Freq. (MHz)	Maximum Conducted Power (dBm)			Total Power (mW)	Total Power (dBm)	Limit (dBm)	Pass / Fail
		Chain 0	Chain 1	Chain 2				
42	5210	13.21	13.81	13.76	68.753	18.37	27.86	Pass
155	5775	19.47	20.32	20.45	307.076	24.87	27.86	Pass

**Note:** 1. Directional gain =  $10 \log[(10^{G0/20} + 10^{G1/20} + 10^{G2/20})^2 / 3] = 8.14\text{dBi} > 6\text{dBi}$ , so the power limit shall be reduced to  $30 - (8.14 - 6) = 27.86\text{dBm}$ .



## 4.4 Occupied Bandwidth Measurement

### 4.4.1 Test Setup

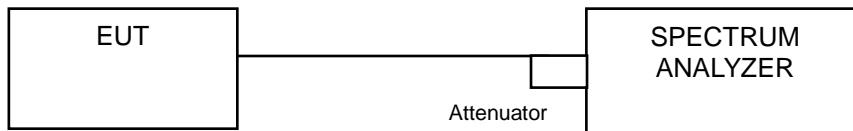

### 4.4.2 Test Instruments

Refer to section 4.1.2 to get information of above instrument.

### 4.4.3 Test Procedure

The transmitter output was connected to the spectrum analyzer through an attenuator. The bandwidth of the fundamental frequency was measured by spectrum analyzer with resolution bandwidth in the range of 1% to 5% of the anticipated emission bandwidth, and a video bandwidth at least 3x the resolution bandwidth and set the detector to SAMPLE. The width of a frequency band such that, below the lower and above the upper frequency limits, the mean powers emitted are each equal to a specified percentage 0.5 %of the total mean power of a given emission.

#### 4.4.4 Test Results

##### 802.11a

Channel	Channel Frequency (MHz)	Occupied Bandwidth (MHz)		
		Chain 0	Chain 1	Chain 2
36	5180	17.04	18.12	18.12
40	5200	19.20	20.64	21.96
48	5240	17.64	17.28	17.64
149	5745	18.36	18.60	23.40
157	5785	29.28	31.32	23.28
165	5825	28.56	30.60	23.64

##### 802.11ac (VHT20)

Channel	Channel Frequency (MHz)	Occupied Bandwidth (MHz)		
		Chain 0	Chain 1	Chain 2
36	5180	18.00	18.00	18.24
40	5200	20.40	21.24	23.76
48	5240	18.24	18.48	18.48
149	5745	18.72	19.08	26.88
157	5785	30.84	32.04	27.12
165	5825	30.72	32.40	26.64

##### 802.11ac (VHT40)

Channel	Channel Frequency (MHz)	Occupied Bandwidth (MHz)		
		Chain 0	Chain 1	Chain 2
38	5190	36.72	36.72	36.72
46	5230	36.96	36.72	36.96
151	5755	37.20	36.96	37.68
159	5795	61.68	66.00	53.04

##### 802.11ac (VHT80)

Channel	Channel Frequency (MHz)	Occupied Bandwidth (MHz)		
		Chain 0	Chain 1	Chain 2
42	5210	76.32	75.84	76.32
155	5775	76.32	76.32	76.32

### Spectrum Plot of Worst Value

**802.11a\_Chain1 / CH157**

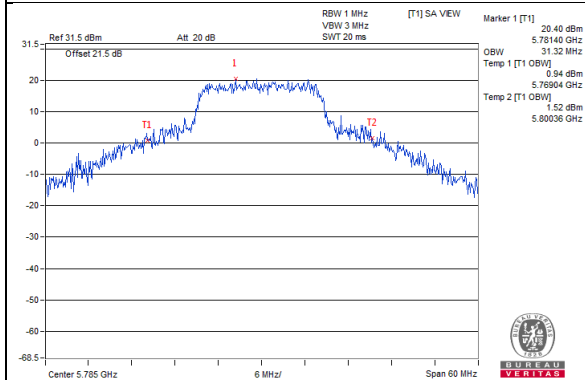

**802.11ac (VHT20)\_Chain1 / CH165**

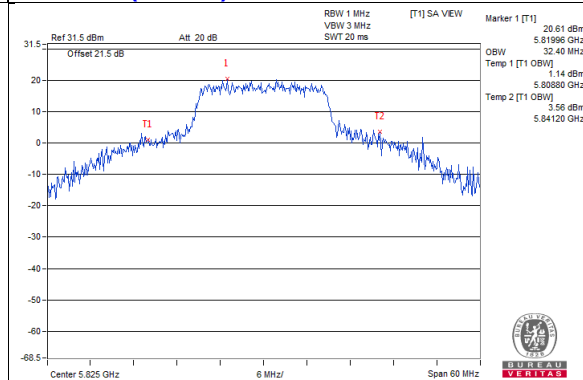

**802.11ac (VHT40)\_Chain1 / CH159**

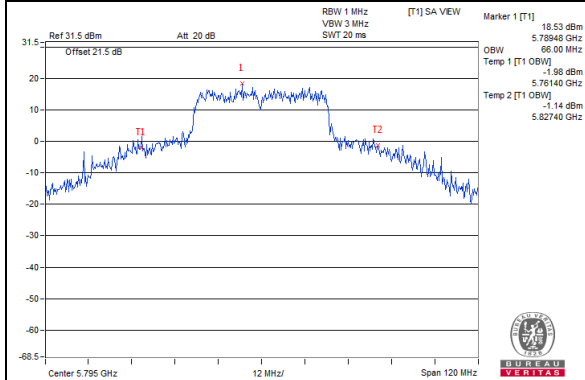

**802.11ac (VHT80)\_Chain0 / CH42**

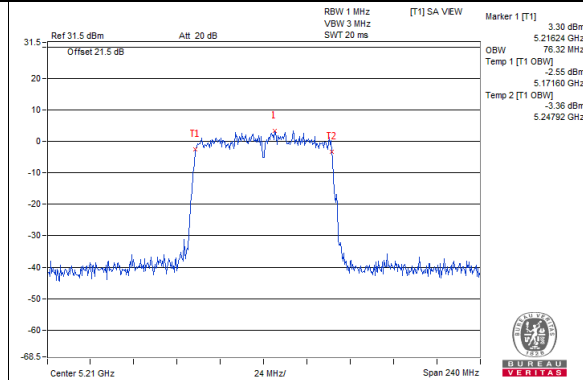

### Spectrum Plot for near by DFS band (DFS is required, if 99% OCP straddle into U-NII-2A band)

**802.11a\_Chain0 / CH48**

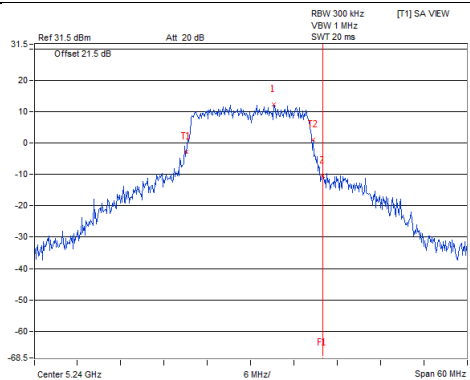

**802.11a\_Chain1 / CH48**

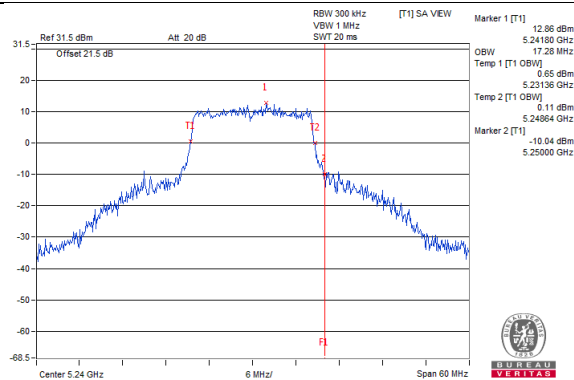

**802.11a\_Chain2 / CH48**

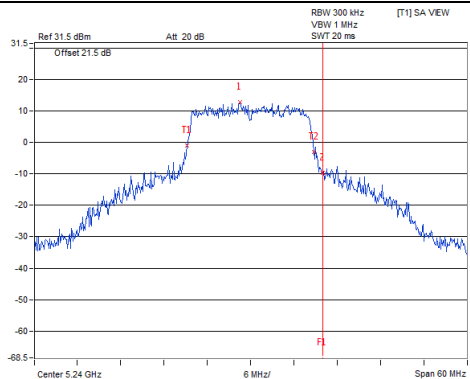

**802.11ac(VHT20)\_Chain0 / CH48**

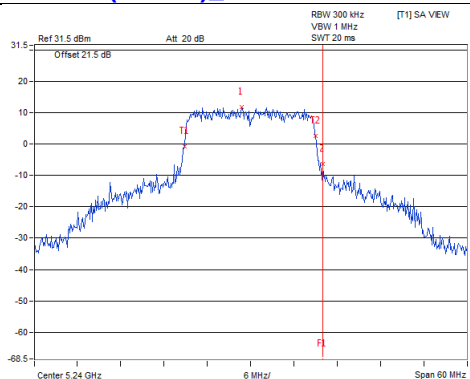

**802.11ac(VHT20)\_Chain1 / CH48**

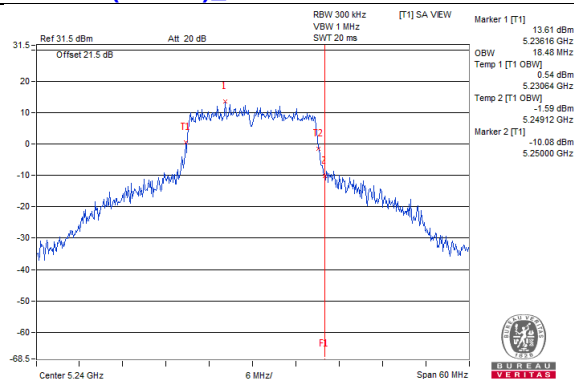

**802.11ac(VHT20)\_Chain2 / CH48**

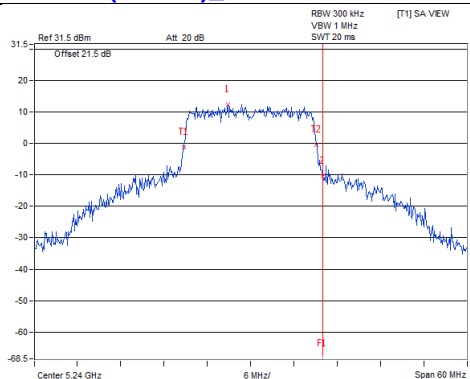

### Spectrum Plot for near by DFS band (DFS is required, if 99% OCP straddle into U-NII-2A band)

**802.11ac(VHT40)\_Chain0 / CH46**

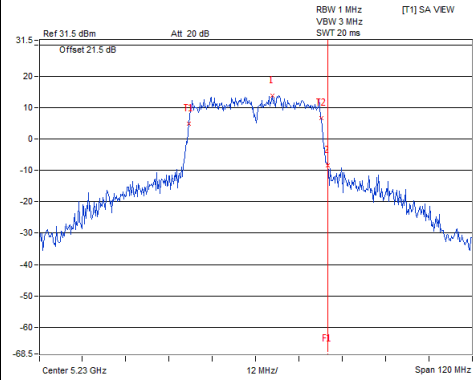

**802.11ac(VHT40)\_Chain1 / CH46**

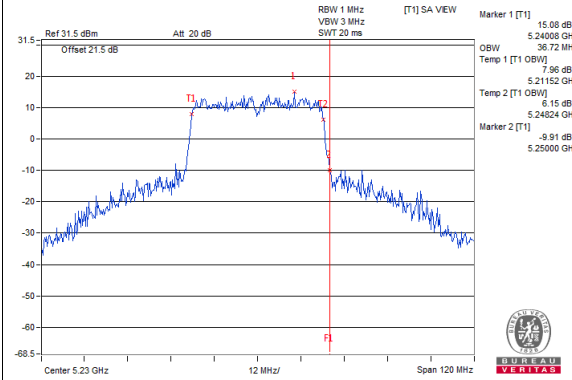

**802.11ac(VHT40)\_Chain2 / CH46**

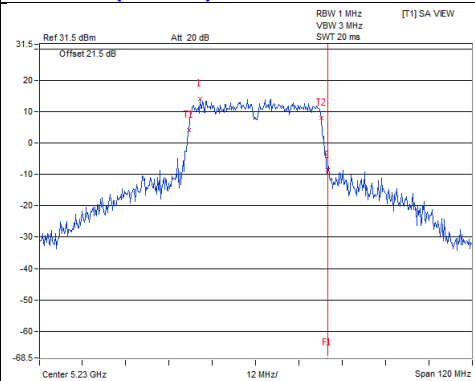

**802.11ac(VHT80)\_Chain0 / CH42**

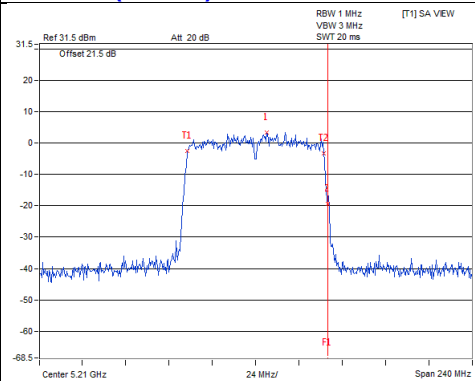

**802.11ac(VHT80)\_Chain1 / CH42**

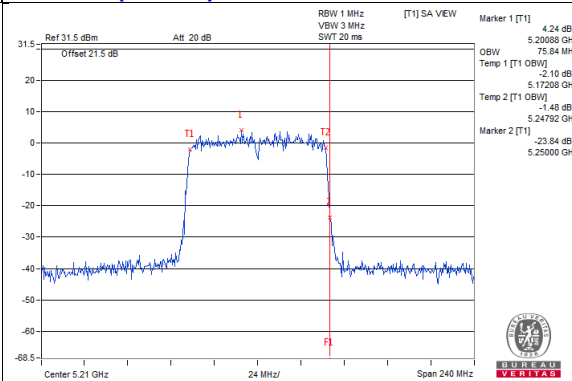

**802.11ac(VHT80)\_Chain2 / CH42**

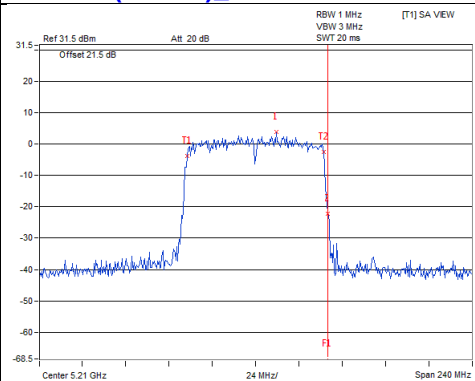

**Spectrum Plot for near by DFS band  
(DFS is required, if 99% OCP straddle into U-NII-2C band)**

**802.11a\_Chain0 / CH149**

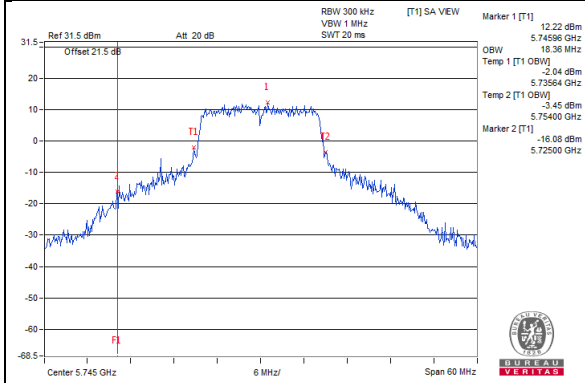

**802.11a\_Chain1 / CH149**

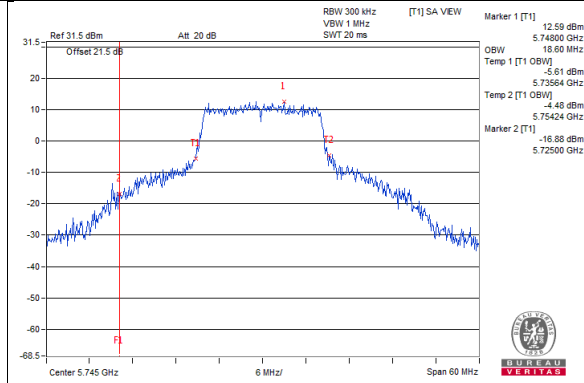

**802.11a\_Chain2 / CH149**

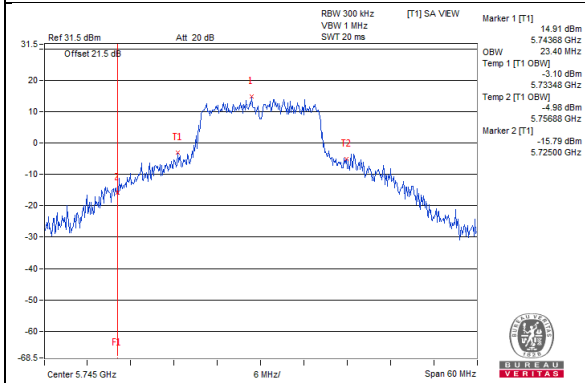

**802.11ac(VHT20)\_Chain0 / CH149**

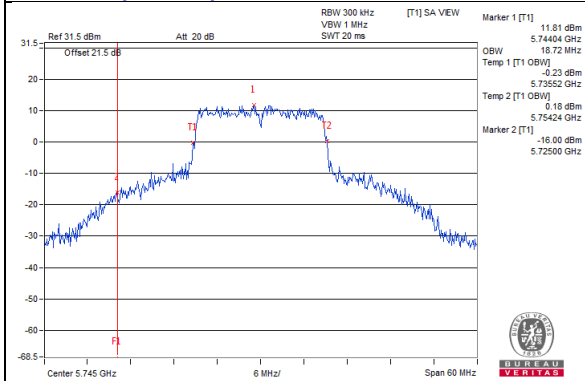

**802.11ac(VHT20)\_Chain1 / CH149**

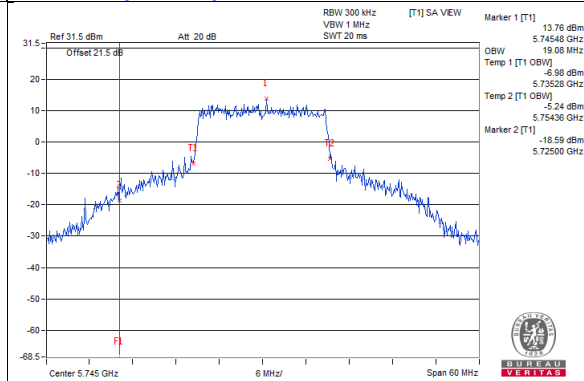

**802.11ac(VHT20)\_Chain2 / CH149**

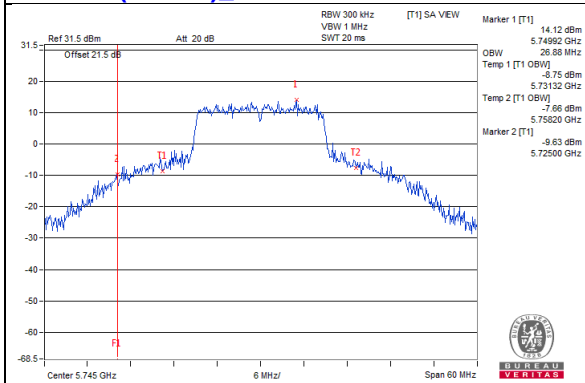

### Spectrum Plot for near by DFS band (DFS is required, if 99% OCP straddle into U-NII-2C band)

**802.11ac(VHT40)\_Chain0 / CH151**

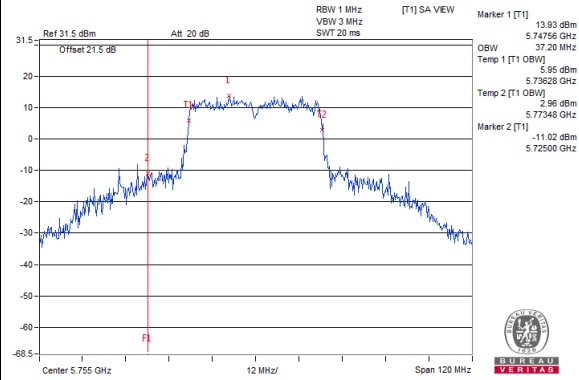

**802.11ac(VHT40)\_Chain1 / CH151**

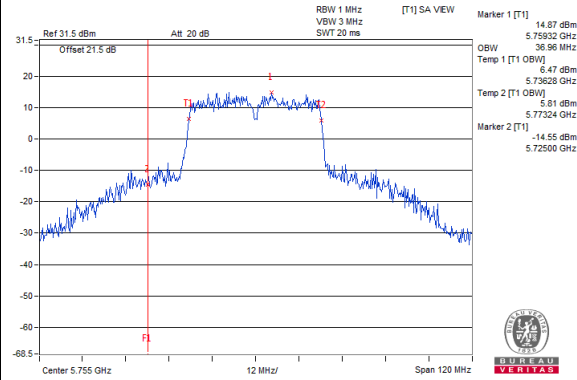

**802.11ac(VHT40)\_Chain2 / CH151**

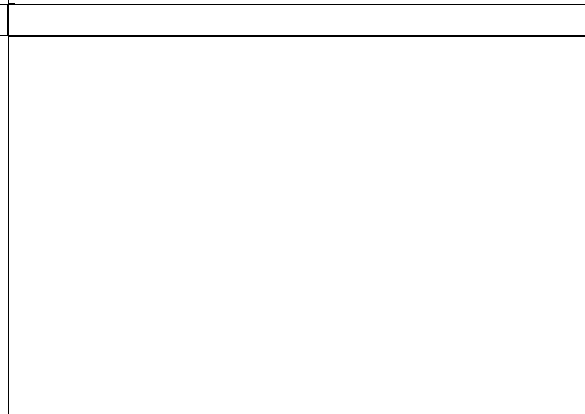
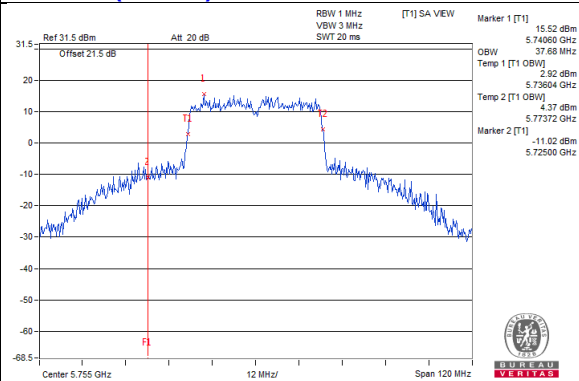

**802.11ac(VHT80)\_Chain0 / CH155**

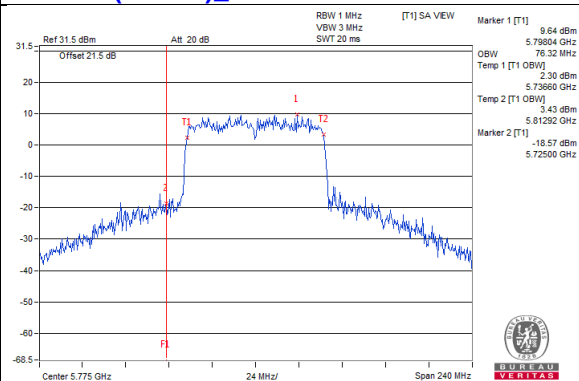

**802.11ac(VHT80)\_Chain1 / CH155**

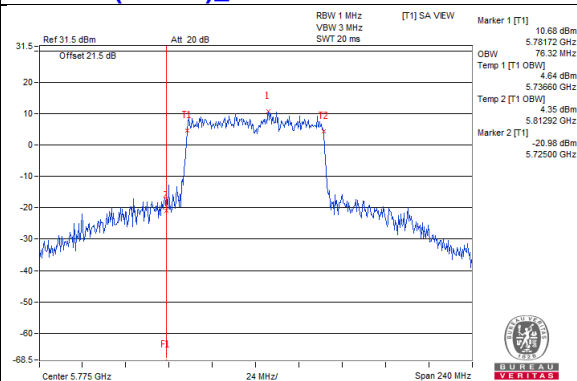

**802.11ac(VHT80)\_Chain2 / CH155**

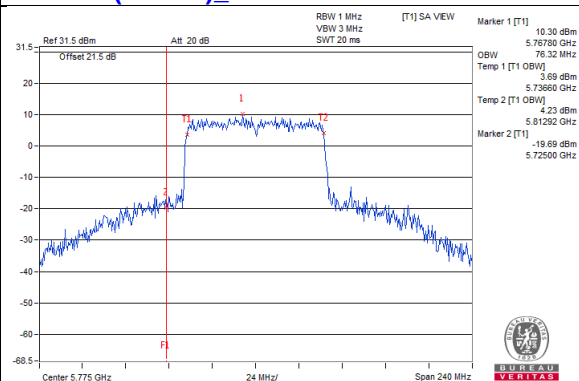

## 4.5 Peak Power Spectral Density Measurement

### 4.5.1 Limits of Peak Power Spectral Density Measurement

Operation Band	EUT Category		Limit
U-NII-1		Outdoor Access Point	17dBm/ MHz
		Fixed point-to-point Access Point	
	√	Indoor Access Point	
		Client device	
U-NII-2A			11dBm/ MHz
U-NII-2C			11dBm/ MHz
U-NII-3	√		30dBm/ 500kHz

### 4.5.2 Test Setup

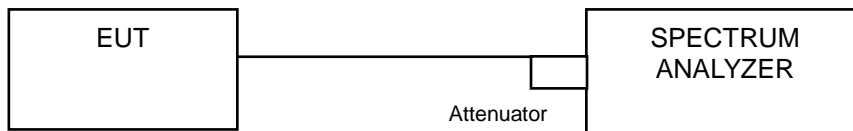

### 4.5.3 Test Instruments

Refer to section 4.1.2 to get information of above instrument.



#### 4.5.4 Test Procedure

##### **802.11a, 802.11ac (VHT20) , 802.11ac (VHT40)**

###### **For U-NII-1:**

Using method SA-1

1. Set span to encompass the entire emission bandwidth (EBW) of the signal.
2. Set RBW = 1 MHz, Set VBW  $\geq$  3 MHz, Detector = RMS
3. Sweep time = auto, trigger set to "free run".
4. Trace average at least 100 traces in power averaging mode.
5. Record the max value

###### **For U-NII-3:**

1. Set span to encompass the entire emission bandwidth (EBW) of the signal.
2. Set RBW = 300 kHz, Set VBW  $\geq$  1 MHz, Detector = RMS
3. Use the peak marker function to determine the maximum power level in any 300 kHz band segment within the fundamental EBW.
4. Scale the observed power level to an equivalent value in 500 kHz by adjusting (reducing) the measured power by a bandwidth correction factor (BWCF) where  $BWCF = 10\log(500 \text{ kHz}/300\text{kHz})$
5. Sweep time = auto, trigger set to "free run".
6. Trace average at least 100 traces in power averaging mode.
7. Record the max value

##### **802.11ac (VHT80)**

###### **For U-NII-1:**

Using method SA-2

1. Set span to encompass the entire emission bandwidth (EBW) of the signal.
2. Set RBW = 1 MHz, Set VBW  $\geq$  3 MHz, Detector = RMS
3. Sweep time = auto, trigger set to "free run".
4. Trace average at least 100 traces in power averaging mode.
5. Record the max value and add  $10 \log (1/\text{duty cycle})$

###### **For U-NII-3:**

1. Set span to encompass the entire emission bandwidth (EBW) of the signal.
2. Set RBW = 300 kHz, Set VBW  $\geq$  1 MHz, Detector = RMS
3. Use the peak marker function to determine the maximum power level in any 300 kHz band segment within the fundamental EBW.
4. Scale the observed power level to an equivalent value in 500 kHz by adjusting (reducing) the measured power by a bandwidth correction factor (BWCF) where  $BWCF = 10\log(500 \text{ kHz}/300\text{kHz})$
5. Sweep time = auto, trigger set to "free run".
6. Trace average at least 100 traces in power averaging mode.
7. Record the max value and add  $10 \log (1/\text{duty cycle})$

#### 4.5.5 Deviation from Test Standard

No deviation.

#### 4.5.6 EUT Operating Condition

Same as Item 4.3.6.

#### 4.5.7 Test Results

##### For U-NII-1:

##### 802.11a

Chan.	Chan. Freq. (MHz)	PSD (dBm/MHz)			Total Power Density (dBm/MHz)	MAX. Limit (dBm/MHz)	Pass / Fail
		Chain 0	Chain 1	Chain 2			
36	5180	6.71	7.11	7.30	11.82	14.86	Pass
40	5200	9.15	9.21	9.52	14.07	14.86	Pass
48	5240	8.32	8.08	8.65	13.13	14.86	Pass

- Note:** 1. Method a) of power density measurement of KDB 662911 is using for calculating total power density. Total power density is summing entire spectra across corresponding frequency bins on the various outputs by computer.  
 2. Directional gain =  $10 \log[(10^{G0/20} + 10^{G1/20} + 10^{G2/20})^2 / 3] = 8.14\text{dBi} > 6\text{dBi}$ , so the power density limit shall be reduced to  $17-(8.14-6) = 14.86\text{dBm}$ .

##### 802.11ac (VHT20)

Chan.	Chan. Freq. (MHz)	PSD (dBm/MHz)			Total Power Density (dBm/MHz)	MAX. Limit (dBm/MHz)	Pass / Fail
		Chain 0	Chain 1	Chain 2			
36	5180	6.46	6.88	7.03	11.57	14.86	Pass
40	5200	8.82	8.96	9.42	13.85	14.86	Pass
48	5240	8.23	7.93	8.31	12.93	14.86	Pass

- Note:** 1. Method a) of power density measurement of KDB 662911 is using for calculating total power density. Total power density is summing entire spectra across corresponding frequency bins on the various outputs by computer.  
 2. Directional gain =  $10 \log[(10^{G0/20} + 10^{G1/20} + 10^{G2/20})^2 / 3] = 8.14\text{dBi} > 6\text{dBi}$ , so the power density limit shall be reduced to  $17-(8.14-6) = 14.86\text{dBm}$ .

##### 802.11ac (VHT40)

Chan.	Chan. Freq. (MHz)	PSD (dBm/MHz)			Total Power Density (dBm/MHz)	MAX. Limit (dBm/MHz)	Pass / Fail
		Chain 0	Chain 1	Chain 2			
38	5190	-0.49	0.31	-0.07	4.70	14.86	Pass
46	5230	4.16	4.19	4.58	9.09	14.86	Pass

- Note:** 1. Method a) of power density measurement of KDB 662911 is using for calculating total power density. Total power density is summing entire spectra across corresponding frequency bins on the various outputs by computer.  
 2. Directional gain =  $10 \log[(10^{G0/20} + 10^{G1/20} + 10^{G2/20})^2 / 3] = 8.14\text{dBi} > 6\text{dBi}$ , so the power density limit shall be reduced to  $17-(8.14-6) = 14.86\text{dBm}$ .

### 802.11ac (VHT80)

Chan.	Chan. Freq. (MHz)	PSD W/O Duty Factor (dBm/MHz)			Duty Factor (dB)	Total PSD With Duty Factor (dBm/MHz)	MAX. Limit (dBm/MHz)	Pass / Fail
		Chain 0	Chain 1	Chain 2				
42	5210	-6.14	-6.07	-6.31	0.18	-1.22	14.86	Pass

- Note:**
- Method a) of power density measurement of KDB 662911 is using for calculating total power density. Total power density is summing entire spectra across corresponding frequency bins on the various outputs by computer.
  - Directional gain =  $10 \log[(10^{G_0/20} + 10^{G_1/20} + 10^{G_2/20})^2 / 3] = 8.14\text{dBi} > 6\text{dBi}$ , so the power density limit shall be reduced to  $17 - (8.14 - 6) = 14.86\text{dBm}$ .
  - Refer to section 3.3 for duty cycle spectrum plot.

### Spectrum Plot of Worst Value

**802.11a\_Chain 2 / CH40**

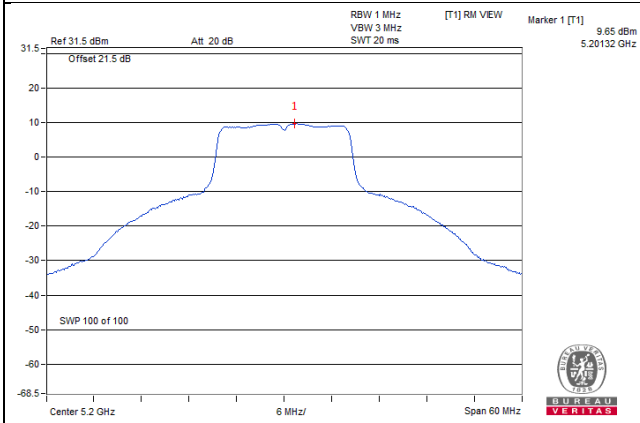

**802.11ac (VHT20)\_Chain 2 / CH40**

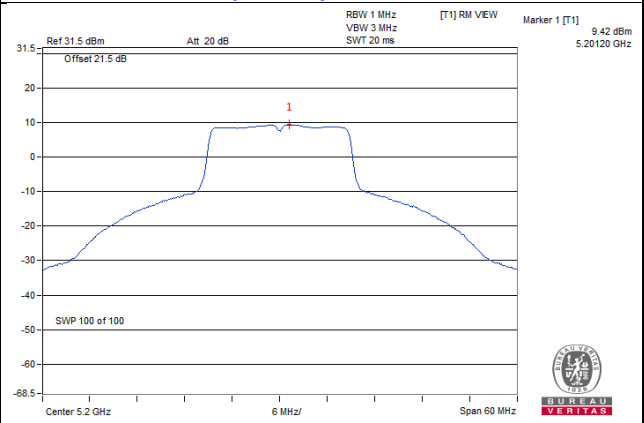

**802.11ac (VHT40)\_Chain 2 / CH46**

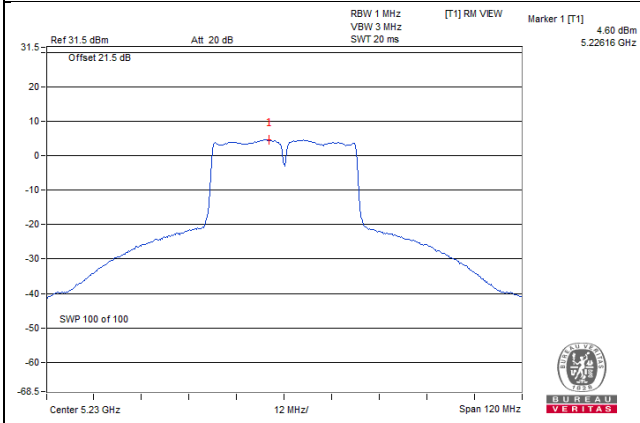

**802.11ac (VHT80)\_Chain 1 / CH42**

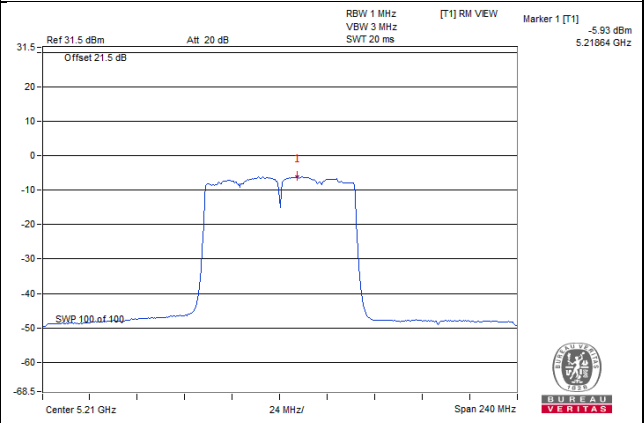

**For U-NII-3:**  
**802.11a**

TX chain	Channel	Freq. (MHz)	PSD (dBm/300kHz)	PSD (dBm/500kHz)	10 log (N=3) dB	Total PSD (dBm/500kHz)	Limit (dBm/500kHz)	Pass /Fail
0	149	5745	0.28	2.50	4.77	7.27	27.86	Pass
	157	5785	2.32	4.54	4.77	9.31	27.86	Pass
	165	5825	2.11	4.33	4.77	9.10	27.86	Pass
1	149	5745	0.80	3.02	4.77	7.79	27.86	Pass
	157	5785	3.03	5.25	4.77	10.02	27.86	Pass
	165	5825	2.74	4.96	4.77	9.73	27.86	Pass
2	149	5745	1.46	3.68	4.77	8.45	27.86	Pass
	157	5785	1.64	3.86	4.77	8.63	27.86	Pass
	165	5825	1.57	3.79	4.77	8.56	27.86	Pass

Note: 1. Directional gain =  $10 \log[(10^{G0/20} + 10^{G1/20} + 10^{G2/20})^2 / 3] = 8.14\text{dBi} > 6\text{dBi}$ , so the power density limit shall be reduced to  $30-(8.14-6) = 27.86\text{dBm}$ .

**802.11ac (VHT20)**

TX chain	Channel	Freq. (MHz)	PSD (dBm/300kHz)	PSD (dBm/500kHz)	10 log (N=3) dB	Total PSD (dBm/500kHz)	Limit (dBm/500kHz)	Pass /Fail
0	149	5745	0.11	2.33	4.77	7.10	27.86	Pass
	157	5785	1.60	3.82	4.77	8.59	27.86	Pass
	165	5825	1.83	4.05	4.77	8.82	27.86	Pass
1	149	5745	0.75	2.97	4.77	7.74	27.86	Pass
	157	5785	2.21	4.43	4.77	9.20	27.86	Pass
	165	5825	2.13	4.35	4.77	9.12	27.86	Pass
2	149	5745	1.38	3.60	4.77	8.37	27.86	Pass
	157	5785	1.53	3.75	4.77	8.52	27.86	Pass
	165	5825	1.59	3.81	4.77	8.58	27.86	Pass

Note: 1. Directional gain =  $10 \log[(10^{G0/20} + 10^{G1/20} + 10^{G2/20})^2 / 3] = 8.14\text{dBi} > 6\text{dBi}$ , so the power density limit shall be reduced to  $30-(8.14-6) = 27.86\text{dBm}$ .

### 802.11ac (VHT40)

TX chain	Channel	Freq. (MHz)	PSD (dBm/300kHz)	PSD (dBm/500kHz)	10 log (N=3) dB	Total PSD (dBm/500kHz)	Limit (dBm/500kHz)	Pass /Fail
0	151	5755	-3.79	-1.57	4.77	3.20	27.86	Pass
	159	5795	-1.55	0.67	4.77	5.44	27.86	Pass
1	151	5755	-3.97	-1.75	4.77	3.02	27.86	Pass
	159	5795	-0.99	1.23	4.77	6.00	27.86	Pass
2	151	5755	-3.22	-1.00	4.77	3.77	27.86	Pass
	159	5795	-1.93	0.29	4.77	5.06	27.86	Pass

Note: 1. Directional gain =  $10 \log[(10^{G0/20} + 10^{G1/20} + 10^{G2/20})^2 / 3] = 8.14\text{dBi} > 6\text{dBi}$ , so the power density limit shall be reduced to  $30 - (8.14 - 6) = 27.86\text{dBm}$ .

### 802.11ac (VHT80)

TX chain	Chan.	Chan. Freq. (MHz)	PSD W/O Duty Factor		10 log (N=3) dB	Duty Factor (dB)	Total PSD With Duty Factor (dBm/500kHz)	Limit (dBm/500kHz)	Pass /Fail
			(dBm/300kHz)	(dBm/500kHz)					
0	155	5775	-8.67	-6.45	4.77	0.18	-1.50	27.86	Pass
1	155	5775	-8.10	-5.88	4.77	0.18	-0.93	27.86	Pass
2	155	5775	-8.50	-6.28	4.77	0.18	-1.33	27.86	Pass

Note: 1. Directional gain =  $10 \log[(10^{G0/20} + 10^{G1/20} + 10^{G2/20})^2 / 3] = 8.14\text{dBi} > 6\text{dBi}$ , so the power density limit shall be reduced to  $30 - (8.14 - 6) = 27.86\text{dBm}$ .

2. Refer to section 3.3 for duty cycle spectrum plot.

Spectrum Plot of Worst Value

802.11a – Chain 1: CH 157

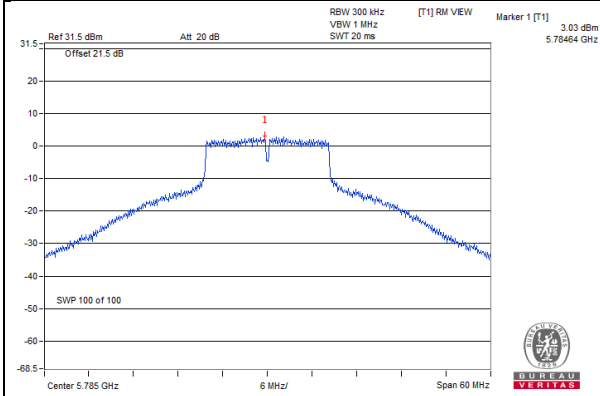

802.11ac (VHT20) – Chain 1: CH 157

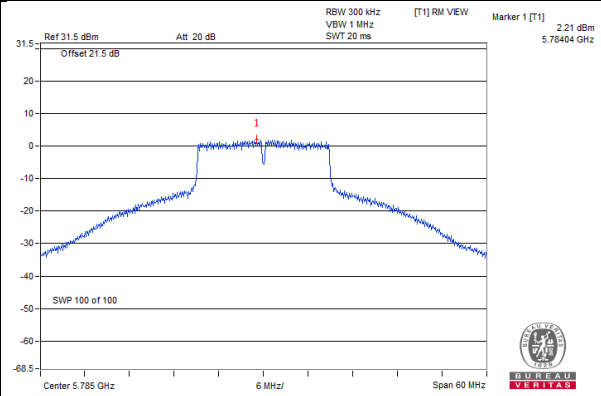

802.11ac (VHT40) – Chain 1: CH 159

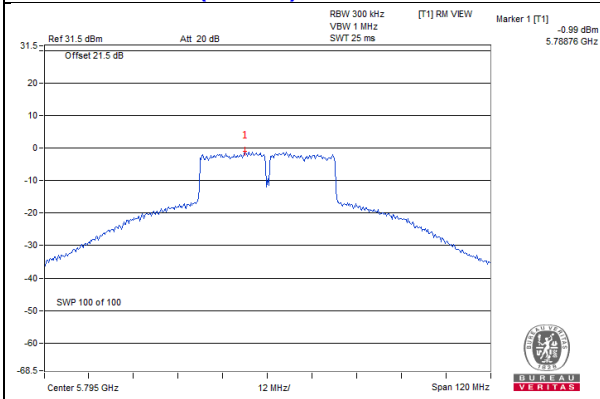

802.11ac (VHT80) – Chain 1: CH 155

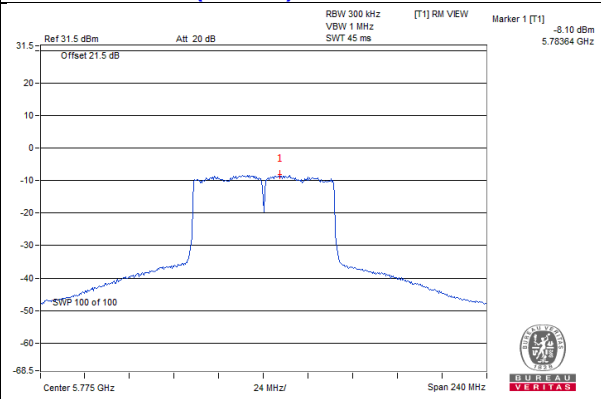

## 4.6 Frequency Stability Measurement

### 4.6.1 Limits of Frequency Stability Measurement

The frequency of the carrier signal shall be maintained within band of operation

### 4.6.2 Test Setup

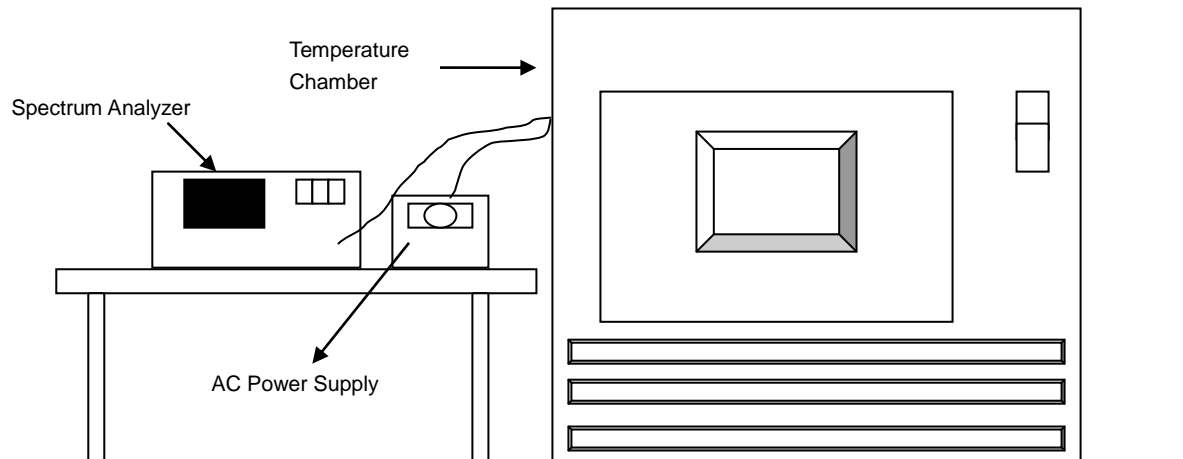

### 4.6.3 Test Instruments

Refer to section 4.1.2 to get information of above instrument.

### 4.6.4 Test Procedure

- The EUT was placed inside the environmental test chamber and powered by nominal AC voltage.
- Turn the EUT on and couple its output to a spectrum analyzer.
- Turn the EUT off and set the chamber to the highest temperature specified.
- Allow sufficient time (approximately 30 min) for the temperature of the chamber to stabilize, turn the EUT on and measure the operating frequency after 2, 5, and 10 Minutes.
- Repeat step 2 and 3 with the temperature chamber set to the lowest temperature.
- The test chamber was allowed to stabilize at +20 degree C for a minimum of 30 Minutes. The supply voltage was then adjusted on the EUT from 85% to 115% and the frequency record.

### 4.6.5 Deviation from Test Standard

No deviation.

### 4.6.6 EUT Operating Condition

Set the EUT transmit at un-modulation mode to test frequency stability.



## 4.6.7 Test Results

Frequency Stability Versus Temp.									
Operating Frequency: 5180 MHz									
TEMP. (°C)	Power Supply (Vac)	0 Minute		2 Minutes		5 Minutes		10 Minutes	
		Measured Frequency (MHz)	Pass/Fail	Measured Frequency (MHz)	Pass/Fail	Measured Frequency (MHz)	Pass/Fail	Measured Frequency (MHz)	Pass/Fail
50	120	5179.9917	PASS	5179.9906	PASS	5179.9892	PASS	5179.9903	PASS
40	120	5180.0153	PASS	5180.0159	PASS	5180.017	PASS	5180.0153	PASS
30	120	5180.0044	PASS	5180.005	PASS	5180.0058	PASS	5180.0067	PASS
20	120	5179.9754	PASS	5179.9762	PASS	5179.9722	PASS	5179.9758	PASS
10	120	5179.9907	PASS	5179.9876	PASS	5179.9898	PASS	5179.9923	PASS
0	120	5179.9823	PASS	5179.9839	PASS	5179.9839	PASS	5179.9845	PASS
-10	120	5179.9954	PASS	5179.9927	PASS	5179.9953	PASS	5179.9944	PASS
-20	120	5180.0038	PASS	5180.0023	PASS	5180.0034	PASS	5180.0018	PASS
-30	120	5180.0219	PASS	5180.0205	PASS	5180.0226	PASS	5180.0207	PASS

Frequency Stability Versus Voltage									
Operating Frequency: 5180 MHz									
TEMP. (°C)	Power Supply (Vac)	0 Minute		2 Minutes		5 Minutes		10 Minutes	
		Measured Frequency (MHz)	Pass/Fail	Measured Frequency (MHz)	Pass/Fail	Measured Frequency (MHz)	Pass/Fail	Measured Frequency (MHz)	Pass/Fail
20	138	5179.9747	PASS	5179.9764	PASS	5179.9728	PASS	5179.9756	PASS
	120	5179.9754	PASS	5179.9762	PASS	5179.9722	PASS	5179.9758	PASS
	102	5179.9752	PASS	5179.9768	PASS	5179.9722	PASS	5179.9751	PASS

## 4.7 6dB Bandwidth Measurement

### 4.7.1 Limits of 6dB Bandwidth Measurement

The minimum of 6dB Bandwidth Measurement is 0.5MHz.

### 4.7.2 Test Setup

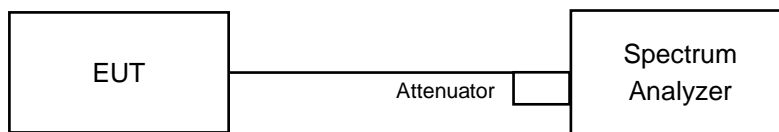

### 4.7.3 Test Instruments

Refer to section 4.1.2 to get information of above instrument.

### 4.7.4 Test Procedure

#### MEASUREMENT PROCEDURE REF

- Set resolution bandwidth (RBW) = 100kHz
- Set the video bandwidth (VBW)  $\geq 3 \times$  RBW, Detector = Peak.
- Trace mode = max hold.
- Sweep = auto couple.
- Measure the maximum width of the emission that is constrained by the frequencies associated with the two amplitude points (upper and lower) that are attenuated by 6 dB relative to the maximum level measured in the fundamental emission

### 4.7.5 Deviation from Test Standard

No deviation.

### 4.7.6 EUT Operating Condition

The software provided by client to enable the EUT under transmission condition continuously at lowest, middle and highest channel frequencies individually.

#### 4.7.7 Test Results

##### 802.11a

Channel	Frequency (MHz)	6dB Bandwidth (MHz)			Minimum Limit (MHz)	Pass / Fail
		Chain 0	Chain 1	Chain 2		
149	5745	16.38	16.39	16.40	0.5	PASS
157	5785	16.37	16.38	16.41	0.5	PASS
165	5825	16.40	16.32	16.40	0.5	PASS

##### 802.11ac (VHT20)

Channel	Frequency (MHz)	6dB Bandwidth (MHz)			Minimum Limit (MHz)	Pass / Fail
		Chain 0	Chain 1	Chain 2		
149	5745	17.60	17.67	17.63	0.5	PASS
157	5785	17.24	17.62	17.62	0.5	PASS
165	5825	17.57	17.61	17.62	0.5	PASS

##### 802.11ac (VHT40)

Channel	Frequency (MHz)	6dB Bandwidth (MHz)			Minimum Limit (MHz)	Pass / Fail
		Chain 0	Chain 1	Chain 2		
151	5755	36.44	36.46	36.47	0.5	PASS
159	5795	36.16	36.39	36.37	0.5	PASS

##### 802.11ac (VHT80)

Channel	Frequency (MHz)	6dB Bandwidth (MHz)			Minimum Limit (MHz)	Pass / Fail
		Chain 0	Chain 1	Chain 2		
155	5775	75.80	76.06	75.59	0.5	PASS

**Spectrum Plot of Worst Value**

**802.11a\_Chain 1 / CH165**

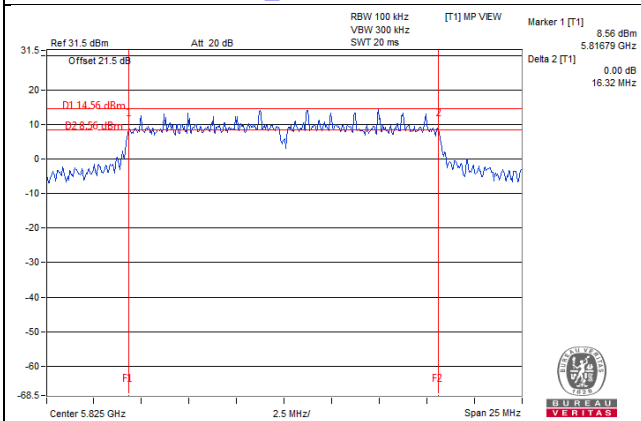

**802.11ac (VHT20)\_Chain 0 / CH157**

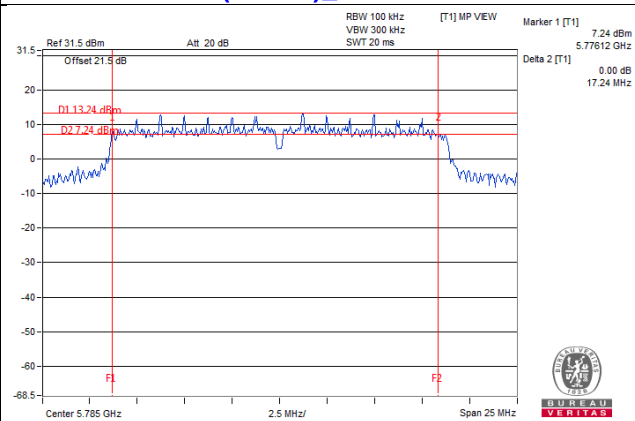

**802.11ac (VHT40)\_Chain 0 / CH159**

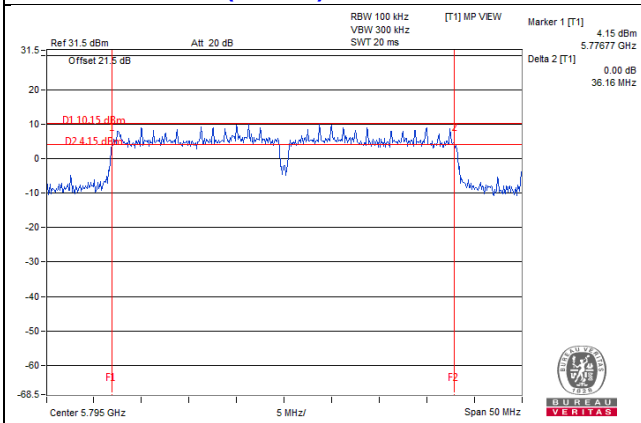

**802.11ac (VHT80)\_Chain 2 / CH155**

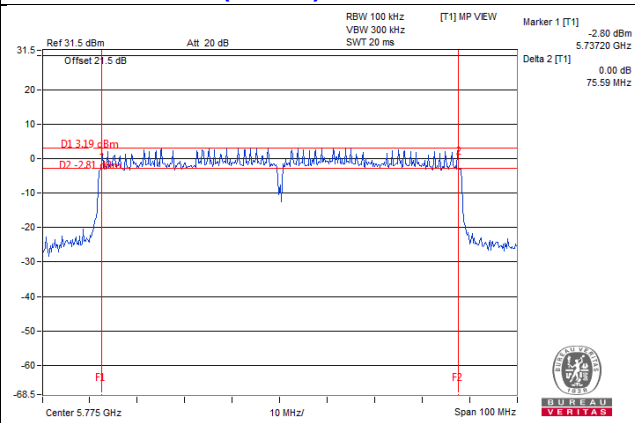

## 5 Pictures of Test Arrangements

Please refer to the attached file (Test Setup Photo).

### Annex A- Radiated Out of Band Emission (OOBE) Measurement (For U-NII-3 band)

802.11a

**CH 149 5745 MHz**

**Horizontal**

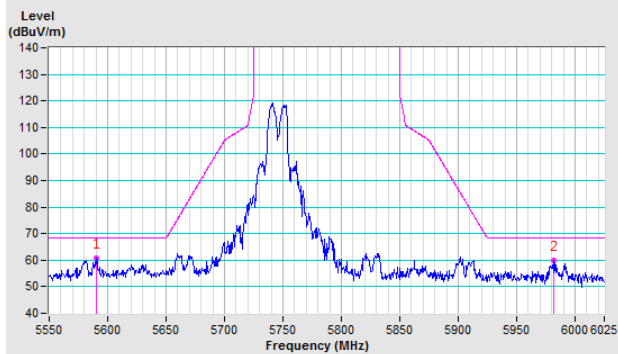

**Vertical**

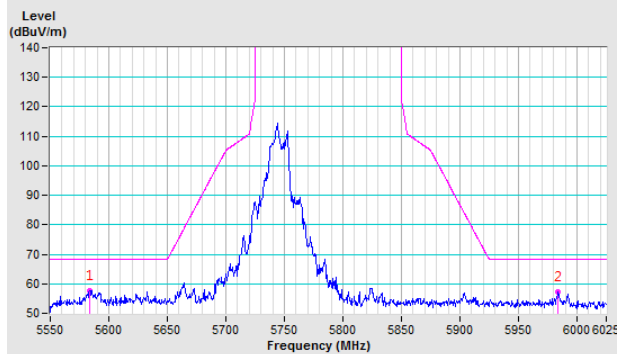

**CH 157 5785 MHz**

**Horizontal**

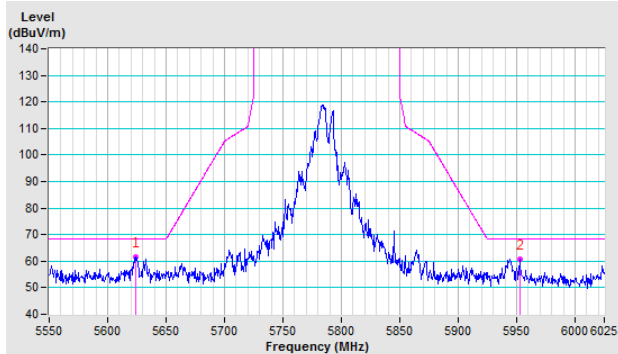

**Vertical**

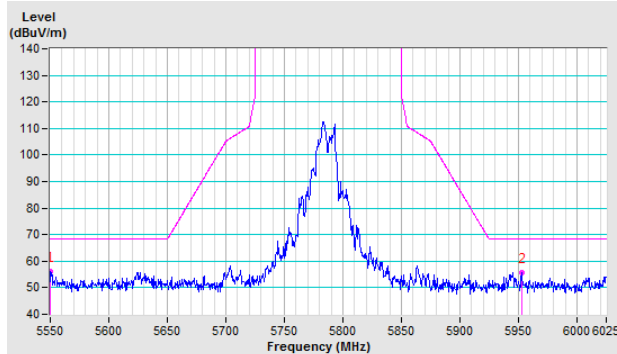

**CH 165 5825 MHz**

**Horizontal**

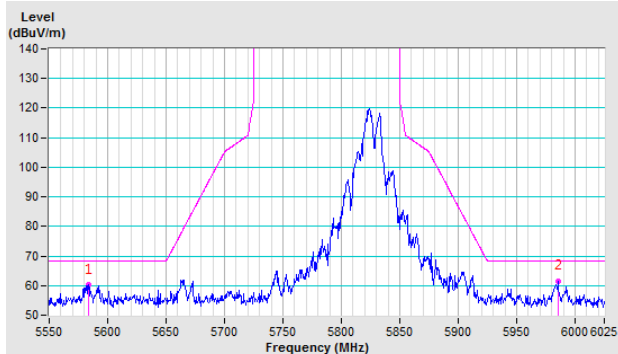

**Vertical**

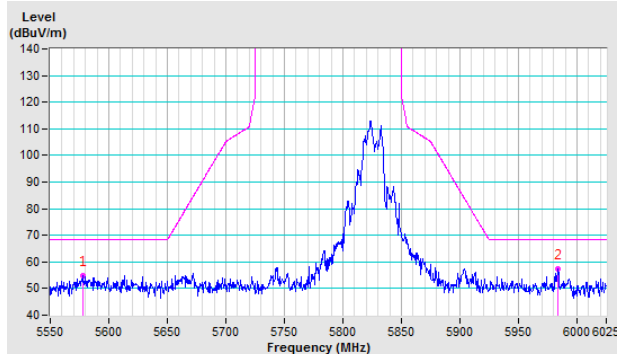

### 802.11ac (VHT20)

#### CH 149 5745 MHz

##### Horizontal

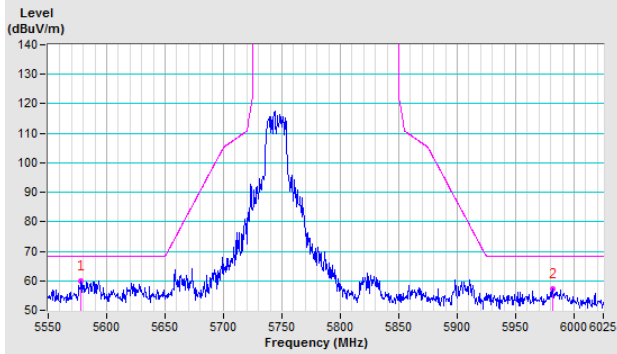

##### Vertical

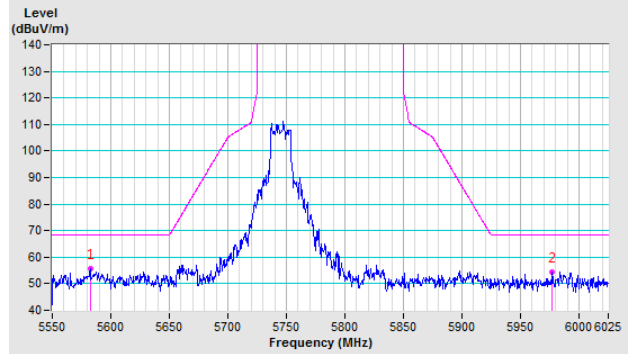

#### CH 157 5785 MHz

##### Horizontal

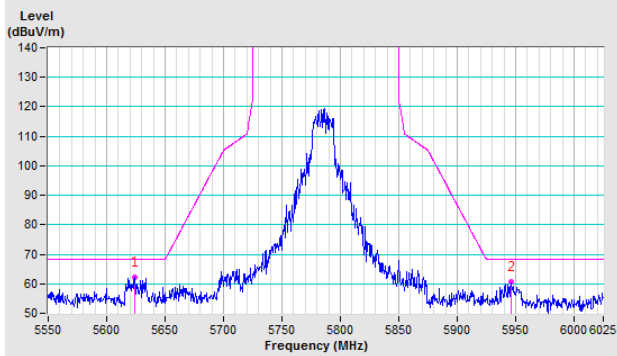

##### Vertical

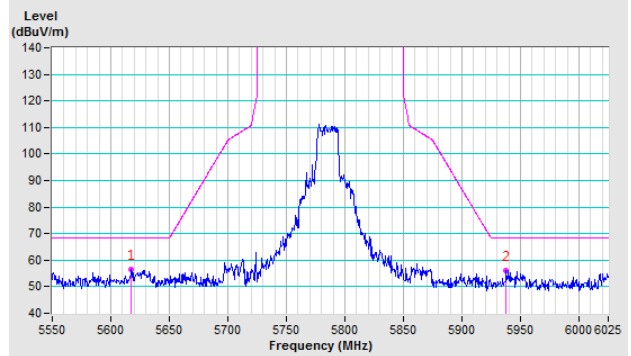

#### CH 165 5825 MHz

##### Horizontal

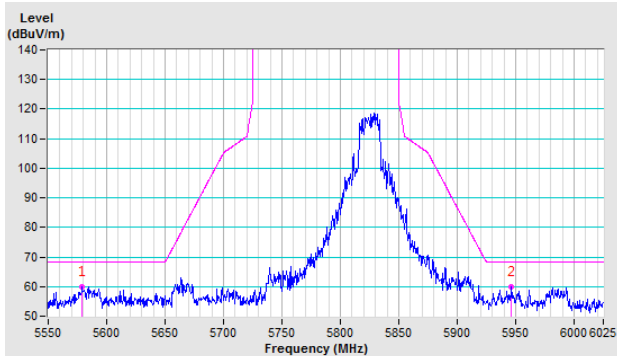

##### Vertical

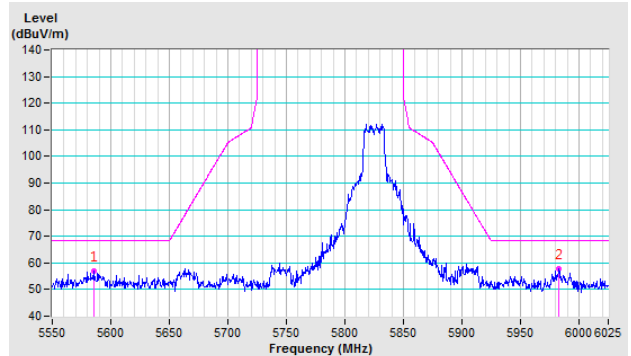

### 802.11ac (VHT40)

CH 151 5755 MHz

Horizontal

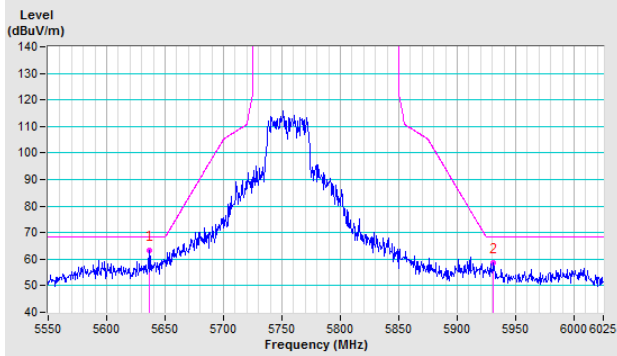

Vertical

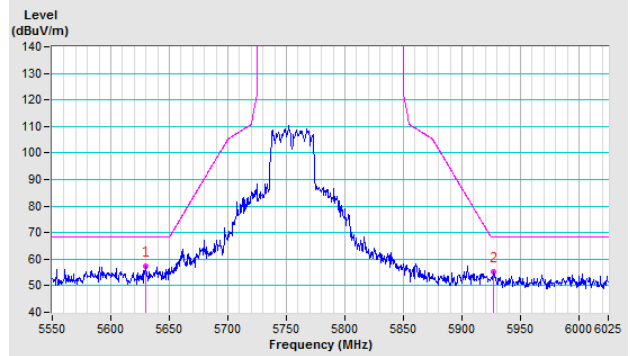

CH 159 5795 MHz

Horizontal

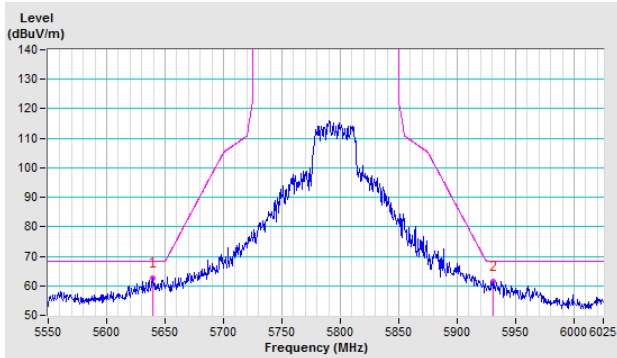

Vertical

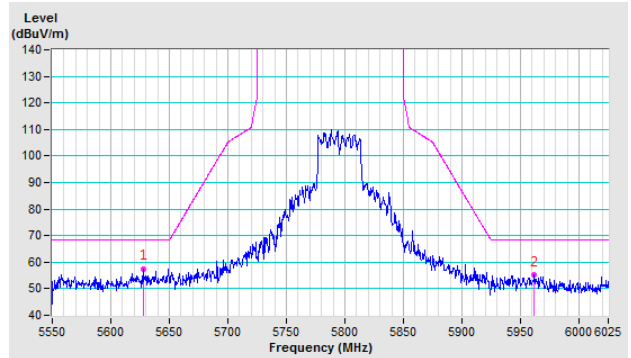

### 802.11ac (VHT80)

CH 155 5775 MHz

Horizontal

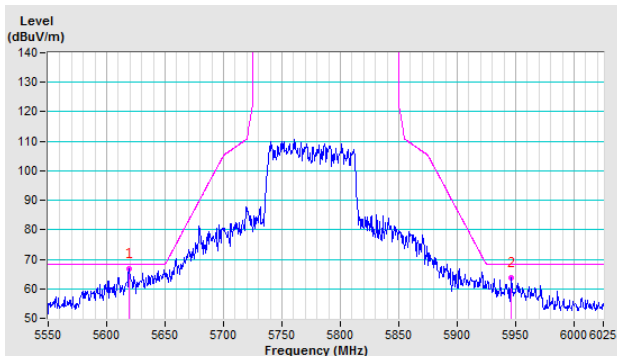

Vertical

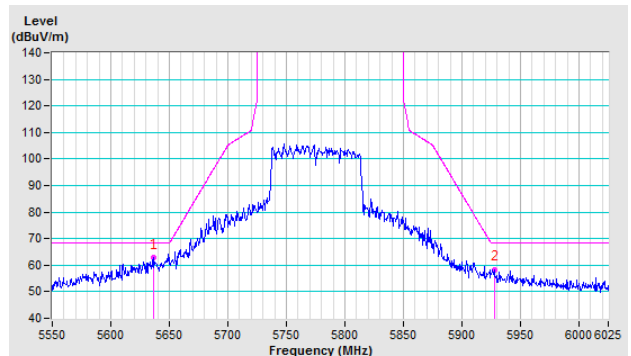



## Appendix – Information on the Testing Laboratories

We, Bureau Veritas Consumer Products Services (H.K.) Ltd., Taoyuan Branch, were founded in 1988 to provide our best service in EMC, Radio, Telecom and Safety consultation. Our laboratories are FCC recognized accredited test firms and accredited according to ISO/IEC 17025.

If you have any comments, please feel free to contact us at the following:

**Linkou EMC/RF Lab**

Tel: 886-2-26052180

Fax: 886-2-26051924

**Hsin Chu EMC/RF/Telecom Lab**

Tel: 886-3-6668565

Fax: 886-3-6668323

**Hwa Ya EMC/RF/Safety Lab**

Tel: 886-3-3183232

Fax: 886-3-3270892

**Email:** [service.adt@tw.bureauveritas.com](mailto:service.adt@tw.bureauveritas.com)

**Web Site:** [www.bureauveritas-adt.com](http://www.bureauveritas-adt.com)

The address and road map of all our labs can be found in our web site also.

--- END ---