

FCC Test Report (WLAN)

Report No.: RF170220E09-1

FCC ID: XCNRAC2V1U

Test Model: RAC2V1U

Received Date: Feb. 20, 2017

Test Date: Mar. 01 to Apr. 26, 2017

Issued Date: June 21, 2017

Applicant: Ubee Interactive Corp.

Address: 10F-1, No. 5, Taiyuan 1st St. Jhubei Ci, Hsinchu County 302, Taiwan ,
R.O.C.

Issued By: Bureau Veritas Consumer Products Services (H.K.) Ltd., Taoyuan Branch
Hsin Chu Laboratory

Lab Address: E-2, No.1, Li Hsin 1st Road, Hsinchu Science Park, Hsinchu City 300,
Taiwan R.O.C.

Test Location (1): E-2, No.1, Li Hsin 1st Road, Hsinchu Science Park, Hsinchu City 300,
Taiwan R.O.C.

Test Location (2): No. 49, Ln. 206, Wende Rd., Shangshan Tsuen, Chiung Lin Hsiang, Hsin
Chu Hsien 307, Taiwan R.O.C.



This report is for your exclusive use. Any copying or replication of this report to or for any other person or entity, or use of our name or trademark, is permitted only with our prior written permission. This report sets forth our findings solely with respect to the test samples identified herein. The results set forth in this report are not indicative or representative of the quality or characteristics of the lot from which a test sample was taken or any similar or identical product unless specifically and expressly noted. Our report includes all of the tests requested by you and the results thereof based upon the information that you provided to us. You have 60 days from date of issuance of this report to notify us of any material error or omission caused by our negligence, provided, however, that such notice shall be in writing and shall specifically address the issue you wish to raise. A failure to raise such issue within the prescribed time shall constitute your unqualified acceptance of the completeness of this report, the tests conducted and the correctness of the report contents. Unless specific mention, the uncertainty of measurement has been explicitly taken into account to declare the compliance or non-compliance to the specification. The report must not be used by the client to claim product certification, approval, or endorsement by TAF or any government agencies.

Table of Contents

Release Control Record	4
1 Certificate of Conformity	5
2 Summary of Test Results	6
2.1 Measurement Uncertainty	6
2.2 Modification Record	6
3 General Information	7
3.1 General Description of EUT	7
3.2 Description of Test Modes	10
3.2.1 Test Mode Applicability and Tested Channel Detail	11
3.3 Duty Cycle of Test Signal	13
3.4 Description of Support Units	14
3.5 Configuration of System under Test	15
3.6 General Description of Applied Standard	16
4 Test Types and Results	17
4.1 Radiated Emission and Bandedge Measurement	17
4.1.1 Limits of Radiated Emission and Bandedge Measurement	17
4.1.2 Test Instruments	18
4.1.3 Test Procedure	20
4.1.4 Deviation from Test Standard	20
4.1.5 Test Setup	21
4.1.6 EUT Operating Condition	22
4.1.7 Test Results	23
4.2 Conducted Emission Measurement	42
4.2.1 Limits of Conducted Emission Measurement	42
4.2.2 Test Instruments	42
4.2.3 Test Procedure	43
4.2.4 Deviation from Test Standard	43
4.2.5 Test Setup	43
4.2.6 EUT Operating Condition	43
4.2.7 Test Results (Mode 1)	44
4.2.8 Test Results (Mode 2)	46
4.3 Transmit Power Measurement	48
4.3.1 Limits of Transmit Power Measurement	48
4.3.2 Test Setup	48
4.3.3 Test Instruments	48
4.3.4 Test Procedure	48
4.3.5 Deviation from Test Standard	48
4.3.6 EUT Operating Condition	48
4.3.7 Test Result	49
4.4 Occupied Bandwidth Measurement	52
4.4.1 Test Setup	52
4.4.2 Test Instruments	52
4.4.3 Test Procedure	52
4.4.4 Test Results	53
4.5 Peak Power Spectral Density Measurement	60
4.5.1 Limits of Peak Power Spectral Density Measurement	60
4.5.2 Test Setup	60
4.5.3 Test Instruments	60
4.5.4 Test Procedure	61
4.5.5 Deviation from Test Standard	61
4.5.6 EUT Operating Condition	61
4.5.7 Test Results	62
4.6 Frequency Stability Measurement	69

4.6.1	Limits of Frequency Stability Measurement	69
4.6.2	Test Setup.....	69
4.6.3	Test Instruments	69
4.6.4	Test Procedure	69
4.6.5	Deviation from Test Standard	69
4.6.6	EUT Operating Condition	69
4.6.7	Test Results	70
4.7	6dB Bandwidth Measurement	71
4.7.1	Limits of 6dB Bandwidth Measurement.....	71
4.7.2	Test Setup.....	71
4.7.3	Test Instruments	71
4.7.4	Test Procedure	71
4.7.5	Deviation from Test Standard	71
4.7.6	EUT Operating Condition	71
4.7.7	Test Results	72
5	Pictures of Test Arrangements.....	74
	Annex A- Radiated Out of Band Emission (OOBE) Measurement (For U-NII-3 band)	75
	Appendix – Information on the Testing Laboratories	78

Release Control Record

Issue No.	Description	Date Issued
RF170220E09-1	Original release.	June 21, 2017

1 Certificate of Conformity

Product: Wave 2 WiFi Router

Brand: Ubee

Test Model: RAC2V1U

Sample Status: ENGINEERING SAMPLE

Applicant: Ubee Interactive Corp.

Test Date: Mar. 01 to Apr. 26, 2017

Standard: 47 CFR FCC Part 15, Subpart E (Section 15.407)
ANSI C63.10: 2013

The above equipment has been tested by **Bureau Veritas Consumer Products Services (H.K.) Ltd., Taoyuan Branch**, and found compliance with the requirement of the above standards. The test record, data evaluation & Equipment Under Test (EUT) configurations represented herein are true and accurate accounts of the measurements of the sample's EMC characteristics under the conditions specified in this report.

Prepared by : Cindy Hsin , **Date:** June 21, 2017
Cindy Hsin / Specialist

Approved by : May Chen , **Date:** June 21, 2017
May Chen / Manager

2 Summary of Test Results

47 CFR FCC Part 15, Subpart E (Section 15.407)			
FCC Clause	Test Item	Result	Remarks
15.407(b)(6)	AC Power Conducted Emissions	Pass	Meet the requirement of limit. Minimum passing margin is -13.55dB at 0.17344MHz.
15.407(b) (1/2/3/4(i/ii)/6)	Radiated Emissions & Band Edge Measurement*	Pass	Meet the requirement of limit. Minimum passing margin is -0.1dB at 6033.00MHz. 11570.00MHz. 5361.00MHz. 5651.03MHz. 6074.00MHz.
15.407(a)(1/2/3)	Max Average Transmit Power	Pass	Meet the requirement of limit.
---	Occupied Bandwidth Measurement	-	Reference only.
15.407(a)(1/2/3)	Peak Power Spectral Density	Pass	Meet the requirement of limit.
15.407(e)	6dB bandwidth	Pass	Meet the requirement of limit. (U-NII-3 Band only)
15.407(g)	Frequency Stability	Pass	Meet the requirement of limit.
15.203	Antenna Requirement	Pass	Antenna connector is i-pex(MHF) not a standard connector.

*For U-NII-3 band compliance with rule part 15.407(b)(4)(i), the OOB test plots were recorded in Annex A.

2.1 Measurement Uncertainty

Where relevant, the following measurement uncertainty levels have been estimated for tests performed on the EUT as specified in CISPR 16-4-2:

Measurement	Frequency	Expanded Uncertainty (k=2) (±)
Conducted Emissions at mains ports	150kHz ~ 30MHz	1.84 dB
Radiated Emissions up to 1 GHz	30MHz ~ 1GHz	5.34 dB
Radiated Emissions above 1 GHz	1GHz ~ 6GHz	3.41 dB
	6GHz ~ 18GHz	3.49 dB
	18GHz ~ 40GHz	3.30 dB

2.2 Modification Record

There were no modifications required for compliance.

3 General Information

3.1 General Description of EUT

Product	Wave 2 WiFi Router
Brand	Ubee
Test Model	RAC2V1U
Status of EUT	ENGINEERING SAMPLE
Power Supply Rating	12Vdc from power adapter
Modulation Type	CCK, DQPSK, DBPSK for DSSS 64QAM, 16QAM, QPSK, BPSK for OFDM 256QAM for OFDM in 11ac mode only
Modulation Technology	DSSS, OFDM
Transfer Rate	802.11b: up to 11Mbps 802.11a/g: up to 54Mbps 802.11n: up to 600Mbps 802.11ac: up to 1733.3Mbps
Operating Frequency	2.4GHz: 2.412 ~ 2.462GHz 5GHz: 5.18 ~ 5.24GHz, 5.745 ~ 5.825GHz
Number of Channel	2.4GHz: 802.11b, 802.11g, 802.11n (HT20): 11 802.11n (HT40): 7 5GHz: 802.11a, 802.11n (HT20), 802.11ac (VHT20): 9 802.11n (HT40), 802.11ac (VHT40): 4 802.11ac (VHT80): 2
Output Power	2.4GHz: 995.285mW 5GHz: 5.18 ~ 5.24GHz: CDD Mode: 325.677mW Beamforming Mode: 325.677mW 5.745 ~ 5.825GHz: CDD Mode: 986.213mW Beamforming Mode: 323.806mW
Antenna Type	Refer to Note
Antenna Connector	Refer to Note
Accessory Device	Adapter x 1
Data Cable Supplied	Ethernet Cable x 1 (1m)

Note:

1. Simultaneously transmission condition.

Condition	Technology	
1	WLAN 2.4GHz	WLAN 5GHz

Note: The emission of the simultaneous operation has been evaluated and no non-compliance was found.

2. The EUT must be supplied with a power adapter and following different models could be chosen as following table:

No	Brand	Model No.	Spec.
1	DVE	DSA-36PFH-12 FUS 120300	Input: 90-264Vac, 1A, 47-63Hz Output: 12V, 3A DC output cable(unshielded, 1.5m)
2	DVE	DSA-30PFG-12 FUS 120250	Input: 100-240Vac, 0.8A, 50/60Hz Output: 12V, 2.5A DC output cable(unshielded, 1.5m)

Note: From the above adapters, the radiated emissions worse case was found in Adapter 1. Therefore only the test data of the mode was recorded in this report.

3. The antennas provided to the EUT, please refer to the following table:

2.4GHz Band							
Antenna No.	Brand	Model	Antenna Net. Gain(dBi)	Frequency range (GHz)	Antenna Type	Connector Type	Cable Length (mm)
1	FOXCONN	ANTP2M1-CZZ0R-EF	4.5	2.4~2.4835	Dipole	i-pex(MHF)	248
2	FOXCONN	ANTP2M1-CZZ0S-EF	4.9	2.4~2.4835			200
3	FOXCONN	ANTP2M1-CZZ0P-EF	4.53	2.4~2.4835			70
5GHz Band							
Antenna No.	Brand	Model	Antenna Net. Gain(dBi)	Frequency range (GHz)	Antenna Type	Connector Type	Cable Length
1	FOXCONN	ANTP2M1-CZZ0M-EF	4.37	5.15~5.25	Dipole	i-pex(MHF)	78
			4.47	5.25~5.35			
			4.5	5.47~5.725			
			4.73	5.725~5.85			
2	FOXCONN	ANTP2M1-CZZ0Q-EF	5.06	5.15~5.25	Dipole	i-pex(MHF)	133
			5.35	5.25~5.35			
			5.18	5.47~5.725			
			5.36	5.725~5.85			
3	FOXCONN	ANTP2M1-CZZ0L-EF	5.35	5.15~5.25	Dipole	i-pex(MHF)	162
			4.20	5.25~5.35			
			3.54	5.47~5.725			
			3.41	5.725~5.85			
4	FOXCONN	ANTP2M1-CZZ0N-EF	4.53	5.15~5.25	Dipole	i-pex(MHF)	153
			4.88	5.25~5.35			
			5.53	5.47~5.725			
			5.69	5.725~5.85			

4. The EUT incorporates a MIMO function.

2.4GHz Band			
MODULATION MODE	DATA RATE (MCS)	TX & RX CONFIGURATION	
802.11b	1 ~ 11Mbps	3TX	3RX
802.11g	6 ~ 54Mbps	3TX	3RX
802.11n (HT20)	MCS 0~7	3TX	3RX
	MCS 8~15	3TX	3RX
	MCS 16~23	3TX	3RX
802.11n (HT40)	MCS 0~7	3TX	3RX
	MCS 8~15	3TX	3RX
	MCS 16~23	3TX	3RX
5GHz Band			
MODULATION MODE	DATA RATE (MCS)	TX & RX CONFIGURATION	
802.11a	6 ~ 54Mbps	4TX	4RX
802.11n (HT20)	MCS 0~7	4TX	4RX
	MCS 8~15	4TX	4RX
	MCS 16~23	4TX	4RX
	MCS 24~31	4TX	4RX
802.11n (HT40)	MCS 0~7	4TX	4RX
	MCS 8~15	4TX	4RX
	MCS 16~23	4TX	4RX
	MCS 24~31	4TX	4RX
802.11ac (VHT20)	MCS0~8 Nss=1	4TX	4RX
	MCS0~8 Nss=2	4TX	4RX
	MCS0~9 Nss=3	4TX	4RX
	MCS0~8 Nss=4	4TX	4RX
802.11ac (VHT40)	MCS0~9 Nss=1	4TX	4RX
	MCS0~9 Nss=2	4TX	4RX
	MCS0~9 Nss=3	4TX	4RX
	MCS0~9 Nss=4	4TX	4RX
802.11ac (VHT80)	MCS0~9 Nss=1	4TX	4RX
	MCS0~9 Nss=2	4TX	4RX
	MCS0~9 Nss=3	4TX	4RX
	MCS0~9 Nss=4	4TX	4RX

Note:

- All of modulation mode support beamforming function except 2.4GHz and 802.11a modulation mode.
 - The modulation and bandwidth are similar for 802.11n mode for 20MHz (40MHz) and 802.11ac mode for 20MHz (40MHz), therefore investigated worst case to representative mode in test report. (Final test mode refer section 3.2.1)
 - The EUT support Beamforming and CDD mode, therefore both mode were investigated and the worst case scenario was identified. The worst case data were presented in test report.
5. The above EUT information is declared by manufacturer and for more detailed features description, please refer to the manufacturer's specifications or user's manual.

3.2 Description of Test Modes

FOR 5180 ~ 5240MHz

4 channels are provided for 802.11a, 802.11n (HT20), 802.11ac (VHT20):

Channel	Frequency	Channel	Frequency
36	5180MHz	44	5220MHz
40	5200MHz	48	5240MHz

2 channels are provided for 802.11n (HT40), 802.11ac (VHT40):

Channel	Frequency	Channel	Frequency
38	5190MHz	46	5230MHz

1 channel is provided for 802.11ac (VHT80):

Channel	Frequency
42	5210MHz

FOR 5745 ~ 5825MHz:

5 channels are provided for 802.11a, 802.11n (HT20), 802.11ac (VHT20):

Channel	Frequency	Channel	Frequency
149	5745MHz	161	5805MHz
153	5765MHz	165	5825MHz
157	5785MHz		

2 channels are provided for 802.11n (HT40), 802.11ac (VHT40):

Channel	Frequency	Channel	Frequency
151	5755MHz	159	5795MHz

1 channel is provided for 802.11ac (VHT80):

Channel	Frequency
155	5775MHz

3.2.1 Test Mode Applicability and Tested Channel Detail

EUT Configure Mode	Applicable To				Description
	RE \geq 1G	RE<1G	PLC	APCM	
1	√	√	√	√	Adapter 1
2	-	-	√	-	Adapter 2

Where **RE \geq 1G**: Radiated Emission above 1GHz **RE<1G**: Radiated Emission below 1GHz
PLC: Power Line Conducted Emission **APCM**: Antenna Port Conducted Measurement

Radiated Emission Test (Above 1GHz):

- Pre-Scan has been conducted to determine the worst-case mode from all possible combinations between available modulations, data rates and antenna ports (if EUT with antenna diversity architecture).
- Following channel(s) was (were) selected for the final test as listed below.

CDD Mode						
Mode	FREQ. Band (MHz)	Available Channel	Tested Channel	Modulation Technology	Modulation Type	Data Rate (Mbps)
802.11a	5180-5240	36 to 48	36, 40, 48	OFDM	BPSK	6
802.11ac (VHT20)		36 to 48	36, 40, 48	OFDM	BPSK	6.5
802.11ac (VHT40)		38 to 46	38, 46	OFDM	BPSK	13.5
802.11ac (VHT80)		42	42	OFDM	BPSK	29.3
802.11a	5745-5825	149 to 165	149, 157, 165	OFDM	BPSK	6
802.11ac (VHT20)		149 to 165	149, 157, 165	OFDM	BPSK	6.5
802.11ac (VHT40)		151 to 159	151, 159	OFDM	BPSK	13.5
802.11ac (VHT80)		155	155	OFDM	BPSK	29.3

Radiated Emission Test (Below 1GHz):

- Pre-Scan has been conducted to determine the worst-case mode from all possible combinations between available modulations, data rates and antenna ports (if EUT with antenna diversity architecture).
- Following channel(s) was (were) selected for the final test as listed below.

CDD Mode						
Mode	FREQ. Band (MHz)	Available Channel	Tested Channel	Modulation Technology	Modulation Type	Data Rate (Mbps)
802.11a	5180-5240 5745-5825	36 to 48 149 to 165	157	OFDM	BPSK	6

Power Line Conducted Emission Test:

- Pre-Scan has been conducted to determine the worst-case mode from all possible combinations between available modulations, data rates and antenna ports (if EUT with antenna diversity architecture).
- Following channel(s) was (were) selected for the final test as listed below.

CDD Mode						
Mode	FREQ. Band (MHz)	Available Channel	Tested Channel	Modulation Technology	Modulation Type	Data Rate (Mbps)
802.11a	5180-5240 5745-5825	36 to 48 149 to 165	157	OFDM	BPSK	6

Antenna Port Conducted Measurement:

- This item includes all test value of each mode, but only includes spectrum plot of worst value of each mode.
- Pre-Scan has been conducted to determine the worst-case mode from all possible combinations between available modulations, data rates and antenna ports (if EUT with antenna diversity architecture).
- Following channel(s) was (were) selected for the final test as listed below.

CDD Mode						
Mode	FREQ. Band (MHz)	Available Channel	Tested Channel	Modulation Technology	Modulation Type	Data Rate (Mbps)
802.11a	5180-5240	36 to 48	36, 40, 48	OFDM	BPSK	6
802.11ac (VHT20)		36 to 48	36, 40, 48	OFDM	BPSK	6.5
802.11ac (VHT40)		38 to 46	38, 46	OFDM	BPSK	13.5
802.11ac (VHT80)		42	42	OFDM	BPSK	29.3
802.11a	5745-5825	149 to 165	149, 157, 165	OFDM	BPSK	6
802.11ac (VHT20)		149 to 165	149, 157, 165	OFDM	BPSK	6.5
802.11ac (VHT40)		151 to 159	151, 159	OFDM	BPSK	13.5
802.11ac (VHT80)		155	155	OFDM	BPSK	29.3
Beamforming Mode (Output power only)						
Mode	FREQ. Band (MHz)	Available Channel	Tested Channel	Modulation Technology	Modulation Type	Data Rate (Mbps)
802.11ac (VHT20)	5180-5240	36 to 48	36, 40, 48	OFDM	BPSK	6.5
802.11ac (VHT40)		38 to 46	38, 46	OFDM	BPSK	13.5
802.11ac (VHT80)		42	42	OFDM	BPSK	29.3
802.11ac (VHT20)	5745-5825	149 to 165	149, 157, 165	OFDM	BPSK	6.5
802.11ac (VHT40)		151 to 159	151, 159	OFDM	BPSK	13.5
802.11ac (VHT80)		155	155	OFDM	BPSK	29.3

Test Condition:

Applicable To	Environmental Conditions	Input Power	Tested By
RE \geq 1G	23deg. C, 66%RH	120Vac, 60Hz	Terry Huang
RE<1G	23deg. C, 66%RH	120Vac, 60Hz	JyunChun.Lin
PLC	24deg. C, 60%RH	120Vac, 60Hz	Andy Ho
APCM	24deg. C, 63%RH	120Vac, 60Hz	Robert Cheng

3.3 Duty Cycle of Test Signal

If duty cycle of test signal is $\geq 98\%$, duty factor is not required.

If duty cycle of test signal is $< 98\%$, duty factor shall be considered.

802.11a: Duty cycle = $2.062 \text{ ms} / 2.112 \text{ ms} = 0.976$, Duty factor = $10 * \log(1/0.976) = 0.1$

802.11ac (VHT20): Duty cycle = $1.926 \text{ ms} / 1.957 \text{ ms} = 0.984$

802.11ac (VHT40): Duty cycle = $0.951 \text{ ms} / 0.981 \text{ ms} = 0.969$, Duty factor = $10 * \log(1/0.969) = 0.13$

802.11ac (VHT80): Duty cycle = $0.459 \text{ ms} / 0.492 \text{ ms} = 0.933$, Duty factor = $10 * \log(1/0.933) = 0.3$

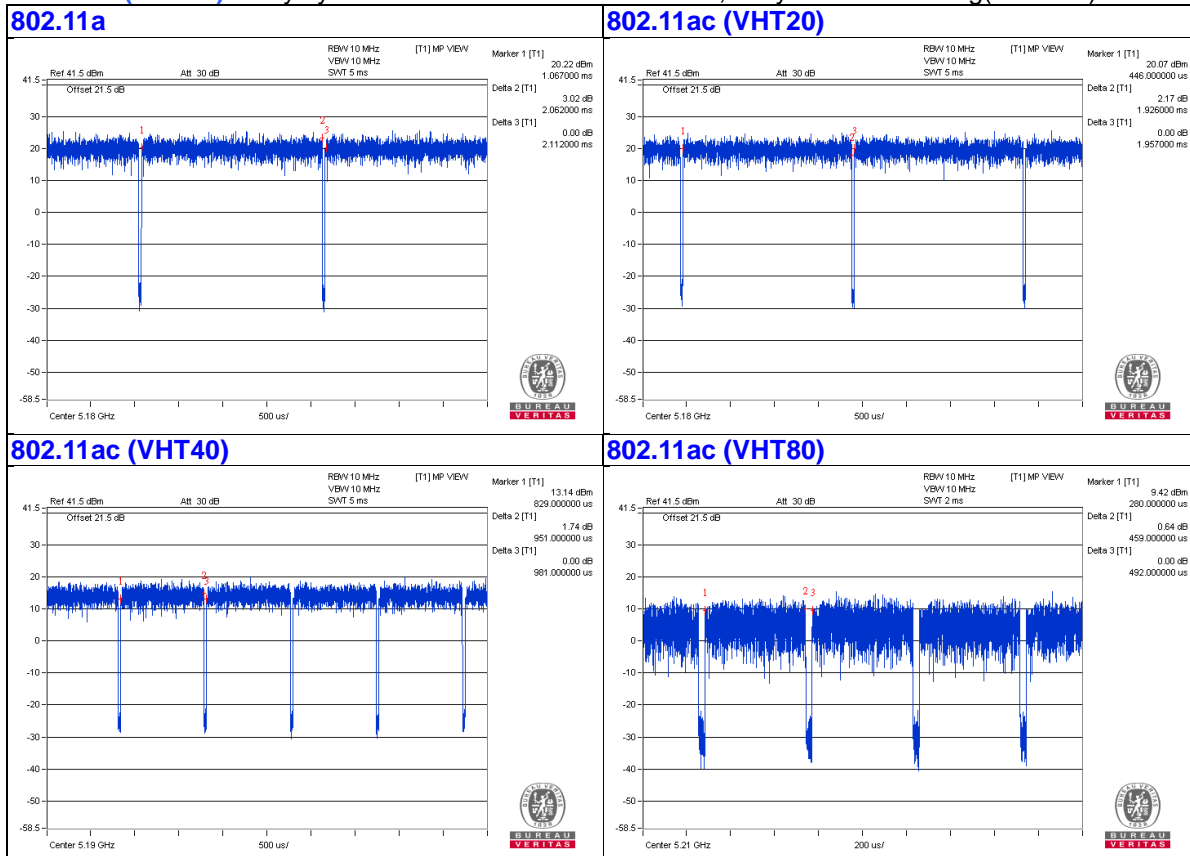

3.4 Description of Support Units

The EUT has been tested as an independent unit together with other necessary accessories or support units. The following support units or accessories were used to form a representative test configuration during the tests.

ID	Product	Brand	Model No.	Serial No.	FCC ID	Remarks
A.	Laptop	DELL	E5430	HYV4VY1	FCC DoC	Provided by Lab
B.	USB 3.0 Disk	NA	NA	NA	NA	Provided by Lab
C.	Laptop	DELL	E5430	4YV4VY1	FCC DoC	Provided by Lab

Note:

1. All power cords of the above support units are non-shielded (1.8m).

ID	Descriptions	Qty.	Length (m)	Shielding (Yes/No)	Cores (Qty.)	Remarks
1.	DC Cable	1	1.5	No	0	Supplied by client
2.	RJ-45 Cable	1	10	No	0	Provided by Lab
3.	RJ-45 Cable	1	10	No	0	Provided by Lab

3.5 Configuration of System under Test

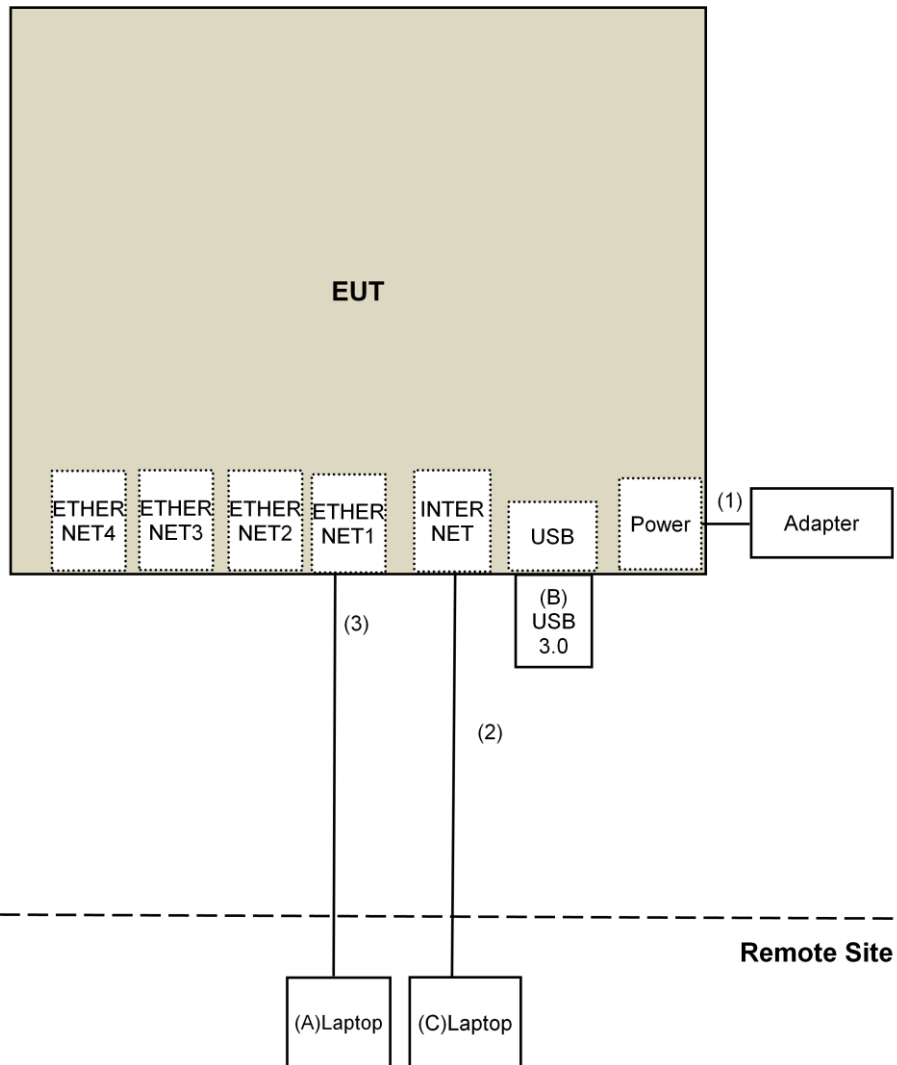

3.6 General Description of Applied Standard

The EUT is a RF Product. According to the specifications of the manufacturer, it must comply with the requirements of the following standards:

FCC Part 15, Subpart E (15.407)
KDB 789033 D02 General UNII Test Procedure New Rules v01r04
KDB 662911 D01 Multiple Transmitter Output v02r01
ANSI C63.10-2013

All test items have been performed and recorded as per the above standards.

NOTE: The EUT has been verified to comply with the requirements of FCC Part 15, Subpart B, Class B (DoC). The test report has been issued separately.

4 Test Types and Results

4.1 Radiated Emission and Bandedge Measurement

4.1.1 Limits of Radiated Emission and Bandedge Measurement

Radiated emissions which fall in the restricted bands must comply with the radiated emission limits specified as below table.

Frequencies (MHz)	Field Strength (microvolts/meter)	Measurement Distance (meters)
0.009 ~ 0.490	2400/F(kHz)	300
0.490 ~ 1.705	24000/F(kHz)	30
1.705 ~ 30.0	30	30
30 ~ 88	100	3
88 ~ 216	150	3
216 ~ 960	200	3
Above 960	500	3

NOTE:

1. The lower limit shall apply at the transition frequencies.
2. Emission level (dBuV/m) = 20 log Emission level (uV/m).
3. For frequencies above 1000MHz, the field strength limits are based on average detector, however, the peak field strength of any emission shall not exceed the maximum permitted average limits, specified above by more than 20dB under any condition of modulation.

Limits of unwanted emission out of the restricted bands

Applicable To		Limit	
789033 D02 General UNII Test Procedure New Rules v01r03		Field Strength at 3m	
		PK:74 (dBuV/m)	AV:54 (dBuV/m)
Frequency Band	Applicable To	EIRP Limit	Equivalent Field Strength at 3m
5150~5250 MHz	15.407(b)(1)	PK:-27 (dBm/MHz)	PK:68.2(dBuV/m)
5250~5350 MHz	15.407(b)(2)		
5470~5725 MHz	15.407(b)(3)		
5725~5850 MHz	<input checked="" type="checkbox"/> 15.407(b)(4)(i)	PK:-27 (dBm/MHz) ^{*1} PK:10 (dBm/MHz) ^{*2} PK:15.6 (dBm/MHz) ^{*3} PK:27 (dBm/MHz) ^{*4}	PK: 68.2(dBuV/m) ^{*1} PK:105.2 (dBuV/m) ^{*2} PK: 110.8(dBuV/m) ^{*3} PK:122.2 (dBuV/m) ^{*4}
	<input type="checkbox"/> 15.407(b)(4)(ii)	Emission limits in section 15.247(d)	
^{*1} beyond 75 MHz or more above of the band edge.		^{*2} below the band edge increasing linearly to 10 dBm/MHz at 25 MHz above.	
^{*3} below the band edge increasing linearly to a level of 15.6 dBm/MHz at 5 MHz above.		^{*4} from 5 MHz above or below the band edge increasing linearly to a level of 27 dBm/MHz at the band edge.	

Note:

The following formula is used to convert the equipment isotropic radiated power (eirp) to field strength:

$$E = \frac{1000000\sqrt{30P}}{3} \mu\text{V/m, where P is the eirp (Watts).}$$

4.1.2 Test Instruments

DESCRIPTION & MANUFACTURER	MODEL NO.	SERIAL NO.	CALIBRATED DATE	CALIBRATED UNTIL
Test Receiver Keysight	N9038A	MY54450088	July 20, 2016	July 19, 2017
Pre-Amplifier ^(*) EMCI	EMC001340	980142	Jan. 20, 2016	Jan. 19, 2018
Loop Antenna ^(*) Electro-Metrics	EM-6879	264	Dec. 16, 2016	Dec. 15, 2018
RF Cable	NA	LOOPCAB-001 LOOPCAB-002	Jan. 17, 2017	Jan. 16, 2018
Pre-Amplifier Mini-Circuits	ZFL-1000VH2B	AMP-ZFL-01	Nov. 10, 2016	Nov. 09, 2017
Trilog Broadband Antenna SCHWARZBECK	VULB 9168	9168-406	Dec. 13, 2016	Dec. 12, 2017
RF Cable	8D	966-4-1 966-4-2 966-4-3	Apr. 02, 2016	Apr. 01, 2017
Fixed attenuator Mini-Circuits	UNAT-5+	PAD-3m-4-01	Oct. 05, 2016	Oct. 04, 2017
Horn_Antenna SCHWARZBECK	BBHA 9120D	9120D-783	Dec. 27, 2016	Dec. 26, 2017
Pre-Amplifier EMCI	EMC12630SE	980385	Feb. 02, 2017	Feb. 01, 2018
RF Cable	EMC104-SM-SM-2000 EMC104-SM-SM-5000 EMC104-SM-SM-5000	160923 150318 150323	Feb. 02, 2017 Mar. 30, 2016 Mar. 30, 2016	Feb. 01, 2018 Mar. 29, 2017 Mar. 29, 2017
Pre-Amplifier EMCI	EMC184045SE	980387	Feb. 02, 2017	Feb. 01, 2018
Horn_Antenna SCHWARZBECK	BBHA 9170	BBHA9170608	Dec. 15, 2016	Dec. 14, 2017
RF Cable	SUCOFLEX 102	36432/2 36433/2	Jan. 15, 2017	Jan. 14, 2018
Software	ADT_Radiated_V8.7.08	NA	NA	NA
Antenna Tower & Turn Table Max-Full	MF-7802	MF780208410	NA	NA
Boresight Antenna Fixture	FBA-01	FBA-SIP02	NA	NA
Spectrum Analyzer R&S	FSV40	100964	June 28, 2016	June 27, 2017
Power meter Anritsu	ML2495A	1014008	May 5, 2016	May 4, 2017
Power sensor Anritsu	MA2411B	0917122	May 5, 2016	May 4, 2017
AC Power Source Extech Electronics	6205	1440452	NA	NA
Temperature & Humidity Chamber Giant Force	GTH-150-40-SP-AR	MAA0812-008	Jan. 11, 2017	Jan. 10, 2018
Digital Multimeter FLUKE	87III	73680266	Nov. 10, 2016	Nov. 09, 2017

Note:

1. The calibration interval of the above test instruments is 12 months and the calibrations are traceable to NML/ROC and NIST/USA.
2. *The calibration interval of the above test instruments is 24 months and the calibrations are traceable to NML/ROC and NIST/USA.
3. The test was performed in 966 Chamber No. 4.
4. The FCC Site Registration No. is 292998
5. The CANADA Site Registration No. is 20331-2
- 6 Loop antenna was used for all emissions below 30 MHz.
7. Tested Date: Mar. 17, 2017

4.1.3 Test Procedure

For Radiated emission below 30MHz

- a. The EUT was placed on the top of a rotating table 0.8 meters above the ground at a 3 meter chamber room. The table was rotated 360 degrees to determine the position of the highest radiation.
- b. The EUT was set 3 meters away from the interference-receiving antenna, which was mounted on the top of a variable-height antenna tower.
- c. Both X and Y axes of the antenna are set to make the measurement.
- d. For each suspected emission, the EUT was arranged to its worst case and the rotatable table was turned from 0 degrees to 360 degrees to find the maximum reading.
- e. The test-receiver system was set to Quasi-Peak Detect Function and Specified Bandwidth with Maximum Hold Mode.

NOTE:

1. The resolution bandwidth and video bandwidth of test receiver/spectrum analyzer is 9kHz at frequency below 30MHz.

For Radiated emission above 30MHz

- a. The EUT was placed on the top of a rotating table 0.8 meters (for 30MHz ~ 1GHz) / 1.5 meters (for above 1GHz) above the ground at 3 meter chamber room for test. The table was rotated 360 degrees to determine the position of the highest radiation.
- b. The EUT was set 3 meters away from the interference-receiving antenna, which was mounted on the top of a variable-height antenna tower.
- c. The height of antenna is varied from one meter to four meters above the ground to determine the maximum value of the field strength. Both horizontal and vertical polarizations of the antenna are set to make the measurement.
- d. For each suspected emission, the EUT was arranged to its worst case and then the antenna was tuned to heights from 1 meter to 4 meters and the rotatable table was turned from 0 degrees to 360 degrees to find the maximum reading.
- e. The test-receiver system was set to quasi-peak detect function and specified bandwidth with maximum hold mode when the test frequency is below 1 GHz.
- f. The test-receiver system was set to peak and average detect function and specified bandwidth with maximum hold mode when the test frequency is above 1 GHz. If the peak reading value also meets average limit, measurement with the average detector is unnecessary.

Note:

1. The resolution bandwidth and video bandwidth of test receiver/spectrum analyzer is 120kHz for Quasi-peak detection (QP) at frequency below 1GHz.
2. The resolution bandwidth of test receiver/spectrum analyzer is 1 MHz and the video bandwidth is 3 MHz for Peak detection (PK) at frequency above 1GHz.
3. The resolution bandwidth of test receiver/spectrum analyzer is 1MHz and the video bandwidth is $\geq 1/T$ (Duty cycle < 98%) or 10Hz (Duty cycle $\geq 98\%$) for Average detection (AV) at frequency above 1GHz.
4. All modes of operation were investigated and the worst-case emissions are reported.

4.1.4 Deviation from Test Standard

No deviation.

4.1.5 Test Setup

For Radiated emission below 30MHz

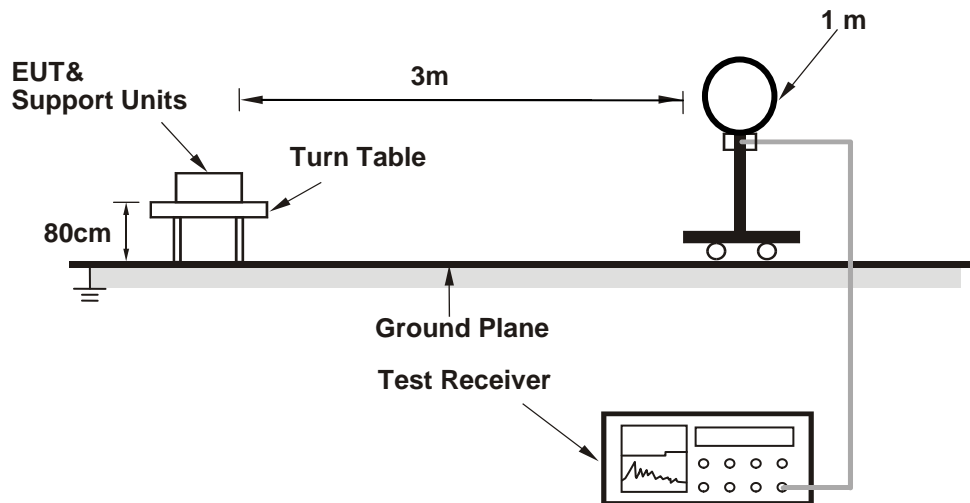

For Radiated emission 30MHz to 1GHz

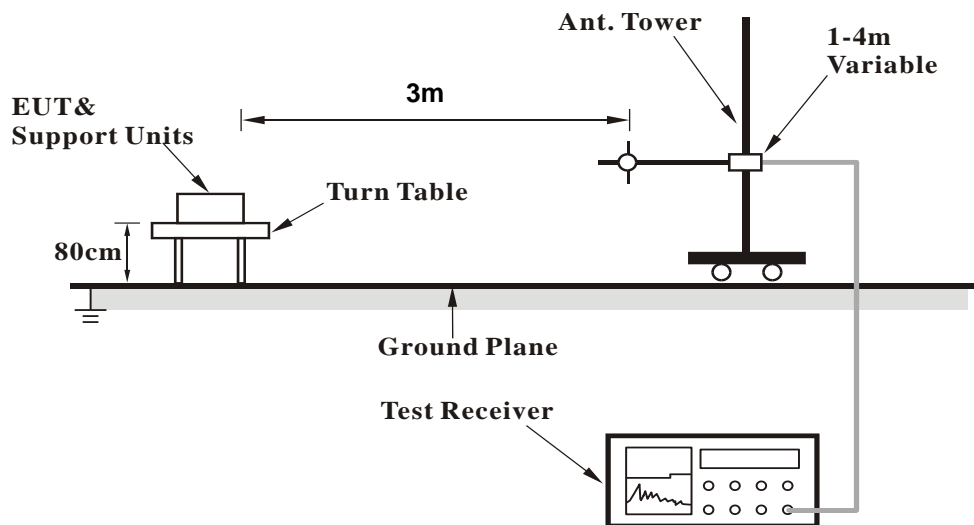

For Radiated emission above 1GHz

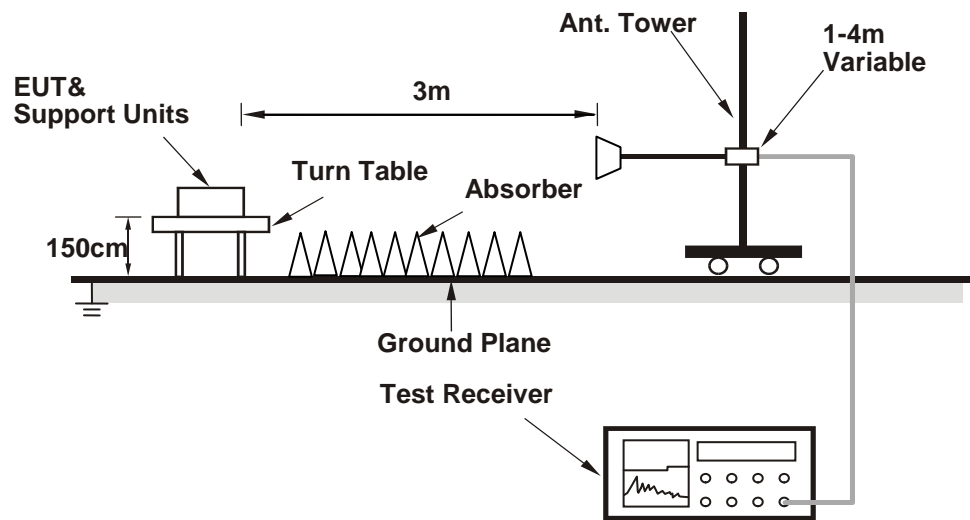

For the actual test configuration, please refer to the attached file (Test Setup Photo).

4.1.6 EUT Operating Condition

- a. Connected the EUT with the Laptop which is placed on remote site.
- b. Controlling software (Mtool 2.0.0.8) has been activated to set the EUT on specific status.

4.1.7 Test Results

Above 1GHz Data:

802.11a

CHANNEL	TX Channel 36	DETECTOR FUNCTION	Peak (PK)
FREQUENCY RANGE	1GHz ~ 40GHz		Average (AV)

ANTENNA POLARITY & TEST DISTANCE: HORIZONTAL AT 3 M

NO.	FREQ. (MHz)	EMISSION LEVEL (dBuV/m)	LIMIT (dBuV/m)	MARGIN (dB)	ANTENNA HEIGHT (m)	TABLE ANGLE (Degree)	RAW VALUE (dBuV)	CORRECTION FACTOR (dB/m)
1	5150.00	66.3 PK	74.0	-7.7	1.29 H	346	63.4	2.9
2	5150.00	46.1 AV	54.0	-7.9	1.29 H	346	43.2	2.9
3	*5180.00	110.7 PK			1.31 H	343	107.7	3.0
4	*5180.00	100.5 AV			1.31 H	343	97.5	3.0
5	#5755.00	50.3 PK	68.2	-17.9	3.43 H	234	46.3	4.0
6	#6906.00	54.1 PK	68.2	-14.1	3.10 H	334	46.9	7.2
7	#10360.00	59.3 PK	68.2	-8.9	1.47 H	230	47.4	11.9
8	15540.00	49.7 PK	74.0	-24.3	1.51 H	262	37.5	12.2
9	15540.00	36.5 AV	54.0	-17.5	1.51 H	262	24.3	12.2

ANTENNA POLARITY & TEST DISTANCE: VERTICAL AT 3 M

NO.	FREQ. (MHz)	EMISSION LEVEL (dBuV/m)	LIMIT (dBuV/m)	MARGIN (dB)	ANTENNA HEIGHT (m)	TABLE ANGLE (Degree)	RAW VALUE (dBuV)	CORRECTION FACTOR (dB/m)
1	5150.00	70.4 PK	74.0	-3.6	1.50 V	201	67.5	2.9
2	5150.00	52.2 AV	54.0	-1.8	1.50 V	201	49.3	2.9
3	*5180.00	115.4 PK			1.50 V	201	112.4	3.0
4	*5180.00	106.1 AV			1.50 V	201	103.1	3.0
5	#5755.00	56.5 PK	68.2	-11.7	2.66 V	234	52.5	4.0
6	#6906.00	59.9 PK	68.2	-8.3	1.82 V	234	52.7	7.2
7	#10360.00	63.4 PK	68.2	-4.8	2.29 V	237	51.5	11.9
8	15540.00	50.3 PK	74.0	-23.7	1.51 V	182	38.1	12.2
9	15540.00	37.1 AV	54.0	-16.9	1.51 V	182	24.9	12.2

REMARKS:

1. Emission Level(dBuV/m) = Raw Value(dBuV) + Correction Factor(dB/m)
2. Correction Factor(dB/m) = Antenna Factor(dB/m) + Cable Factor(dB) – Pre-Amplifier Factor(dB)
3. The other emission levels were very low against the limit.
4. Margin value = Emission Level – Limit value
5. " * ": Fundamental frequency.
6. " # ": The radiated frequency is out of the restricted band.

CHANNEL	TX Channel 40	DETECTOR FUNCTION	Peak (PK)
FREQUENCY RANGE	1GHz ~ 40GHz		Average (AV)

ANTENNA POLARITY & TEST DISTANCE: HORIZONTAL AT 3 M

NO.	FREQ. (MHz)	EMISSION LEVEL (dBuV/m)	LIMIT (dBuV/m)	MARGIN (dB)	ANTENNA HEIGHT (m)	TABLE ANGLE (Degree)	RAW VALUE (dBuV)	CORRECTION FACTOR (dB/m)
1	5150.00	59.5 PK	74.0	-14.5	1.30 H	345	56.6	2.9
2	5150.00	40.8 AV	54.0	-13.2	1.30 H	345	37.9	2.9
3	*5200.00	110.3 PK			1.30 H	345	107.3	3.0
4	*5200.00	100.4 AV			1.30 H	345	97.4	3.0
5	5354.00	54.2 PK	74.0	-19.8	1.30 H	345	50.8	3.4
6	5354.00	39.1 AV	54.0	-14.9	1.30 H	345	35.7	3.4
7	#6933.00	52.4 PK	68.2	-15.8	1.30 H	345	45.2	7.2
8	#10400.00	59.3 PK	68.2	-8.9	1.48 H	222	47.4	11.9
9	15600.00	49.8 PK	74.0	-24.2	1.52 H	269	37.5	12.3
10	15600.00	36.6 AV	54.0	-17.4	1.52 H	269	24.3	12.3

ANTENNA POLARITY & TEST DISTANCE: VERTICAL AT 3 M

NO.	FREQ. (MHz)	EMISSION LEVEL (dBuV/m)	LIMIT (dBuV/m)	MARGIN (dB)	ANTENNA HEIGHT (m)	TABLE ANGLE (Degree)	RAW VALUE (dBuV)	CORRECTION FACTOR (dB/m)
1	5150.00	63.5 PK	74.0	-10.5	1.39 V	193	60.6	2.9
2	5150.00	46.8 AV	54.0	-7.2	1.39 V	193	43.9	2.9
3	*5200.00	116.1 PK			1.45 V	199	113.1	3.0
4	*5200.00	106.5 AV			1.45 V	199	103.5	3.0
5	5354.00	60.0 PK	74.0	-14.0	1.39 V	193	56.6	3.4
6	5354.00	49.2 AV	54.0	-4.8	1.39 V	193	45.8	3.4
7	#6933.00	58.4 PK	68.2	-9.8	1.80 V	234	51.2	7.2
8	#10400.00	63.1 PK	68.2	-5.1	2.33 V	238	51.2	11.9
9	15600.00	49.7 PK	74.0	-24.3	1.46 V	173	37.4	12.3
10	15600.00	36.7 AV	54.0	-17.3	1.46 V	173	24.4	12.3

REMARKS:

- Emission Level(dBuV/m) = Raw Value(dBuV) + Correction Factor(dB/m)
- Correction Factor(dB/m) = Antenna Factor(dB/m) + Cable Factor(dB) – Pre-Amplifier Factor(dB)
- The other emission levels were very low against the limit.
- Margin value = Emission Level – Limit value
- " * ": Fundamental frequency.
- " # ": The radiated frequency is out of the restricted band.

CHANNEL	TX Channel 48	DETECTOR FUNCTION	Peak (PK)
FREQUENCY RANGE	1GHz ~ 40GHz		Average (AV)

ANTENNA POLARITY & TEST DISTANCE: HORIZONTAL AT 3 M

NO.	FREQ. (MHz)	EMISSION LEVEL (dBuV/m)	LIMIT (dBuV/m)	MARGIN (dB)	ANTENNA HEIGHT (m)	TABLE ANGLE (Degree)	RAW VALUE (dBuV)	CORRECTION FACTOR (dB/m)
1	5072.00	58.1 PK	74.0	-15.9	1.33 H	334	55.3	2.8
2	5072.00	45.8 AV	54.0	-8.2	1.33 H	334	43.0	2.8
3	*5240.00	110.6 PK			1.33 H	334	107.5	3.1
4	*5240.00	100.4 AV			1.33 H	334	97.3	3.1
5	5393.00	56.5 PK	74.0	-17.5	1.33 H	334	53.1	3.4
6	5393.00	51.6 AV	54.0	-2.4	1.33 H	334	48.2	3.4
7	#6986.00	53.5 PK	68.2	-14.7	1.33 H	334	46.1	7.4
8	#10480.00	58.8 PK	68.2	-9.4	1.52 H	241	46.9	11.9
9	15720.00	49.3 PK	74.0	-24.7	1.50 H	253	36.3	13.0
10	15720.00	36.3 AV	54.0	-17.7	1.50 H	253	23.3	13.0

ANTENNA POLARITY & TEST DISTANCE: VERTICAL AT 3 M

NO.	FREQ. (MHz)	EMISSION LEVEL (dBuV/m)	LIMIT (dBuV/m)	MARGIN (dB)	ANTENNA HEIGHT (m)	TABLE ANGLE (Degree)	RAW VALUE (dBuV)	CORRECTION FACTOR (dB/m)
1	5072.00	61.9 PK	74.0	-12.1	1.39 V	194	59.1	2.8
2	5072.00	51.7 AV	54.0	-2.3	1.39 V	194	48.9	2.8
3	*5240.00	115.7 PK			1.45 V	194	112.6	3.1
4	*5240.00	106.2 AV			1.45 V	194	103.1	3.1
5	5393.00	62.7 PK	74.0	-11.3	1.39 V	194	59.3	3.4
6	5393.00	52.8 AV	54.0	-1.2	1.39 V	194	49.4	3.4
7	#6986.00	59.7 PK	68.2	-8.5	1.86 V	234	52.3	7.4
8	#10480.00	63.1 PK	68.2	-5.1	2.27 V	250	51.2	11.9
9	15720.00	50.0 PK	74.0	-24.0	1.54 V	172	37.0	13.0
10	15720.00	36.7 AV	54.0	-17.3	1.54 V	172	23.7	13.0

REMARKS:

1. Emission Level(dBuV/m) = Raw Value(dBuV) + Correction Factor(dB/m)
2. Correction Factor(dB/m) = Antenna Factor(dB/m) + Cable Factor(dB) – Pre-Amplifier Factor(dB)
3. The other emission levels were very low against the limit.
4. Margin value = Emission Level – Limit value
5. " * ": Fundamental frequency.
6. " # ": The radiated frequency is out of the restricted band.

CHANNEL	TX Channel 149	DETECTOR FUNCTION	Peak (PK)
FREQUENCY RANGE	1GHz ~ 40GHz		Average (AV)

ANTENNA POLARITY & TEST DISTANCE: HORIZONTAL AT 3 M

NO.	FREQ. (MHz)	EMISSION LEVEL (dBuV/m)	LIMIT (dBuV/m)	MARGIN (dB)	ANTENNA HEIGHT (m)	TABLE ANGLE (Degree)	RAW VALUE (dBuV)	CORRECTION FACTOR (dB/m)
1	#5513.00	60.5 PK	68.2	-7.7	1.47 H	188	57.0	3.5
2	#5581.35	60.6 PK	68.2	-7.6	1.47 H	188	57.0	3.6
3	*5745.00	116.3 PK			1.47 H	188	112.3	4.0
4	*5745.00	106.5 AV			1.47 H	188	102.5	4.0
5	#5991.75	60.2 PK	68.2	-8.0	1.47 H	188	55.7	4.5
6	11490.00	61.7 PK	74.0	-12.3	1.57 H	231	48.9	12.8
7	11490.00	48.7 AV	54.0	-5.3	1.57 H	231	35.9	12.8
8	#17235.00	51.5 PK	68.2	-16.7	1.55 H	265	34.1	17.4

ANTENNA POLARITY & TEST DISTANCE: VERTICAL AT 3 M

NO.	FREQ. (MHz)	EMISSION LEVEL (dBuV/m)	LIMIT (dBuV/m)	MARGIN (dB)	ANTENNA HEIGHT (m)	TABLE ANGLE (Degree)	RAW VALUE (dBuV)	CORRECTION FACTOR (dB/m)
1	#5513.00	66.8 PK	68.2	-1.4	1.83 V	158	63.3	3.5
2	#5578.02	62.6 PK	68.2	-5.6	1.50 V	202	59.0	3.6
3	*5745.00	122.9 PK			1.50 V	202	118.9	4.0
4	*5745.00	113.6 AV			1.50 V	202	109.6	4.0
5	#5977.50	65.7 PK	68.2	-2.5	1.50 V	202	61.2	4.5
6	11490.00	65.8 PK	74.0	-8.2	1.40 V	232	53.0	12.8
7	11490.00	53.7 AV	54.0	-0.3	1.40 V	232	40.9	12.8
8	#17235.00	52.4 PK	68.2	-15.8	1.50 V	219	35.0	17.4

REMARKS:

1. Emission Level(dBuV/m) = Raw Value(dBuV) + Correction Factor(dB/m)
2. Correction Factor(dB/m) = Antenna Factor(dB/m) + Cable Factor(dB) – Pre-Amplifier Factor(dB)
3. The other emission levels were very low against the limit.
4. Margin value = Emission Level – Limit value
5. " * ": Fundamental frequency.
6. " # ": The radiated frequency is out of the restricted band.

CHANNEL	TX Channel 157	DETECTOR FUNCTION	Peak (PK)
FREQUENCY RANGE	1GHz ~ 40GHz		Average (AV)

ANTENNA POLARITY & TEST DISTANCE: HORIZONTAL AT 3 M

NO.	FREQ. (MHz)	EMISSION LEVEL (dBuV/m)	LIMIT (dBuV/m)	MARGIN (dB)	ANTENNA HEIGHT (m)	TABLE ANGLE (Degree)	RAW VALUE (dBuV)	CORRECTION FACTOR (dB/m)
1	#5538.00	57.2 PK	68.2	-11.0	1.47 H	182	53.8	3.4
2	#5538.00	50.3 AV	54.0	-3.7	1.47 H	182	46.9	3.4
3	#5627.90	60.5 PK	68.2	-7.7	1.47 H	182	56.7	3.8
4	*5785.00	115.9 PK			1.47 H	182	111.9	4.0
5	*5785.00	106.1 AV			1.47 H	182	102.1	4.0
6	#5939.02	60.9 PK	68.2	-7.3	1.47 H	182	56.6	4.3
7	#6033.00	61.8 PK	68.2	-6.4	1.47 H	182	57.4	4.4
8	#6427.00	53.6 PK	68.2	-14.6	1.47 H	182	48.0	5.6
9	11570.00	61.5 PK	74.0	-12.5	1.61 H	216	48.9	12.6
10	11570.00	48.4 AV	54.0	-5.6	1.61 H	216	35.8	12.6
11	#17355.00	51.9 PK	68.2	-16.3	1.53 H	253	33.8	18.1

ANTENNA POLARITY & TEST DISTANCE: VERTICAL AT 3 M

NO.	FREQ. (MHz)	EMISSION LEVEL (dBuV/m)	LIMIT (dBuV/m)	MARGIN (dB)	ANTENNA HEIGHT (m)	TABLE ANGLE (Degree)	RAW VALUE (dBuV)	CORRECTION FACTOR (dB/m)
1	#5536.00	63.3 PK	68.2	-4.9	1.50 V	216	59.9	3.4
2	#5536.00	52.1 AV	54.0	-1.9	1.50 V	216	48.7	3.4
3	#5617.93	63.8 PK	68.2	-4.4	1.50 V	211	60.1	3.7
4	*5785.00	122.6 PK			1.50 V	211	118.6	4.0
5	*5785.00	113.2 AV			1.50 V	211	109.2	4.0
6	#5939.98	66.7 PK	68.2	-1.5	1.50 V	211	62.4	4.3
7	#6033.00	68.1 PK	68.2	-0.1	1.82 V	229	63.7	4.4
8	#6427.00	56.0 PK	68.2	-12.2	1.50 V	267	50.4	5.6
9	11570.00	66.3 PK	74.0	-7.7	1.50 V	228	53.7	12.6
10	11570.00	53.9 AV	54.0	-0.1	1.50 V	228	41.3	12.6
11	#17355.00	52.4 PK	68.2	-15.8	1.51 V	208	34.3	18.1

REMARKS:

1. Emission Level(dBuV/m) = Raw Value(dBuV) + Correction Factor(dB/m)
2. Correction Factor(dB/m) = Antenna Factor(dB/m) + Cable Factor(dB) – Pre-Amplifier Factor(dB)
3. The other emission levels were very low against the limit.
4. Margin value = Emission Level – Limit value
5. " * ": Fundamental frequency.
6. " # ": The radiated frequency is out of the restricted band.

CHANNEL	TX Channel 165	DETECTOR FUNCTION	Peak (PK)
FREQUENCY RANGE	1GHz ~ 40GHz		Average (AV)

ANTENNA POLARITY & TEST DISTANCE: HORIZONTAL AT 3 M

NO.	FREQ. (MHz)	EMISSION LEVEL (dBuV/m)	LIMIT (dBuV/m)	MARGIN (dB)	ANTENNA HEIGHT (m)	TABLE ANGLE (Degree)	RAW VALUE (dBuV)	CORRECTION FACTOR (dB/m)
1	#5586.10	59.3 PK	68.2	-8.9	1.47 H	191	55.7	3.6
2	*5825.00	116.0 PK			1.47 H	191	111.9	4.1
3	*5825.00	106.1 AV			1.47 H	191	102.0	4.1
4	#5981.77	60.8 PK	68.2	-7.4	1.47 H	191	56.3	4.5
5	#6074.00	61.7 PK	74.0	-12.3	1.47 H	191	57.2	4.5
6	#6074.00	51.2 AV	54.0	-2.8	1.47 H	191	46.7	4.5
7	11650.00	61.6 PK	74.0	-12.4	1.60 H	217	48.9	12.7
8	11650.00	48.8 AV	54.0	-5.2	1.60 H	217	36.1	12.7
9	#17475.00	51.4 PK	74.0	-22.6	1.53 H	255	32.5	18.9
10	#17475.00	39.8 AV	54.0	-14.2	1.53 H	255	20.9	18.9

ANTENNA POLARITY & TEST DISTANCE: VERTICAL AT 3 M

NO.	FREQ. (MHz)	EMISSION LEVEL (dBuV/m)	LIMIT (dBuV/m)	MARGIN (dB)	ANTENNA HEIGHT (m)	TABLE ANGLE (Degree)	RAW VALUE (dBuV)	CORRECTION FACTOR (dB/m)
1	#5590.37	62.6 PK	68.2	-5.6	1.50 V	211	59.0	3.6
2	*5825.00	122.5 PK			1.50 V	211	118.4	4.1
3	*5825.00	113.0 AV			1.50 V	211	108.9	4.1
4	#5977.98	65.9 PK	68.2	-2.3	1.50 V	211	61.4	4.5
5	#6074.00	64.5 PK	74.0	-9.5	1.50 V	223	60.0	4.5
6	#6074.00	53.9 AV	54.0	-0.1	1.50 V	223	49.4	4.5
7	11650.00	66.0 PK	74.0	-8.0	1.56 V	217	53.3	12.7
8	11650.00	53.7 AV	54.0	-0.3	1.56 V	217	41.0	12.7
9	#17475.00	52.8 PK	74.0	-21.2	1.53 V	213	33.9	18.9
10	#17475.00	40.8 AV	54.0	-13.2	1.53 V	213	21.9	18.9

REMARKS:

1. Emission Level(dBuV/m) = Raw Value(dBuV) + Correction Factor(dB/m)
2. Correction Factor(dB/m) = Antenna Factor(dB/m) + Cable Factor(dB) – Pre-Amplifier Factor(dB)
3. The other emission levels were very low against the limit.
4. Margin value = Emission Level – Limit value
5. " * ": Fundamental frequency.
6. " # ": The radiated frequency is out of the restricted band.

802.11ac (VHT20)

CHANNEL	TX Channel 36	DETECTOR FUNCTION	Peak (PK)
FREQUENCY RANGE	1GHz ~ 40GHz		Average (AV)

ANTENNA POLARITY & TEST DISTANCE: HORIZONTAL AT 3 M

NO.	FREQ. (MHz)	EMISSION LEVEL (dBuV/m)	LIMIT (dBuV/m)	MARGIN (dB)	ANTENNA HEIGHT (m)	TABLE ANGLE (Degree)	RAW VALUE (dBuV)	CORRECTION FACTOR (dB/m)
1	5150.00	67.7 PK	74.0	-6.3	1.39 H	313	64.8	2.9
2	5150.00	45.7 AV	54.0	-8.3	1.39 H	313	42.8	2.9
3	*5180.00	112.9 PK			1.39 H	313	109.9	3.0
4	*5180.00	101.2 AV			1.39 H	313	98.2	3.0
5	#6906.00	53.8 PK	68.2	-14.4	1.39 H	313	46.6	7.2
6	#10360.00	57.8 PK	68.2	-10.4	1.51 H	236	45.9	11.9
7	15540.00	48.7 PK	74.0	-25.3	1.50 H	247	36.5	12.2
8	15540.00	35.2 AV	54.0	-18.8	1.50 H	247	23.0	12.2

ANTENNA POLARITY & TEST DISTANCE: VERTICAL AT 3 M

NO.	FREQ. (MHz)	EMISSION LEVEL (dBuV/m)	LIMIT (dBuV/m)	MARGIN (dB)	ANTENNA HEIGHT (m)	TABLE ANGLE (Degree)	RAW VALUE (dBuV)	CORRECTION FACTOR (dB/m)
1	5150.00	71.8 PK	74.0	-2.2	1.50 V	206	68.9	2.9
2	5150.00	51.8 AV	54.0	-2.2	1.50 V	206	48.9	2.9
3	*5180.00	118.1 PK			1.50 V	206	115.1	3.0
4	*5180.00	107.8 AV			1.50 V	206	104.8	3.0
5	#6906.00	59.6 PK	68.2	-8.6	1.50 V	206	52.4	7.2
6	#10360.00	62.2 PK	68.2	-6.0	2.33 V	220	50.3	11.9
7	15540.00	49.2 PK	74.0	-24.8	1.52 V	178	37.0	12.2
8	15540.00	36.1 AV	54.0	-17.9	1.52 V	178	23.9	12.2

REMARKS:

- Emission Level(dBuV/m) = Raw Value(dBuV) + Correction Factor(dB/m)
- Correction Factor(dB/m) = Antenna Factor(dB/m) + Cable Factor(dB) – Pre-Amplifier Factor(dB)
- The other emission levels were very low against the limit.
- Margin value = Emission Level – Limit value
- " * ": Fundamental frequency.
- " # ": The radiated frequency is out of the restricted band.

CHANNEL	TX Channel 40	DETECTOR FUNCTION	Peak (PK)
FREQUENCY RANGE	1GHz ~ 40GHz		Average (AV)

ANTENNA POLARITY & TEST DISTANCE: HORIZONTAL AT 3 M

NO.	FREQ. (MHz)	EMISSION LEVEL (dBuV/m)	LIMIT (dBuV/m)	MARGIN (dB)	ANTENNA HEIGHT (m)	TABLE ANGLE (Degree)	RAW VALUE (dBuV)	CORRECTION FACTOR (dB/m)
1	5150.00	63.8 PK	74.0	-10.2	1.43 H	308	60.9	2.9
2	5150.00	45.5 AV	54.0	-8.5	1.43 H	308	42.6	2.9
3	*5200.00	112.9 PK			1.43 H	308	109.9	3.0
4	*5200.00	101.1 AV			1.43 H	308	98.1	3.0
5	5354.00	58.9 PK	74.0	-15.1	1.43 H	308	55.5	3.4
6	5354.00	47.2 AV	54.0	-6.8	1.43 H	308	43.8	3.4
7	#6933.00	57.2 PK	68.2	-11.0	1.43 H	308	50.0	7.2
8	#10400.00	57.9 PK	68.2	-10.3	1.52 H	235	46.0	11.9
9	15600.00	48.7 PK	74.0	-25.3	1.47 H	253	36.4	12.3
10	15600.00	35.3 AV	54.0	-18.7	1.47 H	253	23.0	12.3

ANTENNA POLARITY & TEST DISTANCE: VERTICAL AT 3 M

NO.	FREQ. (MHz)	EMISSION LEVEL (dBuV/m)	LIMIT (dBuV/m)	MARGIN (dB)	ANTENNA HEIGHT (m)	TABLE ANGLE (Degree)	RAW VALUE (dBuV)	CORRECTION FACTOR (dB/m)
1	5150.00	68.2 PK	74.0	-5.8	1.36 V	202	65.3	2.9
2	5150.00	51.5 AV	54.0	-2.5	1.36 V	202	48.6	2.9
3	*5200.00	116.8 PK			1.36 V	202	113.8	3.0
4	*5200.00	107.1 AV			1.36 V	202	104.1	3.0
5	5354.00	63.4 PK	74.0	-10.6	1.36 V	202	60.0	3.4
6	5354.00	53.7 AV	54.0	-0.3	1.36 V	202	50.3	3.4
7	#6933.00	62.5 PK	68.2	-5.7	1.36 V	202	55.3	7.2
8	#10400.00	62.4 PK	68.2	-5.8	2.35 V	221	50.5	11.9
9	15600.00	49.2 PK	74.0	-24.8	1.52 V	170	36.9	12.3
10	15600.00	36.0 AV	54.0	-18.0	1.52 V	170	23.7	12.3

REMARKS:

- Emission Level(dBuV/m) = Raw Value(dBuV) + Correction Factor(dB/m)
- Correction Factor(dB/m) = Antenna Factor(dB/m) + Cable Factor(dB) – Pre-Amplifier Factor(dB)
- The other emission levels were very low against the limit.
- Margin value = Emission Level – Limit value
- " * ": Fundamental frequency.
- " # ": The radiated frequency is out of the restricted band.

CHANNEL	TX Channel 48	DETECTOR FUNCTION	Peak (PK)
FREQUENCY RANGE	1GHz ~ 40GHz		Average (AV)

ANTENNA POLARITY & TEST DISTANCE: HORIZONTAL AT 3 M

NO.	FREQ. (MHz)	EMISSION LEVEL (dBuV/m)	LIMIT (dBuV/m)	MARGIN (dB)	ANTENNA HEIGHT (m)	TABLE ANGLE (Degree)	RAW VALUE (dBuV)	CORRECTION FACTOR (dB/m)
1	5086.00	59.3 PK	74.0	-14.7	1.44 H	317	56.5	2.8
2	5086.00	45.4 AV	54.0	-8.6	1.44 H	317	42.6	2.8
3	*5240.00	112.9 PK			1.44 H	317	109.8	3.1
4	*5240.00	101.4 AV			1.44 H	317	98.3	3.1
5	5393.00	58.1 PK	74.0	-15.9	1.44 H	317	54.7	3.4
6	5393.00	46.6 AV	54.0	-7.4	1.44 H	317	43.2	3.4
7	#6986.00	55.9 PK	68.2	-12.3	1.44 H	317	48.5	7.4
8	#10480.00	57.9 PK	68.2	-10.3	1.53 H	231	46.0	11.9
9	15720.00	48.9 PK	74.0	-25.1	1.49 H	266	35.9	13.0
10	15720.00	35.5 AV	54.0	-18.5	1.49 H	266	22.5	13.0

ANTENNA POLARITY & TEST DISTANCE: VERTICAL AT 3 M

NO.	FREQ. (MHz)	EMISSION LEVEL (dBuV/m)	LIMIT (dBuV/m)	MARGIN (dB)	ANTENNA HEIGHT (m)	TABLE ANGLE (Degree)	RAW VALUE (dBuV)	CORRECTION FACTOR (dB/m)
1	5086.00	63.6 PK	74.0	-10.4	1.50 V	186	60.8	2.8
2	5086.00	51.5 AV	54.0	-2.5	1.50 V	186	48.7	2.8
3	*5240.00	117.9 PK			1.50 V	186	114.8	3.1
4	*5240.00	107.4 AV			1.50 V	186	104.3	3.1
5	5393.00	62.4 PK	74.0	-11.6	1.50 V	186	59.0	3.4
6	5393.00	52.6 AV	54.0	-1.4	1.50 V	186	49.2	3.4
7	#6986.00	60.7 PK	68.2	-7.5	1.50 V	186	53.3	7.4
8	#10480.00	62.2 PK	68.2	-6.0	2.37 V	207	50.3	11.9
9	15720.00	48.7 PK	74.0	-25.3	1.55 V	156	35.7	13.0
10	15720.00	35.7 AV	54.0	-18.3	1.55 V	156	22.7	13.0

REMARKS:

1. Emission Level(dBuV/m) = Raw Value(dBuV) + Correction Factor(dB/m)
2. Correction Factor(dB/m) = Antenna Factor(dB/m) + Cable Factor(dB) – Pre-Amplifier Factor(dB)
3. The other emission levels were very low against the limit.
4. Margin value = Emission Level – Limit value
5. " * ": Fundamental frequency.
6. " # ": The radiated frequency is out of the restricted band.

CHANNEL	TX Channel 149	DETECTOR FUNCTION	Peak (PK)
FREQUENCY RANGE	1GHz ~ 40GHz		Average (AV)

ANTENNA POLARITY & TEST DISTANCE: HORIZONTAL AT 3 M

NO.	FREQ. (MHz)	EMISSION LEVEL (dBuV/m)	LIMIT (dBuV/m)	MARGIN (dB)	ANTENNA HEIGHT (m)	TABLE ANGLE (Degree)	RAW VALUE (dBuV)	CORRECTION FACTOR (dB/m)
1	#5513.00	59.6 PK	68.2	-8.6	1.24 H	181	56.1	3.5
2	#5513.00	48.7 AV	54.0	-5.3	1.24 H	181	45.2	3.5
3	#5584.20	60.3 PK	68.2	-7.9	1.24 H	181	56.7	3.6
4	*5745.00	115.5 PK			1.24 H	181	111.5	4.0
5	*5745.00	106.1 AV			1.24 H	181	102.1	4.0
6	#5993.65	60.2 PK	68.2	-8.0	1.24 H	181	55.7	4.5
7	11490.00	62.1 PK	74.0	-11.9	1.57 H	228	49.3	12.8
8	11490.00	48.8 AV	54.0	-5.2	1.57 H	228	36.0	12.8
9	#17235.00	52.5 PK	68.2	-15.7	1.50 H	245	35.1	17.4

ANTENNA POLARITY & TEST DISTANCE: VERTICAL AT 3 M

NO.	FREQ. (MHz)	EMISSION LEVEL (dBuV/m)	LIMIT (dBuV/m)	MARGIN (dB)	ANTENNA HEIGHT (m)	TABLE ANGLE (Degree)	RAW VALUE (dBuV)	CORRECTION FACTOR (dB/m)
1	#5513.00	63.9 PK	68.2	-4.3	1.50 V	202	60.4	3.5
2	#5513.00	52.4 AV	54.0	-1.6	1.50 V	202	48.9	3.5
3	#5589.90	63.0 PK	68.2	-5.2	1.50 V	202	59.4	3.6
4	*5745.00	122.5 PK			1.50 V	202	118.5	4.0
5	*5745.00	112.6 AV			1.50 V	202	108.6	4.0
6	#5977.50	64.8 PK	68.2	-3.4	1.50 V	202	60.3	4.5
7	11490.00	66.7 PK	74.0	-7.3	1.76 V	300	53.9	12.8
8	11490.00	53.5 AV	54.0	-0.5	1.76 V	300	40.7	12.8
9	#17235.00	51.9 PK	68.2	-16.3	1.55 V	208	34.5	17.4

REMARKS:

1. Emission Level(dBuV/m) = Raw Value(dBuV) + Correction Factor(dB/m)
2. Correction Factor(dB/m) = Antenna Factor(dB/m) + Cable Factor(dB) – Pre-Amplifier Factor(dB)
3. The other emission levels were very low against the limit.
4. Margin value = Emission Level – Limit value
5. " * ": Fundamental frequency.
6. " # ": The radiated frequency is out of the restricted band.

CHANNEL	TX Channel 157	DETECTOR FUNCTION	Peak (PK)
FREQUENCY RANGE	1GHz ~ 40GHz		Average (AV)

ANTENNA POLARITY & TEST DISTANCE: HORIZONTAL AT 3 M

NO.	FREQ. (MHz)	EMISSION LEVEL (dBuV/m)	LIMIT (dBuV/m)	MARGIN (dB)	ANTENNA HEIGHT (m)	TABLE ANGLE (Degree)	RAW VALUE (dBuV)	CORRECTION FACTOR (dB/m)
1	#5538.00	60.7 PK	68.2	-7.5	1.47 H	182	57.3	3.4
2	#5627.90	60.7 PK	68.2	-7.5	1.47 H	182	56.9	3.8
3	*5785.00	115.4 PK			1.47 H	182	111.4	4.0
4	*5785.00	105.8 AV			1.47 H	182	101.8	4.0
5	#5947.10	60.5 PK	68.2	-7.7	1.47 H	182	56.2	4.3
6	#6033.00	61.5 PK	68.2	-6.7	1.47 H	182	57.1	4.4
7	11570.00	60.9 PK	74.0	-13.1	1.58 H	223	48.3	12.6
8	11570.00	48.0 AV	54.0	-6.0	1.58 H	223	35.4	12.6
9	#17355.00	51.8 PK	68.2	-16.4	1.49 H	259	33.7	18.1

ANTENNA POLARITY & TEST DISTANCE: VERTICAL AT 3 M

NO.	FREQ. (MHz)	EMISSION LEVEL (dBuV/m)	LIMIT (dBuV/m)	MARGIN (dB)	ANTENNA HEIGHT (m)	TABLE ANGLE (Degree)	RAW VALUE (dBuV)	CORRECTION FACTOR (dB/m)
1	#5538.00	65.0 PK	68.2	-3.2	1.98 V	252	61.6	3.4
2	#5632.18	63.0 PK	68.2	-5.2	1.50 V	202	59.2	3.8
3	*5785.00	122.6 PK			1.50 V	202	118.6	4.0
4	*5785.00	112.3 AV			1.50 V	202	108.3	4.0
5	#5942.35	65.3 PK	68.2	-2.9	1.50 V	202	61.0	4.3
6	#6033.00	66.1 PK	68.2	-2.1	1.98 V	252	61.7	4.4
7	11570.00	67.3 PK	74.0	-6.7	1.76 V	316	54.7	12.6
8	11570.00	53.7 AV	54.0	-0.3	1.76 V	316	41.1	12.6
9	#17355.00	51.9 PK	68.2	-16.3	1.53 V	217	33.8	18.1

REMARKS:

1. Emission Level(dBuV/m) = Raw Value(dBuV) + Correction Factor(dB/m)
2. Correction Factor(dB/m) = Antenna Factor(dB/m) + Cable Factor(dB) – Pre-Amplifier Factor(dB)
3. The other emission levels were very low against the limit.
4. Margin value = Emission Level – Limit value
5. " * ": Fundamental frequency.
6. " # ": The radiated frequency is out of the restricted band.

CHANNEL	TX Channel 165	DETECTOR FUNCTION	Peak (PK)
FREQUENCY RANGE	1GHz ~ 40GHz		Average (AV)

ANTENNA POLARITY & TEST DISTANCE: HORIZONTAL AT 3 M

NO.	FREQ. (MHz)	EMISSION LEVEL (dBuV/m)	LIMIT (dBuV/m)	MARGIN (dB)	ANTENNA HEIGHT (m)	TABLE ANGLE (Degree)	RAW VALUE (dBuV)	CORRECTION FACTOR (dB/m)
1	#5576.12	59.4 PK	68.2	-8.8	1.47 H	190	55.8	3.6
2	*5825.00	115.8 PK			1.47 H	190	111.7	4.1
3	*5825.00	105.2 AV			1.47 H	190	101.1	4.1
4	#5987.48	59.8 PK	68.2	-8.4	1.47 H	190	55.3	4.5
5	#6074.00	63.5 PK	68.2	-4.7	1.47 H	190	59.0	4.5
6	11650.00	61.6 PK	74.0	-12.4	1.57 H	203	48.9	12.7
7	11650.00	48.8 AV	54.0	-5.2	1.57 H	203	36.1	12.7
8	#17475.00	51.5 PK	68.2	-16.7	1.57 H	264	32.6	18.9

ANTENNA POLARITY & TEST DISTANCE: VERTICAL AT 3 M

NO.	FREQ. (MHz)	EMISSION LEVEL (dBuV/m)	LIMIT (dBuV/m)	MARGIN (dB)	ANTENNA HEIGHT (m)	TABLE ANGLE (Degree)	RAW VALUE (dBuV)	CORRECTION FACTOR (dB/m)
1	#5590.85	64.3 PK	68.2	-3.9	1.50 V	248	60.7	3.6
2	*5825.00	122.2 PK			1.50 V	202	118.1	4.1
3	*5825.00	112.0 AV			1.50 V	202	107.9	4.1
4	#5991.27	65.4 PK	68.2	-2.8	1.50 V	248	60.9	4.5
5	#6074.00	65.2 PK	68.2	-3.0	2.91 V	248	60.7	4.5
6	11650.00	67.8 PK	74.0	-6.2	1.80 V	328	55.1	12.7
7	11650.00	53.7 AV	54.0	-0.3	1.80 V	328	41.0	12.7
8	#17475.00	52.5 PK	68.2	-15.7	1.55 V	199	33.6	18.9

REMARKS:

1. Emission Level(dBuV/m) = Raw Value(dBuV) + Correction Factor(dB/m)
2. Correction Factor(dB/m) = Antenna Factor(dB/m) + Cable Factor(dB) – Pre-Amplifier Factor(dB)
3. The other emission levels were very low against the limit.
4. Margin value = Emission Level – Limit value
5. " * ": Fundamental frequency.
6. " # ": The radiated frequency is out of the restricted band.

802.11ac (VHT40)

CHANNEL	TX Channel 38	DETECTOR FUNCTION	Peak (PK)
FREQUENCY RANGE	1GHz ~ 40GHz		Average (AV)

ANTENNA POLARITY & TEST DISTANCE: HORIZONTAL AT 3 M

NO.	FREQ. (MHz)	EMISSION LEVEL (dBuV/m)	LIMIT (dBuV/m)	MARGIN (dB)	ANTENNA HEIGHT (m)	TABLE ANGLE (Degree)	RAW VALUE (dBuV)	CORRECTION FACTOR (dB/m)
1	5146.90	63.6 PK	74.0	-10.4	1.33 H	199	60.7	2.9
2	5146.90	47.5 AV	54.0	-6.5	1.33 H	199	44.6	2.9
3	*5190.00	106.7 PK			1.33 H	199	103.7	3.0
4	*5190.00	95.1 AV			1.33 H	199	92.1	3.0
5	5361.00	59.3 PK	74.0	-14.7	1.33 H	199	55.9	3.4
6	5361.00	49.3 AV	54.0	-4.7	1.33 H	199	45.9	3.4
7	#6920.00	58.4 PK	68.2	-9.8	1.33 H	199	51.2	7.2
8	#10380.00	54.2 PK	68.2	-14.0	1.48 H	218	42.2	12.0
9	15570.00	46.8 PK	74.0	-27.2	1.45 H	282	34.5	12.3
10	15570.00	33.5 AV	54.0	-20.5	1.45 H	282	21.2	12.3

ANTENNA POLARITY & TEST DISTANCE: VERTICAL AT 3 M

NO.	FREQ. (MHz)	EMISSION LEVEL (dBuV/m)	LIMIT (dBuV/m)	MARGIN (dB)	ANTENNA HEIGHT (m)	TABLE ANGLE (Degree)	RAW VALUE (dBuV)	CORRECTION FACTOR (dB/m)
1	5146.90	67.7 PK	74.0	-6.3	1.39 V	197	64.8	2.9
2	5146.90	52.1 AV	54.0	-1.9	1.39 V	197	49.2	2.9
3	*5190.00	113.2 PK			1.39 V	197	110.2	3.0
4	*5190.00	102.0 AV			1.39 V	197	99.0	3.0
5	5361.00	63.7 PK	74.0	-10.3	1.39 V	197	60.3	3.4
6	5361.00	53.9 AV	54.0	-0.1	1.39 V	197	50.5	3.4
7	#6920.00	62.2 PK	68.2	-6.0	1.81 V	234	55.0	7.2
8	#10380.00	58.2 PK	68.2	-10.0	2.41 V	199	46.2	12.0
9	15570.00	46.5 PK	74.0	-27.5	1.61 V	154	34.2	12.3
10	15570.00	33.9 AV	54.0	-20.1	1.61 V	154	21.6	12.3

REMARKS:

- Emission Level(dBuV/m) = Raw Value(dBuV) + Correction Factor(dB/m)
- Correction Factor(dB/m) = Antenna Factor(dB/m) + Cable Factor(dB) – Pre-Amplifier Factor(dB)
- The other emission levels were very low against the limit.
- Margin value = Emission Level – Limit value
- " * ": Fundamental frequency.
- " # ": The radiated frequency is out of the restricted band.

CHANNEL	TX Channel 46	DETECTOR FUNCTION	Peak (PK)
FREQUENCY RANGE	1GHz ~ 40GHz		Average (AV)

ANTENNA POLARITY & TEST DISTANCE: HORIZONTAL AT 3 M

NO.	FREQ. (MHz)	EMISSION LEVEL (dBuV/m)	LIMIT (dBuV/m)	MARGIN (dB)	ANTENNA HEIGHT (m)	TABLE ANGLE (Degree)	RAW VALUE (dBuV)	CORRECTION FACTOR (dB/m)
1	5076.60	58.7 PK	74.0	-15.3	1.38 H	178	55.9	2.8
2	5076.60	46.3 AV	54.0	-7.7	1.38 H	178	43.5	2.8
3	*5230.00	107.9 PK			1.38 H	178	104.8	3.1
4	*5230.00	96.8 AV			1.38 H	178	93.7	3.1
5	5381.50	58.9 PK	74.0	-15.1	1.38 H	178	55.5	3.4
6	5381.50	47.7 AV	54.0	-6.3	1.38 H	178	44.3	3.4
7	#6973.33	56.4 PK	68.2	-11.8	1.38 H	178	49.1	7.3
8	#10460.00	54.9 PK	68.2	-13.3	1.43 H	212	42.9	12.0
9	15690.00	47.1 PK	74.0	-26.9	1.46 H	269	34.1	13.0
10	15690.00	34.0 AV	54.0	-20.0	1.46 H	269	21.0	13.0

ANTENNA POLARITY & TEST DISTANCE: VERTICAL AT 3 M

NO.	FREQ. (MHz)	EMISSION LEVEL (dBuV/m)	LIMIT (dBuV/m)	MARGIN (dB)	ANTENNA HEIGHT (m)	TABLE ANGLE (Degree)	RAW VALUE (dBuV)	CORRECTION FACTOR (dB/m)
1	5076.60	62.9 PK	74.0	-11.1	1.50 V	205	60.1	2.8
2	5076.60	52.2 AV	54.0	-1.8	1.50 V	205	49.4	2.8
3	*5230.00	114.3 PK			1.50 V	205	111.2	3.1
4	*5230.00	103.6 AV			1.50 V	205	100.5	3.1
5	5381.50	62.9 PK	74.0	-11.1	1.50 V	172	59.5	3.4
6	5381.50	53.8 AV	54.0	-0.2	1.50 V	172	50.4	3.4
7	#6973.33	60.5 PK	68.2	-7.7	1.87 V	234	53.2	7.3
8	#10460.00	59.8 PK	68.2	-8.4	2.46 V	214	47.8	12.0
9	15690.00	47.4 PK	74.0	-26.6	1.66 V	160	34.4	13.0
10	15690.00	34.4 AV	54.0	-19.6	1.66 V	160	21.4	13.0

REMARKS:

1. Emission Level(dBuV/m) = Raw Value(dBuV) + Correction Factor(dB/m)
2. Correction Factor(dB/m) = Antenna Factor(dB/m) + Cable Factor(dB) – Pre-Amplifier Factor(dB)
3. The other emission levels were very low against the limit.
4. Margin value = Emission Level – Limit value
5. " * ": Fundamental frequency.
6. " # ": The radiated frequency is out of the restricted band.

CHANNEL	TX Channel 151	DETECTOR FUNCTION	Peak (PK)
FREQUENCY RANGE	1GHz ~ 40GHz		Average (AV)

ANTENNA POLARITY & TEST DISTANCE: HORIZONTAL AT 3 M

NO.	FREQ. (MHz)	EMISSION LEVEL (dBuV/m)	LIMIT (dBuV/m)	MARGIN (dB)	ANTENNA HEIGHT (m)	TABLE ANGLE (Degree)	RAW VALUE (dBuV)	CORRECTION FACTOR (dB/m)
1	#5632.65	60.9 PK	68.2	-7.3	1.51 H	186	57.1	3.8
2	*5755.00	110.5 PK			1.51 H	186	106.5	4.0
3	*5755.00	100.3 AV			1.51 H	186	96.3	4.0
4	#5947.10	60.4 PK	68.2	-7.8	1.51 H	186	56.1	4.3
5	11510.00	59.5 PK	74.0	-14.5	1.51 H	210	46.8	12.7
6	11510.00	47.1 AV	54.0	-6.9	1.51 H	210	34.4	12.7
7	#17265.00	49.5 PK	74.0	-24.5	1.49 H	219	31.9	17.6
8	#17265.00	38.7 AV	54.0	-15.3	1.49 H	219	21.1	17.6

ANTENNA POLARITY & TEST DISTANCE: VERTICAL AT 3 M

NO.	FREQ. (MHz)	EMISSION LEVEL (dBuV/m)	LIMIT (dBuV/m)	MARGIN (dB)	ANTENNA HEIGHT (m)	TABLE ANGLE (Degree)	RAW VALUE (dBuV)	CORRECTION FACTOR (dB/m)
1	#5651.03	68.9 PK	69.0	-0.1	1.49 V	196	65.2	3.7
2	*5755.00	118.7 PK			1.49 V	196	114.7	4.0
3	*5755.00	109.0 AV			1.49 V	196	105.0	4.0
4	#5932.16	62.5 PK	68.2	-5.7	1.49 V	196	58.2	4.3
5	11510.00	64.6 PK	74.0	-9.4	1.49 V	234	51.9	12.7
6	11510.00	52.6 AV	54.0	-1.4	1.49 V	234	39.9	12.7
7	#17265.00	50.8 PK	74.0	-23.2	1.68 V	190	33.2	17.6
8	#17265.00	39.7 AV	54.0	-14.3	1.68 V	190	22.1	17.6

REMARKS:

1. Emission Level(dBuV/m) = Raw Value(dBuV) + Correction Factor(dB/m)
2. Correction Factor(dB/m) = Antenna Factor(dB/m) + Cable Factor(dB) – Pre-Amplifier Factor(dB)
3. The other emission levels were very low against the limit.
4. Margin value = Emission Level – Limit value
5. " * ": Fundamental frequency.
6. " # ": The radiated frequency is out of the restricted band.

CHANNEL	TX Channel 159	DETECTOR FUNCTION	Peak (PK)
FREQUENCY RANGE	1GHz ~ 40GHz		Average (AV)

ANTENNA POLARITY & TEST DISTANCE: HORIZONTAL AT 3 M

NO.	FREQ. (MHz)	EMISSION LEVEL (dBuV/m)	LIMIT (dBuV/m)	MARGIN (dB)	ANTENNA HEIGHT (m)	TABLE ANGLE (Degree)	RAW VALUE (dBuV)	CORRECTION FACTOR (dB/m)
1	#5636.45	60.6 PK	68.2	-7.6	1.50 H	184	56.8	3.8
2	*5795.00	110.2 PK			1.50 H	184	106.2	4.0
3	*5795.00	100.2 AV			1.50 H	184	96.2	4.0
4	#6019.30	59.0 PK	68.2	-9.2	1.50 H	184	54.4	4.6
5	11590.00	59.8 PK	74.0	-14.2	1.46 H	214	47.2	12.6
6	11590.00	47.2 AV	54.0	-6.8	1.46 H	214	34.6	12.6
7	#17385.00	49.5 PK	74.0	-24.5	1.52 H	214	31.1	18.4
8	#17385.00	38.9 AV	54.0	-15.1	1.52 H	214	20.5	18.4

ANTENNA POLARITY & TEST DISTANCE: VERTICAL AT 3 M

NO.	FREQ. (MHz)	EMISSION LEVEL (dBuV/m)	LIMIT (dBuV/m)	MARGIN (dB)	ANTENNA HEIGHT (m)	TABLE ANGLE (Degree)	RAW VALUE (dBuV)	CORRECTION FACTOR (dB/m)
1	#5641.81	64.3 PK	68.2	-3.9	1.49 V	216	60.5	3.8
2	*5795.00	118.3 PK			1.50 V	216	114.3	4.0
3	*5795.00	108.4 AV			1.50 V	216	104.4	4.0
4	#5947.01	64.0 PK	68.2	-4.2	1.49 V	216	59.7	4.3
5	11590.00	65.0 PK	74.0	-9.0	1.54 V	221	52.4	12.6
6	11590.00	52.9 AV	54.0	-1.1	1.54 V	221	40.3	12.6
7	#17385.00	50.7 PK	74.0	-23.3	1.67 V	187	32.3	18.4
8	#17385.00	39.6 AV	54.0	-14.4	1.67 V	187	21.2	18.4

REMARKS:

1. Emission Level(dBuV/m) = Raw Value(dBuV) + Correction Factor(dB/m)
2. Correction Factor(dB/m) = Antenna Factor(dB/m) + Cable Factor(dB) – Pre-Amplifier Factor(dB)
3. The other emission levels were very low against the limit.
4. Margin value = Emission Level – Limit value
5. " * ": Fundamental frequency.
6. " # ": The radiated frequency is out of the restricted band.

802.11ac (VHT80)

CHANNEL	TX Channel 42	DETECTOR FUNCTION	Peak (PK)
FREQUENCY RANGE	1GHz ~ 40GHz		Average (AV)

ANTENNA POLARITY & TEST DISTANCE: HORIZONTAL AT 3 M

NO.	FREQ. (MHz)	EMISSION LEVEL (dBuV/m)	LIMIT (dBuV/m)	MARGIN (dB)	ANTENNA HEIGHT (m)	TABLE ANGLE (Degree)	RAW VALUE (dBuV)	CORRECTION FACTOR (dB/m)
1	5150.00	59.4 PK	74.0	-14.6	1.53 H	188	56.5	2.9
2	5150.00	47.6 AV	54.0	-6.4	1.53 H	188	44.7	2.9
3	*5210.00	109.8 PK			1.53 H	188	106.8	3.0
4	*5210.00	94.3 AV			1.53 H	188	91.3	3.0
5	5356.40	57.6 PK	74.0	-16.4	1.53 H	188	54.2	3.4
6	5356.40	47.2 AV	54.0	-6.8	1.53 H	188	43.8	3.4
7	#6946.67	53.2 PK	68.2	-15.0	1.53 H	188	45.9	7.3
8	#10420.00	50.6 PK	68.2	-17.6	1.53 H	226	38.7	11.9
9	15630.00	44.3 PK	74.0	-29.7	1.43 H	282	31.8	12.5
10	15630.00	32.2 AV	54.0	-21.8	1.43 H	282	19.7	12.5

ANTENNA POLARITY & TEST DISTANCE: VERTICAL AT 3 M

NO.	FREQ. (MHz)	EMISSION LEVEL (dBuV/m)	LIMIT (dBuV/m)	MARGIN (dB)	ANTENNA HEIGHT (m)	TABLE ANGLE (Degree)	RAW VALUE (dBuV)	CORRECTION FACTOR (dB/m)
1	5150.00	63.8 PK	74.0	-10.2	1.50 V	196	60.9	2.9
2	5150.00	53.7 AV	54.0	-0.3	1.50 V	196	50.8	2.9
3	*5210.00	109.2 PK			1.50 V	196	106.2	3.0
4	*5210.00	101.2 AV			1.50 V	196	98.2	3.0
5	5356.40	61.7 PK	74.0	-12.3	1.50 V	196	58.3	3.4
6	5356.40	53.4 AV	54.0	-0.6	1.50 V	196	50.0	3.4
7	#6946.67	57.6 PK	68.2	-10.6	1.76 V	226	50.3	7.3
8	#10420.00	55.1 PK	68.2	-13.1	2.38 V	191	43.2	11.9
9	15630.00	45.1 PK	74.0	-28.9	1.58 V	144	32.6	12.5
10	15630.00	32.6 AV	54.0	-21.4	1.58 V	144	20.1	12.5

REMARKS:

- Emission Level(dBuV/m) = Raw Value(dBuV) + Correction Factor(dB/m)
- Correction Factor(dB/m) = Antenna Factor(dB/m) + Cable Factor(dB) – Pre-Amplifier Factor(dB)
- The other emission levels were very low against the limit.
- Margin value = Emission Level – Limit value
- " * ": Fundamental frequency.
- " # ": The radiated frequency is out of the restricted band.

CHANNEL	TX Channel 155	DETECTOR FUNCTION	Peak (PK)
FREQUENCY RANGE	1GHz ~ 40GHz		Average (AV)

ANTENNA POLARITY & TEST DISTANCE: HORIZONTAL AT 3 M

NO.	FREQ. (MHz)	EMISSION LEVEL (dBuV/m)	LIMIT (dBuV/m)	MARGIN (dB)	ANTENNA HEIGHT (m)	TABLE ANGLE (Degree)	RAW VALUE (dBuV)	CORRECTION FACTOR (dB/m)
1	#5642.62	62.5 PK	68.2	-5.7	1.54 H	169	58.7	3.8
2	*5775.00	105.7 PK			1.54 H	169	101.7	4.0
3	*5775.00	96.0 AV			1.54 H	169	92.0	4.0
4	#5916.70	62.6 PK	74.3	-11.7	1.54 H	169	58.3	4.3
5	11550.00	53.7 PK	74.0	-20.3	1.49 H	225	41.1	12.6
6	11550.00	40.6 AV	54.0	-13.4	1.49 H	225	28.0	12.6
7	#17325.00	47.6 PK	74.0	-26.4	1.48 H	289	29.8	17.8
8	#17325.00	35.2 AV	54.0	-18.8	1.48 H	289	17.4	17.8

ANTENNA POLARITY & TEST DISTANCE: VERTICAL AT 3 M

NO.	FREQ. (MHz)	EMISSION LEVEL (dBuV/m)	LIMIT (dBuV/m)	MARGIN (dB)	ANTENNA HEIGHT (m)	TABLE ANGLE (Degree)	RAW VALUE (dBuV)	CORRECTION FACTOR (dB/m)
1	#5652.60	69.7 PK	70.1	-0.4	1.50 V	216	66.0	3.7
2	*5775.00	113.8 PK			1.50 V	216	109.8	4.0
3	*5775.00	104.2 AV			1.50 V	216	100.2	4.0
4	#5932.85	64.5 PK	68.2	-3.7	1.50 V	216	60.2	4.3
5	11550.00	57.5 PK	74.0	-16.5	2.37 V	184	44.9	12.6
6	11550.00	43.6 AV	54.0	-10.4	2.37 V	184	31.0	12.6
7	#17325.00	48.2 PK	74.0	-25.8	1.62 V	154	30.4	17.8
8	#17325.00	35.6 AV	54.0	-18.4	1.62 V	154	17.8	17.8

REMARKS:

1. Emission Level(dBuV/m) = Raw Value(dBuV) + Correction Factor(dB/m)
2. Correction Factor(dB/m) = Antenna Factor(dB/m) + Cable Factor(dB) – Pre-Amplifier Factor(dB)
3. The other emission levels were very low against the limit.
4. Margin value = Emission Level – Limit value
5. " * ": Fundamental frequency.
6. " # ": The radiated frequency is out of the restricted band.

Below 1GHz Data:

802.11a

CHANNEL	TX Channel 157	DETECTOR FUNCTION	Quasi-Peak (QP)
FREQUENCY RANGE	9kHz ~ 1GHz		

ANTENNA POLARITY & TEST DISTANCE: HORIZONTAL AT 3 M

NO.	FREQ. (MHz)	EMISSION LEVEL (dBuV/m)	LIMIT (dBuV/m)	MARGIN (dB)	ANTENNA HEIGHT (m)	TABLE ANGLE (Degree)	RAW VALUE (dBuV)	CORRECTION FACTOR (dB/m)
1	30.63	34.7 QP	40.0	-5.3	1.00 H	124	44.4	-9.7
2	96.01	33.2 QP	43.5	-10.3	2.00 H	82	46.7	-13.5
3	158.99	39.1 QP	43.5	-4.4	2.00 H	71	47.1	-8.0
4	181.59	34.6 QP	43.5	-8.9	1.50 H	66	44.6	-10.0
5	241.10	33.2 QP	46.0	-12.8	1.00 H	83	43.3	-10.1
6	499.99	31.7 QP	46.0	-14.3	1.50 H	43	34.5	-2.8

ANTENNA POLARITY & TEST DISTANCE: VERTICAL AT 3 M

NO.	FREQ. (MHz)	EMISSION LEVEL (dBuV/m)	LIMIT (dBuV/m)	MARGIN (dB)	ANTENNA HEIGHT (m)	TABLE ANGLE (Degree)	RAW VALUE (dBuV)	CORRECTION FACTOR (dB/m)
1	107.09	37.0 QP	43.5	-6.5	1.00 V	229	48.5	-11.5
2	155.52	32.4 QP	43.5	-11.1	1.00 V	2	40.6	-8.2
3	250.00	27.9 QP	46.0	-18.1	1.00 V	153	37.6	-9.7
4	333.32	29.8 QP	46.0	-16.2	1.50 V	21	36.7	-6.9
5	499.99	35.1 QP	46.0	-10.9	1.00 V	296	37.9	-2.8
6	1000.00	37.2 QP	54.0	-16.8	2.00 V	3	32.2	5.0

REMARKS:

1. Emission Level(dBuV/m) = Raw Value(dBuV) + Correction Factor(dB/m)
2. Correction Factor(dB/m) = Antenna Factor(dB/m) + Cable Factor(dB) – Pre-Amplifier Factor(dB)
3. The other emission levels were very low against the limit.
4. Margin value = Emission Level – Limit value

4.2 Conducted Emission Measurement

4.2.1 Limits of Conducted Emission Measurement

Frequency (MHz)	Conducted Limit (dBuV)	
	Quasi-peak	Average
0.15 - 0.5	66 - 56	56 - 46
0.50 - 5.0	56	46
5.0 - 30.0	60	50

Note: 1. The lower limit shall apply at the transition frequencies.

2. The limit decreases in line with the logarithm of the frequency in the range of 0.15 to 0.50MHz.

4.2.2 Test Instruments

DESCRIPTION & MANUFACTURER	MODEL NO.	SERIAL NO.	CALIBRATED DATE	CALIBRATED UNTIL
Test Receiver R&S	ESCS 30	847124/029	Oct. 24, 2016	Oct. 23, 2017
Line-Impedance Stabilization Network (for EUT) R&S	ESH3-Z5	848773/004	Oct. 26, 2016	Oct. 25, 2017
Line-Impedance Stabilization Network (for Peripheral) R&S	ENV216	100072	June 13, 2016	June 12, 2017
50 ohms Terminator	N/A	EMC-02	Sep. 29, 2016	Sep. 28, 2017
RF Cable	5D-FB	COCCAB-001	Sep. 30, 2016	Sep. 29, 2017
10 dB PAD Mini-Circuits	HAT-10+	CONATT-004	June 20, 2016	June 19, 2017
Software BVADT	BVADT_Cond_ V7.3.7.4	NA	NA	NA

Note:

1. The calibration interval of the above test instruments are 12 months and the calibrations are traceable to NML/ROC and NIST/USA.
2. The test was performed in Shielded Room No. 1.
3. Tested Date: Mar. 06 to Apr. 26, 2017

4.2.3 Test Procedure

- The EUT was placed 0.4 meters from the conducting wall of the shielded room with EUT being connected to the power mains through a line impedance stabilization network (LISN). Other support units were connected to the power mains through another LISN. The two LISNs provide 50 ohm/ 50uH of coupling impedance for the measuring instrument.
- Both lines of the power mains connected to the EUT were checked for maximum conducted interference.
- The frequency range from 150kHz to 30MHz was searched. Emission levels under (Limit - 20dB) was not recorded.

NOTE: All modes of operation were investigated and the worst-case emissions are reported.

4.2.4 Deviation from Test Standard

No deviation.

4.2.5 Test Setup

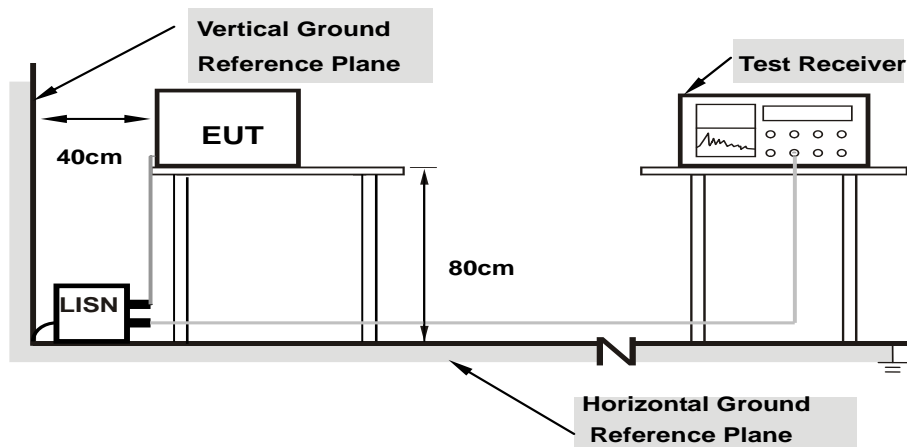

Note: 1.Support units were connected to second LISN.

For the actual test configuration, please refer to the attached file (Test Setup Photo).

4.2.6 EUT Operating Condition

Same as 4.1.6.

4.2.7 Test Results (Mode 1)

Phase	Line (L)	Detector Function	Quasi-Peak (QP) / Average (AV)
-------	----------	-------------------	--------------------------------

No	Freq. [MHz]	Corr.	Reading Value		Emission Level		Limit		Margin	
		Factor (dB)	[dB (uV)]		[dB (uV)]		[dB (uV)]		(dB)	
		Q.P.	AV.	Q.P.	AV.	Q.P.	AV.	Q.P.	AV.	
1	0.15000	10.20	36.09	14.82	46.29	25.02	66.00	56.00	-19.71	-30.98
2	0.18906	10.20	31.26	18.64	41.46	28.84	64.08	54.08	-22.62	-25.24
3	0.43125	10.24	25.94	21.01	36.18	31.25	57.23	47.23	-21.05	-15.98
4	3.11719	10.30	17.73	7.78	28.03	18.08	56.00	46.00	-27.97	-27.92
5	22.17969	11.73	30.07	21.17	41.80	32.90	60.00	50.00	-18.20	-17.10
6	24.22266	11.76	28.46	20.11	40.22	31.87	60.00	50.00	-19.78	-18.13

REMARKS:

1. Q.P. and AV. are abbreviations of quasi-peak and average individually.
2. The emission levels of other frequencies were very low against the limit.
3. Margin value = Emission level - Limit value
4. Correction factor = Insertion loss + Cable loss
5. Emission Level = Correction Factor + Reading Value.

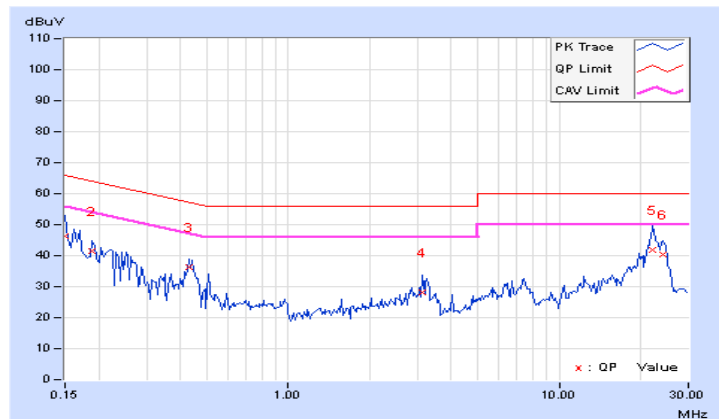

Phase	Neutral (N)	Detector Function	Quasi-Peak (QP) / Average (AV)
-------	-------------	-------------------	--------------------------------

No	Freq. [MHz]	Corr.	Reading Value		Emission Level		Limit		Margin	
		Factor	[dB (uV)]		[dB (uV)]		[dB (uV)]		(dB)	
		(dB)	Q.P.	AV.	Q.P.	AV.	Q.P.	AV.	Q.P.	AV.
1	0.15000	10.19	36.65	14.09	46.84	24.28	66.00	56.00	-19.16	-31.72
2	0.22812	10.18	27.12	10.40	37.30	20.58	62.52	52.52	-25.22	-31.94
3	0.43516	10.24	21.33	15.70	31.57	25.94	57.15	47.15	-25.58	-21.21
4	3.33984	10.25	21.49	10.69	31.74	20.94	56.00	46.00	-24.26	-25.06
5	15.88281	11.14	14.37	8.96	25.51	20.10	60.00	50.00	-34.49	-29.90
6	22.00000	11.38	25.71	17.64	37.09	29.02	60.00	50.00	-22.91	-20.98

REMARKS:

1. Q.P. and AV. are abbreviations of quasi-peak and average individually.
2. The emission levels of other frequencies were very low against the limit.
3. Margin value = Emission level - Limit value
4. Correction factor = Insertion loss + Cable loss
5. Emission Level = Correction Factor + Reading Value.

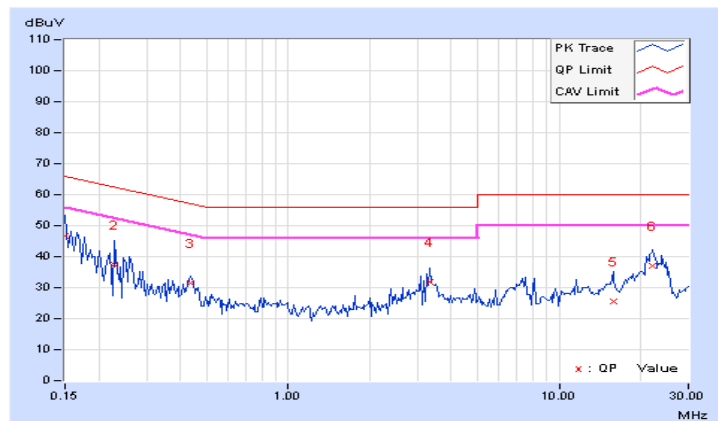

4.2.8 Test Results (Mode 2)

Phase	Line (L)	Detector Function	Quasi-Peak (QP) / Average (AV)
-------	----------	-------------------	--------------------------------

No	Freq. [MHz]	Corr.	Reading Value		Emission Level		Limit		Margin	
		Factor	[dB (uV)]		[dB (uV)]		[dB (uV)]		(dB)	
	(dB)	Q.P.	AV.	Q.P.	AV.	Q.P.	AV.	Q.P.	AV.	
1	0.15000	10.20	40.14	20.37	50.34	30.57	66.00	56.00	-15.66	-25.43
2	0.16562	10.20	37.63	18.90	47.83	29.10	65.18	55.18	-17.35	-26.08
3	0.21641	10.20	35.41	21.77	45.61	31.97	62.96	52.96	-17.35	-20.99
4	0.32188	10.22	22.34	7.67	32.56	17.89	59.66	49.66	-27.10	-31.77
5	13.62109	11.14	11.04	3.87	22.18	15.01	60.00	50.00	-37.82	-34.99
6	22.54688	11.74	9.16	-2.88	20.90	8.86	60.00	50.00	-39.10	-41.14

REMARKS:

1. Q.P. and AV. are abbreviations of quasi-peak and average individually.
2. The emission levels of other frequencies were very low against the limit.
3. Margin value = Emission level - Limit value
4. Correction factor = Insertion loss + Cable loss
5. Emission Level = Correction Factor + Reading Value.

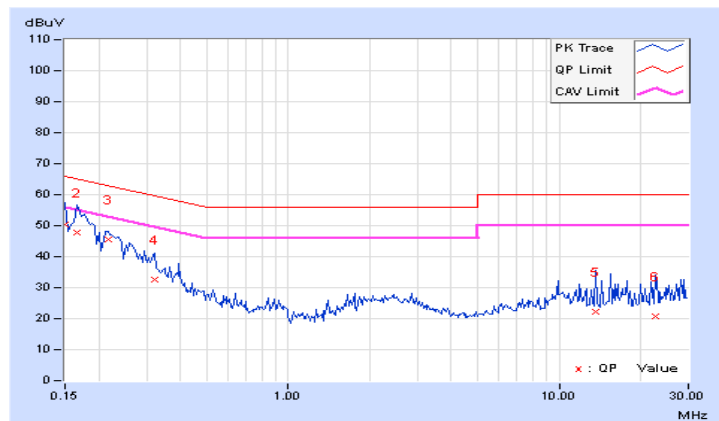

Phase	Neutral (N)	Detector Function	Quasi-Peak (QP) / Average (AV)
-------	-------------	-------------------	--------------------------------

No	Freq. [MHz]	Corr.	Reading Value		Emission Level		Limit		Margin	
		Factor (dB)	[dB (uV)]		[dB (uV)]		[dB (uV)]		(dB)	
			Q.P.	AV.	Q.P.	AV.	Q.P.	AV.	Q.P.	AV.
1	0.15000	10.19	40.53	20.69	50.72	30.88	66.00	56.00	-15.28	-25.12
2	0.17344	10.18	41.06	26.64	51.24	36.82	64.79	54.79	-13.55	-17.97
3	0.22031	10.18	34.28	21.30	44.46	31.48	62.81	52.81	-18.35	-21.33
4	0.86484	10.26	13.54	7.26	23.80	17.52	56.00	46.00	-32.20	-28.48
5	1.72266	10.30	19.83	11.91	30.13	22.21	56.00	46.00	-25.87	-23.79
6	9.34766	10.59	13.72	2.29	24.31	12.88	60.00	50.00	-35.69	-37.12

REMARKS:

1. Q.P. and AV. are abbreviations of quasi-peak and average individually.
2. The emission levels of other frequencies were very low against the limit.
3. Margin value = Emission level - Limit value
4. Correction factor = Insertion loss + Cable loss
5. Emission Level = Correction Factor + Reading Value.

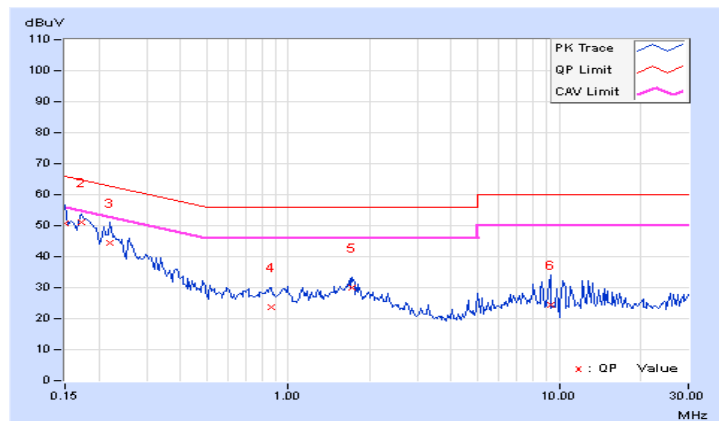

4.3 Transmit Power Measurement

4.3.1 Limits of Transmit Power Measurement

Operation Band	EUT Category		Limit
U-NII-1		Outdoor Access Point	1 Watt (30 dBm) (Max. e.i.r.p \leq 125mW(21 dBm) at any elevation angle above 30 degrees as measured from the horizon)
		Fixed point-to-point Access Point	1 Watt (30 dBm)
	√	Indoor Access Point	1 Watt (30 dBm)
		Mobile and Portable client device	250mW (24 dBm)
U-NII-2A			250mW (24 dBm) or 11 dBm+10 log B*
U-NII-2C			250mW (24 dBm) or 11 dBm+10 log B*
U-NII-3	√		1 Watt (30 dBm)

*B is the 26 dB emission bandwidth in megahertz

Per KDB 662911 Method of conducted output power measurement on IEEE 802.11 devices,

Array Gain = 0 dB (i.e., no array gain) for $N_{ANT} \leq 4$;

Array Gain = 0 dB (i.e., no array gain) for channel widths ≥ 40 MHz for any N_{ANT} ;

Array Gain = $5 \log(N_{ANT}/N_{SS})$ dB or 3 dB, whichever is less for 20-MHz channel widths with $N_{ANT} \geq 5$.

For power measurements on all other devices: Array Gain = $10 \log(N_{ANT}/N_{SS})$ dB.

4.3.2 Test Setup

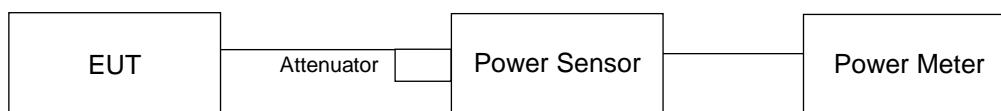

4.3.3 Test Instruments

Refer to section 4.1.2 to get information of above instrument.

4.3.4 Test Procedure

Method PM is used to perform output power measurement, trigger and gating function of wide band power meter is enabled to measure max output power of TX on burst. Duty factor is not added to measured value.

4.3.5 Deviation from Test Standard

No deviation.

4.3.6 EUT Operating Condition

The software provided by client to enable the EUT under transmission condition continuously at lowest,

middle and highest channel frequencies individually.

4.3.7 Test Result

CDD Mode

802.11a

Chan.	Chan. Freq. (MHz)	Average Power (dBm)				Total Power (mW)	Total Power (dBm)	Limit (dBm)	Pass / Fail
		Chain 0	Chain 1	Chain 2	Chain 3				
36	5180	19.71	18.37	18.34	19.35	316.581	25.00	30.00	Pass
40	5200	19.90	18.40	18.38	19.42	323.27	25.10	30.00	Pass
48	5240	19.85	18.59	18.41	19.40	325.321	25.12	30.00	Pass
149	5745	24.45	23.04	23.82	23.80	960.858	29.83	30.00	Pass
157	5785	24.52	23.23	23.98	23.85	986.213	29.94	30.00	Pass
165	5825	24.55	23.22	23.95	23.81	983.745	29.93	30.00	Pass

802.11ac (VHT20)

Chan.	Chan. Freq. (MHz)	Average Power (dBm)				Total Power (mW)	Total Power (dBm)	Limit (dBm)	Pass / Fail
		Chain 0	Chain 1	Chain 2	Chain 3				
36	5180	19.88	18.55	18.35	19.33	322.984	25.09	30.00	Pass
40	5200	19.85	18.68	18.40	19.35	325.677	25.13	30.00	Pass
48	5240	19.85	18.64	18.38	19.31	323.894	25.10	30.00	Pass
149	5745	24.20	23.62	23.91	23.55	965.672	29.85	30.00	Pass
157	5785	24.18	23.60	23.89	23.62	965.955	29.85	30.00	Pass
165	5825	24.16	23.66	24.09	23.71	984.3	29.93	30.00	Pass

802.11ac (VHT40)

Chan.	Chan. Freq. (MHz)	Average Power (dBm)				Total Power (mW)	Total Power (dBm)	Limit (dBm)	Pass / Fail
		Chain 0	Chain 1	Chain 2	Chain 3				
38	5190	18.04	16.84	16.65	17.42	213.432	23.29	30.00	Pass
46	5230	18.82	17.89	17.22	18.42	259.951	24.15	30.00	Pass
151	5755	24.28	23.44	23.23	24.20	962.122	29.83	30.00	Pass
159	5795	24.33	23.56	23.18	24.35	978.245	29.90	30.00	Pass

802.11ac (VHT80)

Chan.	Chan. Freq. (MHz)	Average Power (dBm)				Total Power (mW)	Total Power (dBm)	Limit (dBm)	Pass / Fail
		Chain 0	Chain 1	Chain 2	Chain 3				
42	5210	16.91	16.23	15.83	16.49	173.915	22.40	30.00	Pass
155	5775	21.47	20.97	21.02	21.61	536.658	27.30	30.00	Pass

Beamforming Mode

802.11ac (VHT20)

Chan.	Chan. Freq. (MHz)	Average Power (dBm)				Total Power (mW)	Total Power (dBm)	Limit (dBm)	Pass / Fail
		Chain 0	Chain 1	Chain 2	Chain 3				
36	5180	19.88	18.55	18.35	19.33	322.984	25.09	25.14	Pass
40	5200	19.85	18.68	18.40	19.35	325.677	25.13	25.14	Pass
48	5240	19.85	18.64	18.38	19.31	323.894	25.10	25.14	Pass
149	5745	19.00	19.00	19.00	19.32	323.806	25.10	25.14	Pass
157	5785	19.10	19.01	18.73	19.29	320.462	25.06	25.14	Pass
165	5825	19.11	18.92	18.75	19.42	321.94	25.08	25.14	Pass

Note: 1. For U_NII-1 & U_NII-3: the Directional gain = $10 \log[(10^{G1/20} + 10^{G2/20} + 10^{G3/20} + 10^{G4/20})^2 / 4] = 10.86\text{dBi} > 6\text{dBi}$, so the power limit shall be reduced to $30 - (10.86 - 6) = 25.14\text{dBm}$.

802.11ac (VHT40)

Chan.	Chan. Freq. (MHz)	Average Power (dBm)				Total Power (mW)	Total Power (dBm)	Limit (dBm)	Pass / Fail
		Chain 0	Chain 1	Chain 2	Chain 3				
38	5190	18.04	16.84	16.65	17.42	213.432	23.29	25.14	Pass
46	5230	18.82	17.89	17.22	18.42	259.951	24.15	25.14	Pass
151	5755	19.15	18.99	18.71	19.38	322.472	25.08	25.14	Pass
159	5795	19.12	19.01	18.71	19.28	320.299	25.06	25.14	Pass

Note: 1. For U_NII-1 & U_NII-3: the Directional gain = $10 \log[(10^{G1/20} + 10^{G2/20} + 10^{G3/20} + 10^{G4/20})^2 / 4] = 10.86\text{dBi} > 6\text{dBi}$, so the power limit shall be reduced to $30 - (10.86 - 6) = 25.14\text{dBm}$.

802.11ac (VHT80)

Chan.	Chan. Freq. (MHz)	Average Power (dBm)				Total Power (mW)	Total Power (dBm)	Limit (dBm)	Pass / Fail
		Chain 0	Chain 1	Chain 2	Chain 3				
42	5210	16.91	16.23	15.83	16.49	173.915	22.40	25.14	Pass
155	5775	19.08	19.03	18.69	19.22	318.414	25.03	25.14	Pass

Note: 1. For U_NII-1 & U_NII-3: the Directional gain = $10 \log[(10^{G1/20} + 10^{G2/20} + 10^{G3/20} + 10^{G4/20})^2 / 4] = 10.86\text{dBi} > 6\text{dBi}$, so the power limit shall be reduced to $30 - (10.86 - 6) = 25.14\text{dBm}$.

4.4 Occupied Bandwidth Measurement

4.4.1 Test Setup



4.4.2 Test Instruments

Refer to section 4.1.2 to get information of above instrument.

4.4.3 Test Procedure

The transmitter output was connected to the spectrum analyzer through an attenuator. The bandwidth of the fundamental frequency was measured by spectrum analyzer with resolution bandwidth in the range of 1% to 5% of the anticipated emission bandwidth, and a video bandwidth at least 3x the resolution bandwidth and set the detector to SAMPLE. The width of a frequency band such that, below the lower and above the upper frequency limits, the mean powers emitted are each equal to a specified percentage 0.5 %of the total mean power of a given emission.

4.4.4 Test Results

CDD Mode

802.11a

Channel	Channel Frequency (MHz)	Occupied Bandwidth (MHz)			
		Chain 0	Chain 1	Chain 2	Chain 3
36	5180	17.04	17.04	16.92	17.16
40	5200	17.04	16.92	16.92	16.92
48	5240	17.04	16.92	17.04	17.04
149	5745	18.60	17.76	17.88	18.48
157	5785	18.96	17.64	18.12	18.48
165	5825	18.48	17.52	17.88	19.08

802.11ac (VHT20)

Channel	Channel Frequency (MHz)	Occupied Bandwidth (MHz)			
		Chain 0	Chain 1	Chain 2	Chain 3
36	5180	18.12	18.12	18.12	18.12
40	5200	18.12	18.00	18.12	18.00
48	5240	18.00	17.88	18.00	18.12
149	5745	19.56	18.60	18.60	19.20
157	5785	19.32	18.72	18.84	18.96
165	5825	19.20	18.72	18.96	19.32

802.11ac (VHT40)

Channel	Channel Frequency (MHz)	Occupied Bandwidth (MHz)			
		Chain 0	Chain 1	Chain 2	Chain 3
38	5190	36.72	36.72	36.72	36.72
46	5230	36.72	36.72	36.72	36.72
151	5755	39.36	37.68	37.68	39.12
159	5795	38.40	37.44	37.44	38.16

802.11ac (VHT80)

Channel	Channel Frequency (MHz)	Occupied Bandwidth (MHz)			
		Chain 0	Chain 1	Chain 2	Chain 3
42	5210	74.88	74.88	74.88	75.36
155	5775	76.32	76.32	75.84	76.32

Spectrum Plot of Worst Value

802.11a_Chain3 / CH165

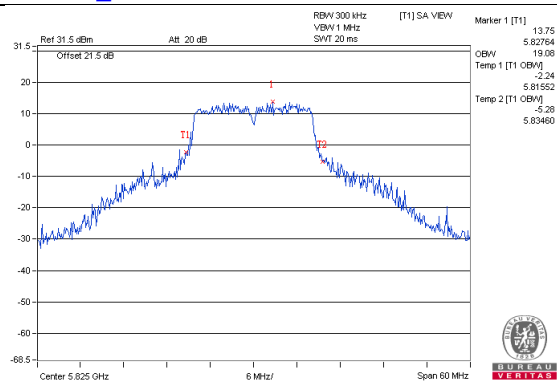

802.11ac (VHT20)_Chain0 / CH149

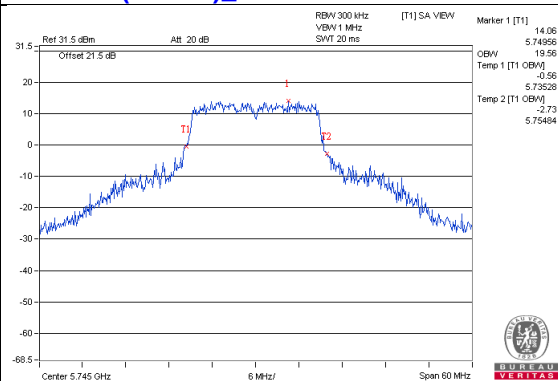

802.11ac (VHT40)_Chain0 / CH151

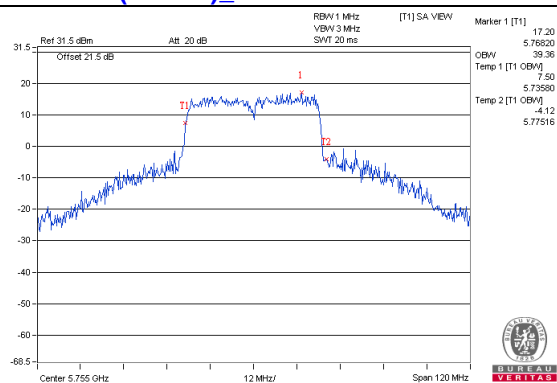

802.11ac (VHT80)_Chain3 / CH155

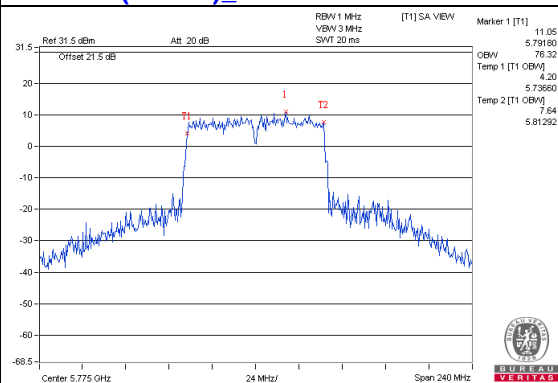

Spectrum Plot for near by DFS band (DFS is required, if 99% OCP straddle into U-NII-2A band)

802.11a_Chain0 / CH48

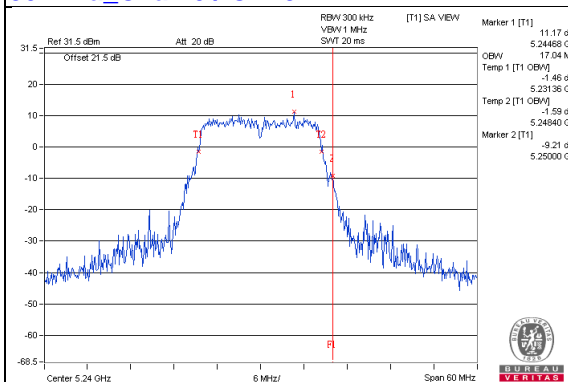

802.11a_Chain1 / CH48

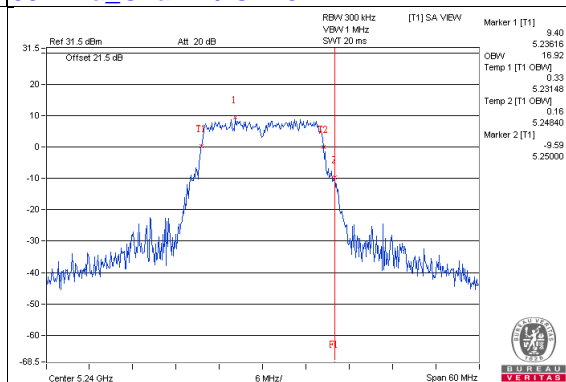

802.11a_Chain2 / CH48

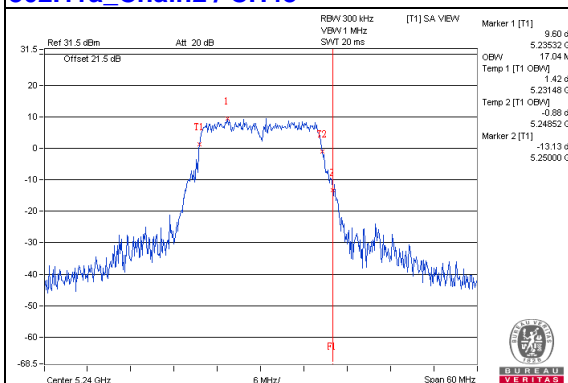

802.11a_Chain3 / CH48

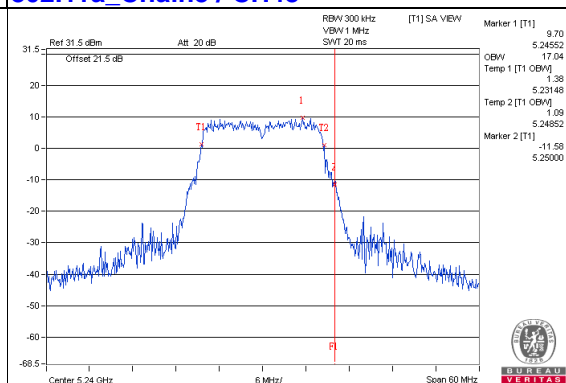

802.11ac(VHT20)_Chain0 / CH48

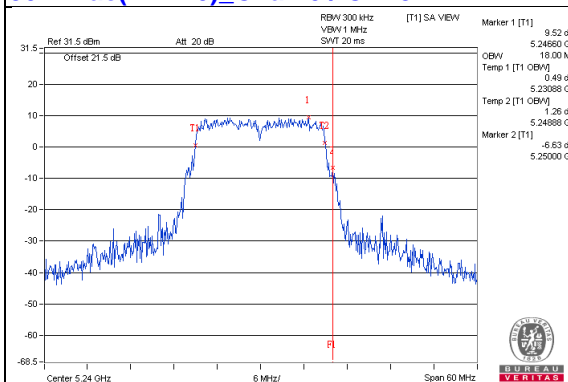

802.11ac(VHT20)_Chain1 / CH48

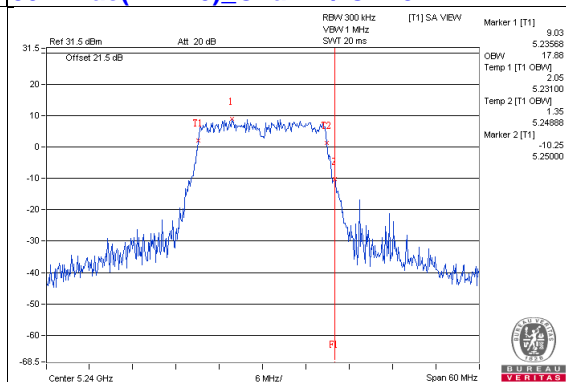

802.11ac(VHT20)_Chain2 / CH48

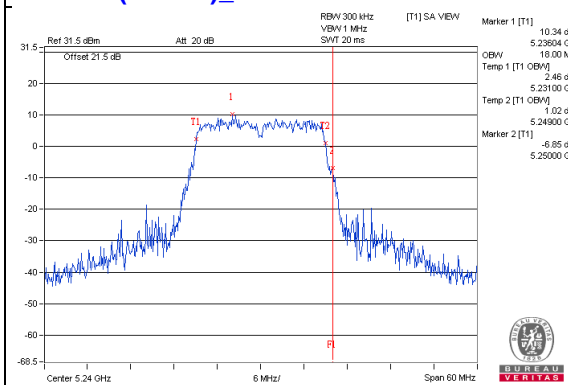

802.11ac(VHT20)_Chain3 / CH48

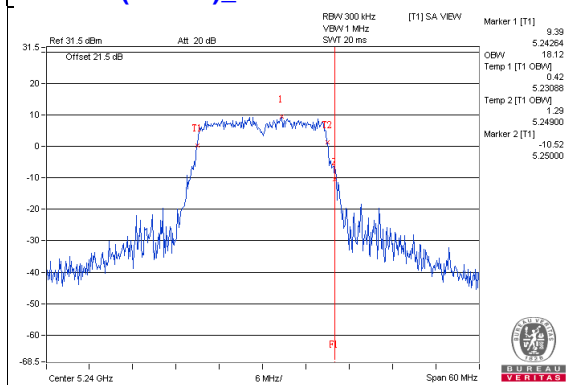

802.11ac(VHT40)_Chain0 / CH46

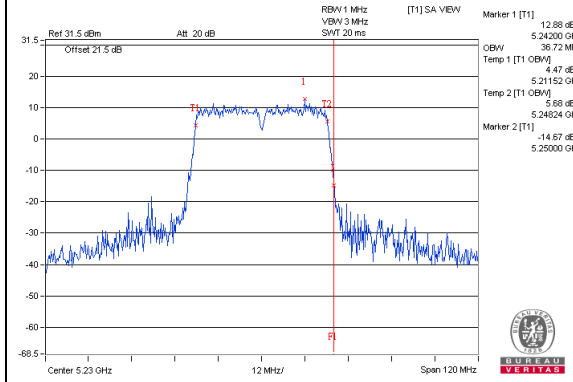

802.11ac(VHT40)_Chain1 / CH46

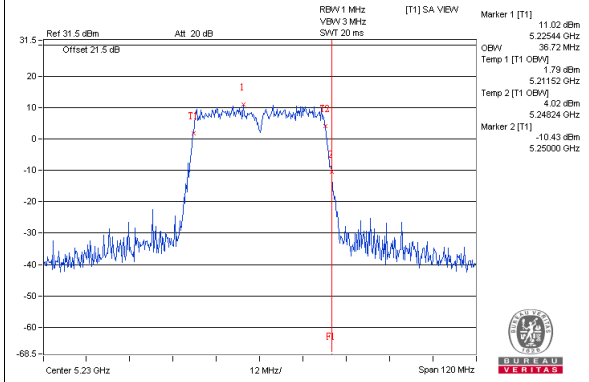

802.11ac(VHT40)_Chain2 / CH46

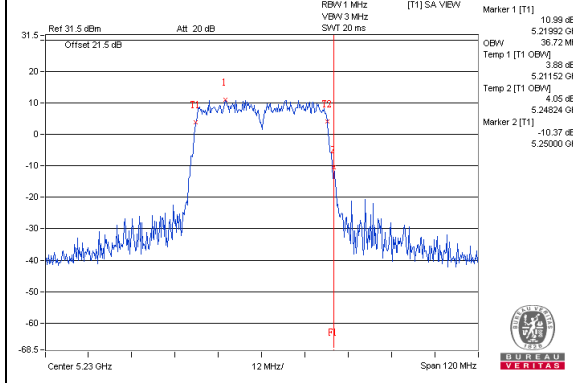

802.11ac(VHT40)_Chain3 / CH46

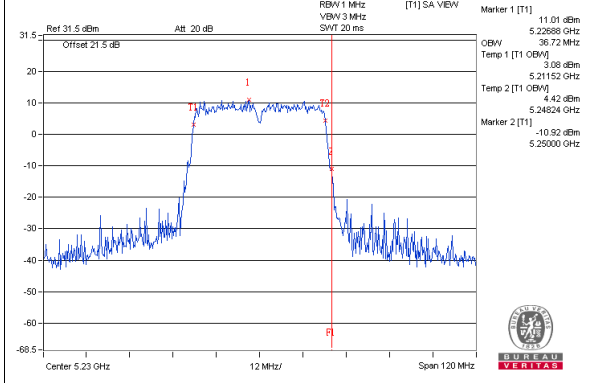

802.11ac(VHT80)_Chain0 / CH42

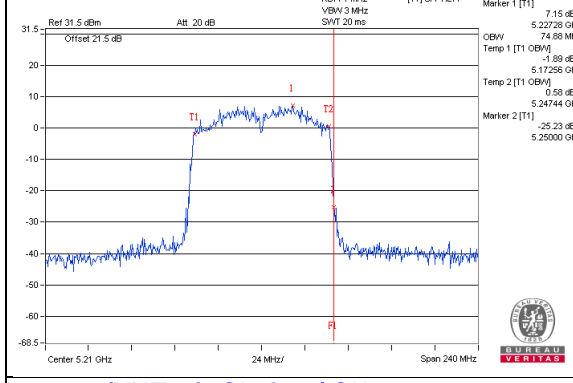

802.11ac(VHT80)_Chain1 / CH42

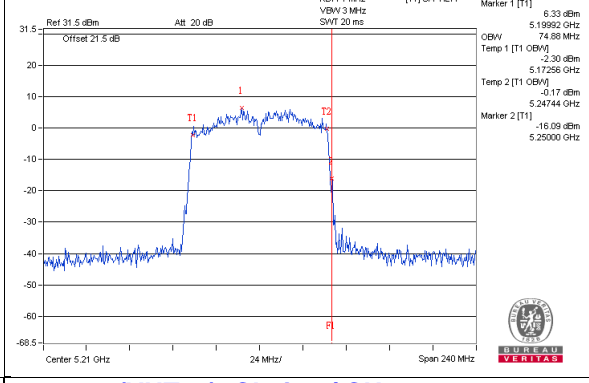

802.11ac(VHT80)_Chain2 / CH42

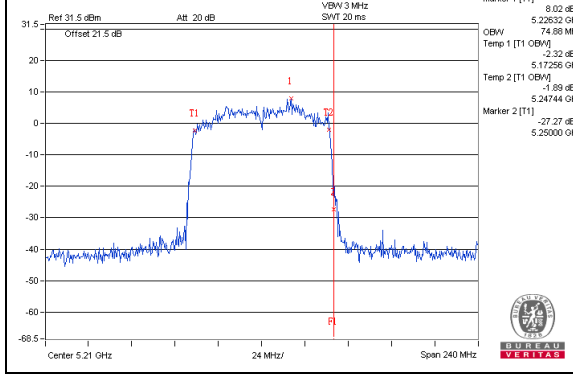

802.11ac(VHT80)_Chain3 / CH42

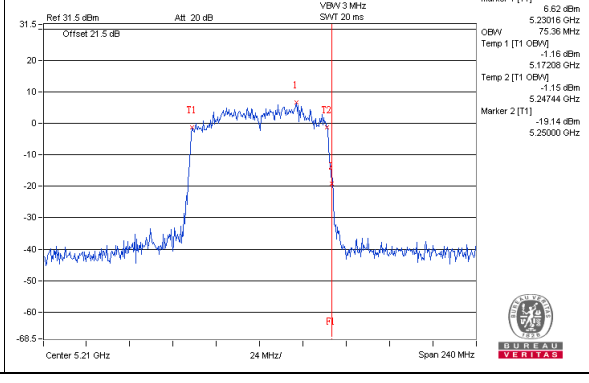

**Spectrum Plot for near by DFS band
(DFS is required, if 99% OCP straddle into U-NII-2C band)**

802.11a_Chain0 / CH149

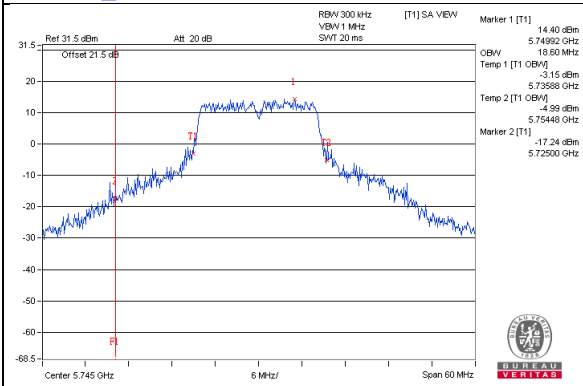

802.11a_Chain1 / CH149

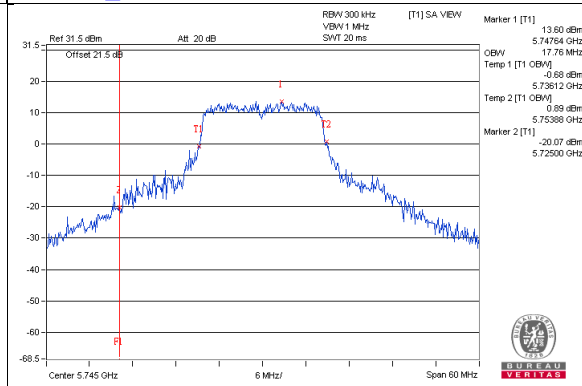

802.11a_Chain2 / CH149

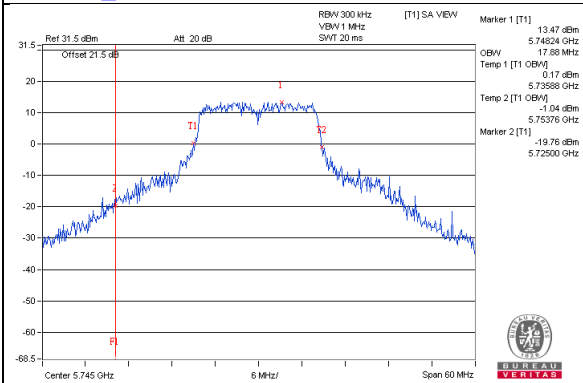

802.11a_Chain3 / CH149

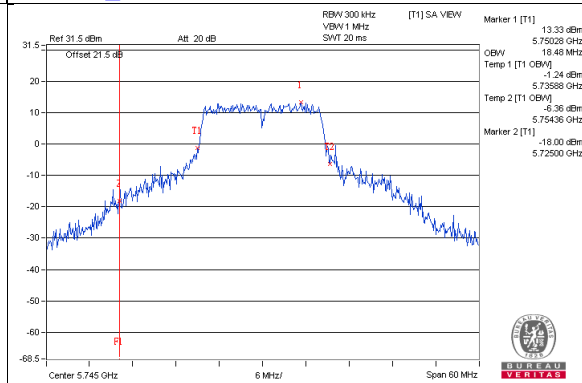

802.11ac(VHT20)_Chain0 / CH149

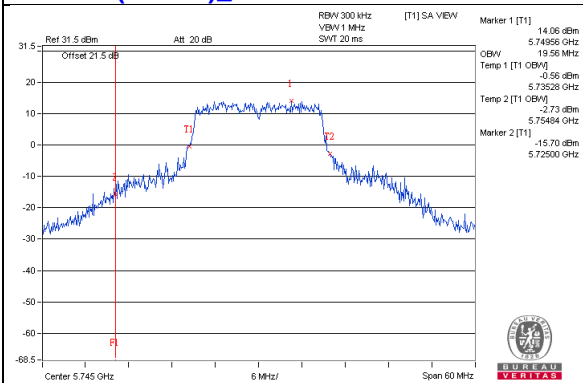

802.11ac(VHT20)_Chain1 / CH149

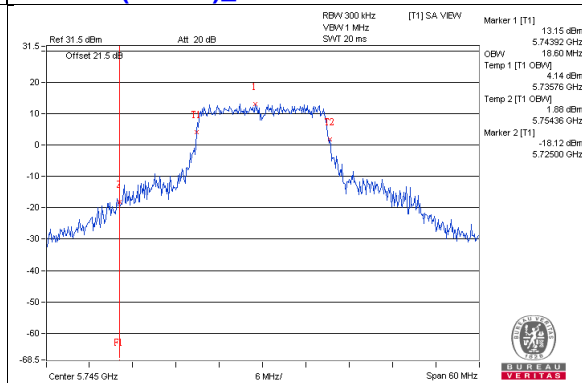

802.11ac(VHT20)_Chain2 / CH149

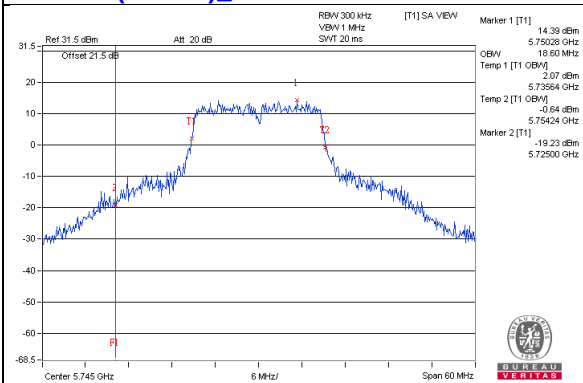

802.11ac(VHT20)_Chain3 / CH149

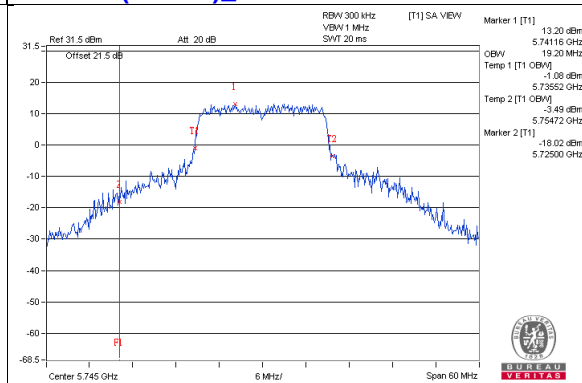

802.11ac(VHT40)_Chain0 / CH151

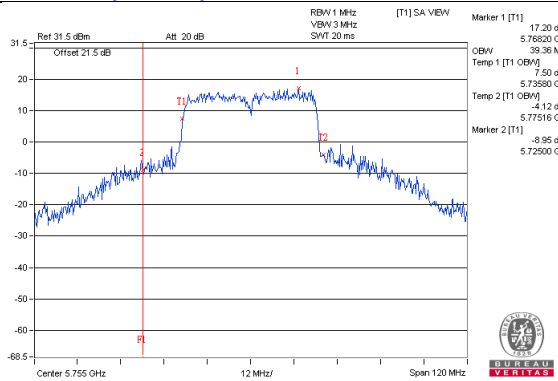

802.11ac(VHT40)_Chain1 / CH151

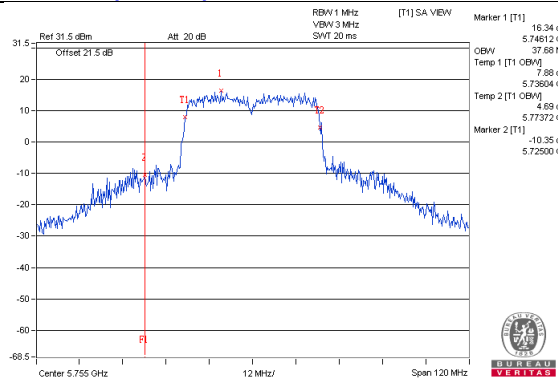

802.11ac(VHT40)_Chain2 / CH151

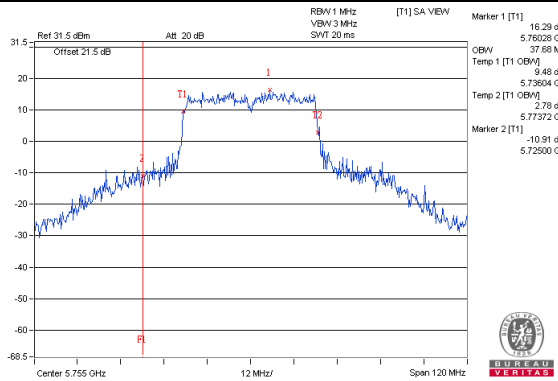

802.11ac(VHT40)_Chain3 / CH151

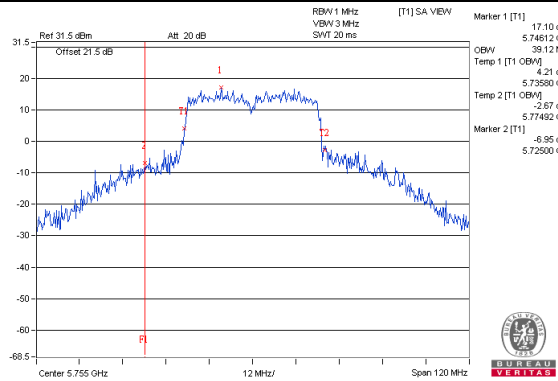

802.11ac(VHT80)_Chain0 / CH155

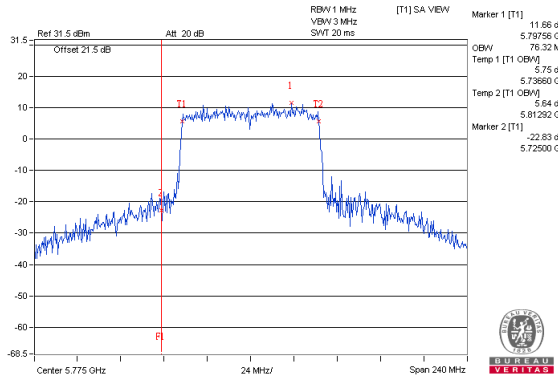

802.11ac(VHT80)_Chain1 / CH155

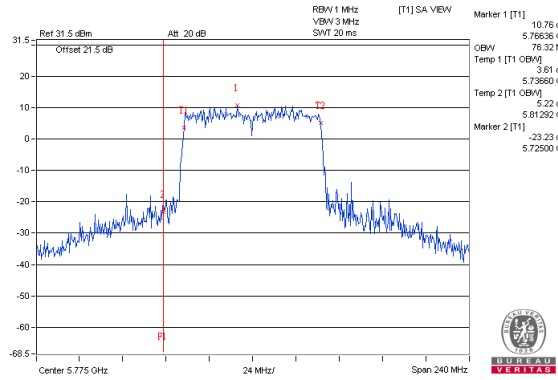

802.11ac(VHT80)_Chain2 / CH155

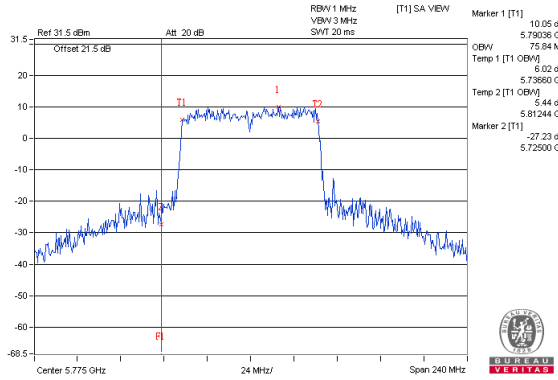

802.11ac(VHT80)_Chain3 / CH155

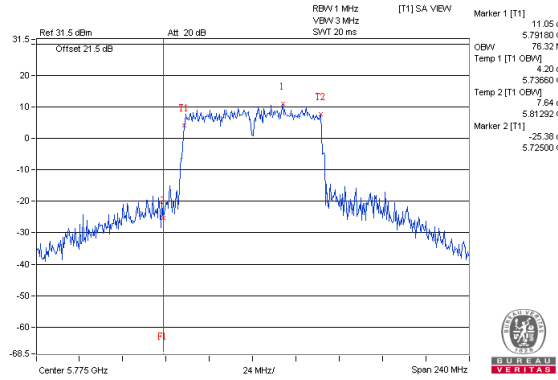

4.5 Peak Power Spectral Density Measurement

4.5.1 Limits of Peak Power Spectral Density Measurement

Operation Band	EUT Category		Limit
U-NII-1		Outdoor Access Point	17dBm/ MHz
		Fixed point-to-point Access Point	
	√	Indoor Access Point	
		Mobile and Portable client device	11dBm/ MHz
U-NII-2A			11dBm/ MHz
U-NII-2C			11dBm/ MHz
U-NII-3	√		30dBm/ 500kHz

4.5.2 Test Setup

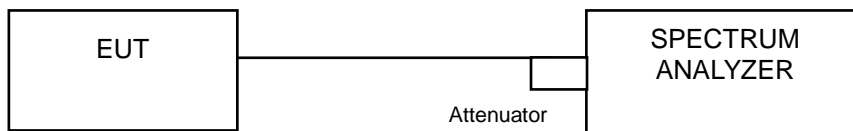

4.5.3 Test Instruments

Refer to section 4.1.2 to get information of above instrument.

4.5.4 Test Procedure

802.11ac (VHT20)

For U-NII-1 band:

Using method SA-1

1. Set span to encompass the entire emission bandwidth (EBW) of the signal.
2. Set RBW = 1 MHz, Set VBW \geq 3 MHz, Detector = RMS
3. Sweep time = auto, trigger set to "free run".
4. Trace average at least 100 traces in power averaging mode.
5. Record the max value

For U-NII-3:

1. Set span to encompass the entire emission bandwidth (EBW) of the signal.
2. Set RBW = 300 kHz, Set VBW \geq 1 MHz, Detector = RMS
3. Use the peak marker function to determine the maximum power level in any 300 kHz band segment within the fundamental EBW.
4. Scale the observed power level to an equivalent value in 500 kHz by adjusting (reducing) the measured power by a bandwidth correction factor (BWCF) where $BWCF = 10\log(500 \text{ kHz}/300\text{kHz})$
5. Sweep time = auto, trigger set to "free run".
6. Trace average at least 100 traces in power averaging mode.
7. Record the max value

802.11a, 802.11ac (VHT40), 802.11ac (VHT80)

For U-NII-1 band:

Using method SA-2

1. Set span to encompass the entire emission bandwidth (EBW) of the signal.
2. Set RBW = 1 MHz, Set VBW \geq 3 MHz, Detector = RMS
3. Sweep time = auto, trigger set to "free run".
4. Trace average at least 100 traces in power averaging mode.
5. Record the max value and add $10 \log (1/\text{duty cycle})$

For U-NII-3:

1. Set span to encompass the entire emission bandwidth (EBW) of the signal.
2. Set RBW = 300 kHz, Set VBW \geq 1 MHz, Detector = RMS
3. Use the peak marker function to determine the maximum power level in any 300 kHz band segment within the fundamental EBW.
4. Scale the observed power level to an equivalent value in 500 kHz by adjusting (reducing) the measured power by a bandwidth correction factor (BWCF) where $BWCF = 10\log(500 \text{ kHz}/300\text{kHz})$
5. Sweep time = auto, trigger set to "free run".
6. Trace average at least 100 traces in power averaging mode.
7. Record the max value and add $10 \log (1/\text{duty cycle})$

4.5.5 Deviation from Test Standard

No deviation.

4.5.6 EUT Operating Condition

Same as Item 4.3.6.

4.5.7 Test Results

CDD Mode

For U-NII-1:

802.11a

Chan.	Chan. Freq. (MHz)	PSD W/O Duty Factor (dBm/MHz)				Duty Factor (dB)	Total PSD With Duty Factor (dBm/MHz)	MAX. EIRP Limit (dBm/MHz)	Pass / Fail
		Chain 0	Chain 1	Chain 2	Chain 3				
36	5180	5.49	4.28	4.95	5.53	0.10	11.22	12.14	Pass
40	5200	5.80	4.80	5.33	5.80	0.10	11.58	12.14	Pass
48	5240	5.99	5.17	5.37	5.39	0.10	11.62	12.14	Pass

- Note:**
- Method a) of power density measurement of KDB 662911 is using for calculating total power density. Total power density is summing entire spectra across corresponding frequency bins on the various outputs by computer.
 - Directional gain = $10 \log[(10^{G1/20} + 10^{G2/20} + 10^{G3/20} + 10^{G4/20})^2 / 4] = 10.86\text{dBi} > 6\text{dBi}$, so the power density limit shall be reduced to $17 - (10.86 - 6) = 12.14\text{dBm}$.
 - Refer to section 3.3 for duty cycle spectrum plot.

802.11ac (VHT20)

Chan.	Chan. Freq. (MHz)	PSD (dBm/MHz)				Total Power Density (dBm/MHz)	MAX. Limit (dBm/MHz)	Pass / Fail
		Chain 0	Chain 1	Chain 2	Chain 3			
36	5180	5.29	4.39	4.66	5.00	10.87	12.14	Pass
40	5200	5.69	4.85	5.08	5.46	11.30	12.14	Pass
48	5240	5.80	4.82	5.08	5.43	11.32	12.14	Pass

- Note:**
- Method a) of power density measurement of KDB 662911 is using for calculating total power density. Total power density is summing entire spectra across corresponding frequency bins on the various outputs by computer.
 - Directional gain = $10 \log[(10^{G1/20} + 10^{G2/20} + 10^{G3/20} + 10^{G4/20})^2 / 4] = 10.86\text{dBi} > 6\text{dBi}$, so the power density limit shall be reduced to $17 - (10.86 - 6) = 12.14\text{dBm}$.

802.11ac (VHT40)

Chan.	Chan. Freq. (MHz)	PSD W/O Duty Factor (dBm/MHz)				Duty Factor (dB)	Total PSD With Duty Factor (dBm/MHz)	MAX. EIRP Limit (dBm/MHz)	Pass / Fail
		Chain 0	Chain 1	Chain 2	Chain 3				
38	5190	0.71	-0.09	-0.13	0.40	0.13	6.39	12.14	Pass
46	5230	1.80	0.68	1.04	1.06	0.13	7.32	12.14	Pass

- Note:**
- Method a) of power density measurement of KDB 662911 is using for calculating total power density. Total power density is summing entire spectra across corresponding frequency bins on the various outputs by computer.
 - Directional gain = $10 \log[(10^{G1/20} + 10^{G2/20} + 10^{G3/20} + 10^{G4/20})^2 / 4] = 10.86\text{dBi} > 6\text{dBi}$, so the power density limit shall be reduced to $17 - (10.86 - 6) = 12.14\text{dBm}$.
 - Refer to section 3.3 for duty cycle spectrum plot.

802.11ac (VHT80)

Chan.	Chan. Freq. (MHz)	PSD W/O Duty Factor (dBm/MHz)				Duty Factor (dB)	Total PSD With Duty Factor (dBm/MHz)	MAX. Limit (dBm/MHz)	Pass / Fail
		Chain 0	Chain 1	Chain 2	Chain 3				
42	5210	-2.14	-3.09	-2.83	-3.02	0.30	3.57	12.14	Pass

- Note:**
- Method a) of power density measurement of KDB 662911 is using for calculating total power density. Total power density is summing entire spectra across corresponding frequency bins on the various outputs by computer.
 - Directional gain = $10 \log[(10^{G1/20} + 10^{G2/20} + 10^{G3/20} + 10^{G4/20})^2 / 4] = 10.86\text{dBi} > 6\text{dBi}$, so the power density limit shall be reduced to $17 - (10.86 - 6) = 12.14\text{dBm}$.
 - Refer to section 3.3 for duty cycle spectrum plot.

Spectrum Plot of Worst Value

802.11a_Chain 0 / CH48

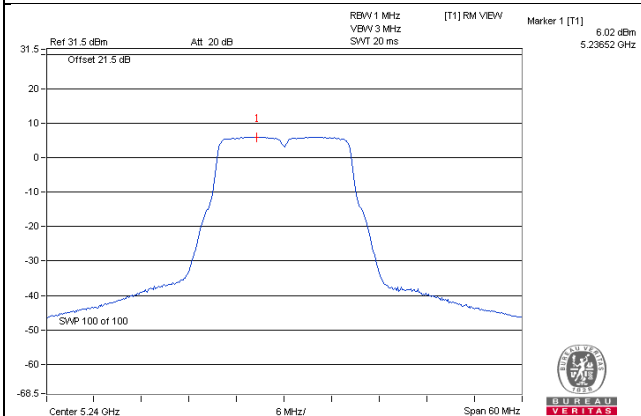

802.11ac (VHT20)_Chain 0 / CH48

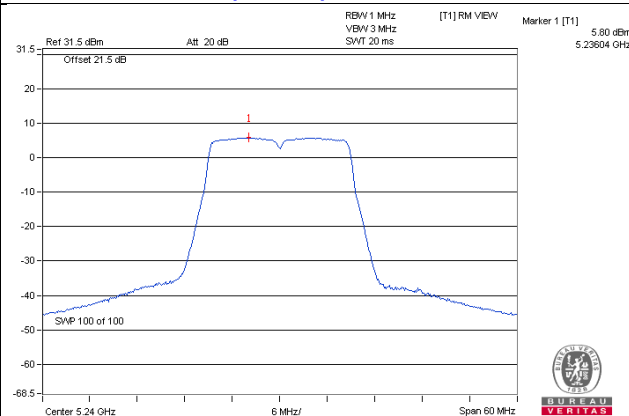

802.11ac (VHT40)_Chain 0 / CH46

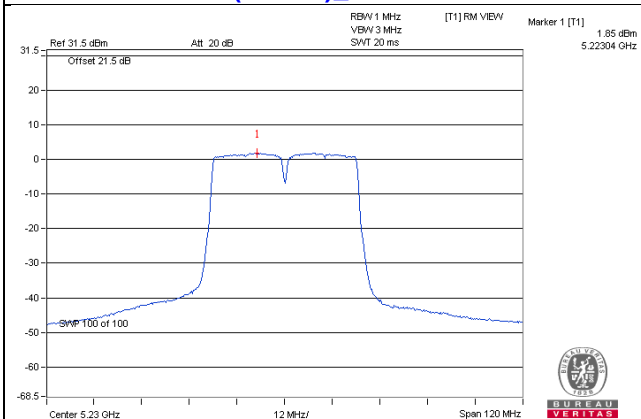

802.11ac (VHT80)_Chain 0 / CH42

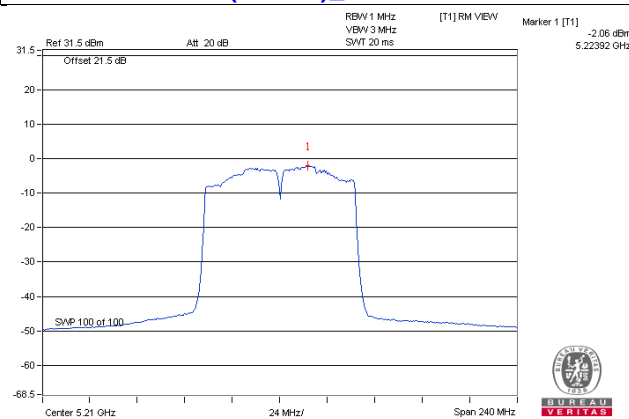

For U-NII-3:

802.11a

TX chain	Chan.	Chan. Freq. (MHz)	PSD W/O Duty Factor		10 log (N=4) dB	Duty Factor (dB)	Total PSD With Duty Factor (dBm/500kHz)	Limit (dBm/500kHz)	Pass /Fail
			(dBm/300kHz)	(dBm/500kHz)					
0	149	5745	2.45	4.67	6.02	0.10	10.79	25.14	Pass
	157	5785	2.43	4.65	6.02	0.10	10.77	25.14	Pass
	165	5825	2.59	4.81	6.02	0.10	10.93	25.14	Pass
1	149	5745	1.73	3.95	6.02	0.10	10.07	25.14	Pass
	157	5785	1.91	4.13	6.02	0.10	10.25	25.14	Pass
	165	5825	2.03	4.25	6.02	0.10	10.37	25.14	Pass
2	149	5745	1.83	4.05	6.02	0.10	10.17	25.14	Pass
	157	5785	2.29	4.51	6.02	0.10	10.63	25.14	Pass
	165	5825	2.25	4.47	6.02	0.10	10.59	25.14	Pass
3	149	5745	2.16	4.38	6.02	0.10	10.50	25.14	Pass
	157	5785	2.02	4.24	6.02	0.10	10.36	25.14	Pass
	165	5825	2.09	4.31	6.02	0.10	10.43	25.14	Pass

Note: 1. Directional gain = $10 \log[(10^{G1/20} + 10^{G2/20} + 10^{G3/20} + 10^{G4/20})^2 / 4] = 10.86\text{dBi} > 6\text{dBi}$, so the power density limit shall be reduced to $30 - (10.86 - 6) = 25.14\text{dBm}$.

2. Refer to section 3.3 for duty cycle spectrum plot.

802.11ac (VHT20)

TX chain	Channel	Freq. (MHz)	PSD (dBm/300kHz)	PSD (dBm/500kHz)	10 log (N=4) dB	Total PSD (dBm/500kHz)	Limit (dBm/500kHz)	Pass /Fail
0	149	5745	2.14	4.36	6.02	10.38	25.14	Pass
	157	5785	2.26	4.48	6.02	10.50	25.14	Pass
	165	5825	2.32	4.54	6.02	10.56	25.14	Pass
1	149	5745	1.55	3.77	6.02	9.79	25.14	Pass
	157	5785	1.82	4.04	6.02	10.06	25.14	Pass
	165	5825	1.74	3.96	6.02	9.98	25.14	Pass
2	149	5745	1.40	3.62	6.02	9.64	25.14	Pass
	157	5785	1.76	3.98	6.02	10.00	25.14	Pass
	165	5825	1.98	4.20	6.02	10.22	25.14	Pass
3	149	5745	1.55	3.77	6.02	9.79	25.14	Pass
	157	5785	1.41	3.63	6.02	9.65	25.14	Pass
	165	5825	1.55	3.77	6.02	9.79	25.14	Pass

Note: 1. Directional gain = $10 \log[(10^{G1/20} + 10^{G2/20} + 10^{G3/20} + 10^{G4/20})^2 / 4] = 10.86\text{dBi} > 6\text{dBi}$, so the power density limit shall be reduced to $30 - (10.86 - 6) = 25.14\text{dBm}$.

802.11ac (VHT40)

TX chain	Chan.	Chan. Freq. (MHz)	PSD W/O Duty Factor		10 log (N=4) dB	Duty Factor (dB)	Total PSD With Duty Factor (dBm/500kHz)	Limit (dBm/500kHz)	Pass /Fail
			(dBm/300kHz)	(dBm/500kHz)					
0	151	5755	-1.00	1.22	6.02	0.13	7.37	25.14	Pass
	159	5795	-1.13	1.09	6.02	0.13	7.24	25.14	Pass
1	151	5755	-1.93	0.29	6.02	0.13	6.44	25.14	Pass
	159	5795	-1.93	0.29	6.02	0.13	6.44	25.14	Pass
2	151	5755	-2.02	0.20	6.02	0.13	6.35	25.14	Pass
	159	5795	-1.61	0.61	6.02	0.13	6.76	25.14	Pass
3	151	5755	-1.66	0.56	6.02	0.13	6.71	25.14	Pass
	159	5795	-2.09	0.13	6.02	0.13	6.28	25.14	Pass

Note: 1. Directional gain = $10 \log[(10^{G1/20} + 10^{G2/20} + 10^{G3/20} + 10^{G4/20})^2 / 4] = 10.86\text{dBi} > 6\text{dBi}$, so the power density limit shall be reduced to $30 - (10.86 - 6) = 25.14\text{dBm}$.

2. Refer to section 3.3 for duty cycle spectrum plot.

802.11ac (VHT80)

TX chain	Chan.	Chan. Freq. (MHz)	PSD W/O Duty Factor		10 log (N=4) dB	Duty Factor (dB)	Total PSD With Duty Factor (dBm/500kHz)	Limit (dBm/500kHz)	Pass /Fail
			(dBm/300kHz)	(dBm/500kHz)					
0	155	5755	-7.12	-4.90	6.02	0.30	1.42	25.14	Pass
1	155	5755	-7.63	-5.41	6.02	0.30	0.91	25.14	Pass
2	155	5755	-7.44	-5.22	6.02	0.30	1.10	25.14	Pass
3	155	5755	-7.66	-5.44	6.02	0.30	0.88	25.14	Pass

Note: 1. Directional gain = $10 \log[(10^{G1/20} + 10^{G2/20} + 10^{G3/20} + 10^{G4/20})^2 / 4] = 10.86\text{dBi} > 6\text{dBi}$, so the power density limit shall be reduced to $30-(10.86-6) = 25.14\text{dBm}$.

2. Refer to section 3.3 for duty cycle spectrum plot.

Spectrum Plot of Worst Value

802.11a – Chain 0: CH 165

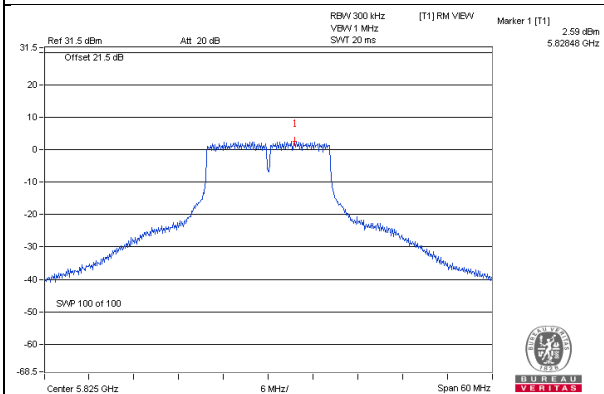

802.11ac (VHT20) – Chain 0: CH 165

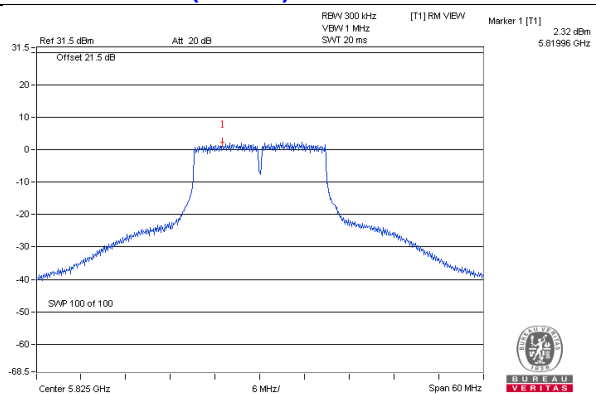

802.11ac (VHT40) – Chain 0: CH 151

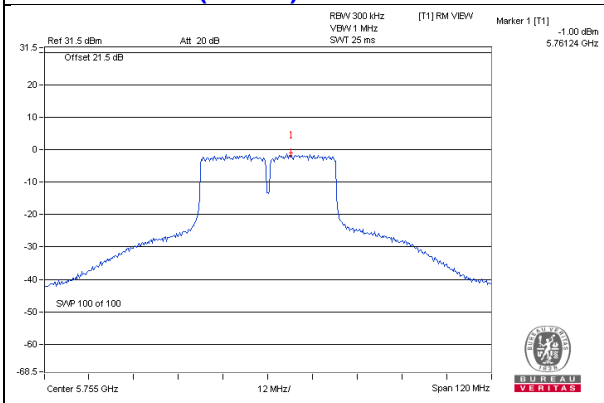

802.11ac (VHT80) – Chain 0: CH 155

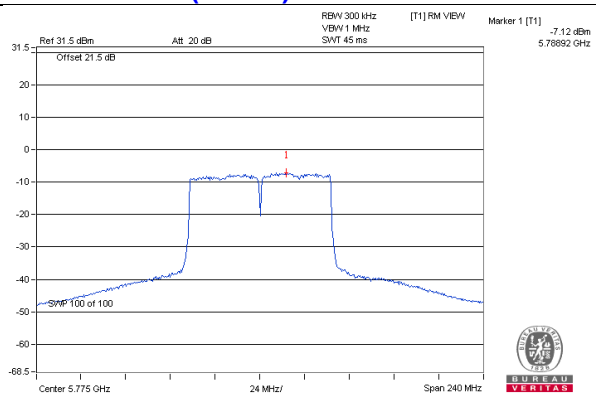

4.6 Frequency Stability Measurement

4.6.1 Limits of Frequency Stability Measurement

The frequency of the carrier signal shall be maintained within band of operation

4.6.2 Test Setup

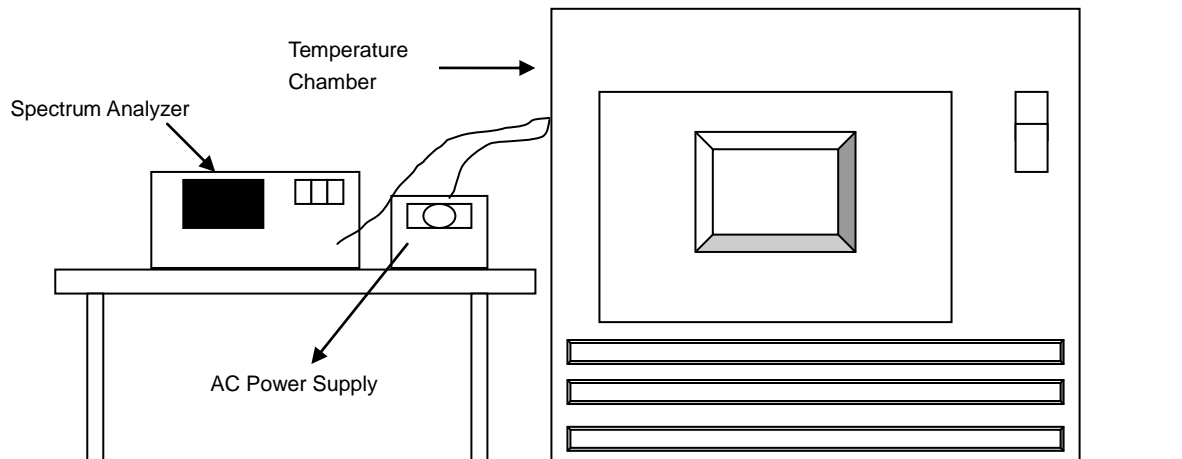

4.6.3 Test Instruments

Refer to section 4.1.2 to get information of above instrument.

4.6.4 Test Procedure

- The EUT was placed inside the environmental test chamber and powered by nominal AC voltage.
- Turn the EUT on and couple its output to a spectrum analyzer.
- Turn the EUT off and set the chamber to the highest temperature specified.
- Allow sufficient time (approximately 30 min) for the temperature of the chamber to stabilize, turn the EUT on and measure the operating frequency after 2, 5, and 10 Minutes.
- Repeat step 2 and 3 with the temperature chamber set to the lowest temperature.
- The test chamber was allowed to stabilize at +20 degree C for a minimum of 30 Minutes. The supply voltage was then adjusted on the EUT from 85% to 115% and the frequency record.

4.6.5 Deviation from Test Standard

No deviation.

4.6.6 EUT Operating Condition

Set the EUT transmit at un-modulation mode to test frequency stability.

4.6.7 Test Results

Frequency Stability Versus Temp.									
Operating Frequency: 5180 MHz									
TEMP. (°C)	Power Supply (Vac)	0 Minute		2 Minute		5 Minute		10 Minute	
		Measured Frequency (MHz)	Pass/Fail	Measured Frequency (MHz)	Pass/Fail	Measured Frequency (MHz)	Pass/Fail	Measured Frequency (MHz)	Pass/Fail
50	120	5180.0216	PASS	5180.0193	PASS	5180.0191	PASS	5180.0192	PASS
40	120	5179.9997	PASS	5180.0027	PASS	5179.9991	PASS	5179.9986	PASS
30	120	5179.984	PASS	5179.9858	PASS	5179.9855	PASS	5179.9871	PASS
20	120	5180.0266	PASS	5180.0259	PASS	5180.0237	PASS	5180.0244	PASS
10	120	5179.9852	PASS	5179.9844	PASS	5179.9875	PASS	5179.9845	PASS
0	120	5179.9895	PASS	5179.9927	PASS	5179.9905	PASS	5179.9899	PASS
-10	120	5180.0152	PASS	5180.0182	PASS	5180.0167	PASS	5180.0155	PASS
-20	120	5180.01	PASS	5180.0085	PASS	5180.0124	PASS	5180.0103	PASS
-30	120	5180.0149	PASS	5180.0136	PASS	5180.0132	PASS	5180.0109	PASS

Frequency Stability Versus Voltage									
Operating Frequency: 5180 MHz									
TEMP. (°C)	Power Supply (Vac)	0 Minute		2 Minute		5 Minute		10 Minute	
		Measured Frequency (MHz)	Pass/Fail	Measured Frequency (MHz)	Pass/Fail	Measured Frequency (MHz)	Pass/Fail	Measured Frequency (MHz)	Pass/Fail
20	138	5180.0263	PASS	5180.0262	PASS	5180.0236	PASS	5180.0244	PASS
	120	5180.0266	PASS	5180.0259	PASS	5180.0237	PASS	5180.0244	PASS
	102	5180.0275	PASS	5180.0264	PASS	5180.0241	PASS	5180.0235	PASS

4.7 6dB Bandwidth Measurement

4.7.1 Limits of 6dB Bandwidth Measurement

The minimum of 6dB Bandwidth Measurement is 0.5MHz.

4.7.2 Test Setup

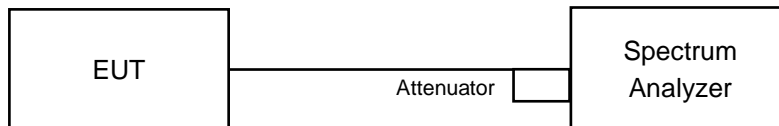

4.7.3 Test Instruments

Refer to section 4.1.2 to get information of above instrument.

4.7.4 Test Procedure

MEASUREMENT PROCEDURE REF

- Set resolution bandwidth (RBW) = 100kHz
- Set the video bandwidth (VBW) $\geq 3 \times$ RBW, Detector = Peak.
- Trace mode = max hold.
- Sweep = auto couple.
- Measure the maximum width of the emission that is constrained by the frequencies associated with the two amplitude points (upper and lower) that are attenuated by 6 dB relative to the maximum level measured in the fundamental emission

4.7.5 Deviation from Test Standard

No deviation.

4.7.6 EUT Operating Condition

The software provided by client to enable the EUT under transmission condition continuously at lowest, middle and highest channel frequencies individually.

4.7.7 Test Results

802.11a

Channel	Frequency (MHz)	6dB Bandwidth (MHz)				Minimum Limit (MHz)	Pass / Fail
		Chain 0	Chain 1	Chain 2	Chain 3		
149	5745	16.41	16.41	16.42	16.40	0.5	PASS
157	5785	16.41	16.42	16.42	16.41	0.5	PASS
165	5825	16.41	16.40	16.42	16.41	0.5	PASS

802.11ac (VHT20)

Channel	Frequency (MHz)	6dB Bandwidth (MHz)				Minimum Limit (MHz)	Pass / Fail
		Chain 0	Chain 1	Chain 2	Chain 3		
149	5745	17.68	17.67	17.67	17.64	0.5	PASS
157	5785	17.64	17.66	17.66	17.67	0.5	PASS
165	5825	17.61	17.62	17.67	17.60	0.5	PASS

802.11ac (VHT40)

Channel	Frequency (MHz)	6dB Bandwidth (MHz)				Minimum Limit (MHz)	Pass / Fail
		Chain 0	Chain 1	Chain 2	Chain 3		
151	5755	36.47	36.46	36.44	36.46	0.5	PASS
159	5795	36.44	36.47	36.46	36.45	0.5	PASS

802.11ac (VHT80)

Channel	Frequency (MHz)	6dB Bandwidth (MHz)				Minimum Limit (MHz)	Pass / Fail
		Chain 0	Chain 1	Chain 2	Chain 3		
155	5775	76.01	76.08	76.27	76.00	0.5	PASS

Spectrum Plot of Worst Value

802.11a_Chain 3 / CH149

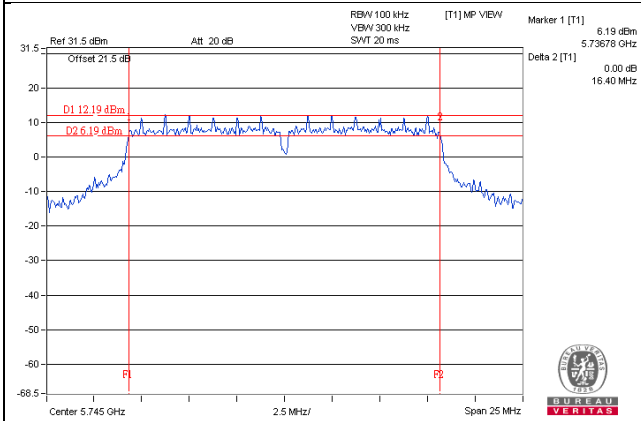

802.11ac (VHT20)_Chain 3 / CH165

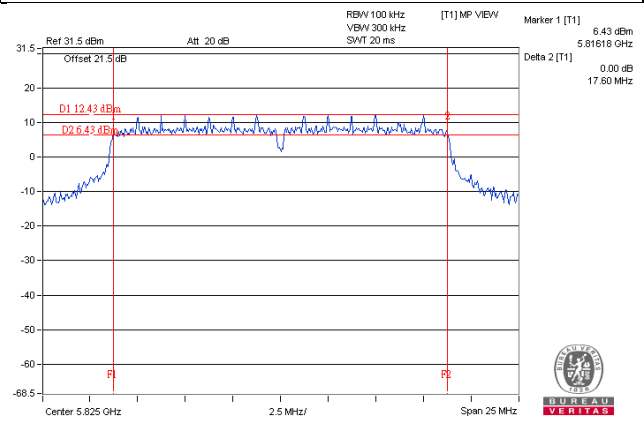

802.11ac (VHT40)_Chain 0 / CH159

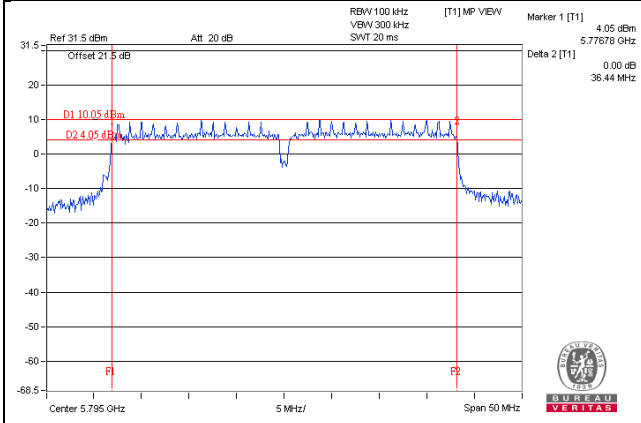

802.11ac (VHT80)_Chain 3 / CH155

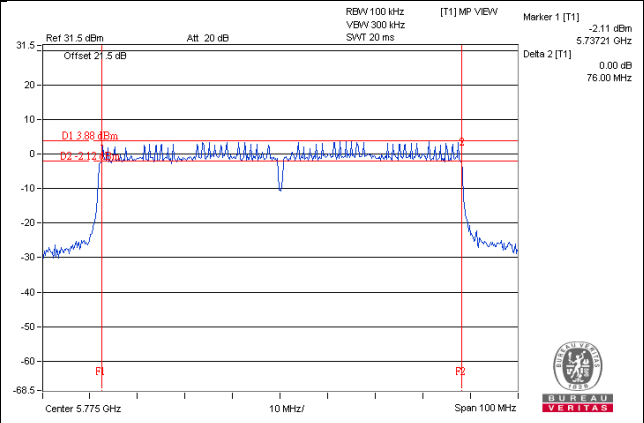

5 Pictures of Test Arrangements

Please refer to the attached file (Test Setup Photo).

Annex A- Radiated Out of Band Emission (OOBE) Measurement (For U-NII-3 band)

802.11a

CH 149 5745 MHz

Horizontal

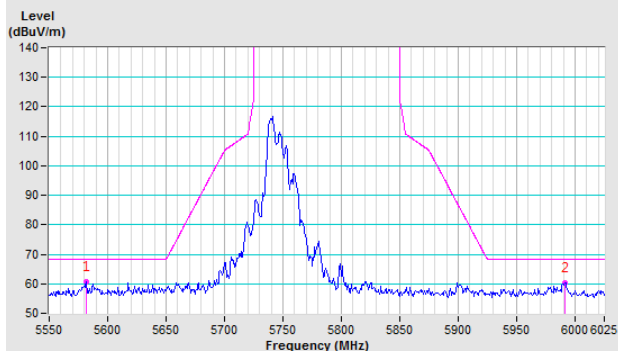

Vertical

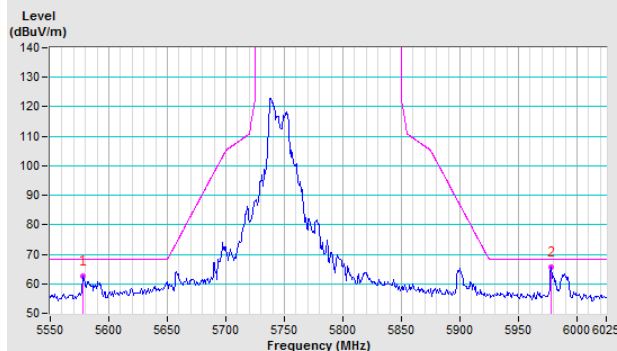

CH 157 5785 MHz

Horizontal

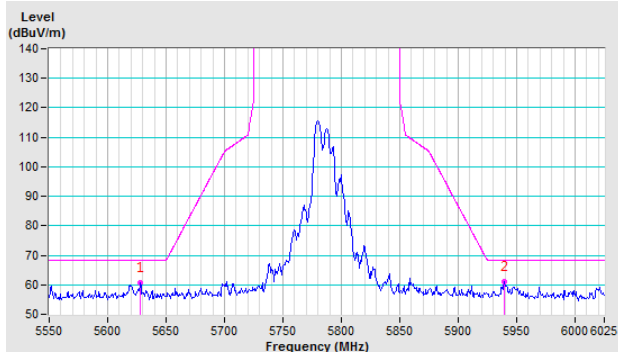

Vertical

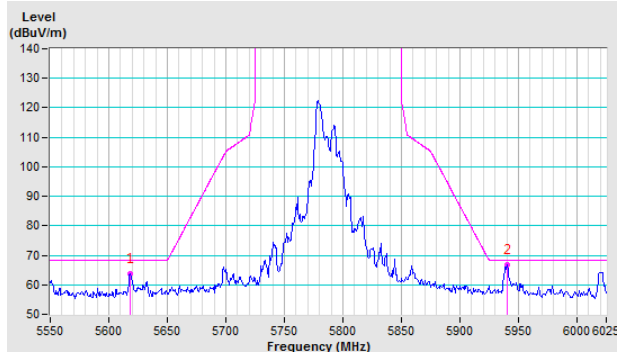

CH 165 5825 MHz

Horizontal

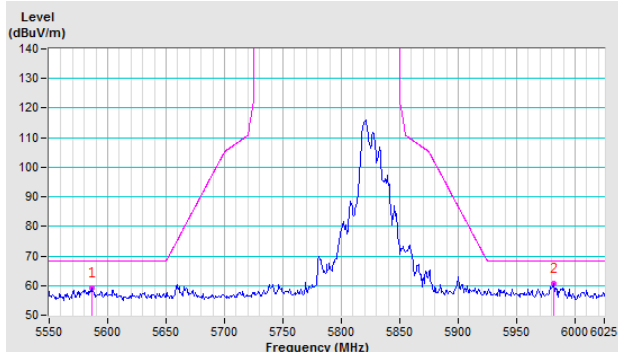

Vertical

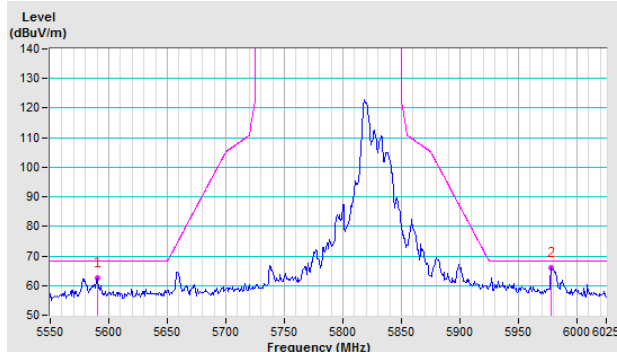

802.11ac (VHT20)

CH 149 5745 MHz

Horizontal

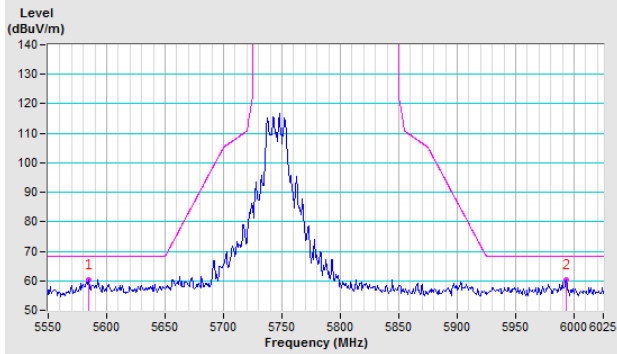

Vertical

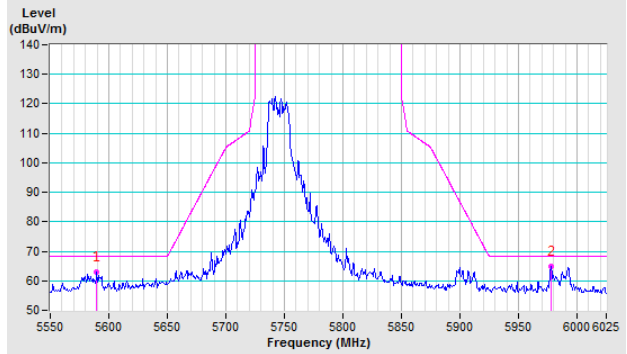

CH 157 5785 MHz

Horizontal

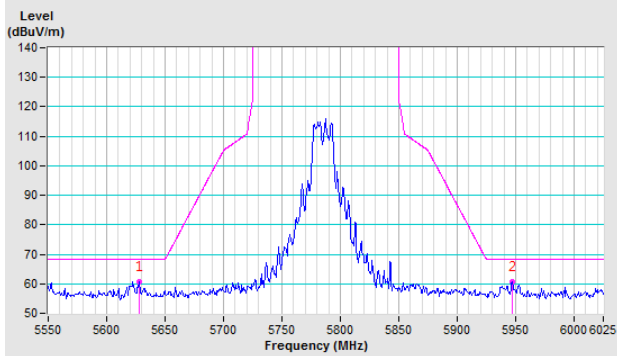

Vertical

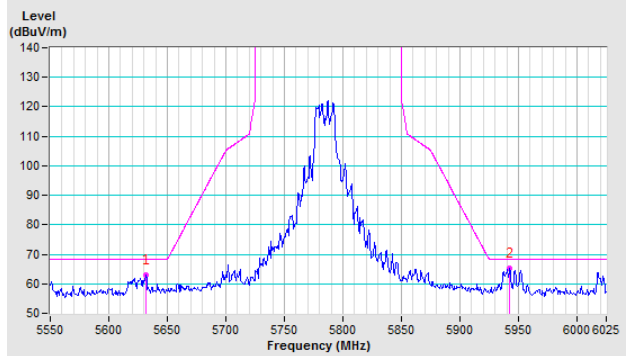

CH 165 5825 MHz

Horizontal

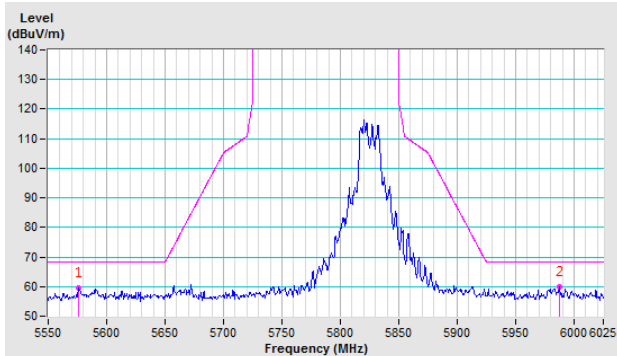

Vertical

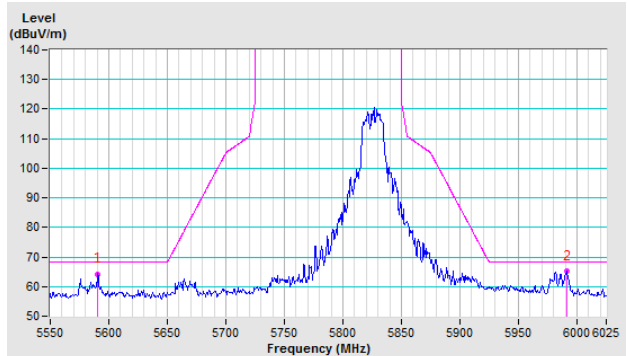

802.11ac (VHT40)

CH 151 5755 MHz

Horizontal

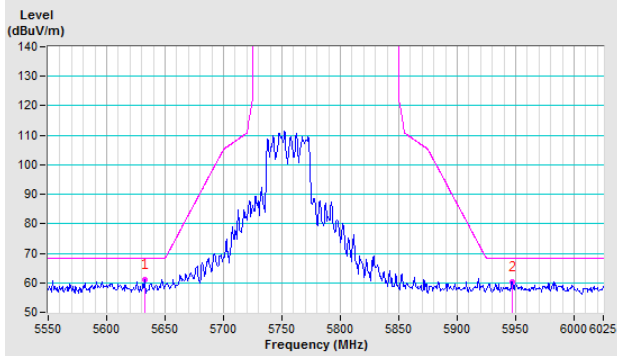

Vertical

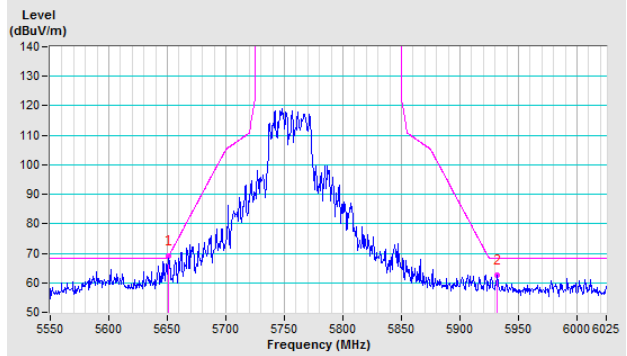

CH 159 5795 MHz

Horizontal

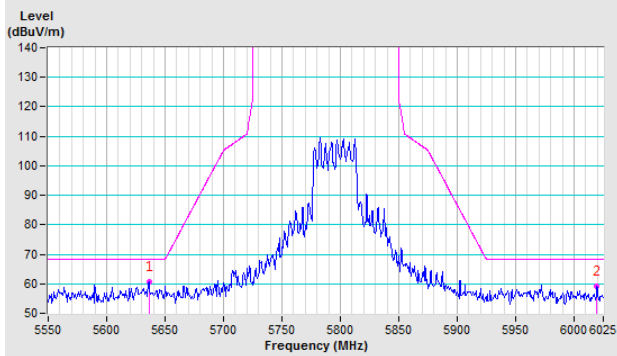

Vertical

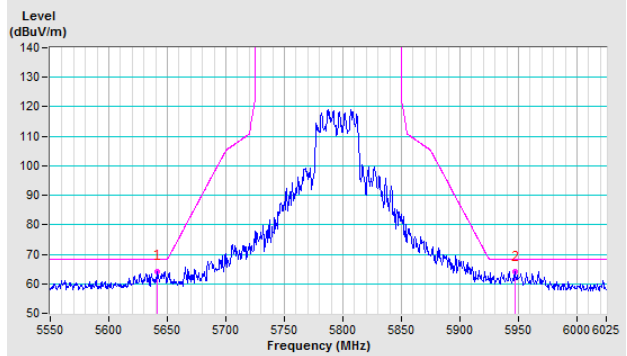

802.11ac (VHT80)

CH 155 5775 MHz

Horizontal

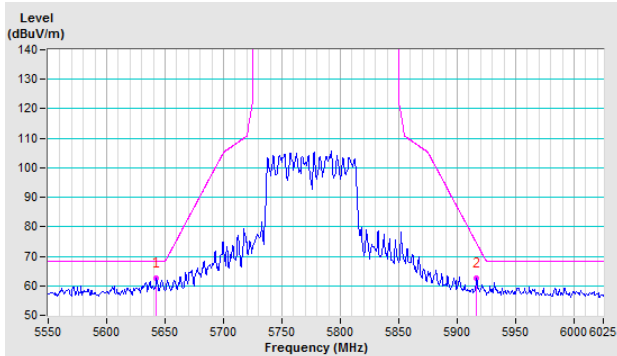

Vertical

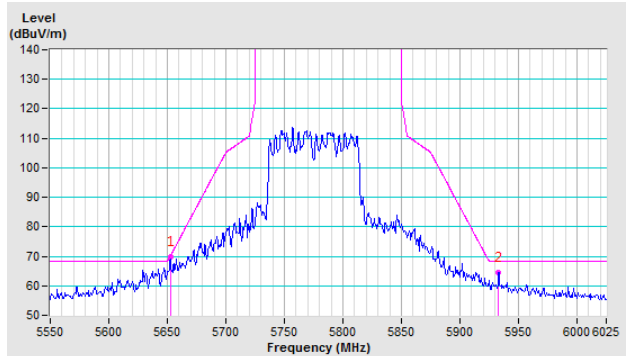

Appendix – Information on the Testing Laboratories

We, Bureau Veritas Consumer Products Services (H.K.) Ltd., Taoyuan Branch, were founded in 1988 to provide our best service in EMC, Radio, Telecom and Safety consultation. Our laboratories are accredited and approved according to ISO/IEC 17025.

If you have any comments, please feel free to contact us at the following:

Linko EMC/RF Lab

Tel: 886-2-26052180

Fax: 886-2-26051924

Hsin Chu EMC/RF/Telecom Lab

Tel: 886-3-6668565

Fax: 886-3-6668323

Hwa Ya EMC/RF/Safety Lab

Tel: 886-3-3183232

Fax: 886-3-3270892

Email: service.adt@tw.bureauveritas.com

Web Site: www.bureauveritas-adt.com

The address and road map of all our labs can be found in our web site also.

--- END ---