

FCC Test Report

Report No.: RF181210E01-1

FCC ID: XCNR1UBC1310

Test Model: R1UBC1310

Received Date: Dec. 10, 2018

Test Date: Dec. 17, 2018 to Jan. 07, 2019

Issued Date: Jan. 22, 2019

Applicant: Ubee Interactive Corp.

Address: 10F-1, No. 5, Taiyuan 1st St. Jhubei Ci, Hsinchu County 302, Taiwan ,
R.O.C.

Issued By: Bureau Veritas Consumer Products Services (H.K.) Ltd., Taoyuan Branch
Hsin Chu Laboratory

Lab Address: E-2, No.1, Li Hsin 1st Road, Hsinchu Science Park, Hsinchu City 300,
Taiwan R.O.C.

Test Location: E-2, No.1, Li Hsin 1st Road, Hsinchu Science Park, Hsinchu City 300,
Taiwan R.O.C.

**FCC Registration /
Designation Number:** 723255 / TW2022



This report is for your exclusive use. Any copying or replication of this report to or for any other person or entity, or use of our name or trademark, is permitted only with our prior written permission. This report sets forth our findings solely with respect to the test samples identified herein. The results set forth in this report are not indicative or representative of the quality or characteristics of the lot from which a test sample was taken or any similar or identical product unless specifically and expressly noted. Our report includes all of the tests requested by you and the results thereof based upon the information that you provided to us. You have 60 days from date of issuance of this report to notify us of any material error or omission caused by our negligence, provided, however, that such notice shall be in writing and shall specifically address the issue you wish to raise. A failure to raise such issue within the prescribed time shall constitute your unqualified acceptance of the completeness of this report, the tests conducted and the correctness of the report contents. Unless specific mention, the uncertainty of measurement has been explicitly taken into account to declare the compliance or non-compliance to the specification. The report must not be used by the client to claim product certification, approval, or endorsement by TAF or any government agencies.

Table of Contents

Release Control Record	4
1 Certificate of Conformity	5
2 Summary of Test Results	6
2.1 Measurement Uncertainty	6
2.2 Modification Record	6
3 General Information	7
3.1 General Description of EUT	7
3.2 Description of Test Modes	9
3.2.1 Test Mode Applicability and Tested Channel Detail	10
3.3 Duty Cycle of Test Signal	12
3.4 Description of Support Units	13
3.4.1 Configuration of System under Test	14
3.5 General Description of Applied Standard	15
4 Test Types and Results	16
4.1 Radiated Emission and Bandedge Measurement	16
4.1.1 Limits of Radiated Emission and Bandedge Measurement	16
4.1.2 Test Instruments	17
4.1.3 Test Procedure	19
4.1.4 Deviation from Test Standard	19
4.1.5 Test Setup	20
4.1.6 EUT Operating Condition	21
4.1.7 Test Results	22
4.2 Conducted Emission Measurement	42
4.2.1 Limits of Conducted Emission Measurement	42
4.2.2 Test Instruments	42
4.2.3 Test Procedure	43
4.2.4 Deviation from Test Standard	43
4.2.5 Test Setup	43
4.2.6 EUT Operating Condition	43
4.2.7 Test Results	44
4.3 Transmit Power Measurement	46
4.3.1 Limits of Transmit Power Measurement	46
4.3.2 Test Setup	47
4.3.3 Test Instruments	47
4.3.4 Test Procedure	47
4.3.5 Deviation from Test Standard	47
4.3.6 EUT Operating Condition	47
4.3.7 Test Results	48
4.4 Occupied Bandwidth Measurement	51
4.4.1 Test Setup	51
4.4.2 Test Instruments	51
4.4.3 Test Procedure	51
4.4.4 Test Results	52
4.5 Peak Power Spectral Density Measurement	58
4.5.1 Limits of Peak Power Spectral Density Measurement	58
4.5.2 Test Setup	58
4.5.3 Test Instruments	58
4.5.4 Test Procedure	59
4.5.5 Deviation from Test Standard	59
4.5.6 EUT Operating Condition	59
4.5.7 Test Results	60
4.6 Frequency Stability Measurement	66
4.6.1 Limits of Frequency Stability Measurement	66

4.6.2	Test Setup.....	66
4.6.3	Test Instruments	66
4.6.4	Test Procedure	66
4.6.5	Deviation from Test Standard	66
4.6.6	EUT Operating Condition	66
4.6.7	Test Results	67
4.7	6dB Bandwidth Measurement	68
4.7.1	Limits of 6dB Bandwidth Measurement.....	68
4.7.2	Test Setup.....	68
4.7.3	Test Instruments	68
4.7.4	Test Procedure	68
4.7.5	Deviation from Test Standard	68
4.7.6	EUT Operating Condition	68
4.7.7	Test Results	69
5	Pictures of Test Arrangements.....	71
	Annex A- Radiated Out of Band Emission (OOBE) Measurement (For U-NII-3 band)	72
	Appendix – Information of the Testing Laboratories	75

Release Control Record

Issue No.	Description	Date Issued
RF181210E01-1	Original release.	Jan. 22, 2019

1 Certificate of Conformity

Product: Cable modem

Brand: Ubee

Test Model: R1UBC1310

Applicant: Ubee Interactive Corp.

Test Date: Dec. 17, 2018 to Jan. 07, 2019

Standard: 47 CFR FCC Part 15, Subpart E (Section 15.407)
ANSI C63.10: 2013

The above equipment has been tested by **Bureau Veritas Consumer Products Services (H.K.) Ltd., Taoyuan Branch**, and found compliance with the requirement of the above standards. The test record, data evaluation & Equipment Under Test (EUT) configurations represented herein are true and accurate accounts of the measurements of the sample's EMC characteristics under the conditions specified in this report.

Prepared by :  , **Date:** Jan. 22, 2019
Claire Kuan / Specialist

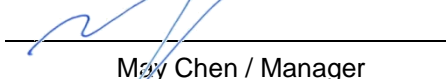
Approved by :  , **Date:** Jan. 22, 2019
May Chen / Manager

2 Summary of Test Results

47 CFR FCC Part 15, Subpart E (Section 15.407)			
FCC Clause	Test Item	Result	Remarks
15.407(b)(6)	AC Power Conducted Emissions	Pass	Meet the requirement of limit. Minimum passing margin is -11.62dB at 0.15000MHz.
15.407(b) (1/2/3/4(i/ii)/6)	Radiated Emissions & Band Edge Measurement*	Pass	Meet the requirement of limit. Minimum passing margin is -0.1dB at 5137.60MH, 5150.00MHz, 5147.50MHz
15.407(a)(1/2/3)	Max Average Transmit Power	Pass	Meet the requirement of limit.
---	Occupied Bandwidth Measurement	-	Reference only.
15.407(a)(1/2/3)	Peak Power Spectral Density	Pass	Meet the requirement of limit.
15.407(e)	6dB bandwidth	Pass	Meet the requirement of limit. (U-NII-3 Band only)
15.407(g)	Frequency Stability	Pass	Meet the requirement of limit.
15.203	Antenna Requirement	Pass	Antenna connector is i-pex (MHF) not a standard connector.

*For U-NII-3 band compliance with rule part 15.407(b)(4)(i), the OOB test plots were recorded in Annex A.

Note:

Determining compliance based on the results of the compliance measurement, not taking into account measurement instrumentation uncertainty.

2.1 Measurement Uncertainty

Where relevant, the following measurement uncertainty levels have been estimated for tests performed on the EUT as specified in CISPR 16-4-2:

Measurement	Frequency	Expanded Uncertainty (k=2) (\pm)
Conducted Emissions at mains ports	150kHz ~ 30MHz	1.84 dB
Radiated Emissions up to 1 GHz	30MHz ~ 1GHz	5.53 dB
Radiated Emissions above 1 GHz	1GHz ~ 6GHz	5.08 dB
	6GHz ~ 18GHz	4.98 dB
	18GHz ~ 40GHz	5.19 dB

2.2 Modification Record

There were no modifications required for compliance.

3 General Information

3.1 General Description of EUT

Product	Cable modem
Brand	Ubee
Test Model	R1UBC1310
Power Supply Rating	12Vdc from power adapter
Modulation Type	CCK, DQPSK, DBPSK for DSSS 64QAM, 16QAM, QPSK, BPSK for OFDM 256QAM for OFDM in 11ac mode and VHT (20/40) mode in 2.4GHz
Modulation Technology	DSSS, OFDM
Transfer Rate	802.11b: up to 11Mbps 802.11a/g: up to 54Mbps 802.11n: up to 450Mbps 802.11ac: up to 1300Mbps
Operating Frequency	2.4GHz: 2.412GHz ~ 2.462GHz 5GHz: 5.18GHz ~ 5.24GHz, 5.745GHz ~ 5.825GHz
Number of Channel	2.4GHz: 802.11b, 802.11g, 802.11n (HT20), VHT20: 11 802.11n (HT40), VHT40: 7 5GHz: 802.11a, 802.11n (HT20), 802.11ac (VHT20): 9 802.11n (HT40), 802.11ac (VHT40): 4 802.11ac (VHT80): 2
Output Power	2.412 ~ 2.462GHz: CDD Mode: 487.554 mW Beamforming Mode: 413.41mW 5.18 ~ 5.24GHz CDD Mode: 472.756 mW Beamforming Mode: 469.245mW 5.745 ~ 5.825GHz CDD Mode: 534.068mW Beamforming Mode: 472.395mW
Antenna Type	Refer to Note
Antenna Connector	Refer to Note
Accessory Device	Base x 1 Adapter x 1
Data Cable Supplied	RJ45 Cable x 1 (Unshielded, 1.5m)

Note:

1. Simultaneously transmission condition.

Condition	Technology	
1	WLAN (2.4GHz)	WLAN (5GHz)

Note: The emission of the simultaneous operation has been evaluated and no non-compliance was found.

2. The EUT must be supplied from a power adapter as the following table:

Brand	Model No.	Spec.
I.T.E Power Supply	MU24AY120200-A1	Input: 100-240Vac, 0.7A, 50/60Hz Output: 12Vdc, 2A DC output cable (Unshielded, 1.5m)

3. The antennas provided to the EUT, please refer to the following table:

Antenna No.	Transmitter Circuit	Ant. Net Gain (dBi)	Freq. range (GHz)	Ant. Type	Connector Type	Cable Length (mm)
1	Chain 2	3.92	2.4~2.4835	PCB	i-pex(MHF)	42
	Chain 0	4.81	5.15~5.85			
2	Chain 1	3.73	2.4~2.4835	PCB	i-pex(MHF)	50
	Chain 1	3.86	5.15~5.85			
3	Chain 0	3.27	2.4~2.4835	PCB	i-pex(MHF)	92.5
	Chain 2	4.54	5.15~5.85			

4. The EUT incorporates a MIMO function

2.4GHz Band		
MODULATION MODE	TX & RX CONFIGURATION	
802.11b	3TX	3RX
802.11g	3TX	3RX
802.11n (HT20)	3TX	3RX
802.11n (HT40)	3TX	3RX
VHT20 (Support 256QAM)	3TX	3RX
VHT40 (Support 256QAM)	3TX	3RX
5GHz Band		
MODULATION MODE	TX & RX CONFIGURATION	
802.11a	3TX	3RX
802.11n (HT20)	3TX	3RX
802.11n (HT40)	3TX	3RX
802.11ac (VHT20)	3TX	3RX
802.11ac (VHT40)	3TX	3RX
802.11ac (VHT80)	3TX	3RX

Note:

- All of modulation mode support beamforming function except 802.11a/b/g modulation mode.
- The EUT support Beamforming and CDD mode, therefore both mode were investigated and the worst case scenario was identified. The worst case data were presented in test report.
- The modulation and bandwidth are similar for 802.11n mode for 20MHz (40MHz) and 802.11ac mode for 20MHz (40MHz), therefore investigated worst case to representative mode in test report. (Final test mode refer section 3.2.1)

5. The above EUT information is declared by manufacturer and for more detailed features description, please refers to the manufacturer's specifications or user's manual.

3.2 Description of Test Modes

FOR 5180 ~ 5240MHz

4 channels are provided for 802.11a, 802.11n (HT20), 802.11ac (VHT20):

Channel	Frequency	Channel	Frequency
36	5180 MHz	44	5220 MHz
40	5200 MHz	48	5240 MHz

2 channels are provided for 802.11n (HT40), 802.11ac (VHT40):

Channel	Frequency	Channel	Frequency
38	5190 MHz	46	5230 MHz

1 channel is provided for 802.11ac (VHT80):

Channel	Frequency
42	5210 MHz

FOR 5745 ~ 5825MHz:

5 channels are provided for 802.11a, 802.11n (HT20), 802.11ac (VHT20):

Channel	Frequency	Channel	Frequency
149	5745 MHz	161	5805 MHz
153	5765 MHz	165	5825 MHz
157	5785 MHz		

2 channels are provided for 802.11n (HT40), 802.11ac (VHT40):

Channel	Frequency	Channel	Frequency
151	5755 MHz	159	5795 MHz

1 channel is provided for 802.11ac (VHT80):

Channel	Frequency
155	5775 MHz

3.2.1 Test Mode Applicability and Tested Channel Detail

EUT Configure Mode	Applicable To				Description
	RE \geq 1G	RE<1G	PLC	APCM	
-	√	√	√	√	-

Where **RE \geq 1G**: Radiated Emission above 1GHz
RE<1G: Radiated Emission below 1GHz
PLC: Power Line Conducted Emission
APCM: Antenna Port Conducted Measurement

Radiated Emission Test (Above 1GHz):

- Pre-Scan has been conducted to determine the worst-case mode from all possible combinations between available modulations, data rates and antenna ports (if EUT with antenna diversity architecture).
- Following channel(s) was (were) selected for the final test as listed below.

CDD Mode						
Mode	FREQ. Band (MHz)	Available Channel	Tested Channel	Modulation Technology	Modulation Type	Data Rate (Mbps)
802.11a	5180-5240	36 to 48	36, 40, 48	OFDM	BPSK	6
802.11ac (VHT20)		36 to 48	36, 40, 48	OFDM	BPSK	6.5
802.11ac (VHT40)		38 to 46	38, 46	OFDM	BPSK	13.5
802.11ac (VHT80)		42	42	OFDM	BPSK	29.3
802.11a	5745-5825	149 to 165	149, 157, 165	OFDM	BPSK	6
802.11ac (VHT20)		149 to 165	149, 157, 165	OFDM	BPSK	6.5
802.11ac (VHT40)		151 to 159	151, 159	OFDM	BPSK	13.5
802.11ac (VHT80)		155	155	OFDM	BPSK	29.3

Radiated Emission Test (Below 1GHz):

- Pre-Scan has been conducted to determine the worst-case mode from all possible combinations between available modulations, data rates and antenna ports (if EUT with antenna diversity architecture).
- Following channel(s) was (were) selected for the final test as listed below.

CDD Mode						
Mode	FREQ. Band (MHz)	Available Channel	Tested Channel	Modulation Technology	Modulation Type	Data Rate (Mbps)
802.11ac (VHT20)	5180-5240, 5745-5825	36 to 48, 149 to 165	165	OFDM	BPSK	6.5

Power Line Conducted Emission Test:

- Pre-Scan has been conducted to determine the worst-case mode from all possible combinations between available modulations, data rates and antenna ports (if EUT with antenna diversity architecture).
- Following channel(s) was (were) selected for the final test as listed below.

CDD Mode						
Mode	FREQ. Band (MHz)	Available Channel	Tested Channel	Modulation Technology	Modulation Type	Data Rate (Mbps)
802.11ac (VHT20)	5180-5240, 5745-5825	36 to 48, 149 to 165	165	OFDM	BPSK	6.5

Antenna Port Conducted Measurement:

- This item includes all test value of each mode, but only includes spectrum plot of worst value of each mode.
- Pre-Scan has been conducted to determine the worst-case mode from all possible combinations between available modulations, data rates and antenna ports (if EUT with antenna diversity architecture).
- Following channel(s) was (were) selected for the final test as listed below.

CDD Mode						
Mode	FREQ. Band (MHz)	Available Channel	Tested Channel	Modulation Technology	Modulation Type	Data Rate (Mbps)
802.11a	5180-5240	36 to 48	36, 40, 48	OFDM	BPSK	6
802.11ac (VHT20)		36 to 48	36, 40, 48	OFDM	BPSK	6.5
802.11ac (VHT40)		38 to 46	38, 46	OFDM	BPSK	13.5
802.11ac (VHT80)		42	42	OFDM	BPSK	29.3
802.11a	5745-5825	149 to 165	149, 157, 165	OFDM	BPSK	6
802.11ac (VHT20)		149 to 165	149, 157, 165	OFDM	BPSK	6.5
802.11ac (VHT40)		151 to 159	151, 159	OFDM	BPSK	13.5
802.11ac (VHT80)		155	155	OFDM	BPSK	29.3
Beamforming Mode (output power only)						
Mode	FREQ. Band (MHz)	Available Channel	Tested Channel	Modulation Technology	Modulation Type	Data Rate (Mbps)
802.11ac (VHT20)	5180-5240	36 to 48	36, 40, 48	OFDM	BPSK	6.5
802.11ac (VHT40)		38 to 46	38, 46	OFDM	BPSK	13.5
802.11ac (VHT80)		42	42	OFDM	BPSK	29.3
802.11ac (VHT20)	5745-5825	149 to 165	149, 157, 165	OFDM	BPSK	6.5
802.11ac (VHT40)		151 to 159	151, 159	OFDM	BPSK	13.5
802.11ac (VHT80)		155	155	OFDM	BPSK	29.3

Test Condition:

Applicable To	Environmental Conditions	Input Power	Tested By
RE \geq 1G	21deg. C, 66%RH	120Vac, 60Hz	Rey Chen
RE $<$ 1G	22deg. C, 66%RH	120Vac, 60Hz	Steven Chiang
PLC	24deg. C, 74%RH	120Vac, 60Hz	Andy Ho
APCM	25deg. C, 60%RH	120Vac, 60Hz	Anderson Chen

3.3 Duty Cycle of Test Signal

If duty cycle of test signal is $\geq 98\%$, duty factor is not required.

If duty cycle of test signal is $< 98\%$, duty factor shall be considered.

802.11a: Duty cycle = $2.061/2.096 = 0.983$

802.11ac (VHT20): Duty cycle = $1.917/1.964 = 0.976$, Duty factor = $10 * \log(1/0.976) = 0.11$

802.11ac (VHT40): Duty cycle = $0.942/0.972 = 0.969$, Duty factor = $10 * \log(1/0.969) = 0.14$

802.11ac (VHT80): Duty cycle = $0.459/0.488 = 0.941$, Duty factor = $10 * \log(1/0.941) = 0.27$

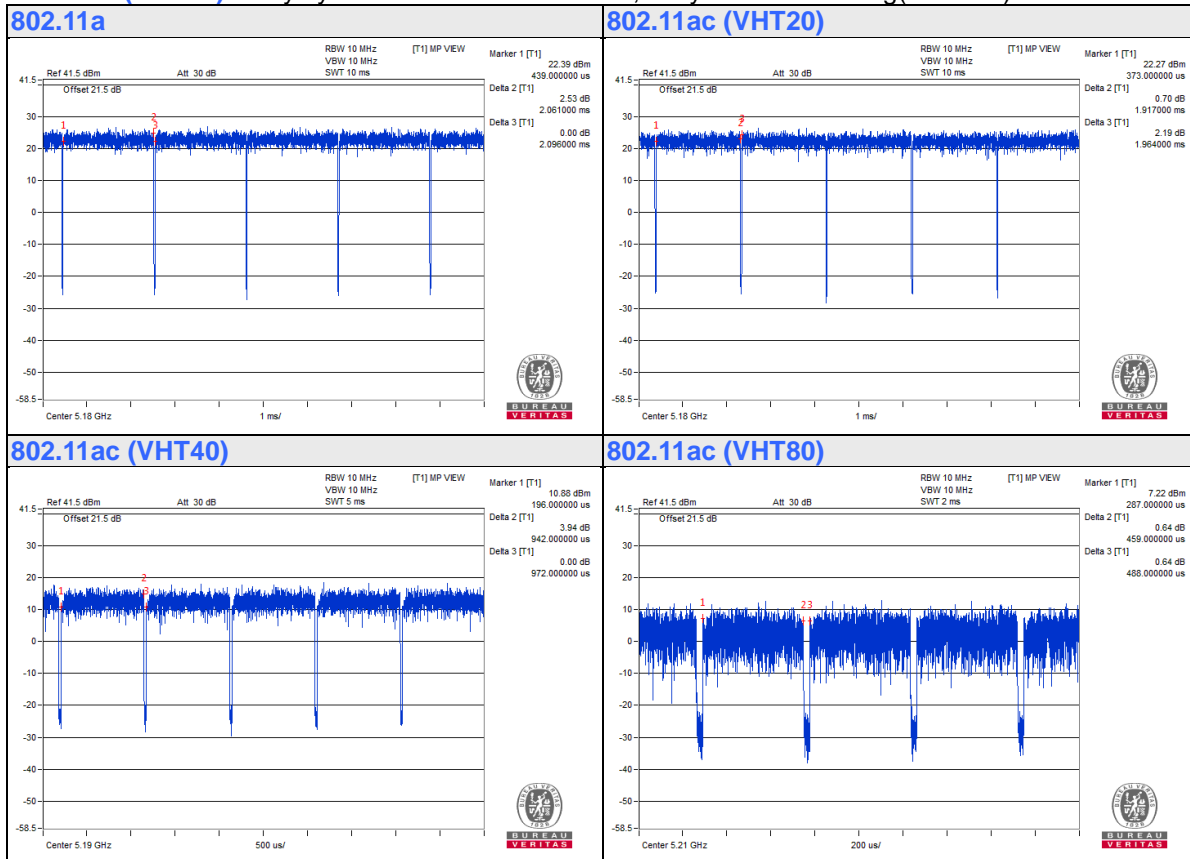

3.4 Description of Support Units

The EUT has been tested as an independent unit together with other necessary accessories or support units. The following support units or accessories were used to form a representative test configuration during the tests.

ID	Product	Brand	Model No.	Serial No.	FCC ID	Remarks
A.	Telephone	WONDER	WD-303	7C17KA04011	NA	Provided by Lab
B.	Laptop	DELL	E6420	B92T3R1	FCC DoC	Provided by Lab

Note:

1. All power cords of the above support units are non-shielded (1.8m).

ID	Descriptions	Qty.	Length (m)	Shielding (Yes/No)	Cores (Qty.)	Remarks
1.	DC Cable	1	1.5	No	0	Supplied by client
2.	RJ-11 Cable	1	10	No	0	Provided by Lab
3.	RJ-45 Cable	1	10	No	0	Provided by Lab
4.	Coaxial Cable	1	10	Yes	0	Provided by Lab

3.4.1 Configuration of System under Test

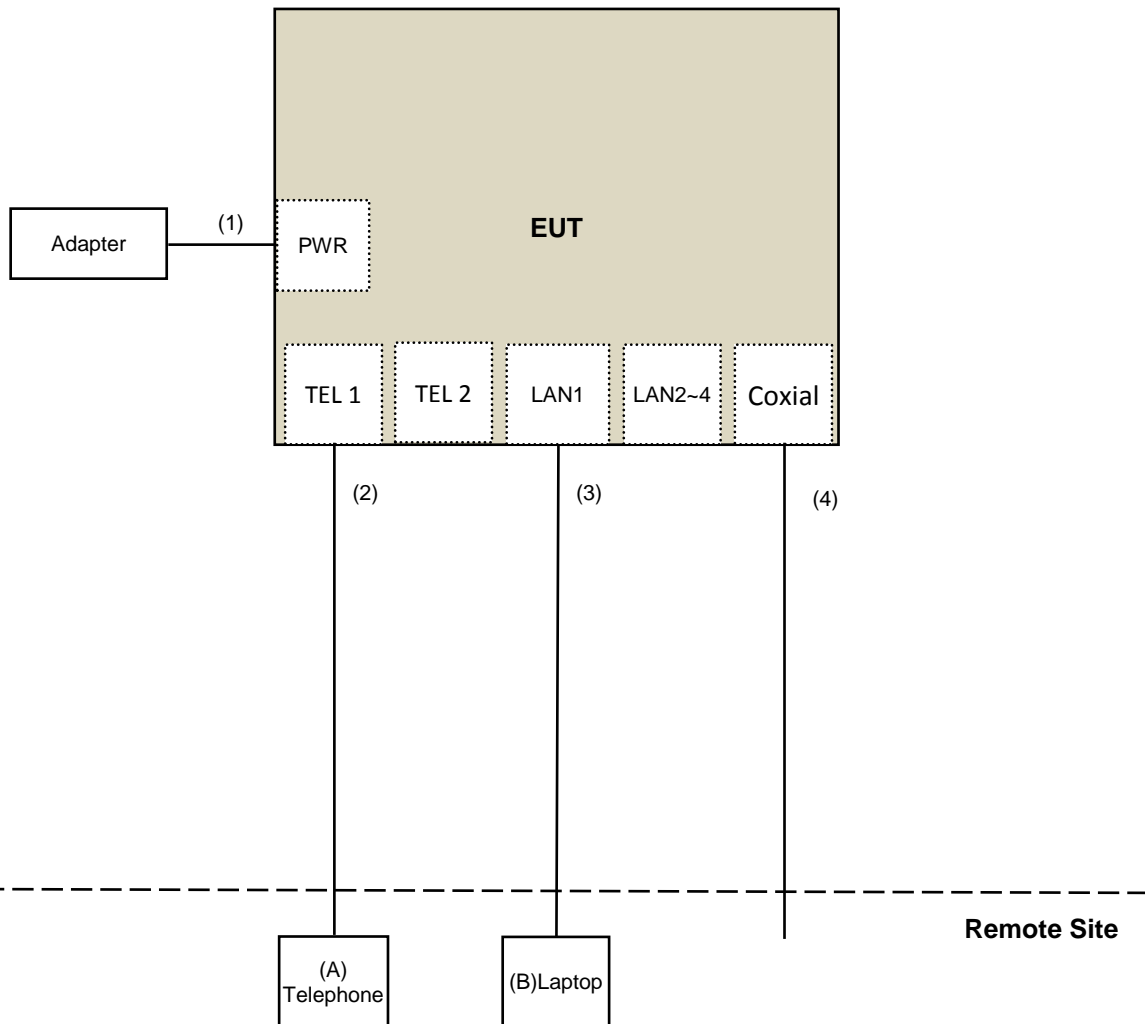

3.5 General Description of Applied Standard

The EUT is a RF Product. According to the specifications of the manufacturer, it must comply with the requirements of the following standards:

FCC Part 15, Subpart E (15.407)

KDB 789033 D02 General UNII Test Procedure New Rules v02r01

KDB 662911 D01 Multiple Transmitter Output v02r01

ANSI C63.10-2013

All test items have been performed and recorded as per the above standards.

4 Test Types and Results

4.1 Radiated Emission and Bandedge Measurement

4.1.1 Limits of Radiated Emission and Bandedge Measurement

Radiated emissions which fall in the restricted bands must comply with the radiated emission limits specified as below table.

Frequencies (MHz)	Field Strength (microvolts/meter)	Measurement Distance (meters)
0.009 ~ 0.490	2400/F(kHz)	300
0.490 ~ 1.705	24000/F(kHz)	30
1.705 ~ 30.0	30	30
30 ~ 88	100	3
88 ~ 216	150	3
216 ~ 960	200	3
Above 960	500	3

NOTE:

1. The lower limit shall apply at the transition frequencies.
2. Emission level (dBuV/m) = 20 log Emission level (uV/m).
3. For frequencies above 1000MHz, the field strength limits are based on average detector, however, the peak field strength of any emission shall not exceed the maximum permitted average limits, specified above by more than 20dB under any condition of modulation.

Limits of unwanted emission out of the restricted bands

Applicable To		Limit	
789033 D02 General UNII Test Procedure New Rules v02r01		Field Strength at 3m	
		PK:74 (dBuV/m)	AV:54 (dBuV/m)
Frequency Band	Applicable To	EIRP Limit	Equivalent Field Strength at 3m
5150~5250 MHz	15.407(b)(1)	PK:-27 (dBm/MHz)	PK:68.2(dBuV/m)
5250~5350 MHz	15.407(b)(2)		
5470~5725 MHz	15.407(b)(3)		
5725~5850 MHz	<input checked="" type="checkbox"/> 15.407(b)(4)(i)	PK:-27 (dBm/MHz) ^{*1} PK:10 (dBm/MHz) ^{*2} PK:15.6 (dBm/MHz) ^{*3} PK:27 (dBm/MHz) ^{*4}	PK: 68.2(dBuV/m) ^{*1} PK:105.2 (dBuV/m) ^{*2} PK: 110.8(dBuV/m) ^{*3} PK:122.2 (dBuV/m) ^{*4}
	<input type="checkbox"/> 15.407(b)(4)(ii)	Emission limits in section 15.247(d)	
^{*1} beyond 75 MHz or more above of the band edge.		^{*2} below the band edge increasing linearly to 10 dBm/MHz at 25 MHz above.	
^{*3} below the band edge increasing linearly to a level of 15.6 dBm/MHz at 5 MHz above.		^{*4} from 5 MHz above or below the band edge increasing linearly to a level of 27 dBm/MHz at the band edge.	

Note:

The following formula is used to convert the equipment isotropic radiated power (eirp) to field strength:

$$E = \frac{1000000\sqrt{30P}}{3} \mu\text{V/m, where } P \text{ is the eirp (Watts).}$$

4.1.2 Test Instruments

DESCRIPTION & MANUFACTURER	MODEL NO.	SERIAL NO.	CALIBRATED DATE	CALIBRATED UNTIL
Test Receiver Agilent	N9038A	MY50010156	July 12, 2018	July 11, 2019
Pre-Amplifier EMCI	EMC001340	980142	Feb. 09, 2018	Feb. 08, 2019
Loop Antenna Electro-Metrics	EM-6879	269	Sep. 07, 2018	Sep. 06, 2019
RF Cable	NA	LOOPCAB-001	Jan. 15, 2018	Jan. 14, 2019
RF Cable	NA	LOOPCAB-002	Jan. 15, 2018	Jan. 14, 2019
Pre-Amplifier Mini-Circuits	ZFL-1000VH2B	AMP-ZFL-05	May 05, 2018	May 04, 2019
Trilog Broadband Antenna SCHWARZBECK	VULB 9168	9168-361	Nov. 22, 2018	Nov. 21, 2019
RF Cable	8D	966-3-1	Mar. 20, 2018	Mar. 19, 2019
RF Cable	8D	966-3-2	Mar. 20, 2018	Mar. 19, 2019
RF Cable	8D	966-3-3	Mar. 20, 2018	Mar. 19, 2019
Fixed attenuator Mini-Circuits	UNAT-5+	PAD-3m-3-01	Sep. 27, 2018	Sep. 26, 2019
Horn_Antenna SCHWARZBECK	BBHA9120-D	9120D-406	Nov. 25, 2018	Nov. 24, 2019
Pre-Amplifier EMCI	EMC12630SE	980384	Jan. 29, 2018	Jan. 28, 2019
RF Cable	EMC104-SM-SM-1200	160922	Jan. 29, 2018	Jan. 28, 2019
RF Cable	EMC104-SM-SM-2000	150317	Jan. 29, 2018	Jan. 28, 2019
RF Cable	EMC104-SM-SM-5000	150322	Jan. 29, 2018	Jan. 28, 2019
Spectrum Analyzer Keysight	N9030A	MY54490679	July 23, 2018	July 22, 2019
Pre-Amplifier EMCI	EMC184045SE	980386	Jan. 29, 2018	Jan. 28, 2019
Horn_Antenna SCHWARZBECK	BBHA 9170	BBHA9170608	Nov. 25, 2018	Nov. 24, 2019
RF Cable	EMC102-KM-KM-1200	160924	Jan. 29, 2018	Jan. 28, 2019
Software	ADT_Radiated_V8.7.08	NA	NA	NA
Antenna Tower & Turn Table Max-Full	MF-7802	MF780208406	NA	NA
Boresight Antenna Fixture	FBA-01	FBA-SIP01	NA	NA
Spectrum Analyzer R&S	FSV40	100964	June 20, 2018	June 19, 2019
Power meter Anritsu	ML2495A	1014008	May 09, 2018	May 08, 2019
Power sensor Anritsu	MA2411B	0917122	May 09, 2018	May 08, 2019
AC Power Source Extech Electronics	6205	1440452	NA	NA
DC Power Supply Topward	6603D	795558	NA	NA
Temperature & Humidity Chamber Giant Force	GTH-150-40-SP-AR	MAA0812-008	Jan. 10, 2018	Jan. 09, 2019
True RMS Clamp Meter FLUKE	325	31130711WS	May 22, 2018	May 21, 2019

Note:

1. The calibration interval of the above test instruments is 12 months and the calibrations are traceable to NML/ROC and NIST/USA.
2. The test was performed in 966 Chamber No. 3.
3. The CANADA Site Registration No. is 20331-1
4. Loop antenna was used for all emissions below 30 MHz.
5. Tested Date: Dec. 17, 2018 to Jan. 07, 2019

4.1.3 Test Procedure

For Radiated emission below 30MHz

- a. The EUT was placed on the top of a rotating table 0.8 meters above the ground at a 3 meter chamber room. The table was rotated 360 degrees to determine the position of the highest radiation.
- b. The EUT was set 3 meters away from the interference-receiving antenna, which was mounted on the top of a variable-height antenna tower.
- c. Parallel, perpendicular, and ground-parallel orientations of the antenna are set to make the measurement.
- d. For each suspected emission, the EUT was arranged to its worst case and the rotatable table was turned from 0 degrees to 360 degrees to find the maximum reading.
- e. The test-receiver system was set to Quasi-Peak Detect Function and Specified Bandwidth with Maximum Hold Mode.

Note:

1. The resolution bandwidth and video bandwidth of test receiver/spectrum analyzer is 9kHz at frequency below 30MHz.

For Radiated emission above 30MHz

- a. The EUT was placed on the top of a rotating table 0.8 meters (for 30MHz ~ 1GHz) / 1.5 meters (for above 1GHz) above the ground at 3 meter chamber room for test. The table was rotated 360 degrees to determine the position of the highest radiation.
- b. The EUT was set 3 meters away from the interference-receiving antenna, which was mounted on the top of a variable-height antenna tower.
- c. The height of antenna is varied from one meter to four meters above the ground to determine the maximum value of the field strength. Both horizontal and vertical polarizations of the antenna are set to make the measurement.
- d. For each suspected emission, the EUT was arranged to its worst case and then the antenna was tuned to heights from 1 meter to 4 meters and the rotatable table was turned from 0 degrees to 360 degrees to find the maximum reading.
- e. The test-receiver system was set to quasi-peak detect function and specified bandwidth with maximum hold mode when the test frequency is below 1 GHz.
- f. The test-receiver system was set to peak and average detects function and specified bandwidth with maximum hold mode when the test frequency is above 1 GHz. If the peak reading value also meets average limit, measurement with the average detector is unnecessary.

Note:

1. The resolution bandwidth and video bandwidth of test receiver/spectrum analyzer is 120kHz for Quasi-peak detection (QP) at frequency below 1GHz.
2. The resolution bandwidth of test receiver/spectrum analyzer is 1 MHz and the video bandwidth is 3 MHz for Peak detection (PK) at frequency above 1GHz.
3. The resolution bandwidth of test receiver/spectrum analyzer is 1MHz and the video bandwidth is $\geq 1/T$ (Duty cycle < 98%) or 10Hz (Duty cycle $\geq 98\%$) for Average detection (AV) at frequency above 1GHz.
4. All modes of operation were investigated and the worst-case emissions are reported.

4.1.4 Deviation from Test Standard

No deviation.

4.1.5 Test Setup

For Radiated emission below 30MHz

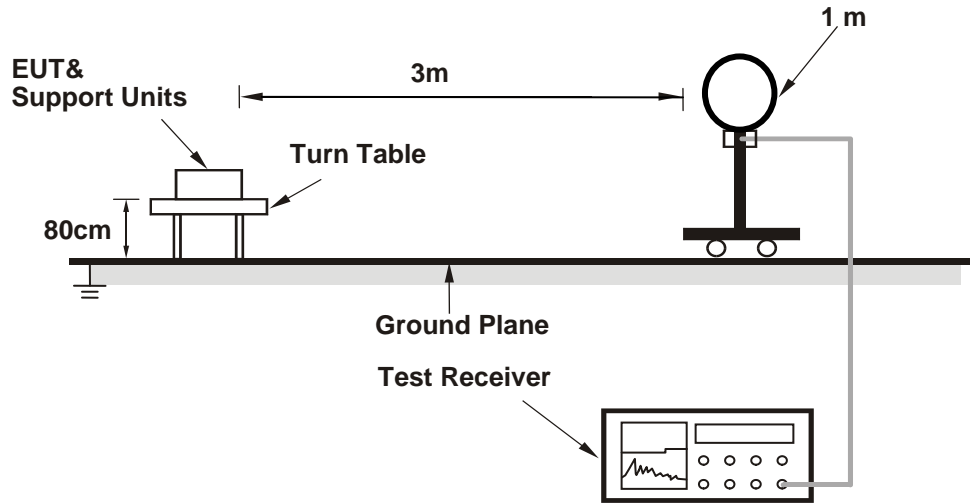

For Radiated emission 30MHz to 1GHz

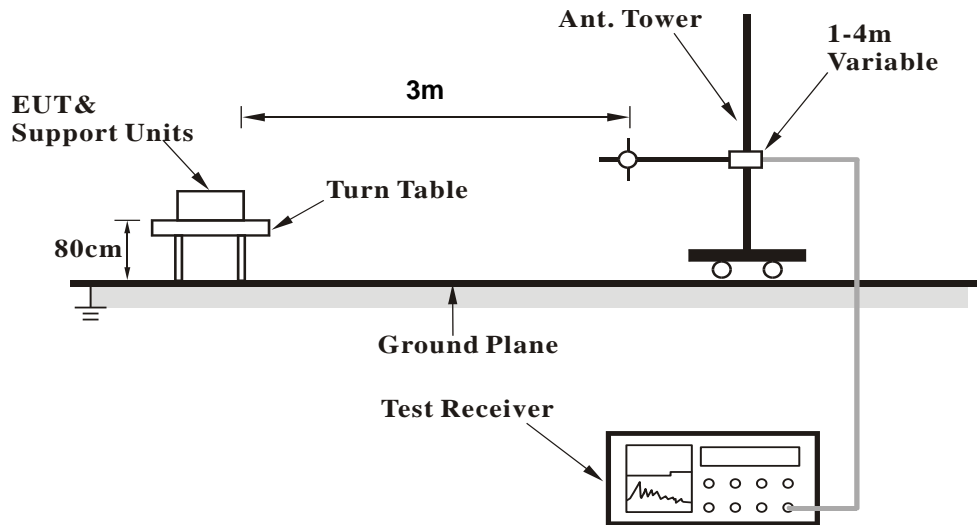

For Radiated emission above 1GHz

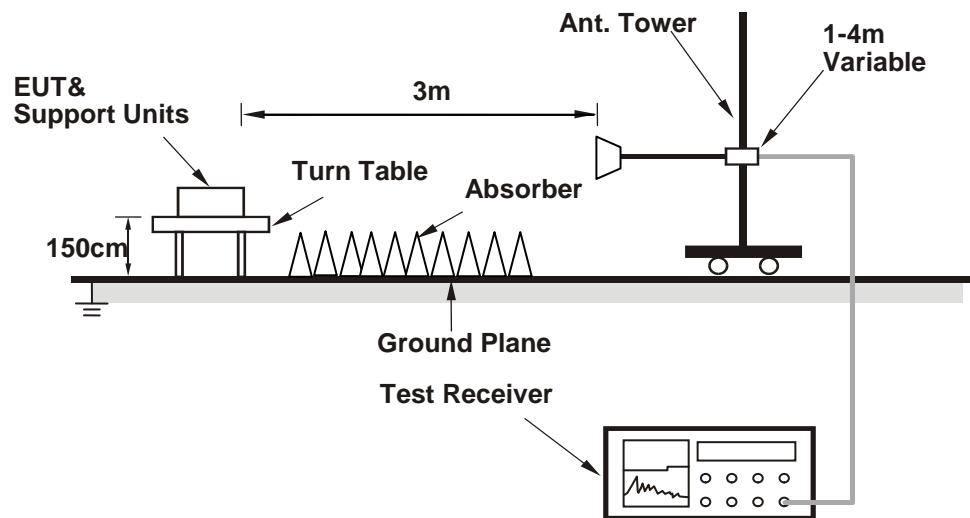

For the actual test configuration, please refer to the attached file (Test Setup Photo).

4.1.6 EUT Operating Condition

- a. Connected the EUT with the Laptop which is placed on remote site.
- b. Controlling software (Mtool (2.0.1.1)) has been activated to set the EUT on specific status.

4.1.7 Test Results

CDD Mode

Above 1GHz Data:

802.11a

CHANNEL	TX Channel 36	DETECTOR FUNCTION	Peak (PK)
FREQUENCY RANGE	1GHz ~ 40GHz		Average (AV)

ANTENNA POLARITY & TEST DISTANCE: HORIZONTAL AT 3 M

NO.	FREQ. (MHz)	EMISSION LEVEL (dBuV/m)	LIMIT (dBuV/m)	MARGIN (dB)	ANTENNA HEIGHT (m)	TABLE ANGLE (Degree)	RAW VALUE (dBuV)	CORRECTION FACTOR (dB/m)
1	5117.50	69.8 PK	74.0	-4.2	1.36 H	45	66.8	3.0
2	5117.50	53.4 AV	54.0	-0.6	1.36 H	45	50.4	3.0
3	*5180.00	116.2 PK			1.36 H	45	113.3	2.9
4	*5180.00	106.6 AV			1.36 H	45	103.7	2.9
5	#10360.00	56.4 PK	68.2	-11.8	1.44 H	354	44.1	12.3
6	15540.00	52.0 PK	74.0	-22.0	3.55 H	78	39.2	12.8
7	15540.00	40.2 AV	54.0	-13.8	3.55 H	78	27.4	12.8

ANTENNA POLARITY & TEST DISTANCE: VERTICAL AT 3 M

NO.	FREQ. (MHz)	EMISSION LEVEL (dBuV/m)	LIMIT (dBuV/m)	MARGIN (dB)	ANTENNA HEIGHT (m)	TABLE ANGLE (Degree)	RAW VALUE (dBuV)	CORRECTION FACTOR (dB/m)
1	5117.50	68.5 PK	74.0	-5.5	2.40 V	121	65.5	3.0
2	5117.50	51.0 AV	54.0	-3.0	2.40 V	121	48.0	3.0
3	*5180.00	113.7 PK			2.40 V	121	110.8	2.9
4	*5180.00	103.7 AV			2.40 V	121	100.8	2.9
5	#10360.00	57.4 PK	68.2	-10.8	1.54 V	95	45.1	12.3
6	15540.00	57.4 PK	74.0	-16.6	3.61 V	71	44.6	12.8
7	15540.00	43.3 AV	54.0	-10.7	3.61 V	71	30.5	12.8

REMARKS:

1. Emission Level(dBuV/m) = Raw Value(dBuV) + Correction Factor(dB/m)
2. Correction Factor(dB/m) = Antenna Factor(dB/m) + Cable Factor(dB) – Pre-Amplifier Factor(dB)
3. The other emission levels were very low against the limit.
4. Margin value = Emission Level – Limit value
5. " * ": Fundamental frequency.
6. " # ": The radiated frequency is out of the restricted band.

CHANNEL	TX Channel 40	DETECTOR FUNCTION	Peak (PK)
FREQUENCY RANGE	1GHz ~ 40GHz		Average (AV)

ANTENNA POLARITY & TEST DISTANCE: HORIZONTAL AT 3 M

NO.	FREQ. (MHz)	EMISSION LEVEL (dBuV/m)	LIMIT (dBuV/m)	MARGIN (dB)	ANTENNA HEIGHT (m)	TABLE ANGLE (Degree)	RAW VALUE (dBuV)	CORRECTION FACTOR (dB/m)
1	5117.50	57.8 PK	74.0	-16.2	2.13 H	36	54.8	3.0
2	5117.50	48.1 AV	54.0	-5.9	2.13 H	36	45.1	3.0
3	*5200.00	116.7 PK			2.13 H	36	113.9	2.8
4	*5200.00	106.6 AV			2.13 H	36	103.8	2.8
5	5398.90	61.6 PK	74.0	-12.4	2.13 H	36	58.8	2.8
6	5398.90	51.5 AV	54.0	-2.5	2.13 H	36	48.7	2.8
7	#10400.00	55.9 PK	68.2	-12.3	1.40 H	360	43.1	12.8
8	15600.00	51.6 PK	74.0	-22.4	3.49 H	67	38.3	13.3
9	15600.00	40.0 AV	54.0	-14.0	3.49 H	67	26.7	13.3

ANTENNA POLARITY & TEST DISTANCE: VERTICAL AT 3 M

NO.	FREQ. (MHz)	EMISSION LEVEL (dBuV/m)	LIMIT (dBuV/m)	MARGIN (dB)	ANTENNA HEIGHT (m)	TABLE ANGLE (Degree)	RAW VALUE (dBuV)	CORRECTION FACTOR (dB/m)
1	5117.50	55.4 PK	74.0	-18.6	2.36 V	131	52.4	3.0
2	5117.50	46.2 AV	54.0	-7.8	2.36 V	131	43.2	3.0
3	*5200.00	113.3 PK			2.36 V	131	110.5	2.8
4	*5200.00	103.3 AV			2.36 V	131	100.5	2.8
5	5398.90	69.1 PK	74.0	-4.9	2.36 V	131	66.3	2.8
6	5398.90	51.4 AV	54.0	-2.6	2.36 V	131	48.6	2.8
7	#10400.00	57.0 PK	68.2	-11.2	1.47 V	121	44.2	12.8
8	15600.00	55.6 PK	74.0	-18.4	3.66 V	76	42.3	13.3
9	15600.00	42.0 AV	54.0	-12.0	3.66 V	76	28.7	13.3

REMARKS:

1. Emission Level(dBuV/m) = Raw Value(dBuV) + Correction Factor(dB/m)
2. Correction Factor(dB/m) = Antenna Factor(dB/m) + Cable Factor(dB) – Pre-Amplifier Factor(dB)
3. The other emission levels were very low against the limit.
4. Margin value = Emission Level – Limit value
5. " * ": Fundamental frequency.
6. " # ": The radiated frequency is out of the restricted band.

CHANNEL	TX Channel 48	DETECTOR FUNCTION	Peak (PK)
FREQUENCY RANGE	1GHz ~ 40GHz		Average (AV)

ANTENNA POLARITY & TEST DISTANCE: HORIZONTAL AT 3 M

NO.	FREQ. (MHz)	EMISSION LEVEL (dBuV/m)	LIMIT (dBuV/m)	MARGIN (dB)	ANTENNA HEIGHT (m)	TABLE ANGLE (Degree)	RAW VALUE (dBuV)	CORRECTION FACTOR (dB/m)
1	*5240.00	116.7 PK			2.12 H	34	114.2	2.5
2	*5240.00	107.0 AV			2.12 H	34	104.5	2.5
3	5398.90	61.9 PK	74.0	-12.1	2.12 H	34	59.1	2.8
4	5398.90	52.3 AV	54.0	-1.7	2.12 H	34	49.5	2.8
5	#10480.00	56.0 PK	68.2	-12.2	1.44 H	356	43.6	12.4
6	15720.00	52.5 PK	74.0	-21.5	3.58 H	69	40.1	12.4
7	15720.00	40.5 AV	54.0	-13.5	3.58 H	69	28.1	12.4

ANTENNA POLARITY & TEST DISTANCE: VERTICAL AT 3 M

NO.	FREQ. (MHz)	EMISSION LEVEL (dBuV/m)	LIMIT (dBuV/m)	MARGIN (dB)	ANTENNA HEIGHT (m)	TABLE ANGLE (Degree)	RAW VALUE (dBuV)	CORRECTION FACTOR (dB/m)
1	*5240.00	113.9 PK			2.37 V	131	111.4	2.5
2	*5240.00	103.6 AV			2.37 V	131	101.1	2.5
3	5398.90	68.2 PK	74.0	-5.8	2.37 V	131	65.4	2.8
4	5398.90	50.8 AV	54.0	-3.2	2.37 V	131	48.0	2.8
5	#10480.00	56.8 PK	68.2	-11.4	1.51 V	114	44.4	12.4
6	15720.00	56.4 PK	74.0	-17.6	3.58 V	74	44.0	12.4
7	15720.00	42.7 AV	54.0	-11.3	3.58 V	74	30.3	12.4

REMARKS:

1. Emission Level(dBuV/m) = Raw Value(dBuV) + Correction Factor(dB/m)
2. Correction Factor(dB/m) = Antenna Factor(dB/m) + Cable Factor(dB) – Pre-Amplifier Factor(dB)
3. The other emission levels were very low against the limit.
4. Margin value = Emission Level – Limit value
5. " * ": Fundamental frequency.
6. " # ": The radiated frequency is out of the restricted band.

CHANNEL	TX Channel 149	DETECTOR FUNCTION	Peak (PK)
FREQUENCY RANGE	1GHz ~ 40GHz		Average (AV)

ANTENNA POLARITY & TEST DISTANCE: HORIZONTAL AT 3 M

NO.	FREQ. (MHz)	EMISSION LEVEL (dBuV/m)	LIMIT (dBuV/m)	MARGIN (dB)	ANTENNA HEIGHT (m)	TABLE ANGLE (Degree)	RAW VALUE (dBuV)	CORRECTION FACTOR (dB/m)
1	#5591.40	60.7 PK	68.2	-7.5	1.52 H	52	57.7	3.0
2	*5745.00	119.6 PK			1.52 H	52	116.3	3.3
3	*5745.00	109.7 AV			1.52 H	52	106.4	3.3
4	#5983.26	57.9 PK	68.2	-10.3	1.52 H	52	54.3	3.6
5	11490.00	58.1 PK	74.0	-15.9	1.46 H	360	45.4	12.7
6	11490.00	46.1 AV	54.0	-7.9	1.46 H	360	33.4	12.7
7	#17235.00	52.9 PK	68.2	-15.3	3.49 H	70	37.0	15.9

ANTENNA POLARITY & TEST DISTANCE: VERTICAL AT 3 M

NO.	FREQ. (MHz)	EMISSION LEVEL (dBuV/m)	LIMIT (dBuV/m)	MARGIN (dB)	ANTENNA HEIGHT (m)	TABLE ANGLE (Degree)	RAW VALUE (dBuV)	CORRECTION FACTOR (dB/m)
1	#5581.10	58.2 PK	68.2	-10.0	2.24 V	353	55.2	3.0
2	*5745.00	115.8 PK			2.24 V	353	112.5	3.3
3	*5745.00	105.8 AV			2.24 V	353	102.5	3.3
4	#5982.26	59.8 PK	68.2	-8.4	2.24 V	353	56.2	3.6
5	11490.00	58.9 PK	74.0	-15.1	1.53 V	106	46.2	12.7
6	11490.00	46.8 AV	54.0	-7.2	1.53 V	106	34.1	12.7
7	#17235.00	58.0 PK	68.2	-10.2	3.65 V	61	42.1	15.9

REMARKS:

1. Emission Level(dBuV/m) = Raw Value(dBuV) + Correction Factor(dB/m)
2. Correction Factor(dB/m) = Antenna Factor(dB/m) + Cable Factor(dB) – Pre-Amplifier Factor(dB)
3. The other emission levels were very low against the limit.
4. Margin value = Emission Level – Limit value
5. " * ": Fundamental frequency.
6. " # ": The radiated frequency is out of the restricted band.

CHANNEL	TX Channel 157	DETECTOR FUNCTION	Peak (PK)
FREQUENCY RANGE	1GHz ~ 40GHz		Average (AV)

ANTENNA POLARITY & TEST DISTANCE: HORIZONTAL AT 3 M

NO.	FREQ. (MHz)	EMISSION LEVEL (dBuV/m)	LIMIT (dBuV/m)	MARGIN (dB)	ANTENNA HEIGHT (m)	TABLE ANGLE (Degree)	RAW VALUE (dBuV)	CORRECTION FACTOR (dB/m)
1	#5619.87	60.2 PK	68.2	-8.0	1.47 H	49	57.2	3.0
2	*5785.00	118.9 PK			1.47 H	49	115.4	3.5
3	*5785.00	109.3 AV			1.47 H	49	105.8	3.5
4	#5951.55	61.8 PK	68.2	-6.4	1.47 H	49	58.1	3.7
5	11570.00	57.1 PK	74.0	-16.9	1.53 H	360	44.6	12.5
6	11570.00	45.3 AV	54.0	-8.7	1.53 H	360	32.8	12.5
7	#17355.00	52.2 PK	68.2	-16.0	3.47 H	64	35.6	16.6

ANTENNA POLARITY & TEST DISTANCE: VERTICAL AT 3 M

NO.	FREQ. (MHz)	EMISSION LEVEL (dBuV/m)	LIMIT (dBuV/m)	MARGIN (dB)	ANTENNA HEIGHT (m)	TABLE ANGLE (Degree)	RAW VALUE (dBuV)	CORRECTION FACTOR (dB/m)
1	#5620.95	57.8 PK	68.2	-10.4	2.28 V	360	54.8	3.0
2	*5785.00	116.7 PK			2.28 V	360	113.2	3.5
3	*5785.00	106.3 AV			2.28 V	360	102.8	3.5
4	#5949.33	59.5 PK	68.2	-8.7	2.28 V	360	55.8	3.7
5	11570.00	58.5 PK	74.0	-15.5	1.62 V	95	46.0	12.5
6	11570.00	46.5 AV	54.0	-7.5	1.62 V	95	34.0	12.5
7	#17355.00	57.9 PK	68.2	-10.3	3.56 V	52	41.3	16.6

REMARKS:

1. Emission Level(dBuV/m) = Raw Value(dBuV) + Correction Factor(dB/m)
2. Correction Factor(dB/m) = Antenna Factor(dB/m) + Cable Factor(dB) – Pre-Amplifier Factor(dB)
3. The other emission levels were very low against the limit.
4. Margin value = Emission Level – Limit value
5. " * ": Fundamental frequency.
6. " # ": The radiated frequency is out of the restricted band.

CHANNEL	TX Channel 165	DETECTOR FUNCTION	Peak (PK)
FREQUENCY RANGE	1GHz ~ 40GHz		Average (AV)

ANTENNA POLARITY & TEST DISTANCE: HORIZONTAL AT 3 M

NO.	FREQ. (MHz)	EMISSION LEVEL (dBuV/m)	LIMIT (dBuV/m)	MARGIN (dB)	ANTENNA HEIGHT (m)	TABLE ANGLE (Degree)	RAW VALUE (dBuV)	CORRECTION FACTOR (dB/m)
1	#5580.41	58.8 PK	68.2	-9.4	1.49 H	41	55.8	3.0
2	*5825.00	119.7 PK			1.49 H	41	116.2	3.5
3	*5825.00	110.0 AV			1.49 H	41	106.5	3.5
4	#5983.26	61.1 PK	68.2	-7.1	1.49 H	41	57.5	3.6
5	11650.00	57.6 PK	74.0	-16.4	1.47 H	360	45.1	12.5
6	11650.00	45.7 AV	54.0	-8.3	1.47 H	360	33.2	12.5
7	#17475.00	52.7 PK	68.2	-15.5	3.47 H	70	34.7	18.0

ANTENNA POLARITY & TEST DISTANCE: VERTICAL AT 3 M

NO.	FREQ. (MHz)	EMISSION LEVEL (dBuV/m)	LIMIT (dBuV/m)	MARGIN (dB)	ANTENNA HEIGHT (m)	TABLE ANGLE (Degree)	RAW VALUE (dBuV)	CORRECTION FACTOR (dB/m)
1	#5578.30	60.2 PK	68.2	-8.0	2.24 V	359	57.2	3.0
2	*5825.00	116.5 PK			2.24 V	359	113.0	3.5
3	*5825.00	106.2 AV			2.24 V	359	102.7	3.5
4	#5984.23	59.3 PK	68.2	-8.9	2.24 V	359	55.7	3.6
5	11650.00	58.6 PK	74.0	-15.4	1.57 V	93	46.1	12.5
6	11650.00	46.7 AV	54.0	-7.3	1.57 V	93	34.2	12.5
7	#17475.00	58.0 PK	68.2	-10.2	3.60 V	65	40.0	18.0

REMARKS:

1. Emission Level(dBuV/m) = Raw Value(dBuV) + Correction Factor(dB/m)
2. Correction Factor(dB/m) = Antenna Factor(dB/m) + Cable Factor(dB) – Pre-Amplifier Factor(dB)
3. The other emission levels were very low against the limit.
4. Margin value = Emission Level – Limit value
5. " * ": Fundamental frequency.
6. " # ": The radiated frequency is out of the restricted band.

802.11ac (VHT20)

CHANNEL	TX Channel 36	DETECTOR FUNCTION	Peak (PK)
FREQUENCY RANGE	1GHz ~ 40GHz		Average (AV)

ANTENNA POLARITY & TEST DISTANCE: HORIZONTAL AT 3 M

NO.	FREQ. (MHz)	EMISSION LEVEL (dBuV/m)	LIMIT (dBuV/m)	MARGIN (dB)	ANTENNA HEIGHT (m)	TABLE ANGLE (Degree)	RAW VALUE (dBuV)	CORRECTION FACTOR (dB/m)
1	5150.00	69.6 PK	74.0	-4.4	2.15 H	30	66.7	2.9
2	5150.00	53.9 AV	54.0	-0.1	2.15 H	30	51.0	2.9
3	*5180.00	116.3 PK			2.15 H	30	113.4	2.9
4	*5180.00	106.4 AV			2.15 H	30	103.5	2.9
5	#10360.00	56.5 PK	68.2	-11.7	1.41 H	353	44.2	12.3
6	15540.00	51.7 PK	74.0	-22.3	3.57 H	64	38.9	12.8
7	15540.00	39.9 AV	54.0	-14.1	3.57 H	64	27.1	12.8

ANTENNA POLARITY & TEST DISTANCE: VERTICAL AT 3 M

NO.	FREQ. (MHz)	EMISSION LEVEL (dBuV/m)	LIMIT (dBuV/m)	MARGIN (dB)	ANTENNA HEIGHT (m)	TABLE ANGLE (Degree)	RAW VALUE (dBuV)	CORRECTION FACTOR (dB/m)
1	5150.00	67.9 PK	74.0	-6.1	2.41 V	112	65.0	2.9
2	5150.00	50.5 AV	54.0	-3.5	2.41 V	112	47.6	2.9
3	*5180.00	114.1 PK			2.41 V	112	111.2	2.9
4	*5180.00	103.9 AV			2.41 V	112	101.0	2.9
5	#10360.00	57.4 PK	68.2	-10.8	1.52 V	96	45.1	12.3
6	15540.00	57.4 PK	74.0	-16.6	3.63 V	85	44.6	12.8
7	15540.00	43.4 AV	54.0	-10.6	3.63 V	85	30.6	12.8

REMARKS:

- Emission Level(dBuV/m) = Raw Value(dBuV) + Correction Factor(dB/m)
- Correction Factor(dB/m) = Antenna Factor(dB/m) + Cable Factor(dB) – Pre-Amplifier Factor(dB)
- The other emission levels were very low against the limit.
- Margin value = Emission Level – Limit value
- " * ": Fundamental frequency.
- " # ": The radiated frequency is out of the restricted band.

CHANNEL	TX Channel 40	DETECTOR FUNCTION	Peak (PK)
FREQUENCY RANGE	1GHz ~ 40GHz		Average (AV)

ANTENNA POLARITY & TEST DISTANCE: HORIZONTAL AT 3 M

NO.	FREQ. (MHz)	EMISSION LEVEL (dBuV/m)	LIMIT (dBuV/m)	MARGIN (dB)	ANTENNA HEIGHT (m)	TABLE ANGLE (Degree)	RAW VALUE (dBuV)	CORRECTION FACTOR (dB/m)
1	5122.40	58.0 PK	74.0	-16.0	2.11 H	31	55.0	3.0
2	5122.40	47.2 AV	54.0	-6.8	2.11 H	31	44.2	3.0
3	*5200.00	116.2 PK			2.11 H	31	113.4	2.8
4	*5200.00	106.6 AV			2.11 H	31	103.8	2.8
5	5357.00	60.5 PK	74.0	-13.5	2.11 H	31	57.8	2.7
6	5357.00	51.0 AV	54.0	-3.0	2.11 H	31	48.3	2.7
7	#10400.00	56.7 PK	68.2	-11.5	1.48 H	344	43.9	12.8
8	15600.00	51.9 PK	74.0	-22.1	3.58 H	88	38.6	13.3
9	15600.00	40.2 AV	54.0	-13.8	3.58 H	88	26.9	13.3

ANTENNA POLARITY & TEST DISTANCE: VERTICAL AT 3 M

NO.	FREQ. (MHz)	EMISSION LEVEL (dBuV/m)	LIMIT (dBuV/m)	MARGIN (dB)	ANTENNA HEIGHT (m)	TABLE ANGLE (Degree)	RAW VALUE (dBuV)	CORRECTION FACTOR (dB/m)
1	5122.40	55.6 PK	74.0	-18.4	2.34 V	129	52.6	3.0
2	5122.40	46.3 AV	54.0	-7.7	2.34 V	129	43.3	3.0
3	*5200.00	113.8 PK			2.34 V	129	111.0	2.8
4	*5200.00	103.6 AV			2.34 V	129	100.8	2.8
5	5357.00	69.3 PK	74.0	-4.7	2.34 V	129	66.6	2.7
6	5357.00	51.5 AV	54.0	-2.5	2.34 V	129	48.8	2.7
7	#10400.00	56.9 PK	68.2	-11.3	1.51 V	110	44.1	12.8
8	15600.00	55.0 PK	74.0	-19.0	3.62 V	73	41.7	13.3
9	15600.00	41.5 AV	54.0	-12.5	3.62 V	73	28.2	13.3

REMARKS:

1. Emission Level(dBuV/m) = Raw Value(dBuV) + Correction Factor(dB/m)
2. Correction Factor(dB/m) = Antenna Factor(dB/m) + Cable Factor(dB) – Pre-Amplifier Factor(dB)
3. The other emission levels were very low against the limit.
4. Margin value = Emission Level – Limit value
5. " * ": Fundamental frequency.
6. " # ": The radiated frequency is out of the restricted band.

CHANNEL	TX Channel 48	DETECTOR FUNCTION	Peak (PK)
FREQUENCY RANGE	1GHz ~ 40GHz		Average (AV)

ANTENNA POLARITY & TEST DISTANCE: HORIZONTAL AT 3 M

NO.	FREQ. (MHz)	EMISSION LEVEL (dBuV/m)	LIMIT (dBuV/m)	MARGIN (dB)	ANTENNA HEIGHT (m)	TABLE ANGLE (Degree)	RAW VALUE (dBuV)	CORRECTION FACTOR (dB/m)
1	*5240.00	117.0 PK			2.13 H	33	114.5	2.5
2	*5240.00	107.3 AV			2.13 H	33	104.8	2.5
3	5397.30	59.7 PK	74.0	-14.3	2.13 H	33	56.9	2.8
4	5397.30	50.5 AV	54.0	-3.5	2.13 H	33	47.7	2.8
5	#10480.00	56.7 PK	68.2	-11.5	1.50 H	360	44.3	12.4
6	15720.00	52.3 PK	74.0	-21.7	3.59 H	71	39.9	12.4
7	15720.00	40.2 AV	54.0	-13.8	3.59 H	71	27.8	12.4

ANTENNA POLARITY & TEST DISTANCE: VERTICAL AT 3 M

NO.	FREQ. (MHz)	EMISSION LEVEL (dBuV/m)	LIMIT (dBuV/m)	MARGIN (dB)	ANTENNA HEIGHT (m)	TABLE ANGLE (Degree)	RAW VALUE (dBuV)	CORRECTION FACTOR (dB/m)
1	*5240.00	113.8 PK			2.33 V	117	111.3	2.5
2	*5240.00	103.3 AV			2.33 V	117	100.8	2.5
3	5397.30	68.6 PK	74.0	-5.4	2.37 V	133	65.8	2.8
4	5397.30	51.3 AV	54.0	-2.7	2.37 V	133	48.5	2.8
5	#10480.00	56.4 PK	68.2	-11.8	1.47 V	122	44.0	12.4
6	15720.00	56.6 PK	74.0	-17.4	3.53 V	78	44.2	12.4
7	15720.00	42.9 AV	54.0	-11.1	3.53 V	78	30.5	12.4

REMARKS:

1. Emission Level(dBuV/m) = Raw Value(dBuV) + Correction Factor(dB/m)
2. Correction Factor(dB/m) = Antenna Factor(dB/m) + Cable Factor(dB) – Pre-Amplifier Factor(dB)
3. The other emission levels were very low against the limit.
4. Margin value = Emission Level – Limit value
5. " * ": Fundamental frequency.
6. " # ": The radiated frequency is out of the restricted band.

CHANNEL	TX Channel 149	DETECTOR FUNCTION	Peak (PK)
FREQUENCY RANGE	1GHz ~ 40GHz		Average (AV)

ANTENNA POLARITY & TEST DISTANCE: HORIZONTAL AT 3 M

NO.	FREQ. (MHz)	EMISSION LEVEL (dBuV/m)	LIMIT (dBuV/m)	MARGIN (dB)	ANTENNA HEIGHT (m)	TABLE ANGLE (Degree)	RAW VALUE (dBuV)	CORRECTION FACTOR (dB/m)
1	#5586.75	61.1 PK	68.2	-7.1	1.50 H	53	58.1	3.0
2	*5745.00	118.4 PK			1.50 H	53	115.1	3.3
3	*5745.00	108.9 AV			1.50 H	53	105.6	3.3
4	#5984.71	58.2 PK	68.2	-10.0	1.50 H	53	54.6	3.6
5	11490.00	58.4 PK	74.0	-15.6	1.50 H	360	45.7	12.7
6	11490.00	46.1 AV	54.0	-7.9	1.50 H	360	33.4	12.7
7	#17235.00	52.4 PK	68.2	-15.8	3.48 H	65	36.5	15.9

ANTENNA POLARITY & TEST DISTANCE: VERTICAL AT 3 M

NO.	FREQ. (MHz)	EMISSION LEVEL (dBuV/m)	LIMIT (dBuV/m)	MARGIN (dB)	ANTENNA HEIGHT (m)	TABLE ANGLE (Degree)	RAW VALUE (dBuV)	CORRECTION FACTOR (dB/m)
1	#5587.44	56.9 PK	68.2	-11.3	2.23 V	360	53.9	3.0
2	*5745.00	115.8 PK			2.23 V	360	112.5	3.3
3	*5745.00	105.2 AV			2.23 V	360	101.9	3.3
4	#5991.18	57.8 PK	68.2	-10.4	2.23 V	360	54.2	3.6
5	11490.00	59.1 PK	74.0	-14.9	1.63 V	85	46.4	12.7
6	11490.00	46.9 AV	54.0	-7.1	1.63 V	85	34.2	12.7
7	#17235.00	58.0 PK	68.2	-10.2	3.61 V	55	42.1	15.9

REMARKS:

1. Emission Level(dBuV/m) = Raw Value(dBuV) + Correction Factor(dB/m)
2. Correction Factor(dB/m) = Antenna Factor(dB/m) + Cable Factor(dB) – Pre-Amplifier Factor(dB)
3. The other emission levels were very low against the limit.
4. Margin value = Emission Level – Limit value
5. " * ": Fundamental frequency.
6. " # ": The radiated frequency is out of the restricted band.

CHANNEL	TX Channel 157	DETECTOR FUNCTION	Peak (PK)
FREQUENCY RANGE	1GHz ~ 40GHz		Average (AV)

ANTENNA POLARITY & TEST DISTANCE: HORIZONTAL AT 3 M

NO.	FREQ. (MHz)	EMISSION LEVEL (dBuV/m)	LIMIT (dBuV/m)	MARGIN (dB)	ANTENNA HEIGHT (m)	TABLE ANGLE (Degree)	RAW VALUE (dBuV)	CORRECTION FACTOR (dB/m)
1	#5619.08	59.0 PK	68.2	-9.2	1.54 H	63	56.0	3.0
2	*5785.00	117.9 PK			1.54 H	63	114.4	3.5
3	*5785.00	108.5 AV			1.54 H	63	105.0	3.5
4	#5946.86	60.7 PK	68.2	-7.5	1.54 H	63	57.0	3.7
5	11570.00	58.2 PK	74.0	-15.8	1.47 H	360	45.7	12.5
6	11570.00	46.3 AV	54.0	-7.7	1.47 H	360	33.8	12.5
7	#17355.00	53.1 PK	68.2	-15.1	3.49 H	80	36.5	16.6

ANTENNA POLARITY & TEST DISTANCE: VERTICAL AT 3 M

NO.	FREQ. (MHz)	EMISSION LEVEL (dBuV/m)	LIMIT (dBuV/m)	MARGIN (dB)	ANTENNA HEIGHT (m)	TABLE ANGLE (Degree)	RAW VALUE (dBuV)	CORRECTION FACTOR (dB/m)
1	#5622.39	58.6 PK	68.2	-9.6	2.19 V	347	55.6	3.0
2	*5785.00	115.9 PK			2.19 V	347	112.4	3.5
3	*5785.00	105.3 AV			2.19 V	347	101.8	3.5
4	#5946.53	59.5 PK	68.2	-8.7	2.19 V	347	55.8	3.7
5	11570.00	58.7 PK	74.0	-15.3	1.55 V	108	46.2	12.5
6	11570.00	46.5 AV	54.0	-7.5	1.55 V	108	34.0	12.5
7	#17355.00	57.8 PK	68.2	-10.4	3.62 V	68	41.2	16.6

REMARKS:

1. Emission Level(dBuV/m) = Raw Value(dBuV) + Correction Factor(dB/m)
2. Correction Factor(dB/m) = Antenna Factor(dB/m) + Cable Factor(dB) – Pre-Amplifier Factor(dB)
3. The other emission levels were very low against the limit.
4. Margin value = Emission Level – Limit value
5. " * ": Fundamental frequency.
6. " # ": The radiated frequency is out of the restricted band.

CHANNEL	TX Channel 165	DETECTOR FUNCTION	Peak (PK)
FREQUENCY RANGE	1GHz ~ 40GHz		Average (AV)

ANTENNA POLARITY & TEST DISTANCE: HORIZONTAL AT 3 M

NO.	FREQ. (MHz)	EMISSION LEVEL (dBuV/m)	LIMIT (dBuV/m)	MARGIN (dB)	ANTENNA HEIGHT (m)	TABLE ANGLE (Degree)	RAW VALUE (dBuV)	CORRECTION FACTOR (dB/m)
1	#5583.67	58.6 PK	68.2	-9.6	1.50 H	47	55.6	3.0
2	*5825.00	118.5 PK			1.50 H	47	115.0	3.5
3	*5825.00	108.8 AV			1.50 H	47	105.3	3.5
4	#5987.40	60.0 PK	68.2	-8.2	1.50 H	47	56.4	3.6
5	11650.00	58.7 PK	74.0	-15.3	1.40 H	356	46.2	12.5
6	11650.00	46.5 AV	54.0	-7.5	1.40 H	356	34.0	12.5
7	#17475.00	52.4 PK	68.2	-15.8	3.50 H	58	34.4	18.0

ANTENNA POLARITY & TEST DISTANCE: VERTICAL AT 3 M

NO.	FREQ. (MHz)	EMISSION LEVEL (dBuV/m)	LIMIT (dBuV/m)	MARGIN (dB)	ANTENNA HEIGHT (m)	TABLE ANGLE (Degree)	RAW VALUE (dBuV)	CORRECTION FACTOR (dB/m)
1	#5580.53	59.5 PK	68.2	-8.7	2.21 V	358	56.5	3.0
2	*5825.00	116.3 PK			2.21 V	358	112.8	3.5
3	*5825.00	105.7 AV			2.21 V	358	102.2	3.5
4	#5981.13	58.2 PK	68.2	-10.0	2.21 V	358	54.6	3.6
5	11650.00	58.1 PK	74.0	-15.9	1.53 V	105	45.6	12.5
6	11650.00	46.4 AV	54.0	-7.6	1.53 V	105	33.9	12.5
7	#17475.00	58.3 PK	68.2	-9.9	3.61 V	74	40.3	18.0

REMARKS:

1. Emission Level(dBuV/m) = Raw Value(dBuV) + Correction Factor(dB/m)
2. Correction Factor(dB/m) = Antenna Factor(dB/m) + Cable Factor(dB) – Pre-Amplifier Factor(dB)
3. The other emission levels were very low against the limit.
4. Margin value = Emission Level – Limit value
5. " * ": Fundamental frequency.
6. " # ": The radiated frequency is out of the restricted band.

802.11ac (VHT40)

CHANNEL	TX Channel 38	DETECTOR FUNCTION	Peak (PK)
FREQUENCY RANGE	1GHz ~ 40GHz		Average (AV)

ANTENNA POLARITY & TEST DISTANCE: HORIZONTAL AT 3 M

NO.	FREQ. (MHz)	EMISSION LEVEL (dBuV/m)	LIMIT (dBuV/m)	MARGIN (dB)	ANTENNA HEIGHT (m)	TABLE ANGLE (Degree)	RAW VALUE (dBuV)	CORRECTION FACTOR (dB/m)
1	5147.50	68.2 PK	74.0	-5.8	1.58 H	31	65.3	2.9
2	5147.50	53.9 AV	54.0	-0.1	1.58 H	31	51.0	2.9
3	*5190.00	108.5 PK			1.58 H	31	105.7	2.8
4	*5190.00	98.4 AV			1.58 H	31	95.6	2.8
5	5352.40	53.6 PK	74.0	-20.4	1.58 H	31	50.9	2.7
6	5352.40	43.5 AV	54.0	-10.5	1.58 H	31	40.8	2.7
7	#10380.00	56.5 PK	68.2	-11.7	1.55 H	360	44.0	12.5
8	15570.00	52.4 PK	74.0	-21.6	3.54 H	57	39.3	13.1
9	15570.00	40.1 AV	54.0	-13.9	3.54 H	57	27.0	13.1

ANTENNA POLARITY & TEST DISTANCE: VERTICAL AT 3 M

NO.	FREQ. (MHz)	EMISSION LEVEL (dBuV/m)	LIMIT (dBuV/m)	MARGIN (dB)	ANTENNA HEIGHT (m)	TABLE ANGLE (Degree)	RAW VALUE (dBuV)	CORRECTION FACTOR (dB/m)
1	5147.50	66.5 PK	74.0	-7.5	2.41 V	116	63.6	2.9
2	5147.50	50.3 AV	54.0	-3.7	2.41 V	116	47.4	2.9
3	*5190.00	106.3 PK			2.41 V	116	103.5	2.8
4	*5190.00	96.4 AV			2.41 V	116	93.6	2.8
5	5352.40	50.5 PK	74.0	-23.5	2.41 V	116	47.8	2.7
6	5352.40	40.3 AV	54.0	-13.7	2.41 V	116	37.6	2.7
7	#10380.00	56.8 PK	68.2	-11.4	1.41 V	122	44.3	12.5
8	15570.00	57.1 PK	74.0	-16.9	3.48 V	78	44.0	13.1
9	15570.00	43.5 AV	54.0	-10.5	3.48 V	78	30.4	13.1

REMARKS:

- Emission Level(dBuV/m) = Raw Value(dBuV) + Correction Factor(dB/m)
- Correction Factor(dB/m) = Antenna Factor(dB/m) + Cable Factor(dB) – Pre-Amplifier Factor(dB)
- The other emission levels were very low against the limit.
- Margin value = Emission Level – Limit value
- " * ": Fundamental frequency.
- " # ": The radiated frequency is out of the restricted band.

CHANNEL	TX Channel 46	DETECTOR FUNCTION	Peak (PK)
FREQUENCY RANGE	1GHz ~ 40GHz		Average (AV)

ANTENNA POLARITY & TEST DISTANCE: HORIZONTAL AT 3 M

NO.	FREQ. (MHz)	EMISSION LEVEL (dBuV/m)	LIMIT (dBuV/m)	MARGIN (dB)	ANTENNA HEIGHT (m)	TABLE ANGLE (Degree)	RAW VALUE (dBuV)	CORRECTION FACTOR (dB/m)
1	5147.00	57.5 PK	74.0	-16.5	1.48 H	35	54.6	2.9
2	5147.00	46.7 AV	54.0	-7.3	1.48 H	35	43.8	2.9
3	*5230.00	114.0 PK			1.48 H	35	111.4	2.6
4	*5230.00	104.1 AV			1.48 H	35	101.5	2.6
5	5387.00	59.8 PK	74.0	-14.2	1.48 H	35	57.0	2.8
6	5387.00	48.6 AV	54.0	-5.4	1.48 H	35	45.8	2.8
7	#10460.00	56.5 PK	68.2	-11.7	1.52 H	359	44.0	12.5
8	15690.00	52.0 PK	74.0	-22.0	3.55 H	83	39.5	12.5
9	15690.00	39.9 AV	54.0	-14.1	3.55 H	83	27.4	12.5

ANTENNA POLARITY & TEST DISTANCE: VERTICAL AT 3 M

NO.	FREQ. (MHz)	EMISSION LEVEL (dBuV/m)	LIMIT (dBuV/m)	MARGIN (dB)	ANTENNA HEIGHT (m)	TABLE ANGLE (Degree)	RAW VALUE (dBuV)	CORRECTION FACTOR (dB/m)
1	5147.00	55.6 PK	74.0	-18.4	2.41 V	129	52.7	2.9
2	5147.00	44.6 AV	54.0	-9.4	2.41 V	129	41.7	2.9
3	*5230.00	112.2 PK			2.41 V	129	109.6	2.6
4	*5230.00	101.5 AV			2.41 V	129	98.9	2.6
5	5387.00	55.8 PK	74.0	-18.2	2.41 V	129	53.0	2.8
6	5387.00	45.3 AV	54.0	-8.7	2.41 V	129	42.5	2.8
7	#10460.00	56.3 PK	68.2	-11.9	1.38 V	137	43.8	12.5
8	15690.00	57.1 PK	74.0	-16.9	3.47 V	65	44.6	12.5
9	15690.00	43.4 AV	54.0	-10.6	3.47 V	65	30.9	12.5

REMARKS:

1. Emission Level(dBuV/m) = Raw Value(dBuV) + Correction Factor(dB/m)
2. Correction Factor(dB/m) = Antenna Factor(dB/m) + Cable Factor(dB) – Pre-Amplifier Factor(dB)
3. The other emission levels were very low against the limit.
4. Margin value = Emission Level – Limit value
5. " * ": Fundamental frequency.
6. " # ": The radiated frequency is out of the restricted band.

CHANNEL	TX Channel 151	DETECTOR FUNCTION	Peak (PK)
FREQUENCY RANGE	1GHz ~ 40GHz		Average (AV)

ANTENNA POLARITY & TEST DISTANCE: HORIZONTAL AT 3 M

NO.	FREQ. (MHz)	EMISSION LEVEL (dBuV/m)	LIMIT (dBuV/m)	MARGIN (dB)	ANTENNA HEIGHT (m)	TABLE ANGLE (Degree)	RAW VALUE (dBuV)	CORRECTION FACTOR (dB/m)
1	#5601.77	58.5 PK	68.2	-9.7	1.51 H	54	55.5	3.0
2	*5755.00	114.7 PK			1.51 H	54	111.3	3.4
3	*5755.00	104.6 AV			1.51 H	54	101.2	3.4
4	#5931.48	57.8 PK	68.2	-10.4	1.51 H	54	54.1	3.7
5	11510.00	58.1 PK	74.0	-15.9	1.43 H	360	45.4	12.7
6	11510.00	46.3 AV	54.0	-7.7	1.43 H	360	33.6	12.7
7	#17265.00	53.3 PK	68.2	-14.9	3.54 H	80	37.3	16.0

ANTENNA POLARITY & TEST DISTANCE: VERTICAL AT 3 M

NO.	FREQ. (MHz)	EMISSION LEVEL (dBuV/m)	LIMIT (dBuV/m)	MARGIN (dB)	ANTENNA HEIGHT (m)	TABLE ANGLE (Degree)	RAW VALUE (dBuV)	CORRECTION FACTOR (dB/m)
1	#5577.79	56.5 PK	68.2	-11.7	2.32 V	360	53.5	3.0
2	*5755.00	112.7 PK			2.32 V	360	109.3	3.4
3	*5755.00	101.9 AV			2.32 V	360	98.5	3.4
4	#5926.25	58.3 PK	68.2	-9.9	2.32 V	360	54.6	3.7
5	11510.00	58.8 PK	74.0	-15.2	1.63 V	81	46.1	12.7
6	11510.00	46.7 AV	54.0	-7.3	1.63 V	81	34.0	12.7
7	#17265.00	57.4 PK	68.2	-10.8	3.56 V	75	41.4	16.0

REMARKS:

1. Emission Level(dBuV/m) = Raw Value(dBuV) + Correction Factor(dB/m)
2. Correction Factor(dB/m) = Antenna Factor(dB/m) + Cable Factor(dB) – Pre-Amplifier Factor(dB)
3. The other emission levels were very low against the limit.
4. Margin value = Emission Level – Limit value
5. " * ": Fundamental frequency.
6. " # ": The radiated frequency is out of the restricted band.

CHANNEL	TX Channel 159	DETECTOR FUNCTION	Peak (PK)
FREQUENCY RANGE	1GHz ~ 40GHz		Average (AV)

ANTENNA POLARITY & TEST DISTANCE: HORIZONTAL AT 3 M

NO.	FREQ. (MHz)	EMISSION LEVEL (dBuV/m)	LIMIT (dBuV/m)	MARGIN (dB)	ANTENNA HEIGHT (m)	TABLE ANGLE (Degree)	RAW VALUE (dBuV)	CORRECTION FACTOR (dB/m)
1	#5631.76	57.6 PK	68.2	-10.6	1.51 H	45	54.6	3.0
2	*5795.00	114.5 PK			1.51 H	45	111.1	3.4
3	*5795.00	104.5 AV			1.51 H	45	101.1	3.4
4	#5942.08	58.4 PK	68.2	-9.8	1.51 H	45	54.7	3.7
5	11590.00	58.0 PK	74.0	-16.0	1.44 H	359	45.5	12.5
6	11590.00	46.4 AV	54.0	-7.6	1.44 H	359	33.9	12.5
7	#17385.00	53.6 PK	68.2	-14.6	3.49 H	94	36.8	16.8

ANTENNA POLARITY & TEST DISTANCE: VERTICAL AT 3 M

NO.	FREQ. (MHz)	EMISSION LEVEL (dBuV/m)	LIMIT (dBuV/m)	MARGIN (dB)	ANTENNA HEIGHT (m)	TABLE ANGLE (Degree)	RAW VALUE (dBuV)	CORRECTION FACTOR (dB/m)
1	#5648.18	56.3 PK	68.2	-11.9	2.27 V	359	53.3	3.0
2	*5795.00	112.6 PK			2.27 V	359	109.2	3.4
3	*5795.00	101.6 AV			2.27 V	359	98.2	3.4
4	#5970.65	56.2 PK	68.2	-12.0	2.27 V	359	52.6	3.6
5	11590.00	59.0 PK	74.0	-15.0	1.52 V	95	46.5	12.5
6	11590.00	47.0 AV	54.0	-7.0	1.52 V	95	34.5	12.5
7	#17385.00	58.1 PK	68.2	-10.1	3.56 V	59	41.3	16.8

REMARKS:

1. Emission Level(dBuV/m) = Raw Value(dBuV) + Correction Factor(dB/m)
2. Correction Factor(dB/m) = Antenna Factor(dB/m) + Cable Factor(dB) – Pre-Amplifier Factor(dB)
3. The other emission levels were very low against the limit.
4. Margin value = Emission Level – Limit value
5. " * ": Fundamental frequency.
6. " # ": The radiated frequency is out of the restricted band.

802.11ac (VHT80)

CHANNEL	TX Channel 42	DETECTOR FUNCTION	Peak (PK)
FREQUENCY RANGE	1GHz ~ 40GHz		Average (AV)

ANTENNA POLARITY & TEST DISTANCE: HORIZONTAL AT 3 M								
NO.	FREQ. (MHz)	EMISSION LEVEL (dBuV/m)	LIMIT (dBuV/m)	MARGIN (dB)	ANTENNA HEIGHT (m)	TABLE ANGLE (Degree)	RAW VALUE (dBuV)	CORRECTION FACTOR (dB/m)
1	5137.60	67.2 PK	74.0	-6.8	1.47 H	37	64.3	2.9
2	5137.60	53.9 AV	54.0	-0.1	1.47 H	37	51.0	2.9
3	*5210.00	103.9 PK			1.47 H	37	101.2	2.7
4	*5210.00	96.0 AV			1.47 H	37	93.3	2.7
5	5358.50	53.5 PK	74.0	-20.5	1.47 H	37	50.8	2.7
6	5358.50	42.9 AV	54.0	-11.1	1.47 H	37	40.2	2.7
7	#10420.00	56.5 PK	68.2	-11.7	1.47 H	360	43.9	12.6
8	15630.00	51.8 PK	74.0	-22.2	3.55 H	83	38.7	13.1
9	15630.00	39.8 AV	54.0	-14.2	3.55 H	83	26.7	13.1

ANTENNA POLARITY & TEST DISTANCE: VERTICAL AT 3 M								
NO.	FREQ. (MHz)	EMISSION LEVEL (dBuV/m)	LIMIT (dBuV/m)	MARGIN (dB)	ANTENNA HEIGHT (m)	TABLE ANGLE (Degree)	RAW VALUE (dBuV)	CORRECTION FACTOR (dB/m)
1	5137.60	63.2 PK	74.0	-10.8	2.26 V	125	60.3	2.9
2	5137.60	50.8 AV	54.0	-3.2	2.26 V	125	47.9	2.9
3	*5210.00	101.3 PK			2.26 V	125	98.6	2.7
4	*5210.00	94.2 AV			2.26 V	125	91.5	2.7
5	5358.50	50.2 PK	74.0	-23.8	2.26 V	125	47.5	2.7
6	5358.50	40.5 AV	54.0	-13.5	2.26 V	125	37.8	2.7
7	#10420.00	56.3 PK	68.2	-11.9	1.51 V	106	43.7	12.6
8	15630.00	56.8 PK	74.0	-17.2	3.49 V	87	43.7	13.1
9	15630.00	43.0 AV	54.0	-11.0	3.49 V	87	29.9	13.1

REMARKS:

1. Emission Level(dBuV/m) = Raw Value(dBuV) + Correction Factor(dB/m)
2. Correction Factor(dB/m) = Antenna Factor(dB/m) + Cable Factor(dB) – Pre-Amplifier Factor(dB)
3. The other emission levels were very low against the limit.
4. Margin value = Emission Level – Limit value
5. " * ": Fundamental frequency.
6. " # ": The radiated frequency is out of the restricted band.

CHANNEL	TX Channel 155	DETECTOR FUNCTION	Peak (PK)
FREQUENCY RANGE	1GHz ~ 40GHz		Average (AV)

ANTENNA POLARITY & TEST DISTANCE: HORIZONTAL AT 3 M

NO.	FREQ. (MHz)	EMISSION LEVEL (dBuV/m)	LIMIT (dBuV/m)	MARGIN (dB)	ANTENNA HEIGHT (m)	TABLE ANGLE (Degree)	RAW VALUE (dBuV)	CORRECTION FACTOR (dB/m)
1	#5640.52	67.8 PK	68.2	-0.4	1.52 H	29	64.8	3.0
2	*5775.00	113.1 PK			1.52 H	29	109.7	3.4
3	*5775.00	104.0 AV			1.52 H	29	100.6	3.4
4	#5930.32	61.7 PK	68.2	-6.5	1.52 H	29	58.0	3.7
5	11550.00	58.0 PK	74.0	-16.0	1.50 H	360	45.4	12.6
6	11550.00	46.0 AV	54.0	-8.0	1.50 H	360	33.4	12.6
7	#17325.00	52.8 PK	68.2	-15.4	3.45 H	81	36.5	16.3

ANTENNA POLARITY & TEST DISTANCE: VERTICAL AT 3 M

NO.	FREQ. (MHz)	EMISSION LEVEL (dBuV/m)	LIMIT (dBuV/m)	MARGIN (dB)	ANTENNA HEIGHT (m)	TABLE ANGLE (Degree)	RAW VALUE (dBuV)	CORRECTION FACTOR (dB/m)
1	#5648.05	62.1 PK	68.2	-6.1	2.28 V	358	59.1	3.0
2	*5775.00	110.8 PK			2.28 V	358	107.4	3.4
3	*5775.00	100.9 AV			2.28 V	358	97.5	3.4
4	#5939.95	57.0 PK	68.2	-11.2	2.28 V	358	53.2	3.8
5	11550.00	58.4 PK	74.0	-15.6	1.63 V	89	45.8	12.6
6	11550.00	46.2 AV	54.0	-7.8	1.63 V	89	33.6	12.6
7	#17325.00	57.9 PK	68.2	-10.3	3.57 V	80	41.6	16.3

REMARKS:

1. Emission Level(dBuV/m) = Raw Value(dBuV) + Correction Factor(dB/m)
2. Correction Factor(dB/m) = Antenna Factor(dB/m) + Cable Factor(dB) – Pre-Amplifier Factor(dB)
3. The other emission levels were very low against the limit.
4. Margin value = Emission Level – Limit value
5. " * ": Fundamental frequency.
6. " # ": The radiated frequency is out of the restricted band.

Below 1GHz Data:

802.11ac (VHT20)

CHANNEL	TX Channel 165	DETECTOR FUNCTION	Quasi-Peak (QP)
FREQUENCY RANGE	9kHz ~ 1GHz		

ANTENNA POLARITY & TEST DISTANCE: HORIZONTAL AT 3 M

NO.	FREQ. (MHz)	EMISSION LEVEL (dBuV/m)	LIMIT (dBuV/m)	MARGIN (dB)	ANTENNA HEIGHT (m)	TABLE ANGLE (Degree)	RAW VALUE (dBuV)	CORRECTION FACTOR (dB/m)
1	124.97	26.5 QP	43.5	-17.0	1.50 H	88	36.5	-10.0
2	250.01	28.6 QP	46.0	-17.4	1.00 H	117	37.5	-8.9
3	375.00	33.3 QP	46.0	-12.7	1.00 H	48	38.5	-5.2
4	504.01	30.4 QP	46.0	-15.6	1.50 H	346	32.3	-1.9
5	624.98	39.4 QP	46.0	-6.6	1.00 H	360	38.8	0.6
6	792.02	36.1 QP	46.0	-9.9	1.00 H	179	33.0	3.1

REMARKS:

1. Emission Level(dBuV/m) = Raw Value(dBuV) + Correction Factor(dB/m)
2. Correction Factor(dB/m) = Antenna Factor(dB/m) + Cable Factor(dB) – Pre-Amplifier Factor(dB)
3. Margin value = Emission Level – Limit value
4. The emission levels were very low against the limit of frequency range 9kHz~30MHz: the amplitude of spurious emissions attenuated more than 20 dB below the permissible value to be report.

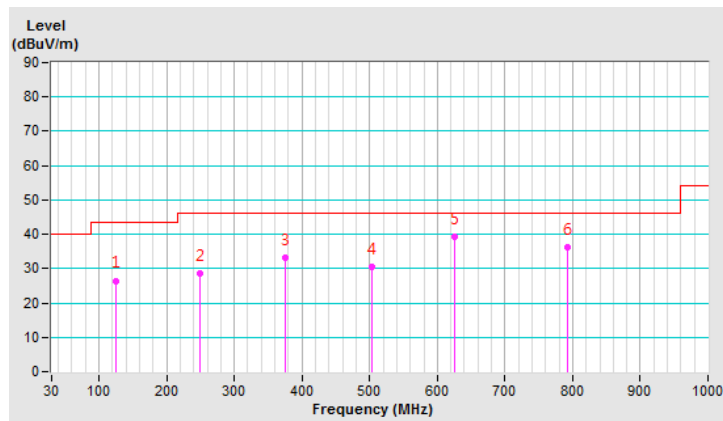

CHANNEL	TX Channel 165	DETECTOR FUNCTION	Quasi-Peak (QP)
FREQUENCY RANGE	9kHz ~ 1GHz		

ANTENNA POLARITY & TEST DISTANCE: VERTICAL AT 3 M

NO.	FREQ. (MHz)	EMISSION LEVEL (dBuV/m)	LIMIT (dBuV/m)	MARGIN (dB)	ANTENNA HEIGHT (m)	TABLE ANGLE (Degree)	RAW VALUE (dBuV)	CORRECTION FACTOR (dB/m)
1	77.82	30.7 QP	40.0	-9.3	1.00 V	0	43.8	-13.1
2	360.01	30.3 QP	46.0	-15.7	1.50 V	250	35.9	-5.6
3	375.00	32.3 QP	46.0	-13.7	1.00 V	327	37.5	-5.2
4	504.01	32.7 QP	46.0	-13.3	1.00 V	282	34.6	-1.9
5	624.98	34.7 QP	46.0	-11.3	1.50 V	349	34.1	0.6
6	719.03	38.7 QP	46.0	-7.3	2.00 V	0	37.1	1.6

REMARKS:

1. Emission Level(dBuV/m) = Raw Value(dBuV) + Correction Factor(dB/m)
2. Correction Factor(dB/m) = Antenna Factor(dB/m) + Cable Factor(dB) – Pre-Amplifier Factor(dB)
3. Margin value = Emission Level – Limit value
4. The emission levels were very low against the limit of frequency range 9kHz~30MHz: the amplitude of spurious emissions attenuated more than 20 dB below the permissible value to be report.

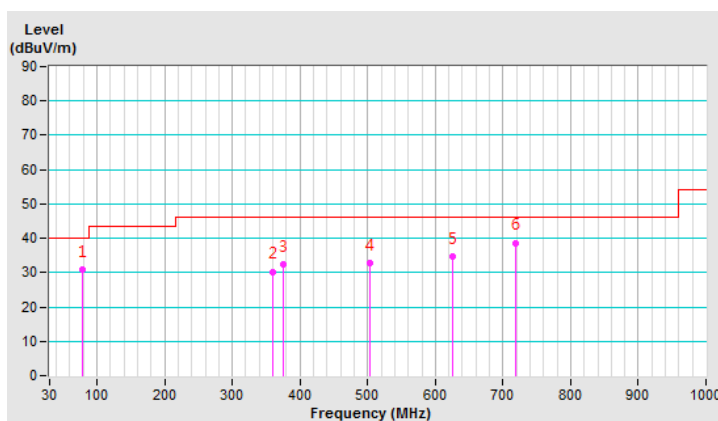

4.2 Conducted Emission Measurement

4.2.1 Limits of Conducted Emission Measurement

Frequency (MHz)	Conducted Limit (dBuV)	
	Quasi-peak	Average
0.15 - 0.5	66 - 56	56 - 46
0.50 - 5.0	56	46
5.0 - 30.0	60	50

Note: 1. The lower limit shall apply at the transition frequencies.

2. The limit decreases in line with the logarithm of the frequency in the range of 0.15 to 0.50MHz.

4.2.2 Test Instruments

DESCRIPTION & MANUFACTURER	MODEL NO.	SERIAL NO.	CALIBRATED DATE	CALIBRATED UNTIL
Test Receiver R&S	ESCS 30	847124/029	Oct. 24, 2018	Oct. 23, 2019
Line-Impedance Stabilization Network (for EUT) R&S	ESH3-Z5	848773/004	Oct. 22, 2018	Oct. 21, 2019
Line-Impedance Stabilization Network (for Peripheral) R&S	ENV216	100072	June 04, 2018	June 03, 2019
50 ohms Terminator	N/A	3	Oct. 22, 2018	Oct. 21, 2019
RF Cable	5D-FB	COCCAB-001	Sep. 28, 2018	Sep. 27, 2019
Fixed attenuator EMCI	STI02-2200-10	003	Mar. 16, 2018	Mar. 15, 2019
Software BVADT	BVADT_Cond_ V7.3.7.4	NA	NA	NA

Note:

1. The calibration interval of the above test instruments are 12 months and the calibrations are traceable to NML/ROC and NIST/USA.
2. The test was performed in Conduction 1.
3. Tested Date: Jan. 05, 2019

4.2.3 Test Procedure

- The EUT was placed 0.4 meters from the conducting wall of the shielded room with EUT being connected to the power mains through a line impedance stabilization network (LISN). Other support units were connected to the power mains through another LISN. The two LISNs provide 50 ohm/ 50uH of coupling impedance for the measuring instrument.
- Both lines of the power mains connected to the EUT were checked for maximum conducted interference.
- The frequency range from 150kHz to 30MHz was searched. Emission levels under (Limit - 20dB) was not recorded.

Note: All modes of operation were investigated and the worst-case emissions are reported.

4.2.4 Deviation from Test Standard

No deviation.

4.2.5 Test Setup

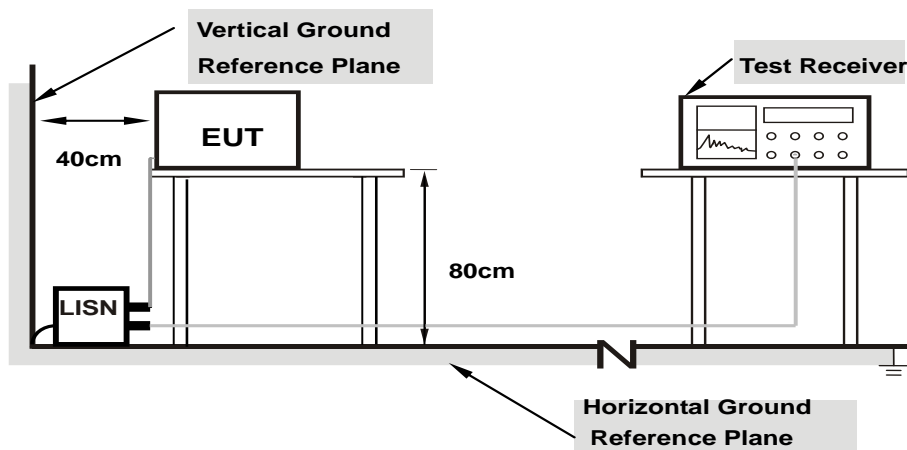

Note: 1.Support units were connected to second LISN.

For the actual test configuration, please refer to the attached file (Test Setup Photo).

4.2.6 EUT Operating Condition

Same as 4.1.6.

4.2.7 Test Results

Phase	Line (L)	Detector Function	Quasi-Peak (QP) / Average (AV)
-------	----------	-------------------	--------------------------------

No	Freq. [MHz]	Corr.	Reading Value		Emission Level		Limit		Margin	
		Factor (dB)	[dB (uV)]		[dB (uV)]		[dB (uV)]		(dB)	
			Q.P.	AV.	Q.P.	AV.	Q.P.	AV.	Q.P.	AV.
1	0.15000	10.03	44.00	31.45	54.03	41.48	66.00	56.00	-11.97	-14.52
2	0.17344	10.04	35.75	21.40	45.79	31.44	64.79	54.79	-19.00	-23.35
3	0.19297	10.05	33.93	23.33	43.98	33.38	63.91	53.91	-19.93	-20.53
4	0.19297	10.05	33.78	23.35	43.83	33.40	63.91	53.91	-20.08	-20.51
5	0.34141	10.07	27.06	19.49	37.13	29.56	59.17	49.17	-22.04	-19.61
6	23.84375	11.45	26.27	16.60	37.72	28.05	60.00	50.00	-22.28	-21.95

Remarks:

1. Q.P. and AV. are abbreviations of quasi-peak and average individually.
2. The emission levels of other frequencies were very low against the limit.
3. Margin value = Emission level – Limit value
4. Correction factor = Insertion loss + Cable loss
5. Emission Level = Correction Factor + Reading Value

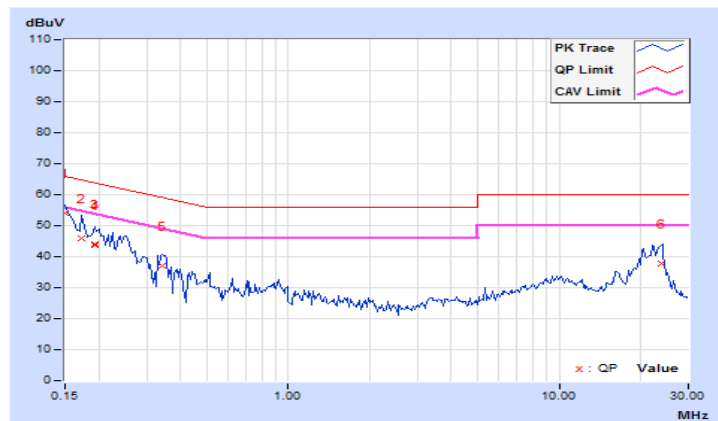

Phase	Neutral (N)	Detector Function	Quasi-Peak (QP) / Average (AV)
-------	-------------	-------------------	--------------------------------

No	Freq. [MHz]	Corr. Factor	Reading Value [dB (uV)]		Emission Level [dB (uV)]		Limit [dB (uV)]		Margin (dB)	
		(dB)	Q.P.	AV.	Q.P.	AV.	Q.P.	AV.	Q.P.	AV.
	1	0.15000	9.94	44.44	31.53	54.38	41.47	66.00	56.00	-11.62
2	0.18906	9.95	33.00	19.81	42.95	29.76	64.08	54.08	-21.13	-24.32
3	0.23203	9.95	29.35	15.95	39.30	25.90	62.38	52.38	-23.08	-26.48
4	0.33750	9.97	23.00	11.13	32.97	21.10	59.26	49.26	-26.29	-28.16
5	9.41406	10.49	21.96	16.50	32.45	26.99	60.00	50.00	-27.55	-23.01
6	21.84375	11.17	25.50	16.95	36.67	28.12	60.00	50.00	-23.33	-21.88

Remarks:

1. Q.P. and AV. are abbreviations of quasi-peak and average individually.
2. The emission levels of other frequencies were very low against the limit.
3. Margin value = Emission level – Limit value
4. Correction factor = Insertion loss + Cable loss
5. Emission Level = Correction Factor + Reading Value

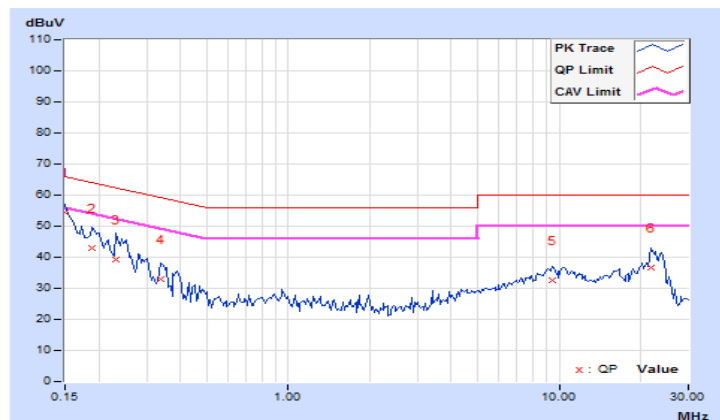

4.3 Transmit Power Measurement

4.3.1 Limits of Transmit Power Measurement

Operation Band	EUT Category		Limit
U-NII-1		Outdoor Access Point	1 Watt (30 dBm) (Max. e.i.r.p \leq 125mW(21 dBm) at any elevation angle above 30 degrees as measured from the horizon)
		Fixed point-to-point Access Point	1 Watt (30 dBm)
	√	Indoor Access Point	1 Watt (30 dBm)
		Client device	250mW (24 dBm)
U-NII-2A			250mW (24 dBm) or 11 dBm+10 log B*
U-NII-2C			250mW (24 dBm) or 11 dBm+10 log B*
U-NII-3		√	1 Watt (30 dBm)

*B is the 26 dB emission bandwidth in megahertz

Per KDB 662911 Method of conducted output power measurement on IEEE 802.11 devices,

Array Gain = 0 dB (i.e., no array gain) for $N_{ANT} \leq 4$;

Array Gain = 0 dB (i.e., no array gain) for channel widths ≥ 40 MHz for any N_{ANT} ;

Array Gain = $5 \log(N_{ANT}/N_{SS})$ dB or 3 dB, whichever is less for 20-MHz channel widths with $N_{ANT} \geq 5$.

For power measurements on all other devices: Array Gain = $10 \log(N_{ANT}/N_{SS})$ dB.

4.3.2 Test Setup

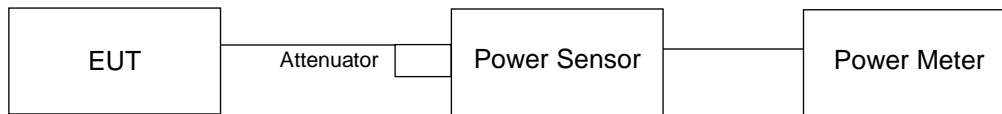

4.3.3 Test Instruments

Refer to section 4.1.2 to get information of above instrument.

4.3.4 Test Procedure

Method PM is used to perform output power measurement, trigger and gating function of wide band power meter is enabled to measure max output power of TX on burst. Duty factor is not added to measured value.

4.3.5 Deviation from Test Standard

No deviation.

4.3.6 EUT Operating Condition

The software provided by client to enable the EUT under transmission condition continuously at lowest, middle and highest channel frequencies individually.

4.3.7 Test Results

CDD Mode

802.11a

Chan.	Chan. Freq. (MHz)	Maximum Conducted Power (dBm)			Total Power (mW)	Total Power (dBm)	Limit (dBm)	Pass / Fail
		Chain 0	Chain 1	Chain 2				
36	5180	22.10	22.14	21.67	472.756	26.75	30	Pass
40	5200	22.02	22.12	21.63	467.697	26.70	30	Pass
48	5240	21.78	22.10	21.54	455.403	26.58	30	Pass
149	5745	22.20	22.37	22.24	506.037	27.04	30	Pass
157	5785	22.41	22.46	22.20	516.338	27.13	30	Pass
165	5825	22.36	22.68	22.15	521.599	27.17	30	Pass

802.11ac (VHT20)

Chan.	Chan. Freq. (MHz)	Maximum Conducted Power (dBm)			Total Power (mW)	Total Power (dBm)	Limit (dBm)	Pass / Fail
		Chain 0	Chain 1	Chain 2				
36	5180	21.98	21.72	21.48	446.96	26.50	30	Pass
40	5200	21.96	22.12	21.74	469.245	26.71	30	Pass
48	5240	21.89	22.06	21.68	462.45	26.65	30	Pass
149	5745	22.16	22.27	22.11	495.647	26.95	30	Pass
157	5785	22.33	22.52	22.10	511.832	27.09	30	Pass
165	5825	22.58	22.70	22.22	534.068	27.28	30	Pass

802.11ac (VHT40)

Chan.	Chan. Freq. (MHz)	Maximum Conducted Power (dBm)			Total Power (mW)	Total Power (dBm)	Limit (dBm)	Pass / Fail
		Chain 0	Chain 1	Chain 2				
38	5190	15.81	16.08	16.48	123.121	20.90	30	Pass
46	5230	22.02	22.10	21.46	461.361	26.64	30	Pass
151	5755	21.28	21.26	21.23	400.675	26.03	30	Pass
159	5795	21.48	21.26	21.25	407.617	26.10	30	Pass

802.11ac (VHT80)

Chan.	Chan. Freq. (MHz)	Maximum Conducted Power (dBm)			Total Power (mW)	Total Power (dBm)	Limit (dBm)	Pass / Fail
		Chain 0	Chain 1	Chain 2				
42	5210	14.80	14.53	15.15	91.313	19.61	30	Pass
155	5775	21.83	22.34	21.72	472.395	26.74	30	Pass

Beamforming Mode

802.11ac (VHT20)

Chan.	Chan. Freq. (MHz)	Maximum Conducted Power (dBm)			Total Power (mW)	Total Power (dBm)	Limit (dBm)	Pass / Fail
		Chain 0	Chain 1	Chain 2				
36	5180	21.98	21.72	21.48	446.96	26.50	26.82	Pass
40	5200	21.96	22.12	21.74	469.245	26.71	26.82	Pass
48	5240	21.89	22.06	21.68	462.45	26.65	26.82	Pass
149	5745	21.65	21.74	21.53	437.73	26.41	26.82	Pass
157	5785	21.76	21.98	21.58	451.609	26.55	26.82	Pass
165	5825	21.89	22.16	21.74	468.241	26.70	26.82	Pass

Note: Directional gain = $10 \log[(10^{G0/20} + 10^{G1/20} + 10^{G2/20})^2 / 3] = 9.18\text{dBi} > 6\text{dBi}$, so the power limit shall be reduced to $30 - (9.18 - 6) = 26.82\text{dBm}$.

802.11ac (VHT40)

Chan.	Chan. Freq. (MHz)	Maximum Conducted Power (dBm)			Total Power (mW)	Total Power (dBm)	Limit (dBm)	Pass / Fail
		Chain 0	Chain 1	Chain 2				
38	5190	15.81	16.08	16.48	123.121	20.90	26.82	Pass
46	5230	22.02	22.10	21.46	461.361	26.64	26.82	Pass
151	5755	21.28	21.26	21.23	400.675	26.03	26.82	Pass
159	5795	21.48	21.26	21.25	407.617	26.10	26.82	Pass

Note: Directional gain = $10 \log[(10^{G0/20} + 10^{G1/20} + 10^{G2/20})^2 / 3] = 9.18\text{dBi} > 6\text{dBi}$, so the power limit shall be reduced to $30 - (9.18 - 6) = 26.82\text{dBm}$.

802.11ac (VHT80)

Chan.	Chan. Freq. (MHz)	Maximum Conducted Power (dBm)			Total Power (mW)	Total Power (dBm)	Limit (dBm)	Pass / Fail
		Chain 0	Chain 1	Chain 2				
42	5210	14.80	14.53	15.15	91.313	19.61	26.82	Pass
155	5775	21.83	22.34	21.72	472.395	26.74	26.82	Pass

Note: Directional gain = $10 \log[(10^{G0/20} + 10^{G1/20} + 10^{G2/20})^2 / 3] = 9.18\text{dBi} > 6\text{dBi}$, so the power limit shall be reduced to $30 - (9.18 - 6) = 26.82\text{dBm}$.

4.4 Occupied Bandwidth Measurement

4.4.1 Test Setup

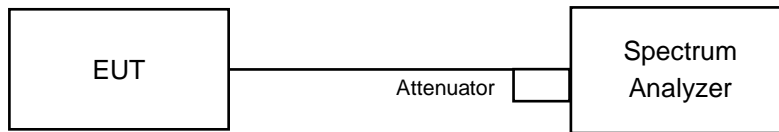

4.4.2 Test Instruments

Refer to section 4.1.2 to get information of above instrument.

4.4.3 Test Procedure

The transmitter output was connected to the spectrum analyzer through an attenuator. The bandwidth of the fundamental frequency was measured by spectrum analyzer with resolution bandwidth in the range of 1% to 5% of the anticipated emission bandwidth, and a video bandwidth at least 3x the resolution bandwidth and set the detector to SAMPLE. The width of a frequency band such that, below the lower and above the upper frequency limits, the mean powers emitted are each equal to a specified percentage 0.5 %of the total mean power of a given emission.

4.4.4 Test Results

802.11a

Channel	Channel Frequency (MHz)	Occupied Bandwidth (MHz)		
		Chain 0	Chain 1	Chain 2
36	5180	17.04	16.92	16.80
40	5200	16.80	16.92	16.92
48	5240	16.92	16.92	17.04
149	5745	17.28	17.40	16.92
157	5785	17.52	17.64	17.04
165	5825	17.64	17.76	17.16

802.11ac (VHT20)

Channel	Channel Frequency (MHz)	Occupied Bandwidth (MHz)		
		Chain 0	Chain 1	Chain 2
36	5180	18.00	18.00	17.88
40	5200	18.00	18.00	17.88
48	5240	17.88	18.00	17.88
149	5745	18.24	18.48	18.12
157	5785	18.36	18.60	18.00
165	5825	18.48	18.60	18.12

802.11ac (VHT40)

Channel	Channel Frequency (MHz)	Occupied Bandwidth (MHz)		
		Chain 0	Chain 1	Chain 2
38	5190	36.72	36.72	36.72
46	5230	36.72	36.72	36.72
151	5755	36.96	36.96	36.72
159	5795	36.96	37.20	36.96

802.11ac (VHT80)

Channel	Channel Frequency (MHz)	Occupied Bandwidth (MHz)		
		Chain 0	Chain 1	Chain 2
42	5210	75.84	76.32	75.36
155	5775	76.32	76.80	76.32

Spectrum Plot of Max Value

802.11a_Chain 1 / CH165

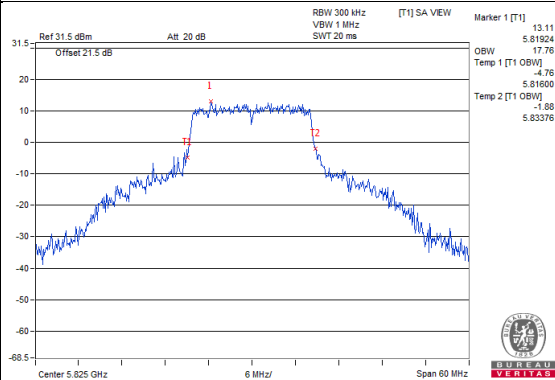

802.11ac (VHT20)_Chain 1 / CH157

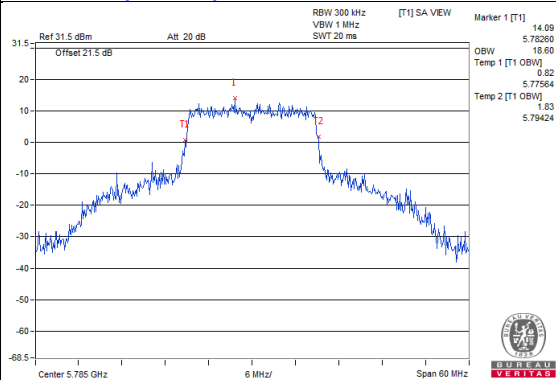

802.11ac (VHT40)_Chain 1 / CH159

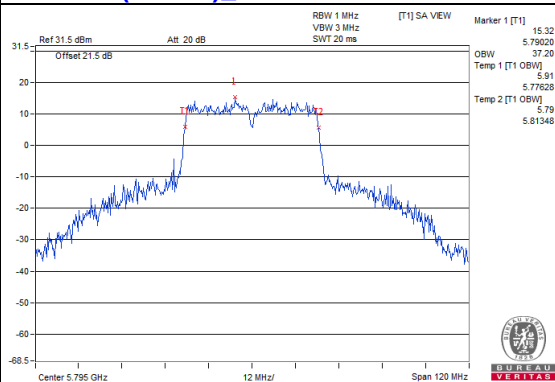

802.11ac (VHT80)_Chain 1 / CH155

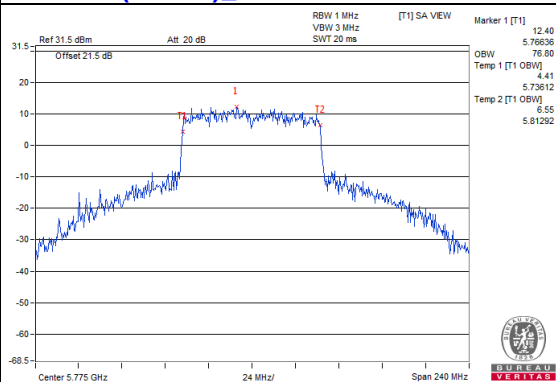

Spectrum Plot for near by DFS band (DFS is required, if 99% OCP straddle into U-NII-2A band)

802.11a_Chain0 / CH48

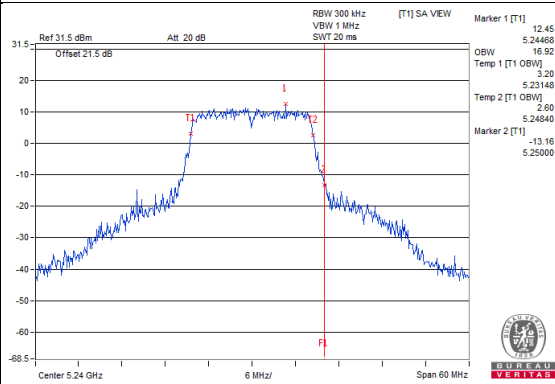

802.11a_Chain1 / CH48

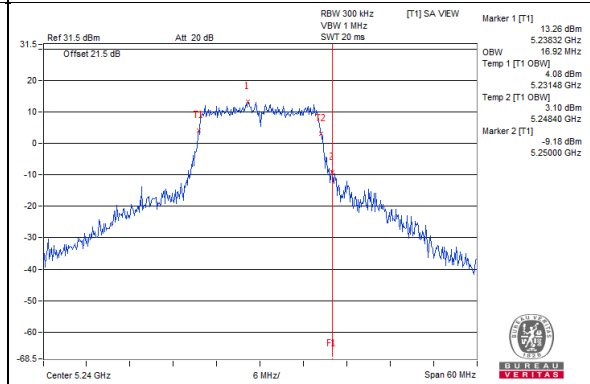

802.11a_Chain2 / CH48

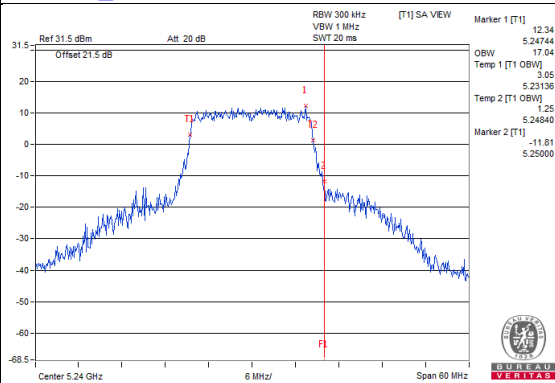

802.11ac(VHT20)_Chain0 / CH48

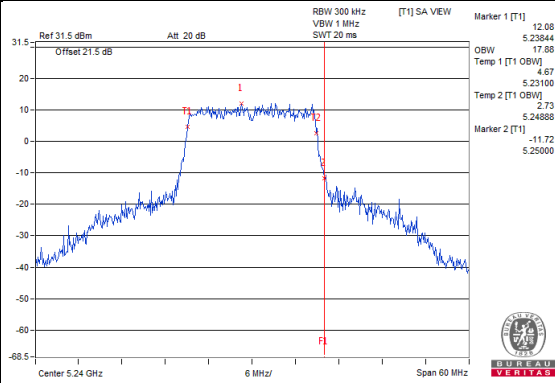

802.11ac(VHT20)_Chain1 / CH48

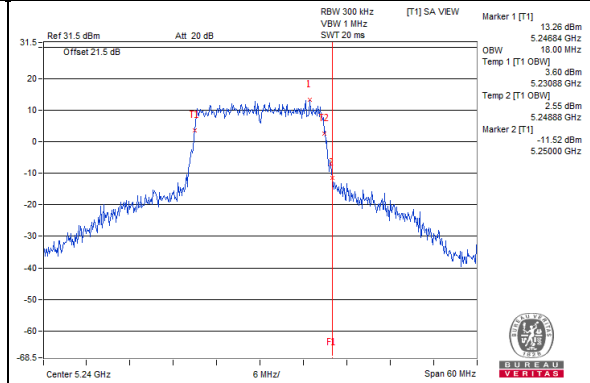

802.11ac(VHT20)_Chain2 / CH48

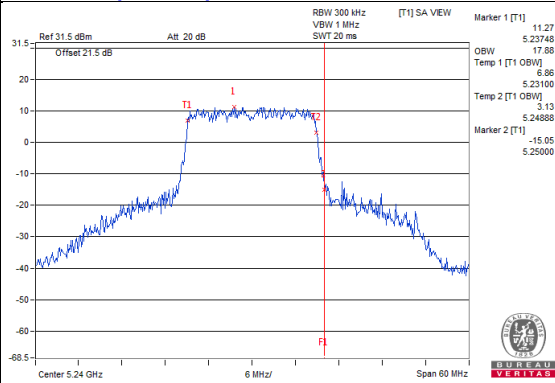

Spectrum Plot for near by DFS band (DFS is required, if 99% OCP straddle into U-NII-2A band)

802.11ac(VHT40)_Chain0 / CH46

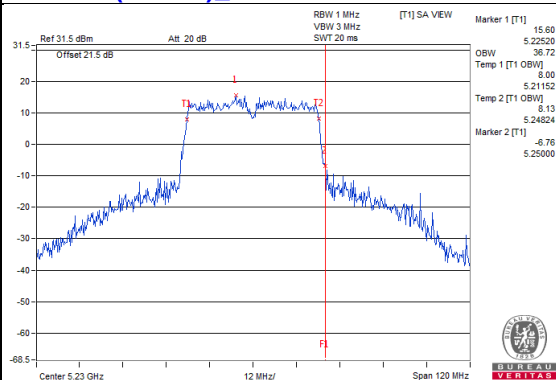

802.11ac(VHT40)_Chain1 / CH46

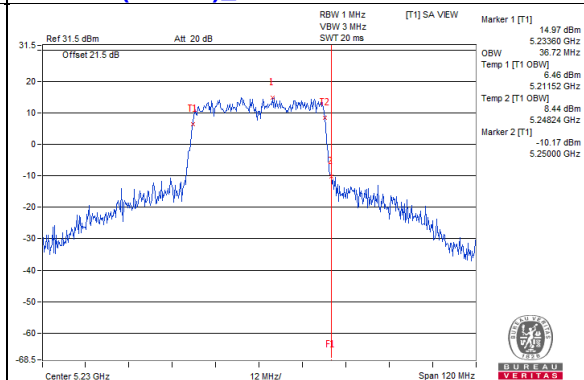

802.11ac(VHT40)_Chain2 / CH46

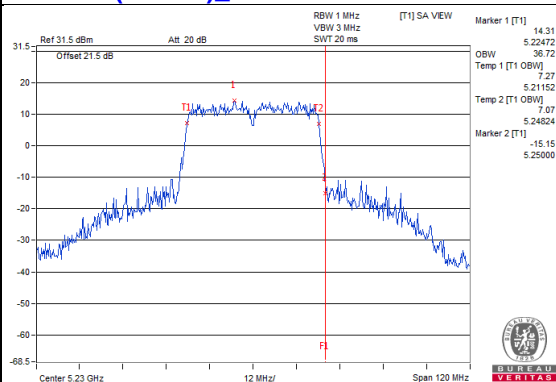

802.11ac(VHT80)_Chain0 / CH42

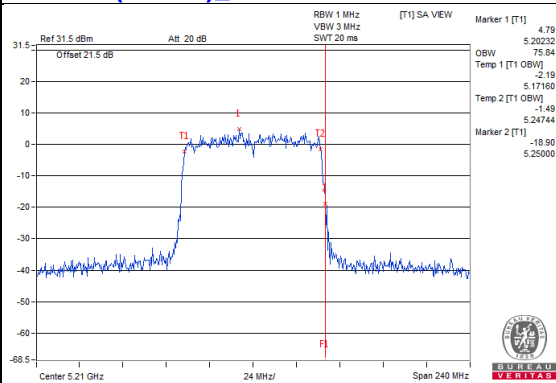

802.11ac(VHT80)_Chain1 / CH42

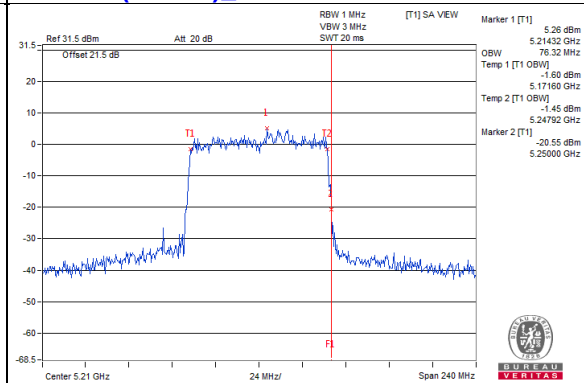

802.11ac(VHT80)_Chain2 / CH42

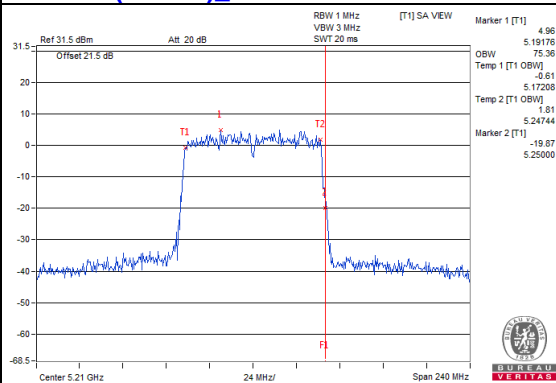

Spectrum Plot for near by DFS band (DFS is required, if 99% OCP straddle into U-NII-2C band)

802.11a_Chain0 / CH149

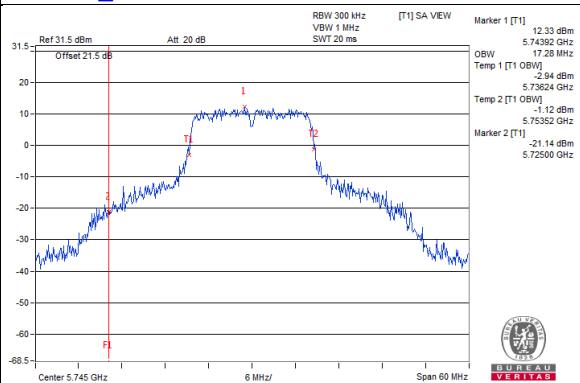

802.11a_Chain1 / CH149

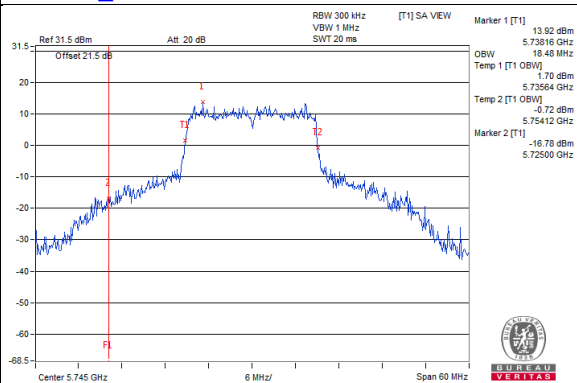

802.11a_Chain2 / CH149

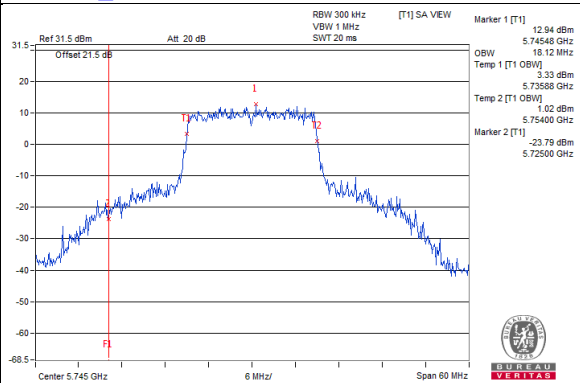

802.11ac(VHT20)_Chain0 / CH149

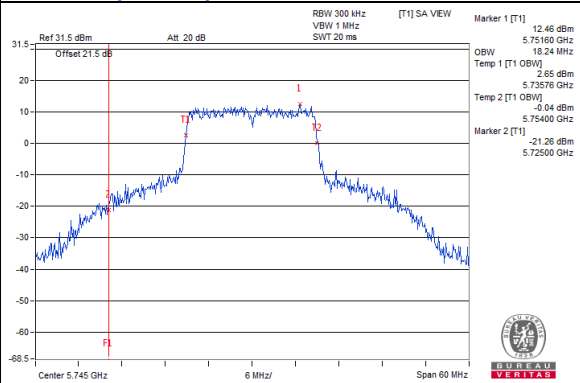

802.11ac(VHT20)_Chain1 / CH149

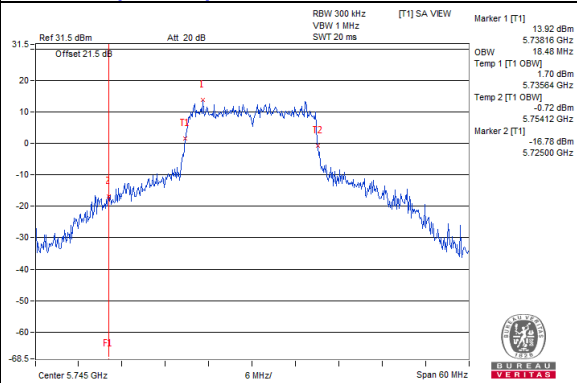

802.11ac(VHT20)_Chain2 / CH149

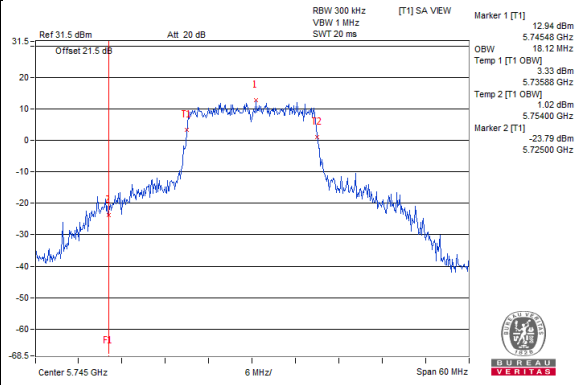

Spectrum Plot for near by DFS band (DFS is required, if 99% OCP straddle into U-NII-2C band)

802.11ac(VHT40)_Chain0 / CH151

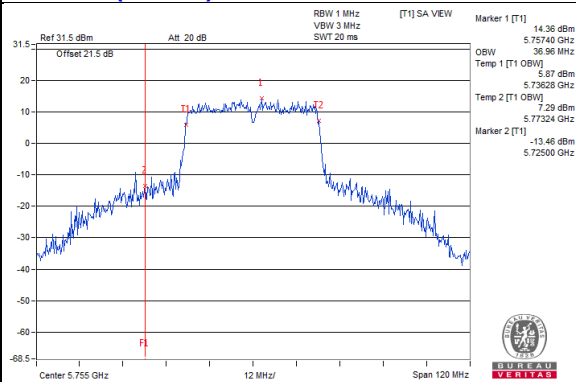

802.11ac(VHT40)_Chain1 / CH151

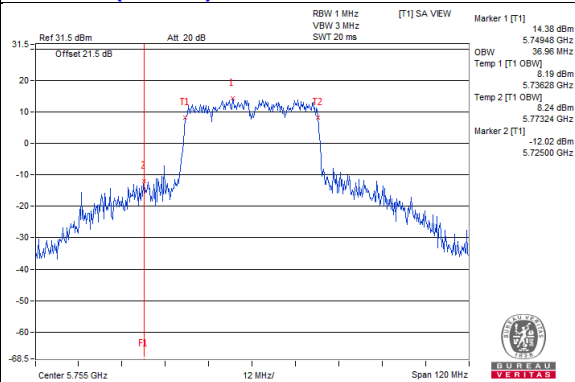

802.11ac(VHT40)_Chain2 / CH151

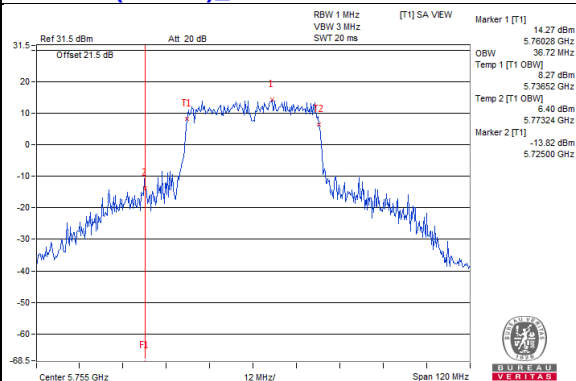

802.11ac(VHT80)_Chain0 / CH155

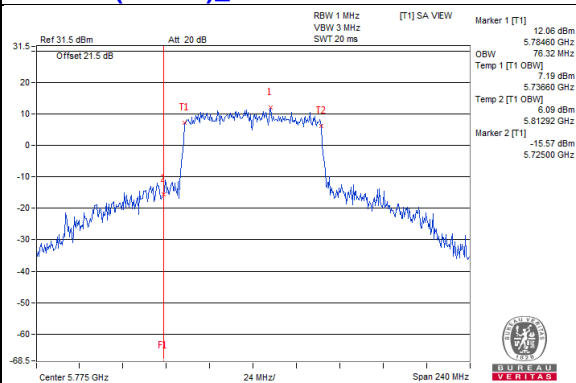

802.11ac(VHT80)_Chain1 / CH155

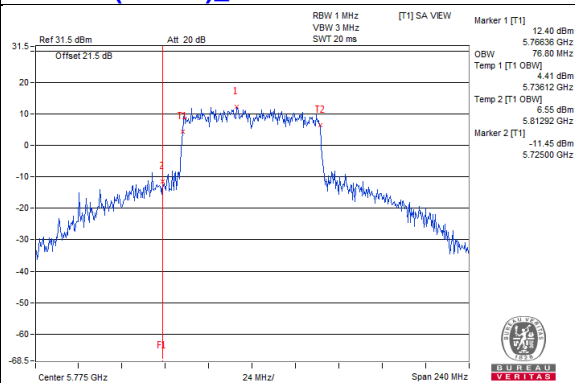

802.11ac(VHT80)_Chain2 / CH155

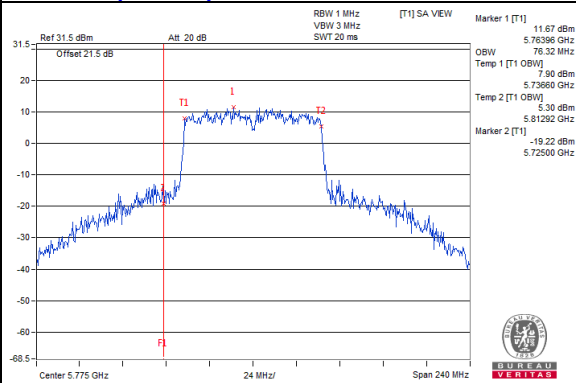

4.5 Peak Power Spectral Density Measurement

4.5.1 Limits of Peak Power Spectral Density Measurement

Operation Band	EUT Category		Limit
U-NII-1		Outdoor Access Point	17dBm/ MHz
		Fixed point-to-point Access Point	
	√	Indoor Access Point	
		Client device	11dBm/ MHz
U-NII-2A			11dBm/ MHz
U-NII-2C			11dBm/ MHz
U-NII-3	√		30dBm/ 500kHz

4.5.2 Test Setup

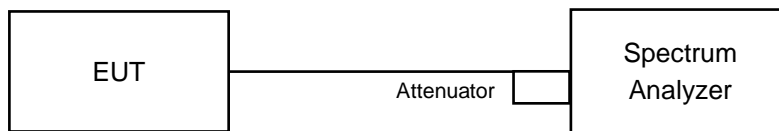

4.5.3 Test Instruments

Refer to section 4.1.2 to get information of above instrument.

4.5.4 Test Procedure

For U-NII-1 band:

For 802.11a:

Using method SA-1

1. Set span to encompass the entire emission bandwidth (EBW) of the signal.
2. Set RBW = 1 MHz, Set VBW \geq 3 MHz, Detector = RMS
3. Sweep time = auto, trigger set to "free run".
4. Trace average at least 100 traces in power averaging mode.
5. Record the max value

For other Modulation test:

Using method SA-2

1. Set span to encompass the entire emission bandwidth (EBW) of the signal.
2. Set RBW = 1 MHz, Set VBW \geq 3 MHz, Detector = RMS
3. Sweep time = auto, trigger set to "free run".
4. Trace average at least 100 traces in power averaging mode.
5. Record the max value and add $10 \log (1/\text{duty cycle})$

For U-NII-3 band:

For 802.11a:

1. Set span to encompass the entire emission bandwidth (EBW) of the signal.
2. Set RBW = 300 kHz, Set VBW \geq 1 MHz, Detector = RMS
3. Use the peak marker function to determine the maximum power level in any 300 kHz band segment within the fundamental EBW.
4. Scale the observed power level to an equivalent value in 500 kHz by adjusting (reducing) the measured power by a bandwidth correction factor (BWCF) where $BWCF = 10 \log(500\text{kHz}/300\text{kHz})$
5. Sweep time = auto, trigger set to "free run".
6. Trace average at least 100 traces in power averaging mode.
7. Record the max value

For other Modulation test:

1. Set span to encompass the entire emission bandwidth (EBW) of the signal.
2. Set RBW = 300 kHz, Set VBW \geq 1 MHz, Detector = RMS
3. Use the peak marker function to determine the maximum power level in any 300 kHz band segment within the fundamental EBW.
4. Scale the observed power level to an equivalent value in 500 kHz by adjusting (reducing) the measured power by a bandwidth correction factor (BWCF) where $BWCF = 10 \log(500\text{kHz}/300\text{kHz})$
5. Sweep time = auto, trigger set to "free run".
6. Trace average at least 100 traces in power averaging mode.
7. Record the max value and add $10 \log (1/\text{duty cycle})$

4.5.5 Deviation from Test Standard

No deviation.

4.5.6 EUT Operating Condition

Same as Item 4.3.6.

4.5.7 Test Results

For U-NII-1:

CDD Mode

802.11a

Chan.	Chan. Freq. (MHz)	PSD (dBm/MHz)			Total Power Density (dBm/MHz)	MAX. Limit (dBm/MHz)	Pass / Fail
		Chain 0	Chain 1	Chain 2			
36	5180	8.78	8.76	8.16	13.35	13.82	Pass
40	5200	8.76	8.76	8.28	13.38	13.82	Pass
48	5240	8.90	8.95	8.59	13.59	13.82	Pass

- Note:** 1. Method a) of power density measurement of KDB 662911 is using for calculating total power density. Total power density is summing entire spectra across corresponding frequency bins on the various outputs by computer.
2. Directional gain = $10 \log[(10^{G0/20} + 10^{G1/20} + 10^{G2/20})^2 / 3] = 9.18\text{dBi} > 6\text{dBi}$, so the power density limit shall be reduced to $17 - (9.18 - 6) = 13.82\text{dBm}$.

802.11ac (VHT20)

Chan.	Chan. Freq. (MHz)	PSD W/O Duty Factor (dBm/MHz)			Duty Factor (dB)	Total PSD With Duty Factor (dBm/MHz)	MAX. Limit (dBm/MHz)	Pass / Fail
		Chain 0	Chain 1	Chain 2				
36	5180	8.49	8.21	8.28	0.11	13.21	13.82	Pass
40	5200	8.49	8.85	8.25	0.11	13.42	13.82	Pass
48	5240	8.36	8.56	8.30	0.11	13.29	13.82	Pass

- Note:** 1. Method a) of power density measurement of KDB 662911 is using for calculating total power density. Total power density is summing entire spectra across corresponding frequency bins on the various outputs by computer.
2. Directional gain = $10 \log[(10^{G0/20} + 10^{G1/20} + 10^{G2/20})^2 / 3] = 9.18\text{dBi} > 6\text{dBi}$, so the power density limit shall be reduced to $17 - (9.18 - 6) = 13.82\text{dBm}$.
3. Refer to section 3.3 for duty cycle spectrum plot.

802.11ac (VHT40)

Chan.	Chan. Freq. (MHz)	PSD W/O Duty Factor (dBm/MHz)			Duty Factor (dB)	Total PSD With Duty Factor (dBm/MHz)	MAX. Limit (dBm/MHz)	Pass / Fail
		Chain 0	Chain 1	Chain 2				
38	5190	-1.34	-1.00	-0.89	0.14	3.84	13.82	Pass
46	5230	5.15	5.05	4.72	0.14	9.89	13.82	Pass

- Note:**
- Method a) of power density measurement of KDB 662911 is using for calculating total power density. Total power density is summing entire spectra across corresponding frequency bins on the various outputs by computer.
 - Directional gain = $10 \log[(10^{G0/20} + 10^{G1/20} + 10^{G2/20})^2 / 3] = 9.18\text{dBi} > 6\text{dBi}$, so the power density limit shall be reduced to $17-(9.18-6) = 13.82\text{dBm}$.
 - Refer to section 3.3 for duty cycle spectrum plot.

802.11ac (VHT80)

Chan.	Chan. Freq. (MHz)	PSD W/O Duty Factor (dBm/MHz)			Duty Factor (dB)	Total PSD With Duty Factor (dBm/MHz)	MAX. Limit (dBm/MHz)	Pass / Fail
		Chain 0	Chain 1	Chain 2				
42	5210	-5.31	-5.67	-5.23	0.27	-0.36	13.82	Pass

- Note:**
- Method a) of power density measurement of KDB 662911 is using for calculating total power density. Total power density is summing entire spectra across corresponding frequency bins on the various outputs by computer.
 - Directional gain = $10 \log[(10^{G0/20} + 10^{G1/20} + 10^{G2/20})^2 / 3] = 9.18\text{dBi} > 6\text{dBi}$, so the power density limit shall be reduced to $17-(9.18-6) = 13.82\text{dBm}$.
 - Refer to section 3.3 for duty cycle spectrum plot.

Spectrum Plot of Worst Value

802.11a / Chain 1 : CH48

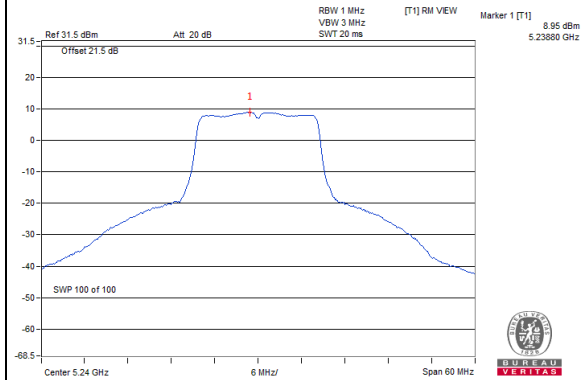

802.11ac (VHT20) / Chain 1 : CH40

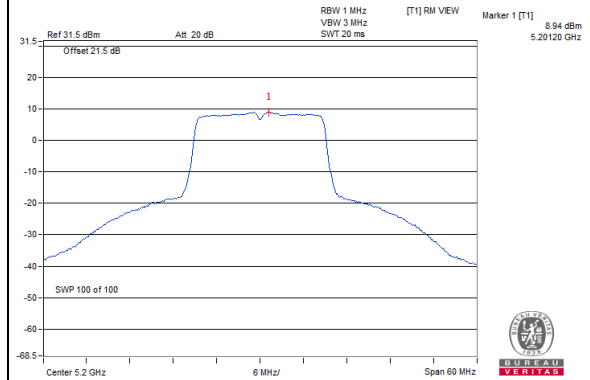

802.11ac (VHT40) / Chain 0: CH46

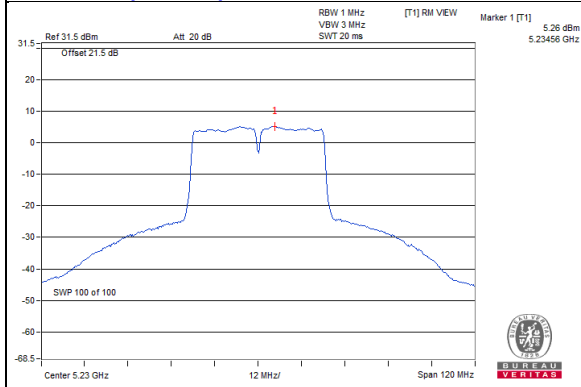

802.11ac (VHT80) / Chain 2 : CH42

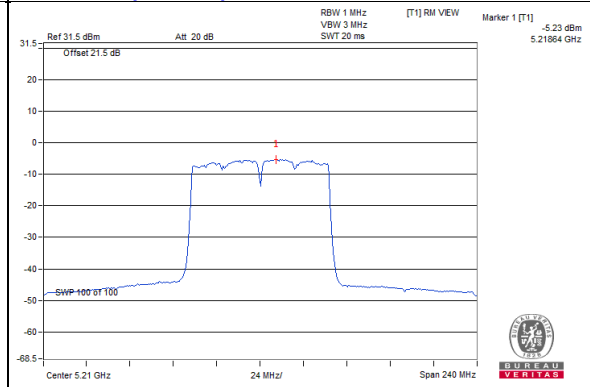

For U-NII-3:

802.11a

Chan.	Freq. (MHz)	PSD (dBm/300kHz)			Total PSD		Total PSD (dBm/500kHz)	Limit (dBm/500kHz)	Pass /Fail
		Chain 0	Chain 1	Chain 2	mW/300kHz	dBm/300kHz			
149	5745	0.59	0.75	0.57	3.4743	5.41	7.63	26.82	Pass
157	5785	0.77	0.76	0.69	3.5574	5.51	7.73	26.82	Pass
165	5825	0.85	0.91	0.37	3.5382	5.49	7.71	26.82	Pass

- Note: 1. Method b) Measure and sum spectral maxima across the outputs of KDB 662911 is using for calculating total power density.
 2. Directional gain = $10 \log[(10^{G0/20} + 10^{G1/20} + 10^{G2/20})^2 / 3] = 9.18\text{dBi} > 6\text{dBi}$, so the power density limit shall be reduced to $30-(9.18-6) = 26.82\text{dBm}$.

802.11ac (VHT20)

Chan.	Freq. (MHz)	PSD W/O Duty Factor (dBm/300kHz)			Duty Factor (dB)	Total PSD With Duty Factor		Total PSD With Duty Factor (dBm/500kHz)	Limit (dBm/500kHz)	Pass /Fail
		Chain 0	Chain 1	Chain 2		mW/300kHz	dBm/300kHz			
149	5745	0.16	0.54	-0.20	0.11	3.2015	5.05	7.27	26.82	Pass
157	5785	0.40	0.65	0.01	0.11	3.3402	5.24	7.46	26.82	Pass
165	5825	0.45	0.67	-0.19	0.11	3.3124	5.20	7.42	26.82	Pass

- Note: 1. Method b) Measure and sum spectral maxima across the outputs of KDB 662911 is using for calculating total power density.
 2. Directional gain = $10 \log[(10^{G0/20} + 10^{G1/20} + 10^{G2/20})^2 / 3] = 9.18\text{dBi} > 6\text{dBi}$, so the power density limit shall be reduced to $30-(9.18-6) = 26.82\text{dBm}$.
 3. Refer to section 3.3 for duty cycle spectrum plot.

802.11ac (VHT40)

Chan.	Freq. (MHz)	PSD W/O Duty Factor (dBm/300kHz)			Duty Factor (dB)	Total PSD With Duty Factor		Total PSD With Duty Factor (dBm/500kHz)	Limit (dBm/500kHz)	Pass /Fail
		Chain 0	Chain 1	Chain 2		mW/300kHz	dBm/300kHz			
151	5755	-3.79	-3.78	-3.76	0.14	1.2974	1.13	3.35	26.82	Pass
159	5795	-4.03	-4.29	-4.28	0.14	1.1773	0.71	2.93	26.82	Pass

- Note: 1. Method b) Measure and sum spectral maxima across the outputs of KDB 662911 is using for calculating total power density.
 2. Directional gain = $10 \log[(10^{G0/20} + 10^{G1/20} + 10^{G2/20})^2 / 3] = 9.18\text{dBi} > 6\text{dBi}$, so the power density limit shall be reduced to $30-(9.18-6) = 26.82\text{dBm}$.
 3. Refer to section 3.3 for duty cycle spectrum plot.

802.11ac (VHT80)

Chan.	Freq. (MHz)	PSD W/O Duty Factor (dBm/300kHz)			Duty Factor (dB)	Total PSD With Duty Factor		Total PSD With Duty Factor (dBm/500kHz)	Limit (dBm/ 500kHz)	Pass /Fail
		Chain 0	Chain 1	Chain 2		mW/ 300kHz	dBm/ 300kHz			
155	5775	-6.61	-6.22	-7.06	0.27	0.6952	-1.58	0.64	26.82	Pass

- Note: 1. Method b) Measure and sum spectral maxima across the outputs of KDB 662911 is using for calculating total power density.
2. Directional gain = $10 \log[(10^{G0/20} + 10^{G1/20} + 10^{G2/20})^2 / 3] = 9.18\text{dBi} > 6\text{dBi}$, so the power density limit shall be reduced to $30 - (9.18 - 6) = 26.82\text{dBm}$.
3. Refer to section 3.3 for duty cycle spectrum plot.

Spectrum Plot of Worst Value

802.11a / Chain 1 : CH165

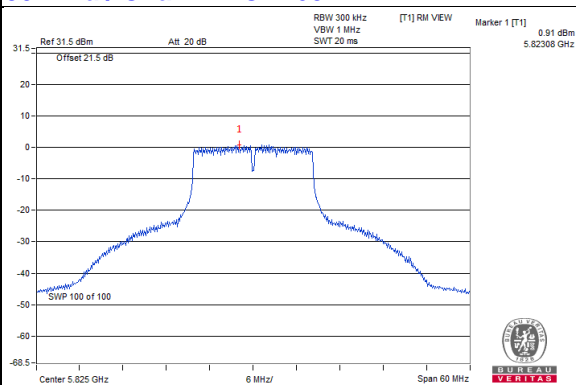

802.11ac (VHT20) / Chain 1 : CH165

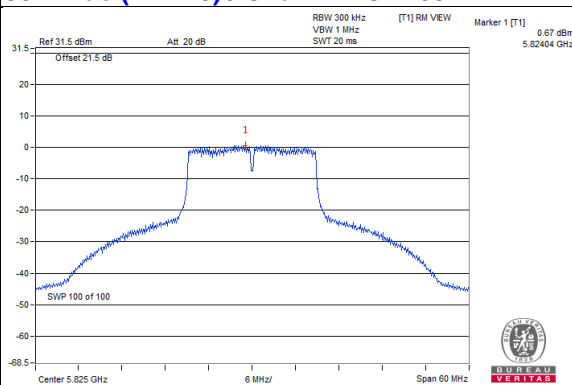

802.11ac (VHT40) / Chain 2: CH151

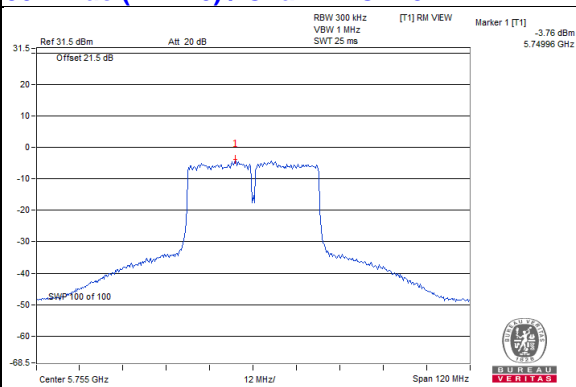

802.11ac (VHT80) / Chain 1 : CH155

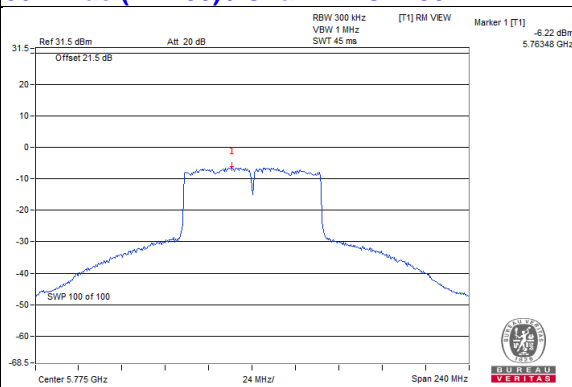

4.6 Frequency Stability Measurement

4.6.1 Limits of Frequency Stability Measurement

The frequency of the carrier signal shall be maintained within band of operation

4.6.2 Test Setup

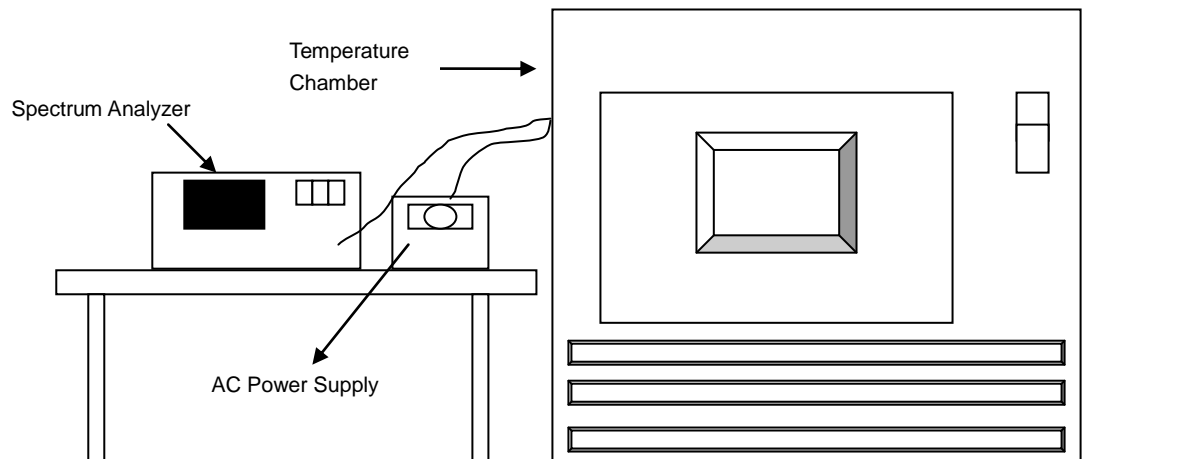

4.6.3 Test Instruments

Refer to section 4.1.2 to get information of above instrument.

4.6.4 Test Procedure

- The EUT was placed inside the environmental test chamber and powered by nominal AC voltage.
- Turn the EUT on and couple its output to a spectrum analyzer.
- Turn the EUT off and set the chamber to the highest temperature specified.
- Allow sufficient time (approximately 30 min) for the temperature of the chamber to stabilize, turn the EUT on and measure the operating frequency after 2, 5, and 10 Minutes.
- Repeat step (d) with the temperature chamber set to the next desired temperature until measurements down to the lowest specified temperature have been completed..
- The test chamber was allowed to stabilize at +20 degree C for a minimum of 30 Minutes. The supply voltage was then adjusted on the EUT from 85% to 115% and the frequency record.

4.6.5 Deviation from Test Standard

No deviation.

4.6.6 EUT Operating Condition

Set the EUT transmit at un-modulation mode to test frequency stability.

4.6.7 Test Results

Frequency Stability Versus Temp.									
Operating Frequency: 5180 MHz									
TEMP. (°C)	Power Supply (Vac)	0 Minute		2 Minutes		5 Minutes		10 Minutes	
		Measured Frequency (MHz)	Pass/Fail	Measured Frequency (MHz)	Pass/Fail	Measured Frequency (MHz)	Pass/Fail	Measured Frequency (MHz)	Pass/Fail
50	120	5179.9942	PASS	5179.9931	PASS	5179.9968	PASS	5179.9928	PASS
40	120	5179.9877	PASS	5179.987	PASS	5179.9866	PASS	5179.9842	PASS
30	120	5180.017	PASS	5180.0159	PASS	5180.0167	PASS	5180.0175	PASS
20	120	5180.0106	PASS	5180.0135	PASS	5180.0136	PASS	5180.0098	PASS
10	120	5180.0244	PASS	5180.026	PASS	5180.0247	PASS	5180.0273	PASS
0	120	5179.9768	PASS	5179.975	PASS	5179.9749	PASS	5179.9759	PASS
-10	120	5180.0097	PASS	5180.0079	PASS	5180.0078	PASS	5180.0101	PASS
-20	120	5180.0178	PASS	5180.0169	PASS	5180.0165	PASS	5180.0194	PASS
-30	120	5180.0184	PASS	5180.0172	PASS	5180.0188	PASS	5180.0184	PASS

Frequency Stability Versus Voltage									
Operating Frequency: 5180 MHz									
TEMP. (°C)	Power Supply (Vac)	0 Minute		2 Minutes		5 Minutes		10 Minutes	
		Measured Frequency (MHz)	Pass/Fail	Measured Frequency (MHz)	Pass/Fail	Measured Frequency (MHz)	Pass/Fail	Measured Frequency (MHz)	Pass/Fail
20	138	5180.0105	PASS	5180.0139	PASS	5180.0144	PASS	5180.01	PASS
	120	5180.0106	PASS	5180.0135	PASS	5180.0136	PASS	5180.0098	PASS
	102	5180.0102	PASS	5180.0131	PASS	5180.0126	PASS	5180.0094	PASS

4.7 6dB Bandwidth Measurement

4.7.1 Limits of 6dB Bandwidth Measurement

The minimum of 6dB Bandwidth Measurement is 0.5MHz.

4.7.2 Test Setup

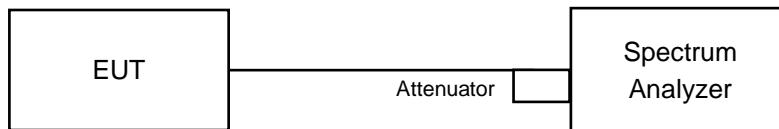

4.7.3 Test Instruments

Refer to section 4.1.2 to get information of above instrument.

4.7.4 Test Procedure

MEASUREMENT PROCEDURE REF

- Set resolution bandwidth (RBW) = 100kHz
- Set the video bandwidth (VBW) $\geq 3 \times$ RBW, Detector = Peak.
- Trace mode = max hold.
- Sweep = auto couple.
- Measure the maximum width of the emission that is constrained by the frequencies associated with the two amplitude points (upper and lower) that are attenuated by 6 dB relative to the maximum level measured in the fundamental emission

4.7.5 Deviation from Test Standard

No deviation.

4.7.6 EUT Operating Condition

The software provided by client to enable the EUT under transmission condition continuously at lowest, middle and highest channel frequencies individually.

4.7.7 Test Results

802.11a

Channel	Frequency (MHz)	6dB Bandwidth (MHz)			Minimum Limit (MHz)	Pass / Fail
		Chain 0	Chain 1	Chain 2		
149	5745	16.40	16.41	16.41	0.5	Pass
157	5785	16.42	16.42	16.42	0.5	Pass
165	5825	16.41	16.42	16.45	0.5	Pass

802.11ac (VHT20)

Channel	Frequency (MHz)	6dB Bandwidth (MHz)			Minimum Limit (MHz)	Pass / Fail
		Chain 0	Chain 1	Chain 2		
149	5745	17.63	17.67	17.66	0.5	Pass
157	5785	17.62	17.66	17.65	0.5	Pass
165	5825	17.64	17.66	17.65	0.5	Pass

802.11ac (VHT40)

Channel	Frequency (MHz)	6dB Bandwidth (MHz)			Minimum Limit (MHz)	Pass / Fail
		Chain 0	Chain 1	Chain 2		
151	5755	36.36	36.44	36.42	0.5	Pass
159	5795	36.40	36.41	36.38	0.5	Pass

802.11ac (VHT80)

Channel	Frequency (MHz)	6dB Bandwidth (MHz)			Minimum Limit (MHz)	Pass / Fail
		Chain 0	Chain 1	Chain 2		
155	5775	75.92	75.80	75.58	0.5	Pass

Spectrum Plot of Worst Value

802.11a / Chain 0 : CH149

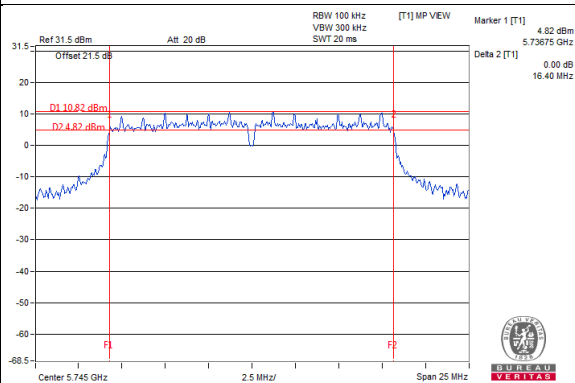

802.11ac (VHT20) / Chain 0 : CH157

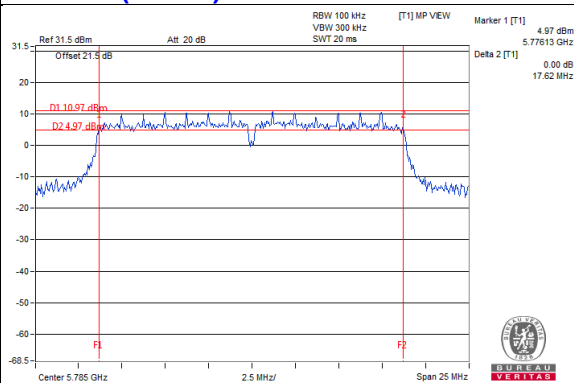

802.11ac (VHT40) / Chain 0 : CH151

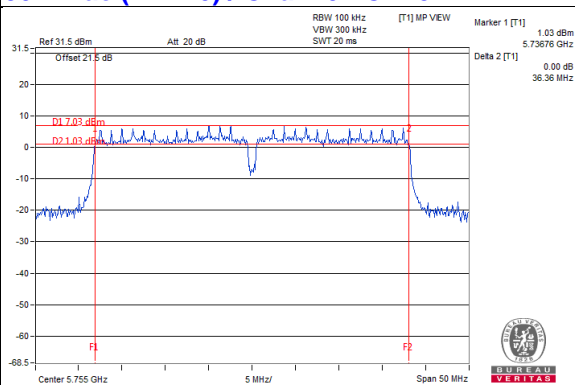

802.11ac (VHT80) / Chain 2 : CH155

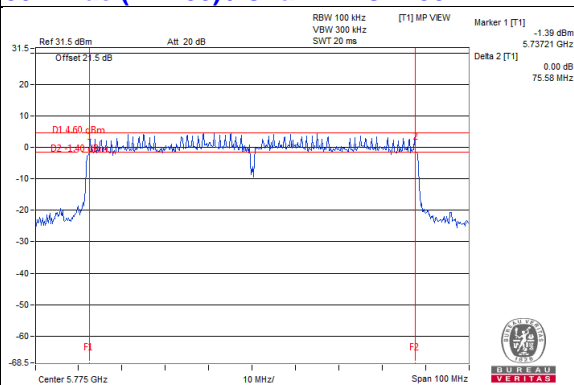

5 Pictures of Test Arrangements

Please refer to the attached file (Test Setup Photo).

Annex A- Radiated Out of Band Emission (OOBE) Measurement (For U-NII-3 band)

802.11a

CH 149 5745 MHz

Horizontal

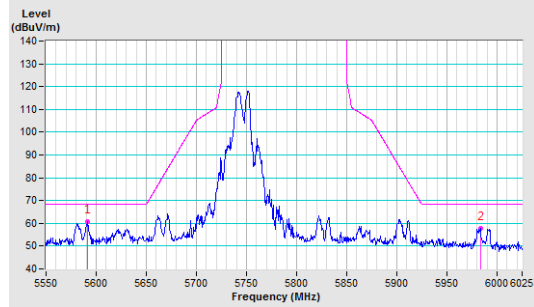

Vertical

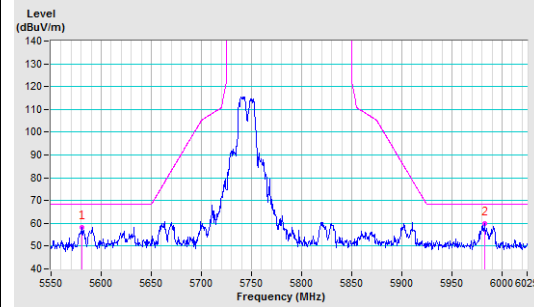

CH 157 5785 MHz

Horizontal

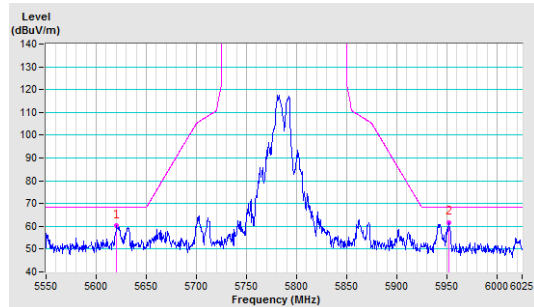

Vertical

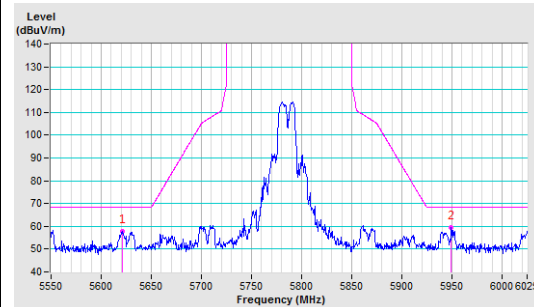

CH 165 5825 MHz

Horizontal

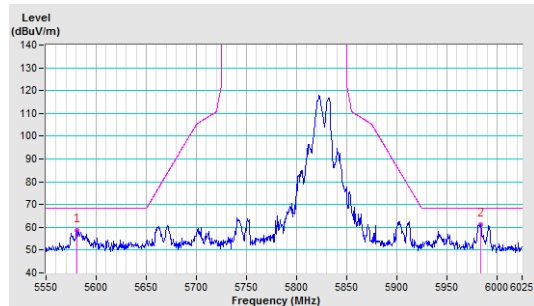

Vertical

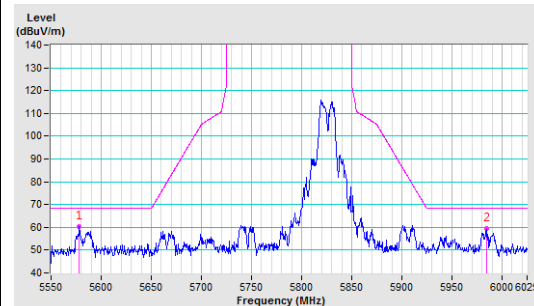

802.11ac (VHT20)

CH 149 5745 MHz

Horizontal

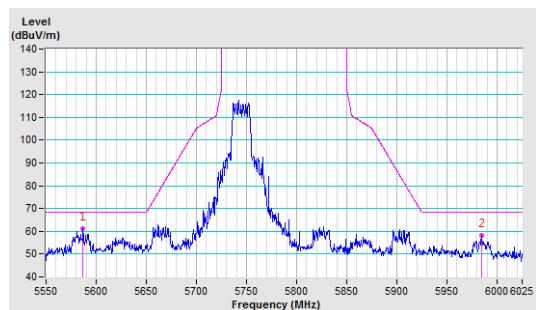

Vertical

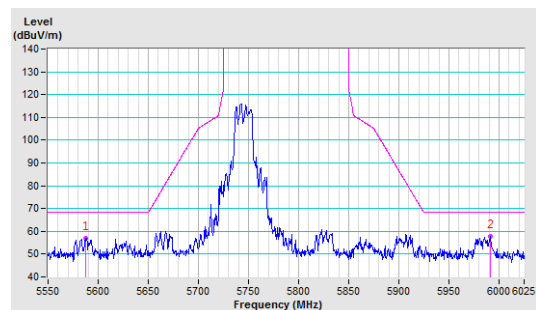

CH 157 5785 MHz

Horizontal

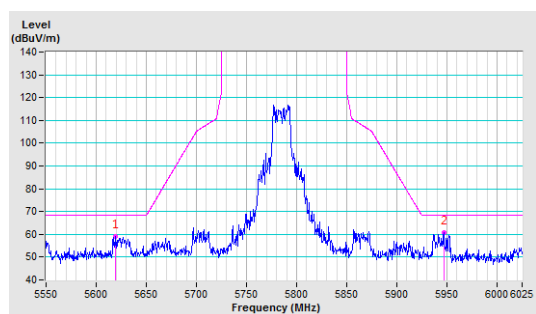

Vertical

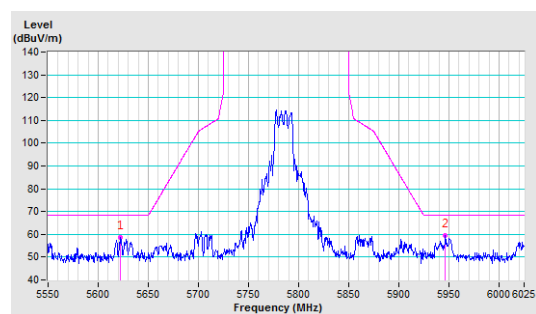

CH 165 5825 MHz

Horizontal

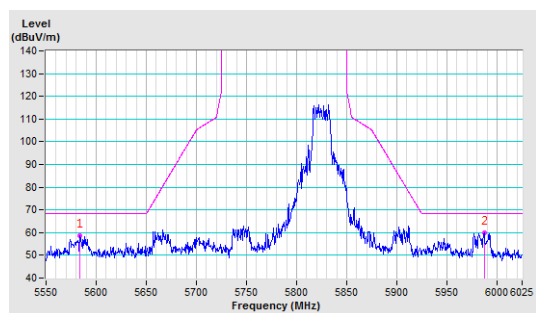

Vertical

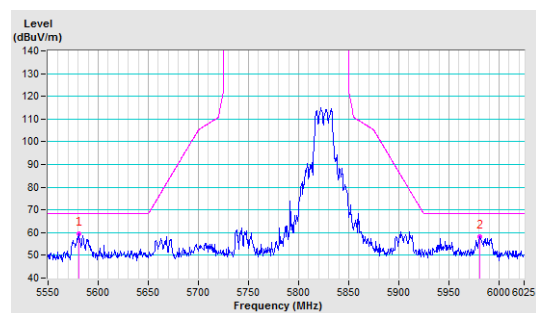

802.11ac (VHT40)

CH 151 5755 MHz

Horizontal

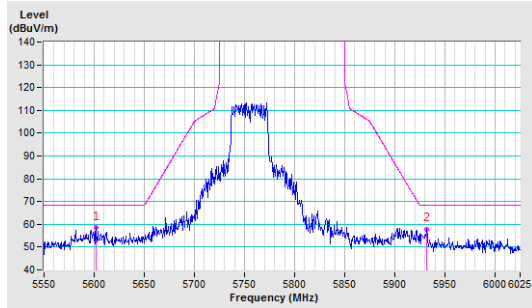

Vertical

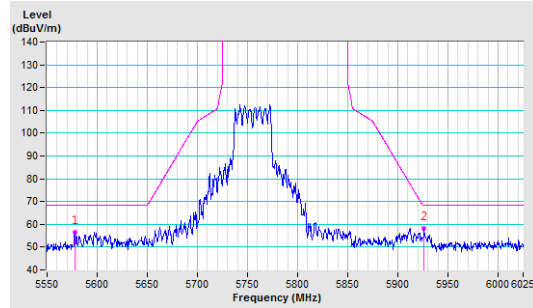

CH 159 5795 MHz

Horizontal

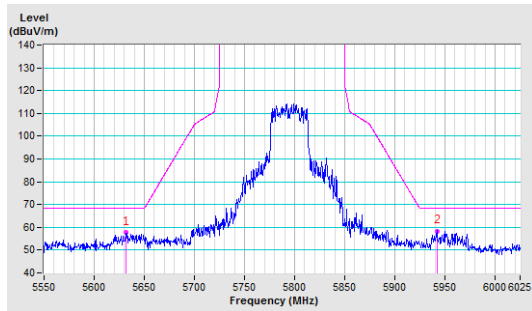

Vertical

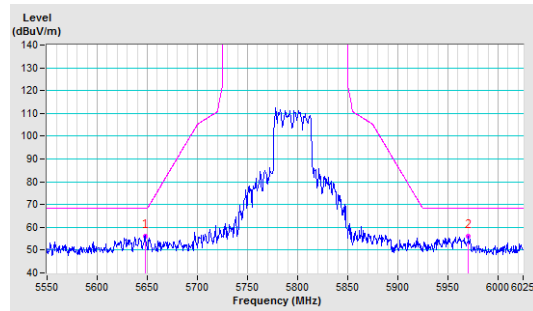

802.11ac (VHT80)

CH 155 5775 MHz

Horizontal

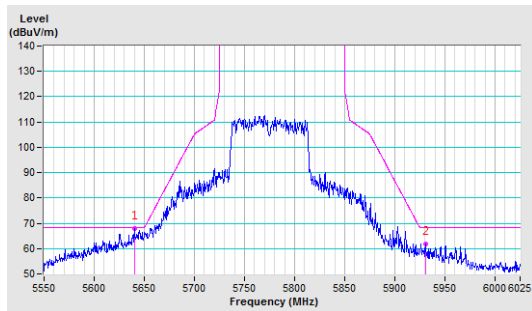

Vertical

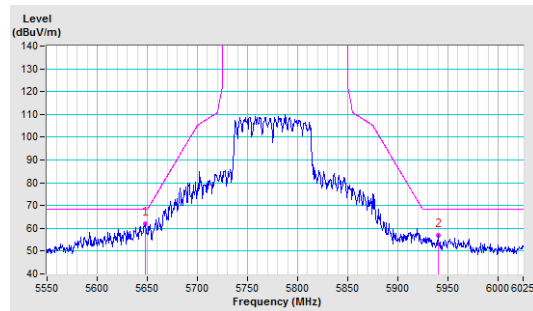

Appendix – Information of the Testing Laboratories

We, Bureau Veritas Consumer Products Services (H.K.) Ltd., Taoyuan Branch, were founded in 1988 to provide our best service in EMC, Radio, Telecom and Safety consultation. Our laboratories are FCC recognized accredited test firms and accredited according to ISO/IEC 17025.

If you have any comments, please feel free to contact us at the following:

Linkou EMC/RF Lab

Tel: 886-2-26052180

Fax: 886-2-26051924

Hsin Chu EMC/RF/Telecom Lab

Tel: 886-3-6668565

Fax: 886-3-6668323

Hwa Ya EMC/RF/Safety Lab

Tel: 886-3-3183232

Fax: 886-3-3270892

Email: service.adt@tw.bureauveritas.com

Web Site: www.bureauveritas-adt.com

The address and road map of all our labs can be found in our web site also.

--- END ---