FCC Test Report

Report No.: AGC05086170602FE08

FCC ID : XBPUV-R50
TYPE OF AUTHORIZATION : Certification
APPLICATION PURPOSE : Original Equipment
PRODUCT DESIGNATION : Two way radio
BRAND NAME : Quansheng
MODEL NAME : UV-R50
CLIENT : Fujian Nanan Quansheng Electronics Co., Ltd.
DATE OF ISSUE : Jul.07, 2017
STANDARD(S) : FCC Part 15 Rules
REPORT VERSION : V 1.0

Attestation of Global Compliance (Shenzhen) Co., Ltd



CAUTION:

This report shall not be reproduced except in full without the written permission of the test laboratory and shall not be quoted out of context.



Report Revise Record

Report Version	Revise Time	Issued Date	Valid Version	Notes
V1.0	/	Jul.07, 2017	Valid	Original Report

TABLE OF CONTENTS

1. VERIFICATION OF COMPLIANCE	4
2. PRODUCT INFORMATION	5
3. IDENTIFICATION OF THE RESPONSIBLE TESTING LOCATION	6
4. SUPPORT EQUIPMENT LIST	7
5. SYSTEM DESCRIPTION.....	7
6. SUMMARY OF TEST RESULTS	8
7. FCC RADIATED EMISSION TEST	9
7.1. TEST EQUIPMENT OF RADIATED EMISSION	9
7.2. LIMITS OF RADIATED EMISSION TEST	9
7.3 BLOCK DIAGRAM OF RADIATED EMISSION TEST	9
7.4 PROCEDURE OF RADIATED EMISSION TEST	10
7.5 TEST RESULT OF RADIATED EMISSION TEST	11
8. CONDUCTED EMISSION TEST	13
8.1 PROVISIONS APPLICABLE	13
8.2 MEASUREMENT PROCEDURE.....	13
8.3 TEST SETUP BLOCK DIAGRAM	14
8.4 TEST RESULT.....	15
9. ANTENNA CONDUCTED POWER FOR RECEIVERS.....	17
APPENDIX 1 PHOTOGRAPHS OF TEST SETUP	20
APPENDIX 2 PHOTOGRAPHS OF EUT	22

1. VERIFICATION OF COMPLIANCE

Applicant	Fujian Nanan Quansheng Electronics Co., Ltd.
Address	NO.82, Qiuzhong Industry Area, Xiamei Town, Nanan City, Fujian Province, China
Manufacturer	Fujian Nanan Quansheng Electronics Co., Ltd.
Address	NO.82, Qiuzhong Industry Area, Xiamei Town, Nanan City, Fujian Province, China
Product Designation	Two way radio
Brand name	Quansheng
Test Model	UV-R50
Hardware Version	UV-R50
Software Version	V3.0
Measurement Procedure	ANSI C63.4: 2014
Date of test:	Jul.05, 2017 to Jul.07, 2017
Deviation:	None
Condition of Test Sample	Normal

The above equipment was tested by Attestation Of Global Compliance (Shenzhen) Co., Ltd. for compliance with the requirements set forth in the FCC Rules and Regulations Part 15, the measurement procedure according to ANSI C63.4:2014. This said equipment in the configuration described in this report shows the maximum emission levels emanating from equipment are within the compliance requirements.

The test results of this report relate only to the tested sample identified in this report.

Tested by 
 Steven Zhou(Zhou Pengyun) Jul.07, 2017

Reviewed by 
 Bart Xie(Xie Xiaobin) Jul.07, 2017

Approved by 
 Solger Zhang(Zhang Hongyi)
 Authorized Officer Jul.07, 2017

2. PRODUCT INFORMATION

The EUT is a Analog Transceiver designed for voice communication. It is designed by way of utilizing the FM modulation achieves the system operating.

A major technical description of EUT is described as following:

Communication Type	Voice / Tone only
Modulation	FM
RX Frequency Range	RX:136-174 & 400-480MHz
Emission Type	F3E
Channel Separation	12.5KHz,25KHz
Antenna Designation	Detachable
Antenna Gain	2.15dBi
Power Supply	DC 7.2V 1450mAh
Charger Parameter	INPUT:AC85V~ 265V 50/60Hz ,0.3A OUTPUT:DC 12V , 0.5A

I/O Port Information (Applicable Not Applicable)

I/O Port of EUT			
I/O Port Type	Q'TY	Cable	Tested with
DC Input Port	1	0.88m, Unshielded	1
Antenna Connect Port	1	0	1

3. IDENTIFICATION OF THE RESPONSIBLE TESTING LOCATION

Site	Dongguan Precise Testing Service Co., Ltd.
Location	Building D, Baoding Technology Park,Guangming Road2, Dongcheng District, Dongguan, Guangdong, China.
Description	The test site is constructed and calibrated to meet the FCC requirements in documents TIA/EIA 603
FCC Registration No.	371540

List Of Test Equipment:

Radiated Emission Test Site					
Name of Equipment	Manufacturer	Model Number	Serial Number	Last Calibration	Due Calibration
EMI Test Receiver	Rohde & Schwarz	ESCI	101417	July 2, 2017	July 1, 2018
Trilog Broadband Antenna (25M-1GHz)	SCHWARZBECK	VULB9160	9160-3355	July 2, 2017	July 1, 2018
Signal Amplifier	SCHWARZBECK	BBV 9475	9745-0013	July 2, 2017	July 1, 2018
RF Cable	SCHWARZBECK	AK9515E	96221	July 2, 2017	July 1, 2018
3m Anechoic Chamber	CHENGYU	966	PTS-001	June 2, 2017	June 1, 2018
MULTI-DEVICE Positioning Controller	Max-Full	MF-7802	MF780208339	N/A	N/A
Active loop antenna (9K-30MHz)	Schwarzbeck	FMZB1519	1519-038	June 2, 2017	June 1, 2018
Spectrum analyzer	Agilent	E4407B	MY46185649	June 2, 2017	June 1, 2018
Power Sensor	Agilent	U2021XA	MY55050474	June 2, 2017	June 1, 2018
Horn Antenna (1G-18GHz)	SCHWARZBECK	BBHA9120D	9120D-1246	June 2, 2017	June 1, 2018
Horn Ant (18G-40GHz)	Schwarzbeck	BBHA 9170	9170-181	June 2, 2017	June 1, 2018

Conducted Emission Test Site					
Name of Equipment	Manufacturer	Model Number	Serial Number	Last Calibration	Due Calibration
EMI Test Receiver	Rohde & Schwarz	ESCI	101417	June 2, 2017	June 1, 2018
Artificial Mains Network	Narda	L2-16B	000WX31025	June 2, 2017	June 1, 2018
Artificial Mains Network (AUX)	Narda	L2-16B	000WX31026	June 2, 2017	June 1, 2018
RF Cable	SCHWARZBECK	AK9515E	96222	June 2, 2017	June 1, 2018
Shielded Room	CHENGYU	843	PTS-002	June 2, 2017	June 1, 2018

4. SUPPORT EQUIPMENT LIST

Device Type	Manufacturer	Model Name	Serial No.	Data Cable	Power Cable
--	--	--	--	--	--

5. SYSTEM DESCRIPTION

EUT test procedure:

1. Connect EUT and peripheral devices.
2. Power on the EUT, the EUT begins to work.
3. Running data transmission and make sure the EUT normal working.

EMC TEST MODES

No.	TEST MODES
1	Scanning mode + Receiving mode

Note: Only the result of the worst case was recorded in the report.

6. SUMMARY OF TEST RESULTS

FCC Rules	Description Of Test	Result
§15.107	Conduction Emission	Compliant
§15.109	Radiated Emission	Compliant
§15.111	Antenna Conducted Power for receivers	Compliant

7. FCC RADIATED EMISSION TEST

7.1. TEST EQUIPMENT OF RADIATED EMISSION

7.2. LIMITS OF RADIATED EMISSION TEST

Frequency (MHz)	Distance (m)	Maximum Field Strength Limit (dBuV/m/ Q.P.)
30~88	3	40.0
88~216	3	43.5
216~960	3	46.0
Above 960	3	54.0

**Note: The lower limit shall apply at the transition frequency.

7.3 BLOCK DIAGRAM OF RADIATED EMISSION TEST

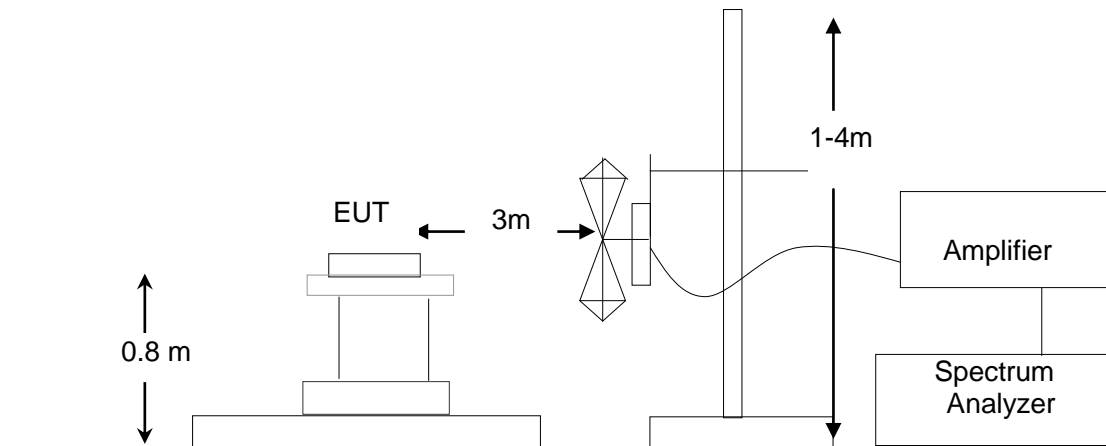

7.4 PROCEDURE OF RADIATED EMISSION TEST

- 1) The equipment was set up as per the test configuration to simulate typical actual usage per the user's manual. When the EUT is a tabletop system, a wooden turntable with a height of 0.8 meters is used which is placed on the ground plane as per ANSI C63.4 (see Test Facility for the dimensions of the ground plane used). When the EUT is floor-standing equipment, it is placed on the ground plane which has a 3-12 mm non-conductive covering to insulate the EUT from the ground plane.
- 2) Support equipment, if needed, was placed as per ANSI C63.4.
- 3) All I/O cables were positioned to simulate typical actual usage as per ANSI C63.4.
- 4) The EUT received power by AC 120V/60Hz.
- 5) The antenna was placed at 3 meter away from the EUT as stated in FCC Part 15. The antenna connected to the Analyzer via a cable and at times a pre-amplifier would be used.
- 6) The Analyzer / Receiver quickly scanned from 30MHz to 1000MHz. The EUT test program was started. Emissions were scanned and measured rotating the EUT to 360 degrees and positioning the antenna 1 to 4 meters above the ground plane, in both the vertical and the horizontal polarization, to maximize the emission reading level.
- 7) The test mode(s) were scanned during the test:
- 8) Recorded at least the six highest emissions. Emission frequency, amplitude, antenna position, polarization and turntable position were recorded into a computer in which correction factors were used to calculate the emission level and compare reading to the applicable limit and Q.P./Peak reading is presented.

The test data of the worst case condition (mode 1) was reported on the following Data page

7.5 TEST RESULT OF RADIATED EMISSION TEST

Radiated Emission Test –Horizontal -3m Below 1G

66.9 dBuV/m

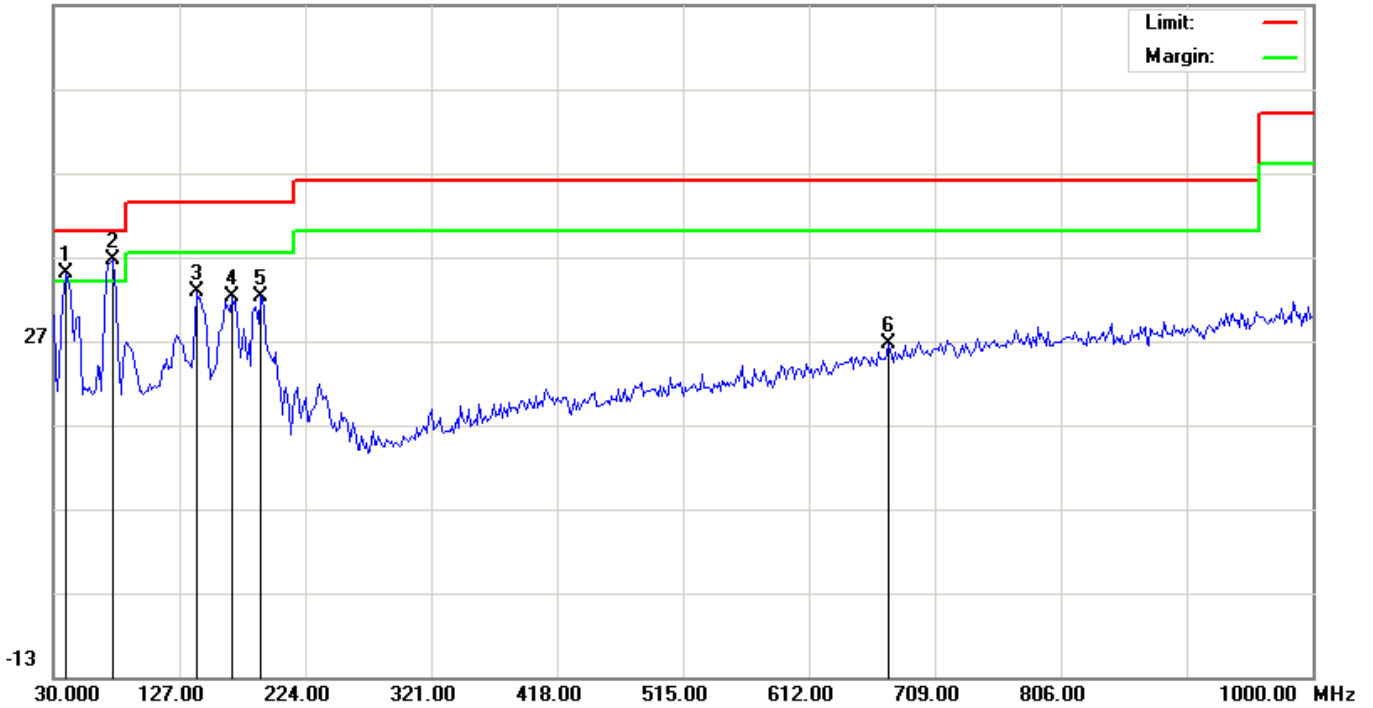

No.	Mk	Freq.	Reading	Factor	Measurement	Limit	Over	Detector	Antenna Height	Table Degree	Comment
		MHz	dBuV	dB/m	dBuV/m	dBuV/m	dB		cm	degree	
1	!	39.7000	19.77	15.30	35.07	40.00	-4.93	peak			
2	*	75.2667	24.76	11.78	36.54	40.00	-3.46	peak			
3		139.9333	17.13	15.61	32.74	43.50	-10.76	peak			
4		167.4167	16.12	16.05	32.17	43.50	-11.33	peak			
5		190.0500	18.64	13.66	32.30	43.50	-11.20	peak			
6		673.4333	1.18	25.46	26.64	46.00	-19.36	peak			

RESULT: PASS

Radiated Emission Test –Vertical -3m Below 1G

66.9 dBuV/m

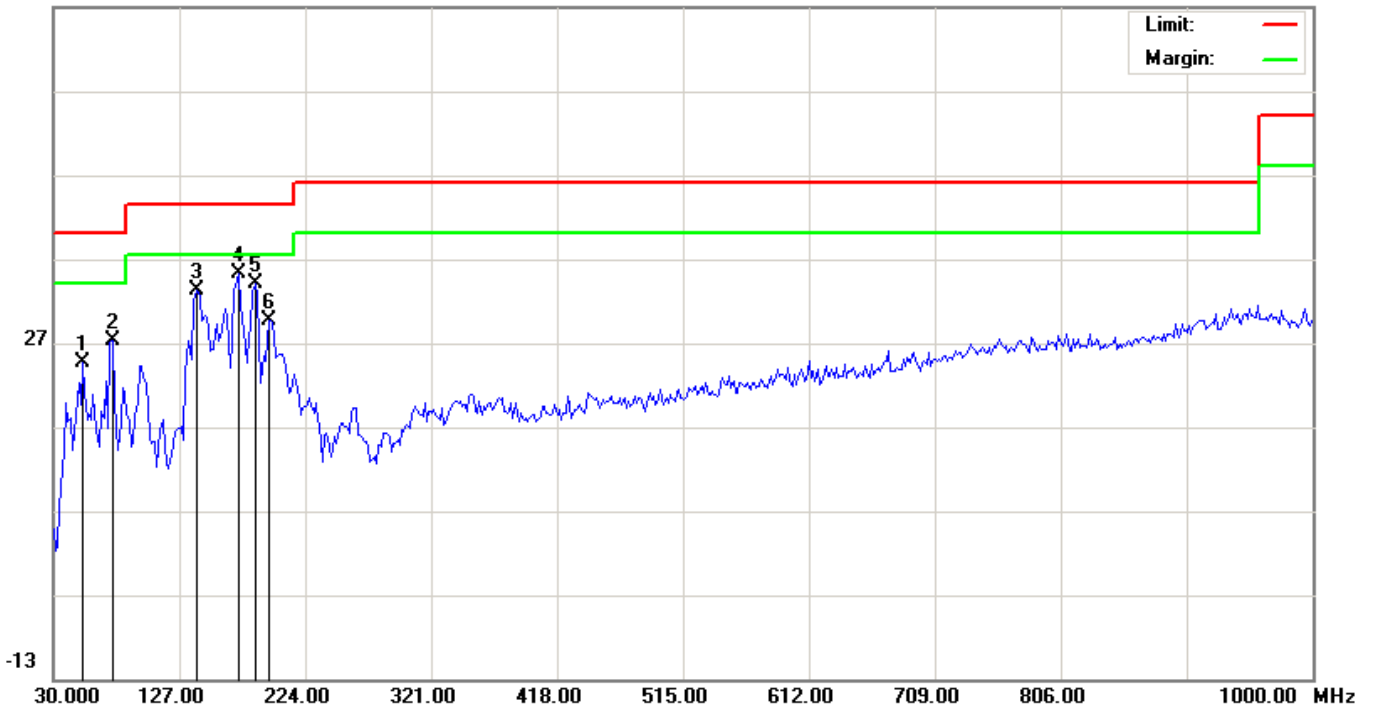

No.	Mk	Freq.	Reading	Factor	Measurement	Limit	Over	Detector	Antenna Height	Table Degree	Comment
		MHz	dBuV	dB/m	dBuV/m	dBuV/m	dB		cm	degree	
1		52.6333	16.27	8.41	24.68	40.00	-15.32	peak			
2		75.2667	22.05	5.12	27.17	40.00	-12.83	peak			
3		139.9333	18.08	15.17	33.25	43.50	-10.25	peak			
4	*	172.2667	24.36	10.78	35.14	43.50	-8.36	peak			
5		185.2000	22.71	11.31	34.02	43.50	-9.48	peak			
6		196.5167	17.83	11.84	29.67	43.50	-13.83	peak			

RESULT: PASS

- Note:** 1. Factor=Antenna Factor + Cable loss - Amplifier gain, Margin=Measurement-Limit.
 2. The "Factor" value can be calculated automatically by software of measurement system.
 3. Emissions range from 1GHz to 12.5GHz have 20dB margin. No recording in the test report.
 4. Only the data of the worst case would be record in this test report.

8. CONDUCTED EMISSION TEST

8.1 PROVISIONS APPLICABLE

For an intentional radiator that is designed to be connected to the public utility (AC) power line, the, the radio frequency voltage that is conducted back onto the AC power line on any frequencies within the band 150 KHz to 30 MHz shall not exceed the limits in the following table, as measured using a 50uH/50 ohms line impedance stabilization network (LISN). Compliance with the provisions of this paragraph shall be based on the measurement of the radio frequency voltage between each power line and ground at the power terminal. The lower limit applies at the boundary between the frequencies ranges.

Frequency of Emission (MHz)	Conducted Limit(dBuV)	
	Quasi-Peak	Average
0.15 – 0.5	66 to 56 *	56 to 46 *
0.5 – 5	56	46
5 – 30	60	50

* Decreases with the logarithm of the frequency.

8.2 MEASUREMENT PROCEDURE

- (1) The equipment was set up as per the test configuration to simulate typical actual usage per the user's manual. When the EUT is a tabletop system, a wooden table with a height of 0.8 meters is used and is placed on the ground plane as per ANSI C63.4 (see Test Facility for the dimensions of the ground plane used). When the EUT is a floor-standing equipment, it is placed on the ground plane which has a 3-12 mm non-conductive covering to insulate the EUT from the ground plane.
- (2) Support equipment, if needed, was placed as per ANSI C63.4.
- (3) All I/O cables were positioned to simulate typical actual usage as per ANSI C63.4.
- (4) The EUT received AC 120V/60Hz power through a Line Impedance Stabilization Network (LISN) which supplied power source and was grounded to the ground plane.
- (5) All support equipments received AC power from a second LISN, if any.
- (6) The EUT test program was started. Emissions were measured on each current carrying line of the EUT using a spectrum Analyzer / Receiver connected to the LISN powering the EUT. The LISN has two monitoring points: Line 1 (Hot Side) and Line 2 (Neutral Side). Two scans were taken: one with Line 1 connected to Analyzer / Receiver and Line 2 connected to a 50 ohm load; the second scan had Line 1 connected to a 50 ohm load and Line 2 connected to the Analyzer / Receiver.
- (7) Analyzer / Receiver scanned from 150 KHz to 30MHz for emissions in each of the test modes.

During the above scans, the emissions were maximized by cable manipulation.

8.3 TEST SETUP BLOCK DIAGRAM

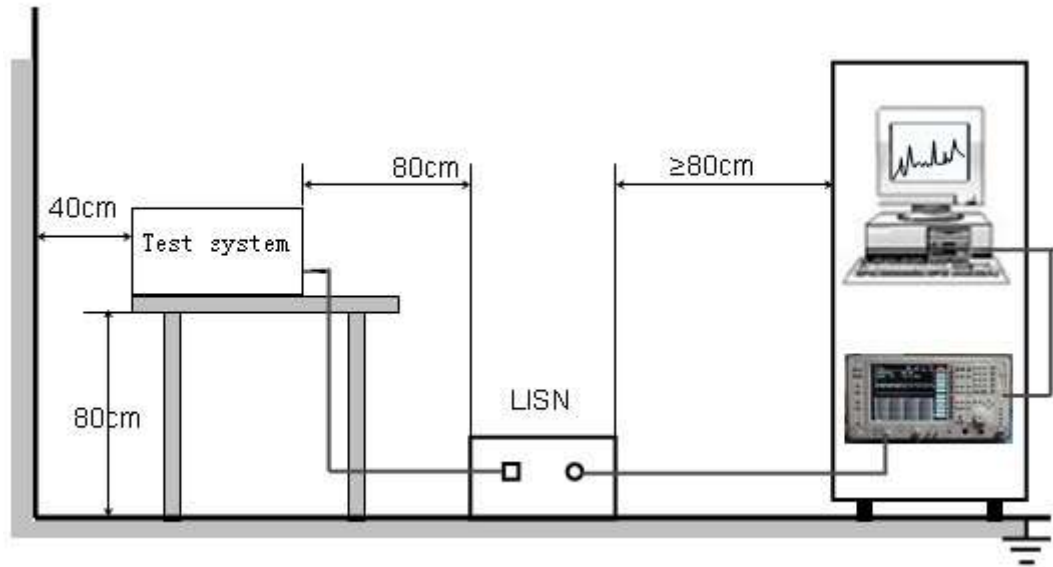

8.4 TEST RESULT

CONDUCTED EMISSION TEST – LINE L

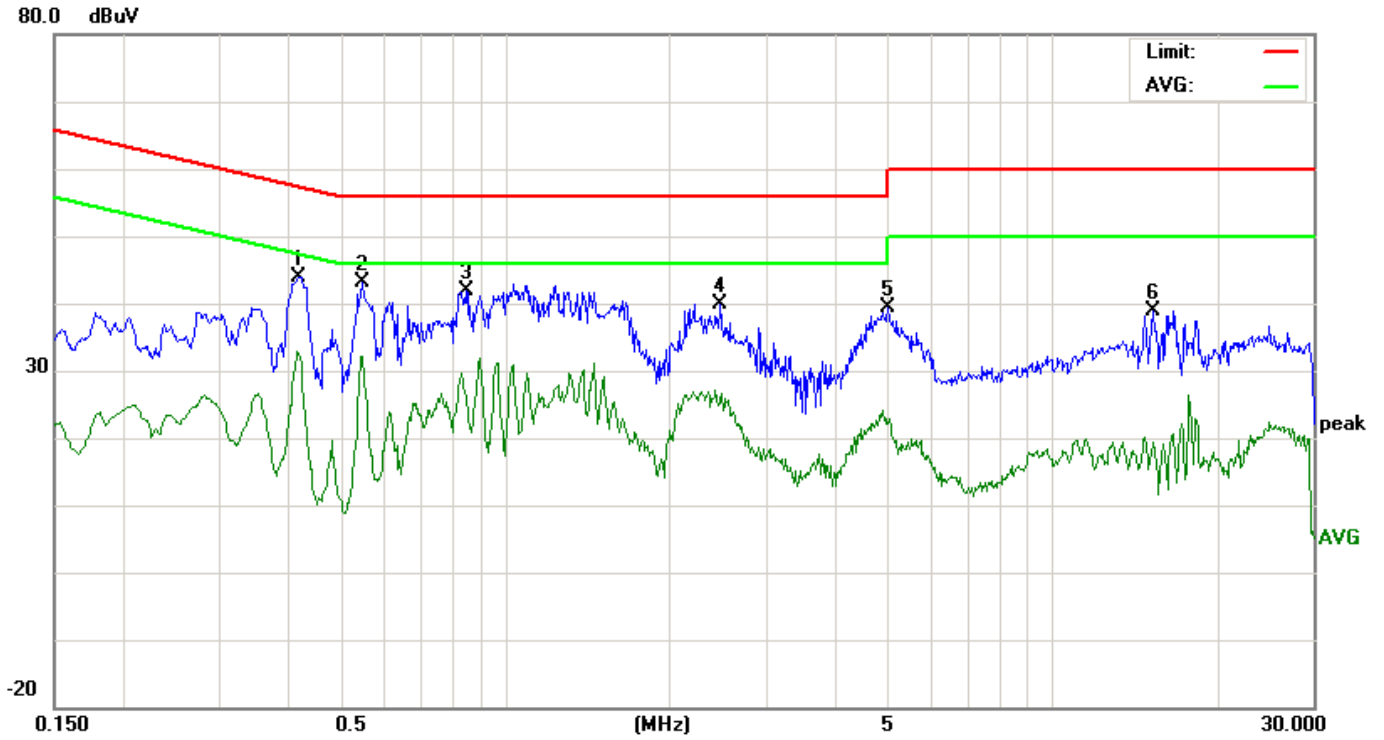

No.	Freq. (MHz)	Reading_Level (dBuV)			Correct Factor (dB)	Measurement (dBuV)			Limit (dBuV)		Margin (dB)		P/F	Comment
		Peak	QP	AVG		Peak	QP	AVG	QP	AVG	QP	AVG		
1	0.4193	33.55		22.30	10.34	43.89		32.64	57.46	47.46	-13.57	-14.82	P	
2	0.5500	32.77		21.87	10.35	43.12		32.22	56.00	46.00	-12.88	-13.78	P	
3	0.8499	31.48		16.09	10.34	41.82		26.43	56.00	46.00	-14.18	-19.57	P	
4	2.4860	29.50		15.47	10.42	39.92		25.89	56.00	46.00	-16.08	-20.11	P	
5	5.0179	29.24		11.98	10.24	39.48		22.22	60.00	50.00	-20.52	-27.78	P	
6	15.2858	28.75		8.84	10.12	38.87		18.96	60.00	50.00	-21.13	-31.04	P	

RESULT: PASS

CONDUCTED EMISSION TEST – LINE N

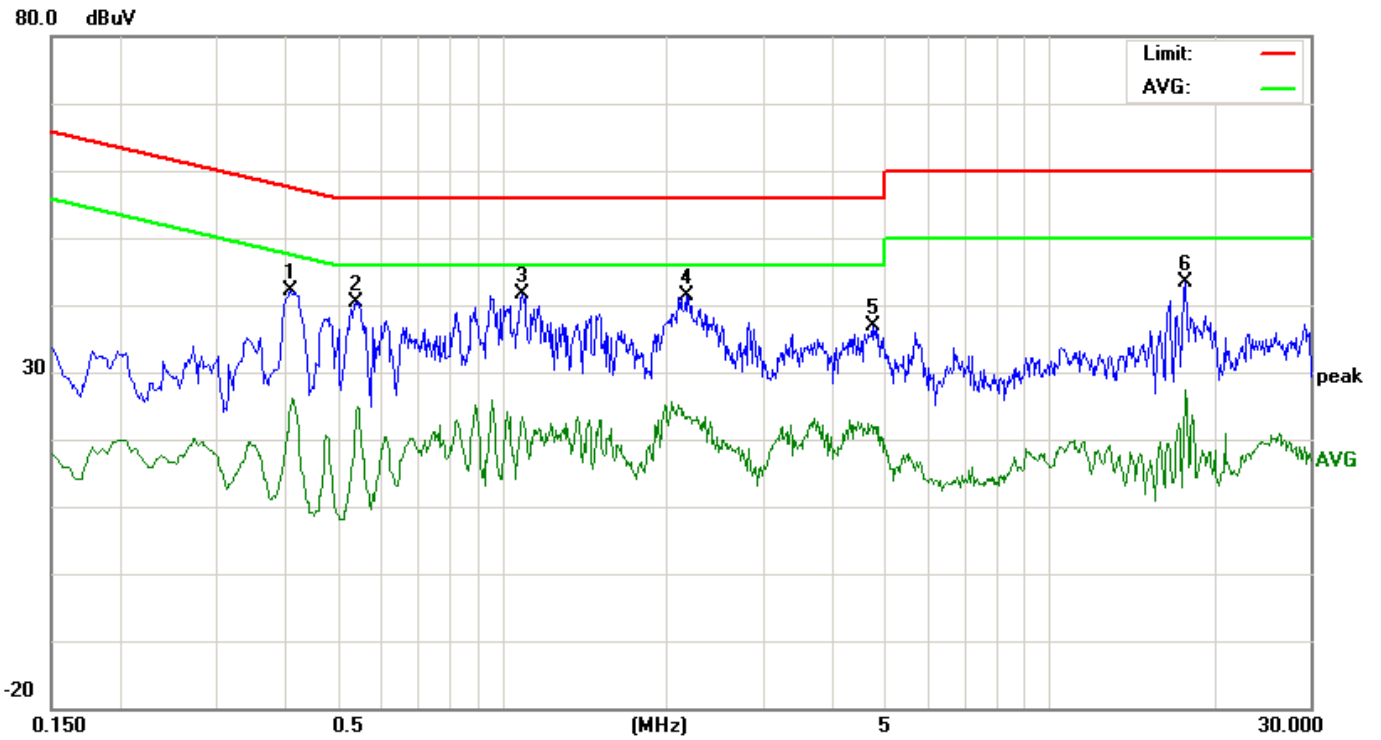

No.	Freq. (MHz)	Reading_Level (dBuV)			Correct Factor (dB)	Measurement (dBuV)			Limit (dBuV)		Margin (dB)		P/F	Comment
		Peak	QP	AVG		Peak	QP	AVG	QP	AVG	QP	AVG		
1	0.4103	31.79		14.10	10.34	42.13		24.44	57.64	47.64	-15.51	-23.20	P	
2	0.5420	30.11		13.78	10.36	40.47		24.14	56.00	46.00	-15.53	-21.86	P	
3	1.0900	31.30		12.95	10.37	41.67		23.32	56.00	46.00	-14.33	-22.68	P	
4	2.1779	31.08		12.94	10.29	41.37		23.23	56.00	46.00	-14.63	-22.77	P	
5	4.7618	26.75		11.75	10.23	36.98		21.98	56.00	46.00	-19.02	-24.02	P	
6	17.8018	33.35		17.17	10.12	43.47		27.29	60.00	50.00	-16.53	-22.71	P	

RESULT: PASS

9. ANTENNA CONDUCTED POWER FOR RECEIVERS

LIMIT

The antenna conducted power of the receiver as defined in §15.111 shall not exceed the values given in the following tables

Frequency Range	9 KHz to 2GHz
Limit	2.0 nW (-57 dBm)

TEST CONFIGURATION

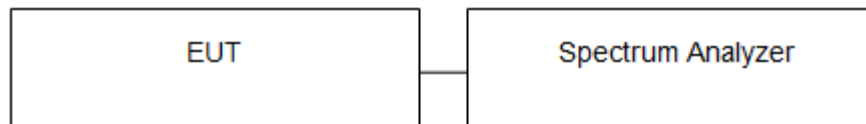

TEST PROCEDURE

1. The receiver antenna terminal connected to a spectrum analyzer.
2. The test data of the worst case condition (mode 1) was reported on the following Data page.

TEST RESULTS

Conducted Measurement (9 KHz to 150 KHz)

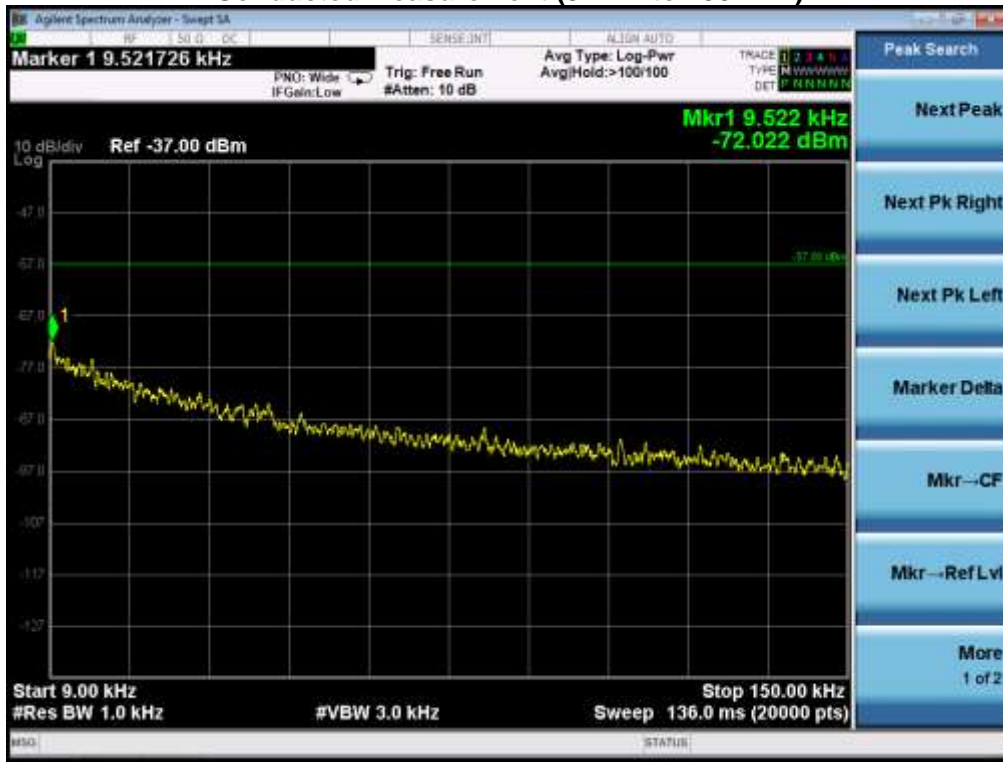

Conducted Measurement (150 KHz to 30MHz)

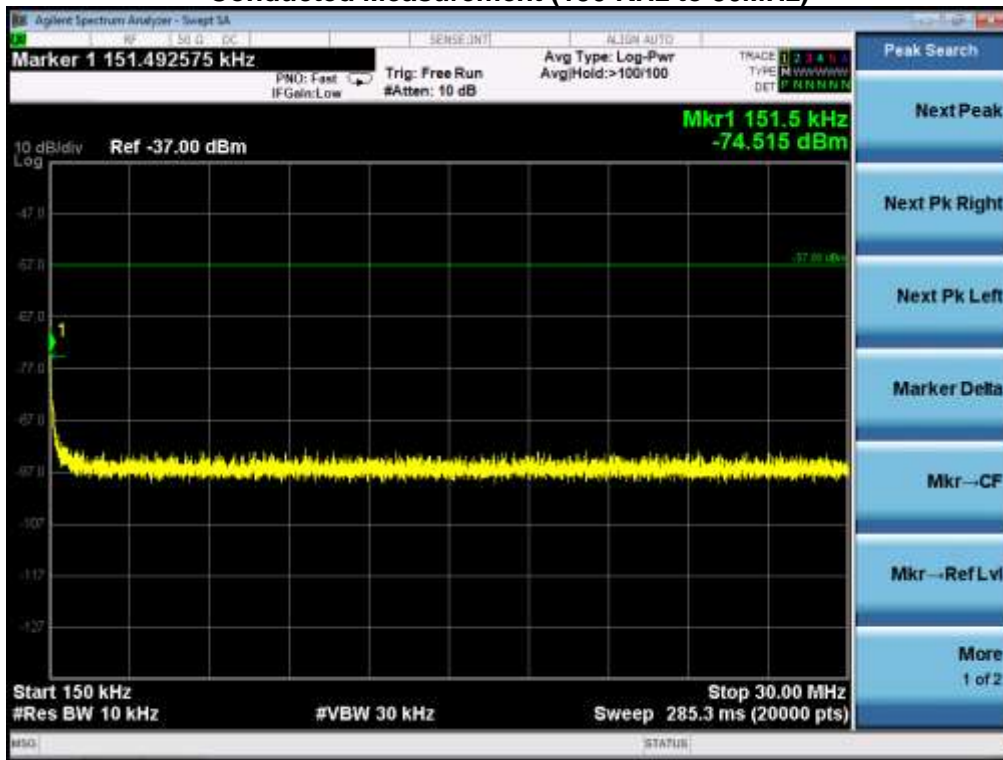

Conducted Measurement (30MHz to 1GHz)

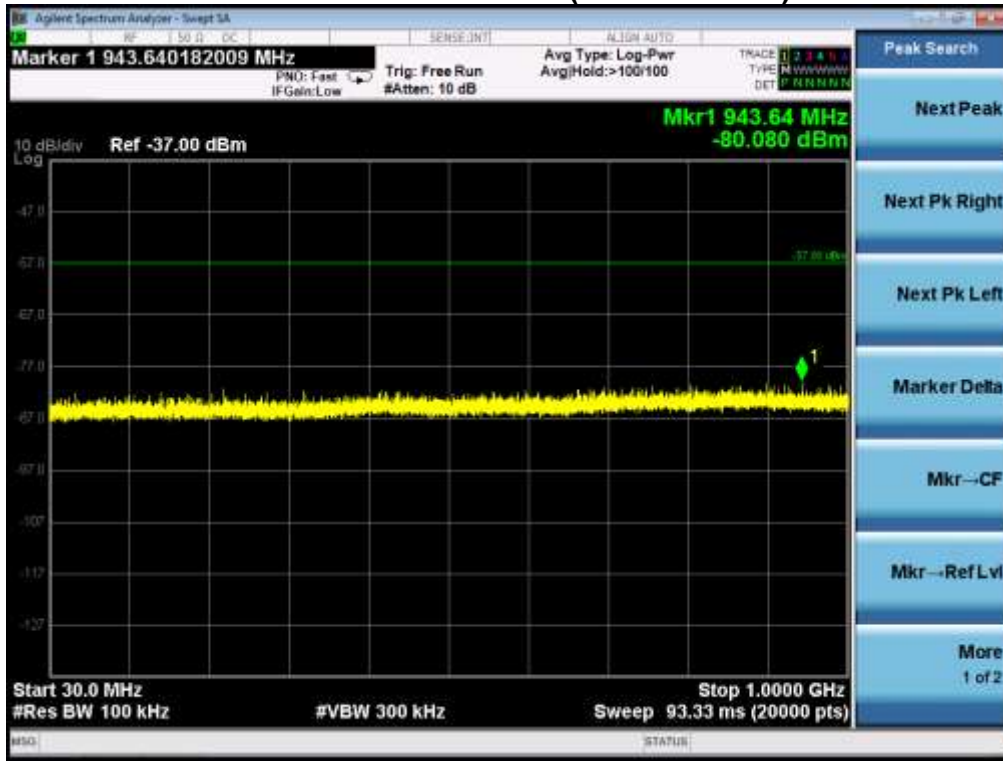

Conducted Measurement (1GHz to 2GHz)

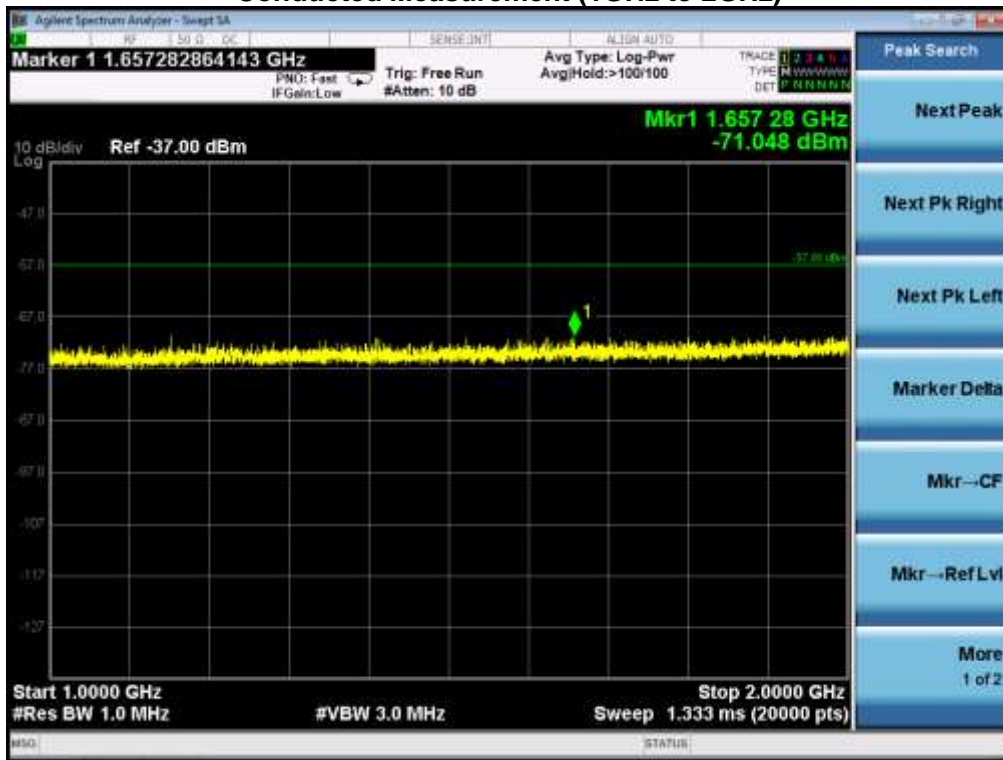

PASS

APPENDIX 1 PHOTOGRAPHS OF TEST SETUP
CONDUCTED EMISSION TEST SETUP



RADIATED EMISSION TEST SETUP

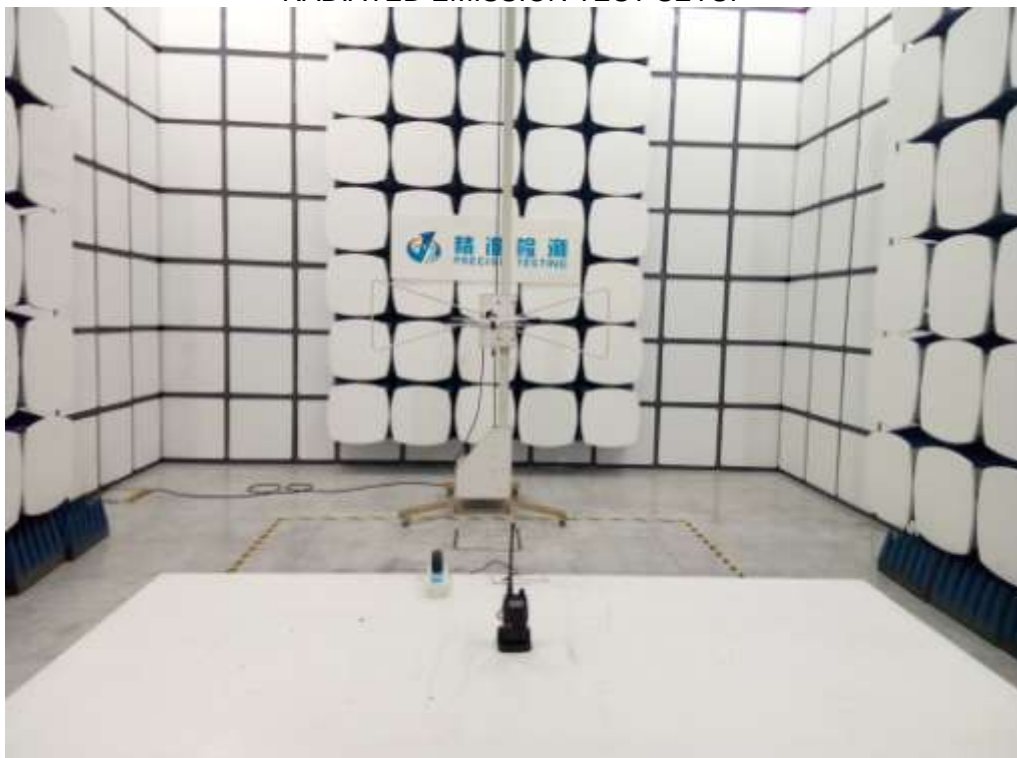

RADIATED EMISSION TEST SETUP

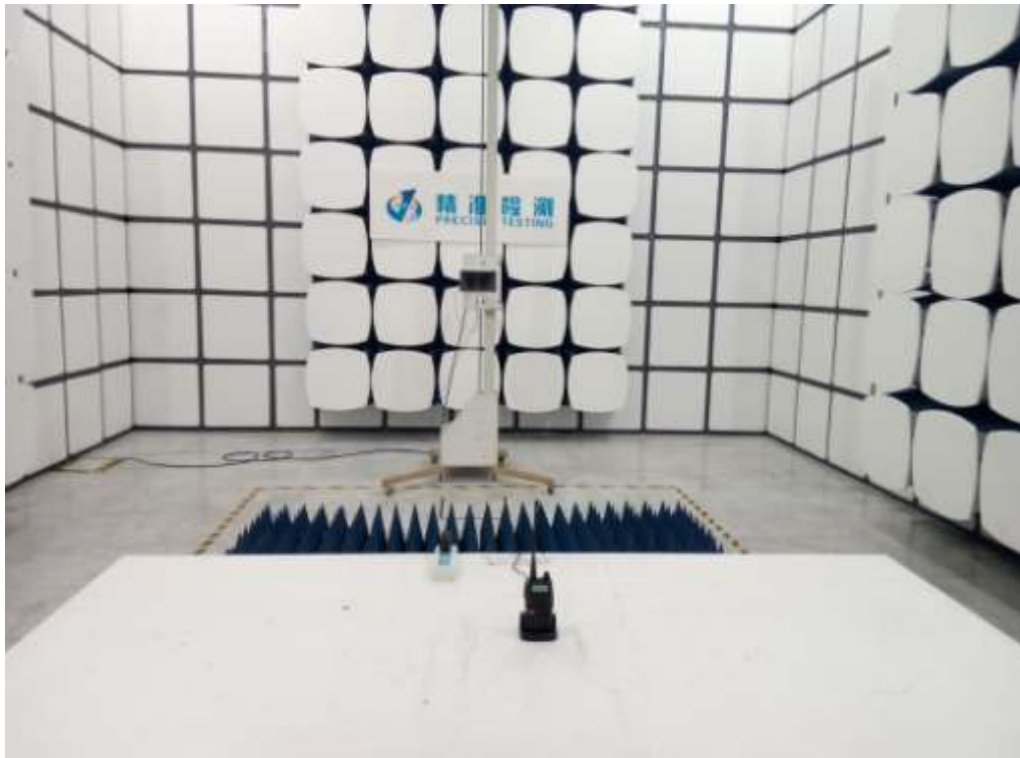

APPENDIX 2 PHOTOGRAPHS OF EUT

TOTAL VIEW OF EUT



TOP VIEW OF EUT



BOTTOM VIEW OF EUT



FRONT VIEW OF EUT



BACK VIEW OF EUT



LEFT VIEW OF EUT



RIGHT VIEW OF EUT



OPEN VIEW-1 OF EUT



OPEN VIEW-2 OF EUT



INTERNAL VIEW-1 OF EUT

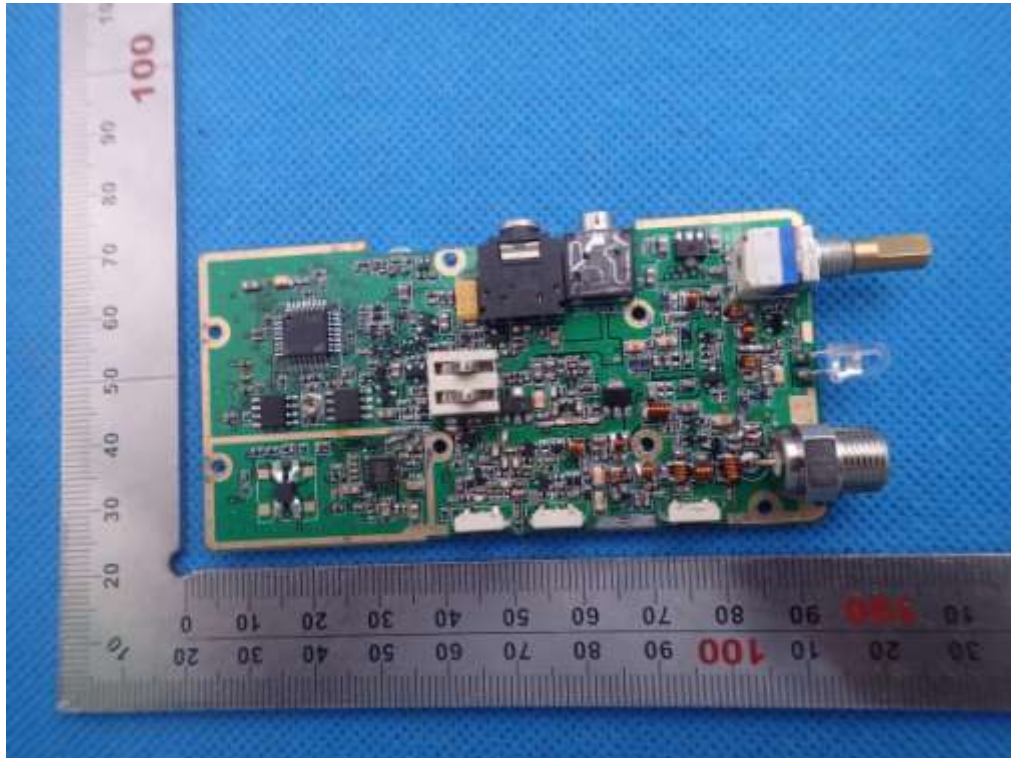

INTERNAL VIEW-2 OF EUT

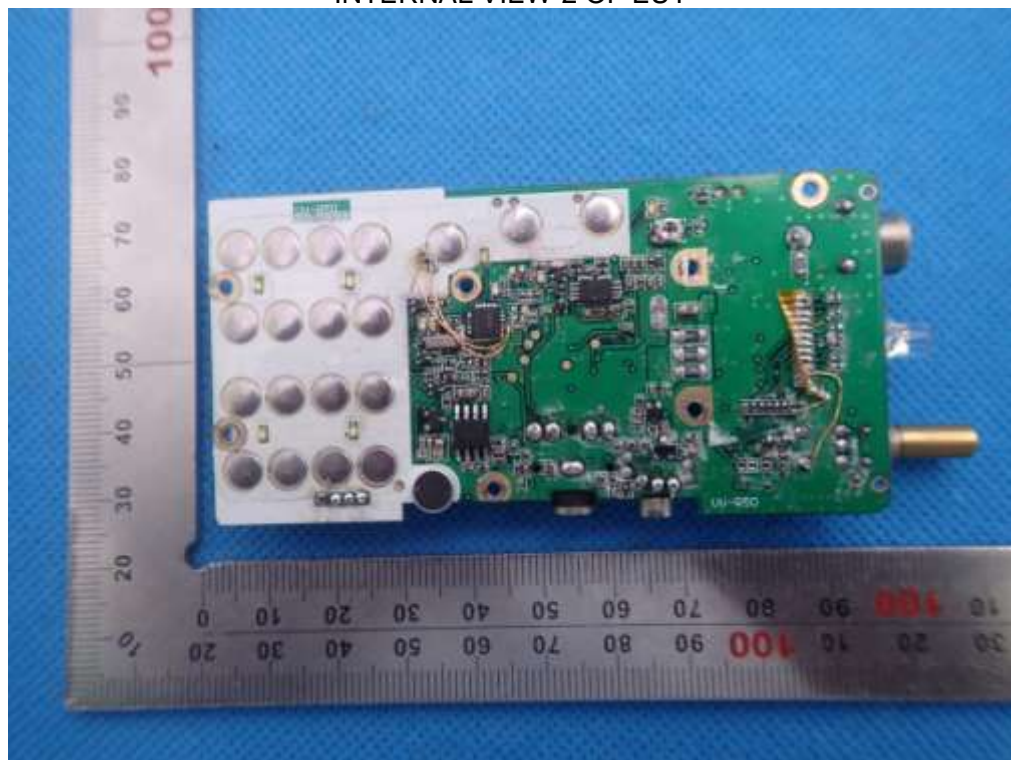

----END OF REPORT----