FCC Part 90 Rules Test Report

Report No.: AGC00933141201FE10

FCC ID : XBPTG-45UV
PRODUCT DESIGNATION : Two way radio
BRAND NAME : Quansheng
MODEL NAME : TG-45UV
CLIENT : Fujian Nanan Quansheng Electronics Co., Ltd.
DATE OF ISSUE : Dec.11, 2014
STANDARD(S) : FCC Part 90 Rules
REPORT VERSION : V 1.0

Attestation of *Global Compliance (Shenzhen) Co., Ltd*

CAUTION: This report shall not be reproduced except in full without the written permission of the test laboratory and shall not be quoted out of context.



Report Revise Record

Report Version	Revise Time	Issued Date	Valid Version	Notes
V1.0	/	Dec.11, 2014	Valid	Original Report

VERIFICATION OF COMPLIANCE

Applicant:	Fujian Nanan Quansheng Electronics Co,Ltd.
	NO.82 Qiuzhong Industry Area, Xiamei Town, Nanan City, Fujian Province, 362302 China
Manufacturer:	Fujian Nanan Quansheng Electronics Co, Ltd.
	NO.82 Qiuzhong Industry Area, Xiamei Town, Nanan City, Fujian Province, 362302 China
Product Designation:	Two way radio
Brand Name:	Quansheng
Test Model	TG-45UV
Date of Test:	Dec.05, 2014 to Dec.10, 2014

WE HEREBY CERTIFY THAT:

The above equipment was tested by Attestation of Global Compliance (Shenzhen) Co., Ltd. The data evaluation, test procedures, and equipment configurations shown in this report were made in accordance with the procedures given in ANSI C 63.4:2009. The sample tested as described in this report is in compliance with the FCC Rules Part 90 requirements

The test results of this report relate only to the tested sample identified in this report.



Tested by	 <hr/> Freddie Duan Dec.11, 2014
Checked By	 <hr/> Kidd Yang Dec.11, 2014
Authorized By	 <hr/> Solger Zhang Dec.11, 2014

TABLE OF CONTENTS

1. GENERAL INFORMATION.....	6
1.1 PRODUCT DESCRIPTION.....	6
1.2 RELATED SUBMITTAL(S) / GRANT (S).....	7
1.3 TEST METHODOLOGY.....	7
1.4 TEST FACILITY.....	7
1.5 SPECIAL ACCESSORIES.....	7
1.6 EQUIPMENT MODIFICATIONS.....	7
2. SYSTEM TEST CONFIGURATION	8
2.1 EUT CONFIGURATION.....	8
2.2 EUT EXERCISE.....	8
2.3 GENERAL TECHNICAL REQUIREMENTS.....	8
2.4 CONFIGURATION OF TESTED SYSTEM.....	9
2.5. SUMMARY OF TEST RESULTS.....	9
3. IDENTIFICATION OF THE RESPONSIBLE TESTING LOCATION.....	10
4. DESCRIPTION OF TEST MODES.....	11
5. CONDUCTED LIMITS.....	12
5.1 PROVISIONS APPLICABLE.....	12
5.2 MEASUREMENT PROCEDURE.....	12
5.3 TEST SETUP BLOCK DIAGRAM.....	13
5.4 TEST RESULT.....	14
6. FREQUENCY TOLERANCE.....	16
6.1 PROVISIONS APPLICABLE.....	16
6.2 MEASUREMENT PROCEDURE.....	16
6.3 TEST SETUP BLOCK DIAGRAM.....	17
6.4 TEST RESULT.....	18
7. EMISSION BANDWIDTH.....	24
7.1 PROVISIONS APPLICABLE.....	24
7.2 MEASUREMENT PROCEDURE.....	24
7.3 TEST SETUP BLOCK DIAGRAM.....	24
7.4 MEASUREMENT RESULT.....	25
8. UNWANTED RADIATION.....	27
8.1 PROVISIONS APPLICABLE.....	27
8.2 MEASUREMENT PROCEDURE.....	27
8.3 TEST SETUP BLOCK DIAGRAM.....	28

8.4 MEASUREMENT RESULTS: 30

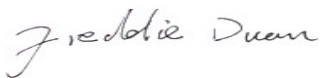
9. MODULATION CHARACTERISTICS..... 37

 9.1 PROVISIONS APPLICABLE 37

 9.2 MEASUREMENT METHOD 37

 9.3 MEASUREMENT RESULT 38

10. MAXIMUM TRANSMITTER POWER..... 44

 10.1 PROVISIONS APPLICABLE 44

 10.2 TEST PROCEDURE..... 44

 10.3 TEST CONFIGURATION..... 45

 10.4 TEST RESULT..... 47

 10.5 CONDUCT SPURIOUS PLOT..... 49

11. TRANSMITTER FREQUENCY BEHAVIOR..... 51

 11.1 PROVISIONS APPLICABLE 51

 11.2 TEST METHOD 51

 11.3 DESCRIBE LIMIT LINE OF TRANSMITTER FREQUENCY BEHAVIOR..... 52

 11.4 MEASURE RESULT 53

12. RADIATED EMISSION ON RECEIVING MODE..... 54

 12.1 PROVISIONS APPLICABLE 55

 12.2 TEST METHOD..... 55

 12.3 MEASURE RESULT (MEASURED AT 3M USING FCC PART15 B LIMITS)..... 56

13. AUDIO LOW PASS FILTER RESPONSE..... 60

 13.1 LIMITS 60

 13.2. METHOD OF MEASUREMENTS..... 60

 13.3 TEST DATA 61

APPENDIX I: PHOTOGRAPHS OF SETUP..... 63

APPENDIX II: EXTERNAL VIEW OF EUT..... 64

1. GENERAL INFORMATION

1.1 PRODUCT DESCRIPTION

The EUT is a **Two way radio** designed for voice communication. It is designed by way of utilizing the FM modulation achieves the system operating.

A major technical description of EUT is described as following:

Communication Type	Voice / Tone only	
Modulation	FM	
Emission Type	11KΦF3E	
Emission Bandwidth	6.188KHz(UHF), 6.184KHz(VHF)	
Peak Frequency Deviation	1.86KHz	
Audio Frequency Response	10.88dB	
Maximum Transmitter Power	36.93	
Output power Modification	5W (It was fixed by the manufacturer, any individual can't arbitrarily change it.)	
Antenna Designation	Detachable	
Power Supply	DC 7.2V,2500mAh (by battery)	
Adapter Parameter	Input: AC110V-240V, 50/60HZ Output: DC8.4V, 450mA	
Limiting Voltage	DC 6.12V-8.28V	
Operation Frequency Range and Channel	Frequency Range: 400MHz to 480MHz (UHF) & 136MHz~174MHz (VHF) Channel Separation: 12.5KHz	
	Bottom Channel: 400.025MHz Centre Channel: 440.000MHz Top Channel: 479.975MHz	Bottom Channel: 136.025MHz Centre Channel: 155.000MHz Top Channel: 173.975MHz
Frequency Tolerance	0.750ppm	

1.2 RELATED SUBMITTAL(S) / GRANT (S)

This submittal(s) (test report) is intended for **FCC ID: XBPTG-45UV**, filing to comply with the FCC Part 90 requirements.

1.3 TEST METHODOLOGY

The radiated emission testing was performed according to the procedures of ANSI C 63.4: 2009; TIA/EIA 603 and FCC CFR 47 Rules of 2.1046, 2.1047, 2.1049, 2.1051, 2.1053, 2.1055, 2.1057.

1.4 TEST FACILITY

The test site used to collect the radiated data is located on the address of Attestation of Global Compliance (Shenzhen) Co., Ltd. The test site is constructed and calibrated to meet the FCC requirements in documents ANSI C63.4: 2003 and IC requirements in documents RS212.

FCC register No.: 259865

1.5 SPECIAL ACCESSORIES

Not available for this EUT intended for grant.

1.6 EQUIPMENT MODIFICATIONS

Not available for this EUT intended for grant.

2. SYSTEM TEST CONFIGURATION

2.1 EUT CONFIGURATION

The EUT configuration for testing is installed on RF field strength measurement to meet the Commission's requirement and operating in a manner which intends to maximize its emission characteristics in a continuous normal application.

2.2 EUT EXERCISE

The Transmitter was operated in the normal operating mode. The TX frequency was fixed which was for the purpose of the measurements.

2.3 GENERAL TECHNICAL REQUIREMENTS

For FCC Part 90 requirements:

- (1). Section 90.205: Maximum ERP is dependent upon the station's antenna HAAT and required service area
- (2). Section 90.207: Modulation Characteristic
- (3). Section 90.209: Occupied Bandwidth
- (4). Section 90.210: Emission Mask
- (5). Section 90.213: Frequency Tolerance
- (6). Section 90.214: Transient Frequency Behavior

2.4 CONFIGURATION OF TESTED SYSTEM

Fig. 2-1 Configuration of Tested System



Table 2-1 Equipment Used in Tested System

Item	Equipment	Model No.	Identifier	Note
1	Two way radio	TG-45UV	FCC ID: XBPTG-45UV	EUT

2.5. SUMMARY OF TEST RESULTS

FCC Rules	Description Of Test	Result
§90.205	Maximum Transmitter Power	Compliant
§90.207	Modulation Characteristic	Compliant
§90.209	Occupied Bandwidth	Compliant
§90.210	Emission Mask	Compliant
§90.213	Frequency Tolerance	Compliant
§90.214	Transient Frequency Behavior	Compliant
§90.242	AUDIO LOW PASS FILTER RESPONSE	Compliant

3. IDENTIFICATION OF THE RESPONSIBLE TESTING LOCATION

Site	Attestation of Global Compliance (Shenzhen) Co., Ltd
Location 1	2/F., Building 2, No.1-No.4, Chaxi Sanwei Technical Industrial Park, Gushu, Xixiang, Bao'an District, Shenzhen, Guangdong, China
Location 2	B112-B113, Building 12, Baoan Building Materials Center, No.1 of Xixiang Inner Ring Road, Baoan District, Shenzhen, Guangdong, P.R.China

LIST OF EQUIPMENTS USED

NAME OF EQUIPMENT	MANUFACTURER	MODEL	SERIAL NUMBER	Cal. Date	Cal. Due
TEST RECEIVER	R&S	ESCI	N/A	07/25/2014	07/24/2015
LISN	R&S	ESH3-Z5	N/A	09/05/2014	09/04/2015
CLIMATE CHAMBER	EXPERY	TN-400	N/A	07/25/2014	07/24/2015
ATTENUATOR	WEINSCHTEL CORP	58-30-33	ML030	07/25/2014	07/24/2015
DC POWER SUPPLY	ZHAOXIN	RXN-605D	N/A	07/25/2014	07/24/2015
SPECTRUM ANALYZER	AGILENT	N9010A	MY53470504	10/21/2014	10/20/2015
MODULATION ANALYZER	HP	8920B	3104A03367	07/16/2014	07/15/2015
HEADPHONE LINE	AGC	N/A	N/A	N/A	N/A
HORN ANT	ETS	3117	00034609	08/17/2014	08/16/2015
BROADBAND ANT	SCHWARZBECK	VULB9168	D69250	08/17/2014	08/16/2015
Broadband Preamplifier	Schwarzbeck	BBV 9718	9718-62	07/30/2014	07/29/2015
Multi-Device Controller	EMCO	2090	N/A	07/30/2014	07/29/2015
HORN ANTENNA	A.H. SYSTEMS INC.	SAS-574	N/A	07/16/2014	07/15/2015
Biconilog Antenna	EMCO	3142C	N/A	08/17/2014	08/16/2015
SIGNAL GENERATOR	AGILENT	E4421B	122501288	07/25/2014	07/24/2015
SIGNAL GENERATOR	R&S	SMT03	A0304261	07/25/2014	07/24/2015
RF CABLE	SUIRONG	9KHZ-30MHZ	N/A	07/16/2014	07/15/2015
RF CABLE	SUIRONG	30MHZ-18GHZ	N/A	07/16/2014	07/15/2015

NOTE: 8920B can generate audio modulation frequency.

4. DESCRIPTION OF TEST MODES

RF TEST MODES

The EUT (Two way radio) has been tested under normal operating condition. (The top channel, the middle channel and the bottom channel) are chosen for testing at each channel separation.

No.	TEST MODES	CHANNEL SEPARATION
1	Low Channel	12.5 KHz
2	Middle Channel	12.5 KHz
3	High Channel	12.5 KHz

EMC TEST MODES

No.	TEST MODES
1	Standby Mode

Note: Only the result of the worst case was recorded in the report.

5. CONDUCTED LIMITS

5.1 PROVISIONS APPLICABLE

For an intentional radiator that is designed to be connected to the public utility (AC) power line, the, the radio frequency voltage that is conducted back onto the AC power line on any frequencies within the band 150 KHz to 30 MHz shall not exceed the limits in the following table, as measured using a 50uH/50 ohms line impedance stabilization network (LISN). Compliance with the provisions of this paragraph shall be based on the measurement of the radio frequency voltage between each power line and ground at the power terminal. The lower limit applies at the boundary between the frequencies ranges.

Frequency of Emission (MHz)	Conducted Limit(dBuV)	
	Quasi-Peak	Average
0.15 – 0.5	66 to 56 *	56 to 46 *
0.5 – 5	56	46
5 – 30	60	50

* Decreases with the logarithm of the frequency.

5.2 MEASUREMENT PROCEDURE

1. The equipment was set up as per the test configuration to simulate typical actual usage per the user's manual. When the EUT is a tabletop system, a wooden table with a height of 0.8 meters is used and is placed on the ground plane as per ANSI C63.4 (see Test Facility for the dimensions of the ground plane used). When the EUT is a floor-standing equipment, it is placed on the ground plane which has a 3-12 mm non-conductive covering to insulate the EUT from the ground plane.
2. Support equipment, if needed, was placed as per ANSI C63.4.
3. All I/O cables were positioned to simulate typical actual usage as per ANSI C63.4.
4. The EUT received power through a Line Impedance Stabilization Network (LISN) which supplied power source and was grounded to the ground plane.
5. All support equipments received AC power from a second LISN, if any.
6. The EUT test program was started. Emissions were measured on each current carrying line of the EUT using a spectrum Analyzer / Receiver connected to the LISN powering the EUT. The LISN has two monitoring points: Line 1 (Hot Side) and Line 2 (Neutral Side). Two scans were taken: one with Line 1 connected to Analyzer / Receiver and Line 2 connected to a 50 ohm load; the second scan had Line 1 connected to a 50 ohm load and Line 2 connected to the Analyzer / Receiver.
7. Analyzer / Receiver scanned from 150 KHz to 30MHz for emissions in each of the test modes. During the above scans, the emissions were maximized by cable manipulation.

5.3 TEST SETUP BLOCK DIAGRAM

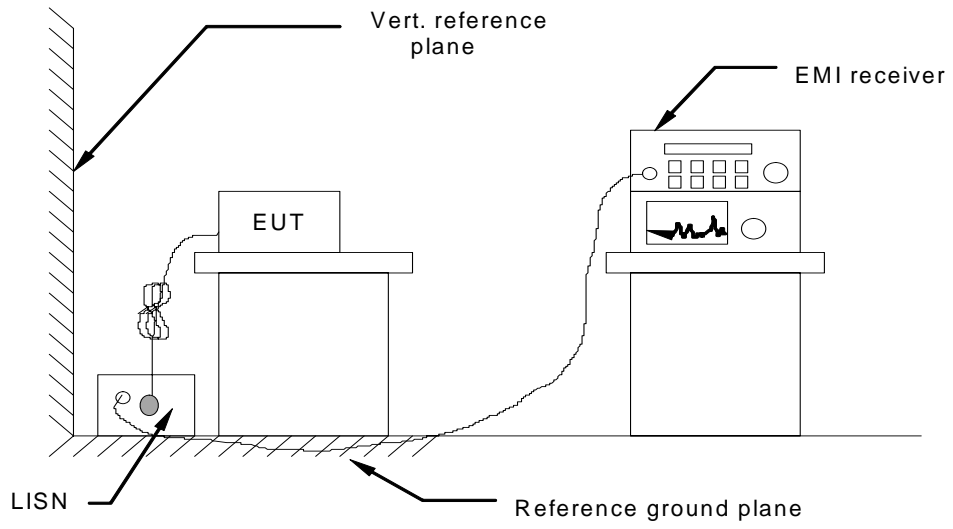

5.4 TEST RESULT

CONDUCTED EMISSION TEST – LINE L1

SCAN TABLE: "Voltage (150K-30M)"
Short Description: 9k-30M Voltage

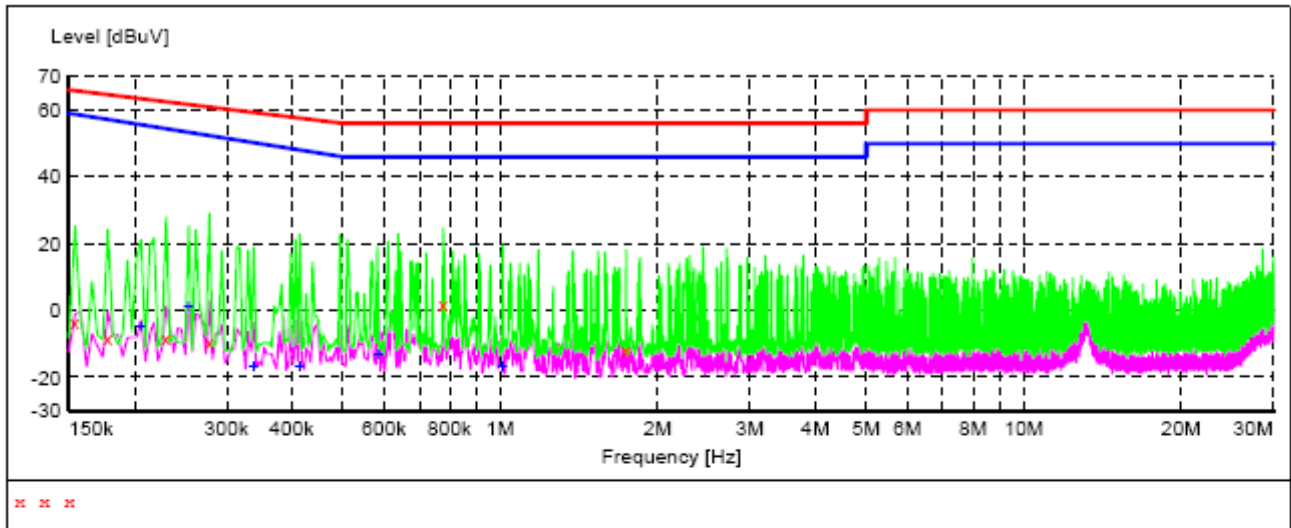

MEASUREMENT RESULT:

Frequency	Level	Transd	Limit	Margin	Detector	Line	PE	AUX STATE
MHz	dBuV	dB	dBuV	dB				
0.154000	-3.80	0.2	66	69.6	PK	L1	FLO	ON
0.178000	-8.10	0.2	65	72.7	PK	L1	FLO	ON
0.230000	-8.50	0.2	62	70.9	PK	L1	FLO	ON
0.278000	-9.30	0.2	61	70.2	PK	L1	FLO	ON
0.778000	1.90	0.2	56	54.1	PK	L1	FLO	ON
1.738000	-12.20	0.3	56	68.2	PK	L1	FLO	ON

MEASUREMENT RESULT:

Frequency	Level	Transd	Limit	Margin	Detector	Line	PE	AUX STATE
MHz	dBuV	dB	dBuV	dB				
0.206000	-4.70	0.2	56	60.3	AV	L1	FLO	ON
0.254000	1.20	0.2	53	52.1	AV	L1	FLO	ON
0.338000	-16.50	0.2	50	66.7	AV	L1	FLO	ON
0.414000	-16.60	0.2	48	64.6	AV	L1	FLO	ON
0.586000	-13.30	0.2	46	59.3	AV	L1	FLO	ON
1.010000	-17.00	0.2	46	63.0	AV	L1	FLO	ON

CONDUCTED EMISSION TEST – LINE N

SCAN TABLE: "Voltage (150K-30M)"
Short Description: 9k-30M Voltage

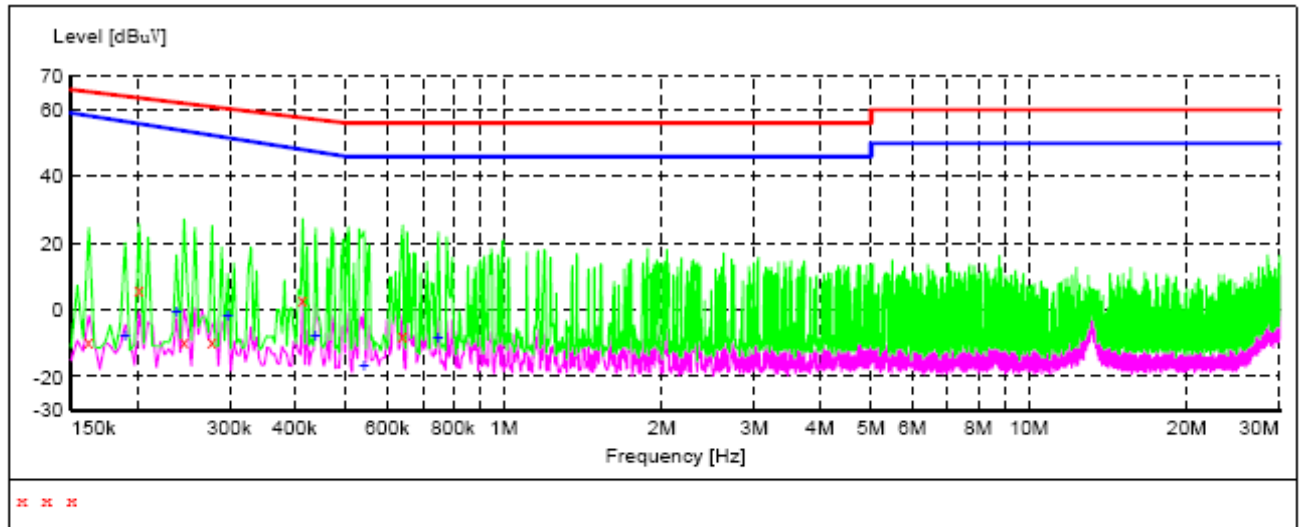

MEASUREMENT RESULT:

Frequency	Level	Transd	Limit	Margin	Detector	Line	PE	AUX STATE
MHz	dBuV	dB	dBuV	dB				
0.162000	-9.20	0.2	65	74.6	PK	N	FLO	ON
0.202000	6.20	0.2	64	57.3	PK	N	FLO	ON
0.246000	-9.40	0.2	62	71.3	PK	N	FLO	ON
0.278000	-9.50	0.2	61	70.4	PK	N	FLO	ON
0.414000	3.10	0.2	58	54.5	PK	N	FLO	ON
0.642000	-7.70	0.2	56	63.7	PK	N	FLO	ON

MEASUREMENT RESULT:

Frequency	Level	Transd	Limit	Margin	Detector	Line	PE	AUX STATE
MHz	dBuV	dB	dBuV	dB				
0.190000	-7.90	0.2	56	64.3	AV	N	FLO	ON
0.238000	-0.40	0.2	54	54.4	AV	N	FLO	ON
0.298000	-1.60	0.2	52	53.2	AV	N	FLO	ON
0.438000	-7.90	0.2	47	55.3	AV	N	FLO	ON
0.542000	-16.40	0.2	46	62.4	AV	N	FLO	ON
0.750000	-8.50	0.2	46	54.5	AV	N	FLO	ON

6. FREQUENCY TOLERANCE

6.1 PROVISIONS APPLICABLE

- a). According to FCC Part 2 Section 2.1055(a)(1), the frequency stability shall be measured with variation of ambient temperature from -30°C to $+50^{\circ}\text{C}$ centigrade.
- b). According to FCC Part 2 Section 2.1055(d)(2), for battery powered equipment, the frequency stability shall be measured with reducing primary supply voltage to the battery operating end point, which is specified by the manufacturer.
- c). According to FCC Part 90 Section 90.213, the frequency tolerance must be maintained within 0.00025% for 12.5 KHz channel separation and 0.0001% for 6.25 KHz channel separation.
- d). According to RSS-119 Section 119.5.3, the frequency tolerance must be maintained within 0.00025% for 12.5 KHz channel separation and 0.0005% for 25KHz channel separation.

6.2 MEASUREMENT PROCEDURE

6.2.1 Frequency stability versus environmental temperature

1. Setup the configuration per figure 1 for frequencies measurement inside an environment chamber, Install new battery in the EUT.
2. Turn on EUT and set SA center frequency to the EUT radiated frequency. Set SA Resolution Bandwidth to 1KHz and Video Resolution Bandwidth to 1KHz and Frequency Span to 50KHz. Record this frequency as reference frequency.
3. Set the temperature of chamber to 50°C . Allow sufficient time (approximately 30 min) for the temperature of the chamber to stabilize. While maintaining a constant temperature inside the chamber, turn the EUT on and measure the EUT operating frequency.
4. Repeat step 2 with a 10°C decreased per stage until the lowest temperature -30°C is measured, record all measured frequencies on each temperature step.

6.2.2 Frequency stability versus input voltage

1. Setup the configuration per figure 1 for frequencies measured at temperature if it is within 15°C to 25°C . Otherwise, an environment chamber set for a temperature of 20°C shall be used. The EUT shall be powered by DC 7.2V.
2. Set SA center frequency to the EUT radiated frequency. Set SA Resolution Bandwidth to 1 KHz and Video Resolution Bandwidth to 1KHz. Record this frequency as reference frequency.
3. Supply the EUT primary voltage at the operating end point which is specified by manufacturer and record the frequency.

6.3 TEST SETUP BLOCK DIAGRAM

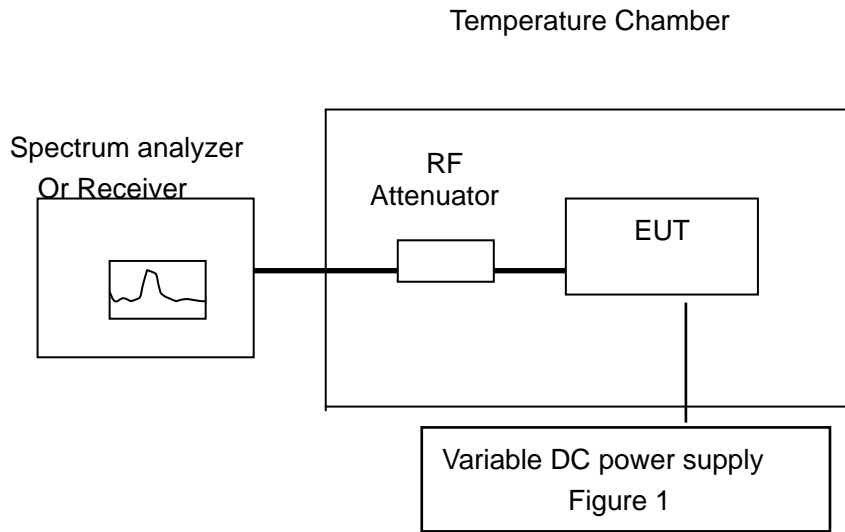

6.4 TEST RESULT

Frequency bands: UHF

(1) Frequency stability versus input voltage (Supply nominal voltage is 7.2V)

Bottom Channel @ 12.5 KHz Channel Separation

Reference Frequency:	400.025 MHz	Limit:	2.5ppm
Environment Temperature	Power Supply	Frequency Deviation	
(°C)	(V)	(MHz)	ppm
50	DC 7.20 V	400.025075	0.187
40	DC 7.20 V	400.025067	0.167
30	DC 7.20 V	400.025055	0.137
20	DC 7.20 V	400.025089	0.222
10	DC 7.20 V	400.025087	0.217
0	DC 7.20 V	400.025096	0.240
-10	DC 7.20 V	400.025077	0.192
-20	DC 7.20 V	400.025086	0.215
-30	DC 7.20 V	400.025095	0.237

Middle Channel @ 12.5 KHz Channel Separation

Reference Frequency:	440.000 MHz	Limit:	2.5ppm
Environment Temperature	Power Supply	Frequency Deviation	
(°C)	(V)	(MHz)	ppm
50	DC 7.20 V	440.000075	0.170
40	DC 7.20 V	440.000062	0.141
30	DC 7.20 V	440.000054	0.123
20	DC 7.20 V	440.000087	0.198
10	DC 7.20 V	440.000079	0.180
0	DC 7.20 V	440.000056	0.127
-10	DC 7.20 V	440.000062	0.141
-20	DC 7.20 V	440.000071	0.161
-30	DC 7.20 V	440.000095	0.216

Top Channel @ 12.5 KHz Channel Separation

Reference Frequency:	479.975 MHz	Limit:	2.5ppm
Environment Temperature	Power Supply	Frequency Deviation	
(°C)	(V)	(MHz)	ppm
50	DC 7.20 V	479.975089	0.185
40	DC 7.20 V	479.975067	0.140
30	DC 7.20 V	479.975055	0.115
20	DC 7.20 V	479.975075	0.156
10	DC 7.20 V	479.975065	0.135
0	DC 7.20 V	479.975052	0.108
-10	DC 7.20 V	479.975075	0.156
-20	DC 7.20 V	479.975087	0.181
-30	DC 7.20 V	479.975095	0.198

Frequency bands: VHF

Bottom Channel @ 12.5 KHz Channel Separation

Reference Frequency:	136.025 MHz	Limit:	5.0ppm
Environment Temperature	Power Supply	Frequency Deviation	
(°C)	(V)	(MHz)	ppm
50	DC 7.20 V	136.025075	0.551
40	DC 7.20 V	136.025068	0.500
30	DC 7.20 V	136.025053	0.390
20	DC 7.20 V	136.025032	0.235
10	DC 7.20 V	136.025057	0.419
0	DC 7.20 V	136.025066	0.485
-10	DC 7.20 V	136.025075	0.551
-20	DC 7.20 V	136.025088	0.647
-30	DC 7.20 V	136.025096	0.706

Middle Channel @ 12.5 KHz Channel Separation

Reference Frequency:	155.000 MHz	Limit:	5.0ppm
Environment Temperature	Power Supply	Frequency Deviation	
(°C)	(V)	(MHz)	ppm
50	DC 7.20 V	155.000073	0.471
40	DC 7.20 V	155.000067	0.432
30	DC 7.20 V	155.000054	0.348
20	DC 7.20 V	155.000033	0.213
10	DC 7.20 V	155.000045	0.290
0	DC 7.20 V	155.000056	0.361
-10	DC 7.20 V	155.000062	0.400
-20	DC 7.20 V	155.000078	0.503
-30	DC 7.20 V	155.000093	0.600

Top Channel @ 12.5 KHz Channel Separation

Reference Frequency:	173.975 MHz	Limit:	5.0ppm
Environment Temperature	Power Supply	Frequency Deviation	
(°C)	(V)	(MHz)	ppm
50	DC 7.20 V	173.975087	0.500
40	DC 7.20 V	173.975061	0.351
30	DC 7.20 V	173.975059	0.339
20	DC 7.20 V	173.975035	0.201
10	DC 7.20 V	173.975047	0.270
0	DC 7.20 V	173.975051	0.293
-10	DC 7.20 V	173.975072	0.414
-20	DC 7.20 V	173.975083	0.477
-30	DC 7.20 V	173.975091	0.523

Frequency bands: UHF

(2) Frequency stability versus input voltage (Battery limiting voltage is 6.12V)

Bottom Channel @ 12.5 KHz Channel Separation

Reference Frequency:	400.025 MHz	Limit:	2.5ppm
Environment Temperature	Power Supply	Frequency Deviation	
(°C)	(V)	(MHz)	ppm
50	DC 6.12 V	400.025085	0.212
40	DC 6.12 V	400.025073	0.182
30	DC 6.12 V	400.025051	0.127
20	DC 6.12 V	400.025049	0.122
10	DC 6.12 V	400.025062	0.155
0	DC 6.12 V	400.025074	0.185
-10	DC 6.12 V	400.025087	0.217
-20	DC 6.12 V	400.025096	0.240
-30	DC 6.12 V	400.025109	0.272

Middle Channel @ 12.5 KHz Channel Separation

Reference Frequency:	440.000 MHz	Limit:	2.5ppm
Environment Temperature	Power Supply	Frequency Deviation	
(°C)	(V)	(MHz)	ppm
50	DC 6.12 V	440.000085	0.193
40	DC 6.12 V	440.000073	0.166
30	DC 6.12 V	440.000067	0.152
20	DC 6.12 V	440.000046	0.105
10	DC 6.12 V	440.000065	0.148
0	DC 6.12 V	440.000077	0.175
-10	DC 6.12 V	440.000086	0.195
-20	DC 6.12 V	440.000092	0.209
-30	DC 6.12 V	440.000108	0.245

Top Channel @ 12.5 KHz Channel Separation

Reference Frequency:	479.975 MHz	Limit:	2.5ppm
Environment Temperature	Power Supply	Frequency Deviation	
(°C)	(V)	(MHz)	ppm
50	DC 6.12 V	479.975083	0.173
40	DC 6.12 V	479.975072	0.150
30	DC 6.12 V	479.975065	0.135
20	DC 6.12 V	479.975047	0.098
10	DC 6.12 V	479.975064	0.133
0	DC 6.12 V	479.975074	0.154
-10	DC 6.12 V	479.975082	0.171
-20	DC 6.12 V	479.975097	0.202
-30	DC 6.12 V	479.975109	0.227

Frequency bands: VHF

Bottom Channel @ 12.5 KHz Channel Separation

Reference Frequency:	136.025 MHz	Limit:	5.0ppm
Environment Temperature	Power Supply	Frequency Deviation	
(°C)	(V)	(MHz)	ppm
50	DC 6.12 V	136.025089	0.654
40	DC 6.12 V	136.025077	0.566
30	DC 6.12 V	136.025058	0.426
20	DC 6.12 V	136.025044	0.323
10	DC 6.12 V	136.025063	0.463
0	DC 6.12 V	136.025076	0.559
-10	DC 6.12 V	136.025083	0.610
-20	DC 6.12 V	136.025095	0.698
-30	DC 6.12 V	136.025102	0.750

Middle Channel @ 12.5 KHz Channel Separation

Reference Frequency:	155.000 MHz	Limit:	5.0ppm
Environment Temperature	Power Supply	Frequency Deviation	
(°C)	(V)	(MHz)	ppm
50	DC 6.12 V	155.000083	0.535
40	DC 6.12 V	155.000072	0.465
30	DC 6.12 V	155.000062	0.400
20	DC 6.12 V	155.000045	0.290
10	DC 6.12 V	155.000066	0.426
0	DC 6.12 V	155.000077	0.497
-10	DC 6.12 V	155.000081	0.523
-20	DC 6.12 V	155.000096	0.619
-30	DC 6.12 V	155.000104	0.671

Top Channel @ 12.5 KHz Channel Separation

Reference Frequency:	173.975 MHz	Limit:	5.0ppm
Environment Temperature	Power Supply	Frequency Deviation	
(°C)	(V)	(MHz)	ppm
50	DC 6.12 V	173.975063	0.362
40	DC 6.12 V	173.975073	0.420
30	DC 6.12 V	173.975062	0.356
20	DC 6.12 V	173.975041	0.236
10	DC 6.12 V	173.975064	0.368
0	DC 6.12 V	173.975072	0.414
-10	DC 6.12 V	173.975084	0.483
-20	DC 6.12 V	173.975097	0.558
-30	DC 6.12 V	173.975105	0.604

Frequency bands: UHF

(3) Frequency stability versus input voltage (Battery Fully Charged voltage is 8.28V)

Bottom Channel @ 12.5 KHz Channel Separation

Reference Frequency:	400.025 MHz	Limit:	2.5ppm
Environment Temperature	Power Supply	Frequency Deviation	
(°C)	(V)	(MHz)	ppm
50	DC 8.28 V	400.025085	0.212
40	DC 8.28 V	400.025073	0.182
30	DC 8.28 V	400.025056	0.140
20	DC 8.28 V	400.025044	0.110
10	DC 8.28 V	400.025063	0.157
0	DC 8.28 V	400.025072	0.180
-10	DC 8.28 V	400.025084	0.210
-20	DC 8.28 V	400.025091	0.227
-30	DC 8.28 V	400.025102	0.255

Middle Channel @ 12.5 KHz Channel Separation

Reference Frequency:	440.000 MHz	Limit:	2.5ppm
Environment Temperature	Power Supply	Frequency Deviation	
(°C)	(V)	(MHz)	ppm
50	DC 8.28 V	440.000085	0.193
40	DC 8.28 V	440.000077	0.175
30	DC 8.28 V	440.000066	0.150
20	DC 8.28 V	440.000042	0.095
10	DC 8.28 V	440.000065	0.148
0	DC 8.28 V	440.000077	0.175
-10	DC 8.28 V	440.000085	0.193
-20	DC 8.28 V	440.000099	0.225
-30	DC 8.28 V	440.000108	0.245

Top Channel @ 12.5 KHz Channel Separation

Reference Frequency:	479.975 MHz	Limit:	2.5ppm
Environment Temperature	Power Supply	Frequency Deviation	
(°C)	(V)	(MHz)	ppm
50	DC 8.28 V	479.975082	0.171
40	DC 8.28 V	479.975077	0.160
30	DC 8.28 V	479.975061	0.127
20	DC 8.28 V	479.975042	0.088
10	DC 8.28 V	479.975061	0.127
0	DC 8.28 V	479.975073	0.152
-10	DC 8.28 V	479.975087	0.181
-20	DC 8.28 V	479.975093	0.194
-30	DC 8.28 V	479.975106	0.221

Frequency bands: VHF

Bottom Channel @ 12.5 KHz Channel Separation

Reference Frequency:	136.025 MHz	Limit:	5.0ppm
Environment Temperature	Power Supply	Frequency Deviation	
(°C)	(V)	(MHz)	ppm
50	DC 8.28 V	136.025082	0.603
40	DC 8.28 V	136.025075	0.551
30	DC 8.28 V	136.025054	0.397
20	DC 8.28 V	136.025044	0.323
10	DC 8.28 V	136.025065	0.478
0	DC 8.28 V	136.025073	0.537
-10	DC 8.28 V	136.025081	0.595
-20	DC 8.28 V	136.025095	0.698
-30	DC 8.28 V	136.025102	0.750

Middle Channel @ 12.5 KHz Channel Separation

Reference Frequency:	155.000 MHz	Limit:	5.0ppm
Environment Temperature	Power Supply	Frequency Deviation	
(°C)	(V)	(MHz)	ppm
50	DC 8.28 V	155.000086	0.555
40	DC 8.28 V	155.000073	0.471
30	DC 8.28 V	155.000067	0.432
20	DC 8.28 V	155.000043	0.277
10	DC 8.28 V	155.000065	0.419
0	DC 8.28 V	155.000074	0.477
-10	DC 8.28 V	155.000087	0.561
-20	DC 8.28 V	155.000094	0.606
-30	DC 8.28 V	155.000102	0.658

Top Channel @ 12.5 KHz Channel Separation

Reference Frequency:	173.975 MHz	Limit:	5.0ppm
Environment Temperature	Power Supply	Frequency Deviation	
(°C)	(V)	(MHz)	ppm
50	DC 8.28 V	173.975088	0.506
40	DC 8.28 V	173.975073	0.420
30	DC 8.28 V	173.975064	0.368
20	DC 8.28 V	173.975045	0.259
10	DC 8.28 V	173.975062	0.356
0	DC 8.28 V	173.975077	0.443
-10	DC 8.28 V	173.975082	0.471
-20	DC 8.28 V	173.975095	0.546
-30	DC 8.28 V	173.975108	0.621

7. EMISSION BANDWIDTH

7.1 PROVISIONS APPLICABLE

According to FCC Part 90 Section 90.209: The authorized bandwidth shall be 11.25 KHz for 12.5 KHz channel separation.

According to RSS-119 Section 119.5.5: The authorized bandwidth shall be 11.25 KHz for 12.5 KHz

7.2 MEASUREMENT PROCEDURE

- 1). The EUT was placed on a turntable which is 0.8m above ground plane.
- 2). The EUT was modulated by 2.5 KHz Sine wave audio signal, The level of the audio signal employed is 16 dB greater than that necessary to produce 50% of rated system deviation. Rated system deviation is 2.5 kHz (12.5 kHz channel spacing).
- 3). Set SPA Center Frequency = fundamental frequency, RBW= 100Hz, VBW= 300Hz, Span =50 KHz.
- 4). Set SPA Max hold. Mark peak, -26 dB.

7.3 TEST SETUP BLOCK DIAGRAM

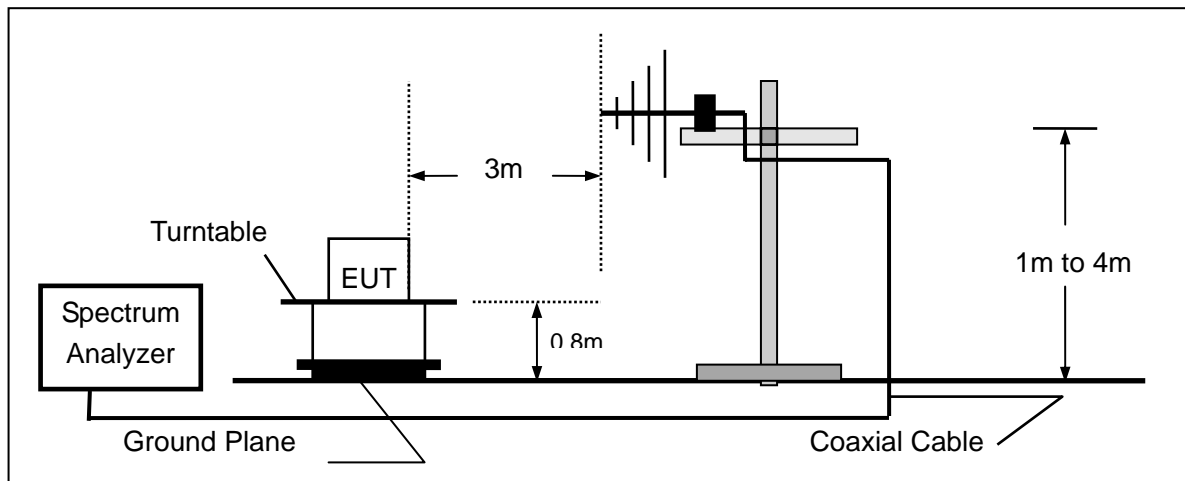

7.4 MEASUREMENT RESULT

26 DB BANDWIDTH MEASUREMENT RESULT			
Operating Frequency	12.5 KHz Channel Separation		
	Test Data	Limits	Result
136.025MHz	6.184KHz	11.25 KHz	Pass
155.000MHz	6.180KHz	11.25 KHz	Pass
173.975MHz	6.179KHz	11.25 KHz	Pass

Occupied bandwidth of Low Channel (Maximum)-VHF

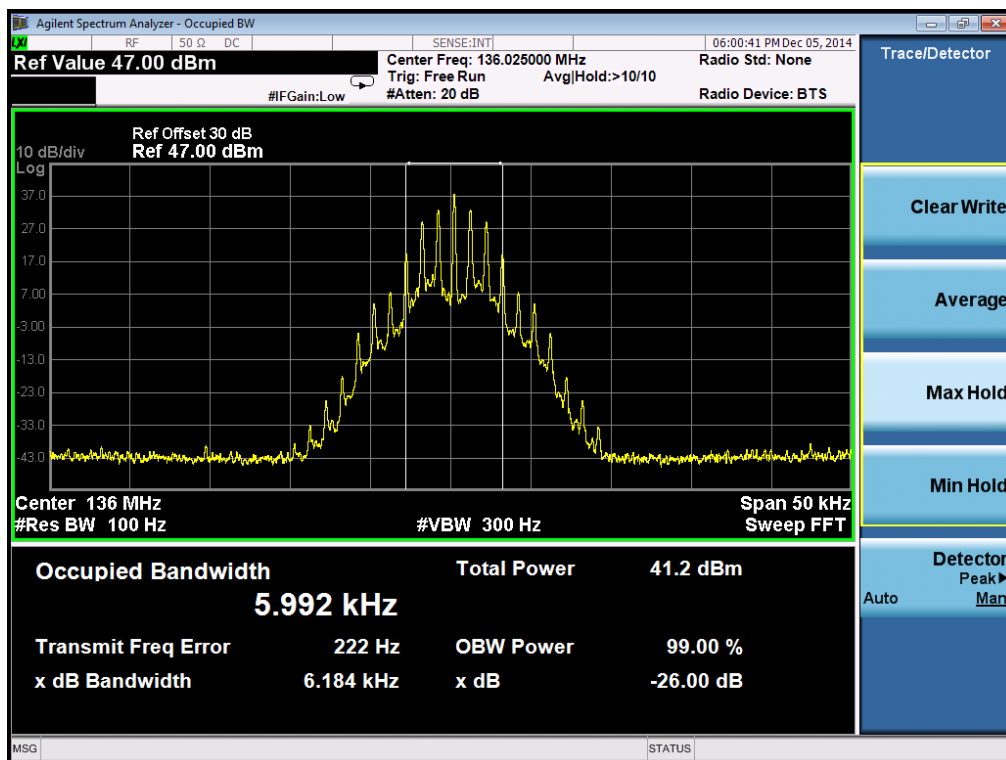

26 DB BANDWIDTH MEASUREMENT RESULT			
Operating Frequency	12.5 KHz Channel Separation		
	Test Data	Limits	Result
400.025MHz	6.188KHz	11.25 KHz	Pass
440.000MHz	6.185KHz	11.25 KHz	Pass
479.975MHz	6.183KHz	11.25 KHz	Pass

Occupied bandwidth of Low Channel (Maximum)-UHF

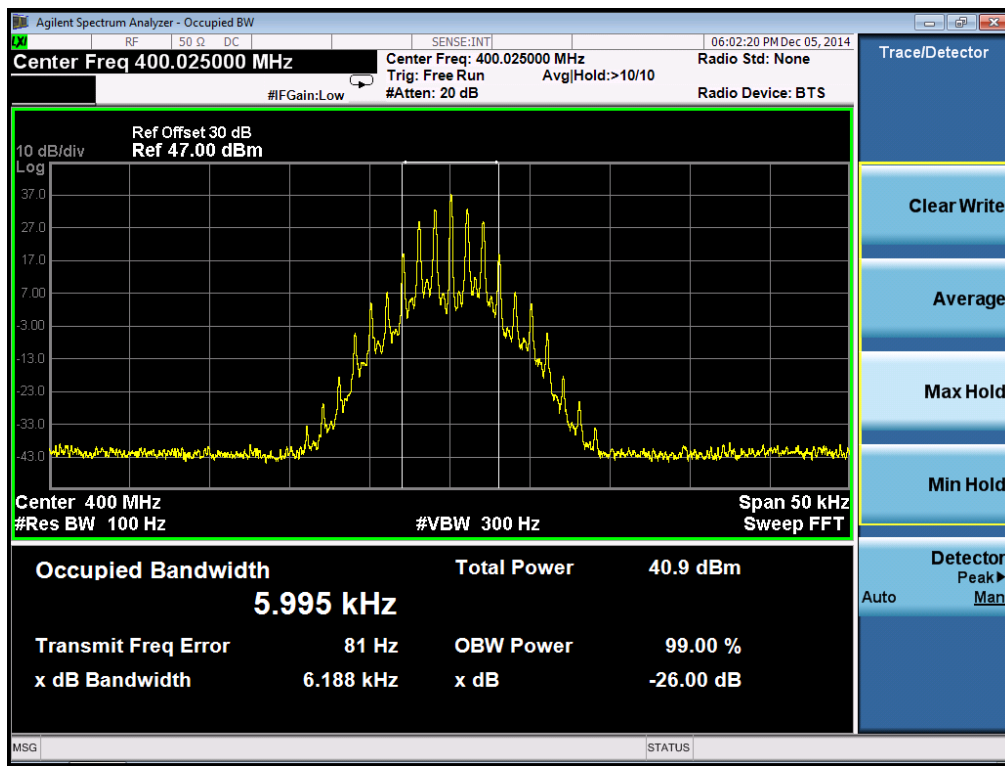

8. UNWANTED RADIATION

8.1 PROVISIONS APPLICABLE

8.1.1 According to Section 90.210, the power of each unwanted emission shall be less than Transmitted Power as specified below for transmitters designed to operate with each channel separation.

According to RSS-119 Section 119.5.8, the power of each unwanted emission shall be less than Transmitted Power as specified below for transmitters with each channel separation.

For 12.5 KHz Channel Separation:

- (1). On any frequency removed from the center of the authorized bandwidth f_0 to 5.625 KHz removed from f_0 : Zero dB.
- (2). On any frequency removed from the center of the authorized bandwidth by a displacement Frequency (f_d in KHz) f_0 of more than 5.625 KHz but no more than 12.5 KHz: At least $7.27(f_d - 2.88 \text{ KHz})$ dB
- (3). On any frequency removed from the center of the authorized bandwidth by a displacement Frequency (f_d in KHz) f_0 of more than 12.5 KHz: At least $50 + 10 \log(P)$ dB or 70 dB, whichever is lesser attenuation.

8.2 MEASUREMENT PROCEDURE

- (1) On a test site, the EUT shall be placed on a turntable, and in the position closest to the normal use as declared by the user.
- (2) The test antenna shall be oriented initially for vertical polarization located 3m from the EUT to correspond to the transmitter.
- (3) The output of the antenna shall be connected to the measuring receiver and either a peak or quasi-peak detector was used for the measurement as indicated on the report. The detector selection is based on how close the emission level was approaching the limit.
- (4) The transmitter shall be switched on; if possible, without the modulation and the measurement receiver shall be tuned to the frequency of the transmitter under test.
- (5) The test antenna shall be raised and lowered through the specified range of height until the measuring receiver detects a maximum signal level.
- (6) The transmitter shall then be rotated through 360° in the horizontal plane, until the maximum signal level is detected by the measuring receiver.
- (7) The test antenna shall be raised and lowered again through the specified range of height until the measuring receiver detects a maximum signal level.

- (8) The maximum signal level detected by the measuring receiver shall be noted.
- (9) The measurement shall be repeated with the test antenna set to horizontal polarization.
- (10) Replace the antenna with a proper Antenna (substitution antenna).
- (11) The substitution antenna shall be oriented for vertical polarization and, if necessary, the length of the substitution antenna shall be adjusted to correspond to the frequency of transmitting.
- (12) The substitution antenna shall be connected to a calibrated signal generator.
- (13) If necessary, the input attenuator setting of the measuring receiver shall be adjusted in order to increase the sensitivity of the measuring receiver.

(14)The test antenna shall be raised and lowered through the specified range of the height to ensure that the maximum signal is received.

(15)The input signal to substitution antenna shall be adjusted to the level that produces a level detected by the measuring receiver, that is equal to the level noted while the transmitter radiated power was measured, corrected for the change of input attenuation setting of the measuring receiver.

(16)The input level to the substitution antenna shall be recorded as power level in dBm, corrected for any change of input attenuator setting of the measuring receiver.

(17)The measurement shall be repeated with the test antenna and the substitution antenna oriented for horizontal polarization.

8.3 TEST SETUP BLOCK DIAGRAM

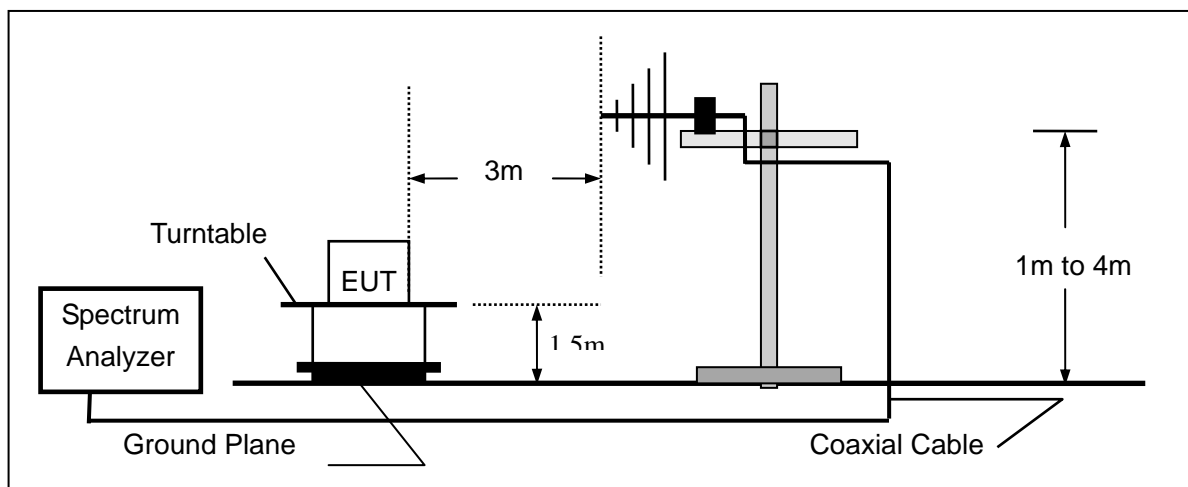

SUBSTITUTION METHOD: (Radiated Emissions)

Radiated Below 1GHz

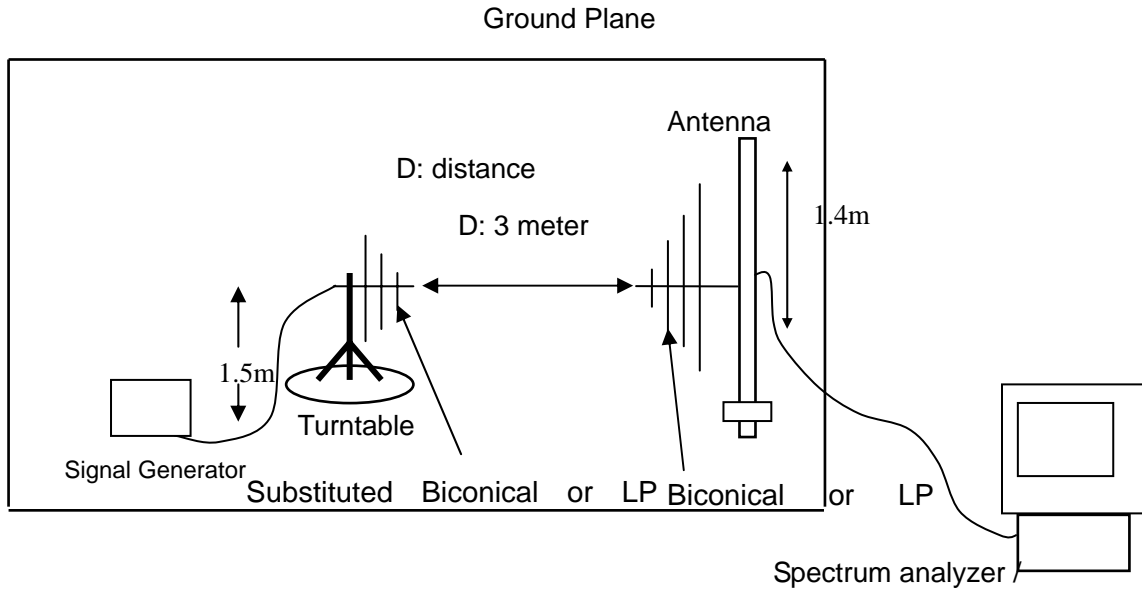

Radiated Above 1 GHz

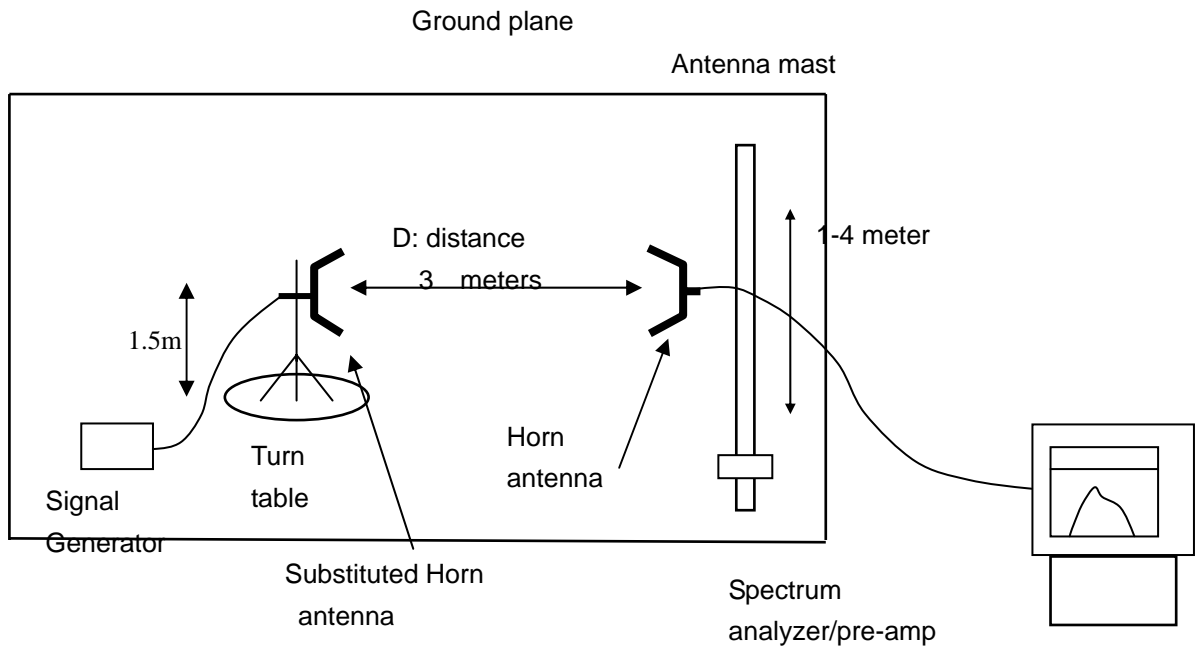

8.4 MEASUREMENT RESULTS:

Measurement Result for 12.5 KHz Channel Separation

On any frequency removed from the center of the authorized bandwidth by a displacement

Frequency (f_d in KHz) for of more than 12.5 KHz: at least $50+10 \log(P)$ dB or 70 dB, whichever is lesser attenuation.

At least $50+10 \log (P) =50+10\log (5) =57$ (dB)

Measurement Result for 12.5 KHz Channel Separation @ 400.025MHz

Emission Frequency (MHz)	Ant. Polarity(H/V)	Measurement Result Below carrier(dBc)	Limit below carrier(dBc)	Result(P/F)
400.025	V	0		pass
800.050	V	69.26	57	pass
1200.075	V	70.16	57	pass
1600.100	V	70.34	57	pass
2000.125	V	72.53	57	pass
2400.150	V	74.11	57	pass
2800.175	V	75.14	57	pass
3200.200	V	77.55	57	pass
3600.225	V	79.83	57	pass
4000.250	V	81.37	57	pass

Emission Frequency (MHz)	Ant. Polarity(H/H)	Measurement Result Below carrier(dBc)	Limit below carrier(dBc)	Result(P/F)
400.025	H	0		pass
800.050	H	69.35(-32.33dBm)	57	pass
1200.08	H	70.11	57	pass
1600.100	H	70.32	57	pass
2000.125	H	72.22	57	pass
2400.150	H	74.04	57	pass
2800.175	H	75.83	57	pass
3200.200	H	77.55	57	pass
3600.225	H	79.81	57	pass
4000.250	H	81.32	57	pass

Measurement Result for 12.5 KHz Channel Separation @ 440.000MHz

Emission Frequency (MHz)	Ant. Polarity(H/V)	Measurement Result Below carrier(dBc)	Limit below carrier(dBc)	Result(P/F)
440.000	V	0		pass
880.000	V	68.33	57	pass
1320.000	V	69.65	57	pass
1760.000	V	72.64	57	pass
2200.000	V	75.56	57	pass
2640.000	V	76.42	57	pass
3080.000	V	78.25	57	pass
3520.000	V	70.61	57	pass
3960.000	V	80.45	57	pass
4400.000	V	81.23	57	pass

Emission Frequency (MHz)	Ant. Polarity(H/H)	Measurement Result Below carrier(dBc)	Limit below carrier(dBc)	Result(P/F)
440.000	H	0		pass
880.000	H	69.67(-32.66dBm)	57	pass
1320.000	H	69.82(-32.83 dBm)	57	pass
1760.000	H	72.43	57	pass
2200.000	H	75.65	57	pass
2640.000	H	76.82	57	pass
3080.000	H	78.61	57	pass
3520.000	H	70.12	57	pass
3960.000	H	80.04	57	pass
4400.000	H	81.13	57	pass

Measurement Result for 12.5 KHz Channel Separation @ 479.975MHz

Emission Frequency (MHz)	Ant. Polarity(H/V)	Measurement Result Below carrier(dBc)	Limit below carrier(dBc)	Result(P/F)
479.975	V	0		pass
959.950	V	69.56(-32.32dBm)	57	pass
1439.925	V	71.34	57	pass
1919.900	V	73.25	57	pass
2399.875	V	74.47	57	pass
2879.850	V	75.46	57	pass
3359.825	V	77.53	57	pass
3839.800	V	79.54	57	pass
4319.775	V	70.48	57	pass
4799.750	V	71.71	57	pass

Emission Frequency (MHz)	Ant. Polarity(H/H)	Measurement Result Below carrier(dBc)	Limit below carrier(dBc)	Result(P/F)
479.975	H	0		pass
959.950	H	69.81(-32.85dBm)	57	pass
1439.925	H	71.35	57	pass
1919.900	H	73.62	57	pass
2399.875	H	74.31	57	pass
2879.850	H	75.52	57	pass
3359.825	H	77.43	57	pass
3839.800	H	79.32	57	pass
4319.775	H	70.24	57	pass
4799.750	H	71.54	57	pass

Measurement Result for 12.5 KHz Channel Separation @ 136.025MHz

Emission Frequency (MHz)	Ant. Polarity(H/V)	Measurement Result Below carrier(dBc)	Limit below carrier(dBc)	Result(P/F)
136.025	V	0		pass
272.050	V	69.25(-32.67dBm)	57	pass
408.08	V	70.12(-32.84dBm)	57	pass
544.100	V	70.31	57	pass
680.125	V	72.46	57	pass
816.150	V	74.13	57	pass
952.175	V	75.09	57	pass
1088.200	V	77.53	57	pass
1224.225	V	79.86	57	pass
1360.250	V	81.31	57	pass

Emission Frequency (MHz)	Ant. Polarity(H/H)	Measurement Result Below carrier(dBc)	Limit below carrier(dBc)	Result(P/F)
136.025	H	0		pass
272.050	H	69.31(-32.33dBm)	57	pass
408.08	H	70.12	57	pass
544.100	H	70.31	57	pass
680.125	H	72.53	57	pass
816.150	H	74.01	57	pass
952.175	H	75.85	57	pass
1088.200	H	77.56	57	pass
1224.225	H	79.88	57	pass
1360.250	H	81.32	57	pass

Measurement Result for 12.5 KHz Channel Separation @ 155.000MHz

Emission Frequency (MHz)	Ant. Polarity(H/V)	Measurement Result Below carrier(dBc)	Limit below carrier(dBc)	Result(P/F)
155.000	V	0		pass
310.000	V	68.34 (-32.84dBm)	57	pass
465.000	V	69.65	57	pass
620.000	V	72.68	57	pass
775.000	V	75.57	57	pass
930.000	V	76.51	57	pass
1085.000	V	78.32	57	pass
1240.000	V	70.57	57	pass
1395.000	V	80.41	57	pass
1550.000	V	81.27	57	pass

Emission Frequency (MHz)	Ant. Polarity(H/H)	Measurement Result Below carrier(dBc)	Limit below carrier(dBc)	Result(P/F)
155.000	H	0		pass
310.000	H	69.72(-32.66dBm)	57	pass
465.000	H	69.85(-32.83 dBm)	57	pass
620.000	H	72.43	57	pass
775.000	H	75.72	57	pass
930.000	H	76.95	57	pass
1085.000	H	78.63	57	pass
1240.000	H	70.14	57	pass
1395.000	H	80.12	57	pass
1550.000	H	81.26	57	pass

Measurement Result for 12.5 KHz Channel Separation @ 173.975MHz

Emission Frequency (MHz)	Ant. Polarity(H/V)	Measurement Result Below carrier(dBc)	Limit below carrier(dBc)	Result(P/F)
173.975	V	0		pass
347.950	V	69.57	57	pass
521.925	V	71.33	57	pass
695.900	V	73.28	57	pass
869.875	V	74.45	57	pass
1043.850	V	75.42	57	pass
1217.825	V	77.57	57	pass
1391.800	V	79.54	57	pass
1565.775	V	70.48	57	pass
1739.750	V	71.72	57	pass

Emission Frequency (MHz)	Ant. Polarity(H/H)	Measurement Result Below carrier(dBc)	Limit below carrier(dBc)	Result(P/F)
173.679	H	0		pass
347.358	H	69.85(-32.85dBm)	57	pass
521.037	H	71.53	57	pass
694.716	H	73.64	57	pass
868.395	H	74.38	57	pass
1042.074	H	75.69	57	pass
1215.753	H	77.37	57	pass
1389.432	H	79.59	57	pass
1563.111	H	70.38	57	pass
1736.790	H	71.71	57	pass

8.6 EMISSION MASK PLOT

The detailed procedure employed for Emission Mask measurements are specified as following:

- The transmitter shall be modulated by a 2.5 kHz audio signal,
- The level of the audio signal employed is 16 dB greater than that necessary to produce 50% of rated system deviation. Rated system deviation is 2.5 kHz.

The Worst Emission Mask D for 12.5 KHz channel Separation UHF (400.025MHz)

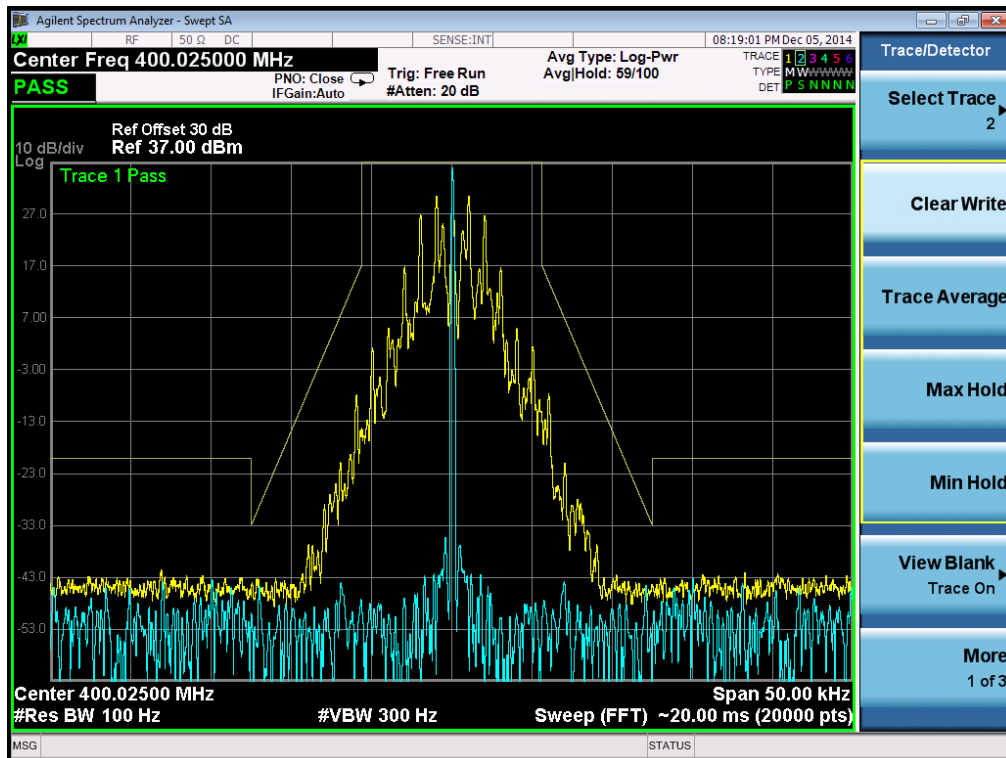

The Worst Emission Mask D for 12.5 KHz channel Separation VHF (136.025MHz)

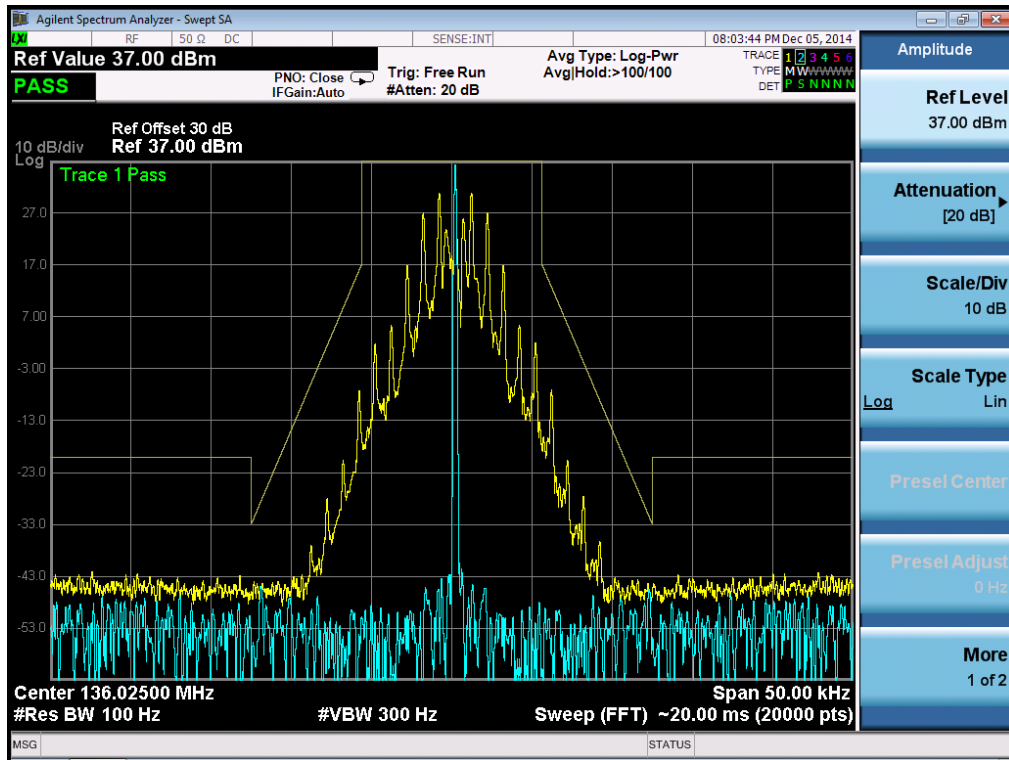

9. MODULATION CHARACTERISTICS

9.1 PROVISIONS APPLICABLE

According to CFR 47 section 2.1047(a), for Voice Modulation Communication Equipment, the frequency response of the audio modulation circuit over a range of 100 to 5000Hz shall be measured.

9.2 MEASUREMENT METHOD

9.2.1 Modulation Limit

- (1). Configure the EUT as shown in figure 1, adjust the audio input for 60% of rated system deviation at 1KHz using this level as a reference (0dB) and vary the input level from -20 to +20dB. Record the frequency deviation obtained as a function of the input level.
- (2). Repeat step 1 with input frequency changing to 300, 1000, 1500 and 3000Hz in sequence.

9.2.2 Audio Frequency Response

- (1). Configure the EUT as shown in figure 1.
- (2). Adjust the audio input for 20% of rated system deviation at 1 KHz using this level as a reference (0 dB).
- (3). Vary the Audio frequency from 100 Hz to 10 KHz and record the frequency deviation.
- (4). Audio Frequency Response = $20\log_{10} (\text{Deviation of test frequency}/\text{Deviation of 1 KHz reference})$.

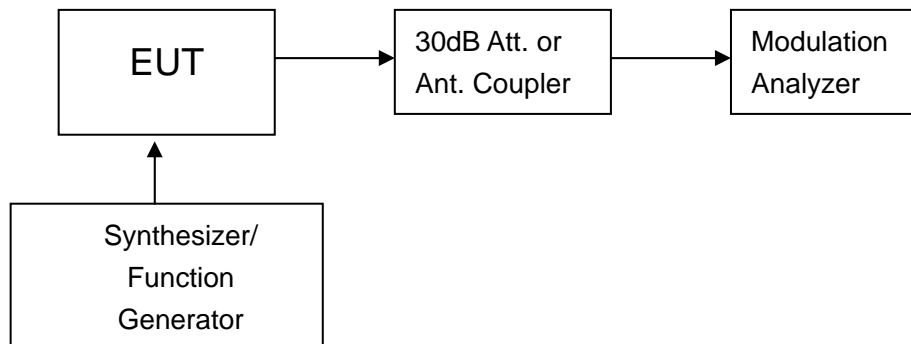

Figure 1: Modulation characteristic measurement configuration

9.3 MEASUREMENT RESULT
TEST RESULT TS FOR H POWER LEVEL

(A). MODULATION LIMIT:

Middle Channel @ 12.5 KHz Channel Separations

Modulation Level (dB)	Peak Freq. Deviation At 300 Hz	Peak Freq. Deviation At 1000 Hz	Peak Freq. Deviation At 1500 Hz	Peak Freq. Deviation At 3000 Hz
-20	0.25	0.86	0.89	0.91
-15	0.35	0.94	0.96	1.02
-10	0.47	1.25	1.27	1.36
-5	0.52	1.36	1.44	1.48
0	0.67	1.5	1.52	1.59
5	0.72	1.62	1.72	1.85
10	0.86	1.73	1.78	1.84
15	0.98	1.64	1.72	1.77
20	0.86	1.59	1.65	1.74

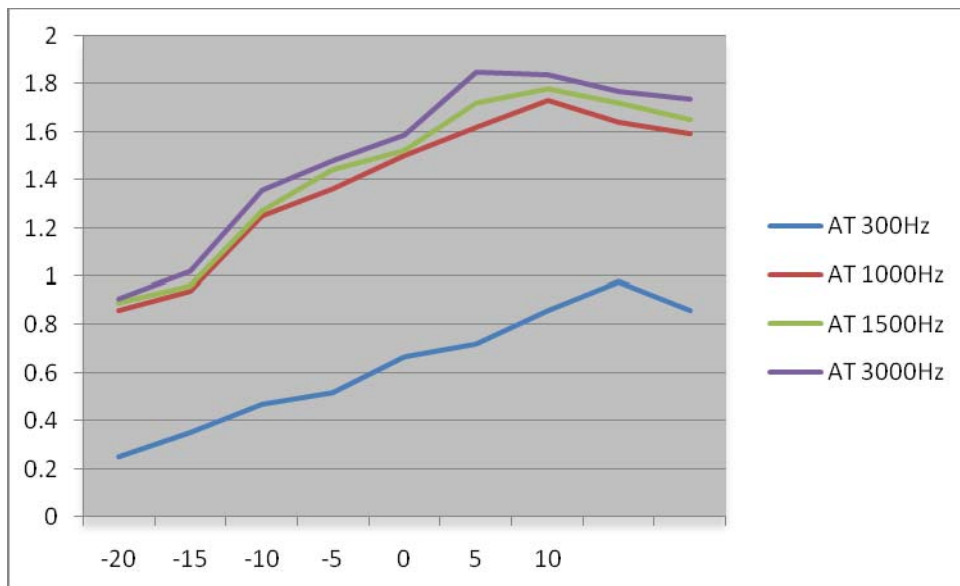

Note: All the modes had been tested, but only the worst data recorded in the report.

(B). AUDIO FREQUENCY RESPONSE:

Middle Channel @ 12.5 KHz Channel Separations

Frequency (Hz)	Deviation (KHz)	Audio Frequency Response(dB)
100	--	--
200	--	--
300	0.11	-13.15
400	0.15	-10.46
500	0.2	-7.96
600	0.25	-6.02
700	0.28	-5.04
800	0.35	-3.10
900	0.42	-1.51
1000	0.5	0.00
1200	0.55	0.83
1400	0.65	2.28
1600	0.75	3.52
1800	0.86	4.71
2000	0.94	5.48
2400	1.23	7.82
2500	1.43	9.13
2800	1.67	10.47
3000	1.75	10.88
3200	1.72	10.73
3600	1.56	9.88
4000	1.04	6.36
4500	0.83	4.40
5000	0.74	3.41
5500	0.56	0.98
6000	0.11	-13.15
6500	0.06	-18.42
7000	0.03	-24.44
7500	0.01	-33.98
9000	--	--
10000	--	--
14000	--	--
18000	--	--
20000	--	--
30000	--	--

Frequency Response of Middle Channel (VHF)

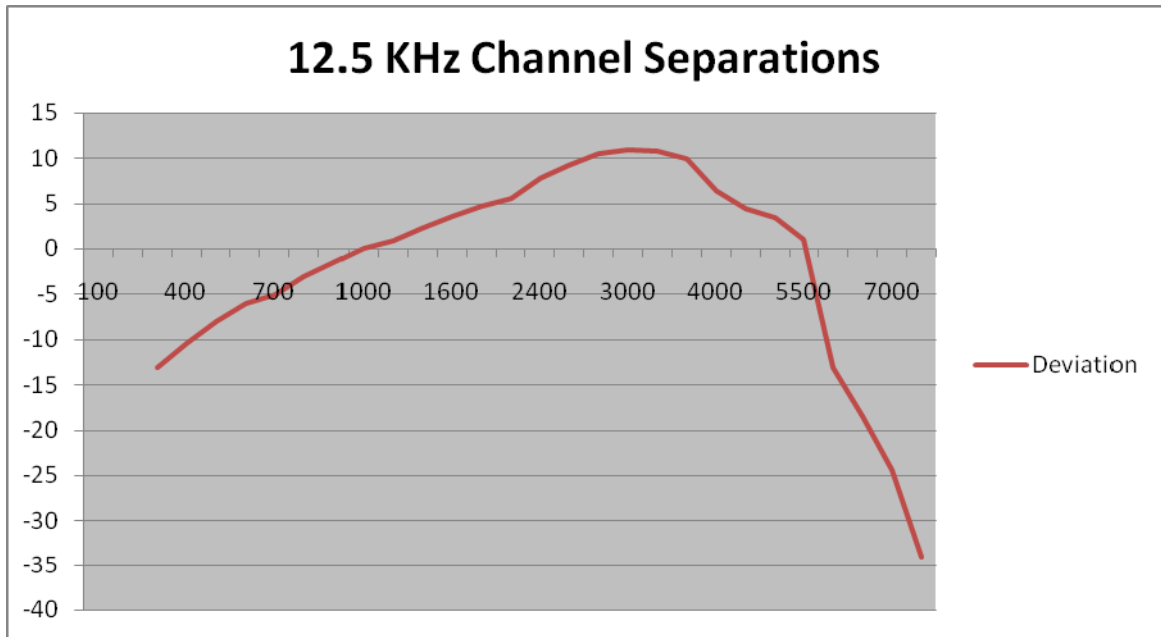

Note: All the modes had been tested, but only the worst data recorded in the report.

TEST RESULTS FOR H POWER LEVEL

(A). MODULATION LIMIT:

High Channel @ 12.5 KHz Channel Separations

Modulation Level (dB)	Peak Freq. Deviation At 300 Hz	Peak Freq. Deviation At 1000 Hz	Peak Freq. Deviation At 1500 Hz	Peak Freq. Deviation At 3000 Hz
-20	0.22	0.83	0.87	0.9
-15	0.34	0.94	0.96	1.06
-10	0.46	1.27	1.28	1.38
-5	0.54	1.34	1.43	1.49
0	0.67	1.5	1.52	1.59
+5	0.73	1.63	1.74	1.86
+10	0.87	1.76	1.78	1.84
+15	0.97	1.65	1.74	1.78
+20	0.88	1.59	1.68	1.75

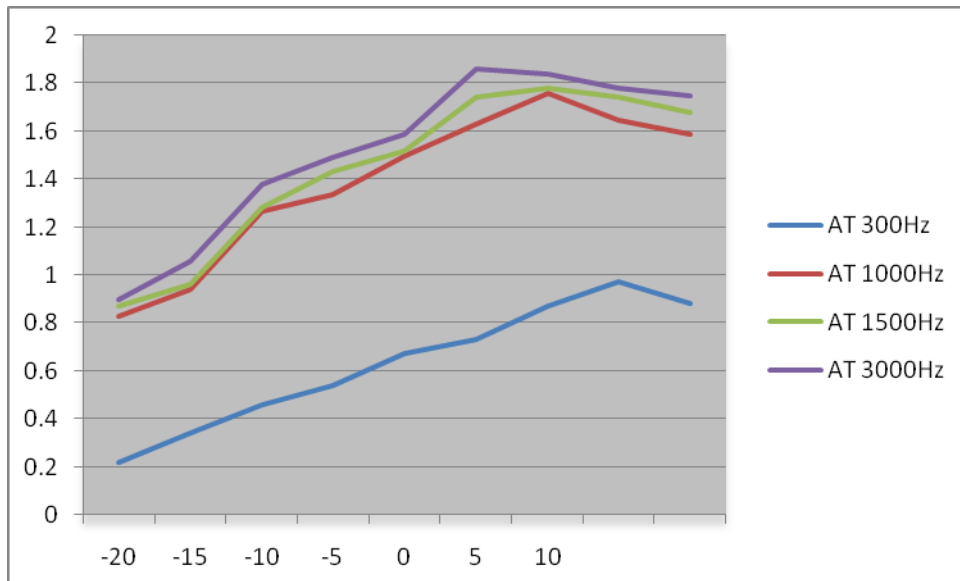

Note: All the modes had been tested, but only the worst data recorded in the report.

(B). AUDIO FREQUENCY RESPONSE:

High Channel @ 12.5 KHz Channel Separations

Frequency (Hz)	Deviation (KHz)	Audio Frequency Response(dB)
100	--	--
200	--	--
300	0.12	-12.40
400	0.16	-9.90
500	0.21	-7.54
600	0.26	-5.68
700	0.29	-4.73
800	0.35	-3.10
900	0.42	-1.51
1000	0.5	0.00
1200	0.55	0.83
1400	0.65	2.28
1600	0.75	3.52
1800	0.86	4.71
2000	0.94	5.48
2400	1.23	7.82
2500	1.43	9.13
2800	1.67	10.47
3000	1.75	10.88
3200	1.72	10.73
3600	1.56	9.88
4000	1.04	6.36
4500	0.83	4.40
5000	0.74	3.41
5500	0.56	0.98
6000	0.14	-11.06
6500	0.05	-20.00
7000	0.03	-24.44
7500	0.01	-33.98
9000	--	--
10000	--	--
14000	--	--
18000	--	--
20000	--	--
30000	--	--

Frequency Response of Middle Channel (UHF)

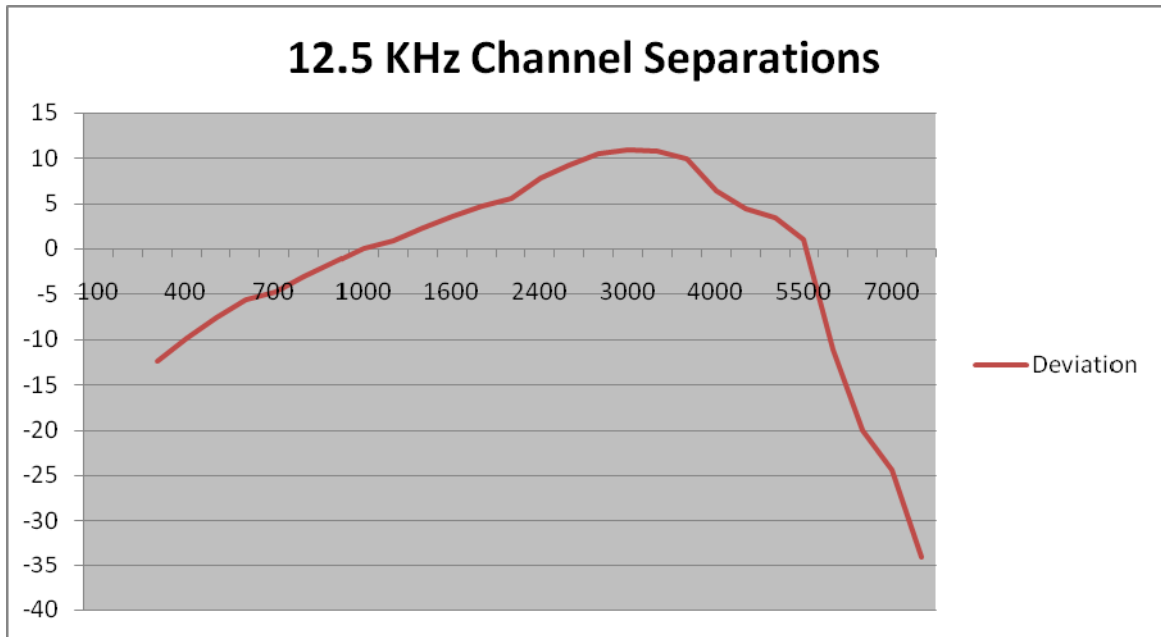

Note: All the modes had been tested, but only the worst data recorded in the report.

10. MAXIMUM TRANSMITTER POWER

10.1 PROVISIONS APPLICABLE

Per FCC §2.1046 and §90.205 AND RSS 119 Part 4.1: Maximum ERP is dependent upon the station's antenna HAAT and required service area.

10.2 TEST PROCEDURE

The RF output of Two-way Radio was conducted to a spectrum analyzer through an appropriate attenuator.

10.3 TEST CONFIGURATION

Conducted Output Power:

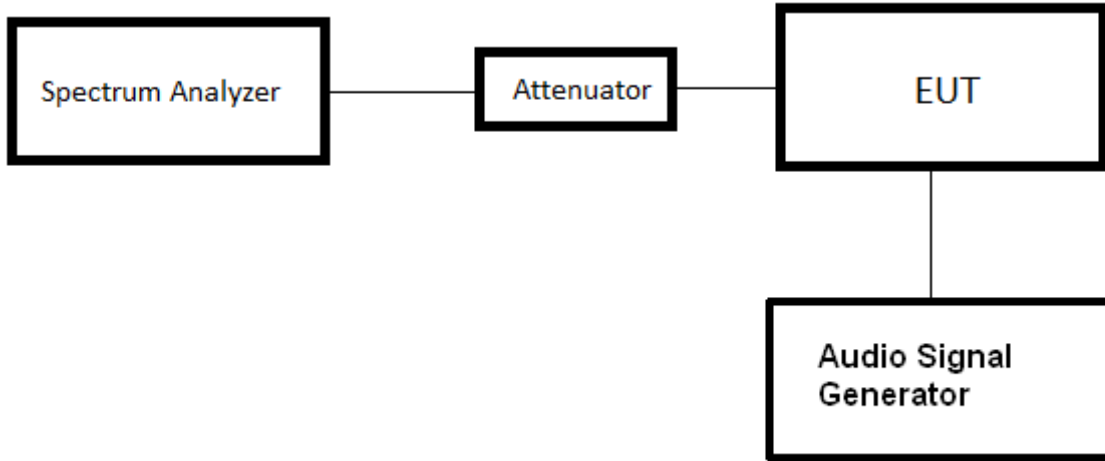

Effective Radiated Power measurement Below 1GHz

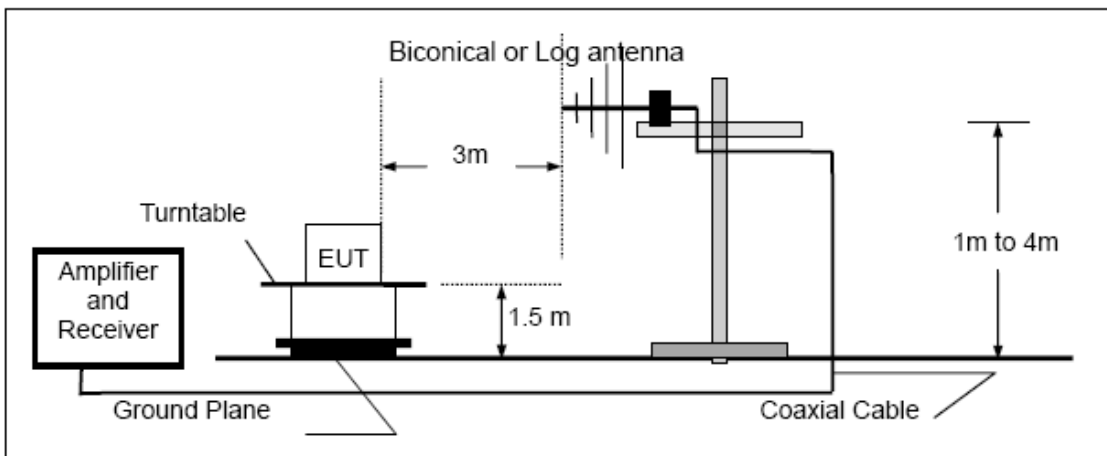

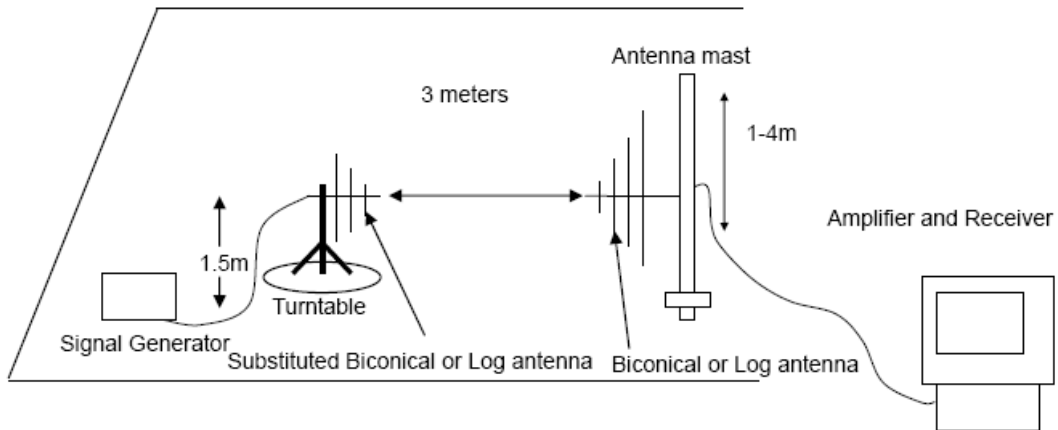

Above 1GHz

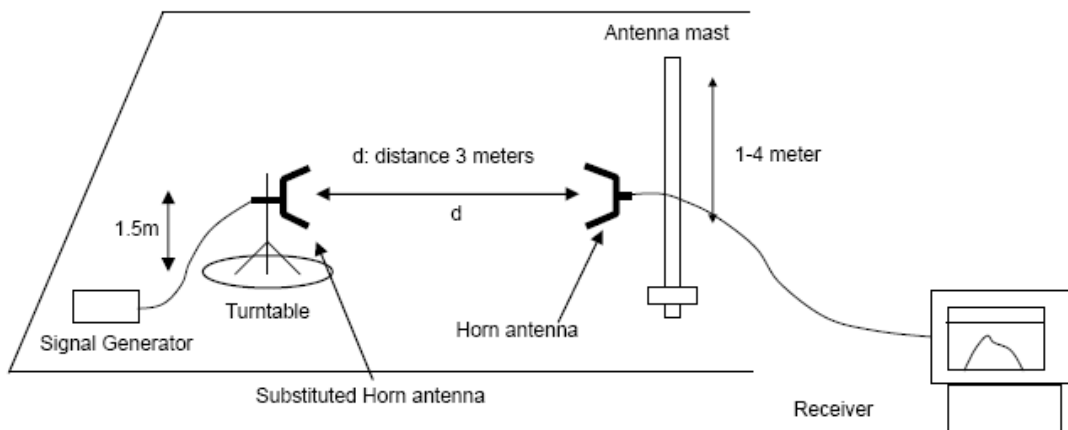
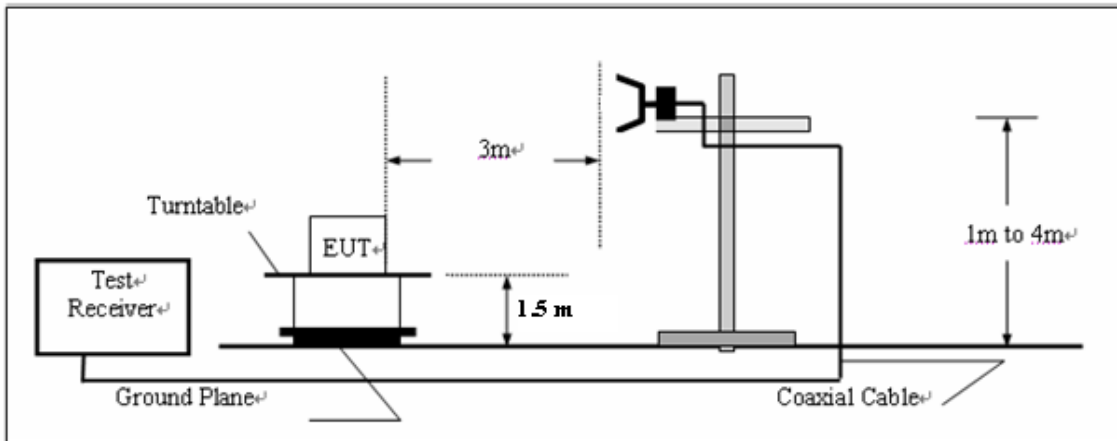

10.4 TEST RESULT

The maximum Conducted Power (CP) is
5 W for 12.5 KHz Channel Separation

Calculation Formula: $CP = R + A + L$

* Note:

CP: The final Conducted Power

R : The reading value from spectrum analyzer

A : The attenuation value of the used attenuator

L : The loss of all connection cables

Conducted Power Measurement Results		
Channel Separation	Channel	Measurement Result (dBm)
		For 36.99dBm(5W)
12.5 KHz	Bottom(136.025MHz)	36.91
	Middle(155.000MHz)	36.92
	Top (173.975MHz)	36.89
	Bottom(400.025MHz)	36.88
	Middle(440.000MHz)	36.93
	Top (479.975MHz)	36.90

Radiated Power Measurement Results		
Channel Separation	Channel	Measurement Result (dBm)
		For 36.99dBm(5W)
Channel Separation	Bottom(136.025MHz)	36.89
	Middle(155.000MHz)	36.91
	Top (173.975MHz)	36.87
	Bottom(400.025MHz)	36.89
	Middle(440.000MHz)	36.92
	Top (479.975MHz)	36.86

10.5 CONDUCT SPURIOUS PLOT

Conducted Spurious Emission (worst) @ UHF -- 400.025MHz With 12.5 KHz Channel Separation 30MHz-1GHz

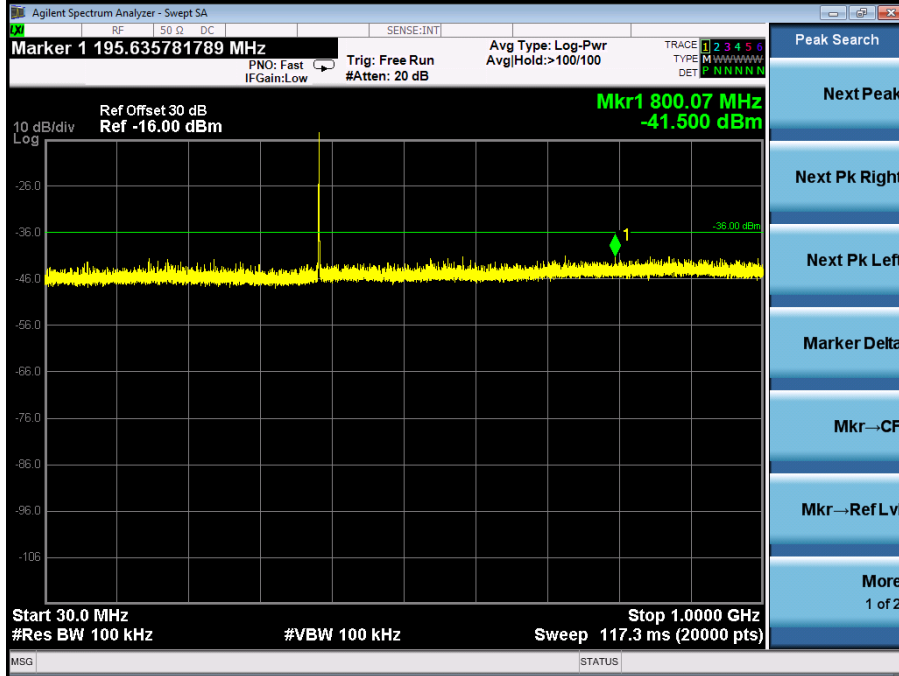

Conduct Spurious Emission (worst) @ UHF -- 400.025MHz With 12.5 KHz Channel Separation 1GHz-12.75GHz

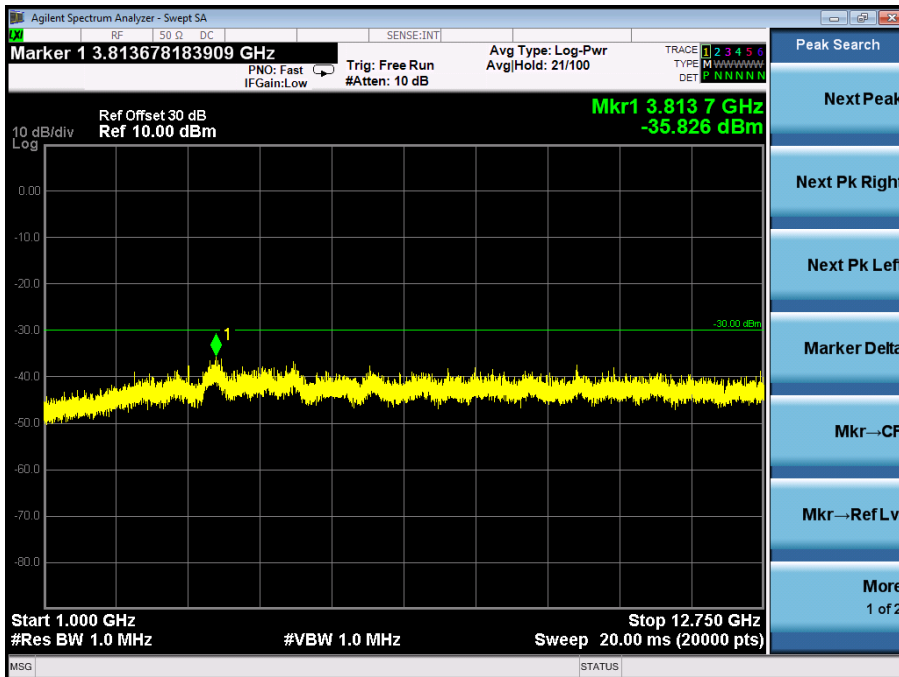

Conducted Spurious Emission (worst) @ VHF -- 136.025MHz With 12.5 KHz Channel Separation
30MHz-1GHz

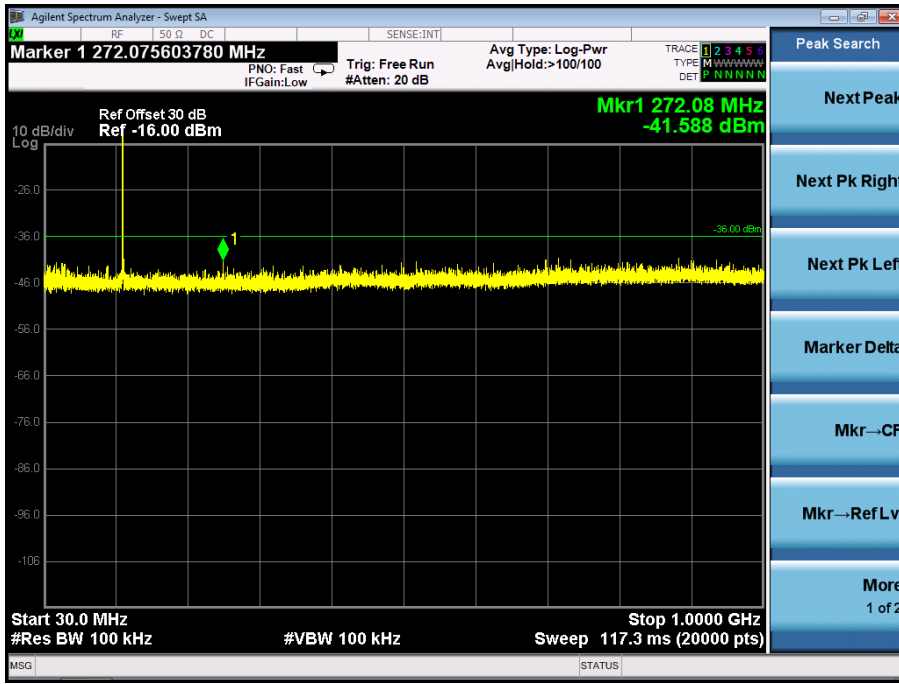

Conducted Spurious Emission (worst) @ VHF -- 136.025MHz With 12.5 KHz Channel Separation
1GHz-12.75GHz



11. TRANSMITTER FREQUENCY BEHAVIOR

11.1 PROVISIONS APPLICABLE

Section 90.214

Time intervals ^{1, 2}	Maximum frequency difference ³	All equipment	
		150 to 174 MHz	421 to 512 MHz
Transient Frequency Behavior for Equipment Designed to Operate on 25 kHz Channels			
t_1^4	± 25.0 kHz	5.0 ms	10.0 ms
t_2	± 12.5 kHz	20.0 ms	25.0 ms
t_3^4	± 25.0 kHz	5.0 ms	10.0 ms
Transient Frequency Behavior for Equipment Designed to Operate on 12.5 kHz Channels			
t_1^4	± 12.5 kHz	5.0 ms	10.0 ms
t_2	± 6.25 kHz	20.0 ms	25.0 ms
t_3^4	± 12.5 kHz	5.0 ms	10.0 ms
Transient Frequency Behavior for Equipment Designed to Operate on 6.25 kHz Channels			
t_1^4	± 6.25 kHz	5.0 ms	10.0 ms
t_2	± 3.125 kHz	20.0 ms	25.0 ms
t_3^4	± 6.25 kHz	5.0 ms	10.0 ms

¹ t_{on} is the instant when a 1 kHz test signal is completely suppressed, including any capture time due to phasing.

t_1 is the time period immediately following t_{on} .

t_2 is the time period immediately following t_1 .

t_3 is the time period from the instant when the transmitter is turned off until t_{off} .

t_{off} is the instant when the 1 kHz test signal starts to rise.

² During the time from the end of t_2 to the beginning of t_3 , the frequency difference must not exceed the limits specified in §90.213.

³ Difference between the actual transmitter frequency and the assigned transmitter frequency.

⁴ If the transmitter carrier output power rating is 6 watts or less, the frequency difference during this time period may exceed the maximum frequency difference for this time period.

11.2 TEST METHOD

TIA/EIA-603 2.2.19

11.3 DESCRIBE LIMIT LINE OF TRANSMITTER FREQUENCY BEHAVIOR

ton: The switch-on instant t_{on} of a transmitter is defined by the condition when the output power, measured at the antenna terminal, exceeds 0,1 % of the full output power (-30 dBc).

t1: period of time starting at t_{on} and finishing according to above 11.1

t2: period of time starting at the end of t_1 and finishing according to above 11.1

toff: switch-off instant defined by the condition when the output power falls below 0,1 % of the full output power (-30 dBc).

t3: period of time that finishing at t_{off} and starting according to above 11.1

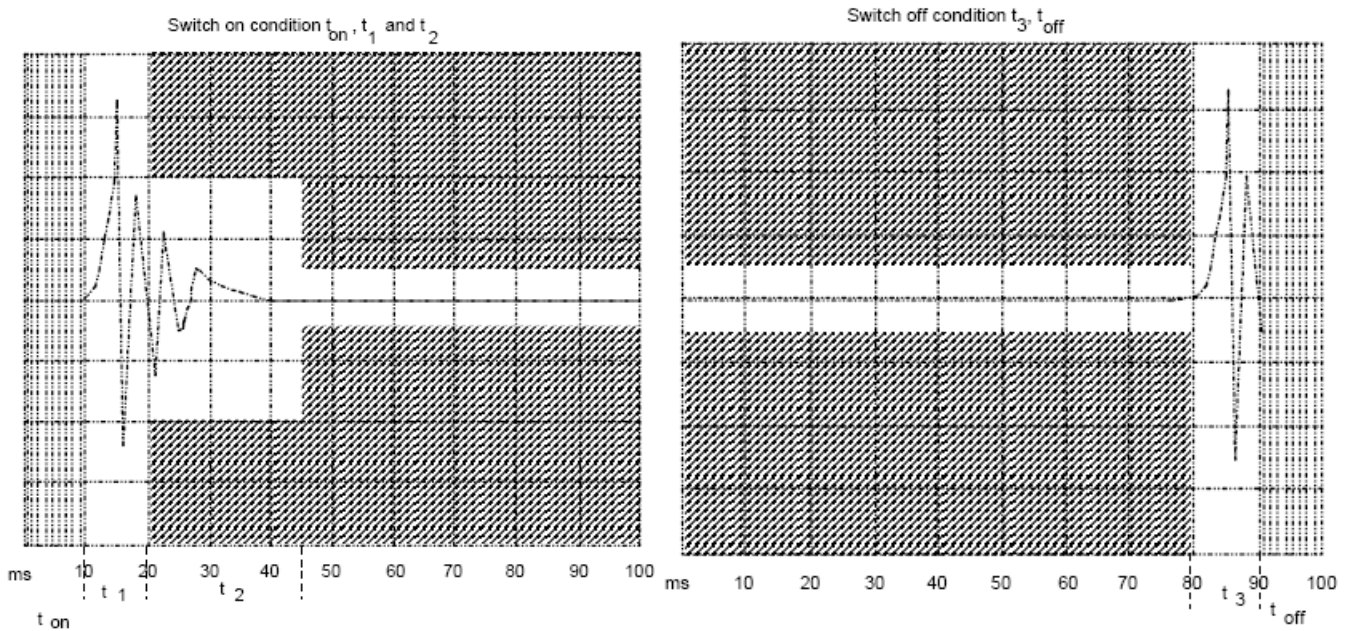

11.4 MEASURE RESULT

VHF TEST RESULTS

Transmitter Frequency Behavior @ 12.5 KHz Channel Separation--Off to On

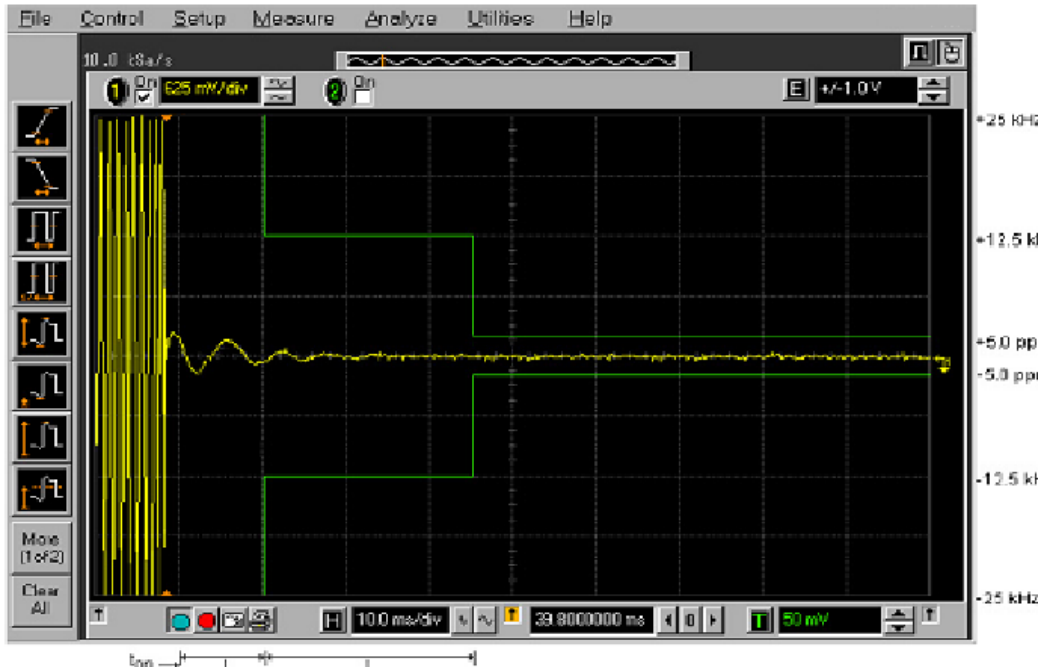

Transmitter Frequency Behavior @ 12.5 KHz Channel Separation--On to Off



UHF TEST RESULTS

Transmitter Frequency Behavior @ 12.5 KHz Channel Separation--Off to On

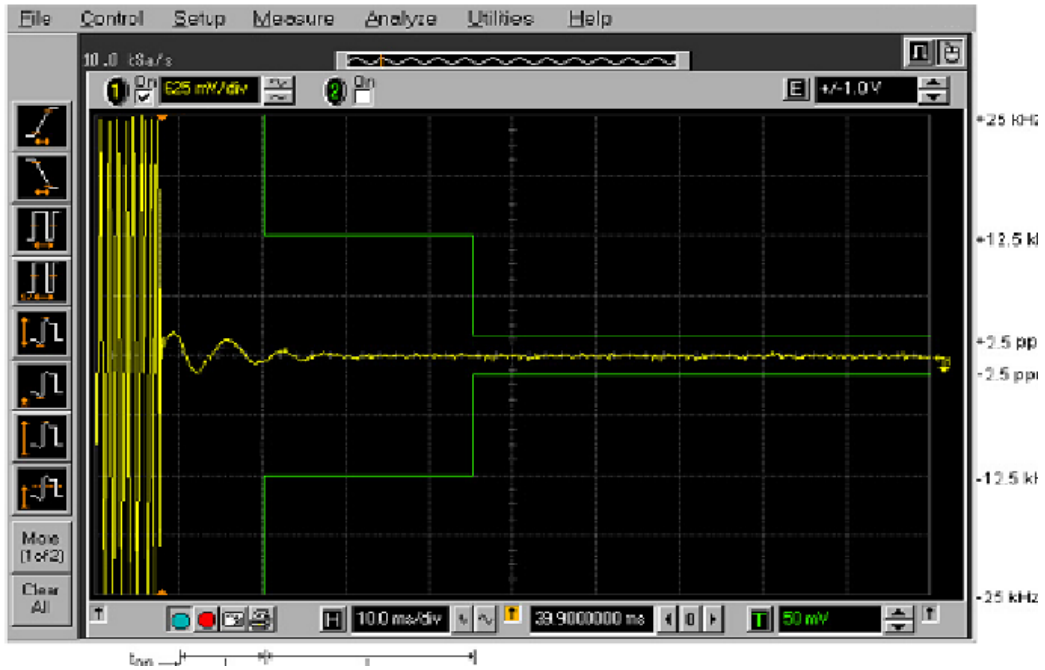

Transmitter Frequency Behavior @ 12.5 KHz Channel Separation--On to Off

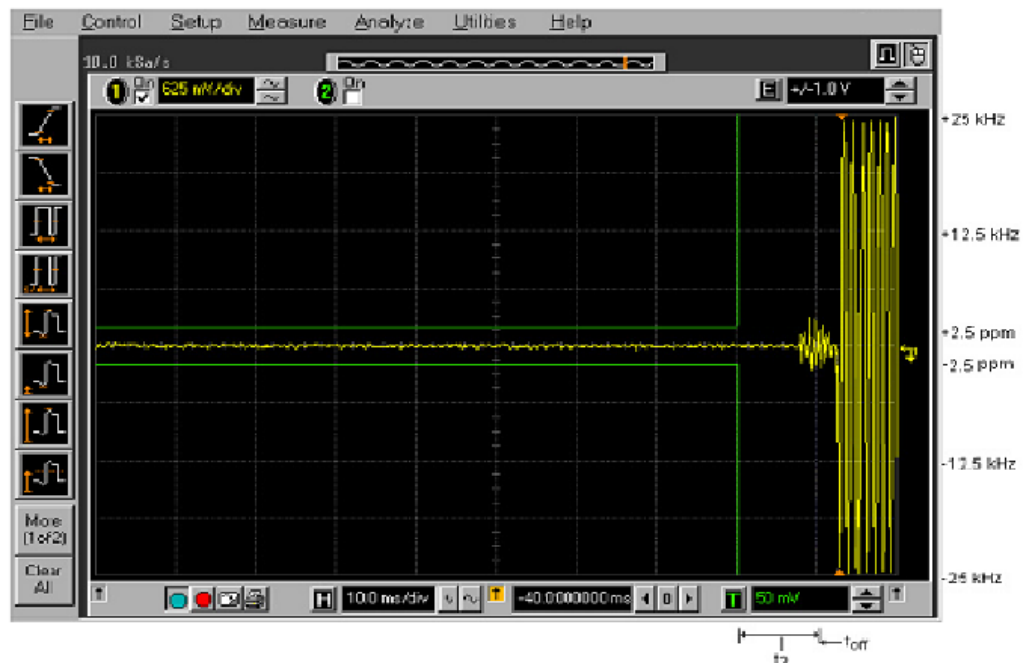

12. RADIATED EMISSION ON RECEIVING MODE

12.1 PROVISIONS APPLICABLE

FCC Part 15 Subpart B Section 15.109

RSS-Gen Subpart B Section RSS-Gen.6.1

12.2 TEST METHOD

ANSI C 63.4: 2003

12.3 MEASURE RESULT (MEASURED AT 3M USING FCC PART15 B LIMITS)

RADIATED EMISSION TEST RESULTS – HORIZONTAL (BELOW 1G)

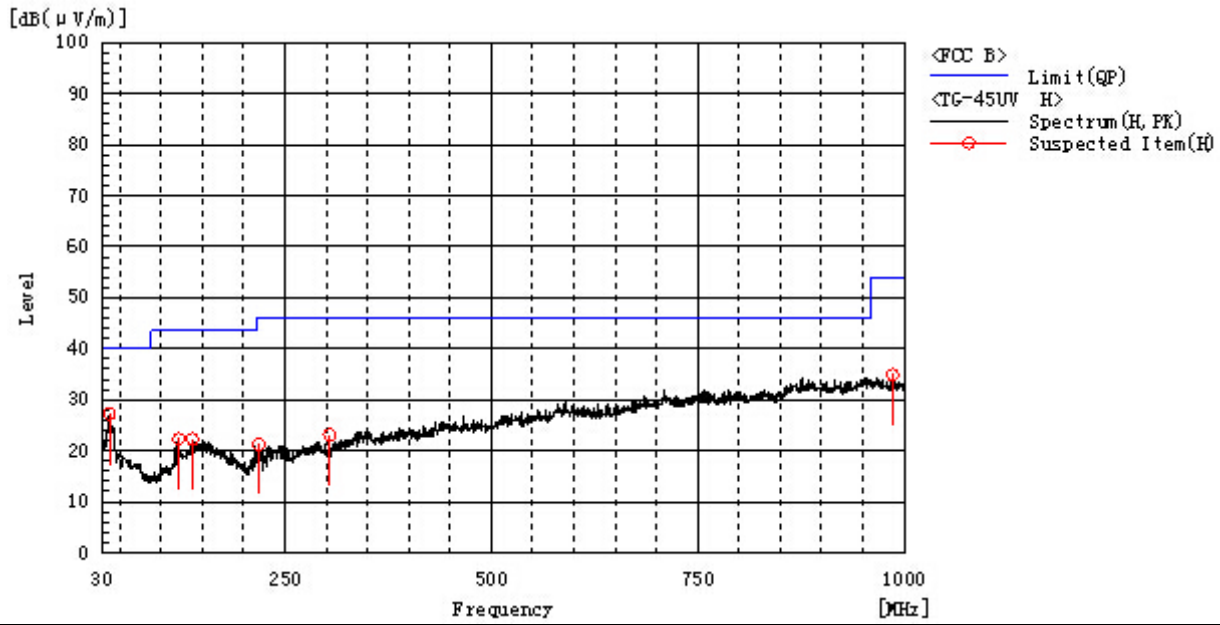

Frequency MHz	Polarization	Reading dB(uV)	Factor dB (1/m)	Level dB(uV/m) PK	Limit dB(uV/m) QP	Margin dB	Pass/Fail	Height cm	Angle deg
37.760	H	6.0	21.2	27.2	40.0	12.8	Pass	100.0	36.1
985.935	H	6.7	28.2	34.9	54.0	19.1	Pass	150.0	106.5
138.155	H	7.5	14.8	22.3	43.5	21.2	Pass	150.0	308.9
121.665	H	9.4	13.0	22.4	43.5	21.1	Pass	150.0	308.9
304.510	H	7.7	15.4	23.1	46.0	22.9	Pass	100.0	154.4
218.665	H	9.6	11.6	21.2	46.0	24.8	Pass	150.0	334.5

RADIATED EMISSION TEST RESULTS – VERTICAL (BELOW 1G)

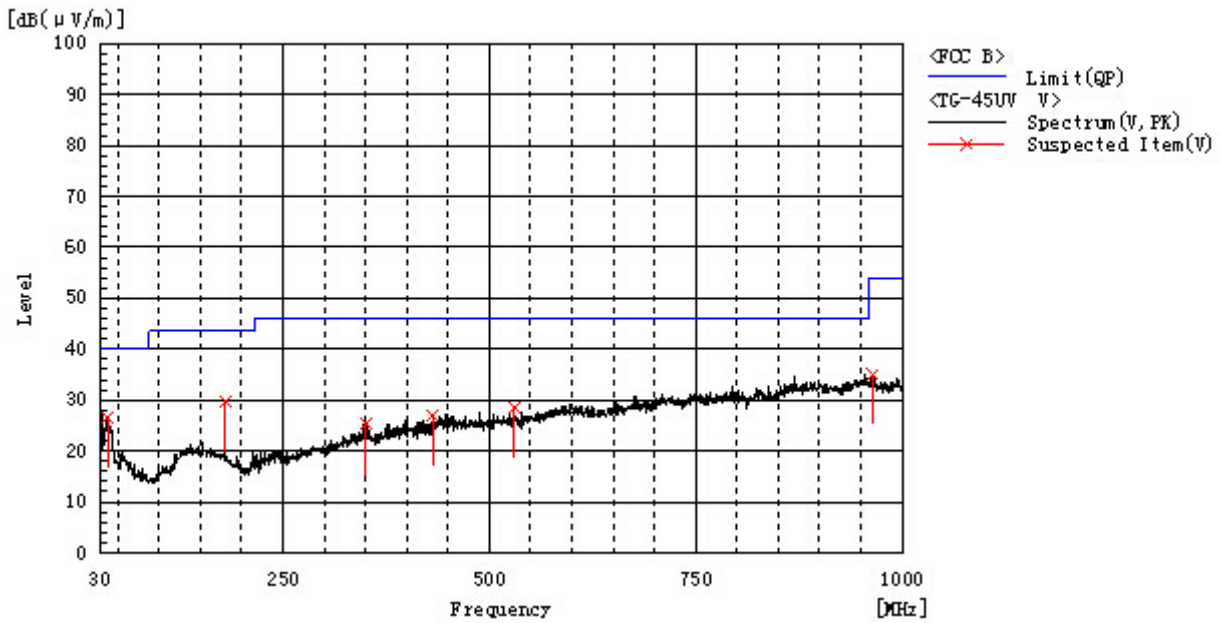

Frequency MHz	Polarization	Reading dB(uV)	Factor dB (1/m)	Level dB(uV/m) PK	Limit dB(uV/m) QP	Margin dB	Pass/Fail	Height cm	Angle deg
38.245	V	5.3	21.2	26.5	40.0	13.5	Pass	150.0	148.3
964.110	V	6.4	28.7	35.1	54.0	18.9	Pass	100.4	336.2
180.350	V	16.0	13.7	29.7	43.5	13.8	Pass	100.4	357.2
431.580	V	7.8	19.3	27.1	46.0	18.9	Pass	100.4	271.0
530.520	V	6.9	21.5	28.4	46.0	17.6	Pass	150.0	43.1
351.070	V	6.8	18.4	25.2	46.0	20.8	Pass	150.0	79.9

RADIATED EMISSION TEST RESULTS – HORIZONTAL (ABOVE 1G)

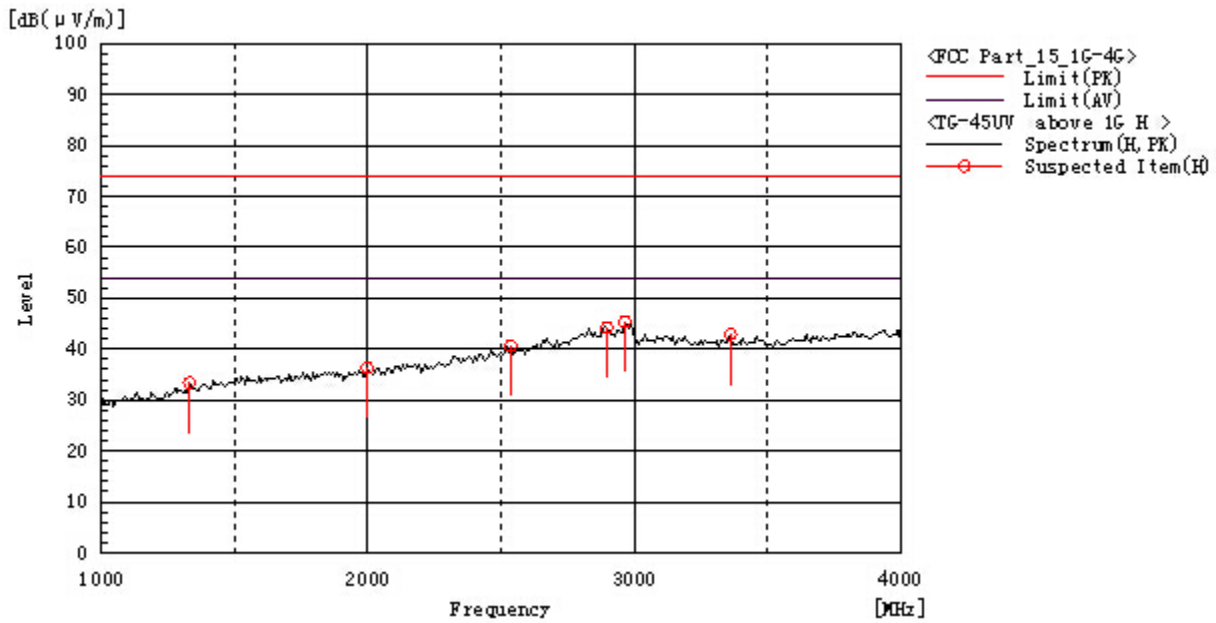

Frequency MHz	Polarization	Reading dB(uV)	Factor dB (1/m)	Level dB(uV/m) PK	Limit dB(uV/m) PK	Margin dB PK	Pass/Fail	Height cm	Angle deg
2965.000	H	42.2	3.2	45.4	74.0	28.6	Pass	200.0	149.1
2897.500	H	41.0	3.3	44.3	74.0	29.7	Pass	100.0	108.7
2537.500	H	40.0	0.6	40.6	74.0	33.4	Pass	100.0	108.7
1997.500	H	39.0	-2.7	36.3	74.0	37.7	Pass	100.0	180.3
1330.000	H	38.6	-5.2	33.4	74.0	40.6	Pass	200.0	149.1
3362.500	H	38.9	4.0	42.9	74.0	31.1	Pass	200.0	149.1

RADIATED EMISSION TEST RESULTS – VERTICAL (ABOVE 1G)

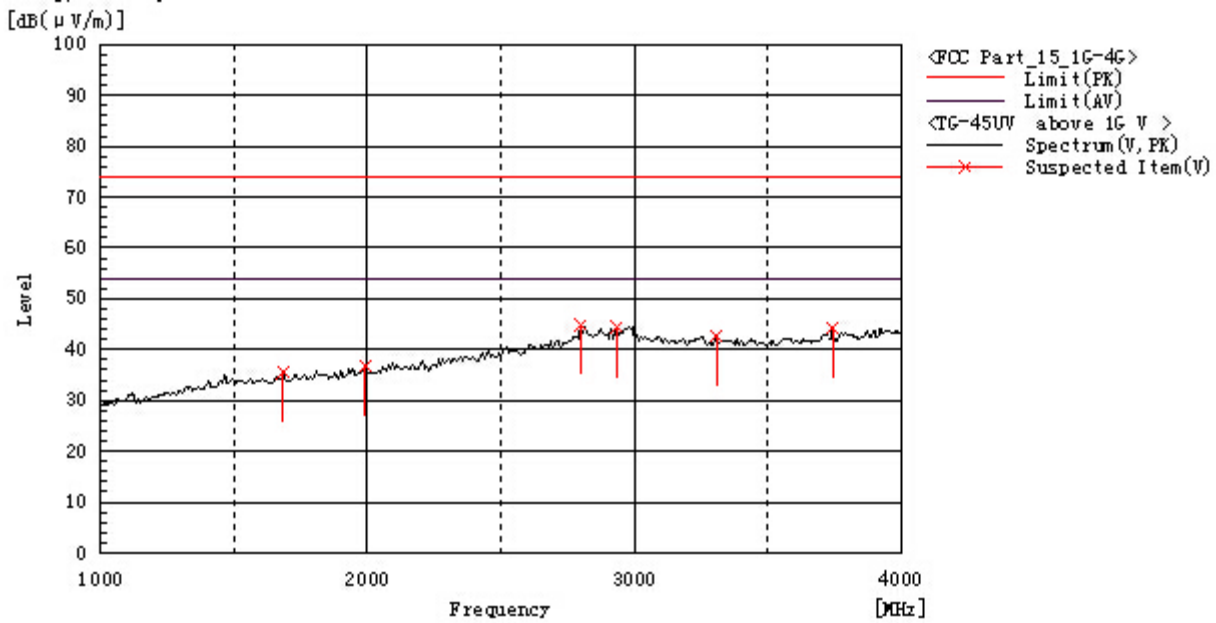

Frequency MHz	Polarization	Reading dB(uV)	Factor dB (1/m)	Level dB(uV/m) PK	Limit dB(uV/m) PK	Margin dB PK	Pass/Fail	Height cm	Angle deg
2800.000	V	42.5	2.5	45.0	74.0	29.0	Pass	200.0	73.2
2935.000	V	41.0	3.3	44.3	74.0	29.7	Pass	100.0	118.0
3310.000	V	38.8	3.9	42.7	74.0	31.3	Pass	200.0	109.3
3745.000	V	39.2	5.2	44.4	74.0	29.6	Pass	100.0	118.0
1990.000	V	39.5	-2.7	36.8	74.0	37.2	Pass	200.0	73.2
1682.500	V	38.9	-3.4	35.5	74.0	38.5	Pass	200.0	219.2

13. AUDIO LOW PASS FILTER RESPONSE

13.1 LIMITS

2.1047(a): Voice modulated communication equipment. A curve or equivalent data showing the frequency response of the audio modulating circuit over a range of 100 to 5000 Hz shall be submitted. For equipment required to have an audio low-pass filter, a curve showing the frequency response of the filter or of all circuitry installed between the modulation limiter and the modulated stage shall be submitted.

90.242(b)(8): Recommended audio filter attenuation characteristics are given below:

Audio band	Minimum Attenuation Rel. to 1 KHz Attenuation
3 –20 KHz	$60 \log_{10}(f/3)$ dB where f is in KHz
20 – 30 KHz	50dB

13.2. METHOD OF MEASUREMENTS

The rated audio input signal was applied to the input of the audio low-pass filter (or of all modulation stages) using an audio oscillator, this input signal level and its corresponding output signal were then measured and recorded using the FFT Digital Spectrum Analyzer. Tests were repeated at different audio signal frequencies from 0 to 50 KHz.

13.3 TEST DATA

12.5 KHZ CHANNEL SPACING, F3E, FREQUENCY OF ALL MODULATION STATES (TEST RESULT FOR VHF)

Frequency (KHz)	Audio In (dBV)	Audio out (dBV)	Attenuation (Out_In) dB	Attenuation Rel.to 3 KHz (dB)	Recommended Attenuation (dB)
0.1	-76.16	-31.21	46.38	-36.53	
0.2	-76.16	-17.38	58.25	-25.63	
0.4	-76.16	-6.29	71.65	-12.83	
0.6	-76.16	0.41	74.25	-6.43	
0.8	-76.16	4.17	78.95	-2.93	
1.0	-76.16	7.18	83.65	-0.03	
1.5	-76.16	8.27	84.85	2.16	
2.0	-76.16	8.99	85.35	1.57	
2.5	-76.16	7.52	83.85	0.67	
3.0	-76.16	6.27	82.55	-1.82	0
3.5	-76.16	2.63	78.45	-4.93	-4
4.0	-76.16	-2.3	74.65	-9.43	-7
4.5	-76.16	-9.21	68.25	-16.53	-12
5.0	-76.16	-15.17	60.65	-21.73	-15
6.0	-76.16	-21.23	54.15	-28.63	-18
7.0	-76.16	-31.61	46.25	-36.43	-22
8.0	-76.16	-39.22	37.95	-47.63	-26
9.0	-76.16	-61.95	15.15	-66.93	-28
10.0	-76.16	-61.95	15.15	-66.43	-31
12.0	-76.16	-61.95	15.15	-66.43	-37
14.0	-76.16	-61.95	15.15	-66.43	-40
16.0	-76.16	-61.95	15.15	-66.43	-44
18.0	-76.16	-61.95	15.15	-66.43	-47
20.0	-76.16	-61.95	15.15	-66.43	-49
25.0	-76.16	-61.95	15.15	-66.43	-49
30.0	-76.16	-61.95	15.15	-66.43	-49
35.0	-76.16	-61.95	15.15	-66.43	-49
40.0	-76.16	-61.95	15.15	-66.43	-49
45.0	-76.16	-61.95	15.15	-66.43	-49
50.0	-76.16	-61.95	15.15	-66.43	-49

Note: Due to the difficulty of measuring the Frequency Response of the internal low-pass filter, the Frequency Response of All Modulation States is performed to show the roll-off at 3 KHz in comparison with the recommended audio filter attenuation.

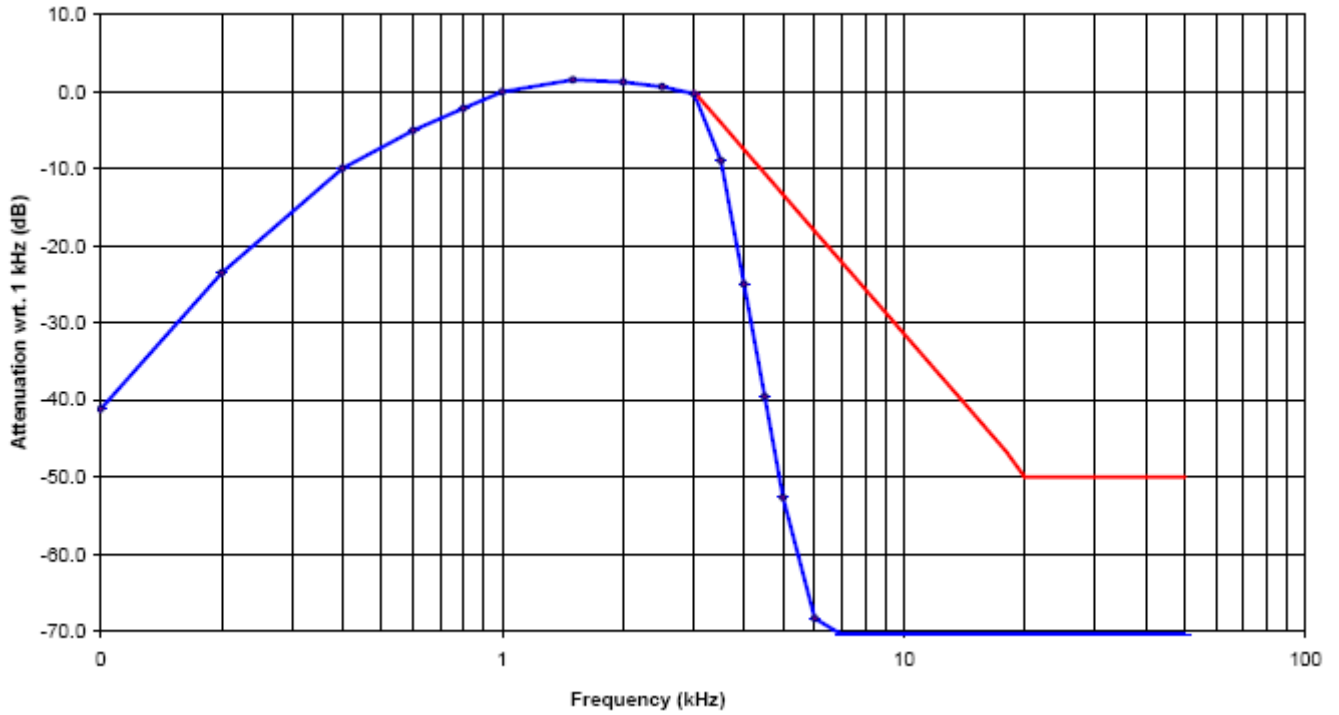

APPENDIX I: PHOTOGRAPHS OF SETUP
RADIATED EMISSION TEST SETUP

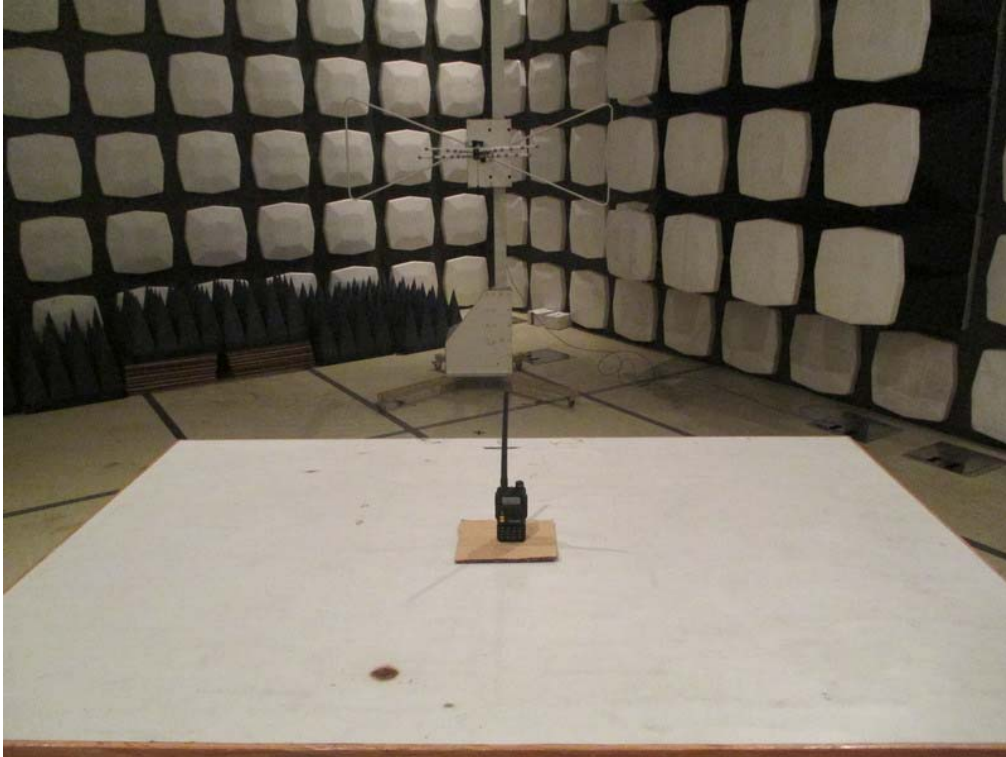

CONDUCTED EMISSION TEST SETUP



APPENDIX II: EXTERNAL VIEW OF EUT
TOTAL VIEW OF EUT



TOP VIEW OF EUT



BOTTOM VIEW OF EUT



FRONT VIEW OF EUT



BACK VIEW OF EUT



LEFT VIEW OF EUT



RIGHT VIEW OF EUT



OPEN VIEW-1 OF EUT



OPEN VIEW-2 OF EUT



OPEN VIEW-3 OF EUT

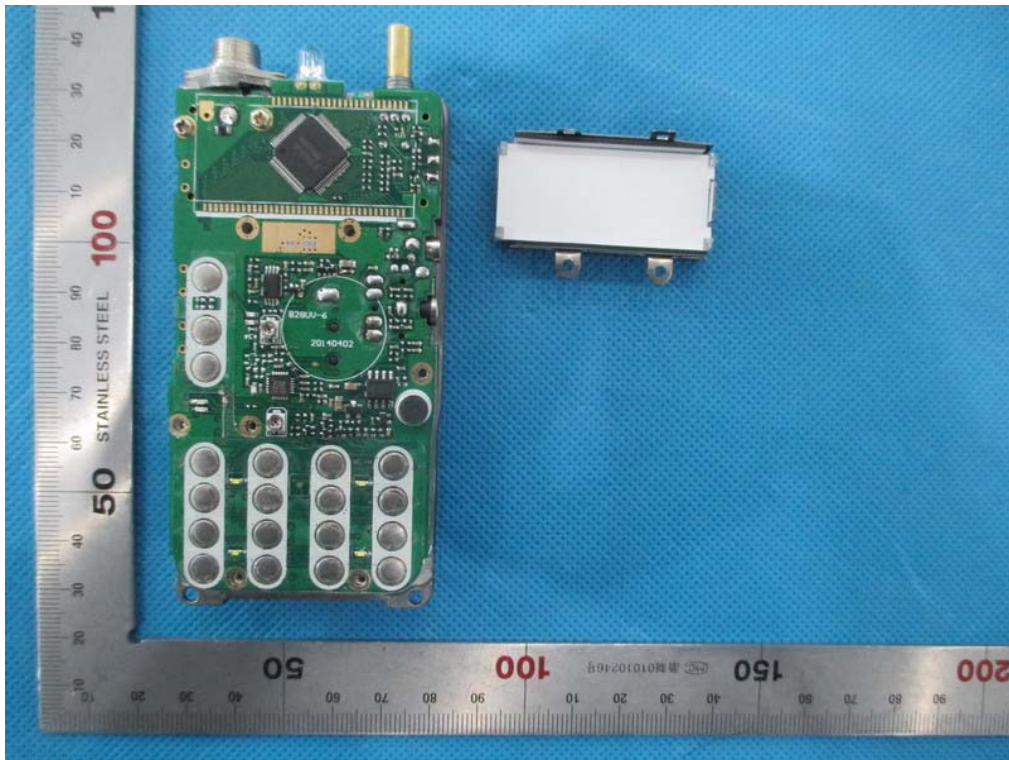

OPEN VIEW-4 OF EUT



INTERNAL VIEW-1 OF EUT

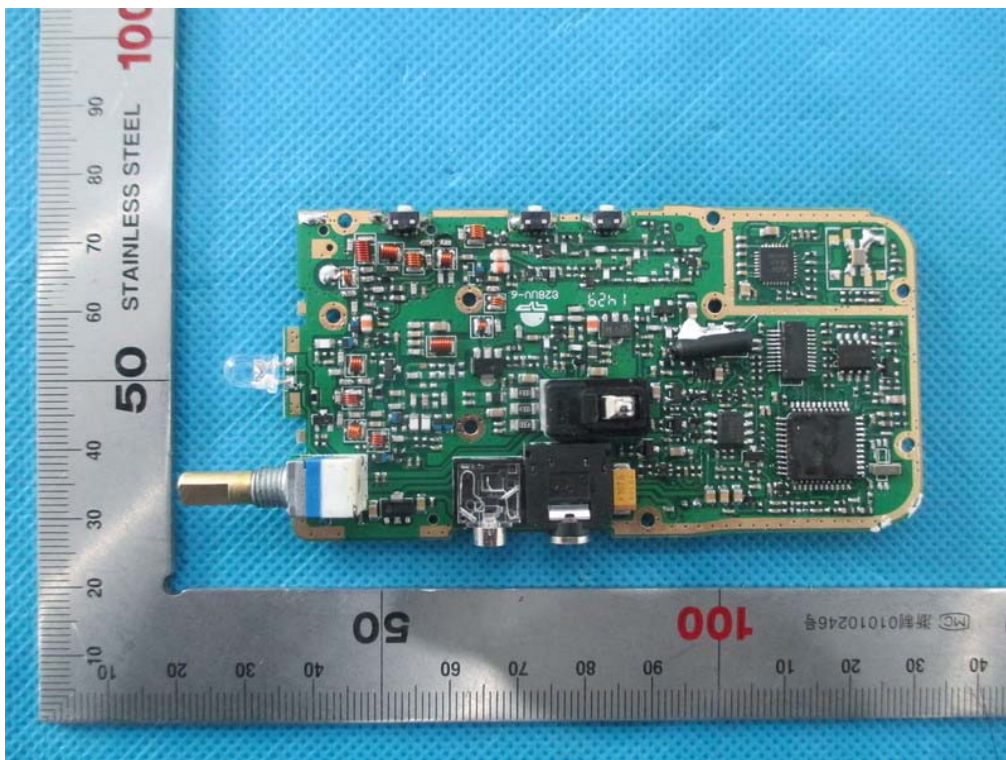

INTERNAL VIEW-2 OF EUT

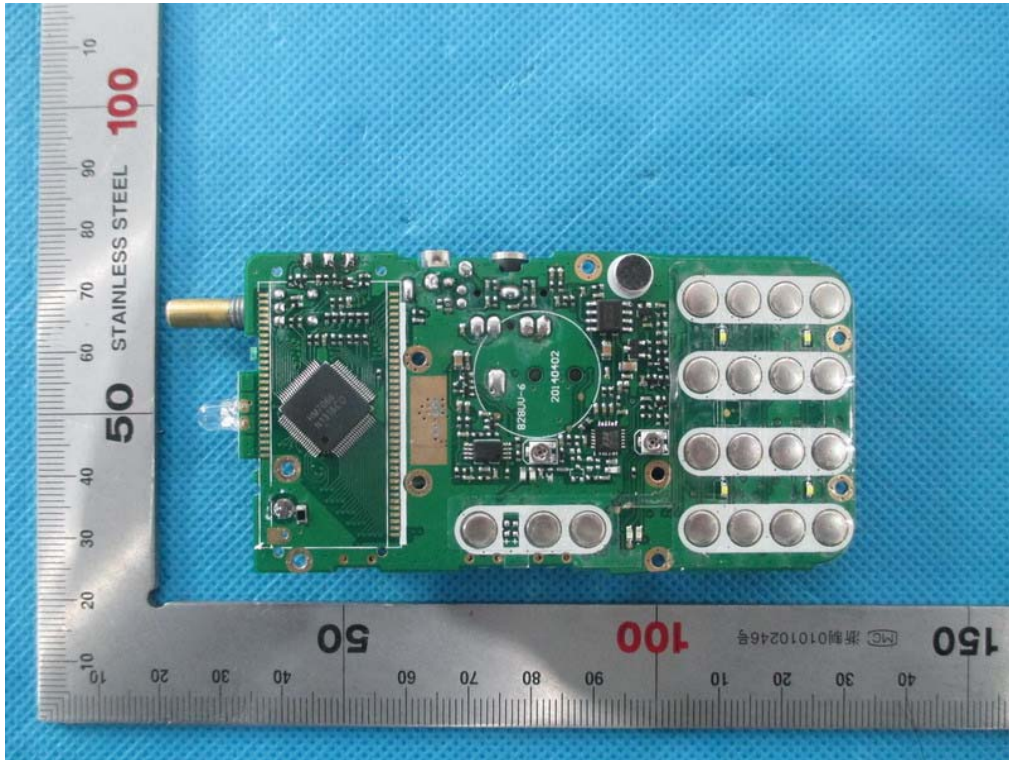

----END OF REPORT----