



MEASUREMENT REPORT

FCC PART 15.247 WLAN 802.11b/g/n

FCC ID: XBG-RENCB
APPLICANT: Avalue Technology Inc
Application Type: Certification
Product: Gateway
Model No.: REN-CB
Trademark: 
FCC Classification: (DTS) Digital Transmission System
FCC Rule Part(s): Part 15.247
Test Procedure(s): ANSI C63.10-2013, KDB 558074 D01v05
Received Date: March 26, 2018
Test Date: April 11~17, 2018

Tested By : *Peter Syu*

(Peter Syu)

Reviewed By : *Paddy Chen*

(Paddy Chen)

Approved By : *Chenz Ker*

(Chenz Ker)



Testing Laboratory
3261

The test results only relate to the samples tested.

This equipment has been shown to be capable of compliance with the applicable technical standards as indicated in the measurement report and was tested in accordance with the measurement procedures specified in KDB 558074 D01v05. Test results reported herein relate only to the item(s) tested.

The test report shall not be reproduced except in full without the written approval of MRT Technology (Taiwan) Co., Ltd.

Revision History

Report No.	Version	Description	Issue Date	Note
1803TW3102-U3	1.0	Original Report	2019-01-19	

CONTENTS

Description	Page
§2.1033 General Information	5
1. INTRODUCTION	6
1.1. Scope.....	6
1.2. MRT Test Location.....	6
2. PRODUCT INFORMATION	7
2.1. Equipment Description	7
2.2. Working Frequencies for this Report	8
2.3. Test Mode	9
2.4. Test Software	9
2.5. Test Configuration	10
2.6. EMI Suppression Device(s)/Modifications	10
2.7. Labeling Requirements	10
3. DESCRIPTION of TEST	11
3.1. Evaluation Procedure	11
3.2. AC Line Conducted Emissions	11
3.3. Radiated Emissions	12
4. ANTENNA REQUIREMENTS	13
5. TEST EQUIPMENT CALIBRATION DATE	14
6. MEASUREMENT UNCERTAINTY	15
7. TEST RESULT	16
7.1. Summary.....	16
7.2. 6dB Bandwidth Measurement	17
7.2.1. Test Limit	17
7.2.2. Test Procedure used	17
7.2.3. Test Setting	17
7.2.4. Test Setup	17
7.2.5. Test Result	18
7.3. Output Power Measurement.....	21
7.3.1. Test Limit	21
7.3.2. Test Procedure Used	21
7.3.3. Test Setting	21
7.3.4. Test Setup	21
7.3.5. Test Result of Output Power	22
7.4. Power Spectral Density Measurement	23
7.4.1. Test Limit	23
7.4.2. Test Procedure Used	23
7.4.3. Test Setting	23
7.4.4. Test Setup	23
7.4.5. Test Result	24
7.5. Out-of-Band Spurious Emissions Emissions Measurement.....	27

7.5.1.	Test Limit	27
7.5.2.	Test Procedure Used	27
7.5.3.	Test Settintg	27
7.5.4.	Test Setup	27
7.5.5.	Test Result	28
7.6.	Radiated Spurious Emission Measurement.....	37
7.6.1.	Test Limit	37
7.6.2.	Test Procedure Used	37
7.6.3.	Test Setting	37
7.6.4.	Test Setup	39
7.6.5.	Test Result	41
7.7.	Radiated Restricted Band Edge Measurement.....	67
7.7.1.	Test Limit	67
7.7.2.	Test Procedure Used	67
7.7.3.	Test Setting	67
7.7.4.	Test Setup	69
7.7.5.	Test Result	70
7.8.	AC Conducted Emissions Measurement	101
7.8.1.	Test Limit	101
7.8.2.	Test Setup	101
7.8.3.	Test Result	102
8.	CONCLUSION	104

§2.1033 General Information

Applicant	Avalue Technology Inc
Applicant Address	7F, 228, Lian-cheng Road, Zhonghe Dist., New Taipei City 235, Taiwan
Manufacturer	Avalue Technology Inc
Manufacturer Address	7F, 228, Lian-cheng Road, Zhonghe Dist., New Taipei City 235, Taiwan
Test Site	MRT Technology (Taiwan) Co., Ltd
Test Site Address	No. 38, Fuxing Second Rd., Guishan Dist., Taoyuan City 333, Taiwan (R.O.C)
MRT FCC Registration No.	291082
FCC Rule Part(s)	Part 15.247
Model No.	REN-CB
Test Device Serial No.	N/A <input type="checkbox"/> Production <input checked="" type="checkbox"/> Pre-Production <input type="checkbox"/> Engineering

Test Facility / Accreditations

1. MRT facility is a FCC registered (Reg. No. 291082) test facility with the site description report on file and is designated by the FCC as an Accredited Test Firm.
2. MRT facility is an IC registered (MRT Reg. No. 21723) test laboratory with the site description on file at Industry Canada.
3. MRT Lab is accredited to ISO 17025 by the Taiwan Accreditation Foundation (TAF Cert. No. 3261) in EMC, Telecommunications and Radio testing for FCC (Designation Number: TW3261), Industry Taiwan, EU and TELEC Rules.

1. INTRODUCTION

1.1. Scope

Measurement and determination of electromagnetic emissions (EMC) of radio frequency devices including intentional and/or unintentional radiators for compliance with the technical rules and regulations of the Federal Communications Commission and the Industry Canada Certification and Engineering Bureau.

1.2. MRT Test Location

The map below shows the location of the MRT LABORATORY, its proximity to the Taoyuan City. These measurement tests were conducted at the MRT Technology (Taiwan) Co., Ltd. Facility located at No.38, Fuxing 2nd Rd., Guishan Dist., Taoyuan City 33377, Taiwan (R.O.C).

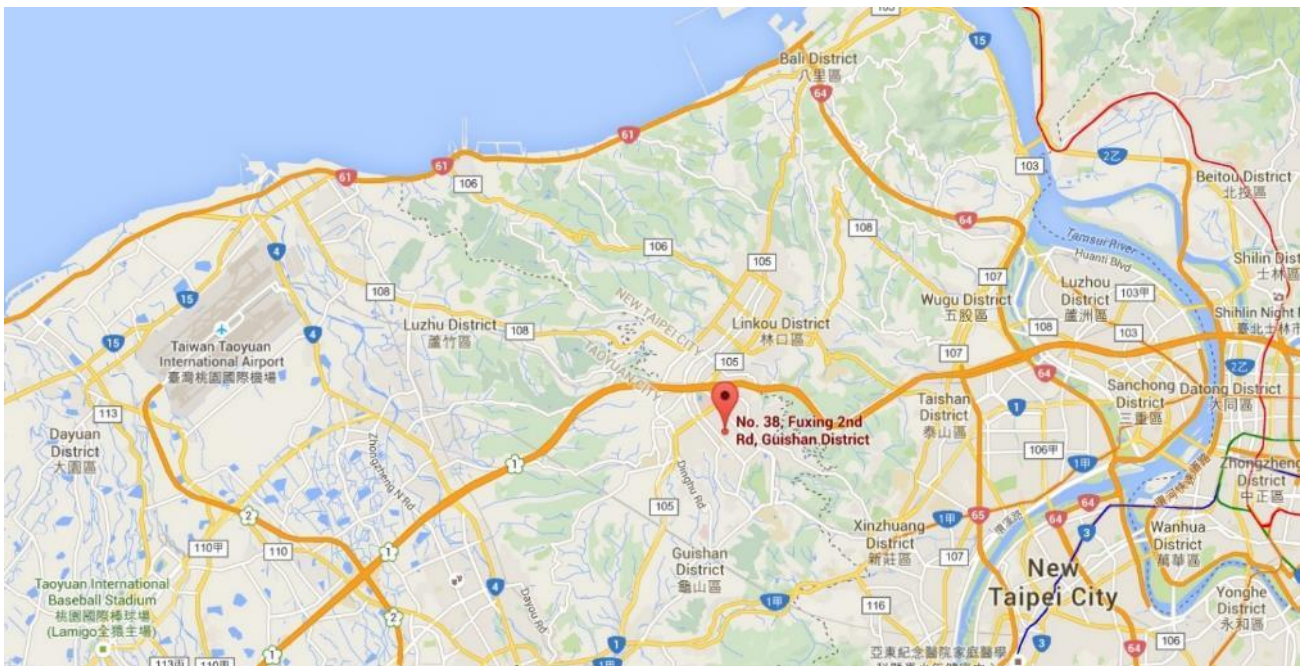

2. PRODUCT INFORMATION

2.1. Equipment Description

Product Name	Gateway
Model No.	REN-CB
Trademark	
Supports Radios Spec.	WLAN: 2.4G: 802.11b/g/n-20/n-40; 5G: 802.11a/n-20/n-40, Band1, 4 Bluetooth: V2.1+EDR/ V4.0 LE
Wi-Fi Specification	802.11 b/g/n
Frequency Range	<u>2.4GHz:</u> For 802.11b/g/n-HT20: 2412 ~ 2462 MHz For 802.11n-HT40: 2422 ~ 2452 MHz
2.4GHz Maximum Output Power	802.11b: 15.83dBm 802.11g: 19.95dBm 802.11n-HT20: 20.13dBm 802.11n-HT40: 19.37dBm
Type of Modulation	802.11b: DSSS, DBPSK, DQPSK, CCK 802.11g/n-20M/n-40M: OFDM, BPSK, QPSK, 16QAM, 64QAM
Adapter	Manufacturer: FSP TECHNOLOGY INC. M/N: FSP010-FPDN Input: 100-240V ~ 50/60Hz, 0.25A Output: 5Vdc, 2.0A

2.2. Working Frequencies for this Report

802.11b/g/n-20M

Channel	Frequency	Channel	Frequency	Channel	Frequency
01	2412 MHz	02	2417 MHz	03	2422 MHz
04	2427 MHz	05	2432 MHz	06	2437 MHz
07	2442 MHz	08	2447 MHz	09	2452 MHz
10	2457 MHz	11	2462 MHz	--	--

802.11n-HT40

Channel	Frequency	Channel	Frequency	Channel	Frequency
03	2422 MHz	04	2427 MHz	05	2432 MHz
06	2437 MHz	07	2442 MHz	08	2447 MHz
09	2452 MHz	--	--	--	--

Duty Cycle

Test Mode	Duty Cycle
802.11b	98%
802.11g	88%
802.11 n-HT20	88%
802.11 n-HT40	77%

2.3. Test Mode

Test Mode	Mode 1: Transmit by 802.11b
	Mode 2: Transmit by 802.11g
	Mode 3: Transmit by 802.11n-20M
	Mode 4: Transmit by 802.11n-40M

Note:

1. Regarding to the operation frequency, the lowest, middle and highest frequency are selected to perform the test.

2.4. Test Software

The test utility software used during testing was “wl”.

2.5. Test Configuration

This device was tested per the guidance of ANSI C63.10-2013 and DA 00-705. ANSI C63.10-2013 was used to reference the appropriate EUT setup for radiated spurious emissions testing and AC line conducted testing.

2.6. EMI Suppression Device(s)/Modifications

No EMI suppression device(s) were added and/or no modifications were made during testing.

2.7. Labeling Requirements

Per 2.1074 & 15.19; Docket 95-19

The label shall be permanently affixed at a conspicuous location on the device; instruction manual or pamphlet supplied to the user and be readily visible to the purchaser at the time of purchase. However, when the device is so small wherein placement of the label with specified statement is not practical, only the FCC ID must be displayed on the device per Section 15.19(a)(5). Please see attachment for FCC ID label and label location.

3. DESCRIPTION of TEST

3.1. Evaluation Procedure

The measurement procedures described in the American National Standard for Testing Unlicensed Wireless Devices (ANSI C63.10-2013), and the guidance provided in KDB 558074 D01v05 were used in the measurement of the device.

Deviation from measurement procedure.....None

3.2. AC Line Conducted Emissions

The line-conducted facility is located inside an 9'x4'x3' shielded enclosure. A 1m x 2m wooden table 80cm high is placed 40cm away from the vertical wall and 80cm away from the sidewall of the shielded room. Two 10kHz-30MHz, 50Ω/50uH Line-Impedance Stabilization Networks (LISNs) are bonded to the shielded room floor. Power to the LISNs is filtered by external high-current high-insertion loss power line filters. These filters attenuate ambient signal noise from entering the measurement lines. These filters are also bonded to the shielded enclosure.

The EUT is powered from one LISN and the support equipment is powered from the second LISN. All interconnecting cables more than 1 meter were shortened to a 1 meter length by non-inductive bundling (serpentine fashion) and draped over the back edge of the test table. All cables were at least 40cm above the horizontal reference ground-plane. Power cables for support equipment were routed down to the second LISN while ensuring that that cables were not draped over the second LISN.

Sufficient time for the EUT, support equipment, and test equipment was allowed in order for them to warm up to their normal operating condition. The RF output of the LISN was connected to the receiver and exploratory measurements were made to determine the frequencies producing the maximum emission from the EUT. The receiver was scanned from 150kHz to 30MHz. The detector function was set to peak mode for exploratory measurements while the bandwidth of the analyzer was set to 9kHz. The EUT, support equipment, and interconnecting cables were arranged and manipulated to maximize each emission. Each emission was also maximized by varying: power lines, the mode of operation or data exchange speed, or support equipment which determined the worst-case emission. Once the worst case emissions have been identified, the one EUT cable configuration/arrangement and mode of operation that produced these emissions are used for final measurements on the same test site. The analyzer is set to CISPR quasi-peak and average detectors with a 9kHz resolution bandwidth for final measurements.

An extension cord was used to connect to a single LISN which powered by EUT. The extension cord was calibrated with LISN, the impedance and insertion loss are compliance with the requirements as stated in ANSI C63.10-2013.

Line conducted emissions test results are shown in Section 7.8.

3.3. Radiated Emissions

The radiated test facilities consisted of an indoor 3 meter semi-anechoic chamber used for final measurements and exploratory measurements, when necessary. The measurement area is contained within the semi-anechoic chamber which is shielded from any ambient interference. For measurements above 1GHz absorbers are arranged on the floor between the turn table and the antenna mast in such a way so as to maximize the reduction of reflections. For measurements below 1GHz, the absorbers are removed. A MF Model 210SS turntable is used for radiated measurement. It is a continuously rotatable, remote controlled, metallic turntable and 2 meters (6.56 ft.) in diameter. The turn table is flush with the raised floor of the chamber in order to maintain its function as a ground plane. An 80cm high PVC support structure is placed on top of the turntable. For all measurements, the spectrum was scanned through all EUT azimuths and from 1 to 4 meter receive antenna height using a broadband antenna from 30MHz up to the upper frequency shown in 15.33(b)(1) depending on the highest frequency generated or used in the device or on which the device operates or tunes. For frequencies above 1GHz, linearly polarized double ridge horn antennas were used. For frequencies below 30MHz, a calibrated loop antenna was used. When exploratory measurements were necessary, they were performed at 1 meter test distance inside the semi-anechoic chamber using broadband antennas, broadband amplifiers, and spectrum analyzers to determine the frequencies and modes producing the maximum emissions. Sufficient time for the EUT, support equipment, and test equipment was allowed in order for them to warm up to their normal operating condition. The test set-up for frequencies below 1GHz was placed on top of the 0.8 meter high, 1 x 1.5 meter table; and test set-up for frequencies 1-40GHz was placed on top of the 1.5 meter high, 1 x 1.5 meter table. The EUT, support equipment, and interconnecting cables were arranged and manipulated to maximize each emission. Appropriate precaution was taken to ensure that all emissions from the EUT were maximized and investigated. The system configuration, clock speed, mode of operation or video resolution, if applicable, turntable azimuth, and receive antenna height was noted for each frequency found.

Final measurements were made in the semi-anechoic chamber using calibrated, linearly polarized broadband and horn antennas. The test setup was configured to the setup that produced the worst case emissions. The spectrum analyzer was set to investigate all frequencies required for testing to compare the highest radiated disturbances with respect to the specified limits. The turntable containing the EUT was rotated through 360 degrees and the height of the receive antenna was varied 1 to 4 meters and stopped at the azimuth and height producing the maximum emission. Each emission was maximized by changing the orientation of the EUT through three orthogonal planes and changing the polarity of the receive antenna, which produced the worst-case emissions. According to 3dB Beam-Width of horn antenna, the horn antenna should be always directed to the EUT when rising height.

Radiated emissions test results are shown in Section 7.6 & 7.7 .

4. ANTENNA REQUIREMENTS

Excerpt from §15.203 of the FCC Rules/Regulations:

“An intentional radiator antenna shall be designed to ensure that no antenna other than that furnished by the responsible party can be used with the device. The use of a permanently attached antenna or of an antenna that uses a unique coupling to the intentional radiator shall be considered sufficient to comply with the provisions of this section.”

- The antenna of the **Gateway**, is permanently attached.
- There are no provisions for connection to an external antenna.

Conclusion:

The EUT unit complies with the requirement of §15.203.

Antenna List

No.	Manufacturer	Part No.	Antenna Type	Peak Gain
1	ARISTOTLE ENTERPRISES	RFA-25-P327-70B-60	FPCB	-6.6dBi

5. TEST EQUIPMENT CALIBRATION DATE

Conducted Emissions – SR2

Instrument	Manufacturer	Type No.	Asset No.	Cali. Interval	Cali. Due Date
Two-Line V-Network	R&S	ENV216	MRTTWA00019	1 year	2019/3/20
Cable	Rosnol	N1C50-RG400- B1C50-500CM	MRTTWE00013	1 year	2019/5/18
EMI Test Receiver	R&S	ESR3	MRTTWA00009	1 year	2019/3/19

Radiated Emissions – AC1

Instrument	Manufacturer	Type No.	Asset No.	Cali. Interval	Cali. Due Date
Broadband TRILOG Antenna	SCHWARZBECK	VULB 9162	MRTTWA00001	1 year	2019/5/22
EMI Test Receiver	R&S	ESR3	MRTTWA00009	1 year	2019/3/19
Active Loop Antenna	Schwarzbeck	FMZB 1519B	MRTTWA00002	1 year	2019/4/24
Broadband Horn antenna	SCHWARZBECK	BBHA 9120D	MRTTWA00003	1 year	2019/4/24
Breitband Hornantenna	Schwarzbeck	BBHA 9170	MRTTWA00004	1 year	2019/4/23
Broadband Amplifier	Schwarzbeck	BBV 9721	MRTTWA00006	1 year	2019/4/23
Broadband Preampfier	SCHWARZBECK	BBV 9718	MRTTWA00005	1 year	2019/4/23
Cable	HUBERSUHNER	SF106	MRTTWA00010	1 year	2019/5/18
Cable	Rosnol	K1K50-UP0264- K1K50-4M	MRTTWA00012	1 year	2019/7/30

Conducted Test Equipment – SR2

Instrument	Manufacturer	Type No.	Asset No.	Cali. Interval	Cali. Due Date
Spectrum Analyzer	KEYSIGHT	N9010A	MRTTWA00012	1 year	2019/7/30
USB Wideband Power Sensor	KEYSIGHT	U2021XA	MRTTWA00015	1 year	2019/3/20

Test Software

Software	Version	Function
e3	9.160520a	EMI Test Software
EMI	V3	EMI Test Software

6. MEASUREMENT UNCERTAINTY

Where relevant, the following test uncertainty levels have been estimated for tests performed on the EUT as specified in CISPR 16-4-2. This uncertainty represents an expanded uncertainty expressed at approximately the 95% confidence level using a coverage factor of $k = 2$.

AC Conducted Emission Measurement – SR2
Measuring Uncertainty for a Level of Confidence of 95% ($U=2Uc(y)$): 150kHz~30MHz: 2.42dB
Conducted Measurement– SR1
Measuring Uncertainty for a Level of Confidence of 95% ($U=2Uc(y)$): 1.3dB
Radiated Emission Measurement – AC1
Measuring Uncertainty for a Level of Confidence of 95% ($U=2Uc(y)$): Horizontal: 9K~30MHz: 4.14dB 30MHz~1GHz: 4.22dB 1GHz~40GHz: 4.05dB Vertical: 9K~30MHz: 4.14dB 30MHz~1GHz: 3.37dB 1GHz~40GHz: 4.08dB

7. TEST RESULT

7.1. Summary

Product Name: Gateway
FCC Classification: (DTS) Digital Transmission System
Data Rate(s) Tested: 1Mbps ~ 11Mbps (b); 6Mbps ~ 54Mbps (g);
6.5/7.2Mbps ~ 65/72.2Mbps (n-20M);
13.5/15Mbps ~ 135/150Mbps (n-40M)

FCC Part Section(s)	Test Description	Test Limit	Test Condition	Test Result	Reference
15.247(a)(2)	6dB Bandwidth	$\geq 500\text{kHz}$	Conducted	Pass	Section 7.2
15.247(b)(3)	Output Power	$\leq 30.00\text{dBm}$		Pass	Section 7.3
15.247(e)	Power Spectral Density	$\leq 8.00\text{dBm}/3\text{kHz}$		Pass	Section 7.4
15.247(d)	Out-of-Band Emissions	Conducted $\geq 20\text{dBc}$		Pass	Section 7.5
15.205 15.209	Spurious Emission	< FCC 15.209 limits	Radiated	Pass	Section 7.6
15.205 15.209	Band Edge Measurement	$\cong 74\text{dBuV/m(Peak)}$ $\cong 54\text{dBuV/m(Average)}$		Pass	Section 7.7
15.207	AC Conducted Emissions 150kHz - 30MHz	< FCC 15.207 limits	Line Conducted	Pass	Section 7.8

Notes:

- 1) All modes of operation and data rates were investigated. For radiated emission test, every axis (X, Y, Z) was also verified. The test results shown in the following sections represent the worst case emissions.
- 2) The analyzer plots shown in this section were all taken with a correction table loaded into the analyzer. The correction table was used to account for the losses of the cables and attenuators used as part of the system to connect the EUT to the analyzer at all frequencies of interest.
- 3) All antenna port conducted emissions testing was performed on a test bench with the antenna port of the EUT connected to the spectrum analyzer through calibrated cables and attenuators.

7.2. 6dB Bandwidth Measurement

7.2.1. Test Limit

The minimum 6dB bandwidth shall be at least 500 kHz.

7.2.2. Test Procedure used

KDB 558074 D01v05- Section 8.2 Option 2

7.2.3. Test Setting

1. The Spectrum's automatic bandwidth measurement capability was used to perform the 6dB bandwidth measurement. The "X" dB bandwidth parameter was set to $X = 6$. The bandwidth measurement was not influenced by any intermediate power nulls in the fundamental emission.
2. Set RBW = 100 kHz
3. VBW $\geq 3 \times$ RBW
4. Detector = Peak
5. Trace mode = max hold
6. Sweep = auto couple
7. Allow the trace was allowed to stabilize

7.2.4. Test Setup

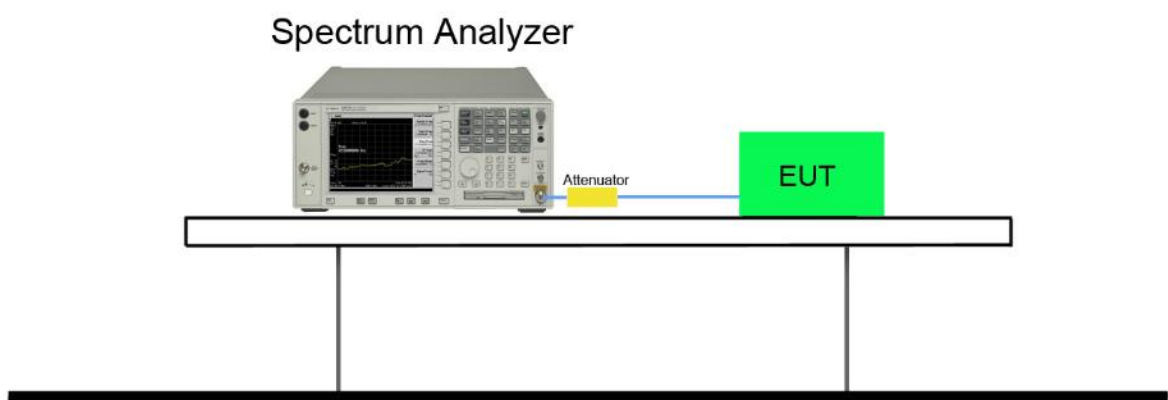

7.2.5. Test Result

Test Mode	Channel No.	Frequency (MHz)	6dB Bandwidth (MHz)	99% Bandwidth (MHz)	Limit (MHz)	Result
802.11b	01	2412	8.096	12.085	≥ 0.5	Pass
802.11b	06	2437	8.094	12.080	≥ 0.5	Pass
802.11b	11	2462	8.101	12.051	≥ 0.5	Pass
802.11g	01	2412	15.140	16.349	≥ 0.5	Pass
802.11g	06	2437	15.130	16.346	≥ 0.5	Pass
802.11g	11	2462	15.130	16.334	≥ 0.5	Pass
802.11n-20M	01	2412	15.150	17.506	≥ 0.5	Pass
802.11n-20M	06	2437	15.140	17.512	≥ 0.5	Pass
802.11n-20M	11	2462	15.120	17.496	≥ 0.5	Pass
802.11n-40M	03	2422	35.190	35.871	≥ 0.5	Pass
802.11n-40M	06	2437	35.160	35.863	≥ 0.5	Pass
802.11n-40M	09	2452	35.180	35.874	≥ 0.5	Pass

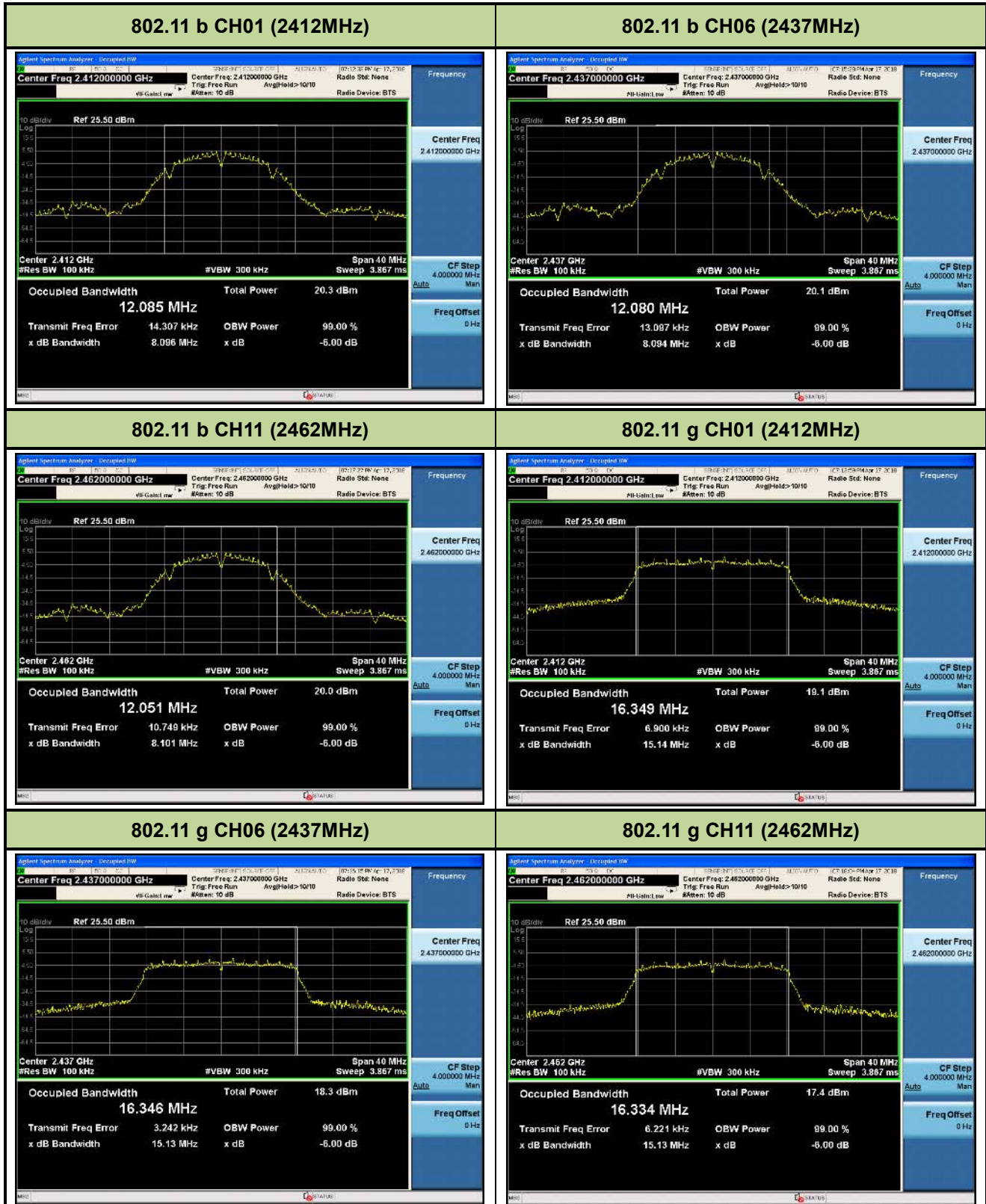

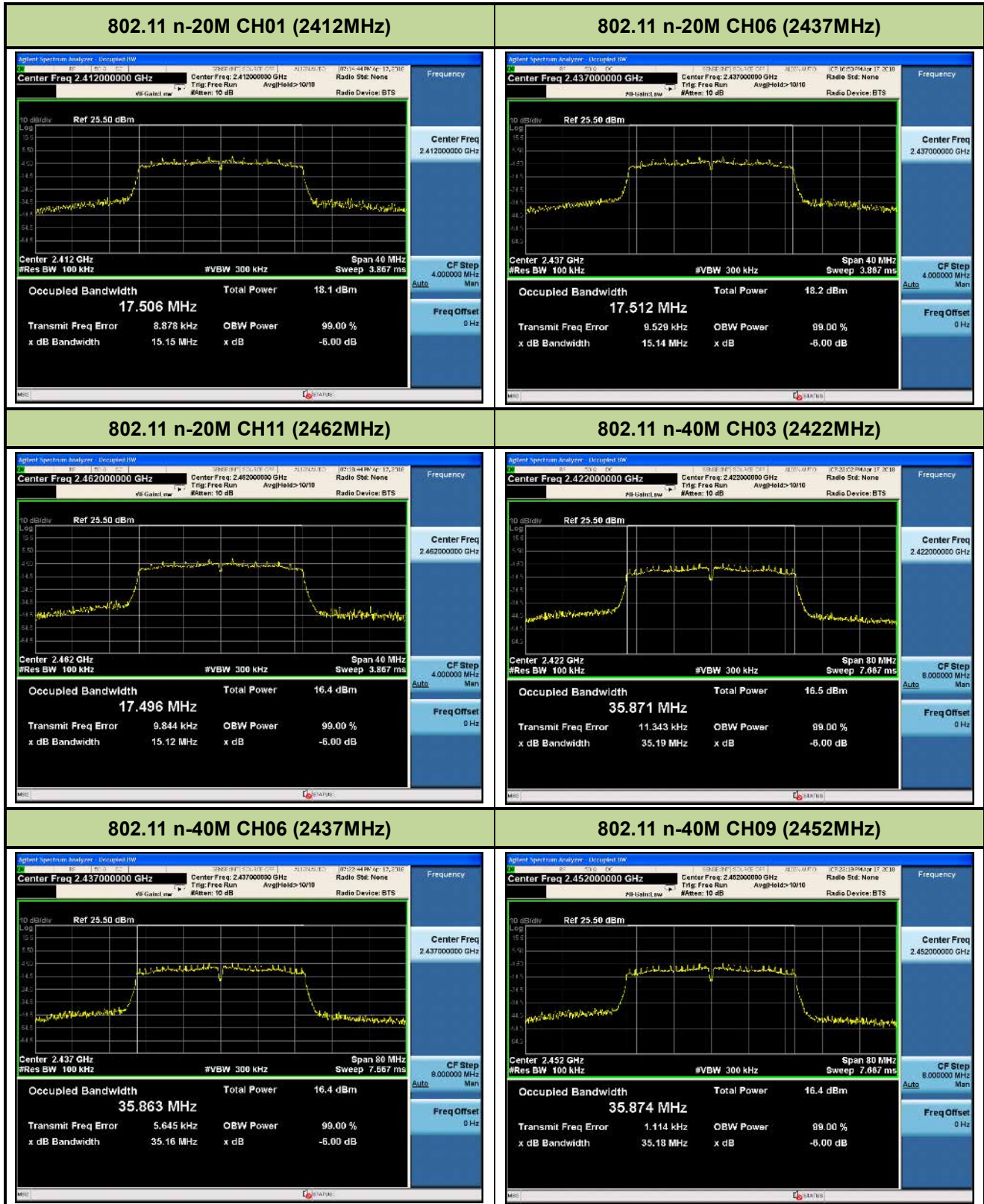

7.3. Output Power Measurement

7.3.1. Test Limit

The maximum out power shall be less 1 Watt (30dBm).

7.3.2. Test Procedure Used

KDB 558074 D01v05 - Section 9.1.2 & 9.2.3.2

7.3.3. Test Setting

Peak Power Measurement

The maximum peak conducted output power may be measured using a broadband peak RF power meter. The power meter shall have a video bandwidth that is greater than or equal to the DTS bandwidth and shall utilize a fast-responding diode detector.

Average Power Measurement

Average power measurements were performed only when the EUT was transmitting at its maximum power control level using a broadband power meter with a pulse sensor. The power meter implemented triggering and gating capabilities which were set up such that power measurements were recorded only during the ON time of the transmitter. The trace was averaged over 100 traces to obtain the final measured average power.

7.3.4. Test Setup

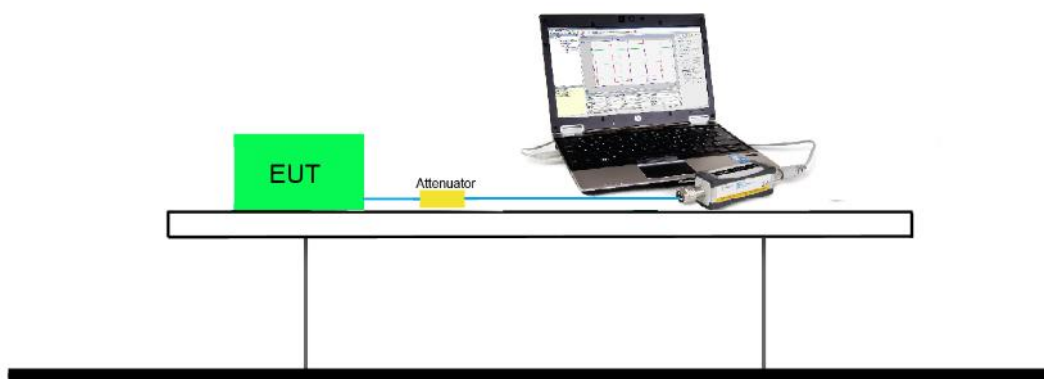

7.3.5. Test Result of Output Power

2.4GHz 802.11b RF Output Power (dBm)											
Channel No.	Frequency (MHz)	Average Power For different Data Rate (Mbps)				Peak Power	Required Limit				
		1	2	5.5	11						
01	2412	12.70	--	--	--	15.83	1Watt= 30 dBm				
06	2437	12.79	12.71	12.67	12.61	15.78	1Watt= 30 dBm				
11	2462	12.52	--	--	--	15.71	1Watt= 30 dBm				
2.4GHz 802.11g RF Output Power (dBm)											
Channel No.	Frequency (MHz)	Average Power For different Data Rate (Mbps)								Peak Power	Required Limit
		6	9	12	18	24	36	48	54		
01	2412	12.20	--	--	--	--	--	--	--	19.64	1Watt= 30 dBm
06	2437	11.40	11.36	11.30	11.22	11.17	11.10	11.06	11.03	19.95	1Watt= 30 dBm
11	2462	10.67	--	--	--	--	--	--	--	19.55	1Watt= 30 dBm
2.4GHz 802.11n-20M RF Output Power (dBm)											
Channel No.	Frequency (MHz)	Average Power For different Data Rate (Mbps)								Peak Power	Required Limit
		MCS0	MCS1	MCS2	MCS3	MCS4	MCS5	MCS6	MCS7		
01	2412	11.31	--	--	--	--	--	--	--	18.86	1Watt= 30 dBm
06	2437	11.54	11.51	11.48	11.46	11.43	11.40	11.34	11.30	20.13	1Watt= 30 dBm
11	2462	9.54	--	--	--	--	--	--	--	19.61	1Watt= 30 dBm
2.4GHz 802.11n-40M RF Output Power (dBm)											
Channel No.	Frequency (MHz)	Average Power For different Data Rate (Mbps)								Peak Power	Required Limit
		MCS0	MCS1	MCS2	MCS3	MCS4	MCS5	MCS6	MCS7		
03	2422	9.97	--	--	--	--	--	--	--	19.37	1Watt= 30 dBm
06	2437	10.06	10.06	10.05	10.05	10.05	10.04	10.03	10.03	19.21	1Watt= 30 dBm
09	2452	10.03	--	--	--	--	--	--	--	17.86	1Watt= 30 dBm

Note: Output power = Reading value on power meter + duty cycle factor + cable loss °

7.4. Power Spectral Density Measurement

7.4.1. Test Limit

The maximum permissible power spectral density is 8dBm in any 3 kHz band.

7.4.2. Test Procedure Used

KDB 558074 D01v05 - Section 10.2 Method PKPSD

7.4.3. Test Setting

This procedure shall be used if maximum peak conducted output power was used to demonstrate compliance, and is optional if the maximum conducted (average) output power was used to demonstrate compliance.

- a) Set analyzer center frequency to DTS channel center frequency.
- b) Set the span to 1.5 times the DTS bandwidth.
- c) Set the RBW to: 3 kHz.
- d) Set the VBW $\geq 3 \times$ RBW.
- e) Detector = peak.
- f) Sweep time = auto couple.
- g) Trace mode = max hold.
- h) Allow trace to fully stabilize.
- i) Use the peak marker function to determine the maximum amplitude level within the RBW.

7.4.4. Test Setup

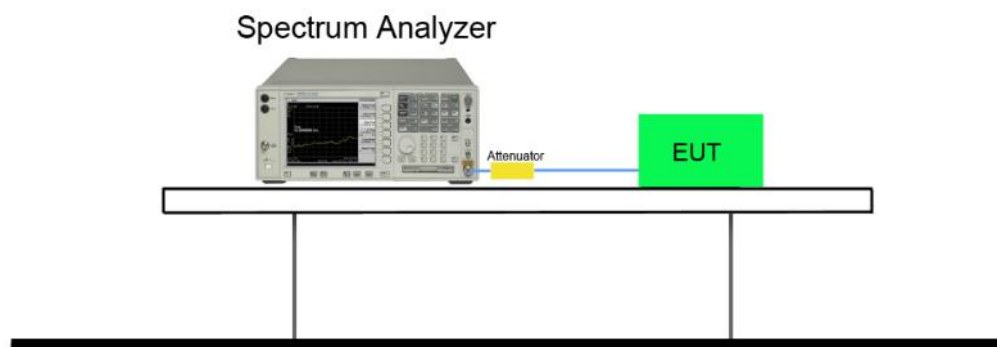

7.4.5. Test Result

Test Mode	Channel No.	Freq. (MHz)	PSD (dBm)	Limit (dBm)	Result
11b	1	2412	-7.500	≤ 8	Pass
11b	6	2437	-8.247	≤ 8	Pass
11b	11	2462	-8.586	≤ 8	Pass
11g	1	2412	-12.270	≤ 8	Pass
11g	6	2437	-12.443	≤ 8	Pass
11g	11	2462	-13.943	≤ 8	Pass
11n-20M	1	2412	-13.356	≤ 8	Pass
11n-20M	6	2437	-13.413	≤ 8	Pass
11n-20M	11	2462	-15.354	≤ 8	Pass
11n-40M	3	2422	-17.312	≤ 8	Pass
11n-40M	6	2437	-18.187	≤ 8	Pass
11n-40M	9	2452	16.426	≤ 8	Pass

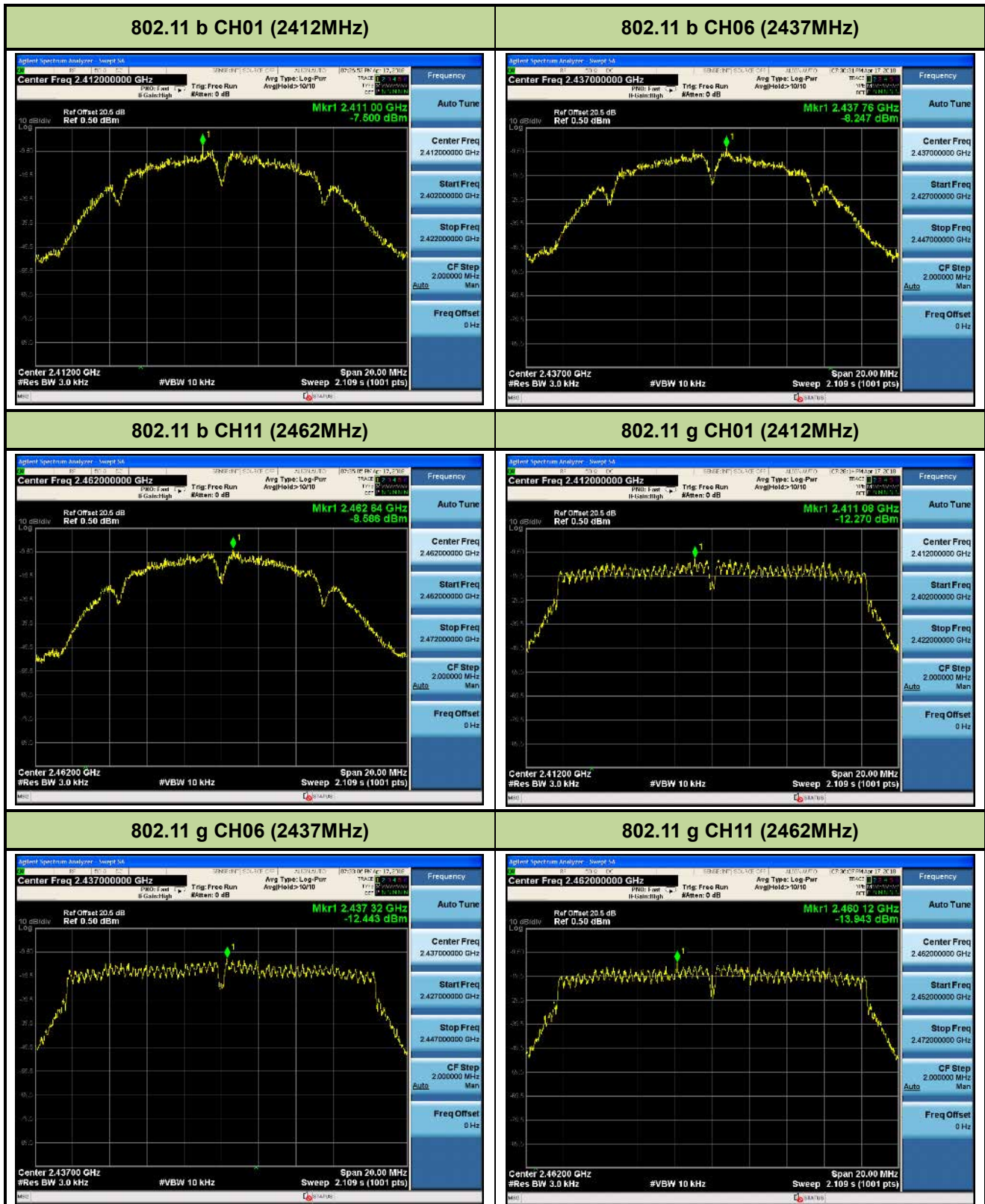

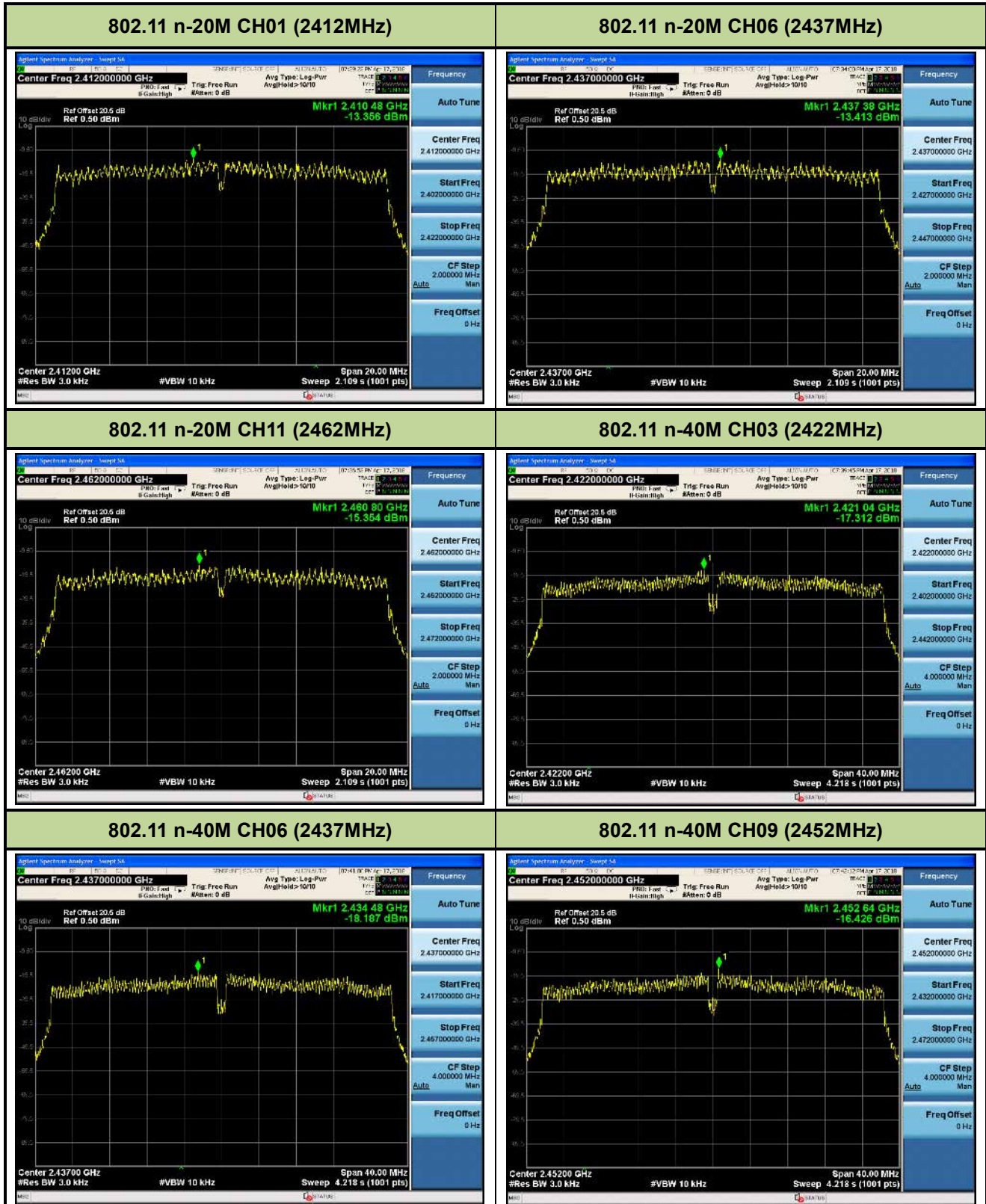

7.5. Out-of-Band Spurious Emissions Emissions Measurement

7.5.1. Test Limit

In any 100 kHz bandwidth outside the frequency band in which the spread spectrum or digitally modulated intentional radiator is operating, the radio frequency power that is produced by the intentional radiator shall be at least 20 dB below that in the 100 kHz bandwidth within the band that contains the highest level of the desired power, based on RF conducted measurement, provided the transmitter demonstrates compliance with the peak conducted power limits.

7.5.2. Test Procedure Used

KDB 558074 D01v05- Section 11.1 & 11.2

7.5.3. Test Setting

- (a) Set instrument center frequency to DTS channel center frequency
- (b) Set the span to ≥ 1.5 times the DTS bandwidth
- (c) Set the RBW = 100 kHz
- (d) Set the VBW $\geq 3 \times$ RBW
- (e) Detector = peak
- (f) Sweep time = auto couple
- (g) Trace mode = max hold
- (h) Allow trace to fully stabilize

7.5.4. Test Setup

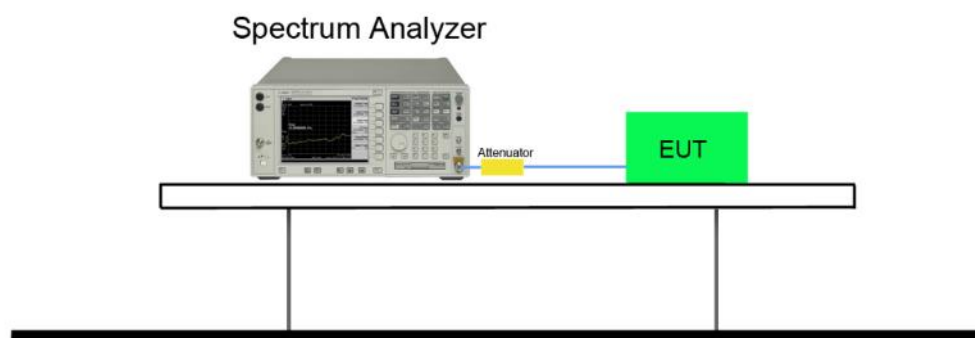

7.5.5. Test Result

Test Mode	Channel No.	Frequency (MHz)	Limit	Result
802.11b	01	2412	20dBc	Pass
802.11b	06	2437	20dBc	Pass
802.11b	11	2462	20dBc	Pass
802.11g	01	2412	20dBc	Pass
802.11g	06	2437	20dBc	Pass
802.11g	11	2462	20dBc	Pass
802.11n-20M	01	2412	20dBc	Pass
802.11n-20M	06	2437	20dBc	Pass
802.11n-20M	11	2462	20dBc	Pass
802.11n-40M	03	2422	20dBc	Pass
802.11n-40M	06	2437	20dBc	Pass
802.11n-40M	09	2452	20dBc	Pass

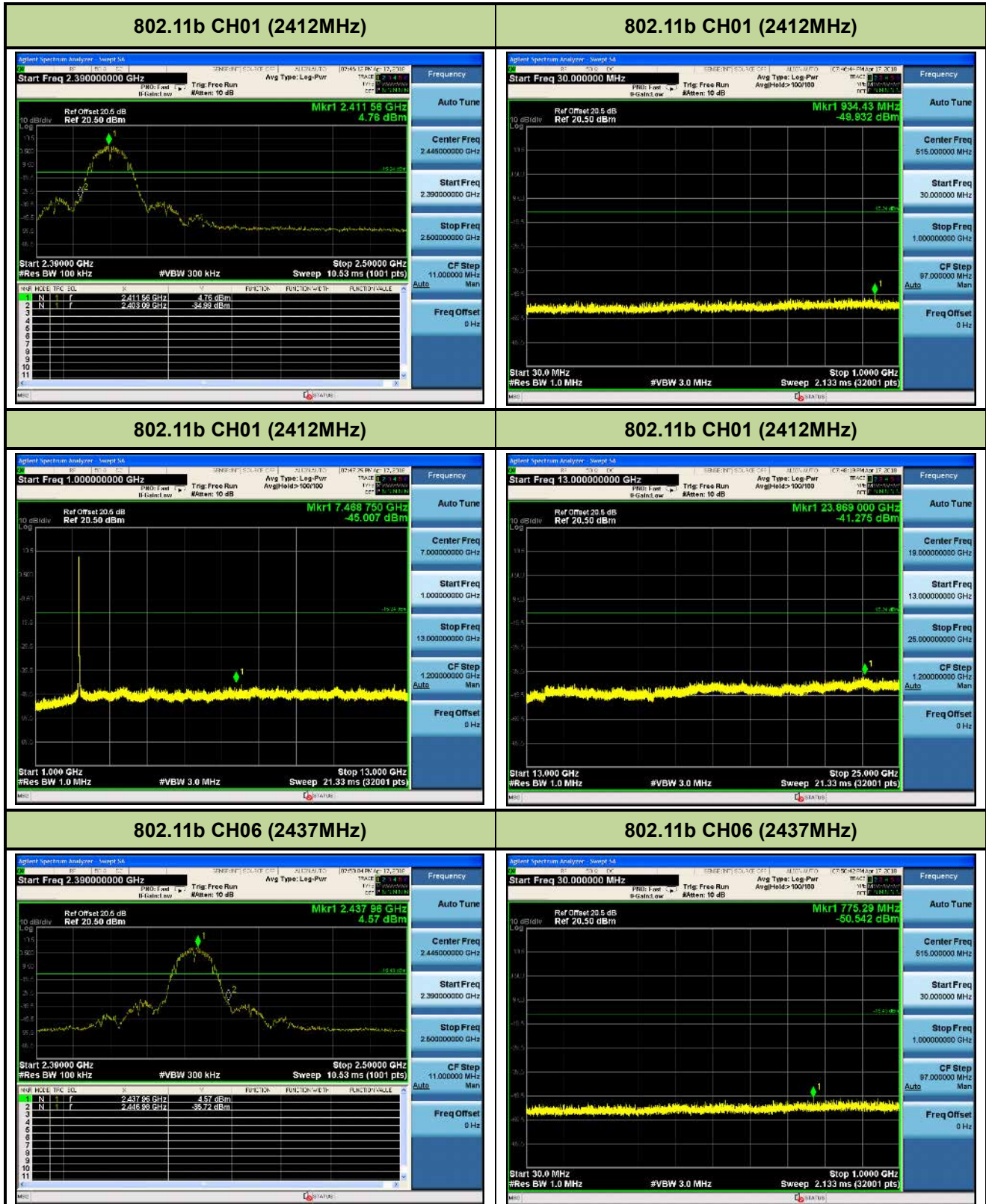

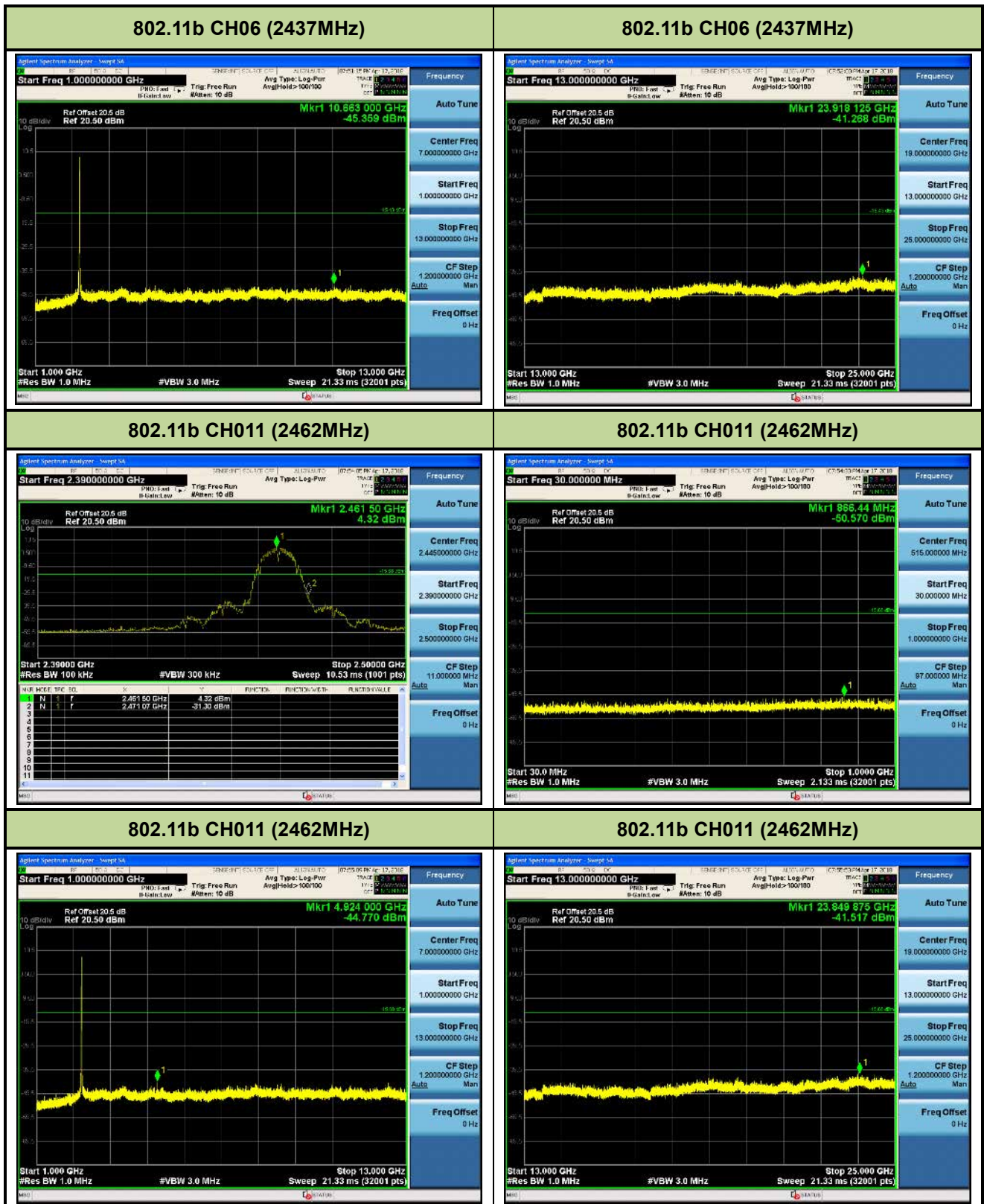

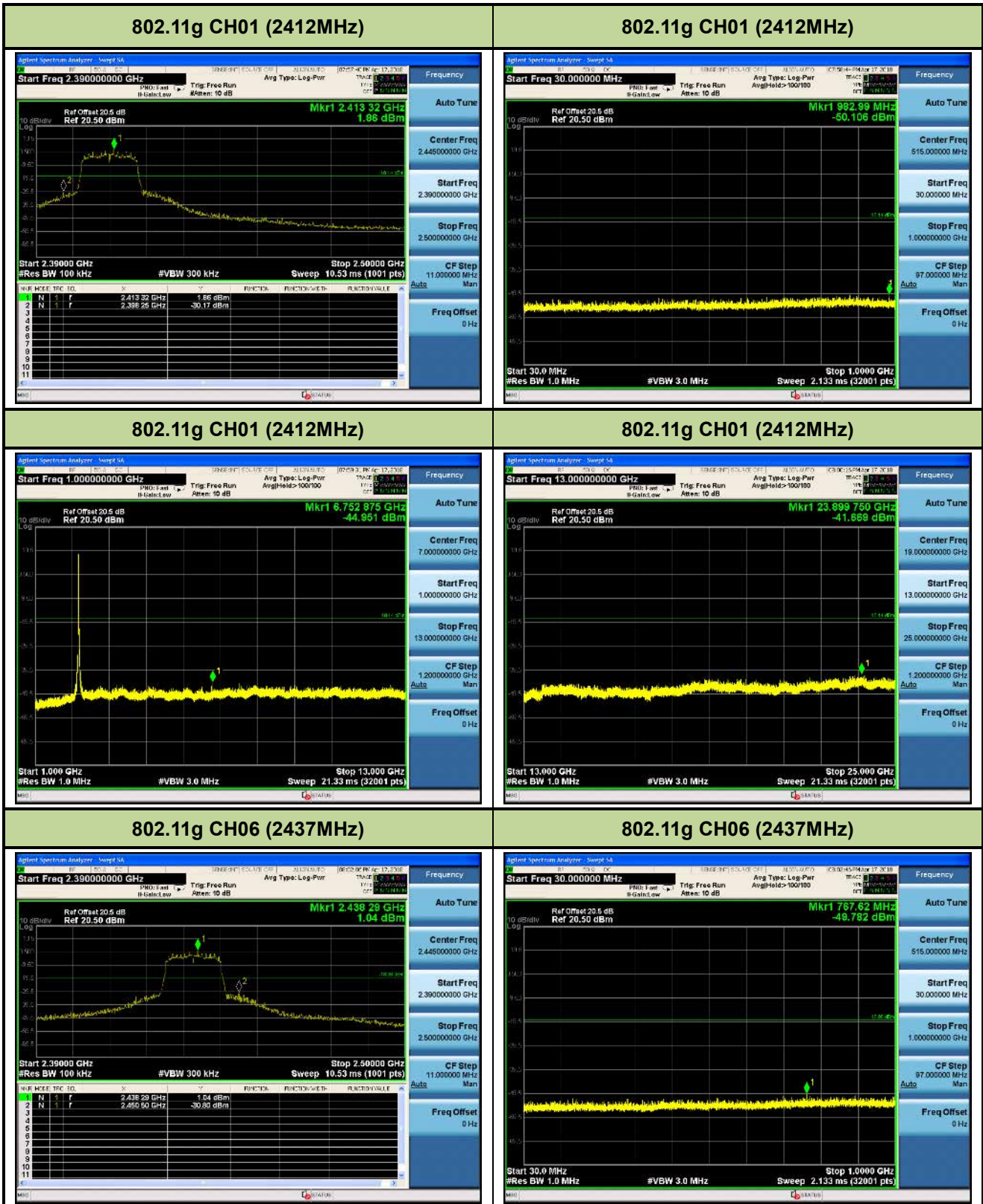

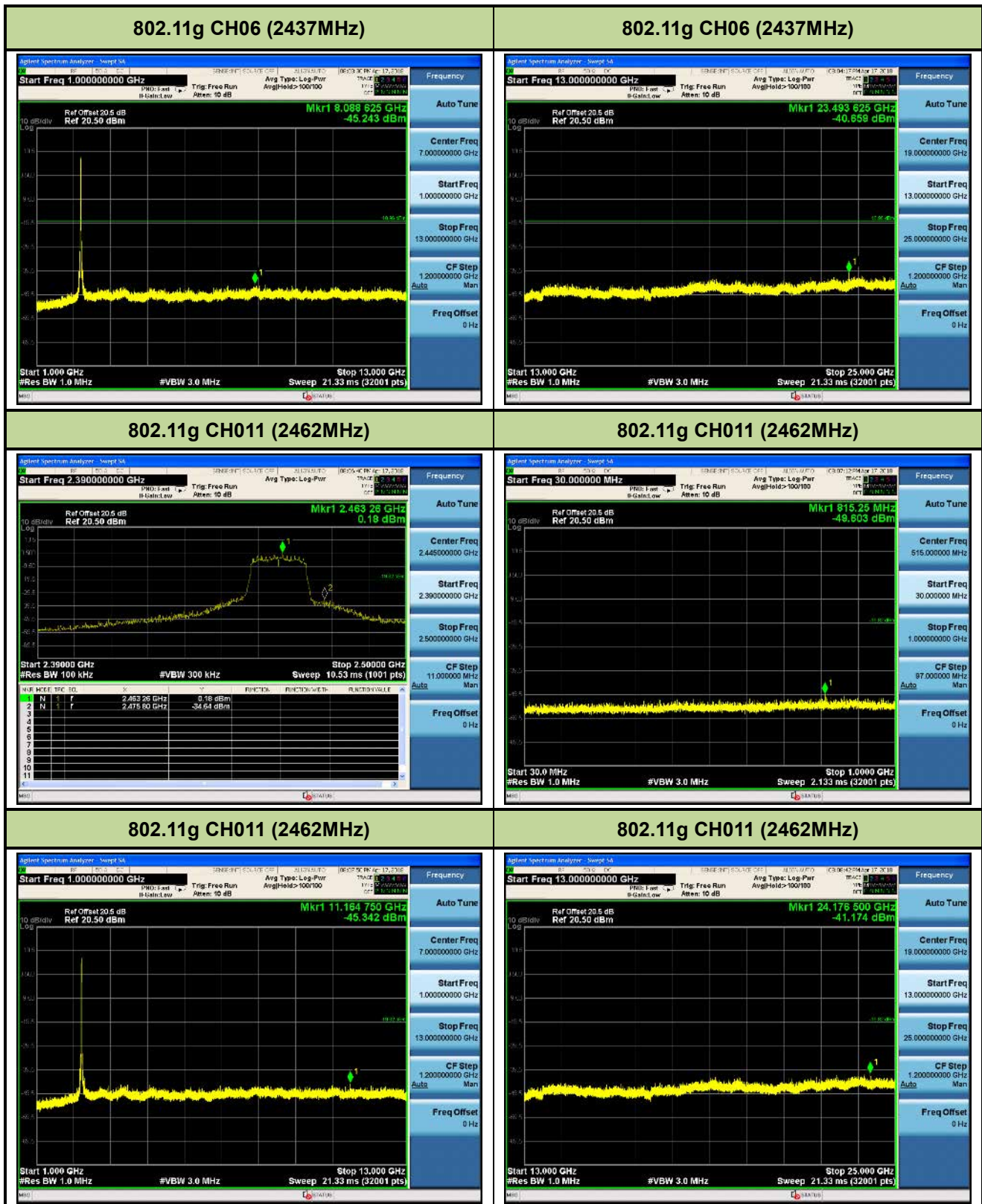

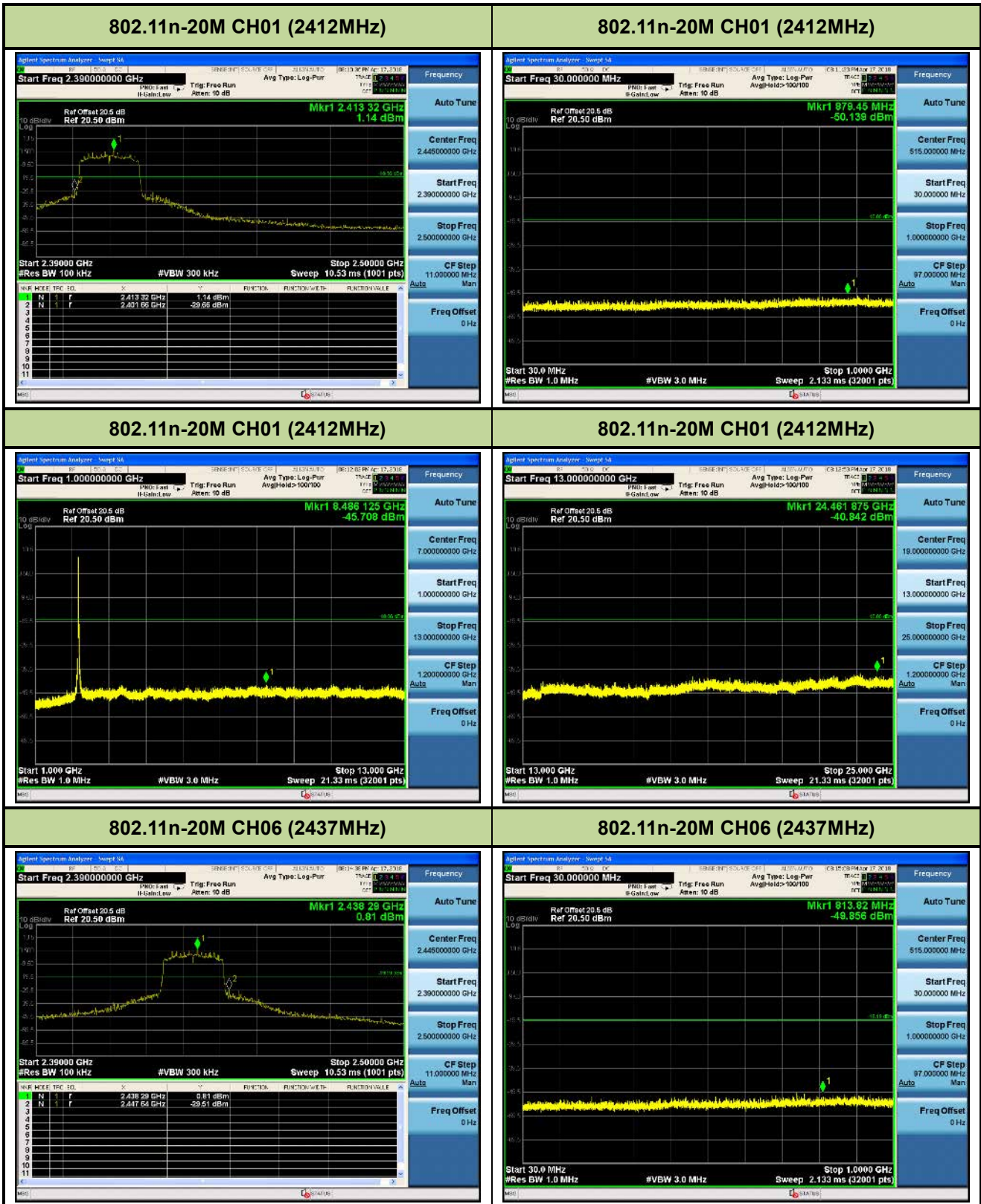

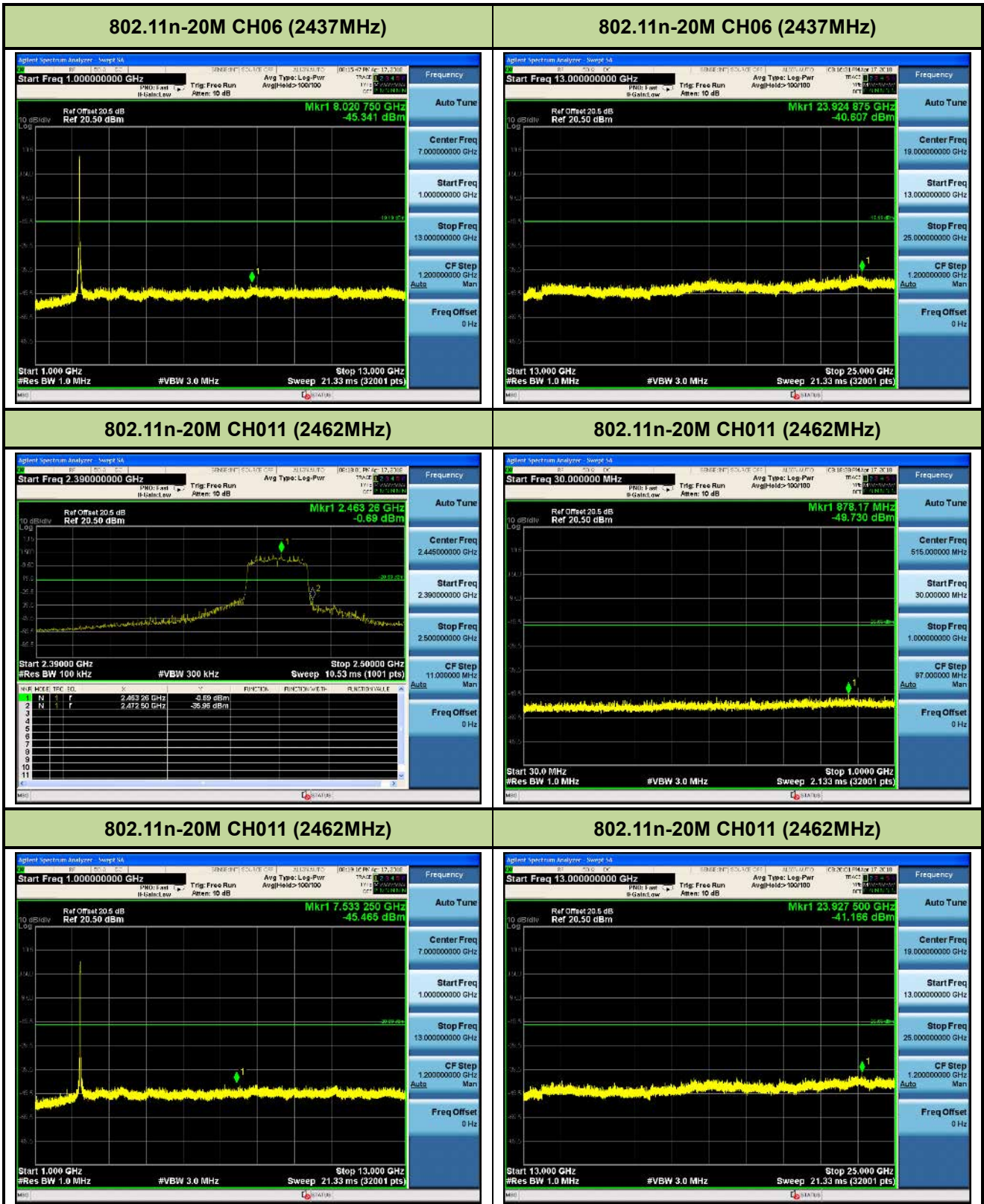

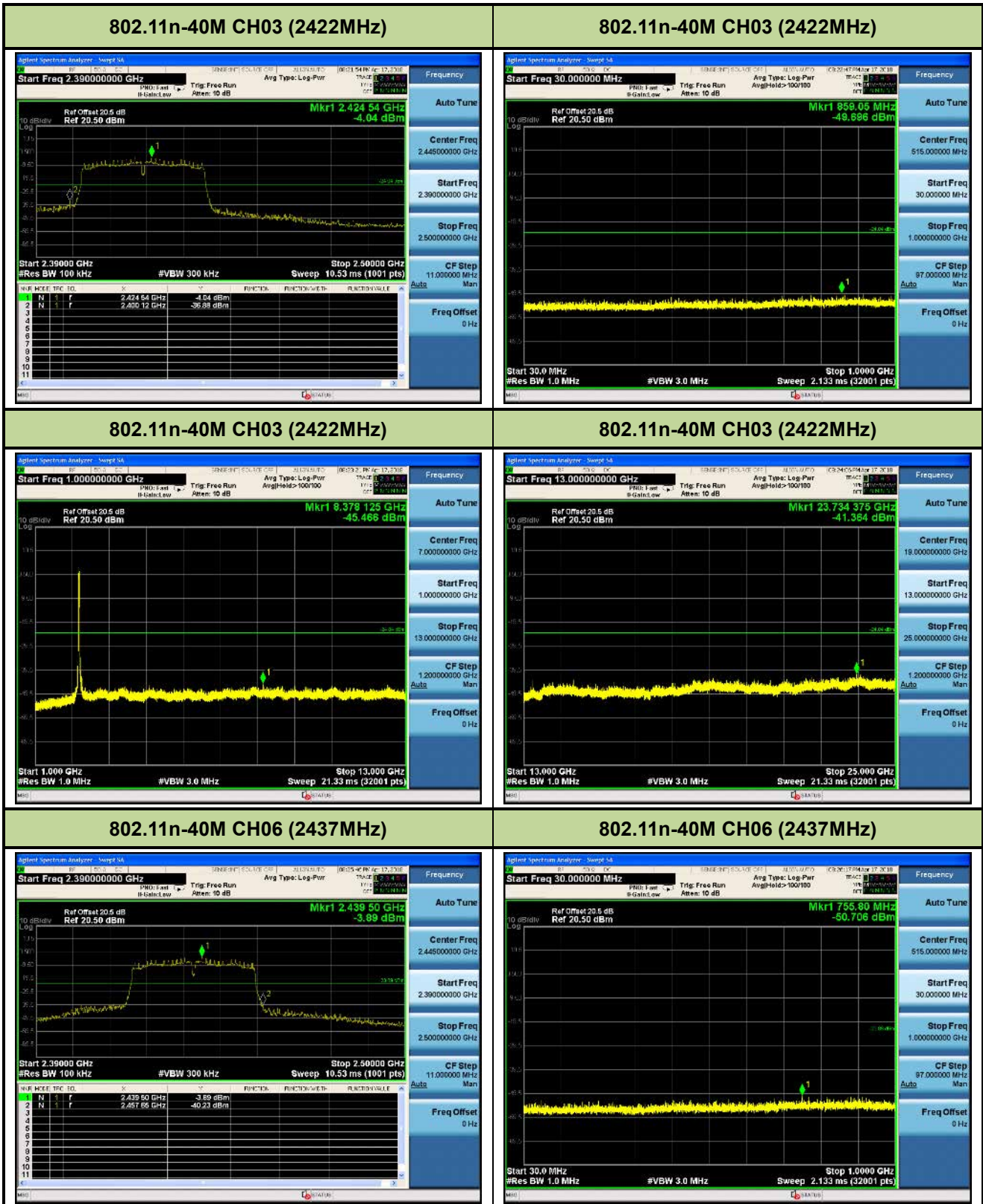

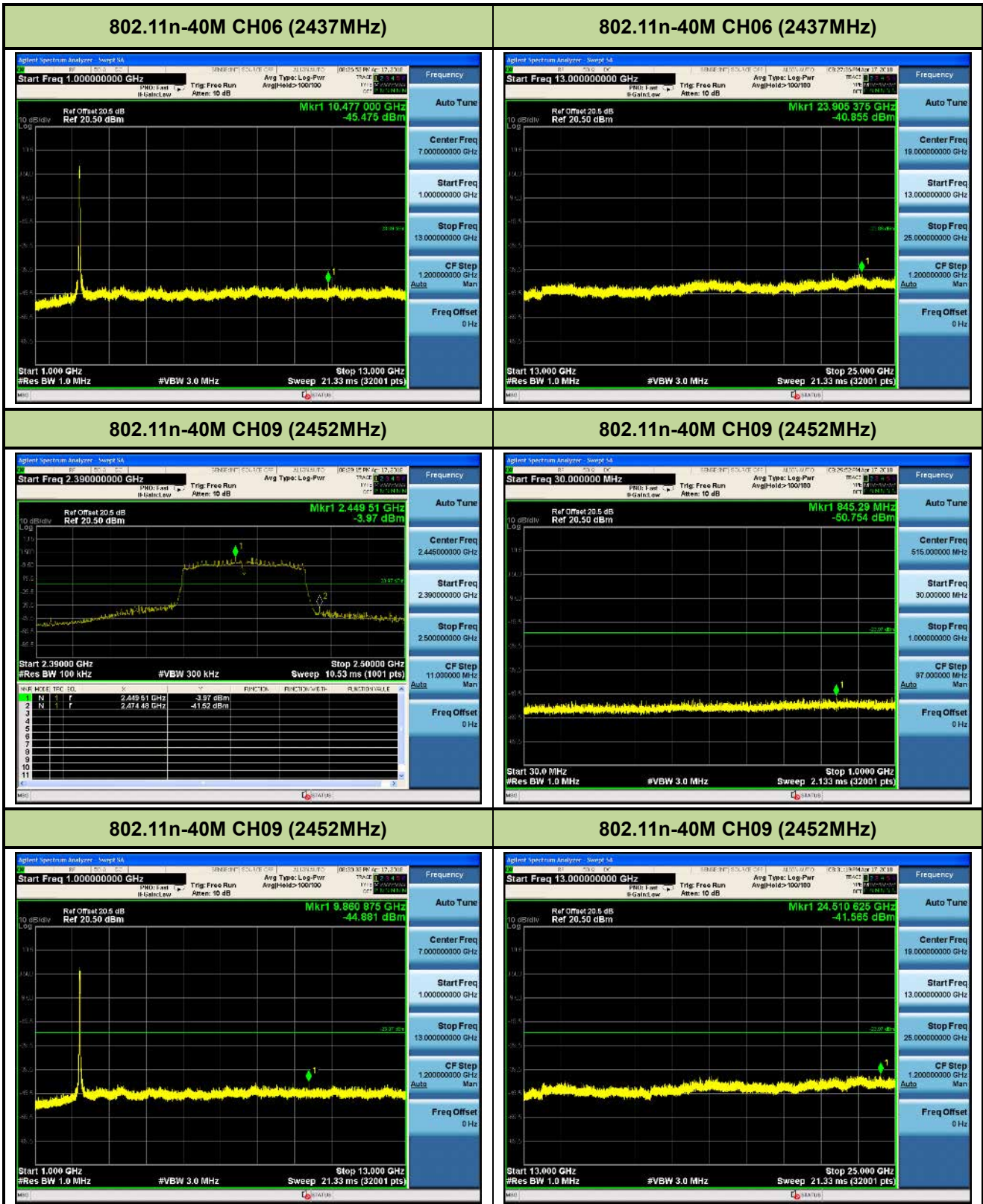

7.6. Radiated Spurious Emission Measurement

7.6.1. Test Limit

All out of band emissions appearing in a restricted band as specified in Section 15.205 of the Title 47 CFR must not exceed the limits shown in Table per Section 15.209.

FCC Part 15 Subpart C Paragraph 15.209		
Frequency [MHz]	Field Strength [V/m]	Measured Distance [Meters]
0.009 - 0.490	2400/F (kHz)	300
0.490 - 1.705	24000/F (kHz)	30
1.705 - 30	30	30
30 - 88	100	3
88 - 216	150	3
216 - 960	200	3
Above 960	500	3

7.6.2. Test Procedure Used

KDB 558074 D01v05- Section 12.2.3 (quasi-peak measurements)

KDB 558074 D01v05- Section 12.2.4 (peak power measurements)

KDB 558074 D01v05- Section 12.2.5 (average power measurements)

7.6.3. Test Setting

Peak Field Strength Measurements

1. Analyzer center frequency was set to the frequency of the radiated spurious emission of interest
2. RBW = as specified in Table 1
3. VBW = 3MHz
4. Detector = peak
5. Sweep time = auto couple

6. Trace mode = max hold

7. Trace was allowed to stabilize

Table 1 - RBW as a function of frequency

Frequency	RBW
9 ~ 150 kHz	200 ~ 300 Hz
0.15 ~ 30 MHz	9 ~ 10 kHz
30 ~ 1000 MHz	100 ~ 120 kHz
> 1000 MHz	1 MHz

Average Field Strength Measurements

1. Analyzer center frequency was set to the frequency of the radiated spurious emission of interest

2. RBW = 1MHz

3. VBW \geq 1/T

4. De As an alternative, the instrument may be set to linear detector mode. Ensure that video filtering is applied in linear voltage domain (rather than in a log or dB domain). Some instruments require linear display mode in order to accomplish this. Others have a setting for Average-VBW Type, which can be set to “Voltage” regardless of the display mode

5. Detector = Peak

6. Sweep time = auto

7. Trace mode = max hold

8. Allow max hold to run for at least 50 times (1/duty cycle) traces

7.6.4. Test Setup

9kHz ~ 30MHz Test Setup:

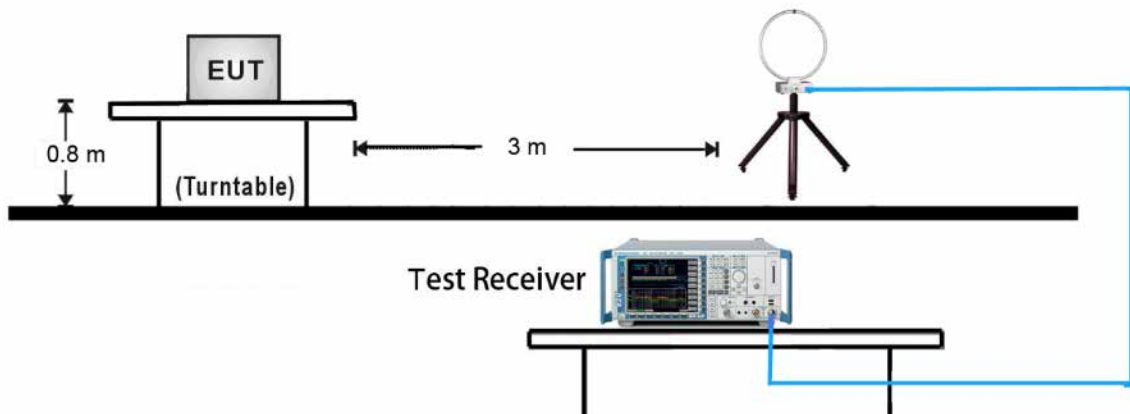

30MHz ~ 1GHz Test Setup:

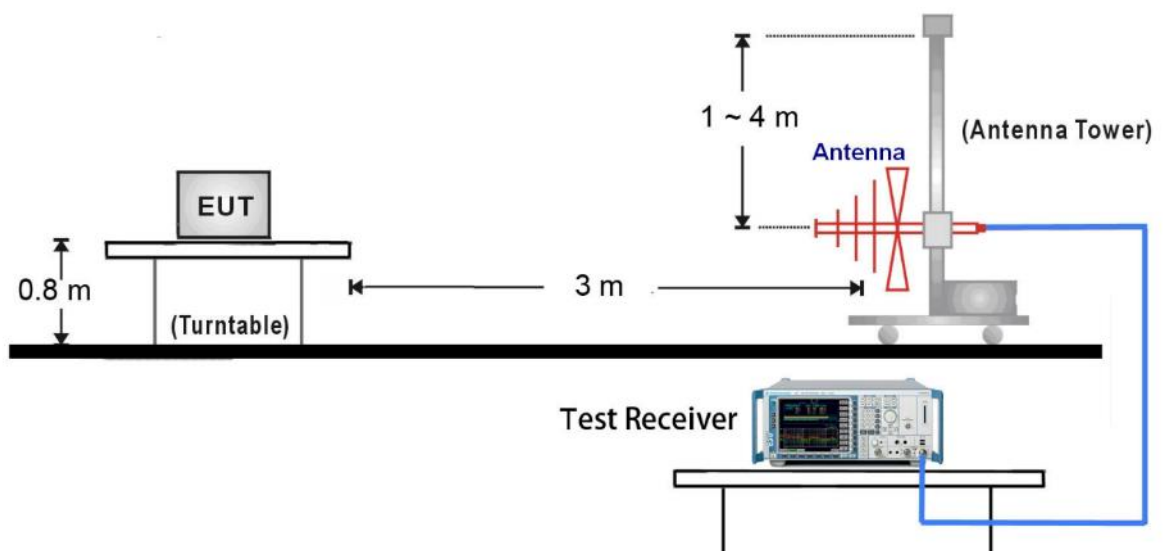

1GHz ~ 18GHz Test Setup:

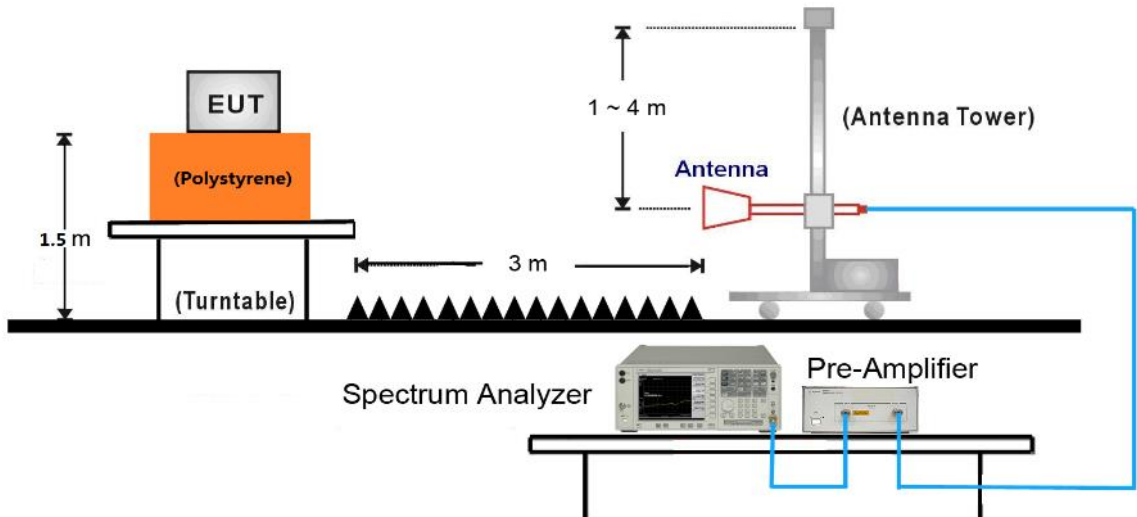

18GHz ~25GHz Test Setup:

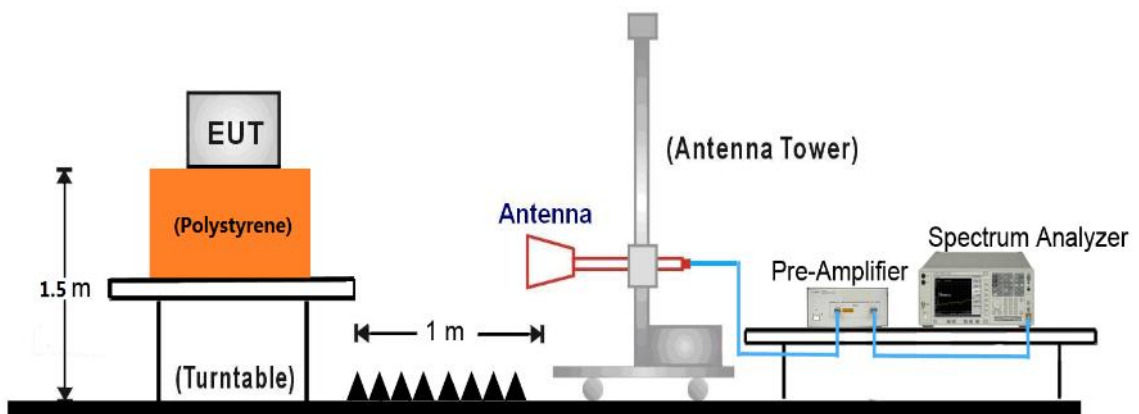

7.6.5. Test Result

EUT	Gateway	Test Date	2018/4/13
Factor	VULB 9162 (30MHz~8GHz)	Temp. / Humidity	25°C / 60%
Polarity	Horizontal	Site / Engineer	AC1 / Peter
Test Mode	MODE3 -CH06	Test Voltage	AC 120V/60Hz

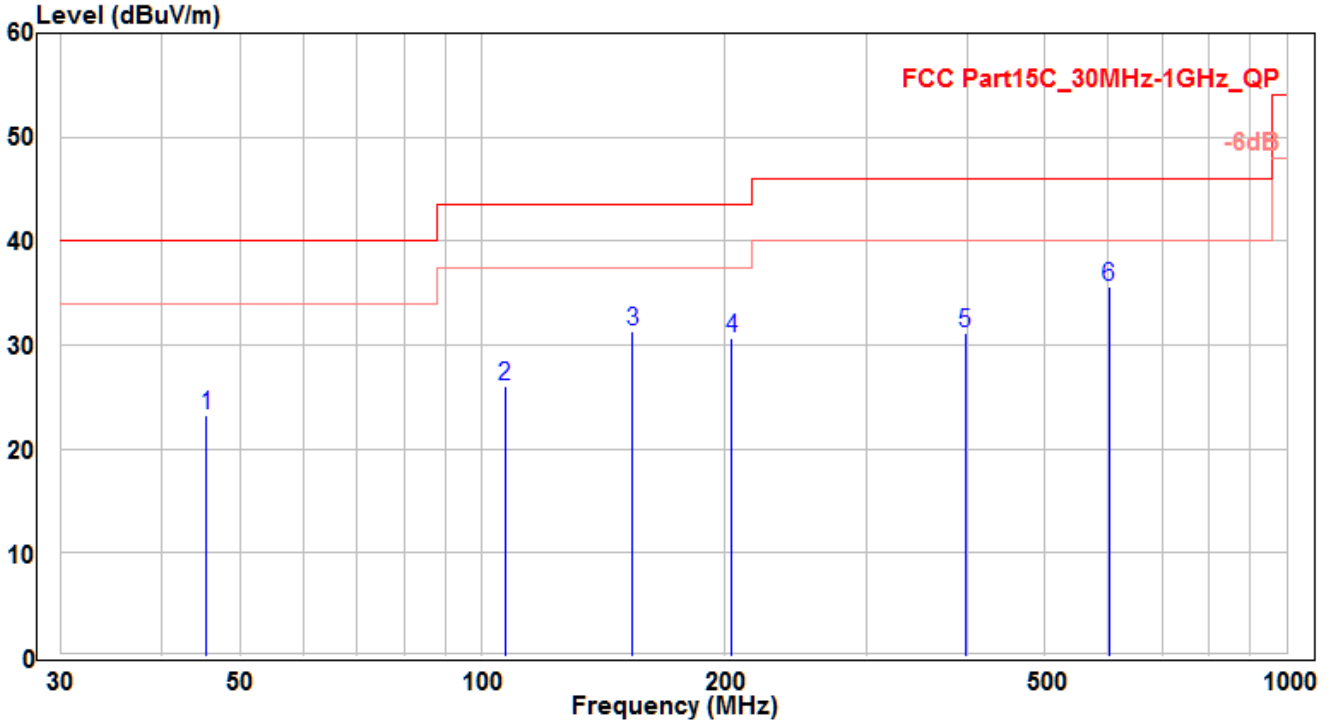

No	Frequency (MHz)	Reading (dBUV)	C.F (dB)	Measurement (dBUV/m)	Margin (dB)	Limit (dBUV/m)	Height (cm)	Angle (deg)	Remark (QP/PK/AV)
1	45.459	1.76	21.42	23.18	-16.82	40	150	290	QP
2	106.842	7.07	18.99	26.06	-17.44	43.5	100	210	QP
3	153.887	15.39	16.01	31.4	-12.1	43.5	200	400	QP
4	204.085	11.77	18.97	30.74	-12.76	43.5	190	365	QP
5	398.418	7.02	24.14	31.16	-14.84	46	175	120	QP
6	* 601.3	7.86	27.72	35.58	-10.42	46	125	-40	QP

Note:

- "*" means this data is the worst emission level.
- C.F (Correction Factor) = Antenna Factor (dB)+ Cable Loss (dB).
- Measurement (dBUV/m) = Reading(dBUV) + C.F (Correction Factor).

EUT	Gateway	Test Date	2018/4/13
Factor	VULB 9162 (30MHz~8GHz)	Temp. / Humidity	25°C / 60%
Polarity	Vertical	Site / Engineer	AC1 / Peter
Test Mode	MODE3 -CH06	Test Voltage	AC 120V/60Hz

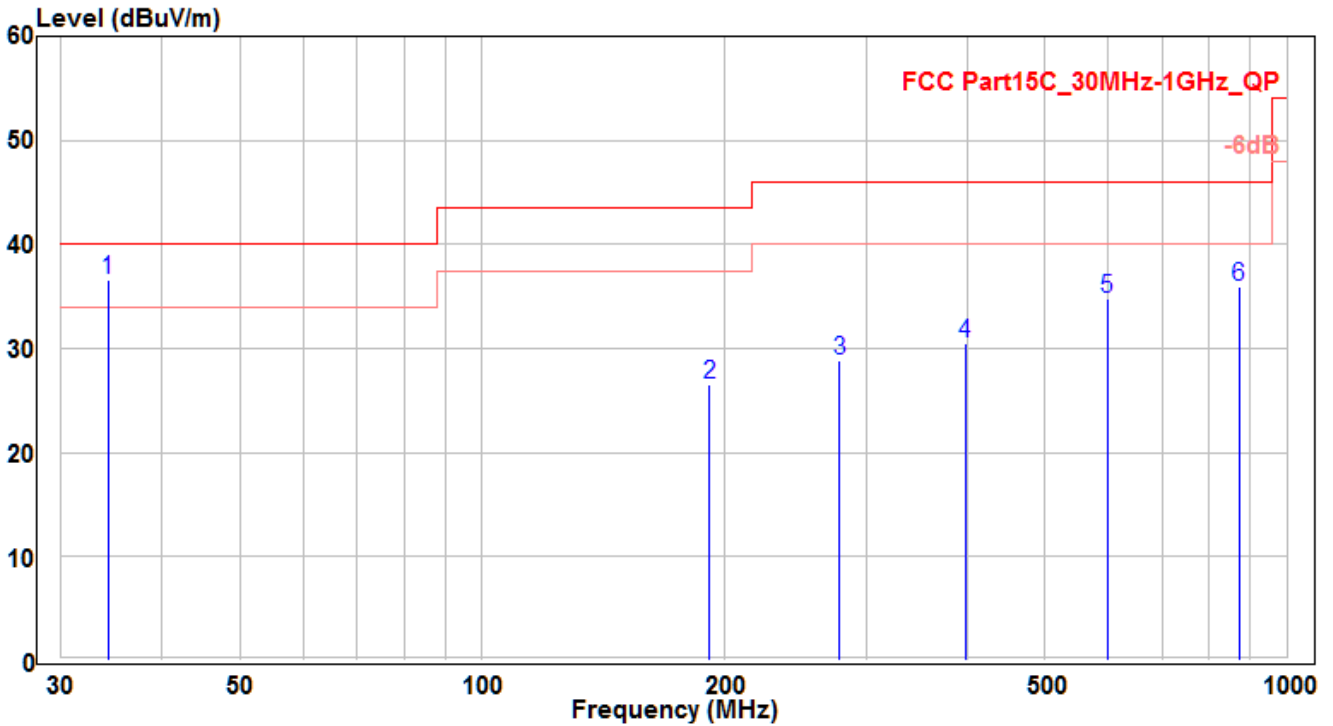

No	Frequency (MHz)	Reading (dBuV)	C.F (dB)	Measurement (dBuV/m)	Margin (dB)	Limit (dBuV/m)	Height (cm)	Angle (deg)	Remark (QP/PK/AV)
1	34.274	17.87	18.77	36.64	-3.36	40	100	400	QP
2	191.869	7.66	18.88	26.54	-16.96	43.5	190	65	QP
3	278.229	7.9	20.98	28.88	-17.12	46	175	100	QP
4	398.297	6.3	24.14	30.44	-15.56	46	100	100	QP
5	598.753	7.18	27.68	34.86	-11.14	46	105	280	QP
6	871.808	4.09	31.81	35.9	-10.1	46	155	400	QP

Note:

- "*" means this data is the worst emission level.
- C.F (Correction Factor) = Antenna Factor (dB)+ Cable Loss (dB).
- Measurement (dBuV/m) = Reading(dBuV) + C.F (Correction Factor).

EUT	Gateway	Test Date	2018/4/11
Factor	BBHA 9120D (1GHz~18GHz)	Temp. / Humidity	25°C / 60%
Polarity	Horizontal	Site / Engineer	AC1 / Peter
Test Mode	MODE1 -CH01	Test Voltage	AC 120V/60Hz

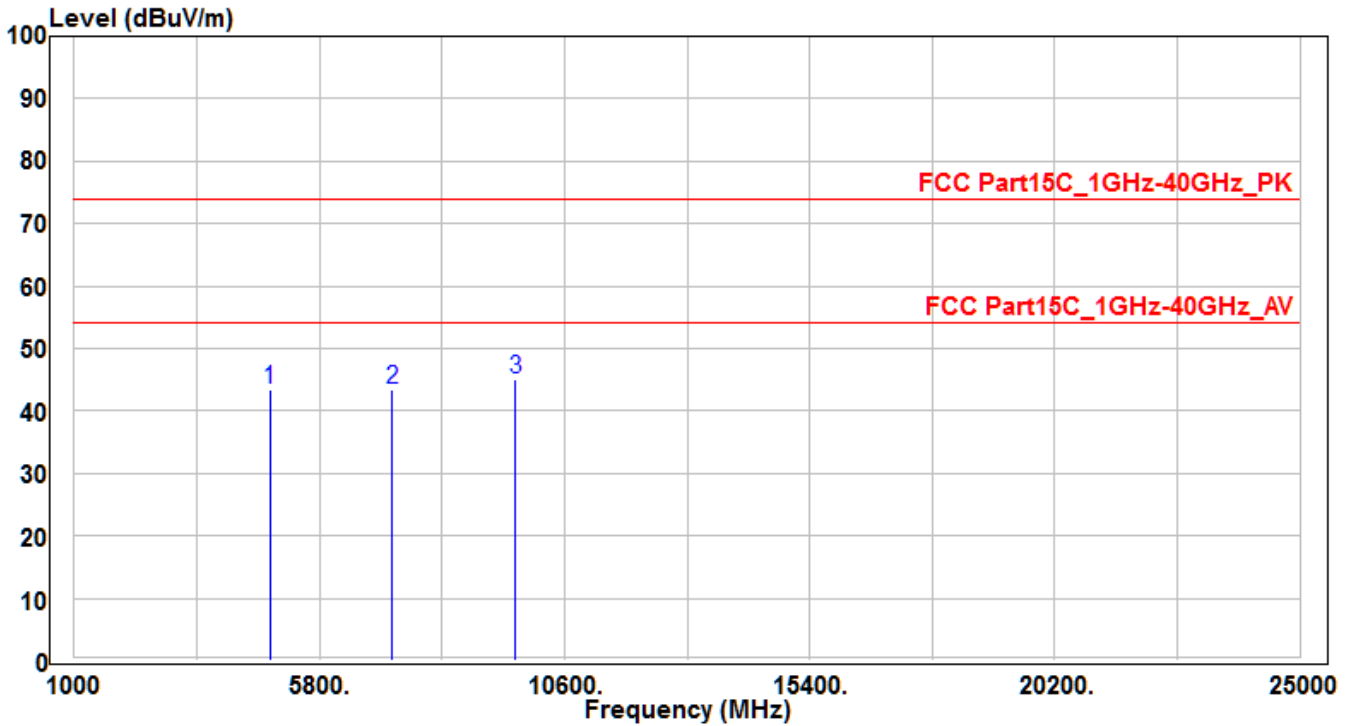

No	Frequency (MHz)	Reading (dBuV)	C.F (dB)	Measurement (dBuV/m)	Margin (dB)	Limit (dBuV/m)	Height (cm)	Angle (deg)	Remark (QP/PK/AV)
1	4824	40.75	2.73	43.48	-30.52	74	150	400	Peak
2	7236	32.05	11.4	43.45	-30.55	74	150	400	Peak
3	* 9648	30.43	14.56	44.99	-29.01	74	150	400	Peak

Note:

1. " * " means this data is the worst emission level.
2. C.F (Correction Factor) = Antenna Factor (dB)+ Cable Loss (dB) - Preamplifier(dB)..
3. Measurement (dBuV/m) = Reading(dBuV) + C.F (Correction Factor).

EUT	Gateway	Test Date	2018/4/11
Factor	BBHA 9120D (1GHz~18GHz)	Temp. / Humidity	25°C / 60%
Polarity	Vertical	Site / Engineer	AC1 / Peter
Test Mode	MODE1 -CH01	Test Voltage	AC 120V/60Hz

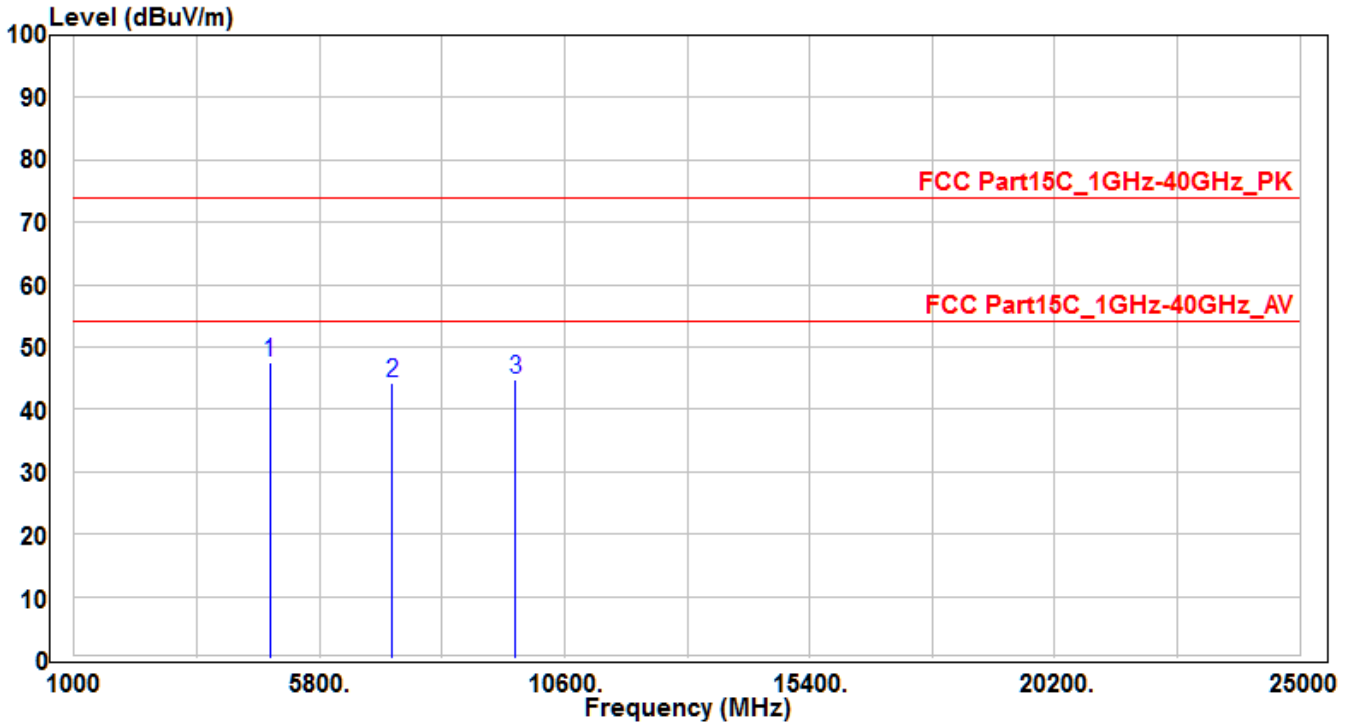

No	Frequency (MHz)	Reading (dBuV)	C.F (dB)	Measurement (dBuV/m)	Margin (dB)	Limit (dBuV/m)	Height (cm)	Angle (deg)	Remark (QP/PK/AV)	
1	*	4824	44.94	2.73	47.67	-26.33	74	150	400	Peak
2		7236	32.83	11.4	44.23	-29.77	74	150	400	Peak
3		9648	30.11	14.56	44.67	-29.33	74	150	400	Peak

Note:

1. " * " means this data is the worst emission level.
2. C.F (Correction Factor) = Antenna Factor (dB)+ Cable Loss (dB) - Preamplifier(dB)..
3. Measurement (dBuV/m) = Reading(dBuV) + C.F (Correction Factor).

EUT	Gateway	Test Date	2018/4/11
Factor	BBHA 9120D (1GHz~18GHz)	Temp. / Humidity	25°C / 60%
Polarity	Horizontal	Site / Engineer	AC1 / Peter
Test Mode	MODE1 -CH06	Test Voltage	AC 120V/60Hz

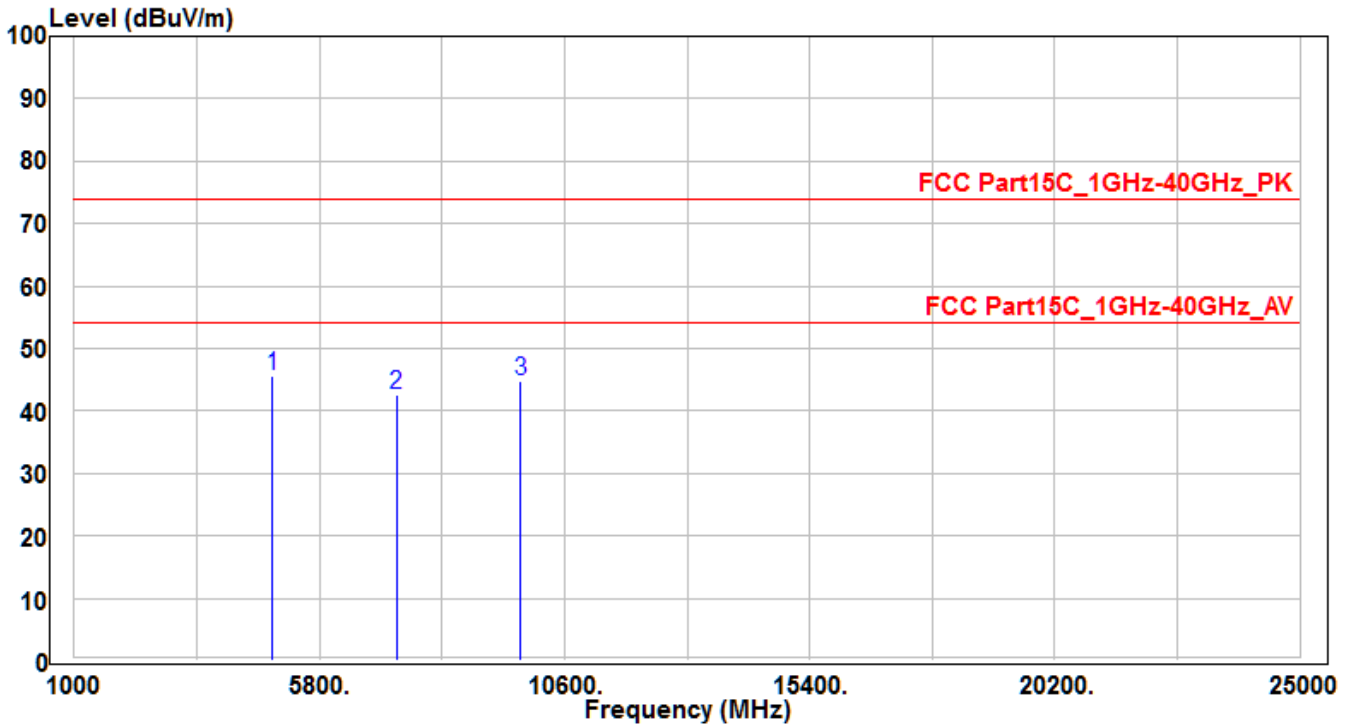

No		Frequency (MHz)	Reading (dBuV)	C.F (dB)	Measurement (dBuV/m)	Margin (dB)	Limit (dBuV/m)	Height (cm)	Angle (deg)	Remark (QP/PK/AV)
1	*	4874	42.8	2.82	45.62	-28.38	74	150	400	Peak
2		7311	30.98	11.74	42.72	-31.28	74	150	400	Peak
3		9748	30.06	14.79	44.85	-29.15	74	150	400	Peak

Note:

1. " * " means this data is the worst emission level.
2. C.F (Correction Factor) = Antenna Factor (dB)+ Cable Loss (dB) - Preamplifier(dB)..
3. Measurement (dBuV/m) = Reading(dBuV) + C.F (Correction Factor).

EUT	Gateway	Test Date	2018/4/11
Factor	BBHA 9120D (1GHz~18GHz)	Temp. / Humidity	25°C / 60%
Polarity	Vertical	Site / Engineer	AC1 / Peter
Test Mode	MODE1 -CH06	Test Voltage	AC 120V/60Hz

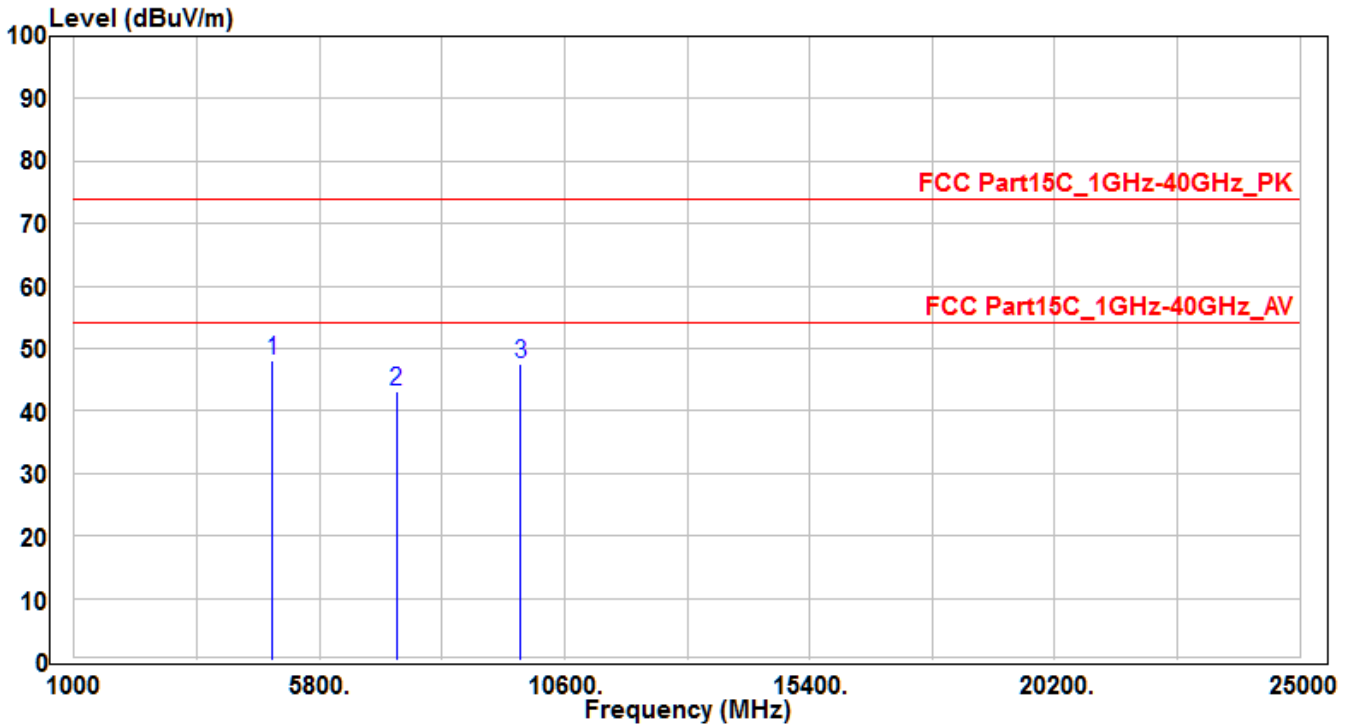

No	Frequency (MHz)	Reading (dBuV)	C.F (dB)	Measurement (dBuV/m)	Margin (dB)	Limit (dBuV/m)	Height (cm)	Angle (deg)	Remark (QP/PK/AV)
1	*	45.25	2.82	48.07	-25.93	74	150	400	Peak
2		31.53	11.74	43.27	-30.73	74	150	400	Peak
3		32.64	14.79	47.43	-26.57	74	150	400	Peak

Note:

1. " * " means the worst value in this measurement data.
2. Measure Level (dBuV/m) = Reading Level (dBuV) + Factor (dB).
3. Factor (dB) = Cable Loss (dB) + Antenna Factor (dB/m).

EUT	Gateway	Test Date	2018/4/11
Factor	BBHA 9120D (1GHz~18GHz)	Temp. / Humidity	25°C / 60%
Polarity	Horizontal	Site / Engineer	AC1 / Peter
Test Mode	MODE1 -CH11	Test Voltage	AC 120V/60Hz

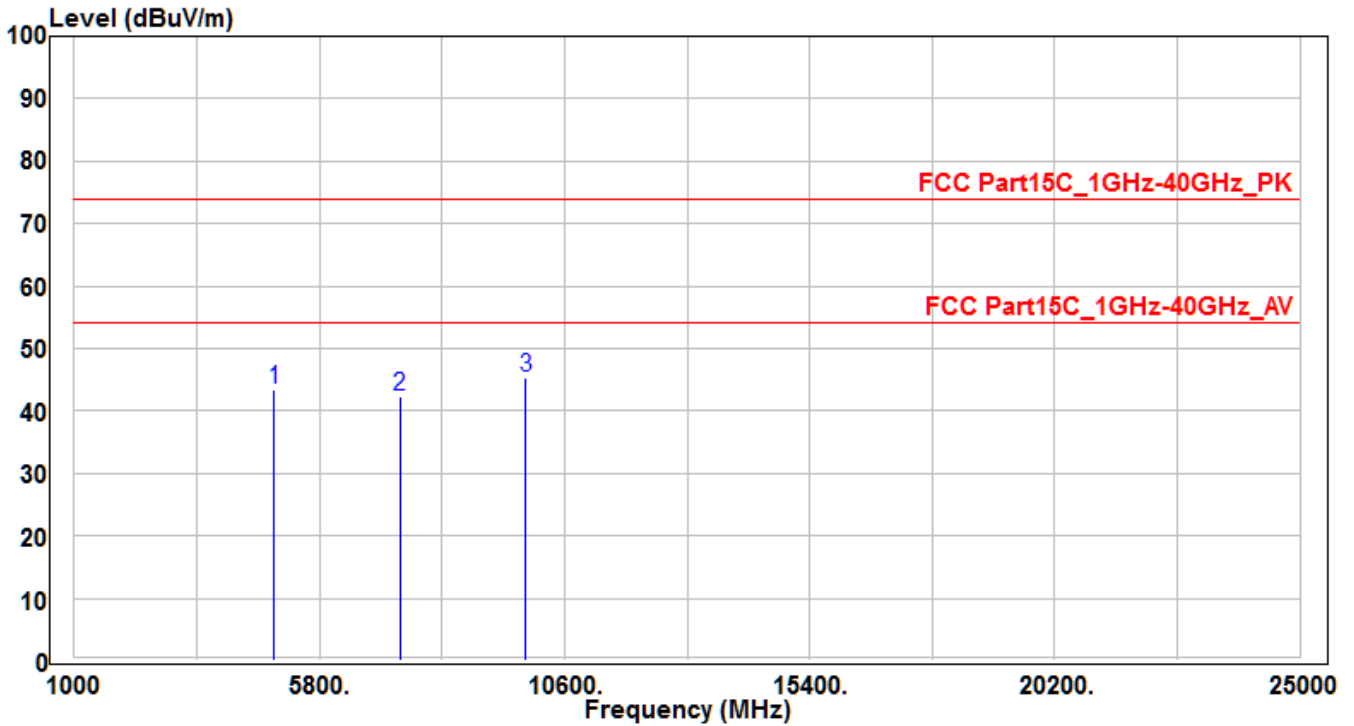

No	Frequency (MHz)	Reading (dBuV)	C.F (dB)	Measurement (dBuV/m)	Margin (dB)	Limit (dBuV/m)	Height (cm)	Angle (deg)	Remark (QP/PK/AV)
1	4924	40.52	2.91	43.43	-30.57	74	150	400	Peak
2	7386	30.33	12.09	42.42	-31.58	74	150	400	Peak
3	* 9848	30.34	15.02	45.36	-28.64	74	150	400	Peak

Note:

1. " * " means this data is the worst emission level.
2. C.F (Correction Factor) = Antenna Factor (dB)+ Cable Loss (dB) - Preamplifier(dB)..
3. Measurement (dBuV/m) = Reading(dBuV) + C.F (Correction Factor).

EUT	Gateway	Test Date	2018/4/11
Factor	BBHA 9120D (1GHz~18GHz)	Temp. / Humidity	25°C / 60%
Polarity	Vertical	Site / Engineer	AC1 / Peter
Test Mode	MODE1 -CH11	Test Voltage	AC 120V/60Hz

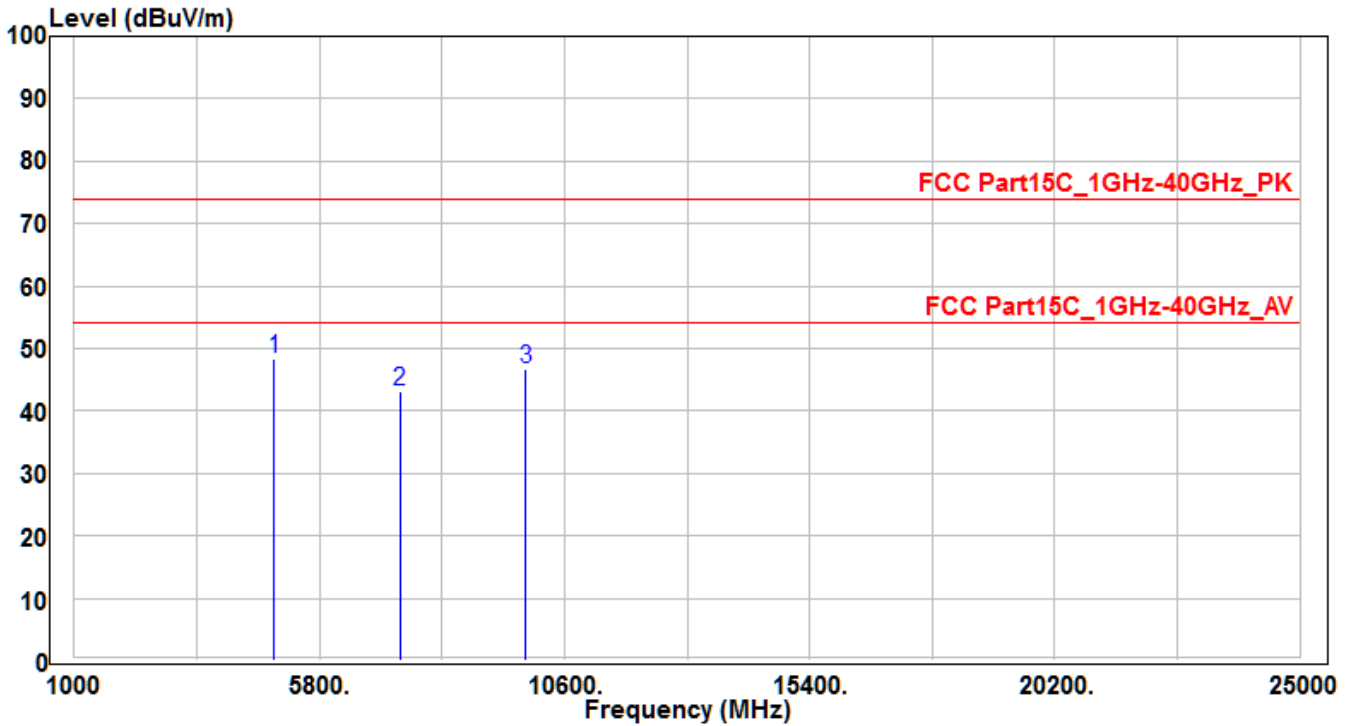

No	Frequency (MHz)	Reading (dBuV)	C.F (dB)	Measurement (dBuV/m)	Margin (dB)	Limit (dBuV/m)	Height (cm)	Angle (deg)	Remark (QP/PK/AV)
1	4924	45.38	2.91	48.29	-25.71	74	150	400	Peak
2	7386	31.19	12.09	43.28	-30.72	74	150	400	Peak
3	9848	31.68	15.02	46.7	-27.3	74	150	400	Peak

Note:

1. " * " means this data is the worst emission level.
2. C.F (Correction Factor) = Antenna Factor (dB)+ Cable Loss (dB) - Preamplifier(dB)..
3. Measurement (dBuV/m) = Reading(dBuV) + C.F (Correction Factor).

EUT	Gateway	Test Date	2018/4/11
Factor	BBHA 9120D (1GHz~18GHz)	Temp. / Humidity	25°C / 60%
Polarity	Horizontal	Site / Engineer	AC1 / Peter
Test Mode	MODE2-CH01	Test Voltage	AC 120V/60Hz

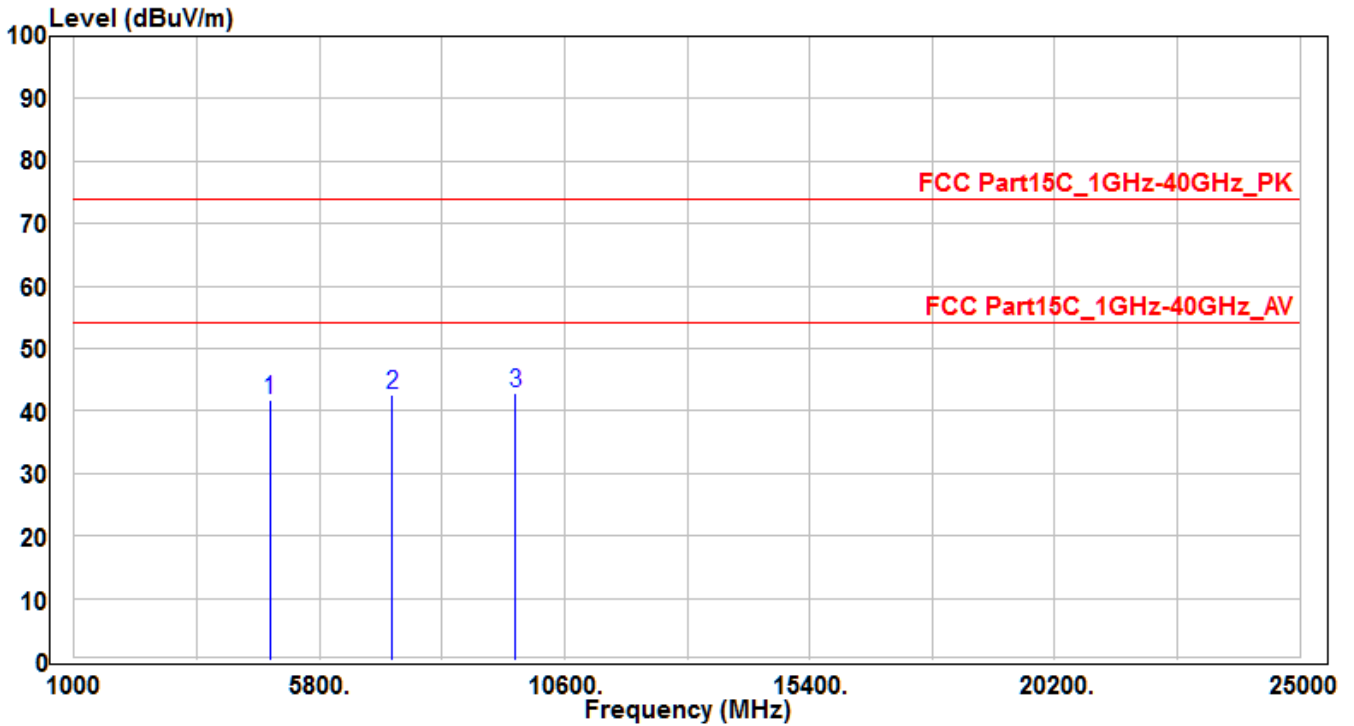

No	Frequency (MHz)	Reading (dBuV)	C.F (dB)	Measurement (dBuV/m)	Margin (dB)	Limit (dBuV/m)	Height (cm)	Angle (deg)	Remark (QP/PK/AV)
1	4824	38.9	2.73	41.63	-32.37	74	150	400	Peak
2	7236	31.09	11.4	42.49	-31.51	74	150	400	Peak
3	* 9648	28.23	14.56	42.79	-31.21	74	150	400	Peak

Note:

- "*" means this data is the worst emission level.
- C.F (Correction Factor) = Antenna Factor (dB)+ Cable Loss (dB) - Preamplifier(dB)..
- Measurement (dBuV/m) = Reading(dBuV) + C.F (Correction Factor).

EUT	Gateway	Test Date	2018/4/11
Factor	BBHA 9120D (1GHz~18GHz)	Temp. / Humidity	25°C / 60%
Polarity	Vertical	Site / Engineer	AC1 / Peter
Test Mode	MODE2-CH01	Test Voltage	AC 120V/60Hz

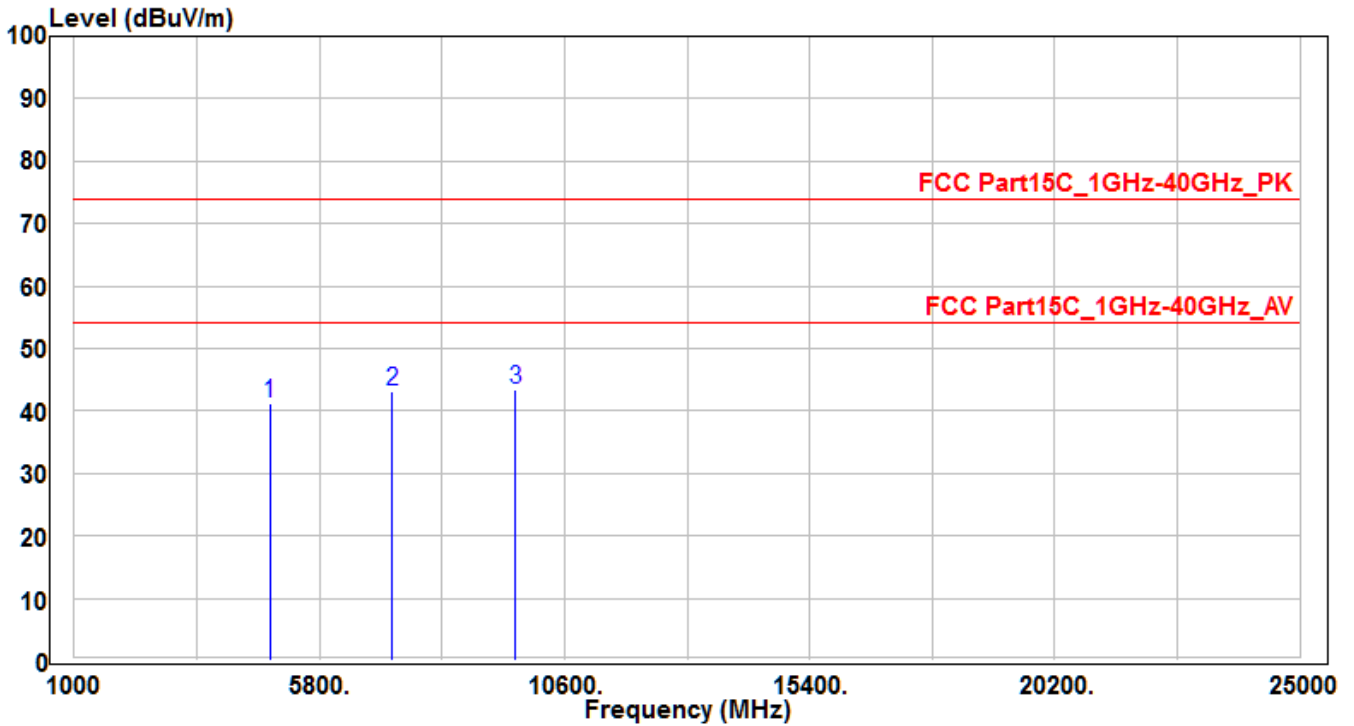

No	Frequency (MHz)	Reading (dBuV)	C.F (dB)	Measurement (dBuV/m)	Margin (dB)	Limit (dBuV/m)	Height (cm)	Angle (deg)	Remark (QP/PK/AV)
1	4824	38.62	2.73	41.35	-32.65	74	150	400	Peak
2	7236	31.62	11.4	43.02	-30.98	74	150	400	Peak
3	* 9648	28.79	14.56	43.35	-30.65	74	150	400	Peak

Note:

1. " * " means this data is the worst emission level.
2. C.F (Correction Factor) = Antenna Factor (dB)+ Cable Loss (dB) - Preamplifier(dB)..
3. Measurement (dBuV/m) = Reading(dBuV) + C.F (Correction Factor).

EUT	Gateway	Test Date	2018/4/11
Factor	BBHA 9120D (1GHz~18GHz)	Temp. / Humidity	25°C / 60%
Polarity	Horizontal	Site / Engineer	AC1 / Peter
Test Mode	MODE2-CH06	Test Voltage	AC 120V/60Hz

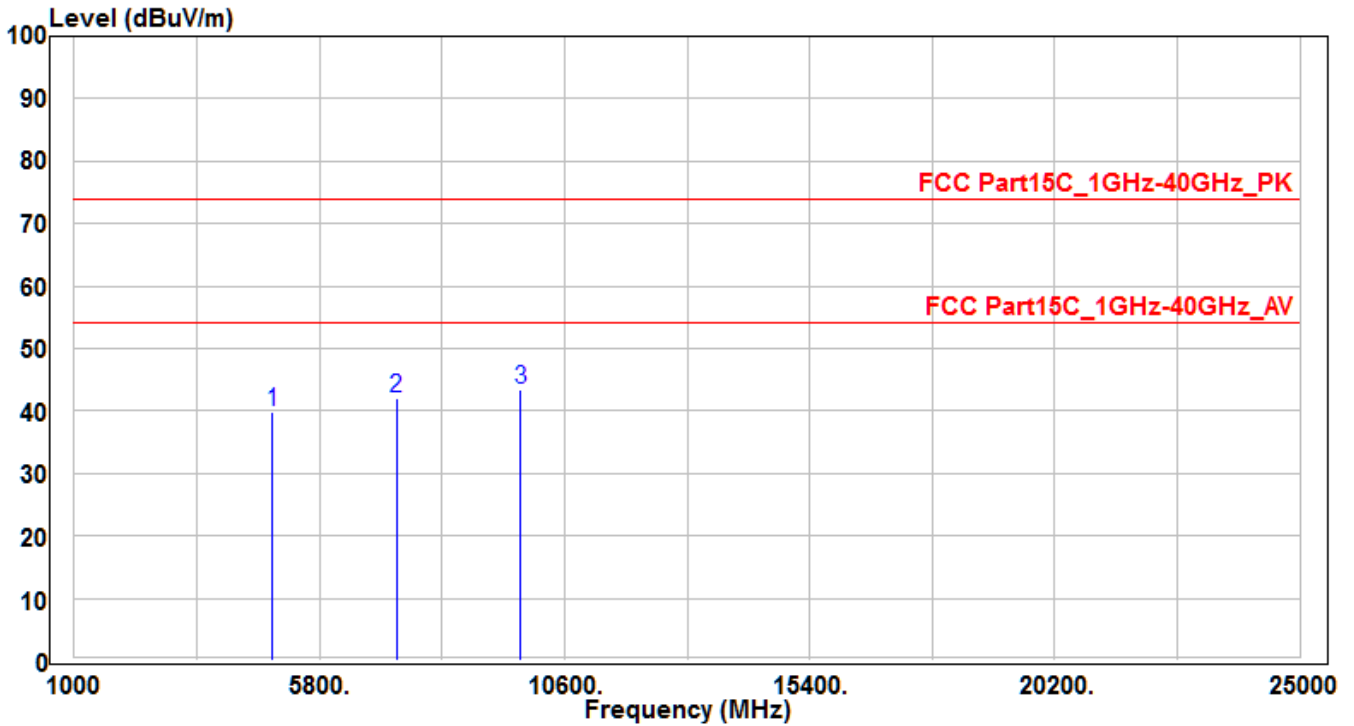

No	Frequency (MHz)	Reading (dBuV)	C.F (dB)	Measurement (dBuV/m)	Margin (dB)	Limit (dBuV/m)	Height (cm)	Angle (deg)	Remark (QP/PK/AV)
1	4874	37.13	2.82	39.95	-34.05	74	150	400	Peak
2	7311	30.2	11.74	41.94	-32.06	74	150	400	Peak
3	* 9748	28.62	14.79	43.41	-30.59	74	150	400	Peak

Note:

1. " * " means this data is the worst emission level.
2. C.F (Correction Factor) = Antenna Factor (dB)+ Cable Loss (dB) - Preamplifier(dB)..
3. Measurement (dBuV/m) = Reading(dBuV) + C.F (Correction Factor).

EUT	Gateway	Test Date	2018/4/11
Factor	BBHA 9120D (1GHz~18GHz)	Temp. / Humidity	25°C / 60%
Polarity	Vertical	Site / Engineer	AC1 / Peter
Test Mode	MODE2-CH06	Test Voltage	AC 120V/60Hz

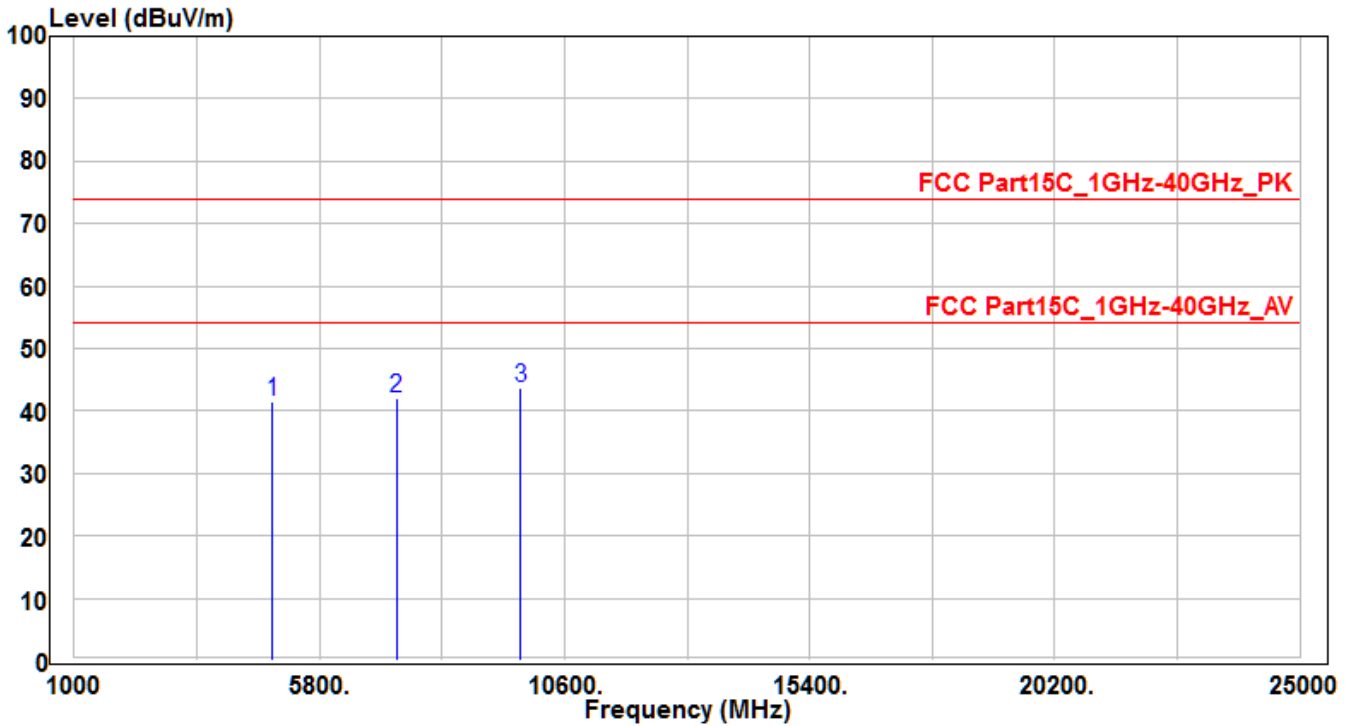

No	Frequency (MHz)	Reading (dBuV)	C.F (dB)	Measurement (dBuV/m)	Margin (dB)	Limit (dBuV/m)	Height (cm)	Angle (deg)	Remark (QP/PK/AV)
1	4874	38.76	2.82	41.58	-32.42	74	150	400	Peak
2	7311	30.32	11.74	42.06	-31.94	74	150	400	Peak
3	* 9748	28.93	14.79	43.72	-30.28	74	150	400	Peak

Note:

1. " * " means this data is the worst emission level.
2. C.F (Correction Factor) = Antenna Factor (dB)+ Cable Loss (dB) - Preamplifier(dB)..
3. Measurement (dBuV/m) = Reading(dBuV) + C.F (Correction Factor).

EUT	Gateway	Test Date	2018/4/11
Factor	BBHA 9120D (1GHz~18GHz)	Temp. / Humidity	25°C / 60%
Polarity	Horizontal	Site / Engineer	AC1 / Peter
Test Mode	MODE2-CH11	Test Voltage	AC 120V/60Hz

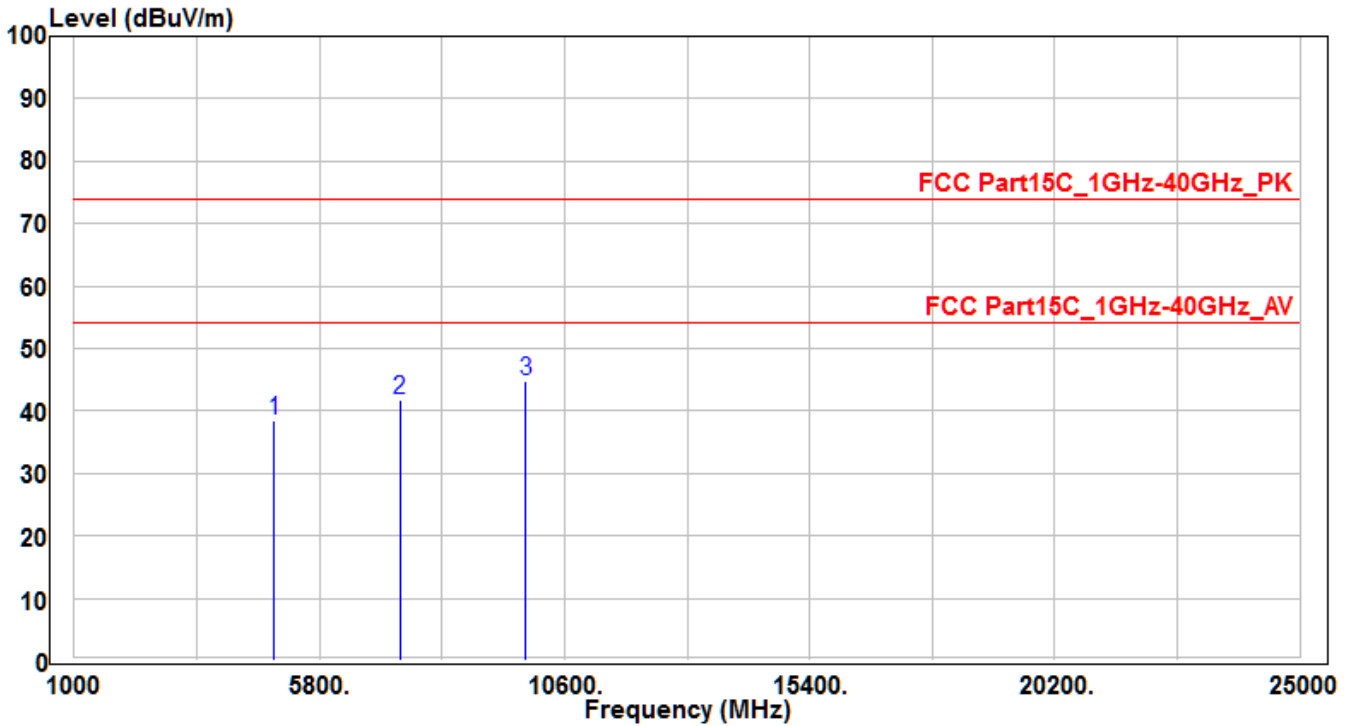

No	Frequency (MHz)	Reading (dBuV)	C.F (dB)	Measurement (dBuV/m)	Margin (dB)	Limit (dBuV/m)	Height (cm)	Angle (deg)	Remark (QP/PK/AV)
1	4924	35.69	2.91	38.6	-35.4	74	150	400	Peak
2	7386	29.71	12.09	41.8	-32.2	74	150	400	Peak
3	* 9848	29.74	15.02	44.76	-29.24	74	150	400	Peak

Note:

1. " * " means this data is the worst emission level.
2. C.F (Correction Factor) = Antenna Factor (dB)+ Cable Loss (dB) - Preamplifier(dB)..
3. Measurement (dBuV/m) = Reading(dBuV) + C.F (Correction Factor).

EUT	Gateway	Test Date	2018/4/11
Factor	BBHA 9120D (1GHz~18GHz)	Temp. / Humidity	25°C / 60%
Polarity	Vertical	Site / Engineer	AC1 / Peter
Test Mode	MODE2-CH11	Test Voltage	AC 120V/60Hz

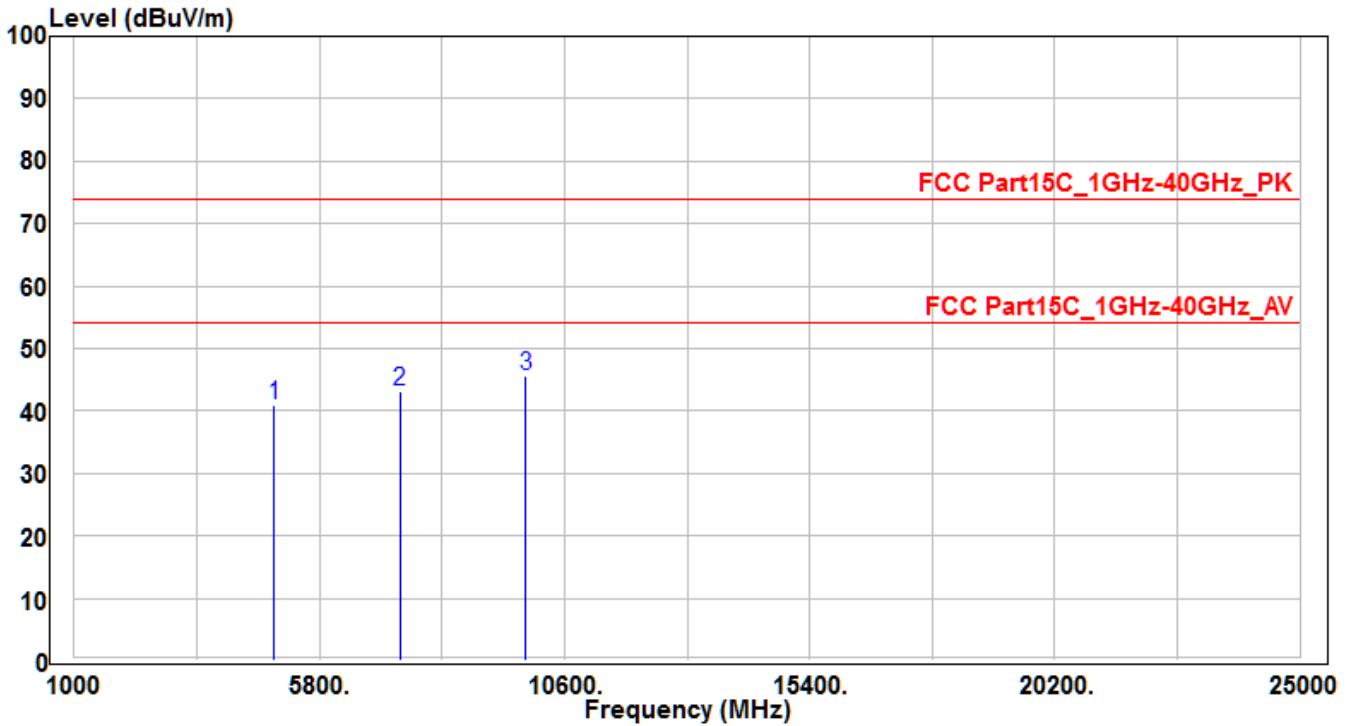

No	Frequency (MHz)	Reading (dBuV)	C.F (dB)	Measurement (dBuV/m)	Margin (dB)	Limit (dBuV/m)	Height (cm)	Angle (deg)	Remark (QP/PK/AV)
1	4924	38.09	2.91	41	-33	74	150	400	Peak
2	7386	31.1	12.09	43.19	-30.81	74	150	400	Peak
3	* 9848	30.69	15.02	45.71	-28.29	74	150	400	Peak

Note:

1. " * " means this data is the worst emission level.
2. C.F (Correction Factor) = Antenna Factor (dB)+ Cable Loss (dB) - Preamplifier(dB)..
3. Measurement (dBuV/m) = Reading(dBuV) + C.F (Correction Factor).

EUT	Gateway	Test Date	2018/4/11
Factor	BBHA 9120D (1GHz~18GHz)	Temp. / Humidity	25°C / 60%
Polarity	Horizontal	Site / Engineer	AC1 / Peter
Test Mode	MODE3-CH01	Test Voltage	AC 120V/60Hz

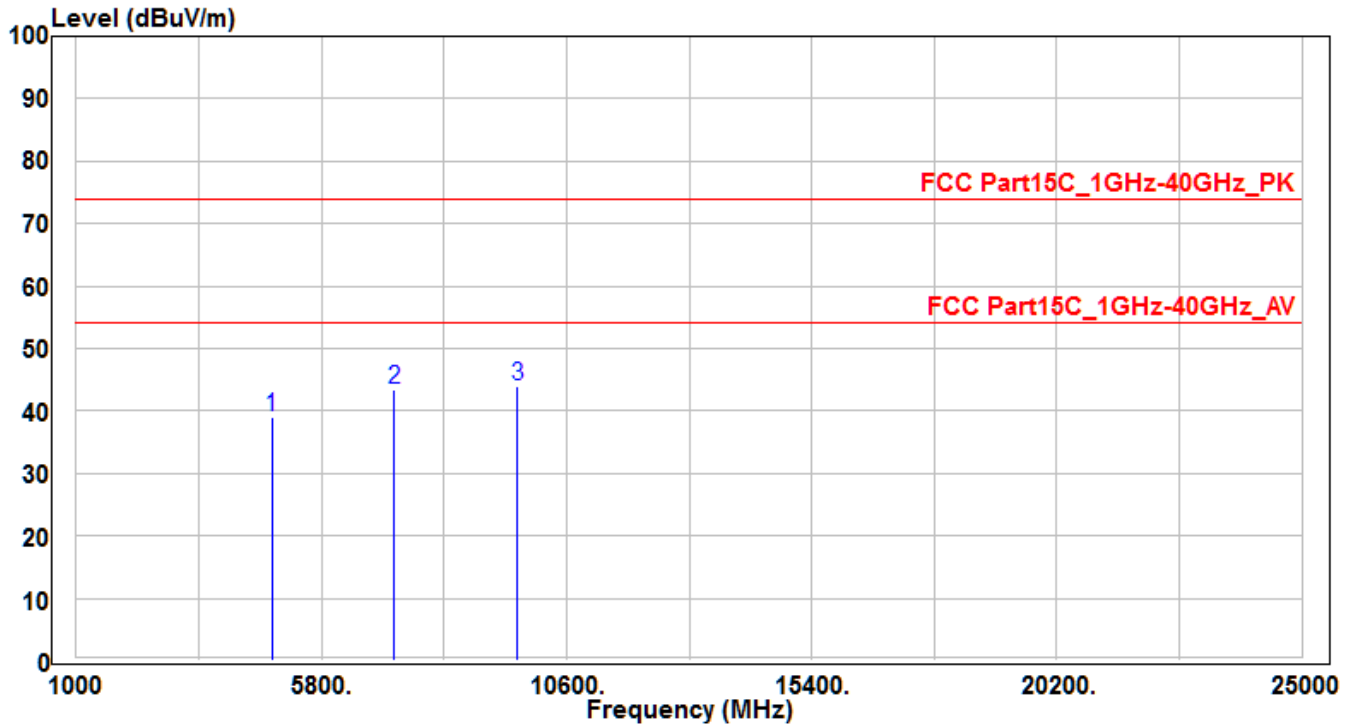

No	Frequency (MHz)	Reading (dBuV)	C.F (dB)	Measurement (dBuV/m)	Margin (dB)	Limit (dBuV/m)	Height (cm)	Angle (deg)	Remark (QP/PK/AV)
1	4824	36.24	2.73	38.97	-35.03	74	150	400	Peak
2	7236	32.14	11.4	43.54	-30.46	74	150	400	Peak
3	* 9648	29.32	14.56	43.88	-30.12	74	150	400	Peak

Note:

1. " * " means this data is the worst emission level.
2. C.F (Correction Factor) = Antenna Factor (dB)+ Cable Loss (dB) - Preamplifier(dB)..
3. Measurement (dBuV/m) = Reading(dBuV) + C.F (Correction Factor).

EUT	Gateway	Test Date	2018/4/11
Factor	BBHA 9120D (1GHz~18GHz)	Temp. / Humidity	25°C / 60%
Polarity	Vertical	Site / Engineer	AC1 / Peter
Test Mode	MODE3-CH01	Test Voltage	AC 120V/60Hz

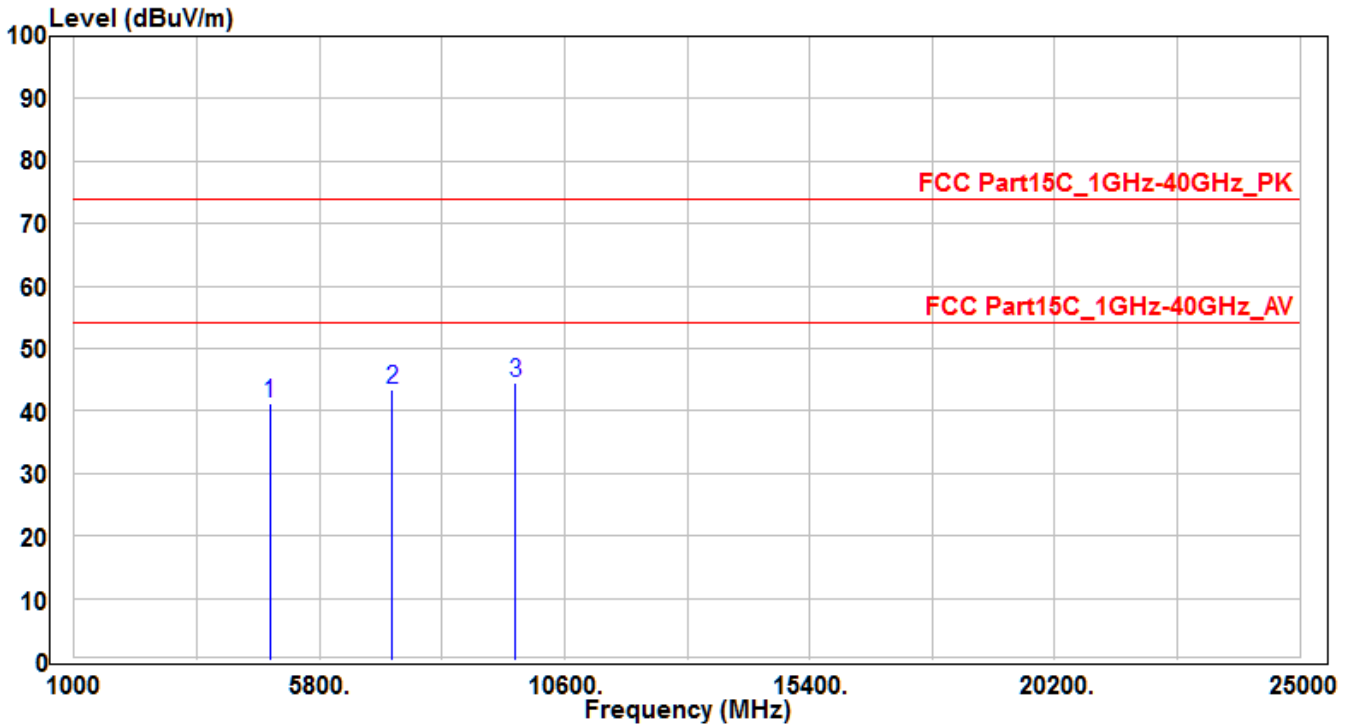

No	Frequency (MHz)	Reading (dBuV)	C.F (dB)	Measurement (dBuV/m)	Margin (dB)	Limit (dBuV/m)	Height (cm)	Angle (deg)	Remark (QP/PK/AV)
1	4824	38.44	2.73	41.17	-32.83	74	150	400	Peak
2	7236	32.14	11.4	43.54	-30.46	74	150	400	Peak
3	* 9648	30	14.56	44.56	-29.44	74	150	400	Peak

Note:

1. " * " means this data is the worst emission level.
2. C.F (Correction Factor) = Antenna Factor (dB)+ Cable Loss (dB) - Preamplifier(dB)..
3. Measurement (dBuV/m) = Reading(dBuV) + C.F (Correction Factor).

EUT	Gateway	Test Date	2018/4/11
Factor	BBHA 9120D (1GHz~18GHz)	Temp. / Humidity	25°C / 60%
Polarity	Horizontal	Site / Engineer	AC1 / Peter
Test Mode	MODE3-CH06	Test Voltage	AC 120V/60Hz

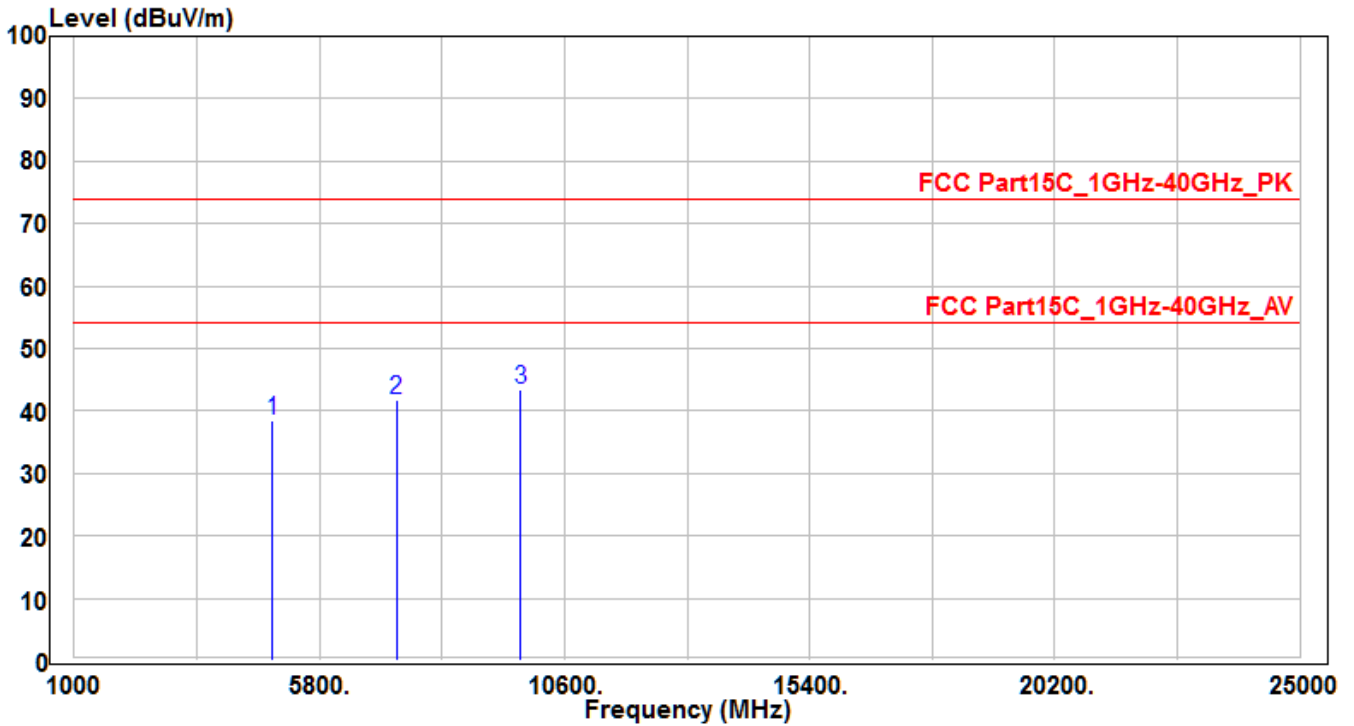

No	Frequency (MHz)	Reading (dBuV)	C.F (dB)	Measurement (dBuV/m)	Margin (dB)	Limit (dBuV/m)	Height (cm)	Angle (deg)	Remark (QP/PK/AV)
1	4874	35.73	2.82	38.55	-35.45	74	150	400	Peak
2	7311	29.94	11.74	41.68	-32.32	74	150	400	Peak
3	* 9748	28.57	14.79	43.36	-30.64	74	150	400	Peak

Note:

1. " * " means this data is the worst emission level.
2. C.F (Correction Factor) = Antenna Factor (dB)+ Cable Loss (dB) - Preamplifier(dB)..
3. Measurement (dBuV/m) = Reading(dBuV) + C.F (Correction Factor).

EUT	Gateway	Test Date	2018/4/11
Factor	BBHA 9120D (1GHz~18GHz)	Temp. / Humidity	25°C / 60%
Polarity	Vertical	Site / Engineer	AC1 / Peter
Test Mode	MODE3-CH06	Test Voltage	AC 120V/60Hz

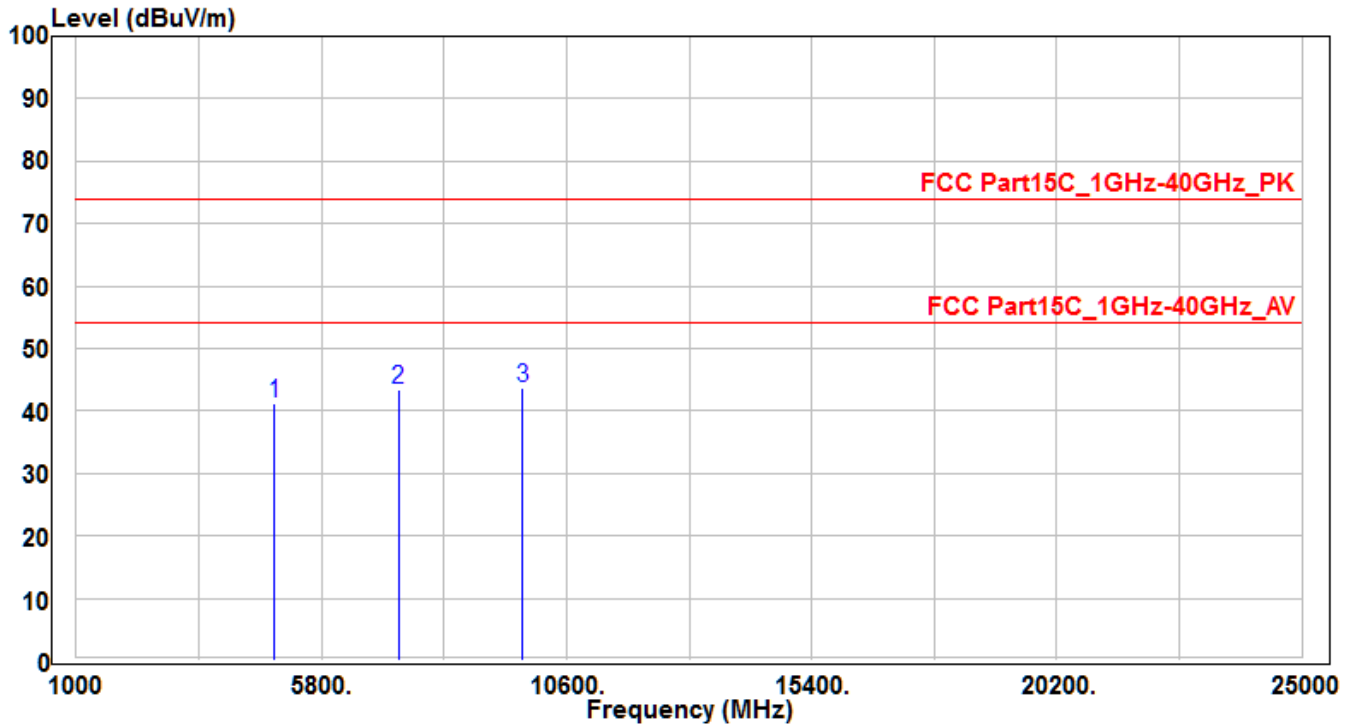

No	Frequency (MHz)	Reading (dBuV)	C.F (dB)	Measurement (dBuV/m)	Margin (dB)	Limit (dBuV/m)	Height (cm)	Angle (deg)	Remark (QP/PK/AV)
1	4874	38.44	2.82	41.26	-32.74	74	150	400	Peak
2	7311	31.75	11.74	43.49	-30.51	74	150	400	Peak
3	* 9748	28.94	14.79	43.73	-30.27	74	150	400	Peak

Note:

1. " * " means this data is the worst emission level.
2. C.F (Correction Factor) = Antenna Factor (dB)+ Cable Loss (dB) - Preamplifier(dB)..
3. Measurement (dBuV/m) = Reading(dBuV) + C.F (Correction Factor).

EUT	Gateway	Test Date	2018/4/11
Factor	BBHA 9120D (1GHz~18GHz)	Temp. / Humidity	25°C / 60%
Polarity	Horizontal	Site / Engineer	AC1 / Peter
Test Mode	MODE3-CH11	Test Voltage	AC 120V/60Hz

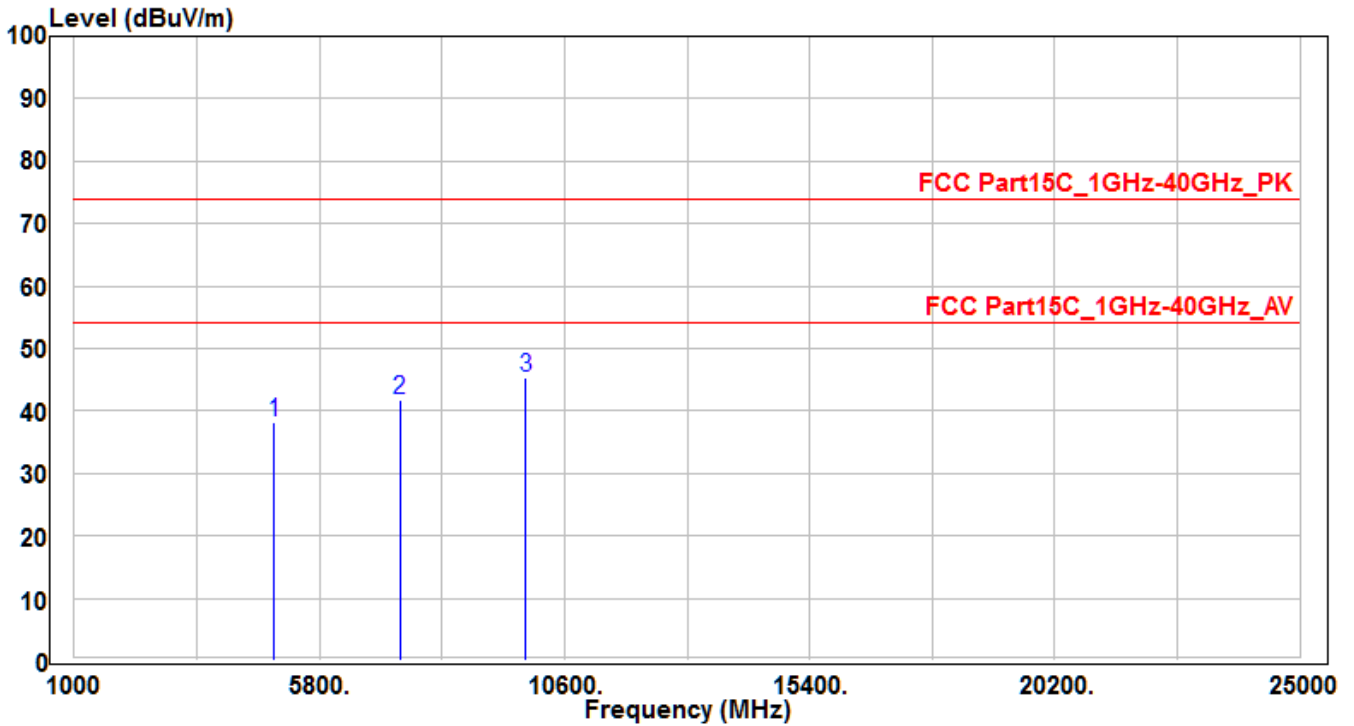

No	Frequency (MHz)	Reading (dBuV)	C.F (dB)	Measurement (dBuV/m)	Margin (dB)	Limit (dBuV/m)	Height (cm)	Angle (deg)	Remark (QP/PK/AV)
1	4924	35.32	2.91	38.23	-35.77	74	150	400	Peak
2	7386	29.64	12.09	41.73	-32.27	74	150	400	Peak
3	* 9848	30.41	15.02	45.43	-28.57	74	150	400	Peak

Note:

1. " * " means this data is the worst emission level.
2. C.F (Correction Factor) = Antenna Factor (dB)+ Cable Loss (dB) - Preamplifier(dB)..
3. Measurement (dBuV/m) = Reading(dBuV) + C.F (Correction Factor).

EUT	Gateway	Test Date	2018/4/11
Factor	BBHA 9120D (1GHz~18GHz)	Temp. / Humidity	25°C / 60%
Polarity	Vertical	Site / Engineer	AC1 / Peter
Test Mode	MODE3 -CH11	Test Voltage	AC 120V/60Hz

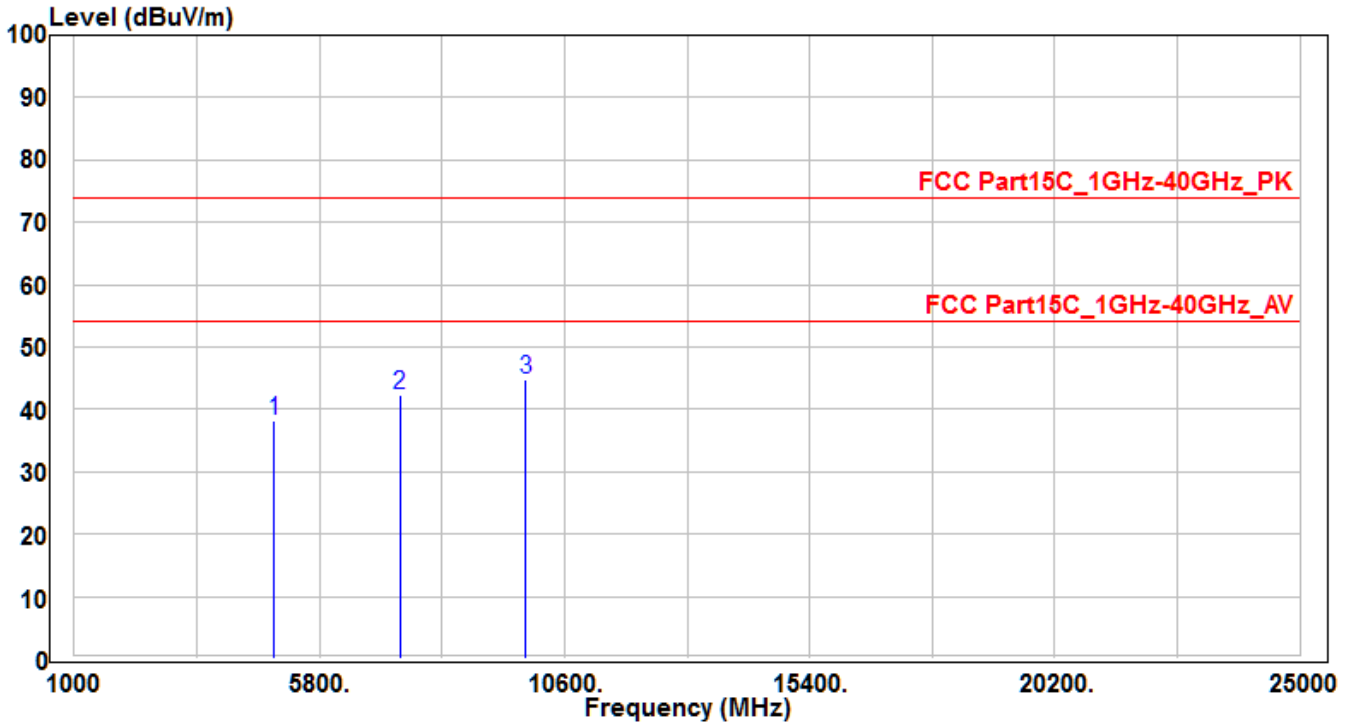

No	Frequency (MHz)	Reading (dBuV)	C.F (dB)	Measurement (dBuV/m)	Margin (dB)	Limit (dBuV/m)	Height (cm)	Angle (deg)	Remark (QP/PK/AV)
1	4924	35.37	2.91	38.28	-35.72	74	150	400	Peak
2	7386	30.23	12.09	42.32	-31.68	74	150	400	Peak
3	* 9848	29.77	15.02	44.79	-29.21	74	150	400	Peak

Note:

1. " * " means this data is the worst emission level.
2. C.F (Correction Factor) = Antenna Factor (dB)+ Cable Loss (dB) - Preamplifier(dB)..
3. Measurement (dBuV/m) = Reading(dBuV) + C.F (Correction Factor).

EUT	Gateway	Test Date	2018/4/11
Factor	BBHA 9120D (1GHz~18GHz)	Temp. / Humidity	25°C / 60%
Polarity	Horizontal	Site / Engineer	AC1 / Peter
Test Mode	MODE4-CH03	Test Voltage	AC 120V/60Hz

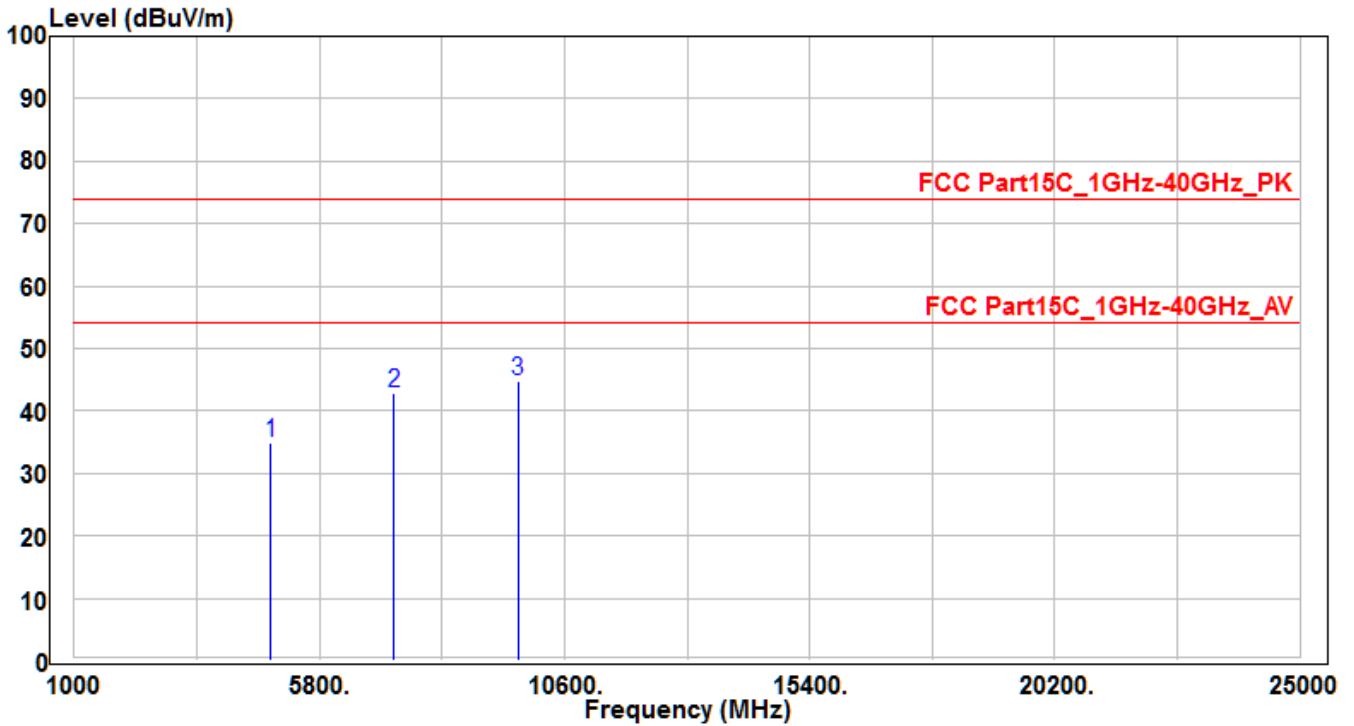

No	Frequency (MHz)	Reading (dBuV)	C.F (dB)	Measurement (dBuV/m)	Margin (dB)	Limit (dBuV/m)	Height (cm)	Angle (deg)	Remark (QP/PK/AV)
1	4844	32.25	2.77	35.02	-38.98	74	150	400	Peak
2	7266	31.44	11.53	42.97	-31.03	74	150	400	Peak
3	*	30.14	14.65	44.79	-29.21	74	150	400	Peak

Note:

1. " * " means this data is the worst emission level.
2. C.F (Correction Factor) = Antenna Factor (dB)+ Cable Loss (dB) - Preamplifier(dB)..
3. Measurement (dBuV/m) = Reading(dBuV) + C.F (Correction Factor).

EUT	Gateway	Test Date	2018/4/11
Factor	BBHA 9120D (1GHz~18GHz)	Temp. / Humidity	25°C / 60%
Polarity	Vertical	Site / Engineer	AC1 / Peter
Test Mode	MODE4-CH03	Test Voltage	AC 120V/60Hz

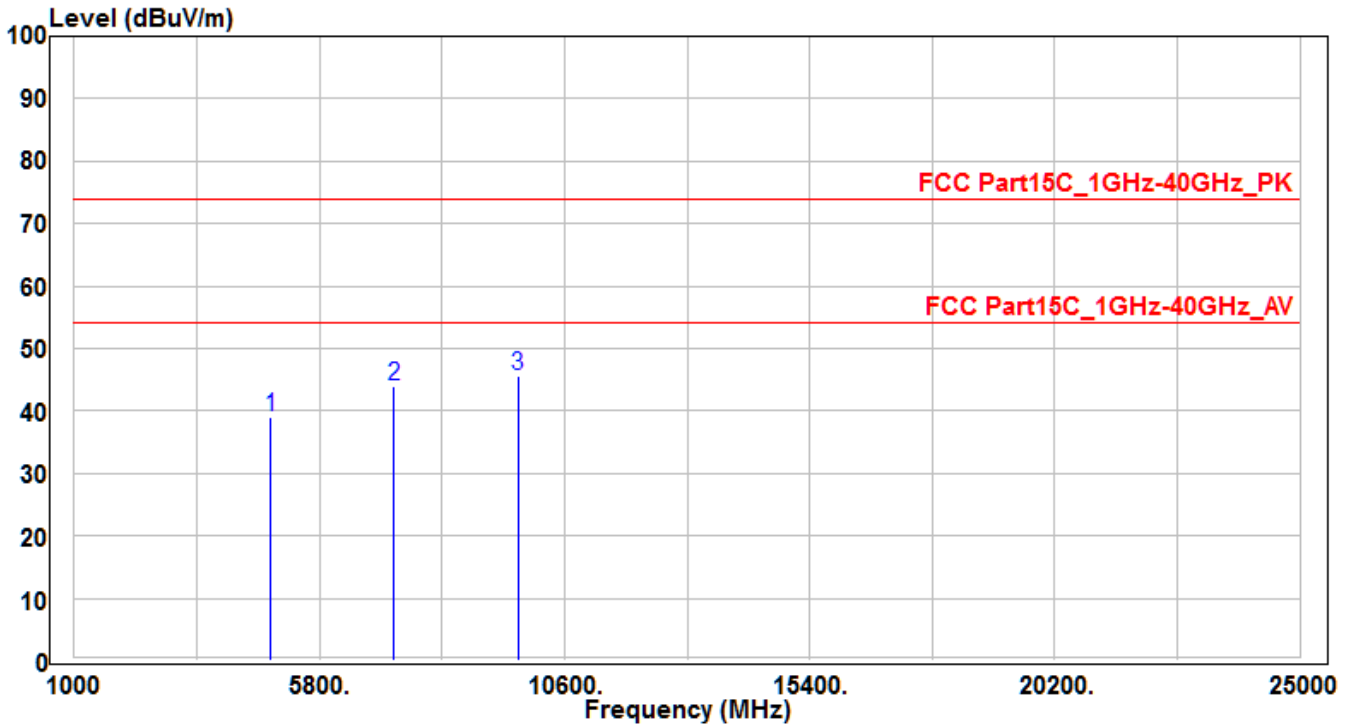

No	Frequency (MHz)	Reading (dBuV)	C.F (dB)	Measurement (dBuV/m)	Margin (dB)	Limit (dBuV/m)	Height (cm)	Angle (deg)	Remark (QP/PK/AV)
1	4844	36.25	2.77	39.02	-34.98	74	150	400	Peak
2	7266	32.35	11.53	43.88	-30.12	74	150	400	Peak
3	* 9688	30.84	14.65	45.49	-28.51	74	150	400	Peak

Note:

1. " * " means this data is the worst emission level.
2. C.F (Correction Factor) = Antenna Factor (dB)+ Cable Loss (dB) - Preamplifier(dB)..
3. Measurement (dBuV/m) = Reading(dBuV) + C.F (Correction Factor).

EUT	Gateway	Test Date	2018/4/11
Factor	BBHA 9120D (1GHz~18GHz)	Temp. / Humidity	25°C / 60%
Polarity	Horizontal	Site / Engineer	AC1 / Peter
Test Mode	MODE4-CH06	Test Voltage	AC 120V/60Hz

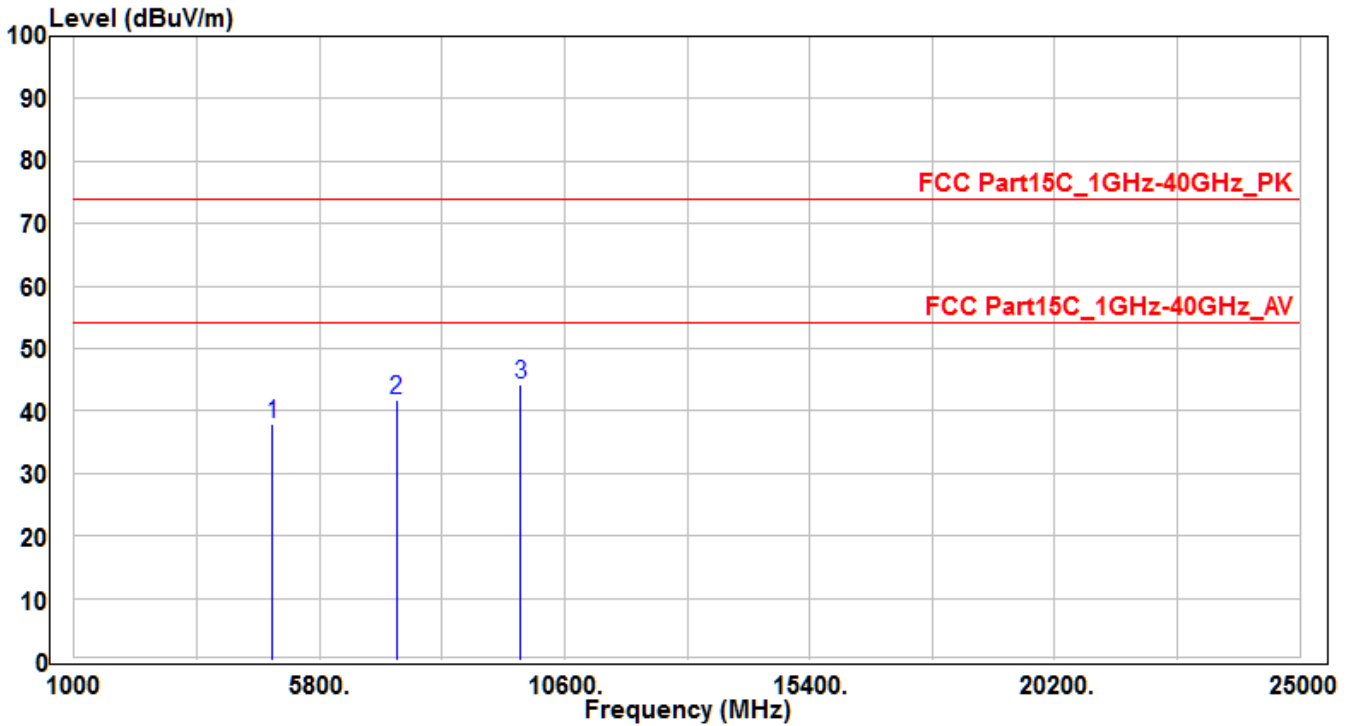

No	Frequency (MHz)	Reading (dBuV)	C.F (dB)	Measurement (dBuV/m)	Margin (dB)	Limit (dBuV/m)	Height (cm)	Angle (deg)	Remark (QP/PK/AV)
1	4874	35	2.82	37.82	-36.18	74	150	400	Peak
2	7311	30.02	11.74	41.76	-32.24	74	150	400	Peak
3	* 9748	29.57	14.79	44.36	-29.64	74	150	400	Peak

Note:

1. " * " means this data is the worst emission level.
2. C.F (Correction Factor) = Antenna Factor (dB)+ Cable Loss (dB) - Preamplifier(dB)..
3. Measurement (dBuV/m) = Reading(dBuV) + C.F (Correction Factor).

EUT	Gateway	Test Date	2018/4/11
Factor	BBHA 9120D (1GHz~18GHz)	Temp. / Humidity	25°C / 60%
Polarity	Vertical	Site / Engineer	AC1 / Peter
Test Mode	MODE4-CH06	Test Voltage	AC 120V/60Hz

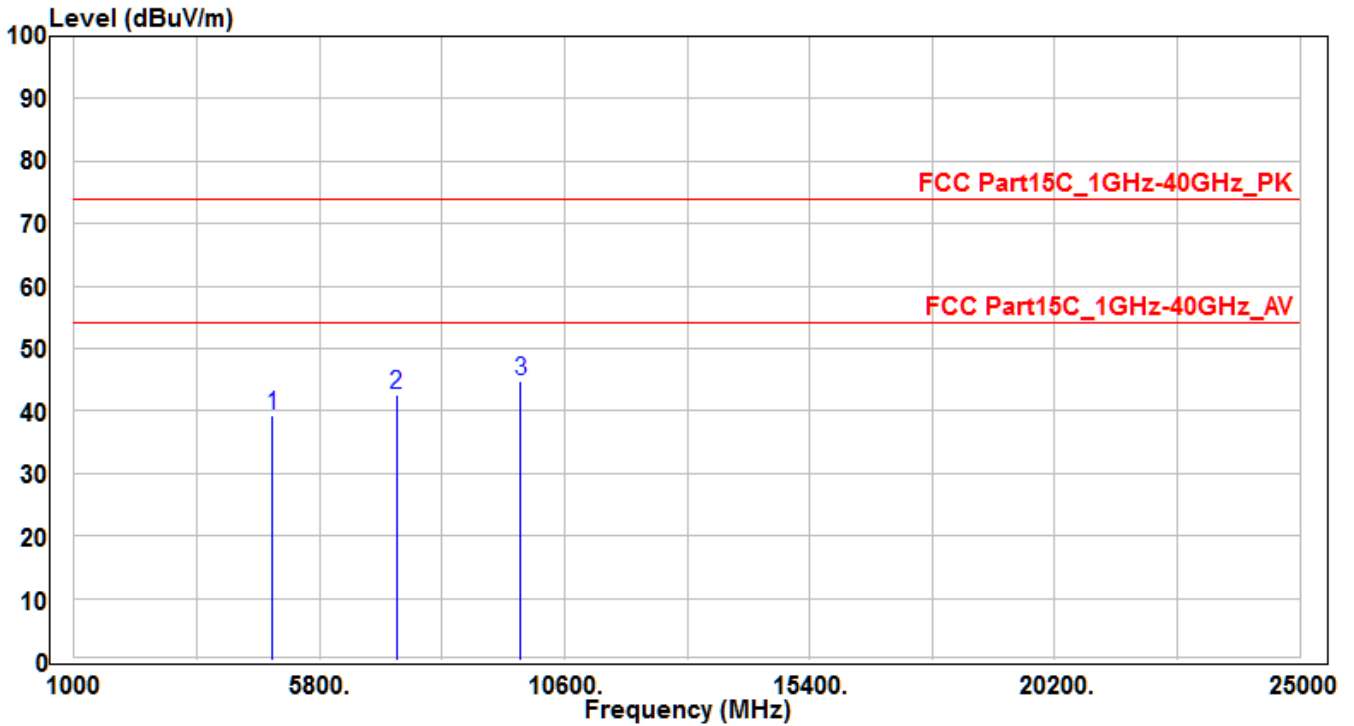

No	Frequency (MHz)	Reading (dBuV)	C.F (dB)	Measurement (dBuV/m)	Margin (dB)	Limit (dBuV/m)	Height (cm)	Angle (deg)	Remark (QP/PK/AV)
1	4874	36.5	2.82	39.32	-34.68	74	150	400	Peak
2	7311	30.98	11.74	42.72	-31.28	74	150	400	Peak
3	* 9748	29.87	14.79	44.66	-29.34	74	150	400	Peak

Note:

1. " * " means this data is the worst emission level.
2. C.F (Correction Factor) = Antenna Factor (dB)+ Cable Loss (dB) - Preamplifier(dB)..
3. Measurement (dBuV/m) = Reading(dBuV) + C.F (Correction Factor).

EUT	Gateway	Test Date	2018/4/11
Factor	BBHA 9120D (1GHz~18GHz)	Temp. / Humidity	25°C / 60%
Polarity	Horizontal	Site / Engineer	AC1 / Peter
Test Mode	MODE4-CH09	Test Voltage	AC 120V/60Hz

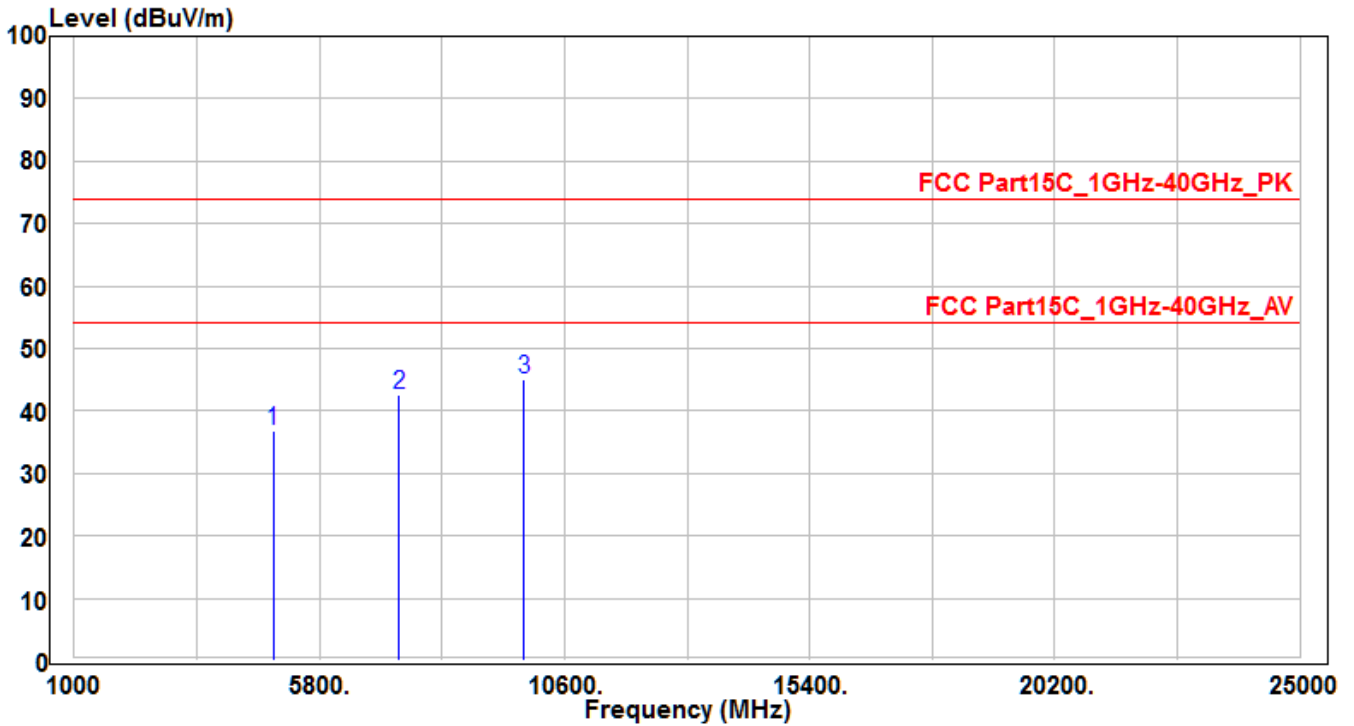

No	Frequency (MHz)	Reading (dBuV)	C.F (dB)	Measurement (dBuV/m)	Margin (dB)	Limit (dBuV/m)	Height (cm)	Angle (deg)	Remark (QP/PK/AV)
1	4904	33.99	2.88	36.87	-37.13	74	150	400	Peak
2	7356	30.61	11.96	42.57	-31.43	74	150	400	Peak
3	*	30.04	14.93	44.97	-29.03	74	150	400	Peak

Note:

1. " * " means this data is the worst emission level.
2. C.F (Correction Factor) = Antenna Factor (dB)+ Cable Loss (dB) - Preamplifier(dB)..
3. Measurement (dBuV/m) = Reading(dBuV) + C.F (Correction Factor).

EUT	Gateway	Test Date	2018/4/11
Factor	BBHA 9120D (1GHz~18GHz)	Temp. / Humidity	25°C / 60%
Polarity	Vertical	Site / Engineer	AC1 / Peter
Test Mode	MODE4-CH09	Test Voltage	AC 120V/60Hz

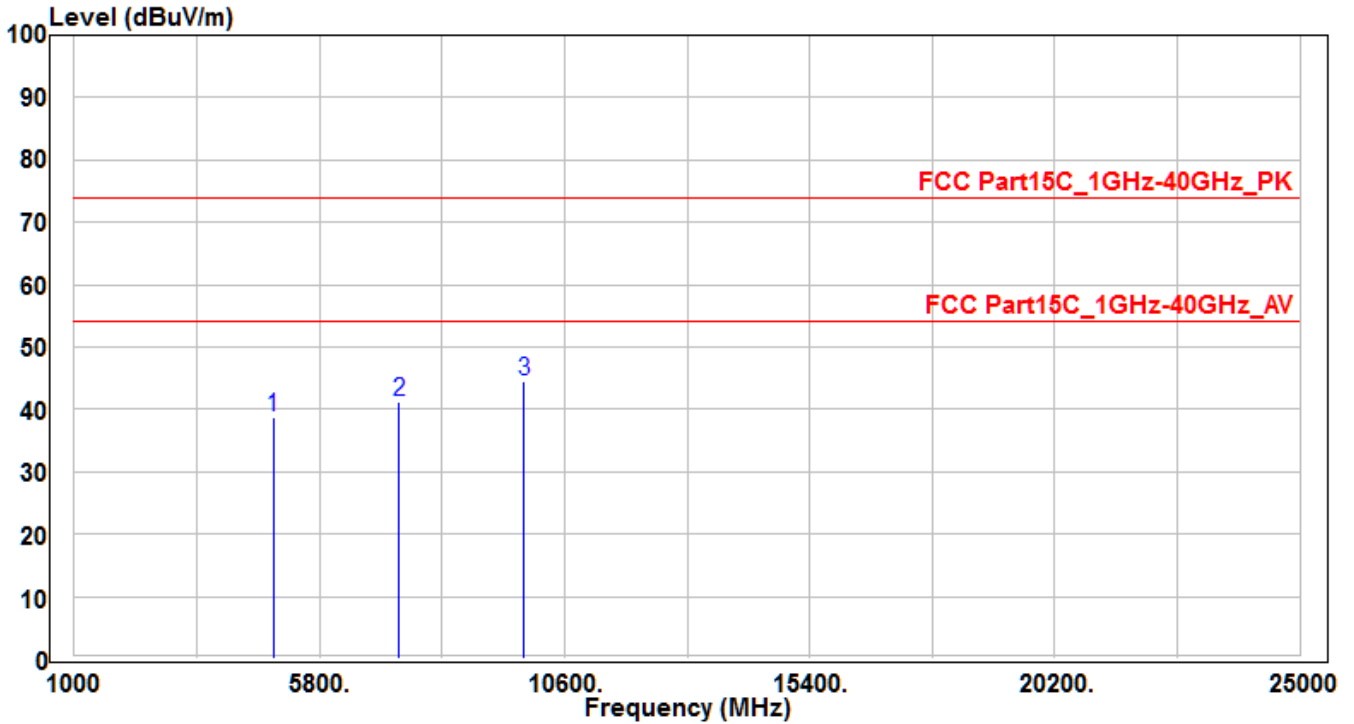

No	Frequency (MHz)	Reading (dBuV)	C.F (dB)	Measurement (dBuV/m)	Margin (dB)	Limit (dBuV/m)	Height (cm)	Angle (deg)	Remark (QP/PK/AV)
1	4904	35.96	2.88	38.84	-35.16	74	150	400	Peak
2	7356	29.33	11.96	41.29	-32.71	74	150	400	Peak
3	*	29.59	14.93	44.52	-29.48	74	150	400	Peak

Note:

1. " * " means this data is the worst emission level.
2. C.F (Correction Factor) = Antenna Factor (dB)+ Cable Loss (dB) - Preamplifier(dB)..
3. Measurement (dBuV/m) = Reading(dBuV) + C.F (Correction Factor).

7.7. Radiated Restricted Band Edge Measurement

7.7.1. Test Limit

All out of band emissions appearing in a restricted band as specified in Section 15.205 of the Title 47 CFR must not exceed the limits shown in Table per Section 15.209.

FCC Part 15 Subpart C Paragraph 15.209		
Frequency [MHz]	Field Strength [V/m]	Measured Distance [Meters]
0.009 - 0.490	2400/F (kHz)	300
0.490 - 1.705	24000/F (kHz)	30
1.705 – 30	30	30
30 – 88	100	3
88 – 216	150	3
216 – 960	200	3
Above 960	500	3

7.7.2. Test Procedure Used

ANSI C63.10-2013 - Section 11.12.1

7.7.3. Test Setting

Peak Field Strength Measurements

1. Analyzer center frequency was set to the frequency of the radiated spurious emission of interest
2. RBW = as specified in Table 1
3. VBW = 3 * RBW
4. Detector = peak
5. Sweep time = auto couple
6. Trace mode = max hold

- Trace was allowed to stabilize

Table 1 - RBW as a function of frequency

Frequency	RBW
9 ~ 150 kHz	200 ~ 300 Hz
0.15 ~ 30 MHz	9 ~ 10 kHz
30 ~ 1000 MHz	100 ~ 120 kHz
> 1000 MHz	1 MHz

Average Field Strength Measurements

- Analyzer center frequency was set to the frequency of the radiated spurious emission of interest
- RBW = 1MHz
- VBW \geq 1/T
- De As an alternative, the instrument may be set to linear detector mode. Ensure that video filtering is applied in linear voltage domain (rather than in a log or dB domain). Some instruments require linear display mode in order to accomplish this. Others have a setting for Average-VBW Type, which can be set to "Voltage" regardless of the display mode
- Detector = Peak
- Sweep time = auto
- Trace mode = max hold
- Allow max hold to run for at least 50 times (1/duty cycle) traces

7.7.4. Test Setup

1GHz ~ 18GHz Test Setup:

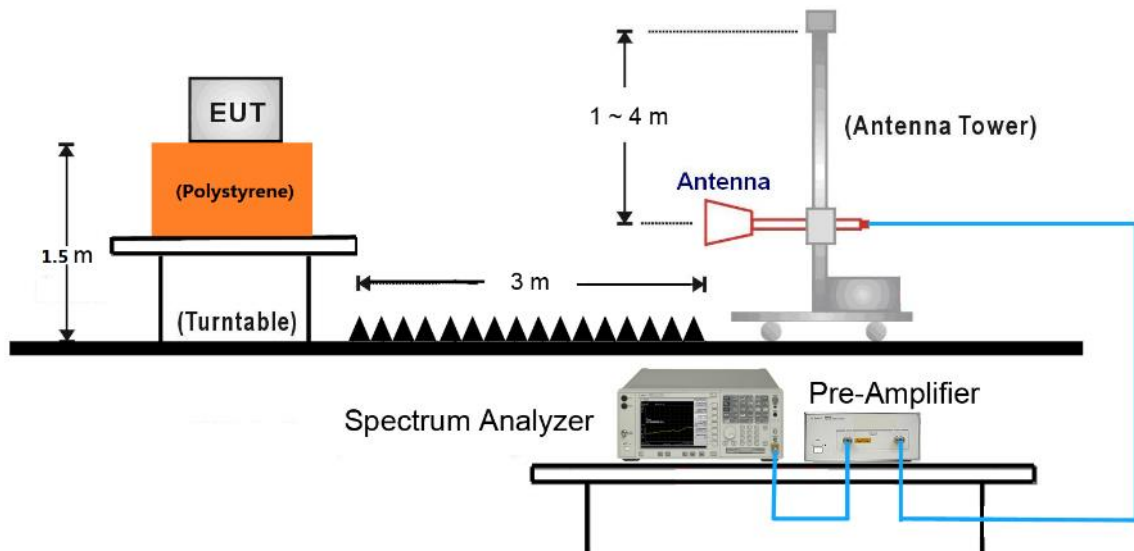

18GHz ~40GHz Test Setup:

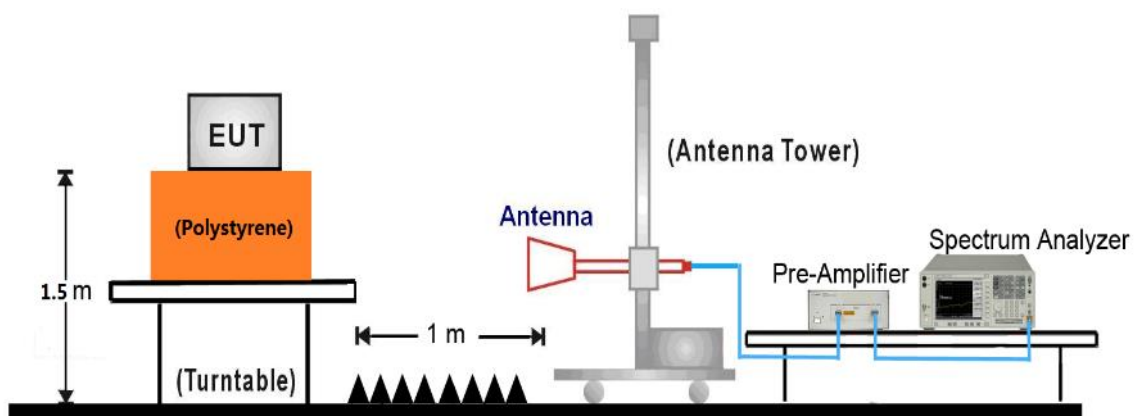

7.7.5. Test Result

EUT	Gateway	Test Date	2018/4/11
Factor	BBHA 9120D (1GHz~18GHz)	Temp. / Humidity	21°C / 57%
Polarity	Horizontal	Site / Engineer	AC1 / Peter
Test Mode	MODE1-CH01	Test Voltage	AC 120V/60Hz

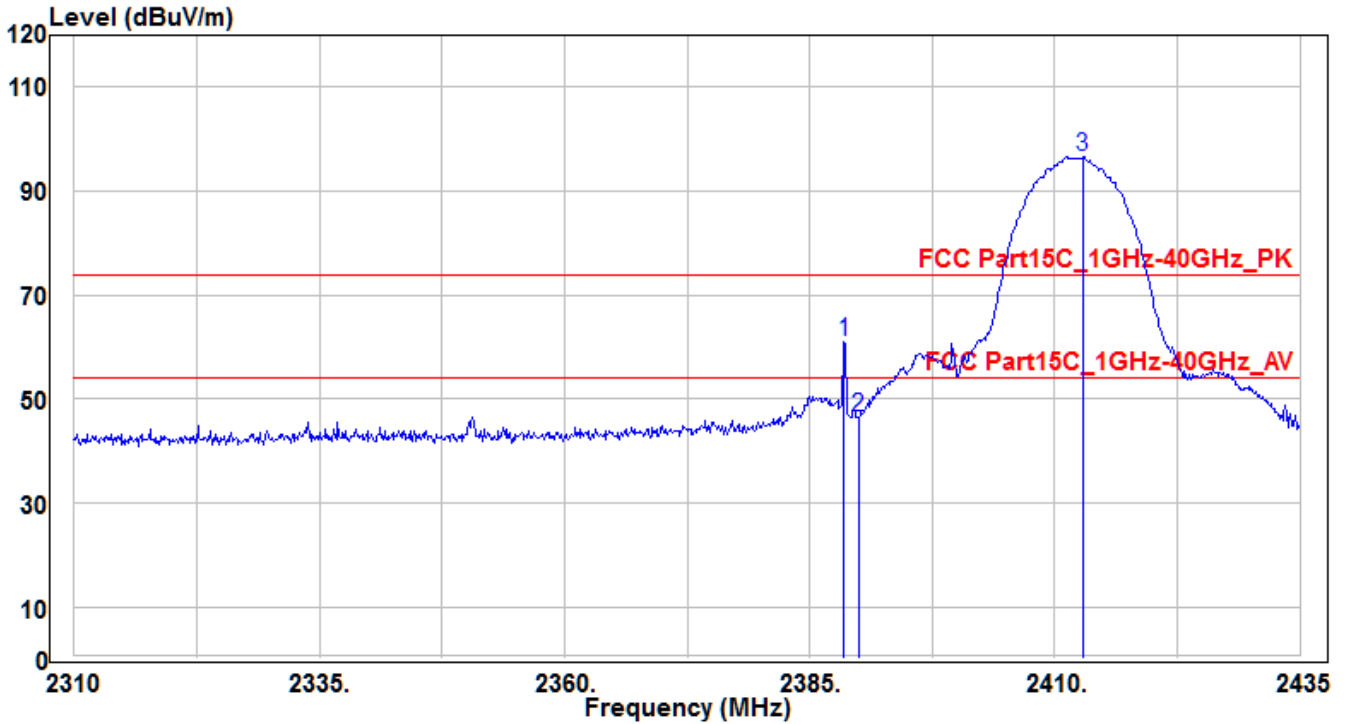

No	Frequency (MHz)	Reading (dBuV)	C.F (dB)	Measurement (dBuV/m)	Margin (dB)	Limit (dBuV/m)	Height (cm)	Angle (deg)	Remark (QP/PK/AV)	
1	*	2388.5	63.64	-2.59	61.05	-12.95	74	150	180	Peak
2		2390	49.24	-2.59	46.65	-27.35	74	150	180	Peak
3		2412.875	99.03	-2.46	96.57	22.57	74	150	180	Peak

Note:

1. " * " means this data is the worst emission level.
2. C.F (Correction Factor) = Antenna Factor (dB)+ Cable Loss (dB) - Preamplifier(dB)..
3. Measurement (dBuV/m) = Reading(dBuV) + C.F (Correction Factor).

EUT	Gateway	Test Date	2018/4/11
Factor	BBHA 9120D (1GHz~18GHz)	Temp. / Humidity	21°C / 57%
Polarity	Horizontal	Site / Engineer	AC1 / Peter
Test Mode	MODE1-CH01	Test Voltage	AC 120V/60Hz

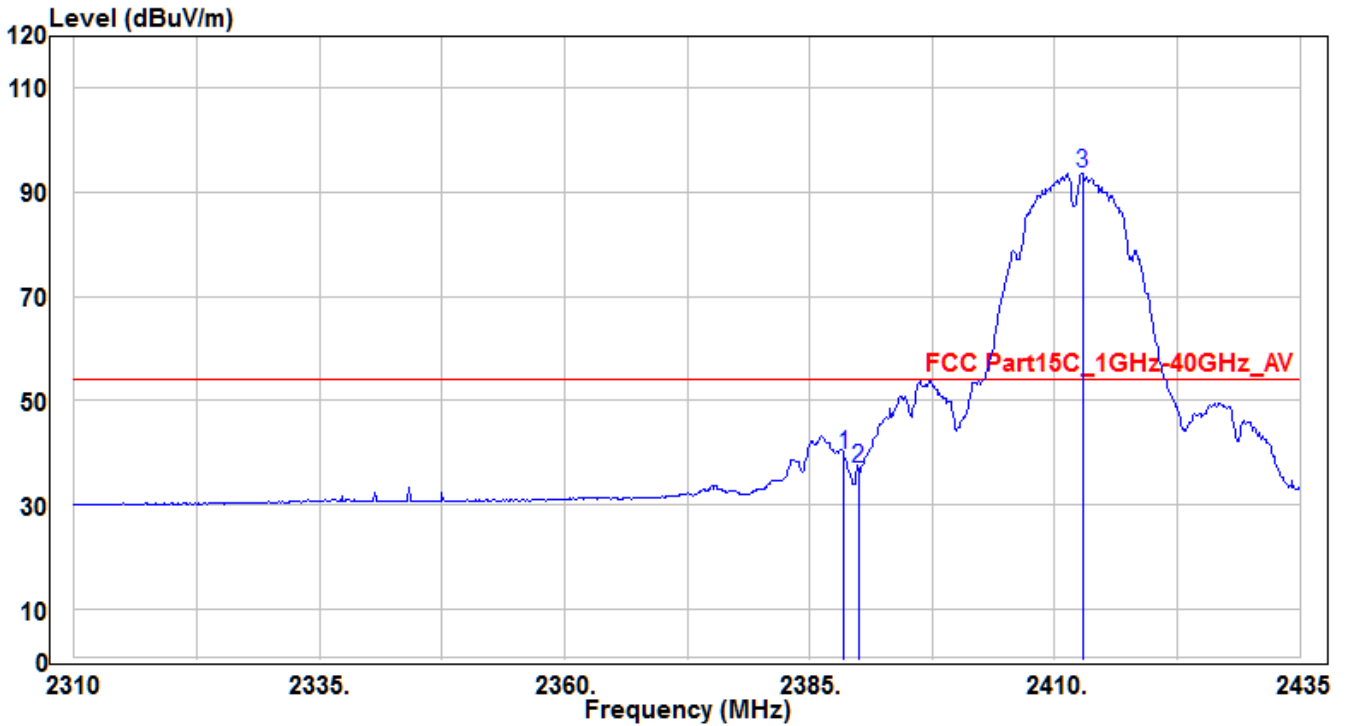

No	Frequency (MHz)	Reading (dBuV)	C.F (dB)	Measurement (dBuV/m)	Margin (dB)	Limit (dBuV/m)	Height (cm)	Angle (deg)	Remark (QP/PK/AV)
1	*	42.16	-2.59	39.57	-14.43	54	150	180	Average
2		39.43	-2.59	36.84	-17.16	54	150	180	Average
3		96.1	-2.46	93.64	39.64	54	150	180	Average

Note:

1. " * " means this data is the worst emission level.
2. C.F (Correction Factor) = Antenna Factor (dB)+ Cable Loss (dB) - Preamplifier(dB)..
3. Measurement (dBuV/m) = Reading(dBuV) + C.F (Correction Factor).

EUT	Gateway	Test Date	2018/4/11
Factor	BBHA 9120D (1GHz~18GHz)	Temp. / Humidity	21°C / 57%
Polarity	Vertical	Site / Engineer	AC1 / Peter
Test Mode	MODE1-CH01	Test Voltage	AC 120V/60Hz

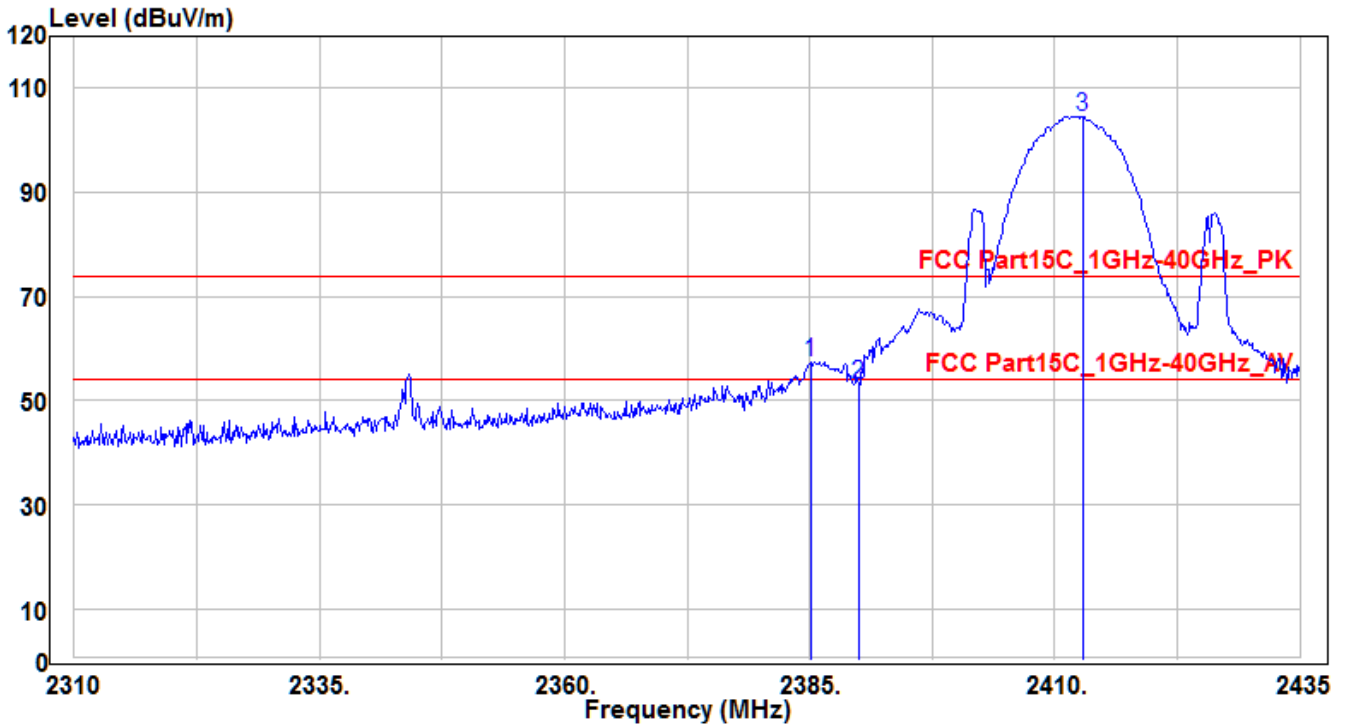

No	Frequency (MHz)	Reading (dBuV)	C.F (dB)	Measurement (dBuV/m)	Margin (dB)	Limit (dBuV/m)	Height (cm)	Angle (deg)	Remark (QP/PK/AV)	
1	*	2385.125	60.16	-2.62	57.54	-16.46	74	220	300	Peak
2		2390	55.61	-2.59	53.02	-20.98	74	220	300	Peak
3		2412.875	107.11	-2.46	104.65	30.65	74	220	300	Peak

Note:

1. " * " means this data is the worst emission level.
2. C.F (Correction Factor) = Antenna Factor (dB)+ Cable Loss (dB) - Preamplifier(dB)..
3. Measurement (dBuV/m) = Reading(dBuV) + C.F (Correction Factor).

EUT	Gateway	Test Date	2018/4/11
Factor	BBHA 9120D (1GHz~18GHz)	Temp. / Humidity	21°C / 57%
Polarity	Vertical	Site / Engineer	AC1 / Peter
Test Mode	MODE1-CH01	Test Voltage	AC 120V/60Hz

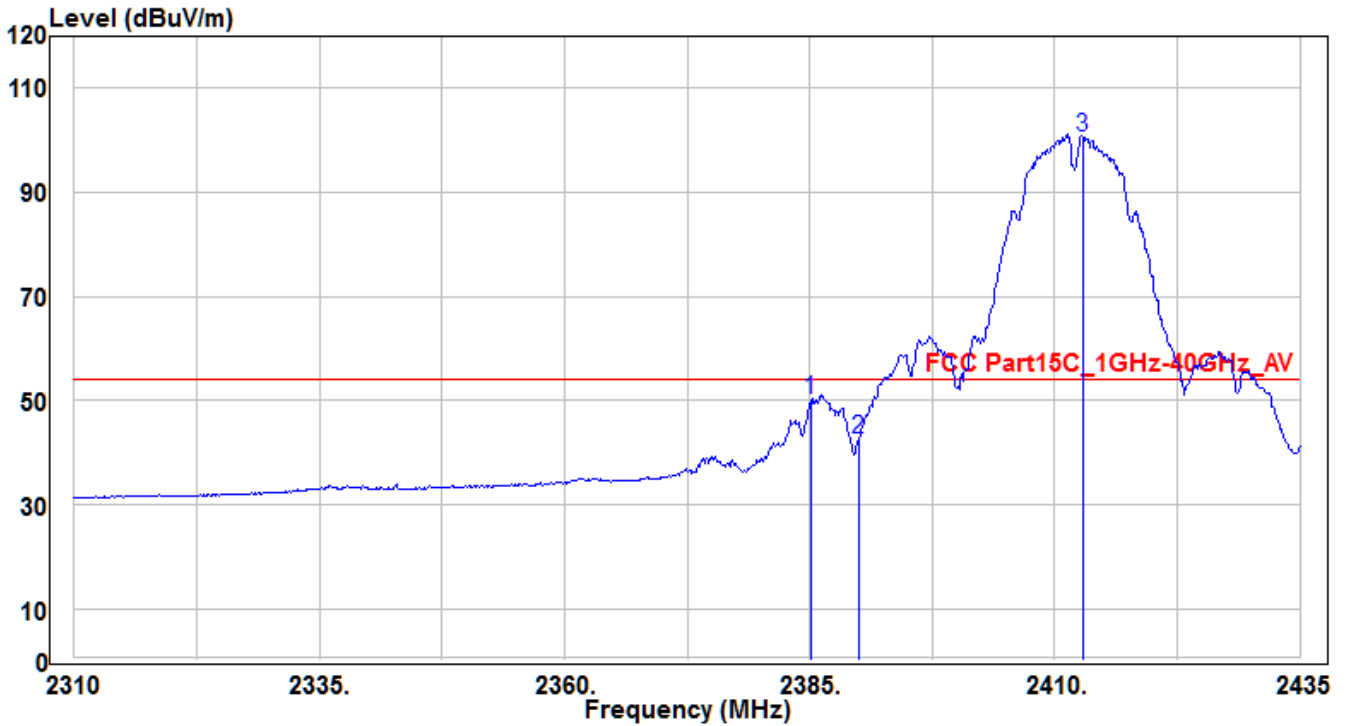

No	Frequency (MHz)	Reading (dBuV)	C.F (dB)	Measurement (dBuV/m)	Margin (dB)	Limit (dBuV/m)	Height (cm)	Angle (deg)	Remark (QP/PK/AV)	
1	*	2385.125	52.82	-2.62	50.2	-3.8	54	220	300	Average
2		2390	45.04	-2.59	42.45	-11.55	54	220	300	Average
3		2412.875	102.96	-2.46	100.5	46.5	54	220	300	Average

Note:

1. " * " means this data is the worst emission level.
2. C.F (Correction Factor) = Antenna Factor (dB)+ Cable Loss (dB) - Preamplifier(dB)..
3. Measurement (dBuV/m) = Reading(dBuV) + C.F (Correction Factor).

EUT	Gateway	Test Date	2018/4/11
Factor	BBHA 9120D (1GHz~18GHz)	Temp. / Humidity	21°C / 57%
Polarity	Horizontal	Site / Engineer	AC1 / Peter
Test Mode	MODE1-CH11	Test Voltage	AC 120V/60Hz

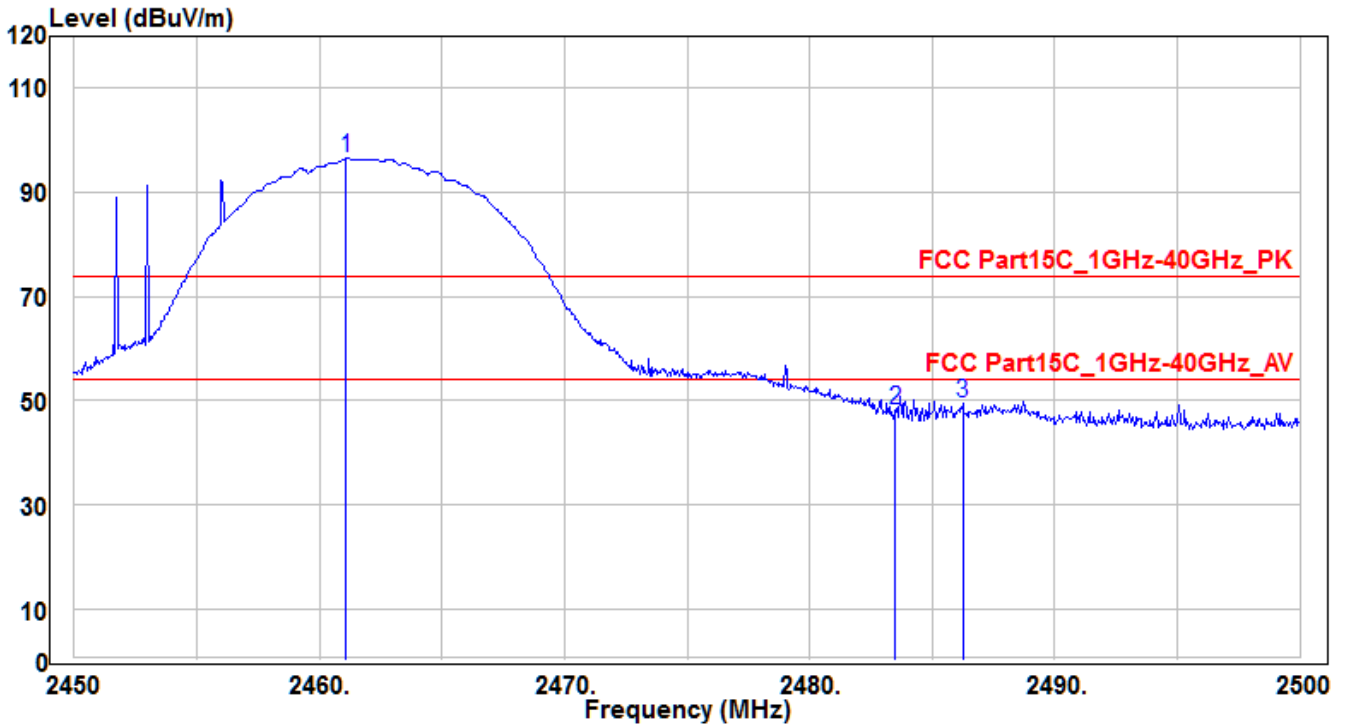

No	Frequency (MHz)	Reading (dBuV)	C.F (dB)	Measurement (dBuV/m)	Margin (dB)	Limit (dBuV/m)	Height (cm)	Angle (deg)	Remark (QP/PK/AV)
1	2461.1	98.77	-2.23	96.54	22.54	74	170	345	Peak
2	2483.5	50.13	-2.11	48.02	-25.98	74	170	345	Peak
3	* 2486.25	51.49	-2.1	49.39	-24.61	74	170	345	Peak

Note:

1. " * " means this data is the worst emission level.
2. C.F (Correction Factor) = Antenna Factor (dB)+ Cable Loss (dB) - Preamplifier(dB)..
3. Measurement (dBuV/m) = Reading(dBuV) + C.F (Correction Factor).

EUT	Gateway	Test Date	2018/4/11
Factor	BBHA 9120D (1GHz~18GHz)	Temp. / Humidity	21°C / 57%
Polarity	Vertical	Site / Engineer	AC1 / Peter
Test Mode	MODE1-CH11	Test Voltage	AC 120V/60Hz

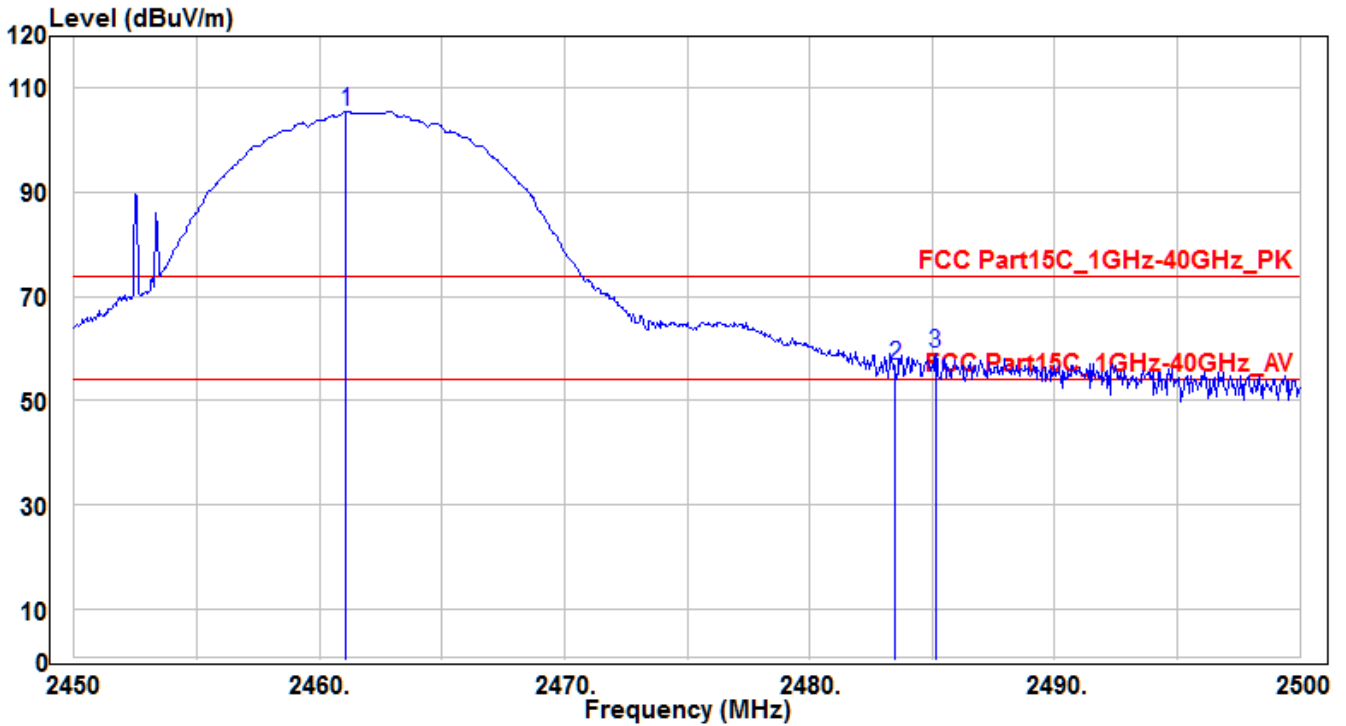

No	Frequency (MHz)	Reading (dBuV)	C.F (dB)	Measurement (dBuV/m)	Margin (dB)	Limit (dBuV/m)	Height (cm)	Angle (deg)	Remark (QP/PK/AV)
1	2461.1	107.72	-2.23	105.49	31.49	74	170	225	Peak
2	2483.5	58.87	-2.11	56.76	-17.24	74	170	225	Peak
3	* 2485.15	61.22	-2.1	59.12	-14.88	74	170	225	Peak

Note:

1. " * " means this data is the worst emission level.
2. C.F (Correction Factor) = Antenna Factor (dB)+ Cable Loss (dB) - Preamplifier(dB)..
3. Measurement (dBuV/m) = Reading(dBuV) + C.F (Correction Factor).

EUT	Gateway	Test Date	2018/4/11
Factor	BBHA 9120D (1GHz~18GHz)	Temp. / Humidity	21°C / 57%
Polarity	Vertical	Site / Engineer	AC1 / Peter
Test Mode	MODE1-CH11	Test Voltage	AC 120V/60Hz

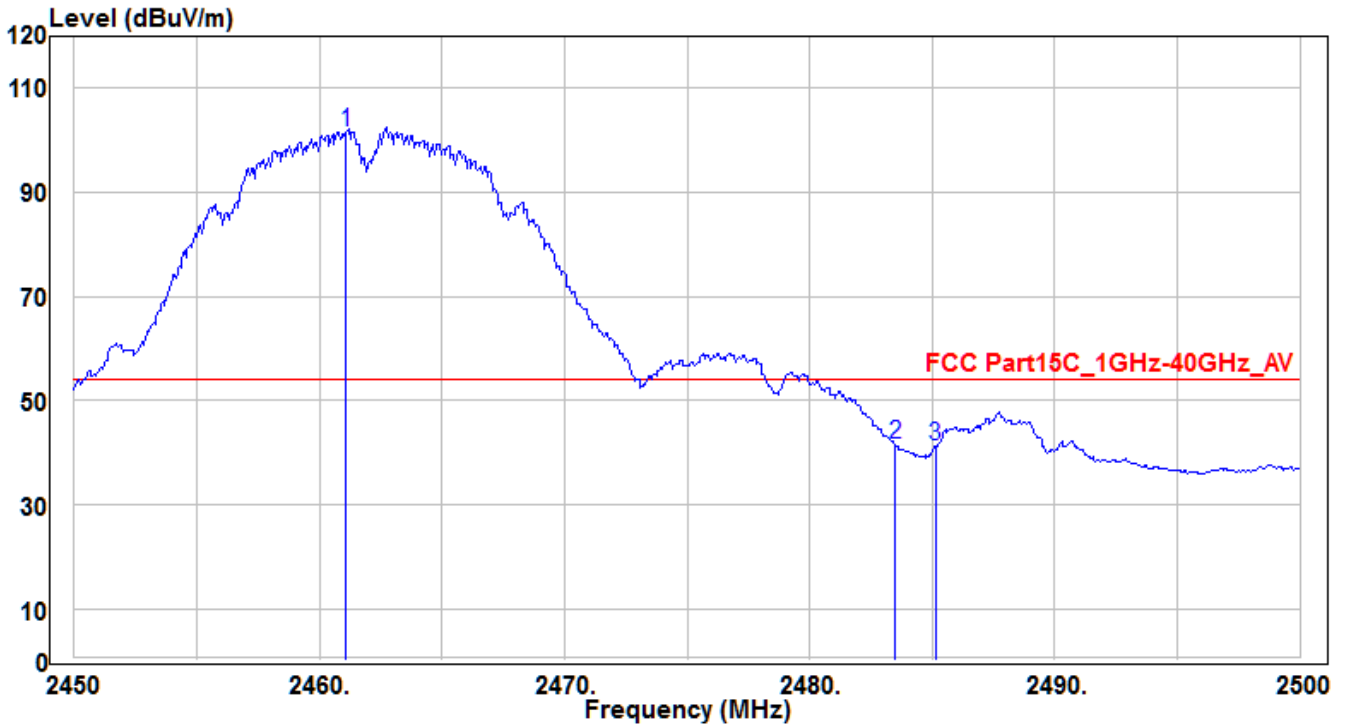

No	Frequency (MHz)	Reading (dBuV)	C.F (dB)	Measurement (dBuV/m)	Margin (dB)	Limit (dBuV/m)	Height (cm)	Angle (deg)	Remark (QP/PK/AV)
1	2461.1	103.66	-2.23	101.43	47.43	54	170	225	Average
2	* 2483.5	43.64	-2.11	41.53	-12.47	54	170	225	Average
3	2485.15	43.37	-2.1	41.27	-12.73	54	170	225	Average

Note:

1. " * " means this data is the worst emission level.
2. C.F (Correction Factor) = Antenna Factor (dB)+ Cable Loss (dB) - Preamplifier(dB)..
3. Measurement (dBuV/m) = Reading(dBuV) + C.F (Correction Factor).

EUT	Gateway	Test Date	2018/4/11
Factor	BBHA 9120D (1GHz~18GHz)	Temp. / Humidity	21°C / 57%
Polarity	Horizontal	Site / Engineer	AC1 / Peter
Test Mode	MODE2-CH01	Test Voltage	AC 120V/60Hz

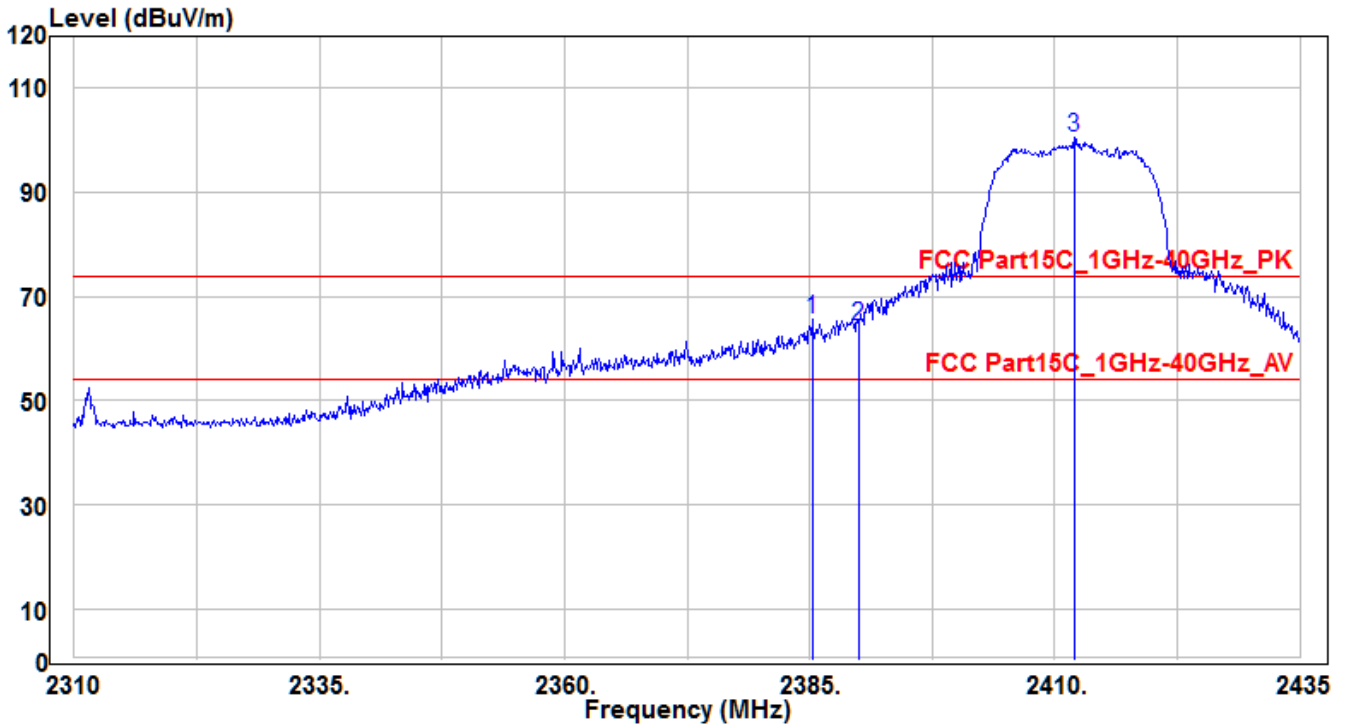

No	Frequency (MHz)	Reading (dBuV)	C.F (dB)	Measurement (dBuV/m)	Margin (dB)	Limit (dBuV/m)	Height (cm)	Angle (deg)	Remark (QP/PK/AV)	
1	*	2385.25	68.16	-2.62	65.54	-8.46	74	170	350	Peak
2		2390	66.97	-2.59	64.38	-9.62	74	170	350	Peak
3		2412	102.99	-2.49	100.5	26.5	74	170	350	Peak

Note:

1. " * " means this data is the worst emission level.
2. C.F (Correction Factor) = Antenna Factor (dB)+ Cable Loss (dB) - Preamplifier(dB)..
3. Measurement (dBuV/m) = Reading(dBuV) + C.F (Correction Factor).

EUT	Gateway	Test Date	2018/4/11
Factor	BBHA 9120D (1GHz~18GHz)	Temp. / Humidity	21°C / 57%
Polarity	Horizontal	Site / Engineer	AC1 / Peter
Test Mode	MODE2-CH01	Test Voltage	AC 120V/60Hz

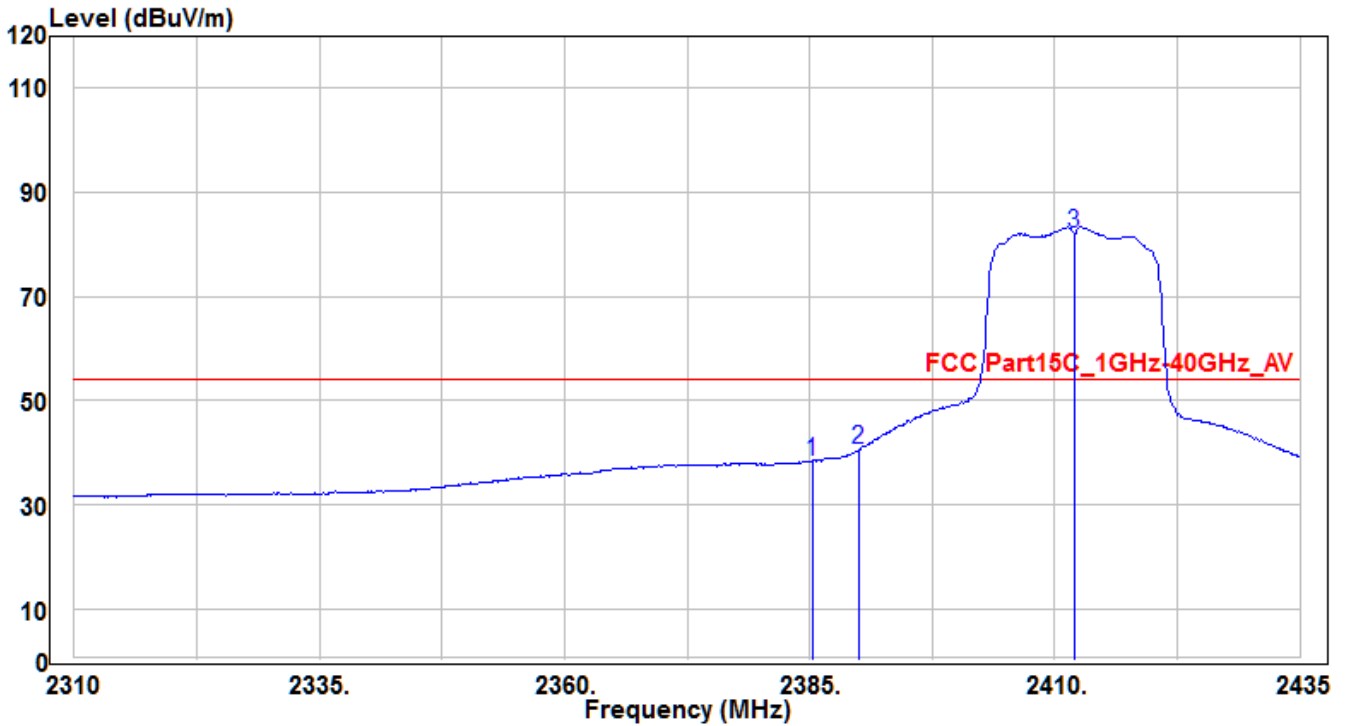

No	Frequency (MHz)	Reading (dBuV)	C.F (dB)	Measurement (dBuV/m)	Margin (dB)	Limit (dBuV/m)	Height (cm)	Angle (deg)	Remark (QP/PK/AV)
1	2385.25	40.85	-2.62	38.23	-15.77	54	170	350	Average
2	* 2390	43.08	-2.59	40.49	-13.51	54	170	350	Average
3	2412	84.45	-2.49	81.96	27.96	54	170	350	Average

Note:

1. " * " means this data is the worst emission level.
2. C.F (Correction Factor) = Antenna Factor (dB)+ Cable Loss (dB) - Preamplifier(dB)..
3. Measurement (dBuV/m) = Reading(dBuV) + C.F (Correction Factor).

EUT	Gateway	Test Date	2018/4/11
Factor	BBHA 9120D (1GHz~18GHz)	Temp. / Humidity	21°C / 57%
Polarity	Vertical	Site / Engineer	AC1 / Peter
Test Mode	MODE2-CH01	Test Voltage	AC 120V/60Hz

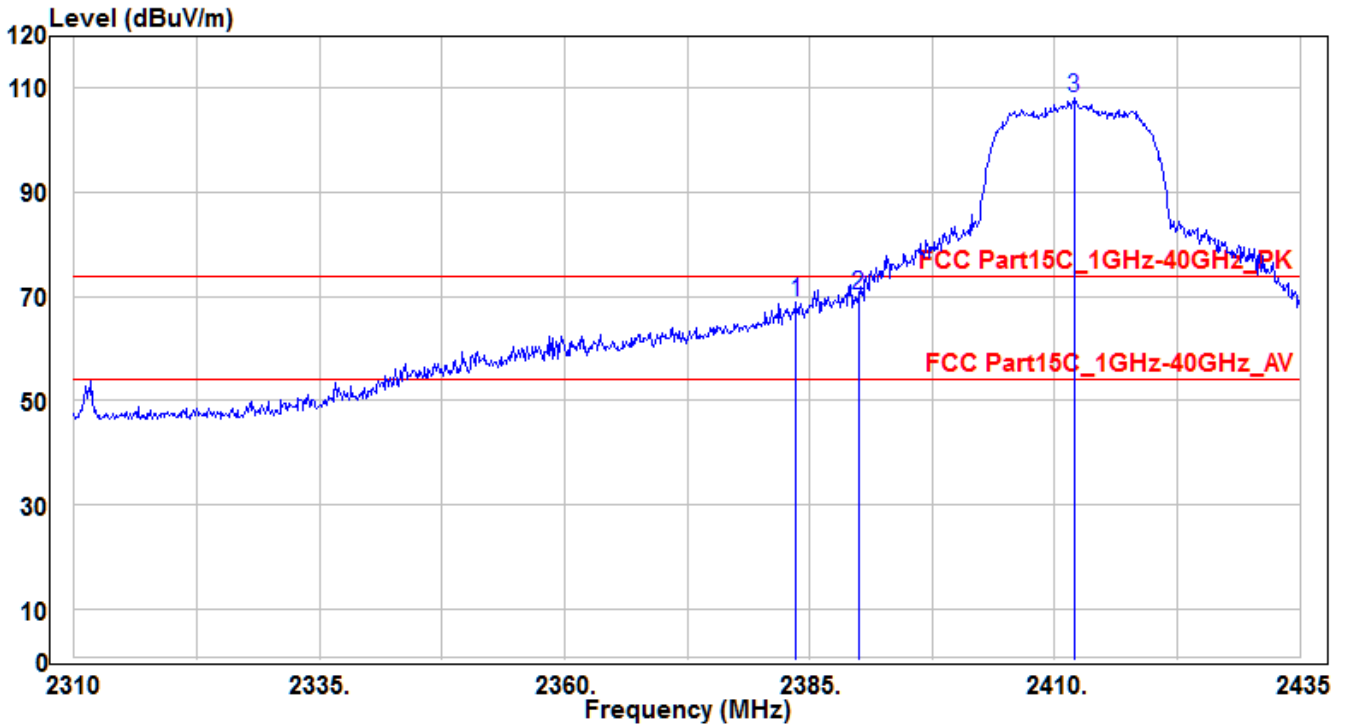

No	Frequency (MHz)	Reading (dBuV)	C.F (dB)	Measurement (dBuV/m)	Margin (dB)	Limit (dBuV/m)	Height (cm)	Angle (deg)	Remark (QP/PK/AV)
1	2383.625	71.6	-2.63	68.97	-5.03	74	150	220	Peak
2	* 2390	72.94	-2.59	70.35	-3.65	74	150	220	Peak
3	2412	110.74	-2.49	108.25	34.25	74	150	220	Peak

Note:

1. " * " means this data is the worst emission level.
2. C.F (Correction Factor) = Antenna Factor (dB)+ Cable Loss (dB) - Preamplifier(dB)..
3. Measurement (dBuV/m) = Reading(dBuV) + C.F (Correction Factor).

EUT	Gateway	Test Date	2018/4/11
Factor	BBHA 9120D (1GHz~18GHz)	Temp. / Humidity	21°C / 57%
Polarity	Vertical	Site / Engineer	AC1 / Peter
Test Mode	MODE2-CH01	Test Voltage	AC 120V/60Hz

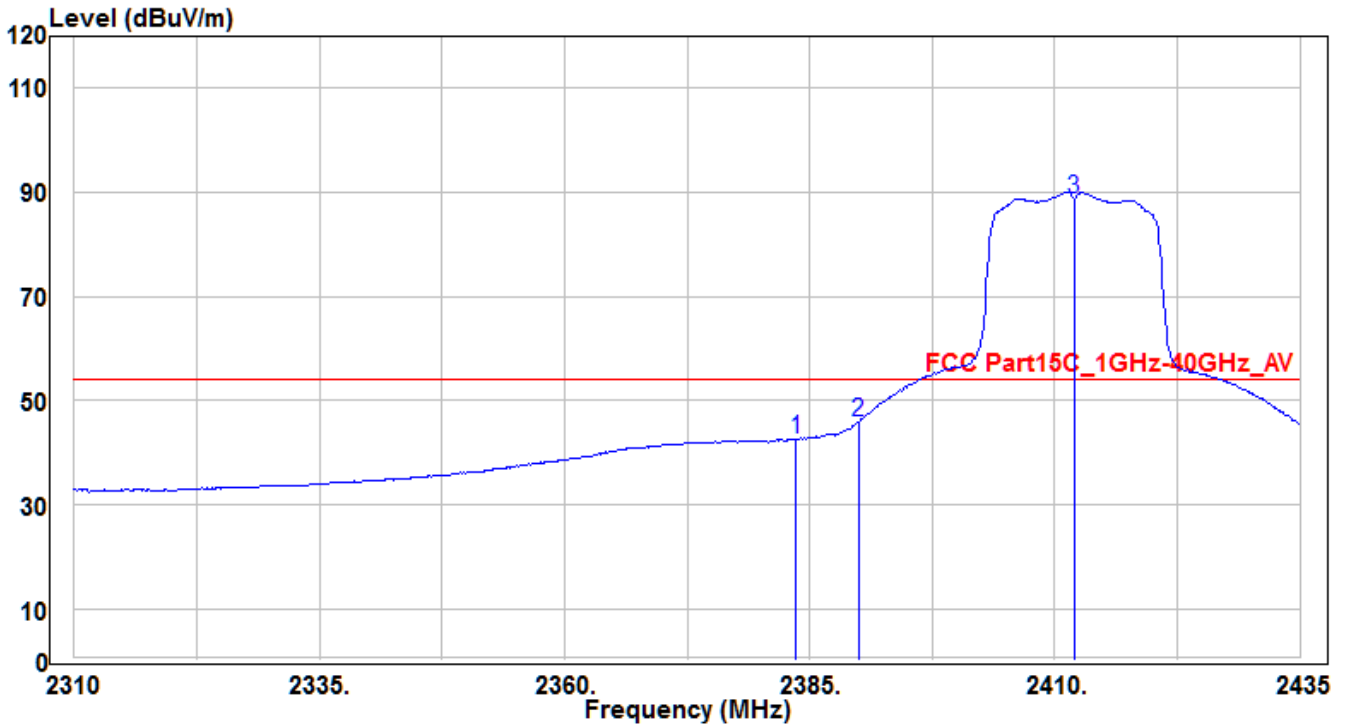

No	Frequency (MHz)	Reading (dBuV)	C.F (dB)	Measurement (dBuV/m)	Margin (dB)	Limit (dBuV/m)	Height (cm)	Angle (deg)	Remark (QP/PK/AV)
1	2383.625	45.26	-2.63	42.63	-11.37	54	150	220	Average
2	* 2390	48.53	-2.59	45.94	-8.06	54	150	220	Average
3	2412	91.05	-2.49	88.56	34.56	54	150	220	Average

Note:

1. " * " means this data is the worst emission level.
2. C.F (Correction Factor) = Antenna Factor (dB)+ Cable Loss (dB) - Preamplifier(dB)..
3. Measurement (dBuV/m) = Reading(dBuV) + C.F (Correction Factor).

EUT	Gateway	Test Date	2018/4/11
Factor	BBHA 9120D (1GHz~18GHz)	Temp. / Humidity	21°C / 57%
Polarity	Horizontal	Site / Engineer	AC1 / Peter
Test Mode	MODE2-CH11	Test Voltage	AC 120V/60Hz

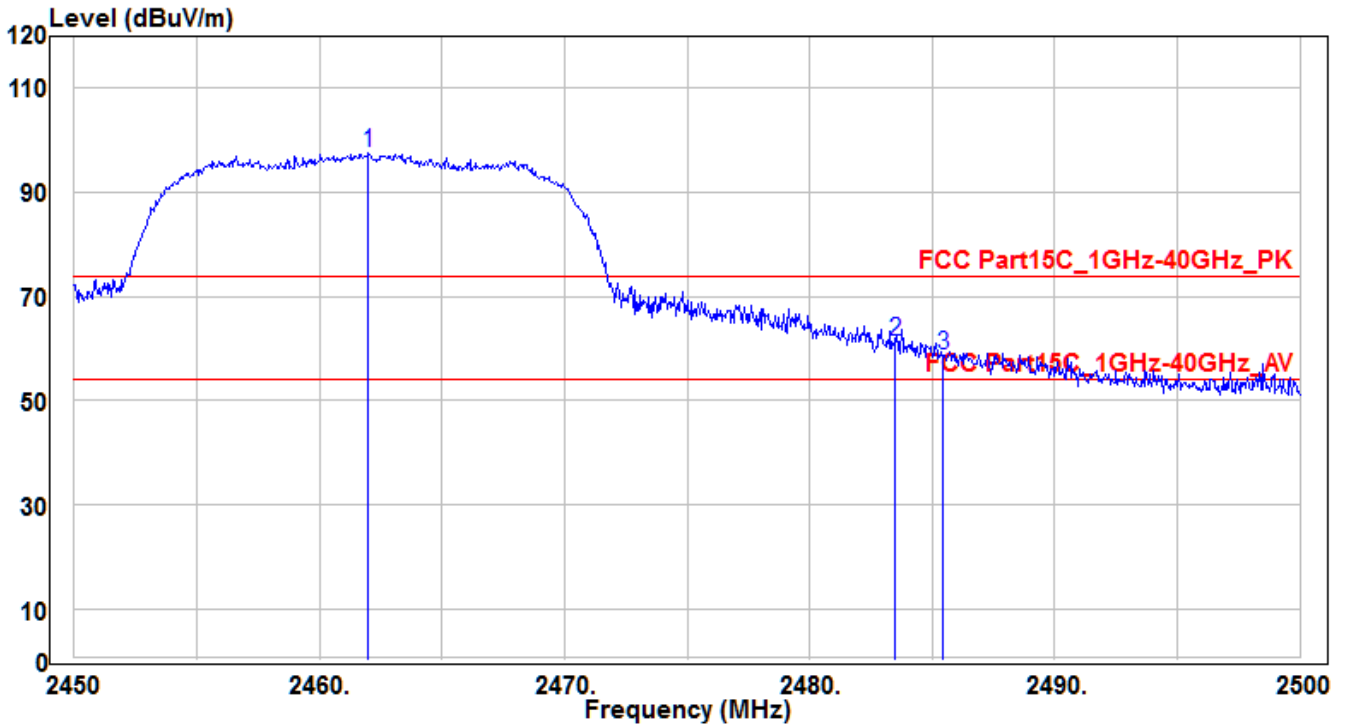

No	Frequency (MHz)	Reading (dBuV)	C.F (dB)	Measurement (dBuV/m)	Margin (dB)	Limit (dBuV/m)	Height (cm)	Angle (deg)	Remark (QP/PK/AV)
1	2462	99.79	-2.23	97.56	23.56	74	165	345	Peak
2	* 2483.5	63.51	-2.11	61.4	-12.6	74	165	345	Peak
3	2485.45	60.65	-2.1	58.55	-15.45	74	165	345	Peak

Note:

1. " * " means this data is the worst emission level.
2. C.F (Correction Factor) = Antenna Factor (dB)+ Cable Loss (dB) - Preamplifier(dB)..
3. Measurement (dBuV/m) = Reading(dBuV) + C.F (Correction Factor).

EUT	Gateway	Test Date	2018/4/11
Factor	BBHA 9120D (1GHz~18GHz)	Temp. / Humidity	21°C / 57%
Polarity	Horizontal	Site / Engineer	AC1 / Peter
Test Mode	MODE2-CH11	Test Voltage	AC 120V/60Hz

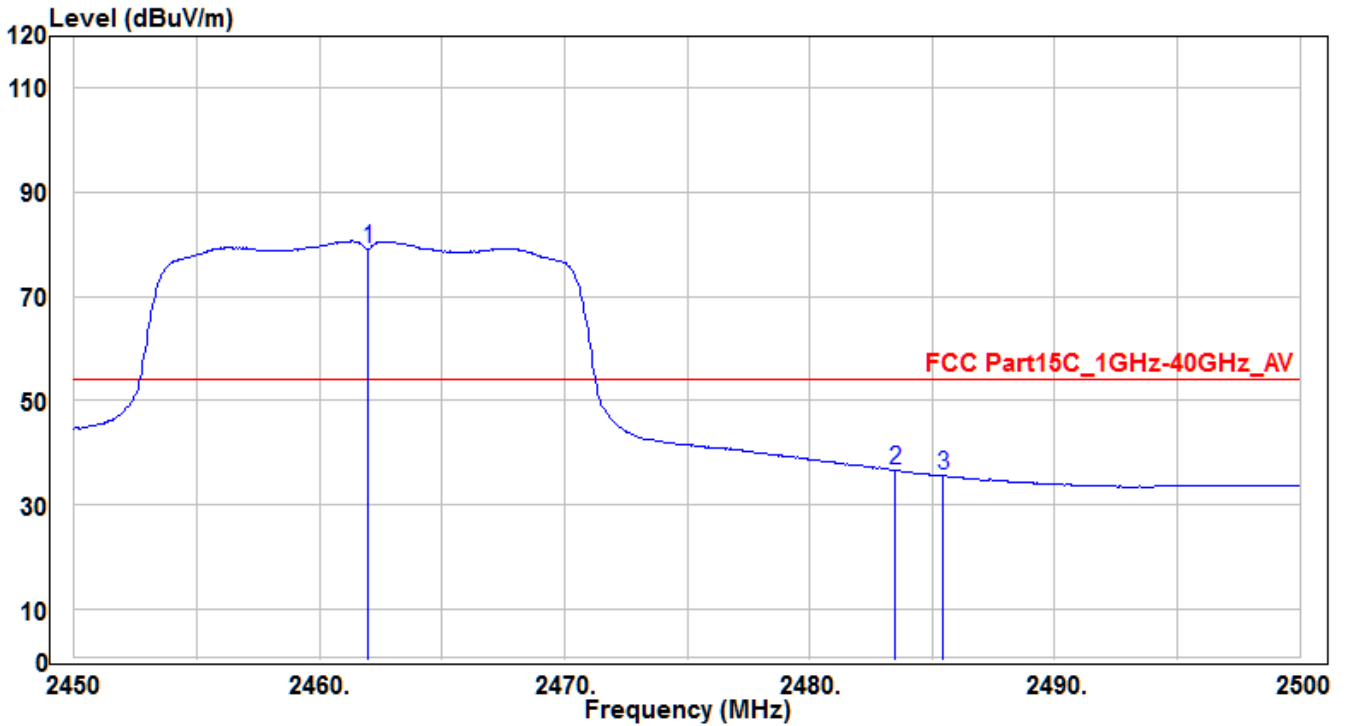

No	Frequency (MHz)	Reading (dBuV)	C.F (dB)	Measurement (dBuV/m)	Margin (dB)	Limit (dBuV/m)	Height (cm)	Angle (deg)	Remark (QP/PK/AV)
1	2462	81.39	-2.23	79.16	25.16	54	165	345	Average
2	* 2483.5	38.62	-2.11	36.51	-17.49	54	165	345	Average
3	2485.45	37.58	-2.1	35.48	-18.52	54	165	345	Average

Note:

1. " * " means this data is the worst emission level.
2. C.F (Correction Factor) = Antenna Factor (dB)+ Cable Loss (dB) - Preamplifier(dB)..
3. Measurement (dBuV/m) = Reading(dBuV) + C.F (Correction Factor).

EUT	Gateway	Test Date	2018/4/11
Factor	BBHA 9120D (1GHz~18GHz)	Temp. / Humidity	21°C / 57%
Polarity	Vertical	Site / Engineer	AC1 / Peter
Test Mode	MODE2-CH11	Test Voltage	AC 120V/60Hz

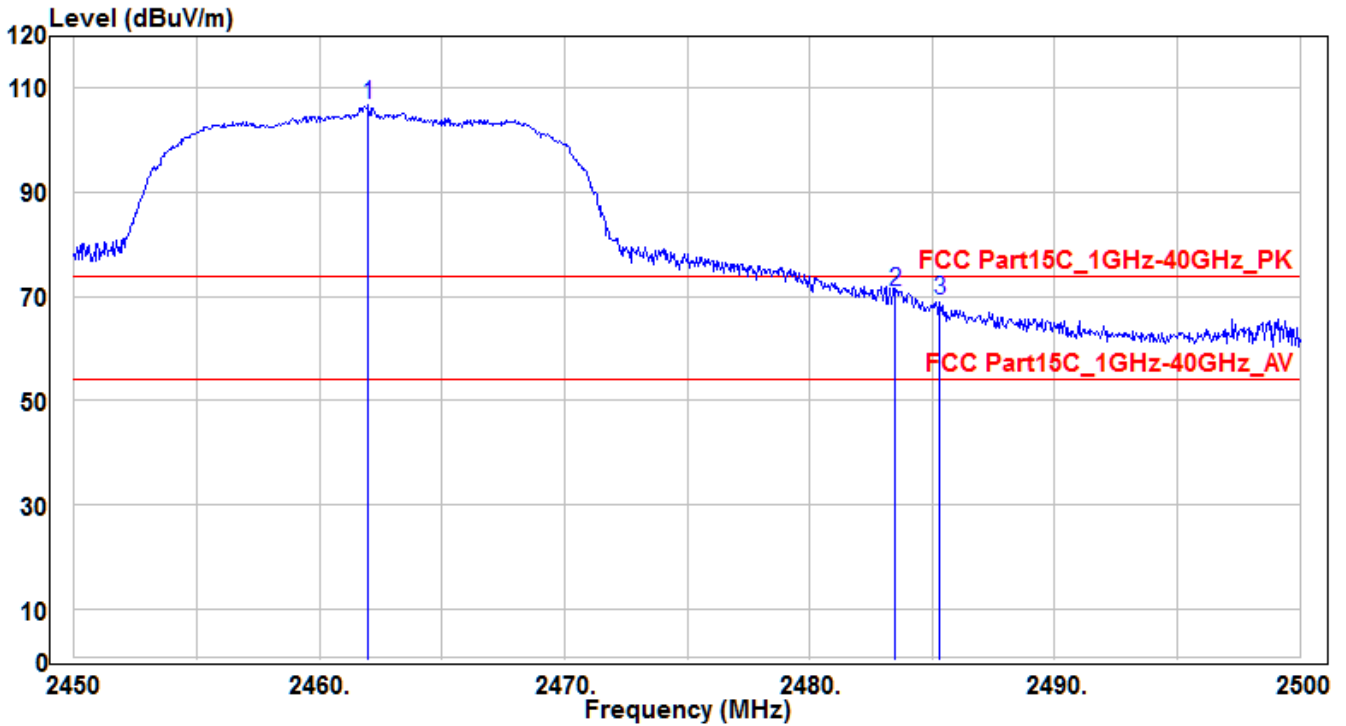

No	Frequency (MHz)	Reading (dBuV)	C.F (dB)	Measurement (dBuV/m)	Margin (dB)	Limit (dBuV/m)	Height (cm)	Angle (deg)	Remark (QP/PK/AV)
1	2462	108.97	-2.23	106.74	32.74	74	160	210	Peak
2	* 2483.5	73.16	-2.11	71.05	-2.95	74	160	210	Peak
3	2485.3	71.4	-2.1	69.3	-4.7	74	160	210	Peak

Note:

1. " * " means this data is the worst emission level.
2. C.F (Correction Factor) = Antenna Factor (dB)+ Cable Loss (dB) - Preamplifier(dB)..
3. Measurement (dBuV/m) = Reading(dBuV) + C.F (Correction Factor).

EUT	Gateway	Test Date	2018/4/11
Factor	BBHA 9120D (1GHz~18GHz)	Temp. / Humidity	21°C / 57%
Polarity	Vertical	Site / Engineer	AC1 / Peter
Test Mode	MODE2-CH11	Test Voltage	AC 120V/60Hz

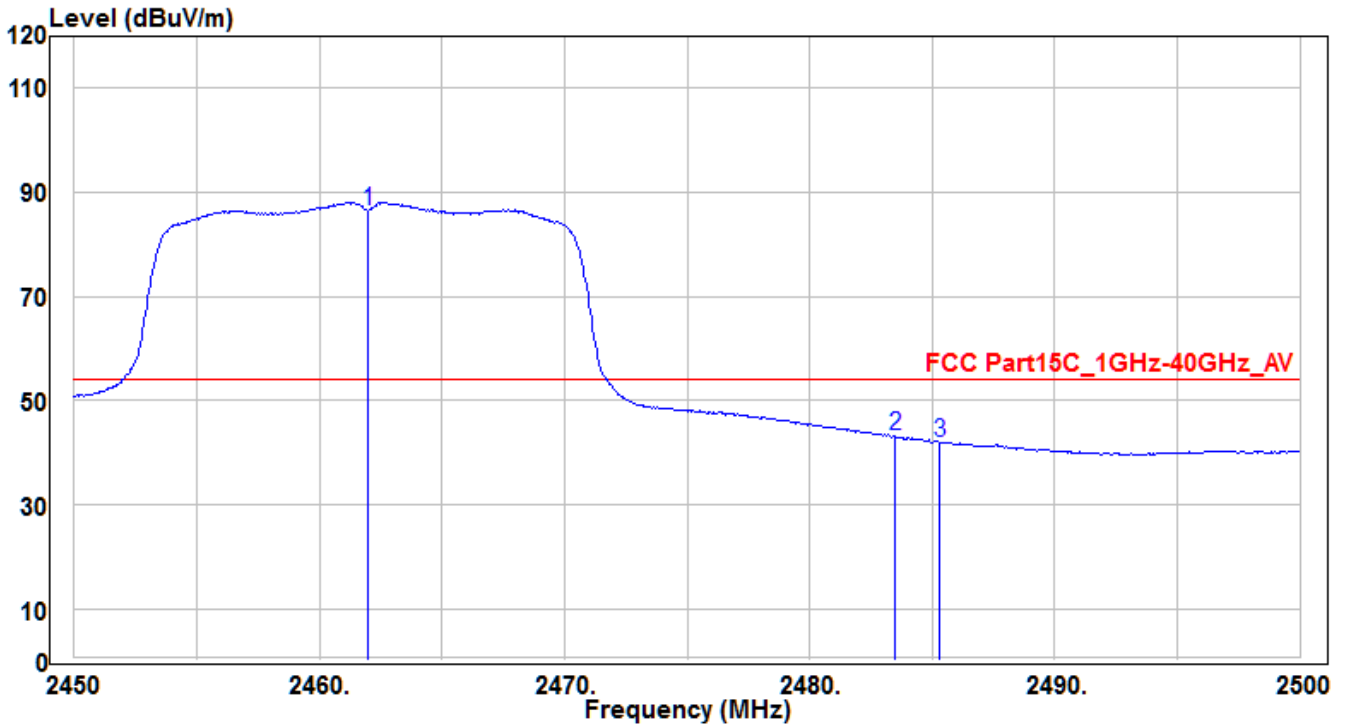

No	Frequency (MHz)	Reading (dBuV)	C.F (dB)	Measurement (dBuV/m)	Margin (dB)	Limit (dBuV/m)	Height (cm)	Angle (deg)	Remark (QP/PK/AV)
1	2462	88.73	-2.23	86.5	32.5	54	160	210	Average
2	* 2483.5	45.16	-2.11	43.05	-10.95	54	160	210	Average
3	2485.3	44.07	-2.1	41.97	-12.03	54	160	210	Average

Note:

1. " * " means this data is the worst emission level.
2. C.F (Correction Factor) = Antenna Factor (dB)+ Cable Loss (dB) - Preamplifier(dB)..
3. Measurement (dBuV/m) = Reading(dBuV) + C.F (Correction Factor).

EUT	Gateway	Test Date	2018/4/11
Factor	BBHA 9120D (1GHz~18GHz)	Temp. / Humidity	21°C / 57%
Polarity	Horizontal	Site / Engineer	AC1 / Peter
Test Mode	MODE3-CH01	Test Voltage	AC 120V/60Hz

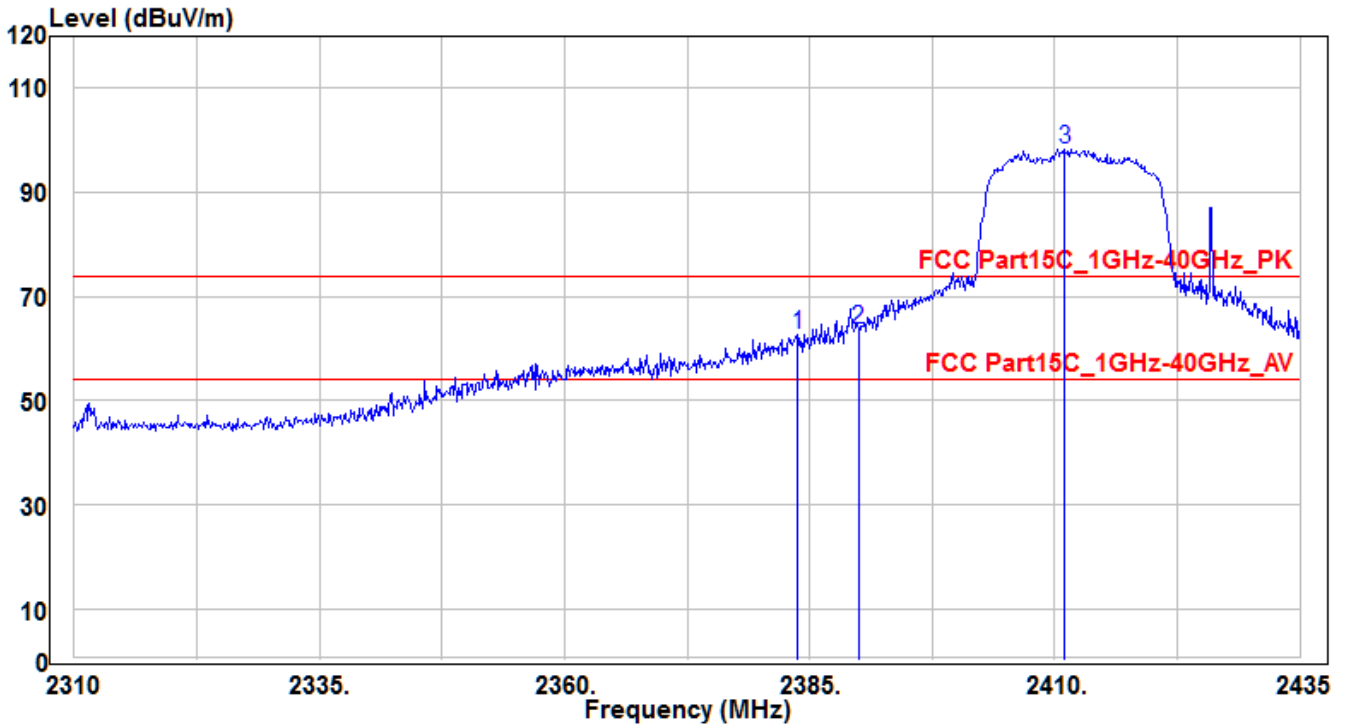

No	Frequency (MHz)	Reading (dBuV)	C.F (dB)	Measurement (dBuV/m)	Margin (dB)	Limit (dBuV/m)	Height (cm)	Angle (deg)	Remark (QP/PK/AV)
1	2383.75	65.21	-2.63	62.58	-11.42	74	175	345	Peak
2	* 2390	66.22	-2.59	63.63	-10.37	74	175	345	Peak
3	2411	100.86	-2.49	98.37	24.37	74	175	345	Peak

Note:

- "*" means this data is the worst emission level.
- C.F (Correction Factor) = Antenna Factor (dB)+ Cable Loss (dB) - Preamplifier(dB)..
- Measurement (dBuV/m) = Reading(dBuV) + C.F (Correction Factor).

EUT	Gateway	Test Date	2018/4/11
Factor	BBHA 9120D (1GHz~18GHz)	Temp. / Humidity	21°C / 57%
Polarity	Horizontal	Site / Engineer	AC1 / Peter
Test Mode	MODE3-CH01	Test Voltage	AC 120V/60Hz

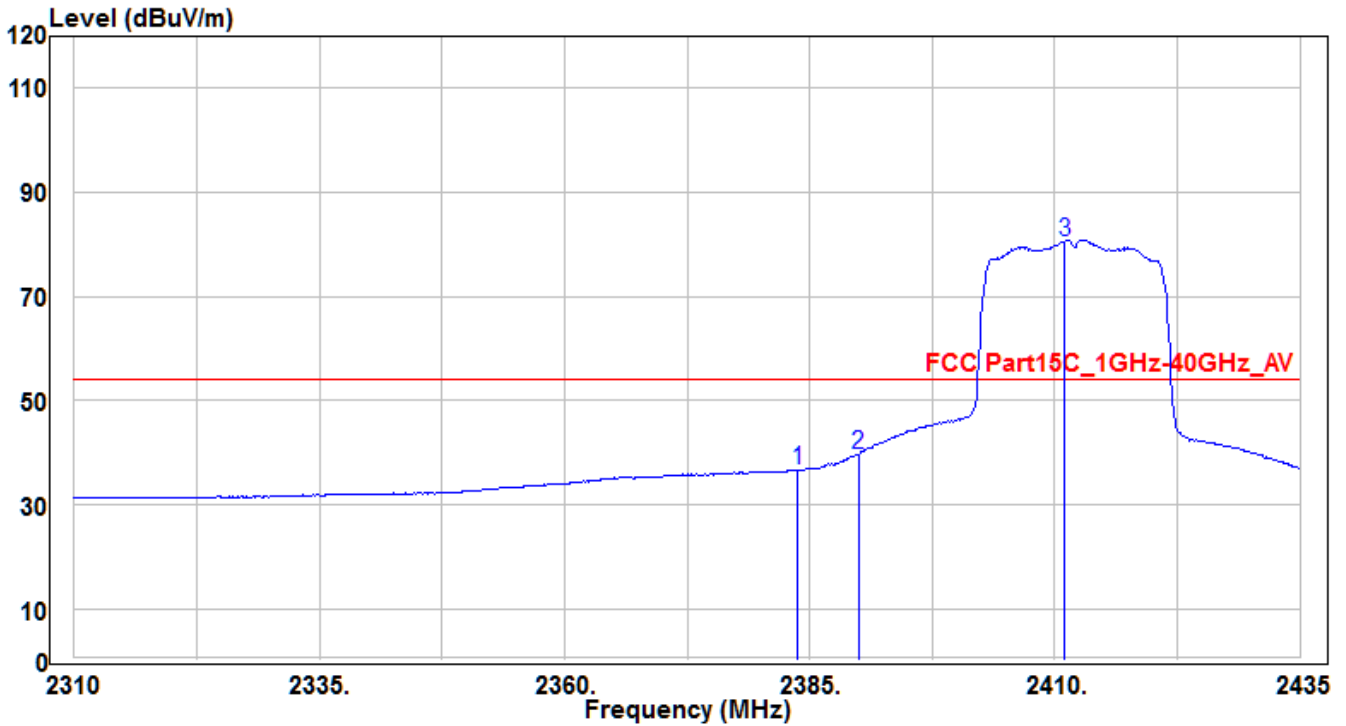

No	Frequency (MHz)	Reading (dBuV)	C.F (dB)	Measurement (dBuV/m)	Margin (dB)	Limit (dBuV/m)	Height (cm)	Angle (deg)	Remark (QP/PK/AV)
1	2383.75	39.25	-2.63	36.62	-17.38	54	175	345	Average
2	* 2390	42.27	-2.59	39.68	-14.32	54	175	345	Average
3	2411	83.07	-2.49	80.58	26.58	54	175	345	Average

Note:

- "*" means this data is the worst emission level.
- C.F (Correction Factor) = Antenna Factor (dB)+ Cable Loss (dB) - Preamplifier(dB)..
- Measurement (dBuV/m) = Reading(dBuV) + C.F (Correction Factor).

EUT	Gateway	Test Date	2018/4/11
Factor	BBHA 9120D (1GHz~18GHz)	Temp. / Humidity	21°C / 57%
Polarity	Vertical	Site / Engineer	AC1 / Peter
Test Mode	MODE3-CH01	Test Voltage	AC 120V/60Hz

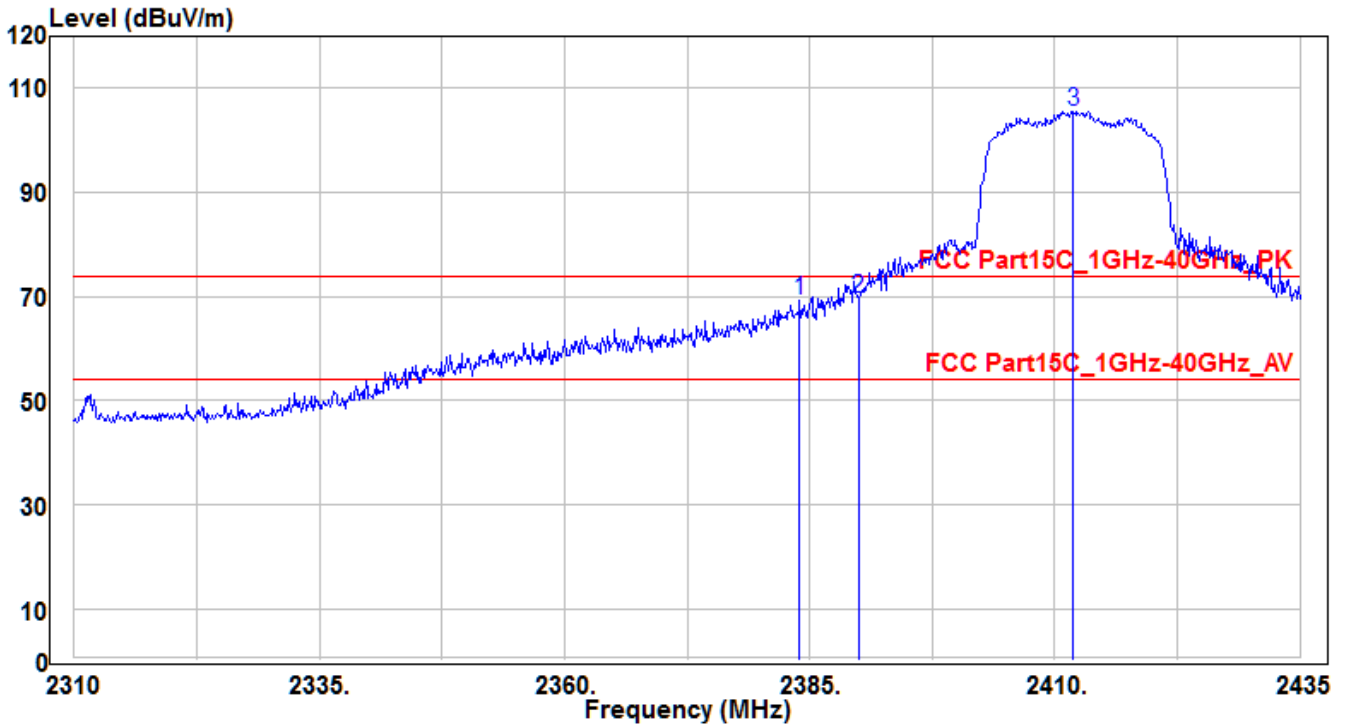

No	Frequency (MHz)	Reading (dBuV)	C.F (dB)	Measurement (dBuV/m)	Margin (dB)	Limit (dBuV/m)	Height (cm)	Angle (deg)	Remark (QP/PK/AV)
1	2384	72	-2.62	69.38	-4.62	74	180	105	Peak
2	* 2390	72.22	-2.59	69.63	-4.37	74	180	105	Peak
3	2411.875	108.1	-2.49	105.61	31.61	74	180	105	Peak

Note:

- "*" means this data is the worst emission level.
- C.F (Correction Factor) = Antenna Factor (dB)+ Cable Loss (dB) - Preamplifier(dB)..
- Measurement (dBuV/m) = Reading(dBuV) + C.F (Correction Factor).

EUT	Gateway	Test Date	2018/4/11
Factor	BBHA 9120D (1GHz~18GHz)	Temp. / Humidity	21°C / 57%
Polarity	Vertical	Site / Engineer	AC1 / Peter
Test Mode	MODE3-CH01	Test Voltage	AC 120V/60Hz

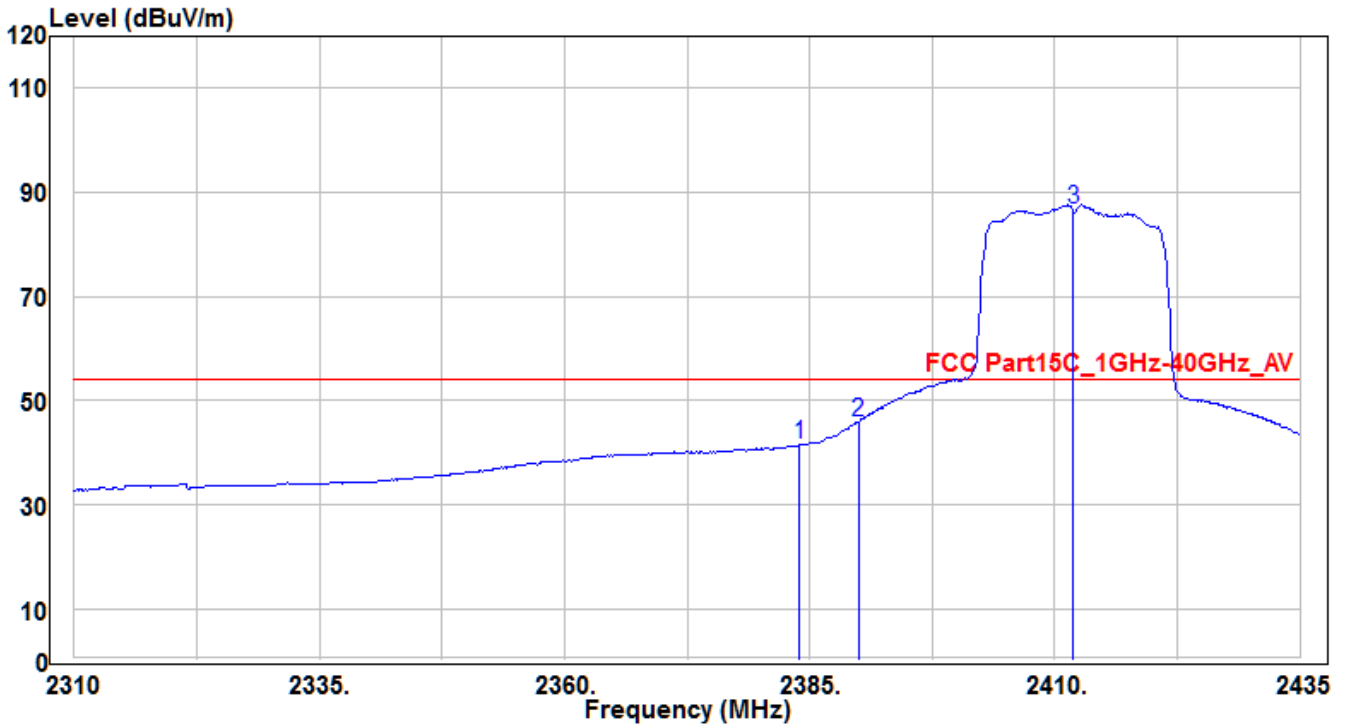

No	Frequency (MHz)	Reading (dBuV)	C.F (dB)	Measurement (dBuV/m)	Margin (dB)	Limit (dBuV/m)	Height (cm)	Angle (deg)	Remark (QP/PK/AV)
1	2384	44.04	-2.62	41.42	-12.58	54	180	105	Average
2	* 2390	48.5	-2.59	45.91	-8.09	54	180	105	Average
3	2411.875	89.13	-2.49	86.64	32.64	54	180	105	Average

Note:

1. " * " means this data is the worst emission level.
2. C.F (Correction Factor) = Antenna Factor (dB)+ Cable Loss (dB) - Preamplifier(dB)..
3. Measurement (dBuV/m) = Reading(dBuV) + C.F (Correction Factor).

EUT	Gateway	Test Date	2018/4/11
Factor	BBHA 9120D (1GHz~18GHz)	Temp. / Humidity	21°C / 57%
Polarity	Horizontal	Site / Engineer	AC1 / Peter
Test Mode	MODE3-CH11	Test Voltage	AC 120V/60Hz

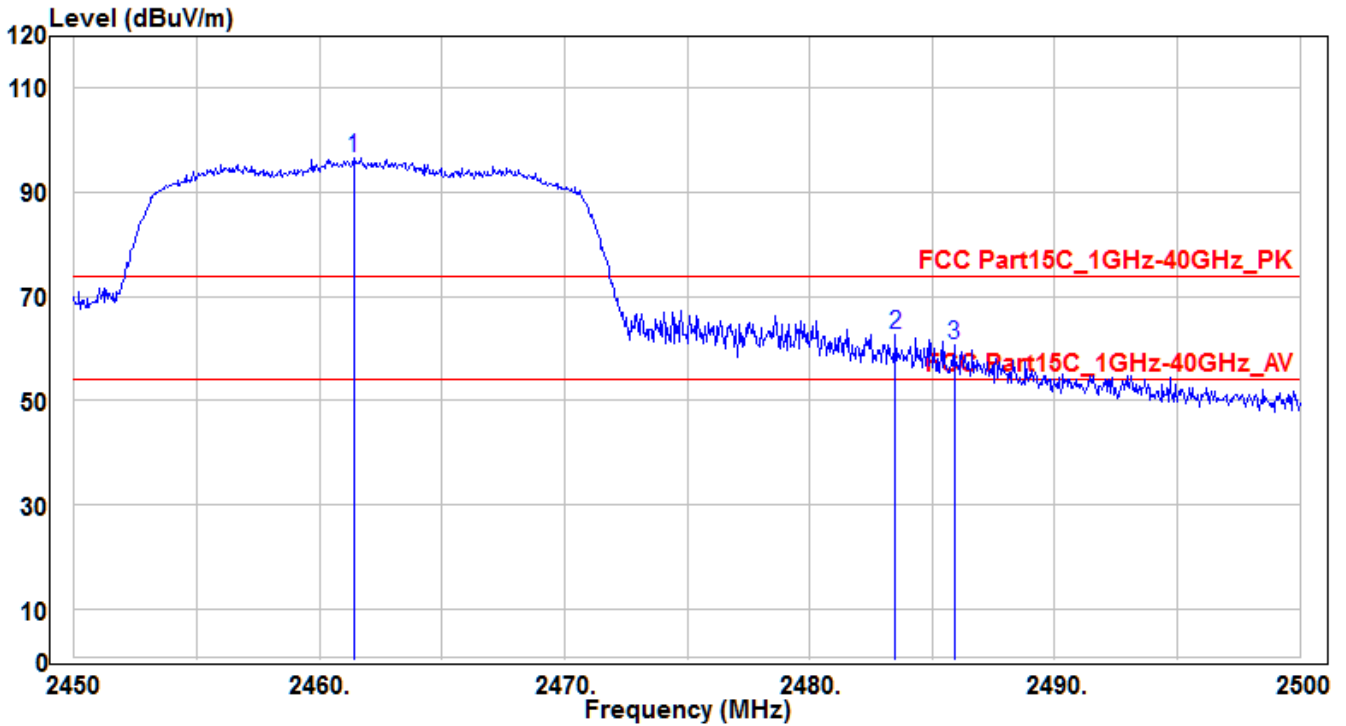

No	Frequency (MHz)	Reading (dBuV)	C.F (dB)	Measurement (dBuV/m)	Margin (dB)	Limit (dBuV/m)	Height (cm)	Angle (deg)	Remark (QP/PK/AV)
1	2461.4	98.79	-2.23	96.56	22.56	74	170	345	Peak
2	* 2483.5	64.8	-2.11	62.69	-11.31	74	170	345	Peak
3	2485.9	62.71	-2.1	60.61	-13.39	74	170	345	Peak

Note:

- "*" means this data is the worst emission level.
- C.F (Correction Factor) = Antenna Factor (dB)+ Cable Loss (dB) - Preamplifier(dB)..
- Measurement (dBuV/m) = Reading(dBuV) + C.F (Correction Factor).

EUT	Gateway	Test Date	2018/4/11
Factor	BBHA 9120D (1GHz~18GHz)	Temp. / Humidity	21°C / 57%
Polarity	Horizontal	Site / Engineer	AC1 / Peter
Test Mode	MODE3-CH11	Test Voltage	AC 120V/60Hz

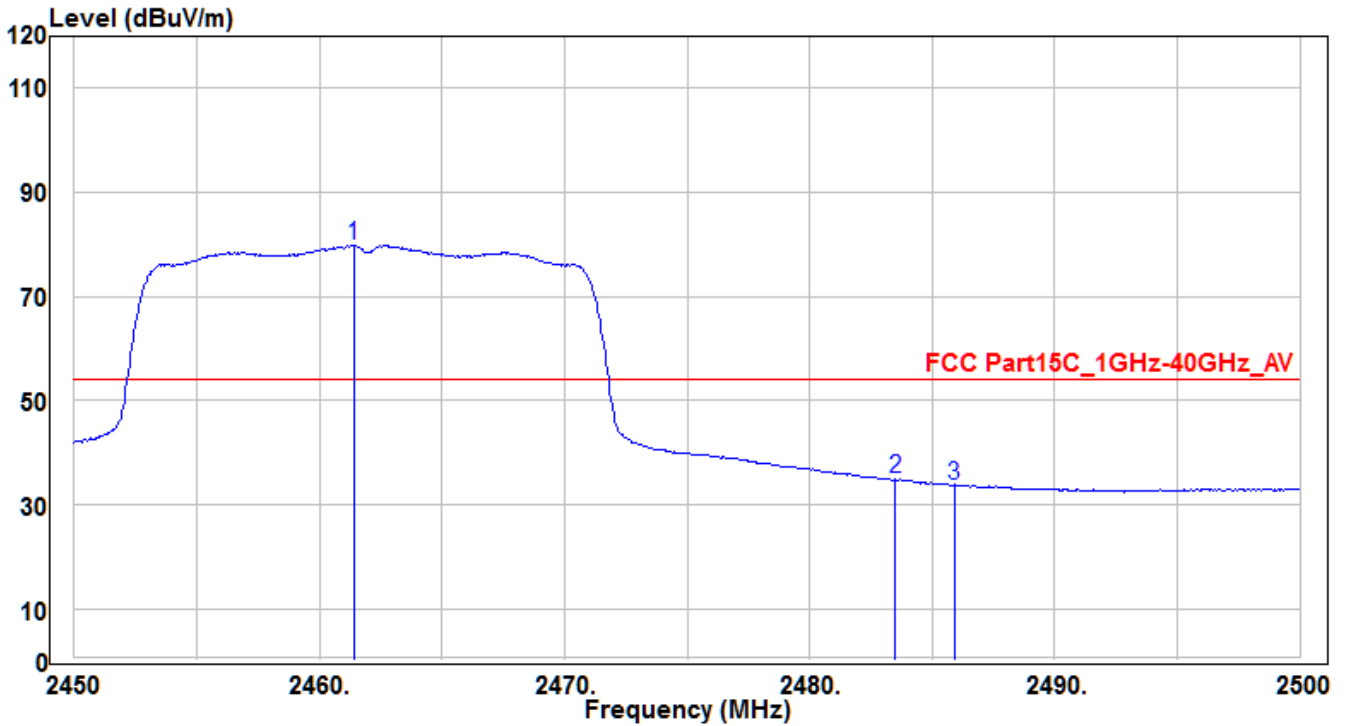

No	Frequency (MHz)	Reading (dBuV)	C.F (dB)	Measurement (dBuV/m)	Margin (dB)	Limit (dBuV/m)	Height (cm)	Angle (deg)	Remark (QP/PK/AV)
1	2461.4	81.88	-2.23	79.65	25.65	54	170	345	Average
2	* 2483.5	36.91	-2.11	34.8	-19.2	54	170	345	Average
3	2485.9	35.89	-2.1	33.79	-20.21	54	170	345	Average

Note:

- "*" means this data is the worst emission level.
- C.F (Correction Factor) = Antenna Factor (dB)+ Cable Loss (dB) - Preamplifier(dB)..
- Measurement (dBuV/m) = Reading(dBuV) + C.F (Correction Factor).

EUT	Gateway	Test Date	2018/4/11
Factor	BBHA 9120D (1GHz~18GHz)	Temp. / Humidity	21°C / 57%
Polarity	Vertical	Site / Engineer	AC1 / Peter
Test Mode	MODE3-CH11	Test Voltage	AC 120V/60Hz

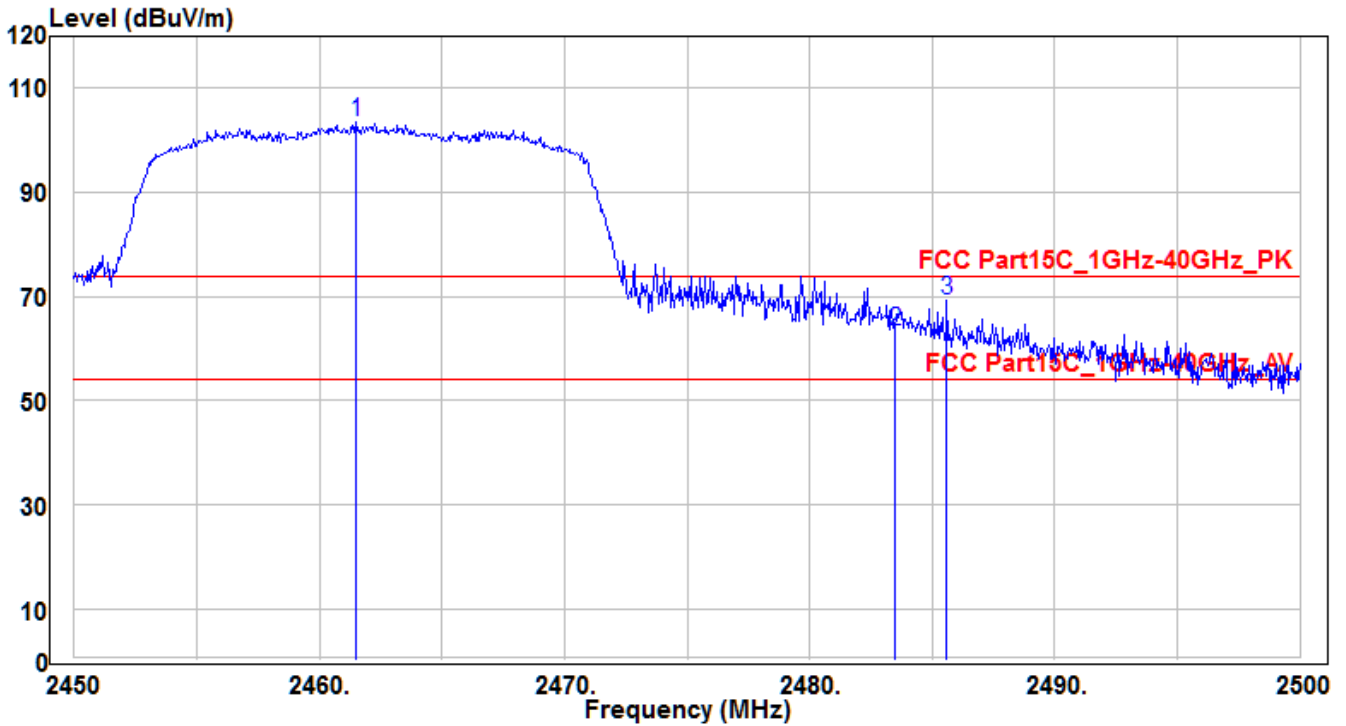

No	Frequency (MHz)	Reading (dBuV)	C.F (dB)	Measurement (dBuV/m)	Margin (dB)	Limit (dBuV/m)	Height (cm)	Angle (deg)	Remark (QP/PK/AV)
1	2461.5	105.75	-2.23	103.52	29.52	74	180	100	Peak
2	2483.5	65.37	-2.11	63.26	-10.74	74	180	100	Peak
3	* 2485.6	71.29	-2.1	69.19	-4.81	74	180	100	Peak

Note:

- "*" means this data is the worst emission level.
- C.F (Correction Factor) = Antenna Factor (dB)+ Cable Loss (dB) - Preamplifier(dB)..
- Measurement (dBuV/m) = Reading(dBuV) + C.F (Correction Factor).

EUT	Gateway	Test Date	2018/4/11
Factor	BBHA 9120D (1GHz~18GHz)	Temp. / Humidity	21°C / 57%
Polarity	Vertical	Site / Engineer	AC1 / Peter
Test Mode	MODE3-CH11	Test Voltage	AC 120V/60Hz

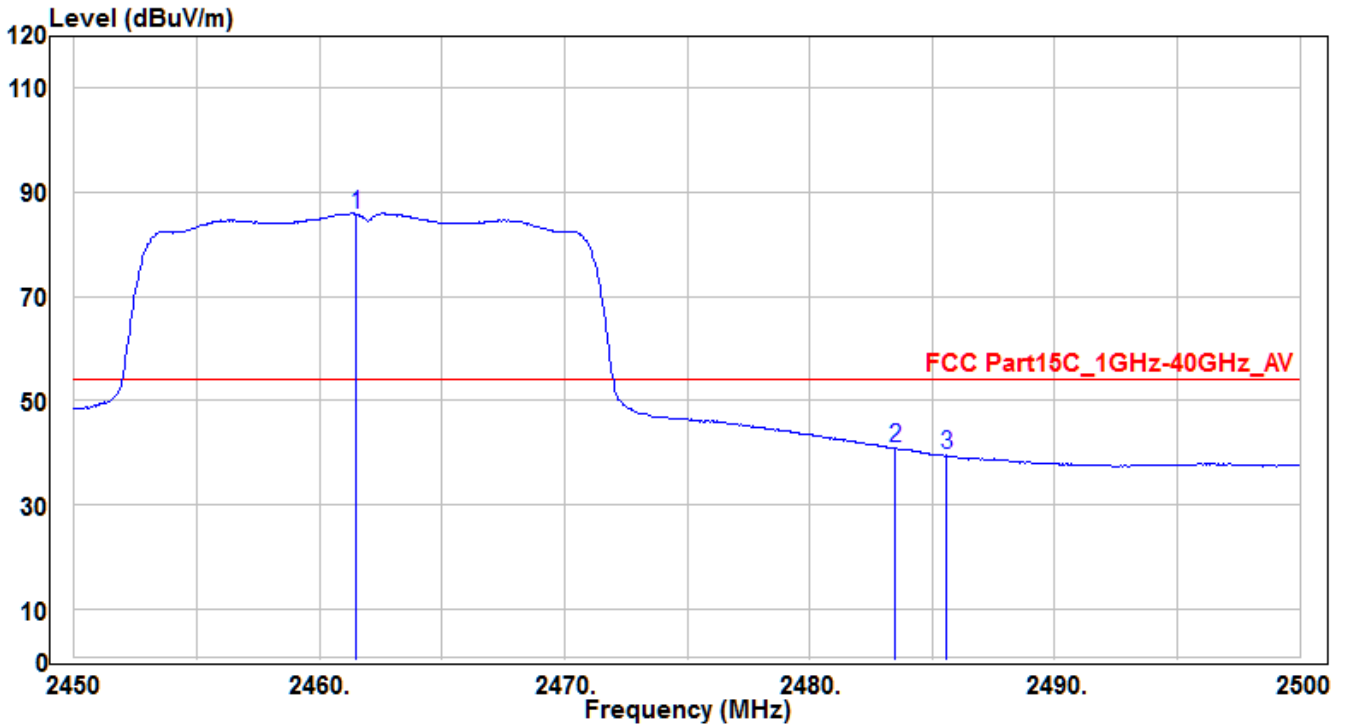

No	Frequency (MHz)	Reading (dBuV)	C.F (dB)	Measurement (dBuV/m)	Margin (dB)	Limit (dBuV/m)	Height (cm)	Angle (deg)	Remark (QP/PK/AV)
1	2461.5	88.09	-2.23	85.86	31.86	54	180	100	Average
2	* 2483.5	42.84	-2.11	40.73	-13.27	54	180	100	Average
3	2485.6	41.58	-2.1	39.48	-14.52	54	180	100	Average

Note:

1. " * " means this data is the worst emission level.
2. C.F (Correction Factor) = Antenna Factor (dB)+ Cable Loss (dB) - Preamplifier(dB)..
3. Measurement (dBuV/m) = Reading(dBuV) + C.F (Correction Factor).

EUT	Gateway	Test Date	2018/4/11
Factor	BBHA 9120D (1GHz~18GHz)	Temp. / Humidity	21°C / 57%
Polarity	Horizontal	Site / Engineer	AC1 / Peter
Test Mode	MODE4-CH03	Test Voltage	AC 120V/60Hz

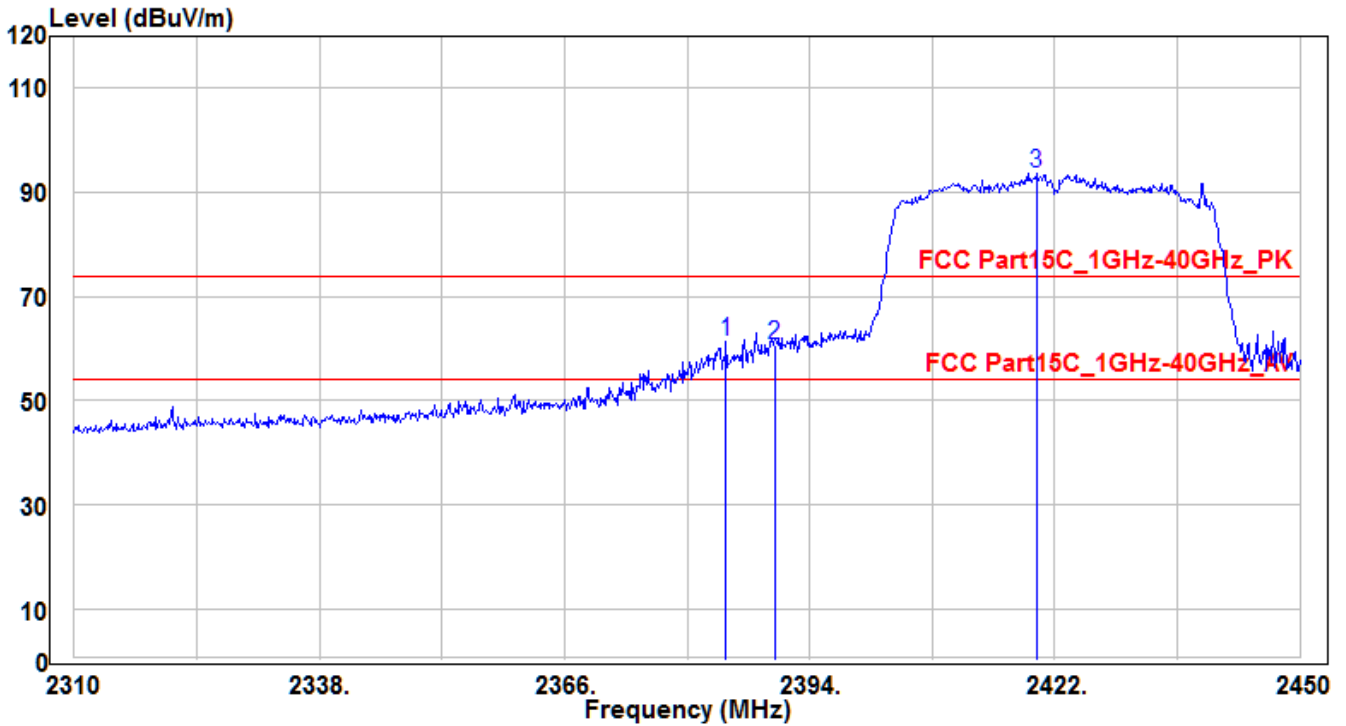

No	Frequency (MHz)	Reading (dBuV)	C.F (dB)	Measurement (dBuV/m)	Margin (dB)	Limit (dBuV/m)	Height (cm)	Angle (deg)	Remark (QP/PK/AV)	
1	*	2384.48	63.93	-2.62	61.31	-12.69	74	165	345	Peak
2		2390	63.14	-2.59	60.55	-13.45	74	165	345	Peak
3		2419.9	96.13	-2.44	93.69	19.69	74	165	345	Peak

Note:

- "*" means this data is the worst emission level.
- C.F (Correction Factor) = Antenna Factor (dB)+ Cable Loss (dB) - Preamplifier(dB)..
- Measurement (dBuV/m) = Reading(dBuV) + C.F (Correction Factor).

EUT	Gateway	Test Date	2018/4/11
Factor	BBHA 9120D (1GHz~18GHz)	Temp. / Humidity	21°C / 57%
Polarity	Horizontal	Site / Engineer	AC1 / Peter
Test Mode	MODE4-CH03	Test Voltage	AC 120V/60Hz

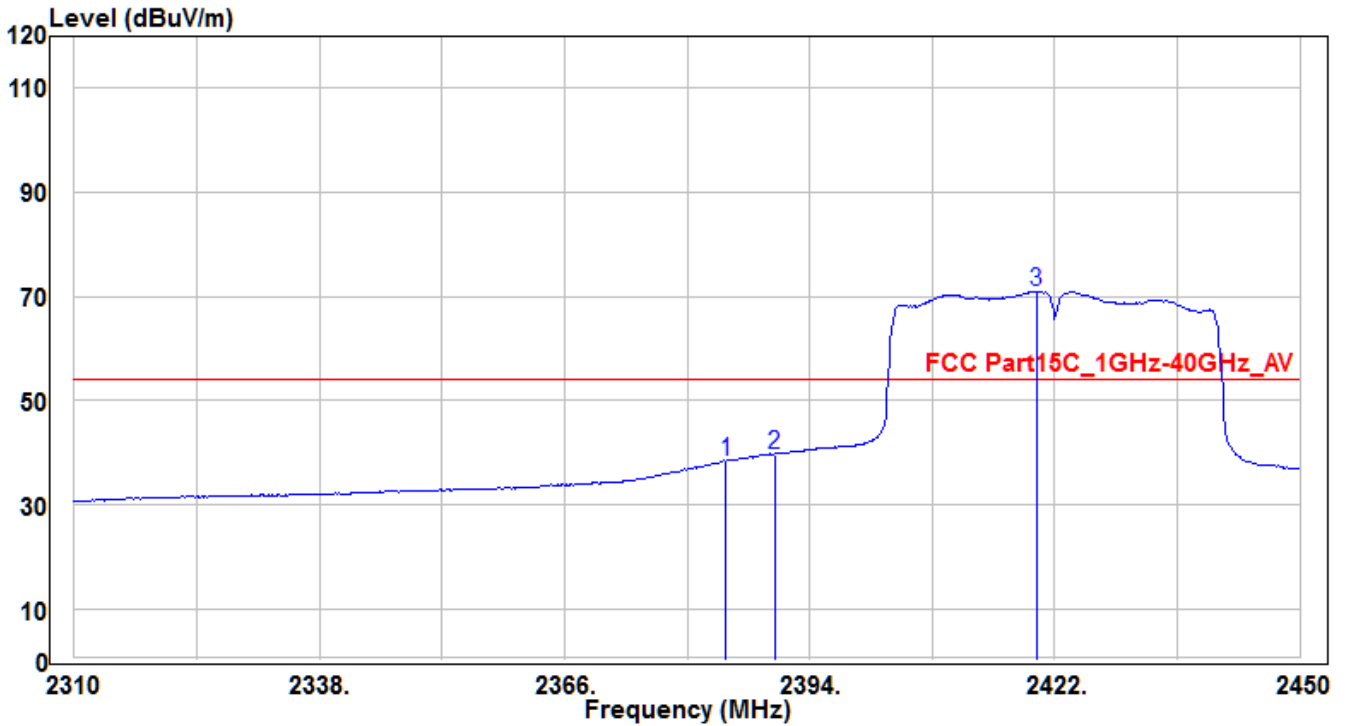

No	Frequency (MHz)	Reading (dBuV)	C.F (dB)	Measurement (dBuV/m)	Margin (dB)	Limit (dBuV/m)	Height (cm)	Angle (deg)	Remark (QP/PK/AV)
1	2384.48	40.99	-2.62	38.37	-15.63	54	165	345	Average
2	* 2390	42.29	-2.59	39.7	-14.3	54	165	345	Average
3	2419.9	73.45	-2.44	71.01	17.01	54	165	345	Average

Note:

- "*" means this data is the worst emission level.
- C.F (Correction Factor) = Antenna Factor (dB)+ Cable Loss (dB) - Preamplifier(dB)..
- Measurement (dBuV/m) = Reading(dBuV) + C.F (Correction Factor).

EUT	Gateway	Test Date	2018/4/11
Factor	BBHA 9120D (1GHz~18GHz)	Temp. / Humidity	21°C / 57%
Polarity	Vertical	Site / Engineer	AC1 / Peter
Test Mode	MODE4-CH03	Test Voltage	AC 120V/60Hz

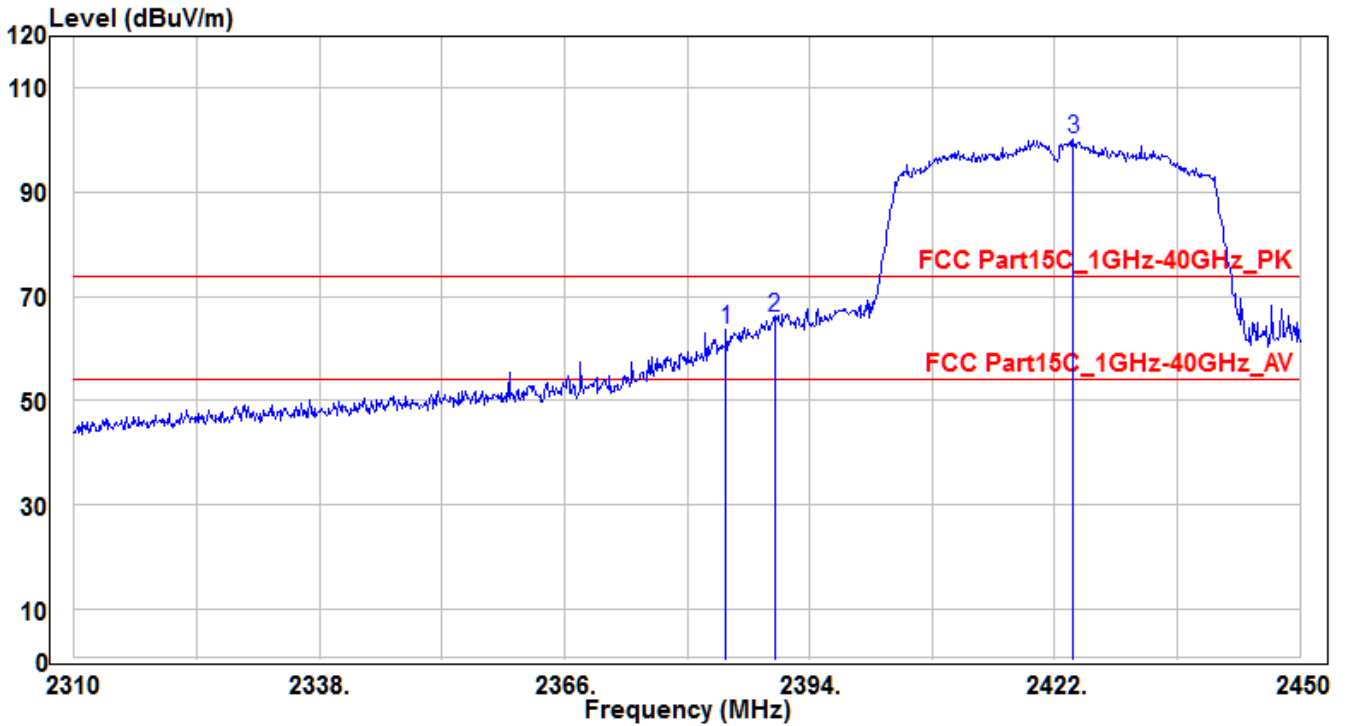

No	Frequency (MHz)	Reading (dBuV)	C.F (dB)	Measurement (dBuV/m)	Margin (dB)	Limit (dBuV/m)	Height (cm)	Angle (deg)	Remark (QP/PK/AV)
1	2384.48	66.2	-2.62	63.58	-10.42	74	170	285	Peak
2	* 2390	68.52	-2.59	65.93	-8.07	74	170	285	Peak
3	2424.1	102.67	-2.41	100.26	26.26	74	170	285	Peak

Note:

1. " * " means this data is the worst emission level.
2. C.F (Correction Factor) = Antenna Factor (dB)+ Cable Loss (dB) - Preamplifier(dB)..
3. Measurement (dBuV/m) = Reading(dBuV) + C.F (Correction Factor).

EUT	Gateway	Test Date	2018/4/11
Factor	BBHA 9120D (1GHz~18GHz)	Temp. / Humidity	21°C / 57%
Polarity	Vertical	Site / Engineer	AC1 / Peter
Test Mode	MODE4-CH03	Test Voltage	AC 120V/60Hz

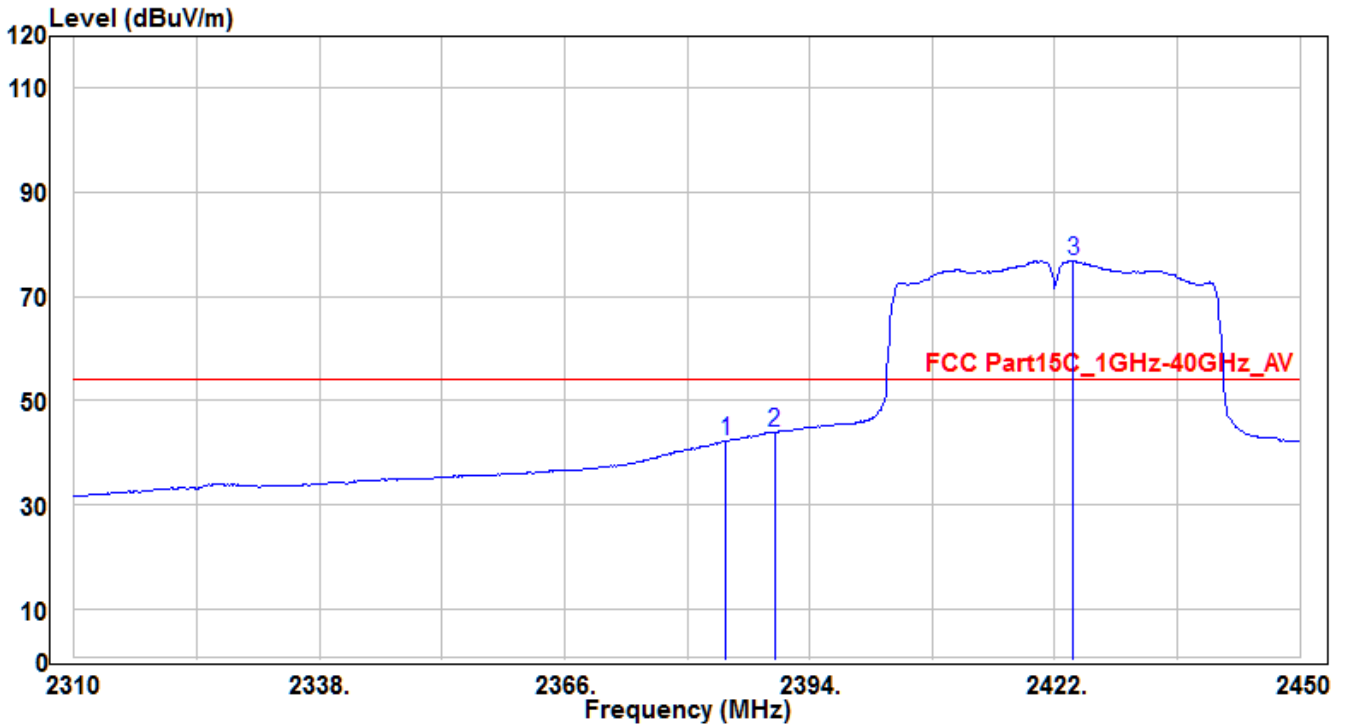

No	Frequency (MHz)	Reading (dBuV)	C.F (dB)	Measurement (dBuV/m)	Margin (dB)	Limit (dBuV/m)	Height (cm)	Angle (deg)	Remark (QP/PK/AV)
1	2384.48	44.84	-2.62	42.22	-11.78	54	170	285	Average
2	* 2390	46.39	-2.59	43.8	-10.2	54	170	285	Average
3	2424.1	79.21	-2.41	76.8	22.8	54	170	285	Average

Note:

- "*" means this data is the worst emission level.
- C.F (Correction Factor) = Antenna Factor (dB)+ Cable Loss (dB) - Preamplifier(dB)..
- Measurement (dBuV/m) = Reading(dBuV) + C.F (Correction Factor).

EUT	Gateway	Test Date	2018/4/11
Factor	BBHA 9120D (1GHz~18GHz)	Temp. / Humidity	21°C / 57%
Polarity	Horizontal	Site / Engineer	AC1 / Peter
Test Mode	MODE4-CH09	Test Voltage	AC 120V/60Hz

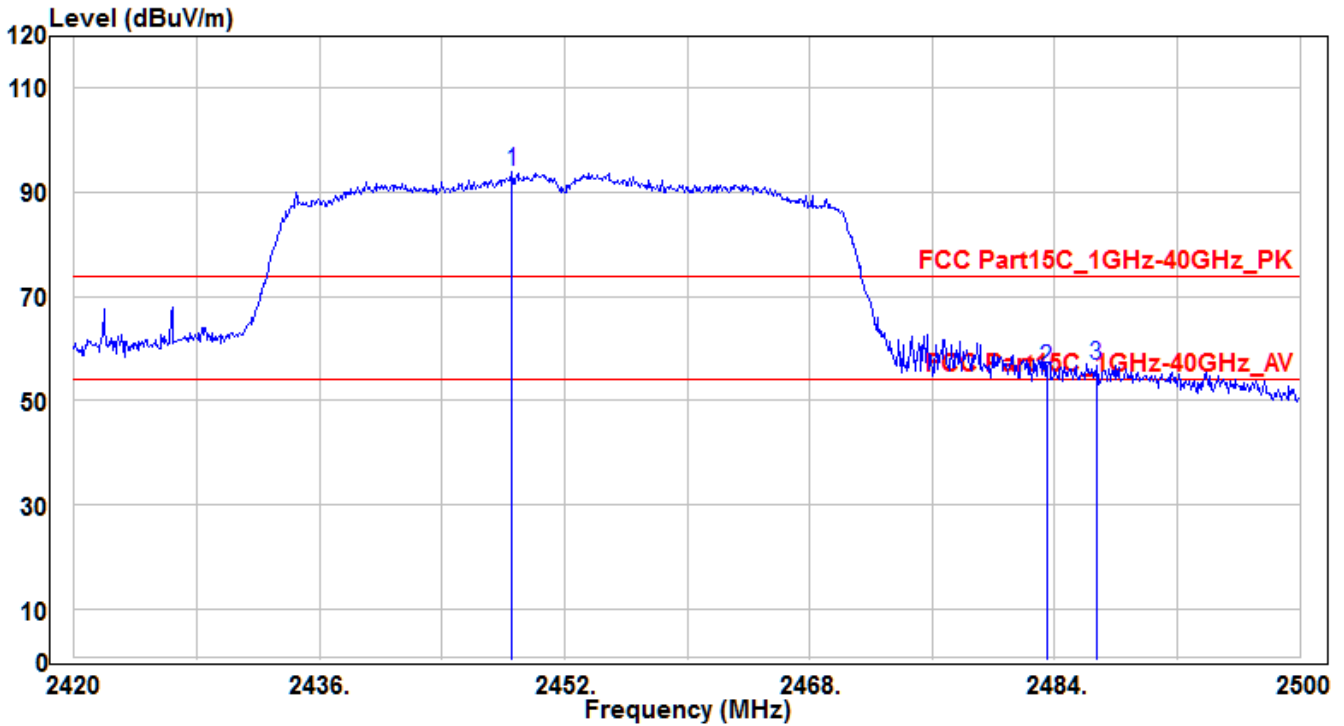

No	Frequency (MHz)	Reading (dBuV)	C.F (dB)	Measurement (dBuV/m)	Margin (dB)	Limit (dBuV/m)	Height (cm)	Angle (deg)	Remark (QP/PK/AV)
1	2448.56	96.21	-2.28	93.93	19.93	74	170	-15	Peak
2	2483.5	58.03	-2.11	55.92	-18.08	74	170	-15	Peak
3	* 2486.72	58.93	-2.1	56.83	-17.17	74	170	-15	Peak

Note:

1. " * " means this data is the worst emission level.
2. C.F (Correction Factor) = Antenna Factor (dB)+ Cable Loss (dB) - Preamplifier(dB)..
3. Measurement (dBuV/m) = Reading(dBuV) + C.F (Correction Factor).

EUT	Gateway	Test Date	2018/4/11
Factor	BBHA 9120D (1GHz~18GHz)	Temp. / Humidity	21°C / 57%
Polarity	Horizontal	Site / Engineer	AC1 / Peter
Test Mode	MODE4-CH09	Test Voltage	AC 120V/60Hz

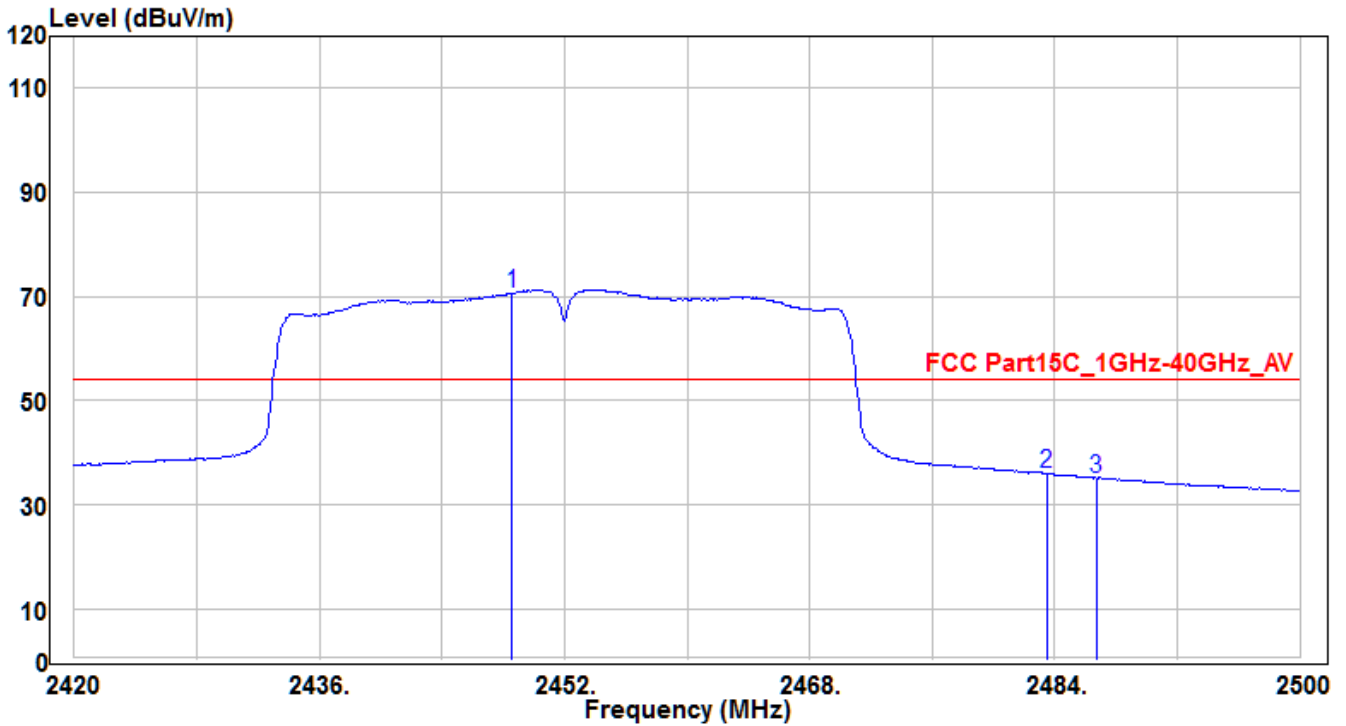

No	Frequency (MHz)	Reading (dBuV)	C.F (dB)	Measurement (dBuV/m)	Margin (dB)	Limit (dBuV/m)	Height (cm)	Angle (deg)	Remark (QP/PK/AV)
1	2448.56	72.83	-2.28	70.55	16.55	54	170	-15	Average
2	* 2483.5	38.21	-2.11	36.1	-17.9	54	170	-15	Average
3	2486.72	37.21	-2.1	35.11	-18.89	54	170	-15	Average

Note:

1. " * " means this data is the worst emission level.
2. C.F (Correction Factor) = Antenna Factor (dB)+ Cable Loss (dB) - Preamplifier(dB)..
3. Measurement (dBuV/m) = Reading(dBuV) + C.F (Correction Factor).

EUT	Gateway	Test Date	2018/4/11
Factor	BBHA 9120D (1GHz~18GHz)	Temp. / Humidity	21°C / 57%
Polarity	Vertical	Site / Engineer	AC1 / Peter
Test Mode	MODE4-CH09	Test Voltage	AC 120V/60Hz

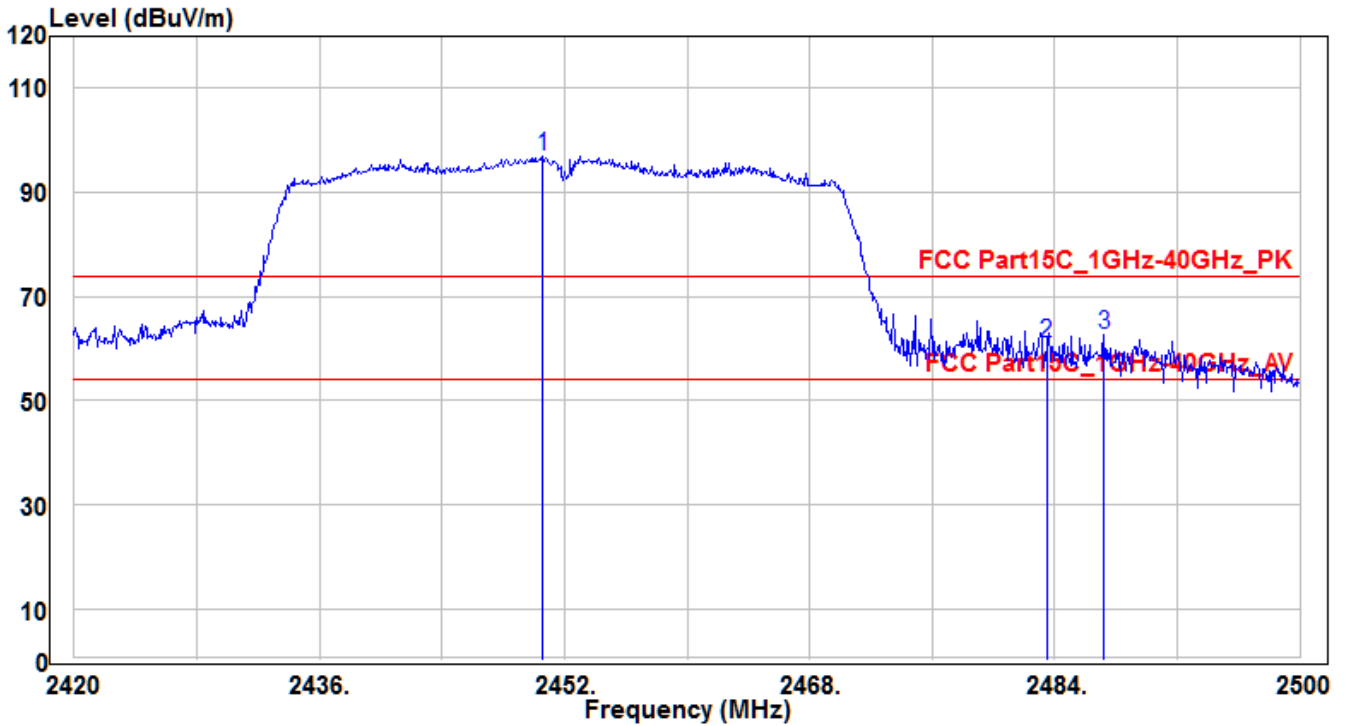

No	Frequency (MHz)	Reading (dBuV)	C.F (dB)	Measurement (dBuV/m)	Margin (dB)	Limit (dBuV/m)	Height (cm)	Angle (deg)	Remark (QP/PK/AV)
1	2450.56	99.38	-2.28	97.1	23.1	74	230	300	Peak
2	2483.5	62.98	-2.11	60.87	-13.13	74	230	300	Peak
3	* 2487.2	64.65	-2.1	62.55	-11.45	74	230	300	Peak

Note:

1. " * " means this data is the worst emission level.
2. C.F (Correction Factor) = Antenna Factor (dB)+ Cable Loss (dB) - Preamplifier(dB)..
3. Measurement (dBuV/m) = Reading(dBuV) + C.F (Correction Factor).

EUT	Gateway	Test Date	2018/4/11
Factor	BBHA 9120D (1GHz~18GHz)	Temp. / Humidity	21°C / 57%
Polarity	Vertical	Site / Engineer	AC1 / Peter
Test Mode	MODE4-CH09	Test Voltage	AC 120V/60Hz

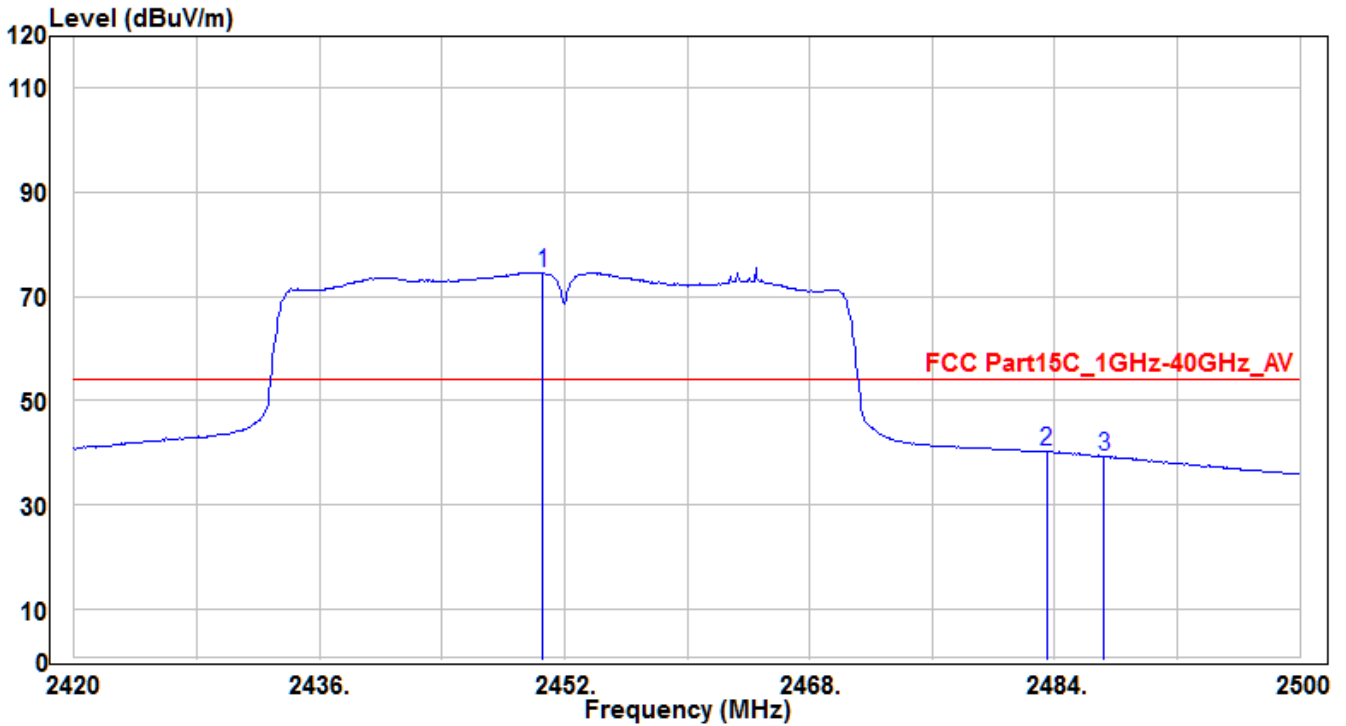

No	Frequency (MHz)	Reading (dBuV)	C.F (dB)	Measurement (dBuV/m)	Margin (dB)	Limit (dBuV/m)	Height (cm)	Angle (deg)	Remark (QP/PK/AV)
1	2450.56	76.89	-2.28	74.61	20.61	54	230	300	Average
2	* 2483.5	42.42	-2.11	40.31	-13.69	54	230	300	Average
3	2487.2	41.25	-2.1	39.15	-14.85	54	230	300	Average

Note:

- "*" means this data is the worst emission level.
- C.F (Correction Factor) = Antenna Factor (dB)+ Cable Loss (dB) - Preamplifier(dB)..
- Measurement (dBuV/m) = Reading(dBuV) + C.F (Correction Factor).

7.8. AC Conducted Emissions Measurement

7.8.1. Test Limit

FCC Part 15 Subpart C Paragraph 15.207 Limits		
Frequency (MHz)	QP (dB μ V)	Average (dB μ V)
0.15 - 0.50	66 - 56	56 - 46
0.50 - 5.0	56	46
5.0 - 30	60	50

Note 1: The lower limit shall apply at the transition frequencies.

Note 2: The limit decreases linearly with the logarithm of the frequency in the range 0.15MHz to 0.5MHz.

7.8.2. Test Setup

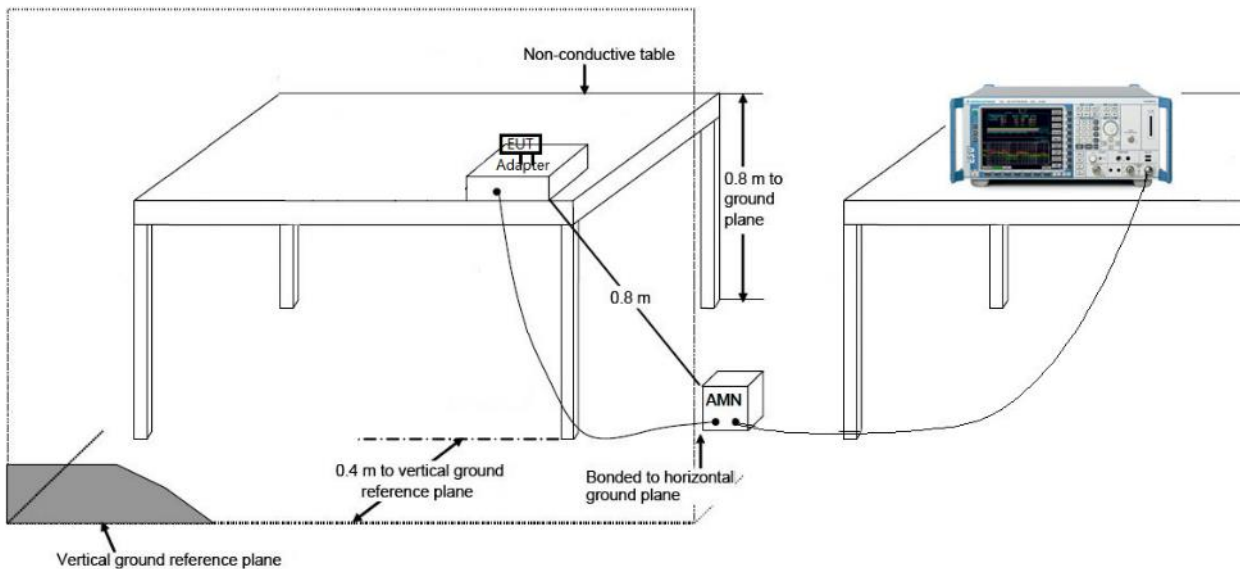

7.8.3. Test Result

EUT	Gateway	Test Date	2018/4/16
Factor	CE_ENV216-L1 (Filter ON)	Temp. / Humidity	24°C / 55%
Polarity	Line1	Site / Engineer	SR2 / Peter
Test Mode	MODE3-CH06	Test Voltage	AC120V/60Hz

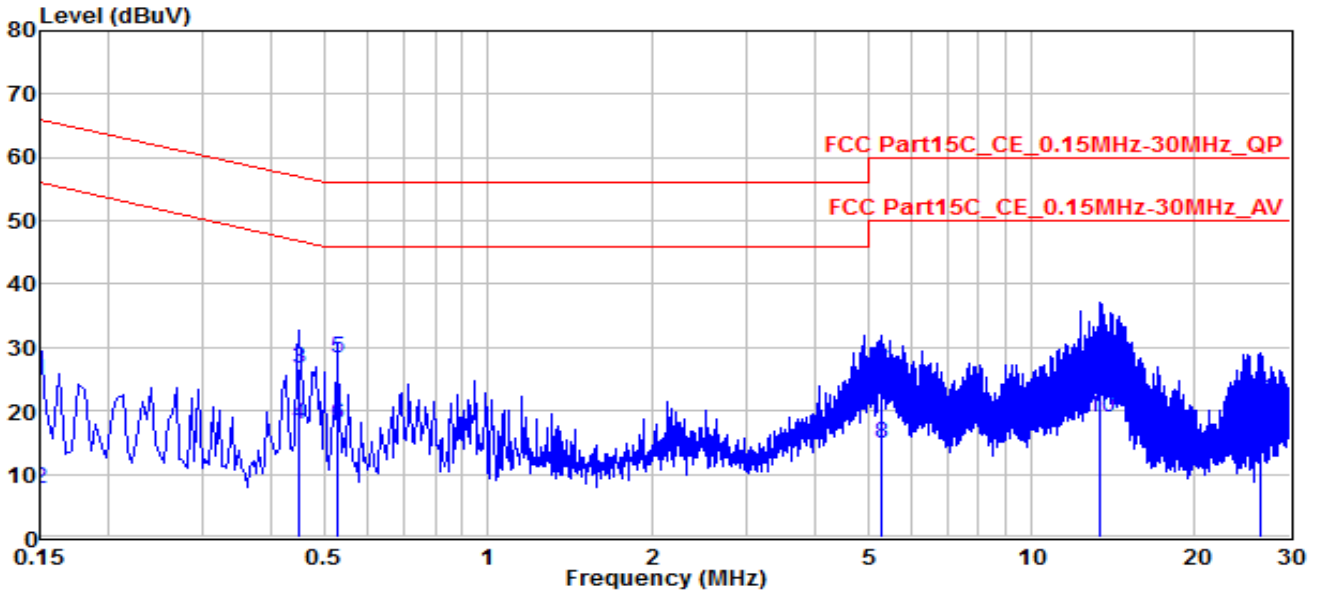

No	Frequency (MHz)	Reading (dBuV)	C.F (dB)	Measurement (dBuV)	Margin (dB)	Limit (dBuV)	Remark (QP/PK/AV)
1	0.15	14.9	9.77	24.67	-41.33	66	QP
2	0.15	-1.99	9.77	7.78	-48.22	56	Average
3	0.45147	16.49	10.07	26.56	-30.29	56.85	QP
4	0.45147	7.93	10.07	18	-28.85	46.85	Average
5	* 0.52796	18.24	10.08	28.32	-27.68	56	QP
6	* 0.52796	7.8	10.08	17.88	-28.12	46	Average
7	5.288	16.46	9.76	26.22	-33.78	60	QP
8	5.288	5.1	9.76	14.86	-35.14	50	Average
9	13.388	17.75	9.93	27.68	-32.32	60	QP
10	13.388	9.1	9.93	19.03	-30.97	50	Average
11	26.391	11.66	10.02	21.68	-38.32	60	QP
12	26.391	4.44	10.02	14.46	-35.54	50	Average

Note:

- " * ", means this data is the worst emission level.
- C.F (Correction Factor) = Factor (dB)+ Cable Loss (dB).
- Measurement (dBuV) = Reading(dBuV)+ C.F (Correction Factor).

EUT	Gateway	Test Date	2018/4/16
Factor	CE_ENV216-N (Filter ON)	Temp. / Humidity	24°C / 55%
Polarity	Neutral	Site / Engineer	SR2 / Peter
Test Mode	MODE3-CH06	Test Voltage	AC120V/60Hz

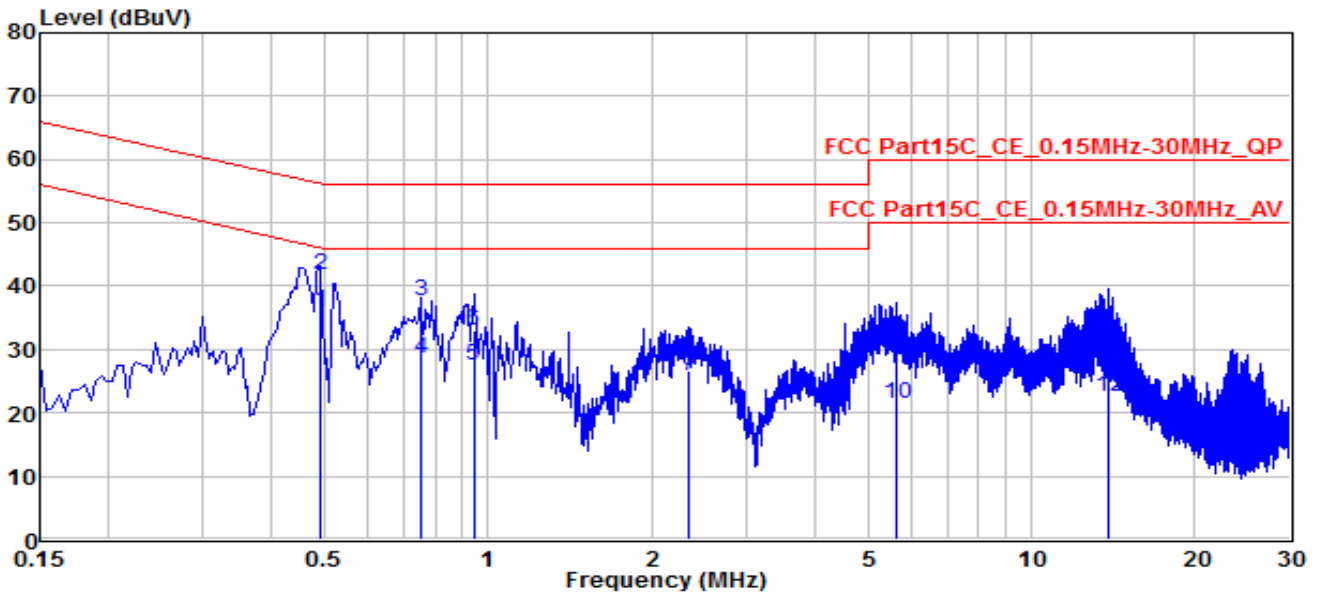

No		Frequency (MHz)	Reading (dBuV)	C.F (dB)	Measurement (dBuV)	Margin (dB)	Limit (dBuV)	Remark (QP/PK/AV)
1	*	0.49197	25.78	10.12	35.9	-20.23	56.13	QP
2	*	0.49197	31.78	10.12	41.9	-4.23	46.13	Average
3		0.75294	27.55	10	37.55	-18.45	56	QP
4		0.75294	18.61	10	28.61	-17.39	46	Average
5		0.94192	17.64	9.91	27.55	-28.45	56	QP
6		0.94192	23.12	9.91	33.03	-12.97	46	Average
7		2.35	15.97	9.85	25.82	-30.18	56	QP
8		2.35	16.95	9.85	26.8	-19.2	46	Average
9		5.662	21.96	9.78	31.74	-28.26	60	QP
10		5.662	11.78	9.78	21.56	-28.44	50	Average
11		13.905	21.69	9.96	31.65	-28.35	60	QP
12		13.905	12.46	9.96	22.42	-27.58	50	Average

Note:

1. " * ", means this data is the worst emission level.
2. C.F (Correction Factor) = Factor (dB)+ Cable Loss (dB).
3. Measurement (dBuV) = Reading(dBuV)+ C.F (Correction Factor).

8. CONCLUSION

The data collected relate only the item(s) tested and show that the **Gateway** is in compliance with Part 15C of the FCC Rules.

————— The End —————