



MET Laboratories, Inc. *Safety Certification - EMI - Telecom Environmental Simulation*

914 WEST PATAPSCO AVENUE • BALTIMORE, MARYLAND 21230-3432 • PHONE (410) 354-3300 • FAX (410) 354-3313
33439 WESTERN AVENUE • UNION CITY, CALIFORNIA 94587 • PHONE (510) 489-6300 • FAX (510) 489-6372
3162 BELICK STREET • SANTA CLARA, CA 95054 • PHONE (408) 748-3585 • FAX (510) 489-6372
13301 MCCALLEN PASS • AUSTIN, TX 78753 • PHONE (512) 287-2500 • FAX (512) 287-2513

January 26, 2015

LINAK A/S
Smedevænget 8
DK6430 Nordborg

Dear Puk Nielsen,

Enclosed is the EMC Wireless test report for compliance testing of the LINAK A/S, HC1xRF as tested to the requirements of Title 47 of the CFR, Ch. 1 (10-1-06 ed.), FCC Part 15 Subpart B and ICES-003 Issue 5, August 2012 for a Class B Digital Device, and FCC Part 15 Subpart C and RSS-210 Issue 8, December 2010 for Intentional Radiators.

Thank you for using the services of MET Laboratories, Inc. If you have any questions regarding these results or if MET can be of further service to you, please feel free to contact me.

Sincerely yours,
MET LABORATORIES, INC.

Jennifer Warnell
Documentation Department

Reference: (\LINAK A/S\EMC40542B-FCC231 Rev. 1)

Certificates and reports shall not be reproduced except in full, without the written permission of MET Laboratories, Inc. .



MET Laboratories, Inc. *Safety Certification - EMI - Telecom Environmental Simulation*

914 WEST PATAPSCO AVENUE • BALTIMORE, MARYLAND 21230-3432 • PHONE (410) 354-3300 • FAX (410) 354-3313

33439 WESTERN AVENUE • UNION CITY, CALIFORNIA 94587 • PHONE (510) 489-6300 • FAX (510) 489-6372

3162 BELICK STREET • SANTA CLARA, CA 95054 • PHONE (408) 748-3585 • FAX (510) 489-6372

13301 MCCALLEN PASS • AUSTIN, TX 78753 • PHONE (512) 287-2500 • FAX (512) 287-2513

**Electromagnetic Compatibility Criteria
Test Report**

for the

**LINAK A/S
HC1xRF**

Tested under

the FCC Certification Rules
contained in

Title 47 of the CFR, Parts 15 Subpart B and ICES-003
for Class B Digital Devices

&

15.231 Subpart C and RSS-210
for Intentional Radiators

MET Report: EMC40542B-FCC231 Rev. 1

January 26, 2015

Prepared For:

**LINAK A/S
Smedevænget 8
DK6430 Nordborg**

Prepared By:
MET Laboratories, Inc.
914 W. Patapsco Ave
Baltimore, MD 21230

Electromagnetic Compatibility Criteria Test Report

for the

LINAk A/S
HC1xRF

Tested Under

the FCC Certification Rules
contained in
Title 47 of the CFR, Parts 15 Subpart B and ICES-003
for Class B Digital Devices
&
15.231 Subpart C and RSS-210
for Intentional Radiators



Surinder Singh, Project Engineer
Electromagnetic Compatibility Lab



Jennifer Warnell
Documentation Department

Engineering Statement: The measurements shown in this report were made in accordance with the procedures indicated, and the emissions from this equipment were found to be within the limits applicable. I assume full responsibility for the accuracy and completeness of these measurements, and for the qualifications of all persons taking them. It is further stated that upon the basis of the measurements made, the equipment tested is capable of operation in accordance with the requirements of FCC Rules Parts 15B and 15.231 and Industry Canada standards ICES-003 Issue 5, August 2012 and RSS-210 Issue 8, December 2010 under normal use and maintenance.



Asad Bajwa
Director, Electromagnetic Compatibility Lab

Report Status Sheet

Revision	Report Date	Reason for Revision
∅	January 8, 2015	Initial Issue.
1	January 26, 2015	Editorial correction.

Table of Contents

I.	Executive Summary	1
	A. Purpose of Test	2
	B. Executive Summary	2
II.	Equipment Configuration	3
	A. Overview.....	4
	B. References.....	5
	C. Test Site	5
	D. Description of Test Sample.....	6
	E. Equipment Configuration.....	7
	F. Mode of Operation.....	7
	G. Modifications	8
	a) Modifications to EUT.....	8
	b) Modifications to Test Standard.....	8
	H. Disposition of EUT	8
III.	Electromagnetic Compatibility Criteria for Unintentional Radiators	9
	§ 15.107(a) Conducted Emissions Limits	10
	§ 15.109(a) Radiated Emission Limits	11
IV.	Electromagnetic Compatibility Criteria for Intentional Radiators	14
	§ 15.203 Antenna Requirement	15
	§ 15.231(a) Periodic Operation Requirements	16
	§ 15.231(b)(e) Field Strength of Fundamental and Harmonics	18
	§ 15.231(c) 20dB Bandwidth.....	23
V.	Test Equipment	24
VI.	Certification & User's Manual Information	26
	A. Certification Information	27
	B. Label and User's Manual Information	31

List of Tables

Table 1. Executive Summary of EMC Part 15.231 Compliance Testing	2
Table 2. EUT Summary Table.....	4
Table 3. References	5
Table 4. Equipment Configuration	7
Table 5. Conducted Limits for Radio Frequency Devices calculated from FCC Part 15 Subsections 15.107(a) (b).....	10
Table 6. Radiated Emissions Limits calculated from FCC Part 15, §15.109 (a) (b)	11
Table 7. Radiated Emissions Limits, Test Results, 30 MHz – 1 GHz.....	12
Table 8. Test Equipment List	25

List of Photographs

Photograph 1. LINAK HC1xRF.....	6
Photograph 2. Radiated Emissions, Test Setup	13
Photograph 3. Fundamental Field Strength, Harmonic/Spurious Emission 1-5GHz Test Setup.....	22

List of Terms and Abbreviations

AC	Alternating Current
ACF	Antenna Correction Factor
Cal	Calibration
<i>d</i>	Measurement Distance
dB	Decibels
dBμA	Decibels above one microamp
dBμV	Decibels above one microvolt
dBμA/m	Decibels above one microamp per meter
dBμV/m	Decibels above one microvolt per meter
DC	Direct Current
E	Electric Field
EUT	Equipment Under Test
<i>f</i>	Frequency
FCC	Federal Communications Commission
GRP	Ground Reference Plane
H	Magnetic Field
HCP	Horizontal Coupling Plane
Hz	Hertz
kHz	kilohertz
kPa	kilopascal
kV	kilovolt
LISN	Line Impedance Stabilization Network
MHz	Megahertz
μH	microhenry
μ	microfarad
μs	microseconds
PRF	Pulse Repetition Frequency
RF	Radio Frequency
RMS	Root-Mean-Square
TWT	Traveling Wave Tube
V/m	Volts per meter
VCP	Vertical Coupling Plane

I. Executive Summary

A. Purpose of Test

An EMC evaluation was performed to determine compliance of the LINAK A/S HC1xRF, with the requirements of Part 15, §15.231. All references are to the most current version of Title 47 of the Code of Federal Regulations in effect. In accordance with §2.1033, the following data is presented in support of the Certification of the HC1xRF. LINAK A/S should retain a copy of this document which should be kept on file for at least two years after the manufacturing of the HC1xRF, has been **permanently** discontinued.

B. Executive Summary

The following tests were conducted on a sample of the equipment for the purpose of demonstrating compliance with Part 15, §15.231, in accordance with LINAK A/S, purchase order number 141274. All tests were conducted using measurement procedure ANSI C63.4-2003.

FCC Reference	IC Reference	Description	Results
Unintentional Digital			
§15.107	ICES-003 Issue 5, August 2012	AC Power Line Conducted Emissions	Not Applicable - EUT is battery powered.
§15.109	ICES-003 Issue 5, August 2012	Radiated Emissions	Compliant
Transmitter Mode (TX)			
§15.203	N/A	Antenna Requirement	Compliant
§15.207	RSS-GEN (7.2.4)	AC Power Line Conducted Emissions	Not Applicable - EUT is battery powered.
§15.231(e)	N/A	Periodic Operation Requirements	Compliant
§15.231(e)	RSS-210 (2.5)	Field Strength of Fundamentals and Harmonics	Compliant
§15.231(c)	RSS-210 (A6.1.3)	20dB Bandwidth	Compliant

Table 1. Executive Summary of EMC Part 15.231 Compliance Testing

II. Equipment Configuration

A. Overview

MET Laboratories, Inc. was contracted by LINAK A/S to perform testing on the HC1xRF, under LINAK A/S's purchase order number 141274.

This document describes the test setups, test methods, required test equipment, and the test limit criteria used to perform compliance testing of the LINAK A/S, HC1xRF.

The results obtained relate only to the item(s) tested.

Model(s) Tested:	HC1xRF	
EUT Specifications:	Primary Power: 18 VDC	
	FCC ID: XBE-HC1XRF IC: 12338A-HC1XRF	
	Max Field Strength:	71.96 dB μ V/m
	EUT Frequency Ranges:	433.92MHz
Analysis:	The results obtained relate only to the item(s) tested.	
Environmental Test Conditions:	Temperature: 15-35° C	
	Relative Humidity: 30-60%	
	Barometric Pressure: 860-1060 mbar	
Evaluated by:	Surinder Singh	
Report Date(s):	January 26, 2015	

Table 2. EUT Summary Table

B. References

CFR 47, Part 15, Subpart C	Federal Communication Commission, Code of Federal Regulations, Title 47, Part 15: General Rules and Regulations, Allocation, Assignment, and Use of Radio Frequencies
CFR 47, Part 15, Subpart B	Electromagnetic Compatibility: Criteria for Radio Frequency Devices
RSS-210, Issue 8, Dec. 2010	Low-power Licence-exempt Radiocommunications Devices (All Frequency Bands): Category I Equipment
RSS-GEN, Issue 3, Dec. 2010	General Requirements and Information for the Certification of Radio Apparatus
ICES-003, Issue 5 August 2012	Information Technology Equipment (ITE) — Limits and methods of measurement
ANSI C63.4:2003	Methods and Measurements of Radio-Noise Emissions from Low-Voltage Electrical And Electronic Equipment in the Range of 9 kHz to 40 GHz
ISO/IEC 17025:2005	General Requirements for the Competence of Testing and Calibration Laboratories

Table 3. References

C. Test Site

All testing was performed at MET Laboratories, Inc., 914 W. Patapsco Ave., Baltimore, MD 21230. All equipment used in making physical determinations is accurate and bears recent traceability to the National Institute of Standards and Technology.

Radiated Emissions measurements were performed in a 3 meter semi-anechoic chamber (equivalent to an Open Area Test Site). In accordance with §2.948(a)(3), a complete site description is contained at MET Laboratories.

D. Description of Test Sample

The Remotes are used in Bedrooms to control elevation beds. It is possible to control the motor at the head and the motor at the legs, if wanted light underneath the bed can be controlled.



Photograph 1. LINAK HC1xRF

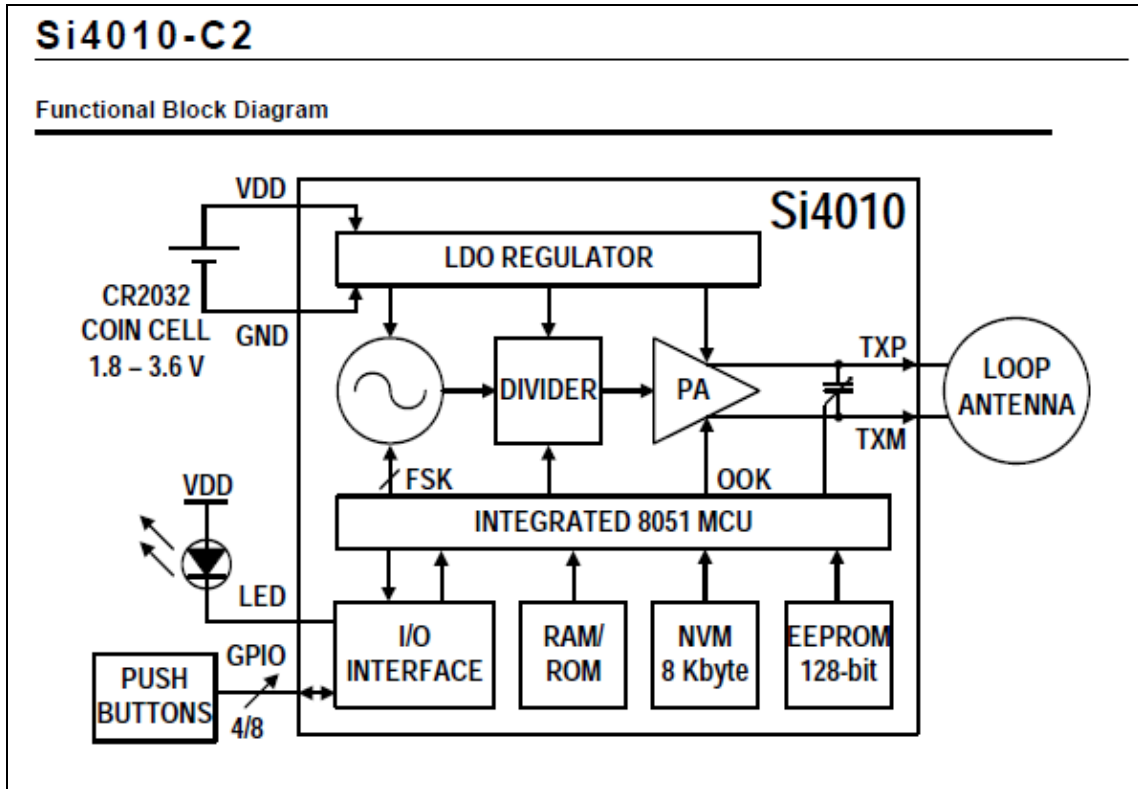

Figure 1. Block Diagram of Equipment Configuration

E. Equipment Configuration

Name / Description	Model Number
HC1xRF	HC12RF0100

Table 4. Equipment Configuration

F. Mode of Operation

Two modes of normal operation:

- 1) Standby when no buttons are pressed.
- 2) Transmitting when one or more buttons is being pressed.

The packet length is 20mS. The space between each packet is 160mS. The duty cycle of a packet is 50%. Thus the total duty cycle is less the 20% during normal transmission. After 5 minutes the transmission will stop in order to save power.

During EMC test however the EUT is put in a special mode of operation. Where it is transmitting constantly with a duty cycle of 50%. The measured values must accordingly be reduced by 80%.

G. Modifications

a) Modifications to EUT

No modifications were made to the EUT.

b) Modifications to Test Standard

No modifications were made to the test standard.

H. Disposition of EUT

The test sample including all support equipment submitted to the Electro-Magnetic Compatibility Lab for testing was returned to LINAk A/S upon completion of testing.

III. Electromagnetic Compatibility Criteria for Unintentional Radiators

Electromagnetic Compatibility Criteria

§ 15.107 Conducted Emissions Limits

Test Requirement(s): **15.107 (a)** Except for Class A digital devices, for equipment that is designed to be connected to the public utility (AC) power line, the radio frequency voltage that is conducted back onto the AC power line on any frequency or frequencies within the band 150 kHz to 30 MHz shall not exceed the limits in Table 5. Compliance with this provision shall be based on the measurement of the radio frequency voltage between each power line and ground at the power terminals.

15.107 (b) For a Class A digital device that is designed to be connected to the public utility (AC) power line, the radio frequency voltage that is conducted back onto the AC power line on any frequency or frequencies within the band 150 kHz to 30 MHz shall not exceed the limits in Table 5. Compliance with this provision shall be based on the measurement of the radio frequency voltage between each power line and ground at the power terminals. The lower limit applies at the band edges.

Frequency range (MHz)	Class A Conducted Limits (dB μ V)		*Class B Conducted Limits (dB μ V)	
	Quasi-Peak	Average	Quasi-Peak	Average
* 0.15- 0.45	79	66	66 - 56	56 - 46
0.45 - 0.5	79	66	56	46
0.5 - 30	73	60	60	50

Note 1 — The lower limit shall apply at the transition frequencies.
Note 2 — The limit decreases linearly with the logarithm if the frequency in the range 0.15 MHz to 0.5 MHz.

Table 5. Conducted Limits for Radio Frequency Devices calculated from FCC Part 15 Subsections 15.107(a) (b)

Test Results: The EUT was not applicable with the Class B requirement(s) of this section. The EUT is battery operated.

Radiated Emission Limits

§ 15.109 Radiated Emissions Limits

Test Requirement(s): **15.109 (a)** Except for Class A digital devices, the field strength of radiated emissions from unintentional radiators at a distance of 3 meters shall not exceed the Class B limits expressed in Table 6.

15.109 (b) The field strength of radiated emissions from a Class A digital device, as determined at a distance of 10 meters, shall not exceed the Class A limits expressed in Table 6.

Frequency (MHz)	Field Strength (dB μ V/m)	
	§15.109 (b), Class A Limit (dB μ V/m) @ 10m	§15.109 (a), Class B Limit (dB μ V/m) @ 3m
30 - 88	39.00	40.00
88 - 216	43.50	43.50
216 - 960	46.40	46.00
Above 960	49.50	54.00

Table 6. Radiated Emissions Limits calculated from FCC Part 15, §15.109 (a) (b)

Test Procedures: The EUT was placed on a non-metallic table, 80 cm above the ground plane on the turntable inside a semi-anechoic chamber. The method of testing and test conditions of ANSI C63.4 were used. An antenna was located 3 m from the EUT on an adjustable mast. A pre-scan was first performed in order to find prominent radiated emissions. For final emissions measurements at each frequency of interest, the EUT was rotated and the antenna height was varied between 1 m and 4 m in order to maximize the emission. Measurements in both horizontal and vertical polarities were made and the data was recorded. Unless otherwise specified, measurements were made using a quasi-peak detector with a 120 kHz bandwidth.

Test Results: The EUT was compliant with the Class B requirement(s) of this section. Measured emissions were below applicable limits.

Test Engineer(s): Surinder Singh

Test Date(s): 12/10/13

Radiated Emissions Limits Test Results, Class B

Frequency (MHz)	EUT Azimuth (Degrees)	Antenna Polarity (H/V)	Antenna HEIGHT (m)	Uncorrected Amplitude (dB μ V)	Antenna Correction Factor (dB) (+)	Cable Loss (dB) (+)	Distance Correction Factor (dB) (-)	Corrected Amplitude (dB μ V/m)	Limit (dB μ V/m)	Margin (dB)
37.41483	342	H	1.26	5.02	16.19	0.41	0.00	21.62	40.00	-18.38
37.41483	352	V	1.24	5.10	16.19	0.41	0.00	21.70	40.00	-18.30
831.06212	332	H	1.25	5.50	22.42	2.60	0.00	30.52	46.00	-15.48
831.06212	322	V	1.28	5.42	22.42	2.60	0.00	30.44	46.00	-15.56

Table 7. Radiated Emissions Limits, Test Results, 30 MHz – 1 GHz

Note: The EUT was tested at 3 m.

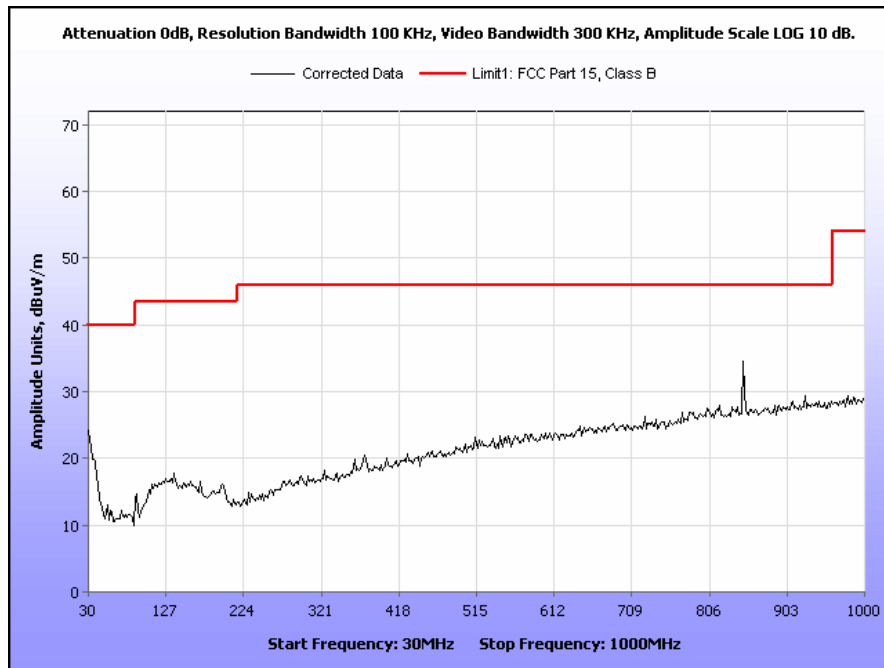

Plot 1. Radiated Emissions, 30 MHz - 1 GHz

Radiated Emissions Limits Test Setup

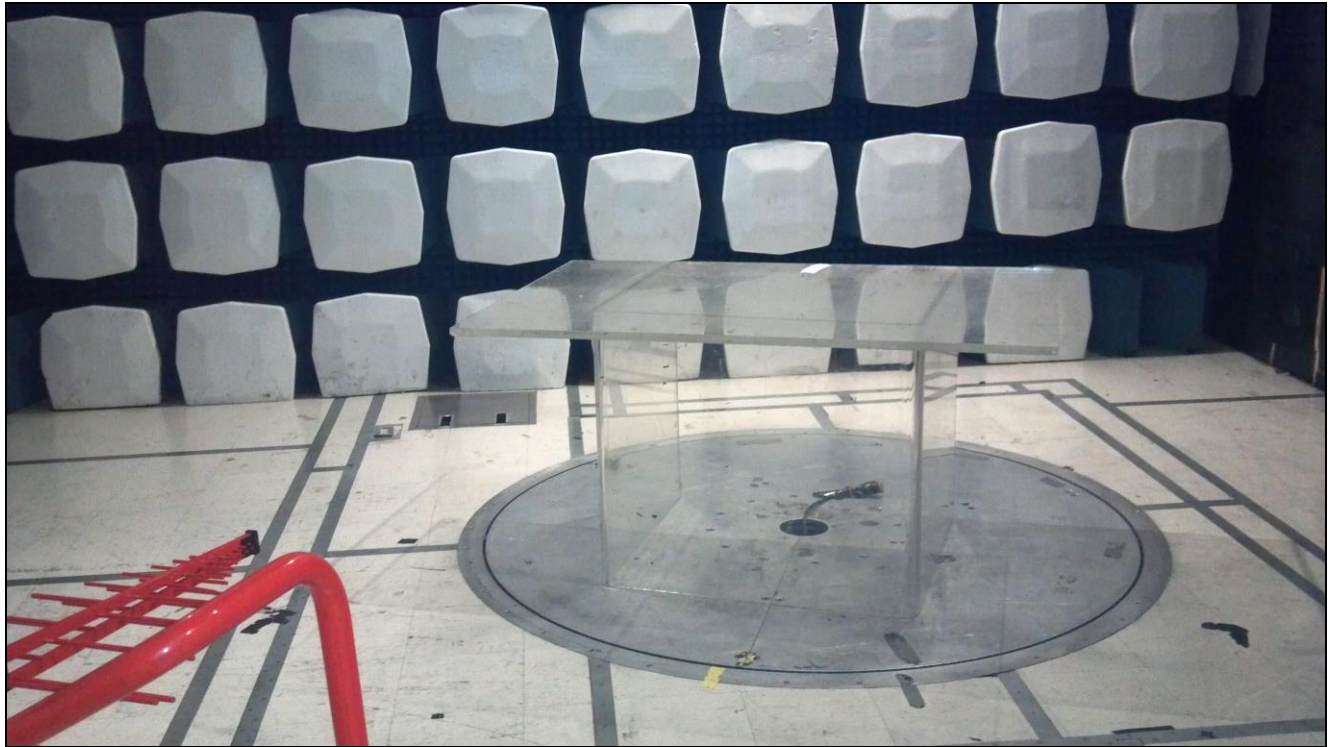

Photograph 2. Radiated Emissions, Test Setup

IV. Electromagnetic Compatibility Criteria for Intentional Radiators

Electromagnetic Compatibility Criteria for Intentional Radiators

§ 15.203 Antenna Requirement

Test Requirement: § 15.203: An intentional radiator shall be designed to ensure that no antenna other than that furnished by the responsible party shall be used with the device. The use of a permanently attached antenna or of an antenna that uses a unique coupling to the intentional radiator shall be considered sufficient to comply with the provisions of this section. The manufacturer may design the unit so that a broken antenna can be replaced by the user, but the use of a standard antenna jack or electrical connector is prohibited.

The structure and application of the EUT were analyzed to determine compliance with Section 15.203 of the Rules. Section 15.203 states that the subject device must meet at least one of the following criteria:

- a.) Antenna must be permanently attached to the unit.
- b.) Antenna must use a unique type of connector to attach to the EUT.
- c.) Unit must be professionally installed. Installer shall be responsible for verifying that the correct antenna is employed with the unit.

Results: The EUT is compliant the criteria of §15.203. The EUT has an integral antenna.

Test Engineer(s): Surinder Singh

Test Date(s): 12/10/13

Electromagnetic Compatibility Criteria for Intentional Radiators

§ 15.231 (a) Periodic Operation Requirements

Test Requirement(s): § 15.231 (a): The provisions of this section are restricted to periodic operation within the band 40.66-40.70 MHz and above 70 MHz. Except as shown in paragraph (e) of this section, the intentional radiator is restricted to the transmission of a control signal such as those used with alarm systems, door openers, remote switches, etc. Continuous transmissions, voice, video and the radio control of toys are not permitted. Data is permitted to be sent with a control signal. The following conditions shall be met to comply with the provisions for this periodic operation:

- (1) A manually operated transmitter shall employ a switch that will automatically deactivate the transmitter within not more than 5 seconds of being released.

Test Procedure: The EUT transmitter was activated. The spectrum analyzer single sweep was triggered while a command on the EUT was activated and plots were captured.

Test Results: Marker 1 is when the EUT button was released. The plot clearly shows that the transmitter stopped transmitting within 5s.

Test Engineer(s): Surinder Singh

Test Date(s): 12/23/13

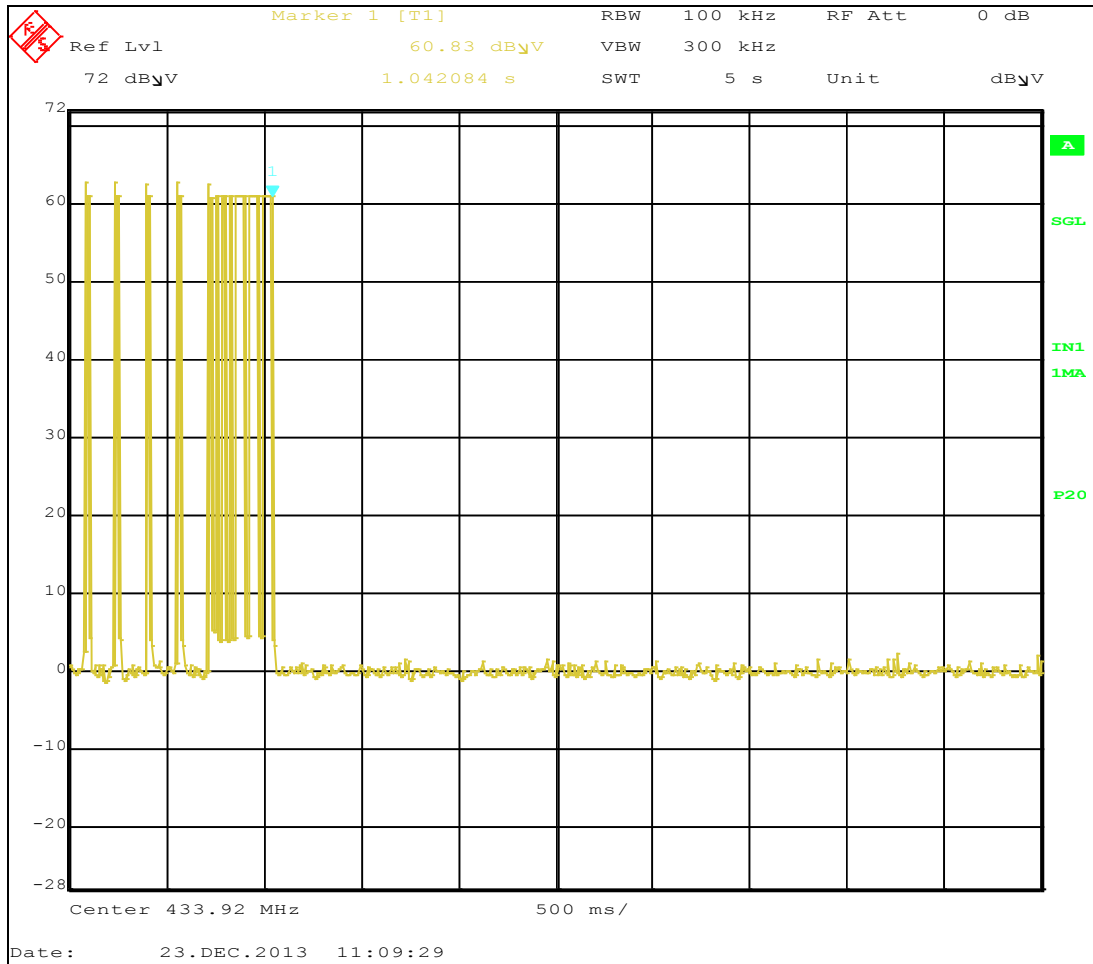

Plot 2. Periodic Operation Requirement, 433 MHz, 5s Sweep

Electromagnetic Compatibility Criteria for Intentional Radiators

§ 15.231(b) Field Strength of Fundamental and Harmonics

Test Requirements: §15.231(b): In addition to the provisions of §15.205, the field strength of emissions from intentional radiators operated under this section shall not exceed the following:

Fundamental Frequency (MHz)	Field Strength of Fundamental (microvolts/meter)	Field Strength of Spurious Emission (microvolts/meter)
40.66 – 407.70	2,250	225
70 – 130	1,2500	125
130 – 174	1,250 to 3,750 ¹	125 to 375 ¹
174 – 260	3,750	375
260 – 470	3,750 to 12,500 ¹	375 to 1,250 ¹
Above 470	12,500	1250

¹Linear interpolations.

Test Procedure: The EUT was placed in a 3m semi anechoic chamber. A log periodic antenna was placed 3m from the EUT and used to measure the field strength of the fundamental. The EUT was rotated about all three orthogonal axis. The average field strength was measured and recorded.

A Duty Cycle Correction Factor was removed from the Peak field strength to produce a corrected average field strength. The limit was determined through linear interpolation of the limits described in 15.231(b). The maximum allowable field strength was determined to be 82 dBuV/m. The measured field strength was compared to this limit.

For spurious emissions above 1GHz, peak emissions were compliant under the average limit.

Test Results: Equipment complies with § 15.231 (e).

Test Engineer: Surinder Singh

Test Date: 12/11/13

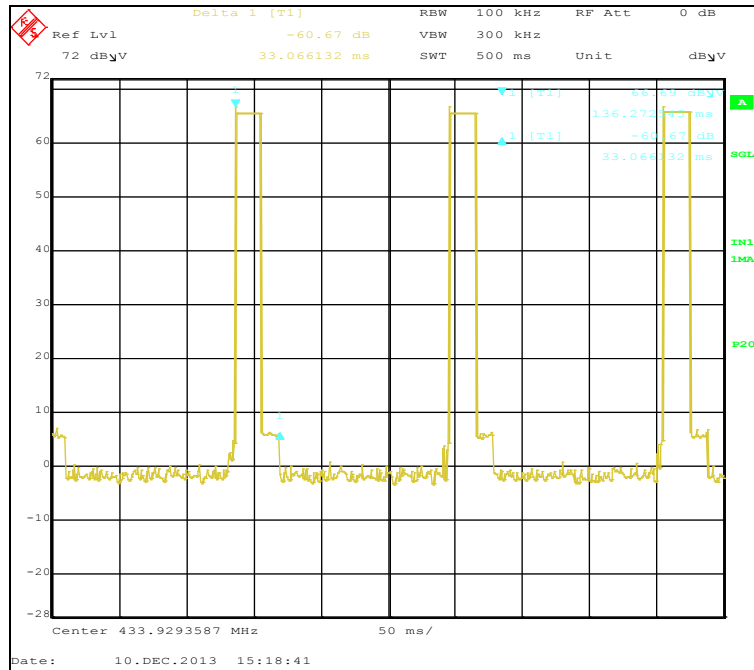

Plot 3. Transmitter ON time

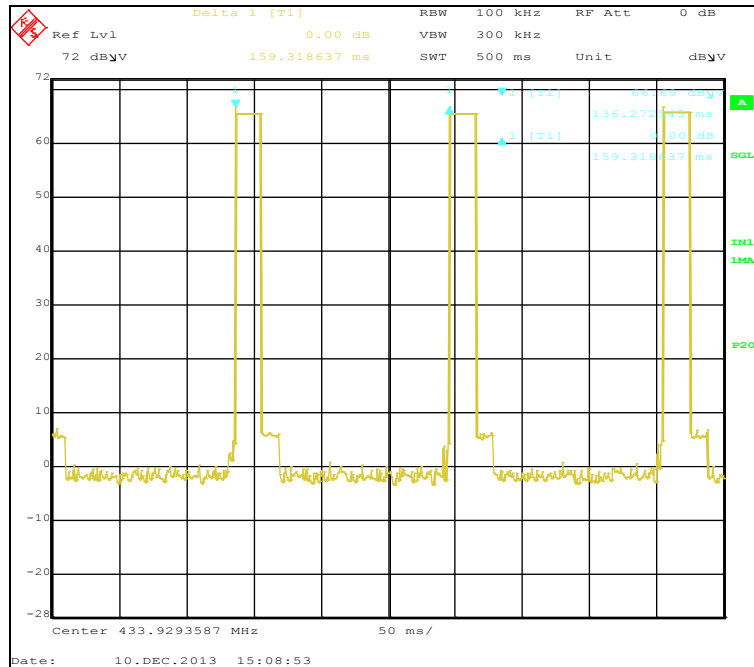

Plot 4. Transmitter Period

$$\begin{aligned} \text{Duty Cycle Correction Factor} &= 20\log(\text{ON/Period}) \\ &= 20\log(33.06/159.31) \\ &= \mathbf{-13.6 \text{ dB}} \end{aligned}$$

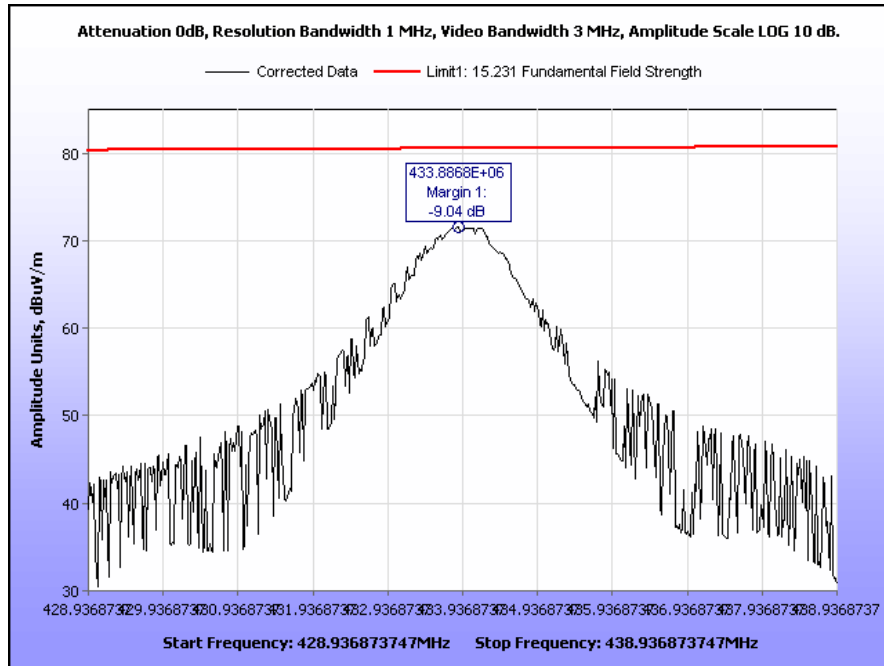

Plot 5. Field Strength of Fundamental, 433 MHz, Avg.

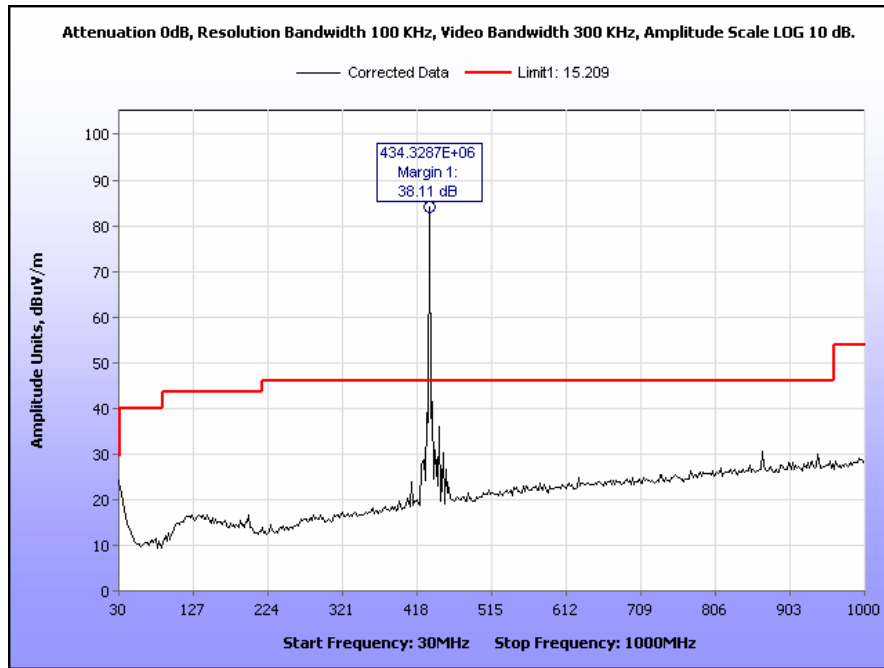

Plot 6. Radiated Spurious Emissions, 433 MHz, 30 MHz – 1 GHz

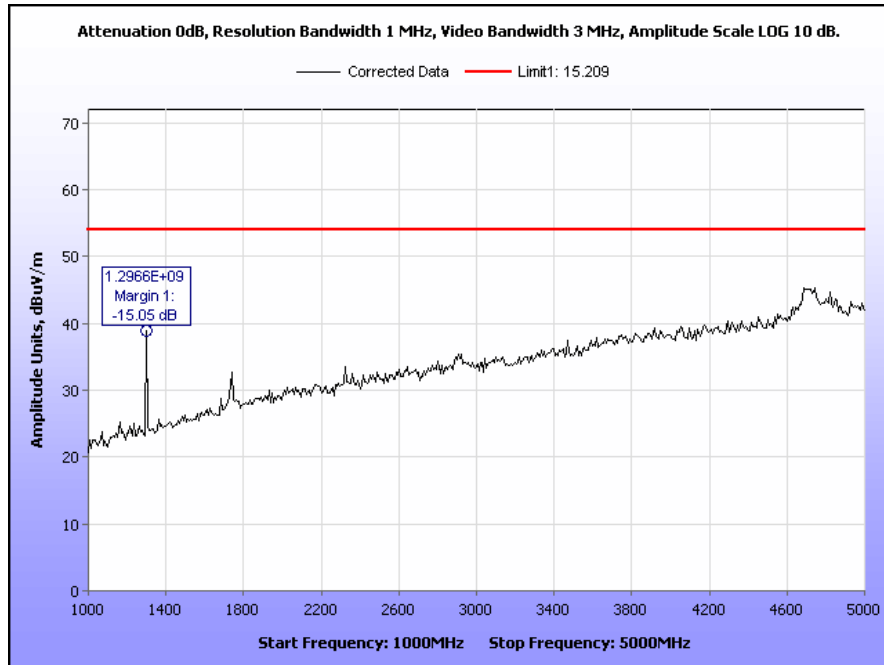

Plot 7. Radiated Spurious Emissions, 433 MHz, 1 GHz – 5 GHz

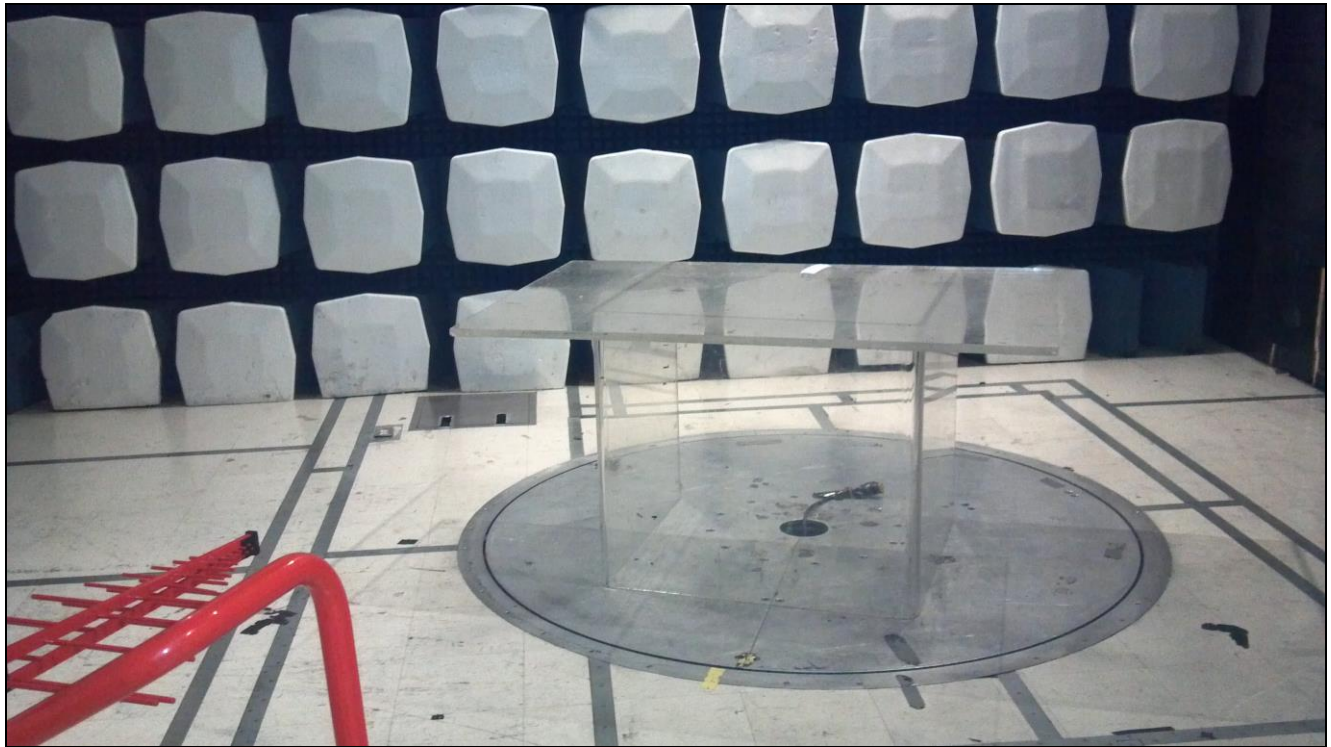

Photograph 3. Fundamental Field Strength, Harmonic/Spurious Emission 1-5GHz Test Setup

Electromagnetic Compatibility Criteria for Intentional Radiators

§ 15.231(c) 20dB Bandwidth

Test Requirements: §15.231(c): The bandwidth of the emission shall be no wider than 0.25% of the center frequency for devices operating above 70MHz and below 900MHz. For devices operating above 900MHz, the emission shall be no wider than 0.5% of the center frequency. Bandwidth is determined at the points 20dB down from the modulated carrier. For a center frequency of 433.92MHz, the maximum allowable 20dB bandwidth was determined to be 2169.6 kHz.

Test Results: Equipment complies with § 15.231(c).

Test Engineer: Surinder Singh

Test Date: 12/11/13

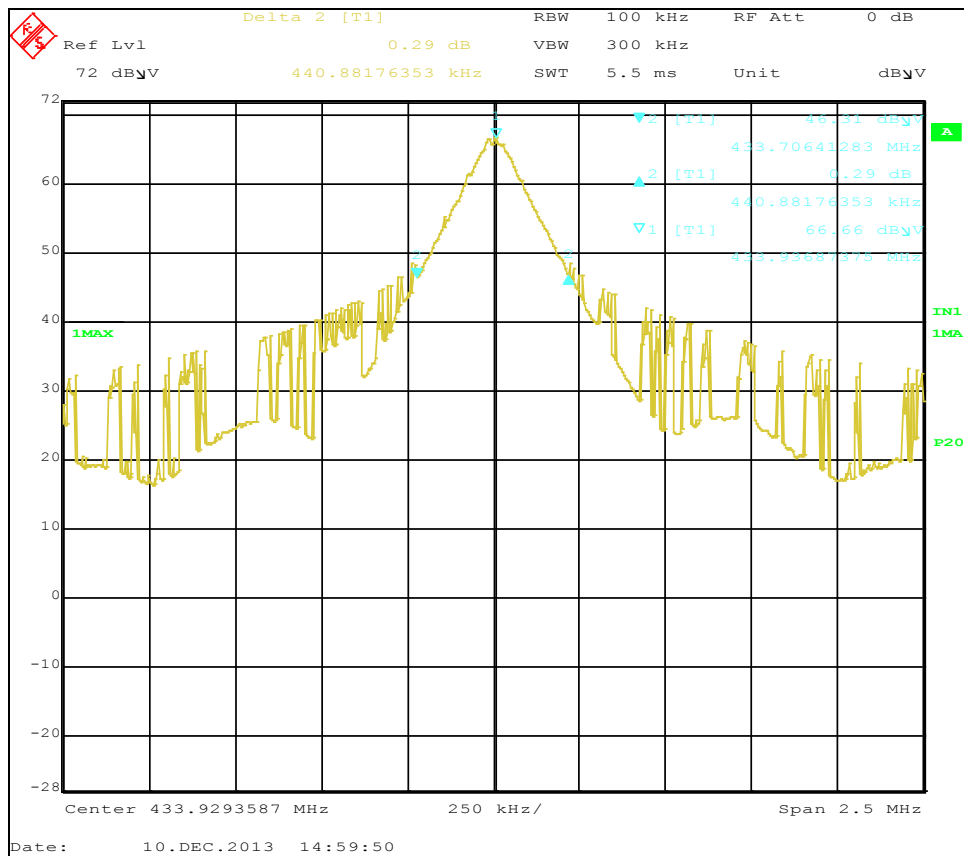

Plot 8. 20 dB Bandwidth Plot

IV. Test Equipment

Test Equipment

Calibrated test equipment utilized during testing was maintained in a current state of calibration per the requirements of ISO/IEC 17025:2005.

MET #	Equipment	Manufacturer	Model#	Cal Date	Cal Due
1T440 9	EMI RECEIVER	ROHDE & SCHWARZ	ESIB7	7/16/2012	7/16/2014
1T481 8	COMB GENERATOR	COM-POWER	CGO-520	SEE NOTE	
1T478 7	HYGROMETER / THERMOMETER / BAROMETER / DEW POINT PEN	CONTROL COMPANY	15-078-198, FB70423, 245CD	2/15/2012	2/15/2014
1T480 0	ANTENNA, LOOP	EMCO	6512	8/6/2012	2/6/2014
1T475 1	ANTENNA - BILOG	SUNOL SCIENCES	JB6	1/8/2013	7/8/2014
1T266 5	ANTENNA; HORN	EMCO	3115	9/5/2012	3/5/2014

Table 8. Test Equipment List

Note: Functionally verified test equipment is verified using calibrated instrumentation at the time of testing.

V. Certification & User's Manual Information

Certification & User's Manual Information

A. Certification Information

The following is extracted from Title 47 of the Code of Federal Regulations, Part 2, Subpart I — Marketing of Radio frequency devices:

§ 2.801 Radio-frequency device defined.

As used in this part, a radio-frequency device is any device which in its operation is capable of Emitting radio-frequency energy by radiation, conduction, or other means. Radio- frequency devices include, but are not limited to:

- (a) The various types of radio communication transmitting devices described throughout this chapter.
- (b) *The incidental, unintentional and intentional radiators defined in Part 15 of this chapter.*
- (c) The industrial, scientific, and medical equipment described in Part 18 of this chapter.
- (d) Any part or component thereof which in use emits radio-frequency energy by radiation, conduction, or other means.

§ 2.803 Marketing of radio frequency devices prior to equipment authorization.

- (a) Except as provided elsewhere in this chapter, no person shall sell or lease, or offer for sale or lease (including advertising for sale or lease), or import, ship or distribute for the purpose of selling or leasing or offering for sale or lease, any radio frequency device unless:
 - (1) In the case of a device subject to certification, such device has been authorized by the Commission in accordance with the rules in this chapter and is properly identified and labeled as required by §2.925 and other relevant sections in this chapter; or
 - (2) In the case of a device that is not required to have a grant of equipment authorization issued by the Commission, but which must comply with the specified technical standards prior to use, such device also complies with all applicable administrative (including verification of the equipment or authorization under a Declaration of Conformity, where required), technical, labeling and identification requirements specified in this chapter.
- (d) Notwithstanding the provisions of paragraph (a) of this section, the offer for sale solely to business, commercial, industrial, scientific or medical users (but not an offer for sale to other parties or to end users located in a residential environment) of a radio frequency device that is in the conceptual, developmental, design or pre-production stage is permitted prior to equipment authorization or, for devices not subject to the equipment authorization requirements, prior to a determination of compliance with the applicable technical requirements *provided* that the prospective buyer is advised in writing at the time of the offer for sale that the equipment is subject to the FCC rules and that the equipment will comply with the appropriate rules before delivery to the buyer or to centers of distribution.

- (e)(1) Notwithstanding the provisions of paragraph (a) of this section, prior to equipment authorization or determination of compliance with the applicable technical requirements any radio frequency device may be operated, but not marketed, for the following purposes and under the following conditions:
- (i) *Compliance testing*;
 - (ii) Demonstrations at a trade show provided the notice contained in paragraph (c) of this section is displayed in a conspicuous location on, or immediately adjacent to, the device;
 - (iii) Demonstrations at an exhibition conducted at a business, commercial, industrial, scientific or medical location, but excluding locations in a residential environment, provided the notice contained in paragraphs (c) or (d) of this section, as appropriate, is displayed in a conspicuous location on, or immediately adjacent to, the device;
 - (iv) Evaluation of product performance and determination of customer acceptability, provided such operation takes place at the manufacturer's facilities during developmental, design or pre-production states; or
 - (v) Evaluation of product performance and determination of customer acceptability where customer acceptability of a radio frequency device cannot be determined at the manufacturer's facilities because of size or unique capability of the device, provided the device is operated at a business, commercial, industrial, scientific or medical user's site, but not at a residential site, during the development, design or pre-production stages.
- (e)(2) For the purpose of paragraphs (e)(1)(iv) and (e)(1)(v) of this section, the term *manufacturer's facilities* includes the facilities of the party responsible for compliance with the regulations and the manufacturer's premises, as well as the facilities of other entities working under the authorization of the responsible party in connection with the development and manufacture, but not the marketing, of the equipment.
- (f) For radio frequency devices subject to verification and sold solely to business, commercial, industrial, scientific and medical users (excluding products sold to other parties or for operation in a residential environment), parties responsible for verification of the devices shall have the option of ensuring compliance with the applicable technical specifications of this chapter at each end user's location after installation, provided that the purchase or lease agreement includes a proviso that such a determination of compliance be made and is the responsibility of the party responsible for verification of the equipment.

Certification & User's Manual Information

The following is extracted from Title 47 of the Code of Federal Regulations, Part 2, Subpart J — Equipment Authorization Procedures:

§ 2.901 Basis and Purpose

- (a) In order to carry out its responsibilities under the Communications Act and the various treaties and international regulations, and in order to promote efficient use of the radio spectrum, the Commission has developed technical standards for radio frequency equipment and parts or components thereof. The technical standards applicable to individual types of equipment are found in that part of the rules governing the service wherein the equipment is to be operated.¹ *In addition to the technical standards provided, the rules governing the service may require that such equipment be verified by the manufacturer or importer, be authorized under a Declaration of Conformity, or receive an equipment authorization from the Commission by one of the following procedures: certification or registration.*
- (b) The following sections describe the verification procedure, the procedure for a Declaration of Conformity, and the procedures to be followed in obtaining certification from the Commission and the conditions attendant to such a grant.

§ 2.907 Certification.

- (a) Certification is an equipment authorization issued by the Commission, based on representation and test data submitted by the applicant.
- (b) Certification attaches to all units subsequently marketed by the grantee which are identical (see Section 2.908) to the sample tested except for permissive changes or other variations authorized by the Commission pursuant to Section 2.1043.

¹ In this case, the equipment is subject to the rules of Part 15. More specifically, the equipment falls under Subpart B (of Part 15), which deals with unintentional radiators.

Certification & User's Manual Information

§ 2.948 Description of measurement facilities.

- (a) Each party making measurements of equipment that is subject to an equipment authorization under Part 15 or Part 18 of this chapter, regardless of whether the measurements are filed with the Commission or kept on file by the party responsible for compliance of equipment marketed within the U.S. or its possessions, shall compile a description of the measurement facilities employed.
- (1) If the measured equipment is subject to the verification procedure, the description of the measurement facilities shall be retained by the party responsible for verification of the equipment.
- (i) *If the equipment is verified through measurements performed by an independent laboratory, it is acceptable for the party responsible for verification of the equipment to rely upon the description of the measurement facilities retained by or placed on file with the Commission by that laboratory. In this situation, the party responsible for the verification of the equipment is not required to retain a duplicate copy of the description of the measurement facilities.*
- (ii) If the equipment is verified based on measurements performed at the installation site of the equipment, no specific site calibration data is required. It is acceptable to retain the description of the measurement facilities at the site at which the measurements were performed.
- (2) If the equipment is to be authorized by the Commission under the certification procedure, the description of the measurement facilities shall be filed with the Commission's Laboratory in Columbia, Maryland. The data describing the measurement facilities need only be filed once but must be updated as changes are made to the measurement facilities or as otherwise described in this section. At least every three years, the organization responsible for filing the data with the Commission shall certify that the data on file is current.

Certification & User's Manual Information

Label and User's Manual Information

The following is extracted from Title 47 of the Code of Federal Regulations, Part 15, Subpart A — General:

§ 15.19 Labeling requirements.

(a) *In addition to the requirements in Part 2 of this chapter, a device subject to certification or verification shall be labeled as follows:*

- (1) Receivers associated with the operation of a licensed radio service, e.g., FM broadcast under Part 73 of this chapter, land mobile operation under Part 90, etc., shall bear the following statement in a conspicuous location on the device:

This device complies with Part 15 of the FCC Rules. Operation is subject to the condition that this device does not cause harmful interference.

- (2) A stand-alone cable input selector switch, shall bear the following statement in a conspicuous location on the device:

This device is verified to comply with Part 15 of the FCC Rules for use with cable television service.

- (3) All other devices shall bear the following statement in a conspicuous location on the device:

This device complies with Part 15 of the FCC Rules. Operation is subject to the following two conditions: (1) This device may not cause harmful interference, and (2) this device must accept any interference received, including interference that may cause undesired operation.

- (4) Where a device is constructed in two or more sections connected by wires and marketed together, the statement specified under paragraph (a) of this section is required to be affixed only to the main control unit.

- (5) When the device is so small or for such use that it is not practicable to place the statement specified under paragraph (a) of this section on it, the information required by this paragraph shall be placed in a prominent location in the instruction manual or pamphlet supplied to the user or, alternatively, shall be placed on the container in which the device is marketed. However, the FCC identifier or the unique identifier, as appropriate, must be displayed on the device.

§ 15.21 Information to user.

The users manual or instruction manual for an intentional or unintentional radiator shall caution the user that changes or modifications not expressly approved by the party responsible for compliance could void the user's authority to operate the equipment.

Verification & User's Manual Information

The following is extracted from Title 47 of the Code of Federal Regulations, Part 15, Subpart B — Unintentional Radiators:

§ 15.105 Information to the user.

- (a) For a Class A digital device or peripheral, the instructions furnished the user shall include the following or similar statement, placed in a prominent location in the text of the manual:

Note: This equipment has been tested and found to comply with the limits for a Class A digital device, pursuant to Part 15 of the FCC Rules. These limits are designed to provide reasonable protection against harmful interference when the equipment is operated in a commercial environment. This equipment generates, uses, and can radiate radio frequency energy and, if not installed and used in accordance with the instruction manual, may cause harmful interference to radio communications. Operation of this equipment in a residential area is likely to cause harmful interference in which case the user will be required to correct the interference at own expense.

- (b) For a Class B digital device or peripheral, the instructions furnished the user shall include the following or similar statement, placed in a prominent location in the text of the manual:

Note: This equipment has been tested and found to comply with the limits for a Class B digital device, pursuant to Part 15 of the FCC Rules. These limits are designed to provide reasonable protection against harmful interference when the equipment is operated in a residential environment. This equipment generates, uses, and can radiate radio frequency energy and, if not installed and used in accordance with the instruction manual, may cause harmful interference to radio communications. However, there is no guarantee that interference will not occur in a particular installation. If this equipment does cause harmful interference to radio or television reception, which can be determined by turning the equipment off and on, the user is encouraged to try to correct the interference by one or more of the following measures:

- Reorient or relocate the receiving antenna.
- Increase the separation between the equipment and receiver.
- Connect the equipment into an outlet on a circuit different from that to which the receiver is connected.
- Consult the dealer or an experienced radio/TV technician for help.

End of Report