

RM2004

User Instruction Manual

FM / MW / LW & DAB receiver, USB, BT audio media player, four channel audio amplifier, fixed front panel

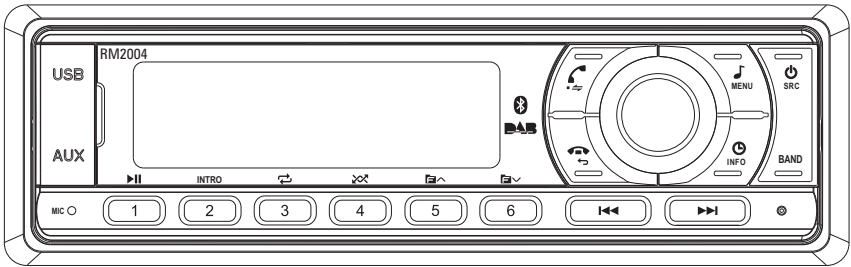
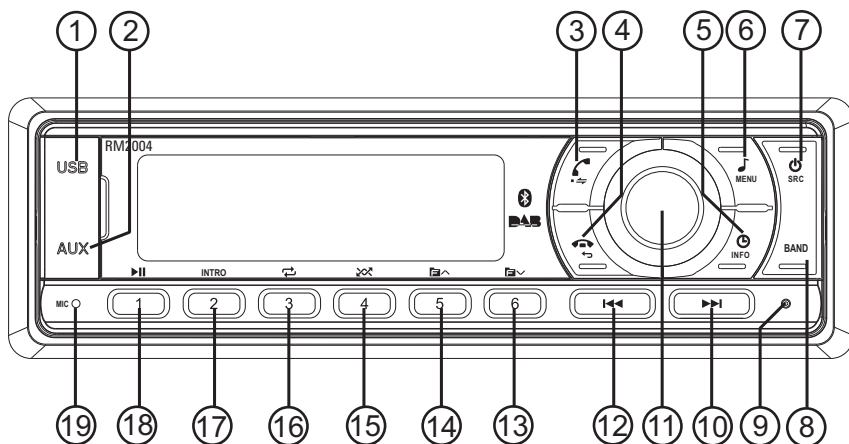

Table of Contents

Front Panel Layout	3
General Operation	4
Bluetooth Operation	5
Radio FM/MW/LW	5
Radio RDS Notes	6
Radio Preset Notes	6
Radio DAB/DAB+	7
Radio DAB/DAB+ Notes	7
iPod/iPhone	8
Media USB	9
Reset - Software / Hardware	9
Power Off Timer	10
Menu Reference	10
Context Sensitive	10
Wiring Notes	11
Mounting Notes	12
Technical	12

Front Panel Layout



Item	Button Name	Comments
1	USB	
2	AUX-IN	3.5mm Stereo Socket
3	Call Pick Up	Transfer or last number re-dial
4	Call Hang Up	Return from menu or selection
5	INFO (information) / Clock	Select info to view or display clock
6	Menu	Audio and System menus
7	Source / Power	Radio / DAB / BT / USB /AUX- On/Off
8	Band	FM/MW/LW band select
9	Reset	
10	Up >>I / Next	
11	Mute / Select (center switch)	
12	Down I<< / Previous	
13	Preset 6 (Folder - Previous)	
14	Preset 5 (Folder - Next)	
15	Preset 4 (RDM - Random Play)	
16	Preset 3 (RPT - Repeat)	
17	Preset 2 (INTRO)	
18	Preset 1 (Play / Pause)	Play/Pause media control
19	Built-In Mic (if fitted)	Optional. (Ext Mic. is Standard)

General Operation

Buttons to navigate through Menus

In the menu system certain controls have some common functions to help you move through the menus:

- 1) Volume control centre switch = select
- 2) Volume control rotary = "choose"
- 3) Hang Up (Return on non BT models) = return or move back up a menu level

Powering On/Off

To switch the unit on press the power button. To turn the unit off, press and hold the power button for 2 seconds.

In a similar manner many of the buttons on the front panel have two modes of activation: "Short press" and "Long press" to directly select different functions.

The 'Volume' Knob

Audio volume is adjusted when the rotary knob is turned, and MUTE is toggled on/off when the knob is pressed briefly - short press.

In the SYSTEM or AUDIO menus volume adjustment is temporarily disabled, and the rotation of the knob adjusts the value of the menu item. In this mode pressing the volume knob will select the item you have chosen. The menu list may also be cycled through with the >>| and |<< buttons.

Example: short press (push and let go) the MENU button to access the AUDIO menu – EQ, loudness, bass, treble, balance, and fader.

Radio Operating Region

When the radio is first powered up or after a reset it will ask you to select the geographical radio operating region, use the rotary control to choose your region and press the knob to select.

This can also be set using the Radio Mode menu – all menus are context sensitive i.e. radio only functions can only be accessed in radio mode.

Button Functions

The function of some controls depends on context. For example, the "1" button is used to recall (short press) or store (long press) radio station preset 1. However, when playing media (USB, BT), pressing this button will toggle play / pause.

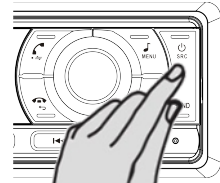

TURN for Volume adjustment /
PRESS to MUTE

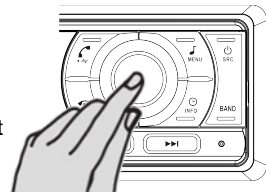

TURN to choose /
PRESS to select

REGIONS AVAILABLE

EUROPE / ASIA / MID-EAST /
AUST / USA / LATIN (America) /
JAPAN / RUSSIA

Bluetooth Operation (not available on RM1800 and RM1900 non-BT models)

General Operation

When paired to a mobile phone Bluetooth-enabled radio models, allow the user to perform handsfree calling via the radio. The radio has “Answer” and “Hang-Up” buttons to accept or reject an incoming call.

When no call is active the “Answer” button can be used to re-dial the last number - pressing once asks if you want to re-dial, pressing again dials the number, pressing the “Hang-Up” button cancels the request.

The external microphone should be fitted in a position close to the operator.

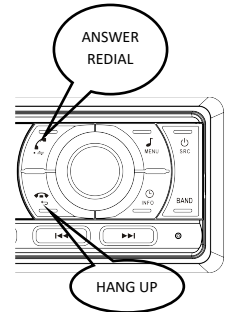

Bluetooth Profiles

Bluetooth enabled units can wirelessly link to Bluetooth devices such as mobile phones. The modes of Bluetooth connection are referred to as “profiles”. This radio supports the following profiles:

- 1) A2DP: Advanced Audio Distribution Profile – Playing (Streaming) music using Bluetooth. Devices that have A2DP functionality can stream music into the radio to be played through the vehicle's loudspeaker system.
- 2) AVRCP: In addition, if supported by the device, the AVRCP profile (Remote Control Profile), allowing functions like ‘next track’ and ‘previous track’ to be controlled from the radio.
- 3) HFP: Handsfree Profile – Making or receiving telephone calls using Bluetooth.
- 4) SSP: Secure Simple Pairing - this method is based on a random number generator and the user does not need to enter a PIN number on the phone.

Pairing

To use the Bluetooth handsfree function a mobile phone needs to be “paired” to the radio. To “pair” the mobile phone with the radio ensure that the radio is turned on. On the mobile phone search for Bluetooth devices and select the radio model number. Check for a successful pairing notification on the mobile phone.

Once paired it is the mobile phone that determines automatic reconnection to the radio. (e.g. on re-entry to the vehicle with the ignition on).

To disconnect a Bluetooth device temporarily use the “DISCONN” (disconnect) menu function. To permanently remove a pairing, use the “UNPAIR” menu function.

Radio FM/MW/LW

Searching for Radio Stations

Use the >>| and |<< buttons to search for radio stations: short press to automatically seek the next available frequency (jump to the next seek stop).

Manual Tuning

Long press either the >>| or |<< button to change to manual-seek mode. In this mode a short press of one of these seek buttons changes frequency one step at a time whereas a long press will scroll until the button is released. The radio will revert to auto-seek mode if either button is not operated for 3 seconds.

AutoStore Radio Stations

Long press the BAND button will start an “auto store” sequence to scan the whole band and store the strongest stations found.

Radio FM/MW/LW - Continued

Storing and Recalling Radio Stations

When listening to a radio station a long press on one of the radio preset buttons will store it permanently. The current station will be saved. A stored radio station can be recalled by a short press of one of these buttons. The stored radio station can be updated by tuning to a different station and performing a long press.



Long press: Store your favorite radio stations using radio station presets.
Short press: Recall the stored station.

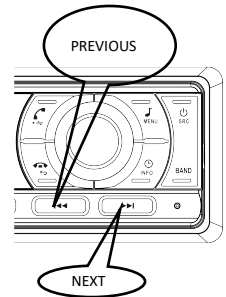

FM Radio

Radio Data System (RDS) is available in many countries. If an RDS broadcast is present, RDS functions such as AF and TA can be enabled or disabled. RDS is only available in the FM bands.

RDS (see also "Radio RDS Notes")

AF: Alternative Frequency
TA: Traffic Announcement
TP: Traffic Program
PTY: Program type

Radio RDS Notes

When RDS (Radio Data System) is operating the radio will show the station name e.g. "BBC R1" rather than the frequency. RDS is only available on the FM band. If RDS service is not available, the radio operates in conventional FM radio mode.

- AF:** Alternative Frequencies. When this feature is enabled, the radio can stay tuned to BBC R1 by automatically retuning the reception frequency when the first signal becomes weak such as when the vehicle has moved out of range, providing that a stronger signal on the alternative frequency is available. Channel switching to the same radio station is performed automatically. In fringe reception areas the user may switch off AF if silent frequency seek is experienced frequently. Choose the AF menu item and select OFF.
- TA:** Traffic Announcement. When switched on, if a traffic announcement is available the radio will automatically switch to the station broadcasting the announcement until it is complete. The TA menu item toggles between TA ON and TA OFF.
- TP:** Traffic Program – An indicator is displayed if the currently tuned station is a traffic announcement capable station.
- PTY:** Program type. RDS broadcasting services categorizes the type of programs for the listener. Examples are NEWS, AFFAIRS, INFO, SPORT, EDUCATION, DRAMA, CULTURE, SCIENCE, POP M, ROCK.

Radio Preset Notes

FM has 3 bands, FM1, FM2 and FM3 bands each band has 6 radio presets. In total there are 18 FM radio presets for the user to store pre-tuned radio stations.

MW has one band with 6 radio presets, as does LW. There are 12 AM (MW & LW) radio presets.

DAB mode also has 3 "bands", DAB1, DAB2 and DAB3 each with 6 presets to store your favorite stations.

In total there are $5 \times 6 = 30$ radio presets and 18 DAB presets available to the user. The radio stores these permanently on an EEPROM memory device, that does not require external power to retain the radio station preset memory.

Radio DAB/DAB+

Digital Audio Broadcasting - DAB/DAB+ Mode

DAB is a terrestrial digital transmission system. DAB stations bundle radio programs ("services") into an ensemble. Each ensemble contains one or more radio services. The same service can sometimes be received on different frequencies.

DAB/DAB+

To listen to DAB radio press SRC to select "DAB/DAB+".

When the DAB band is selected for the first time an initial scan is needed. The radio will ask for confirmation to do this – press the volume control knob to start scanning. Allow the initial scan to finish. (If interrupted, the initial scan will be requested again the next time you select the DAB mode)

Tuning DAB Stations

Enter the DAB system menu with a long press on the MENU button, select SCAN to perform a full scan of the DAB band.

To update the station list (usually because you have moved to a different geographical region) enter the DAB system menu and select PRUNE to clean up the stored list of DAB stations.

Selecting a DAB Station

Method 1: Use the >>| and |<< buttons to select the next (or previous) DAB station in the alphabetically sorted list of stations.

Method 2: PREFERRED - Long press the BAND/BROWSE button to select the BROWSE feature. This will allow you to use the rotary volume control knob to scroll through the DAB station list. Press the volume knob to select the station name you want.

Storing and Recalling DAB Stations

To store a favourite station press and hold down one of the user preset buttons 1 – 6 until a beep is heard or "SAVED" is displayed. To recall any one of your preferred stations, briefly press the desired preset button.

Radio DAB/DAB+ Notes

When there is no reception, "NO STATION FOUND" scrolling text is shown on the display. Use "seek up" () or "seek down" () button to search for the next available DAB radio broadcast.

When reception is lost for approximately 15 seconds "NO SIGNAL" is displayed.

DAB is a digital system and as such it either works and clear audio is heard or it does not work and the audio is muted. This is unlike a traditional FM broadcast that becomes increasingly noisy but may still be intelligible.

iPod/iPhone

Connecting iPod/iPhone

- 1) Open the front cover
- 2) Connect the iPod/iPhone with the USB socket.

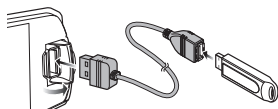

The unit reads the device and playback starts.

Connectable iPod/iPhone

The following models can be connected to this unit.

Made for

- iPhone XS Max
- iPhone X
- iPhone 8 Plus
- iPhone 8
- iPhone 7 Plus
- iPhone XS
- iPhone SE
- iPhone 6s Plus
- iPhone 6s
- iPhone 7
- iPhone XR
- iPhone 5s
- iPhone 6 Plus
- iPhone 6

IMPORTANT NOTE:

- If you start playback after connecting the iPod, the music that has been played by the iPod is played first.

Playback Operation

The following models can be connected to this unit.

- >>| Next track (short press), fast forward (press and hold down)
- |<< Previous track (short press), rewind (press and hold down)
- >|| Play and Pause playback.

Repeat

Repeat play mode. RPT TRK repeats the current track when it has reached the end. RPT FLD repeats playing of all the tracks in the current folder. RPT ALL repeats all the tracks in the entire media library.

Random

RDM Random-play, RDM ALL randomly plays from all tracks. RDM FLD plays tracks randomly from the current folder. RDM OFF plays tracks in the order they appear in the folder.

Media USB

One single media device can easily fit thousands of songs (audio tracks). These tracks are often referred to as MP3 and WMA. Without any specific metadata, the radio uses the track filename as the title. Tracks can be put into folders and sub-folders.

For media carriers such as USB sticks, the unit can play files inside sub-folders.

Avoid having too many levels of depth in the sub-folders.

Do not carry too many audio files on a media to avoid difficulty in finding the desired song / track.

Media software and hardware are updated at a fast pace, so although the radio is shipped with the latest media compatibility; newer USB sticks and/or new file formats may not be compatible.

Listed below are the alternative functions of various keys on the front panel for media playback.

>>| Next track (short press), fast forward (press and hold down)

|<< Previous track (short press), rewind (press and hold down)

>|| Play and Pause playback.

Repeat play mode. RPT TRK repeats the current track when it has reached the end. RPT FLD repeats playing of all the tracks in the current folder. RPT ALL repeats all the tracks in the entire media library.

INTRO Intro-play indicator will be shown on the LCD display. When in this mode the radio will play the first 10 seconds of each track (intro) then skip to the next track. When at the desired track, press the INTRO button again to cancel intro-play and listen to the whole track.

RDM Random-play, RDM ALL randomly plays from all tracks, RDM FLD plays tracks randomly from the current folder. RDM OFF plays tracks in the order they appear in the folder.

FLV / FLA Previous folder and next folder.

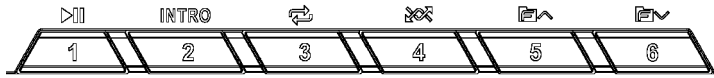

Reset - Software / Hardware

Soft Reset – MENU – RESET: If the user is not sure if settings on the radio have been altered inadvertently, restoring the factory default settings may help. On a reset factory settings will be reloaded, overwriting the current data selections with their default values. This includes such items as BT pairing, station presets, tone settings, etc.

Hard Reset - A hardware reset button is located on the front panel (see “Front Panel Layout”) and can be activated by a paper clip or pen. This is only necessary if the radio refuses to react to any button input.

Power Off Timer

This radio has a power-off-timer enhancement feature. The setting for this is accessed by a long press on the MENU button (system menu), in any mode, and using the >>| or |<< buttons to select the timer menu. Settings are OFF, AUTO, 30 min, 60 min and 90 min. OFF is the factory default value where the radio powers off immediately when the ignition key is switched off. This is the same as conventional radios.

AUTO mode will switch off the radio with the ignition, but you can turn the radio back on (or off) for a 30-minute period.

30, 60 or 90 minutes will keep the radio playing for this time after the ignition is switched off. Turning the radio off manually will cancel the timer and the radio will not switch on until the ignition is also turned on.

This count-down timer is shown on the display using the small secondary line of characters.

In the last 5 minutes of the count-down time the main display will warn the user that the radio is about to shut down.

This feature extends listening time and allows the ignition key to be removed for safety reasons. It also prevents the battery from being drained if the radio is left turned on for an extended period. Exact availability of this feature depends on the type of the vehicle since both a switched ignition "ACC" wire and a permanent battery "B+" wire are used to control this function and must be connected to the radio.

Menu Reference

SYSTEM MENU	
DIS-CON	Disconnect current BT device
UNPAIR	Forget current BT device
CLK (SET)	Set - Hours (down) Minutes (up)
CLK (12/24H)	Select 12/24 hour display
BEEP	Audible feedback (on/off)
RESET	Reset radio to default settings
MANUAL	Auto-play USB media on/off
TIMER	Off timer setting (off / AUTO / 30 / 60 / 90min.)

AUDIO MENU	
EQ	Equalisation presets
LOUD	Equal loudness contour on/off
BASS	Bass tone control
TREBLE	Treble tone control
BALANCE	Left/Right balance
FADER	Front/Rear fader

Menu Reference - Context Sensitive

RADIO (context sensitive items)	
LOC	Local or DX seek setting
AREA	Operating region
RDS	Radio Data System
PTY	Select and choose available content type
AF	Alternate Frequencies
TA	Traffic Announcement
CT	Clock Time & Date
SOFT	Soft mute on/off (*)

DAB/DAB+ (context sensitive items)	
SCAN	Scan the whole DAB band for stations
12V	Switch phantom power to DAB antenna on/off
PRUNE	Scan and clean up DAB station list

(*) *Soft mute is a noise reduction technique used in FM receivers to lower the volume when the signal to noise ratio decreases. If you are in a weak signal area we recommend that you keep this function OFF to get the maximum received signal even if more background noise or "hiss" is heard.*

Wiring Notes

Connections to be made at the rear of the unit during installation.

Connector A pins:

A4. B+ or BATT +12V

When the radio is turned on electrical power is supplied to the internal electronics of the unit through this pin. Main consuming blocks such as audio power amplifier and backlights draw power from this pin. Ensure the connecting wire has minimum AWG14 wire gauge to carry the current.

A5. AUTO ANTENNA OUTPUT +12V

The voltage state on this output pin is a direct indicator of whether this unit is powered on or off. It can be used to control ancillary equipment such as an automatic electric antenna or an audio power amplifier. When connected properly such ancillary equipment will power on and off automatically in sync with the radio.

A7. ACCESSORY (ACC) or IGNITION +12V (key position)

Normally connects to the ignition or accessory circuit. By sensing the voltage on this pin, the unit is able to automatically power on and off when the ignition key switch is turned on or off.

A8. CHASSIS GROUND (EARTH)

All electrical current from this pin is combined to complete the power supply circuit. Ensure the connecting wire has minimum AWG14 wire gauge to carry the current. The metal enclosure of this unit is grounded to this pin. The unit is only suitable for "negative earth" vehicles.

PINS A4 and A7 B+ (BATT) and ACC (IGNITION) CAN BE SWAPPED BY CHANGING THE POSITION OF THE FUSE - SEE DIAGRAM BELOW

Connector B pins (loudspeakers pins):

- B1. REAR RIGHT (+)
- B2. REAR RIGHT (-)
- B3. FRONT RIGHT (+)
- B4. FRONT RIGHT (-)
- B5. FRONT LEFT (+)
- B6. FRONT LEFT (-)
- B7. REAR LEFT (+)
- B8. REAR LEFT (-)

IMPORTANT NOTE: Always replace the fuse with the same type and rating. A blown fuse usually indicates a problem in the circuit. Do not rely completely on replacing the fuse to fix a problem. An over-rated fuse will compromise protection against over-current. Under-rated fuses can blow even if a fault condition does not exist.

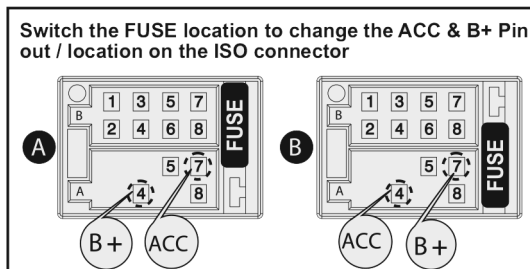

Mounting Notes

Fitting the Radio

Fit the mounting cage (sleeve) into the vehicles' ISO / DIN slot and bend the fixing tangs to lock it in place.

Connect the wiring to the rear of the radio.

Slide the radio into the cage until it "clicks" into place on the locking clips.

Fit the bezel (trim ring) on the front of the radio.

Check correct operation of the radio.

Removing the Radio

Slide the Release Keys centrally along the two sides of the radio to release the locking clips.

Slide the radio out, keeping the Release Keys in place.

Once the radio is out disconnect all the wiring and remove the radio completely.

If necessary bend the fixing tangs inward to remove the mounting cage as well.

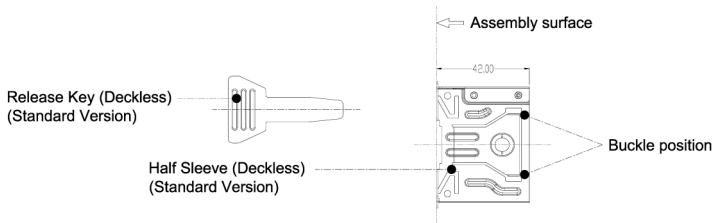

Fitting the External Microphone

The Bluetooth radio models may be supplied with an external microphone this will be either a panel mounted unit with a M8 stud or a visor clip.

Panel mounted M8 stud:

Find a suitable location as close to the front of the user as possible (30 to 45cm).

Drill a 8.5 to 9mm hole for the mounting stud, run the cable through this and route it to the radio.

Fit the star washer and the M8 nut to hold the microphone in place.



Visor mounted:

Find a suitable location as close to the front of the user as possible (30 to 45cm).

Clip, or use an adhesive pad to mount the microphone, and route the cable to the rear of the radio.



When routing the cable back to the radio be careful of sharp edges and pinch points that may damage the cable.

Make sure the cable and microphone do not interfere with any control operation or compromise the drivers view.

Technical

TUNER (FM)

Frequency range	See World Bands below
Channel step	See World Bands below
Sensitivity	<= 10 dB μ V
Stereo separation	>= 30 dB
SNR	>= 50 dB
Auto Stop Sens. LOC on	38 dB μ V +/- 6dB (LO)
Auto Stop Sens. LOC off	18 dB μ V +/- 6dB (DX)

TUNER (DAB/DAB+)

Frequency range	VHF Band III 174.928 - 239.200MHz
Sensitivity	<= 12 dB μ V
SNR	>= 65 dB
Scan Sensitivity	<= 12 dB μ V

MEDIA (USB, CD)

Stereo separation	>= 50 dB
SNR	>= 65 dB
Media Codecs	WAV, FLAC, MP3, WMA

TUNER (AM)

Frequency range	See World Bands below
Channel step	See World Bands below
Sensitivity	<= 40 dB μ V
SNR	>= 40 dB
Auto Stop Sens. LOC on	55 dB μ V +/- 6dB (LO)
Auto Stop Sens. LOC off	33 dB μ V +/- 6dB (DX)

AUDIO

Audio Power	40W max. / Channel, 4 Ohms @ 10% THD
Speaker Impedance	4 to 8 Ohm
Line Output Level	1.7V nominal
Line Output SNR	>= 70 dB

GENERAL

Power Supply	12V DC (9 to 18V)
Fuse Rating	15A
Permanent Memory	EEPROM
Mounting	DIN / ISO Cage

World Bands	FM Frequency [MHz]			AM MW Frequency [kHz]			AM LW Frequency [kHz]		
	Start	End	Step [kHz]	Start	End	Step [kHz]	Start	End	Step [kHz]
EUROPE	87.5	108.0	50	526.5	1606.5	9	148.5	283.5	1
USA	87.5	107.9	200	530	1710	10	---	---	---
LATIN	87.5	108.0	100	530	1710	10	---	---	---
M-EAST	87.5	108.0	100	522	1620	9	144	288	1
AUST-LIA	87.5	108.0	100	522	1710	9	144	288	1
ASIA	87.5	108.0	100	522	1620	9	144	288	1
JAPAN	76.0	90.0	100	522	1629	9	---	---	---
RUSSIA	87.5	108.0	50	522	1620	9	144	288	1
RUSSIA (FM3)	65.0	74.0	10	522	1620	9	144	288	1

FCC Statement

- This device complies with Part 15 of the FCC Rules. Operation is subject to the following two conditions:
 - This device may not cause harmful interference, and
 - This device must accept any interference received, including interference that may cause undesired operation.
- Any changes or modifications not expressly approved by the party responsible for compliance could void the user's authority to operate the equipment.

NOTE: This equipment has been tested and found to comply with the limits for a Class B digital device, pursuant to Part 15 of the FCC Rules. These limits are designed to provide reasonable protection against harmful interference in a residential installation.

This equipment generates uses and can radiate radio frequency energy and, if not installed and used in accordance with the instructions, may cause harmful interference to radio communications. However, there is no guarantee that interference will not occur in a particular installation. If this equipment does cause harmful interference to radio or television reception, which can be determined by turning the equipment off and on, the user is encouraged to try to correct the interference by one or more of the following measures:
Reorient or relocate the receiving antenna.

Increase the separation between the equipment and receiver.

Connect the equipment into an outlet on a circuit different from that to which the receiver is connected.

Consult the dealer or an experienced radio/TV technician for help.

FCC/ IC Radiation Exposure Statement

This equipment complies with FCC and IC radiation exposure limits set forth for an uncontrolled environment. This equipment should be installed and operated with minimum distance 20cm between the radiator & your body.

FCC/ IC Déclaration d'exposition aux rayonnements

Cet appareil est conforme à FCC et IC l'exposition aux rayonnements limites fixées pour un environnement non contrôlé. Cet appareil doit être installé et utilisé avec une distance minimale de 20 cm entre le radiateur et votre corps. Cet transmetteur ne doit pas être co-situé ou opérant en liaison avec toute autre antenne ou transmetteur.

This device contains licence-exempt transmitter(s)/receiver(s) that comply with Innovation, Science and Economic Development Canada's licence-exempt RSS(s).

- This device may not cause interference; and
- This device must accept any interference, including interference that may cause undesired operation of the device.

Cet appareil contient des émetteurs / récepteurs exempts de licence conformes aux RSS (RSS) d'Innovation, Sciences et Développement économique Canada.

- l'appareil ne doit pas produire de brouillage, et
- l'utilisateur de l'appareil doit accepter tout brouillage radioélectrique subi, même si le brouillage est susceptible d'en compromettre le fonctionnement.*

Bluetooth Models

Bluetooth Frequency : 2.402 - 2.480 GHz
Output Power(Max.) : Less than 20dBm

**Instructions on Disposal and Environmental Protection**

Do not dispose of this product in the usual household garbage at the end of its lifecycle; hand it over at a collection point for the recycling of electrical and electronic appliances. The symbol on the product, the instructions for use or the packing will inform about the methods for disposal.

The materials are recyclable as mentioned in this marking. By recycling, material recycling or other forms of re-utilization of old appliances, you are making an important contribution to protecting our environment.

█ Please inquire at the community administration for the authorized disposal location.