

FCC TEST REPORT (PART 22)

Product: LTE Smartphone
Model No.: Smart-Ex 01
FCC ID: XAM500055GR04
Applicant: ecom instruments GmbH
Address: Industriestraße. 2, 97959 Assamstadt, Germany
Manufacturer: ecom instruments GmbH
Address: Industriestraße. 2, 97959 Assamstadt, Germany
Prepared by: Bureau Veritas Shenzhen Co., Ltd. Dongguan Branch
Lab Location: No. 34, Chenwulu Section, Guantai Rd., Houjie Town, Dongguan City, Guangdong 523942, China
TEL: +86 769 8593 5656
FAX: +86 769 8593 1080
E-MAIL: customerservice.dg@cn.bureauveritas.com
Report No.: RF141006N005-3
Received Date: Oct. 06, 2014
Test Date: Oct. 06, 2014 ~ Nov. 11, 2014
Issued Date: Nov. 13, 2014

This report should not be used by the client to claim product certification, approval, or endorsement by A2LA or any government agencies.

This report is for your exclusive use. Any copying or replication of this report to or for any other person or entity, or use of our name or trademark, is permitted only with our prior written permission. This report sets forth our findings solely with respect to the test samples identified herein. The results set forth in this report are not indicative or representative of the quality or characteristics of the lot from which a test sample was taken or any similar or identical product unless specifically and expressly noted. Our report includes all of the tests requested by you and the results thereof based upon the information that you provided to us. You have 60 days from date of issuance of this report to notify us of any material error or omission caused by our negligence, provided, however, that such notice shall be in writing and shall specifically address the issue you wish to raise. A failure to raise such issue within the prescribed time shall constitute your unqualified acceptance of the completeness of this report, the tests conducted and the correctness of the report contents. Unless specific mention, the uncertainty of measurement has been explicitly taken into account to declare the compliance or non-compliance to the specification.



TABLE OF CONTENTS

RELEASE CONTROL RECORD	4
1 CERTIFICATION	5
2 SUMMARY OF TEST RESULTS	6
2.1 MEASUREMENT UNCERTAINTY.....	6
2.2 TEST SITE AND INSTRUMENTS	7
3 GENERAL INFORMATION.....	8
3.1 GENERAL DESCRIPTION OF EUT	8
3.2 CONFIGURATION OF SYSTEM UNDER TEST	10
3.3 DESCRIPTION OF SUPPORT UNITS	11
3.4 TEST ITEM AND TEST CONFIGURATION.....	11
3.5 EUT OPERATING CONDITIONS	14
3.6 GENERAL DESCRIPTION OF APPLIED STANDARDS	14
4 TEST TYPES AND RESULTS	15
4.1 OUTPUT POWER MEASUREMENT	15
4.1.1 LIMITS OF OUTPUT POWER MEASUREMENT	15
4.1.2 TEST PROCEDURES	15
4.1.3 TEST SETUP.....	16
4.1.4 TEST RESULTS	17
4.2 FREQUENCY STABILITY MEASUREMENT	24
4.2.1 LIMITS OF FREQUENCY STABILITY MEASUREMENT	24
4.2.2 TEST PROCEDURE	24
4.2.3 TEST SETUP.....	24
4.2.4 TEST RESULTS	25
4.3 OCCUPIED BANDWIDTH MEASUREMENT	26
4.3.1 TEST PROCEDURES	26
4.3.2 TEST SETUP.....	26
4.3.3 TEST RESULTS	27
4.4 BAND EDGE MEASUREMENT.....	33
4.4.1 LIMITS OF BAND EDGE MEASUREMENT.....	33
4.4.2 TEST SETUP.....	33
4.4.3 TEST PROCEDURES	33
4.4.4 TEST RESULTS	35
4.5 CONDUCTED SPURIOUS EMISSIONS	40
4.5.1 LIMITS OF CONDUCTED SPURIOUS EMISSIONS MEASUREMENT.....	40
4.5.2 TEST PROCEDURE	40
4.5.3 TEST SETUP.....	40
4.5.4 TEST RESULTS	41
4.6 RADIATED EMISSION MEASUREMENT	45
4.6.1 LIMITS OF RADIATED EMISSION MEASUREMENT	45
4.6.2 TEST PROCEDURES	45
4.6.3 DEVIATION FROM TEST STANDARD	45
4.6.4 TEST SETUP.....	46
4.6.5 TEST RESULTS	47
5 PHOTOGRAPHS OF THE TEST CONFIGURATION	54



Test Report No.: RF141006N005-3

6	INFORMATION ON THE TESTING LABORATORIES	55
7	APPENDIX A – MODIFICATIONS RECORDERS FOR ENGINEERING CHANGES TO THE EUT BY THE LAB	56



Test Report No.: RF141006N005-3

RELEASE CONTROL RECORD

ISSUE NO.	REASON FOR CHANGE	DATE ISSUED
RF141006N005-3	Original release	Nov. 13, 2014





Test Report No.: RF141006N005-3

1 CERTIFICATION

PRODUCT: LTE Smartphone
BRAND: ecom MOBILE SAFETY
MODEL NO.: Smart-Ex 01
APPLICANT: ecom instruments GmbH
TESTED: Oct. 06, 2014 ~ Nov. 11, 2014
TEST SAMPLE: Identical Prototype
STANDARDS: FCC PART 22, Subpart H

The above equipment has been tested by **Bureau Veritas Shenzhen Co., Ltd. Dongguan Branch**, and found compliance with the requirement of the above standards. The test record, data evaluation & Equipment Under Test (EUT) configurations represented herein are true and accurate accounts of the measurements of the sample's EMC characteristics under the conditions specified in this report.

TESTED BY :  **DATE** : Nov. 13, 2014
Glyn He/ Project Engineer

APPROVED BY :  **DATE** : Nov. 13, 2014
Sam Tung / Technical Manager

2 SUMMARY OF TEST RESULTS

The EUT has been tested according to the following specifications:

APPLIED STANDARD: FCC Part 22 & Part 2			
STANDARD SECTION	1.1.1.1.1 TEST TYPE	RESULT	REMARK
2.1046 22.913 (a)	Effective Radiated Power	PASS	Meet the requirement of limit.
2.1055 22.355	Frequency Stability	PASS	Meet the requirement of limit.
2.1049	Occupied Bandwidth	PASS	Meet the requirement of limit.
22.917	Band Edge Measurements	PASS	Meet the requirement of limit.
2.1051 22.917	Conducted Spurious Emissions	PASS	Meet the requirement of limit.
2.1053 22.917	Radiated Spurious Emissions	PASS	Meet the requirement of limit. Minimum passing margin is -20.49dB at 2509MHz.

2.1 MEASUREMENT UNCERTAINTY

Where relevant, the following measurement uncertainty levels have been estimated for tests performed on the EUT as specified in CISPR 16-4-2:

MEASUREMENT	FREQUENCY	UNCERTAINTY
Conducted emissions	9kHz~30MHz	2.66dB
Radiated emissions	9KHz ~ 30MHz	2.74dB
	30MHz ~ 1GHz	3.55dB
	1GHz ~ 18GHz	4.84dB
	18GHz ~ 40GHz	1.94dB

This uncertainty represents an expanded uncertainty expressed at approximately the 95% confidence level using a coverage factor of k=2.

2.2 TEST SITE AND INSTRUMENTS

Equipment	Manufacturer	Model No.	Serial No.	Last Cal.	Next Cal.
Spectrum Analyzer	Agilent	E7405A	MY45118807	May 13,14	May 12,15
Spectrum Analyzer (10Hz-40GHz)	Rohde&Schwarz	FSV40	101003	Apr. 09,14	Apr. 08,15
Signal Analyzer	Rohde&Schwarz	FSV7	102331	Nov. 25,13	Nov. 24,14
EMI Test Receiver	Rohde&Schwarz	ESU 26	100005	May 13,14	May 12,15
Loop antenna (9kHz~30MHz)	Daze	ZN30900A	0708	Dec. 05,13	Dec. 05,14
Bilog Antenna	Teseq	CBL 6111D	27089	Jun. 27, 14	Jun. 26, 15
Horn Antenna (1GHz -18GHz)	ETS -Lindgren	3117	00062558	May 30,14	May 29,16
Horn Antenna (15GHz-40GHz)	SCHWARZBECK	BBHA 9170	BBHA9170242	Feb. 13,14	Feb. 12,17
Signal Amplifier	Agilent	8447D	2944A10488	Jun. 25,14	Jun. 24,15
Pre-Amplifier (100MHz-26.5GHz)	Agilent	8449B	3008A00409	May 13,14	May 12,15
Pre-Amplifier (18GHz-40GHz)	EMCI	EMC 184045	980102	Nov. 03,14	Nov. 02,15
Digital Multimeter	FLUKE	15B	A1220010DG	Oct. 29, 14	Oct. 28, 15
Peak and Avg Power Sensor	Anritsu	MA2411B	1126068	Feb. 21,14	Feb. 20,15
Power Meter	Anritsu	ML2495A	1139001	Feb. 21,14	Feb. 20,15
3m Semi-anechoic Chamber	ETS-LINDGREN	9m*6m*6m	NSEMC003	Apr. 19,14	Apr. 18,15
Humid & Temp Programmable Tester	Haida	HD-2257	110807201	Sep.04,14	Sep. 03,15
Signal Generator	Agilent	N5183A	MY50140980	Nov. 03,14	Nov. 02,15
ESG Vector Signal Generator	Agilent	E4438C	MY49072505	Mar.14, 14	Mar.13, 15
Test Software	ADT	ADT_Radiated _V7.6.15.9.2	N/A	N/A	N/A
BLUETOOTH TESTER	Rohde&Schwarz	CBT32	100811	Sep. 04,14	Sep. 03,15

- NOTE:**
1. The calibration interval of the above test instruments is 12 months or 24 months and the calibrations are traceable to CEPREI/CHINA, GRGT/CHINA and NIM/CHINA.
 2. The test was performed in Dongguan 966 Chamber
 3. The horn antenna are used only for the measurement of emission frequency above 1GHz if tested.
 4. The FCC Site Registration No. is 502831.

3 GENERAL INFORMATION

3.1 GENERAL DESCRIPTION OF EUT

EUT	LTE Smartphone	
MODEL NO.	Smart-Ex 01	
TYPE NUMBER	L12V012BB, L12V012AB, L13V012AB	
POWER SUPPLY	5.0Vdc (adapter or host equipment) 3.7Vdc (battery)	
MODULATION TYPE	GSM/GPRS	GMSK
	EDGE	GMSK, 8PSK
	WCDMA	BPSK
	LTE	QPSK, 16QAM
FREQUENCY RANGE	GSM/GPRS/EDGE	824.2MHz ~ 848.8MHz
	WCDMA	826.4MHz ~ 846.6MHz
	LTE Band 5 (Channel Bandwidth: 1.4MHz)	824.7MHz ~ 848.3MHz
	LTE Band 5 (Channel Bandwidth: 3MHz)	825.5MHz ~ 847.5MHz
	LTE Band 5 (Channel Bandwidth: 5MHz)	826.5MHz ~ 846.5MHz
	LTE Band 5 (Channel Bandwidth: 10MHz)	829MHz ~ 844MHz
MAX. ERP POWER	GSM	693mW
	EDGE	452mW
	WCDMA	306mW
	LTE Band 5 (Channel Bandwidth: 1.4MHz)	184mW
	LTE Band 5 (Channel Bandwidth: 3MHz)	188mW
	LTE Band 5 (Channel Bandwidth: 5MHz)	198mW
	LTE Band 5 (Channel Bandwidth: 10MHz)	200mW
EMISSION DESIGNATOR	GSM	245KGXW
	EDGE	243KG7W
	WCDMA	4M16F9W
	LTE Band 5 (Channel Bandwidth: 1.4MHz)	1M09W7D
	LTE Band 5 (Channel Bandwidth: 3MHz)	2M69W7D
	LTE Band 5 (Channel Bandwidth: 5MHz)	4M47W7D

	LTE Band 5 (Channel Bandwidth: 10MHz)	8M97W7D
ANTENNA TYPE	Fixed Internal antenna with 1dBi gain	
HW VERSION	A	
SW VERSION	7A.1.0-01-4.4.2-16.02.11	
I/O PORTS	Refer to user's manual	
DATA CABLE	See note 3	

NOTE:

- For a more detailed features description, please refer to the manufacturer's specifications or the user's manual.
- The EUT was powered by the following adapter:

ADAPTER	
BRAND:	Sonim
MODEL:	S11C02
INPUT:	AC 100-240V, 450mA
OUTPUT:	DC 5V, 2100mA

- The EUT matched the following USB cable:

USB CABLE	
BRAND:	ecom MOBILE SAFETY
MODEL:	Safety Box SB S01
SIGNAL LINE:	1.1 METER

- For the test results, the EUT had been tested with all conditions. But only the worst case was shown in test report.

3.2 CONFIGURATION OF SYSTEM UNDER TEST

FOR RADIATION EMISSION TEST

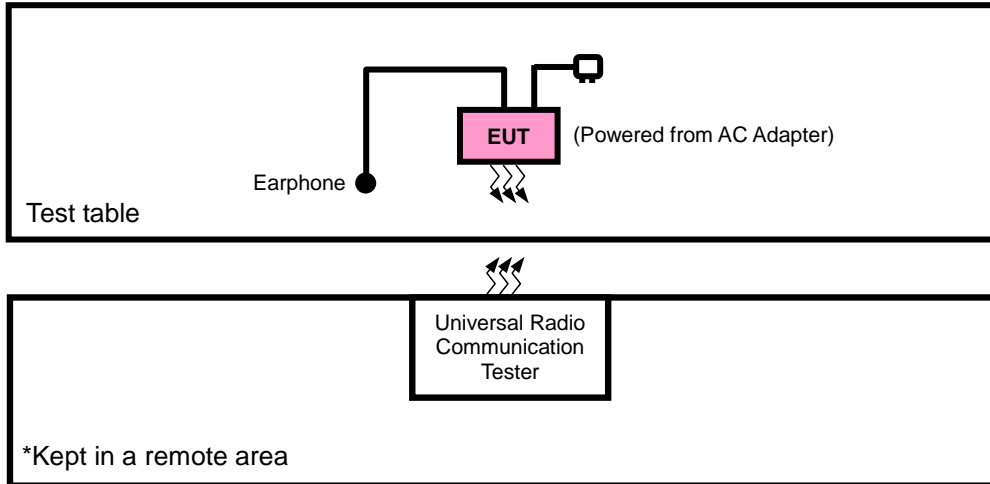

FOR E.R.P. TEST

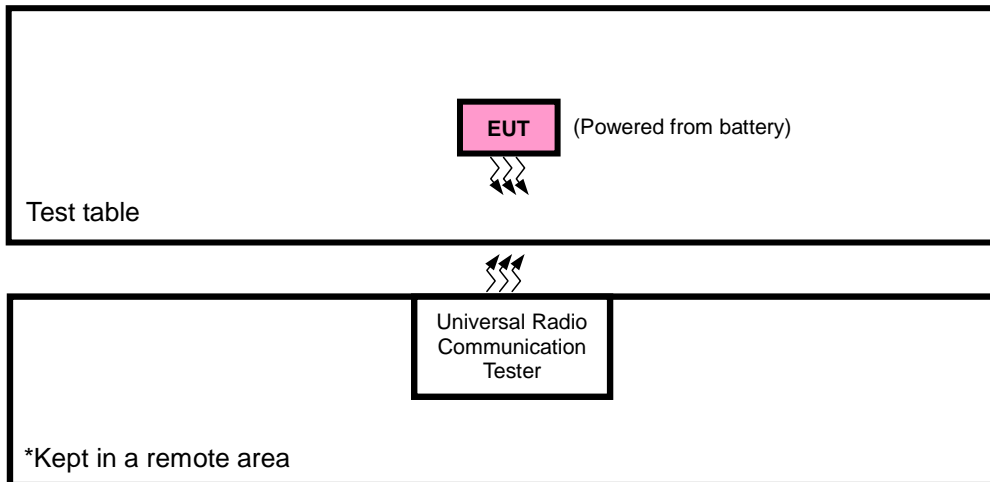

3.3 DESCRIPTION OF SUPPORT UNITS

The EUT has been tested as an independent unit together with other necessary accessories or support units. The following support units or accessories were used to form a representative test configuration during the tests.

NO.	PRODUCT	BRAND	MODEL NO.	SERIAL NO.	FCC ID
1	DC source	LONG WEI	PS-6403D	010934269	N/A
2	PC	HP	A6608CN	3CR83825X3	N/A
3	Earphone	Minami	ME-816B5-E	N/A	N/A

NO.	SIGNAL CABLE DESCRIPTION OF THE ABOVE SUPPORT UNITS
1	DC Line: Unshielded, Detachable 1.0m
2	AC Line: Unshielded, Detachable 1.5m
3	DC Line: Unshielded, Detachable 1.2m

NOTE:

1. All power cords of the above support units are non shielded (1.8m).

3.4 TEST ITEM AND TEST CONFIGURATION

Pre-Scan has been conducted to determine the worst-case mode from all possible combinations between available modulations, data rates, XYZ axis and antenna ports. The worst case was found when positioned on Y-plane for ERP and X-axis for radiated emission. Following channel(s) was (were) selected for the final test as listed below:

EUT CONFIGURE MODE	DESCRIPTION
A	EUT + Adapter + Earphone with GSM ,WCDMA or LTE link
B	EUT + Battery + Earphone with GSM ,WCDMA or LTE link

GSM MODE

EUT CONFIGURE MODE	TEST ITEM	AVAILABLE CHANNEL	TESTED CHANNEL	MODE
B	ERP	128 to 251	128, 190, 251	GSM, EDGE
B	FREQUENCY STABILITY	128 to 251	190	GSM, EDGE
B	OCCUPIED BANDWIDTH	128 to 251	128, 190, 251	GSM, GPRS, EDGE
B	BAND EDGE	128 to 251	128, 251	GSM, GPRS, EDGE
B	CONDCUDED EMISSION	128 to 251	128, 190, 251	GSM
A	RADIATED EMISSION	128 to 251	190	GSM, EDGE

WCDMA MODE

EUT CONFIGURE MODE	TEST ITEM	AVAILABLE CHANNEL	TESTED CHANNEL	MODE
B	ERP	4132 to 4233	4132, 4182, 4233	WCDMA
B	FREQUENCY STABILITY	4132 to 4233	4182	WCDMA
B	OCCUPIED BANDWIDTH	4132 to 4233	4132, 4182, 4233	WCDMA
B	BAND EDGE	4132 to 4233	4132, 4233	WCDMA
B	CONDCUDED EMISSION	4132 to 4233	4132, 4182, 4233	WCDMA
A	RADIATED EMISSION	4132 to 4233	4182	WCDMA

LTE BAND 5 MODE

TEST ITEM	Available Channel	Tested Channel	Channel bandwidth	modulation	mode
ERP	20407 to 20643	20407, 20525, 20643	1.4MHz	QPSK,16QAM	1 RB / 0 RB Offset
	20415 to 20635	20415, 20525, 20635	3MHz	QPSK,16QAM	1 RB / 0 RB Offset
	20425 to 20625	20425, 20525, 20625	5MHz	QPSK,16QAM	1 RB / 0 RB Offset
	20450 to 20600	20450, 20525, 20600	10MHz	QPSK,16QAM	1 RB / 0 RB Offset
FREQUENCY STABILITY	20407 to 20643	20525	1.4MHz	QPSK	1 RB / 0 RB Offset
	20415 to 20635	20525	3MHz	QPSK	1 RB / 0 RB Offset
	20425 to 20625	20525	5MHz	QPSK	1 RB / 0 RB Offset
	20450 to 20600	20525	10MHz	QPSK	1 RB / 0 RB Offset
OCCUPIED BANDWIDTH	20407 to 20643	20407, 20525, 20643	1.4MHz	QPSK	6 RB / 0 RB Offset
				16QAM	6 RB / 0 RB Offset
	20415 to 20635	20415, 20525, 20635	3MHz	QPSK	15 RB / 0 RB Offset
				16QAM	15 RB / 0 RB Offset
	20425 to 20625	20425, 20525, 20625	5MHz	QPSK	25 RB / 0 RB Offset
				16QAM	25 RB / 0 RB Offset
	20450 to 20600	20450, 20525, 20600	10MHz	QPSK	50 RB / 0 RB Offset
				16QAM	50 RB / 0 RB Offset



Test Report No.: RF141006N005-3

BAND EDGE	20407 to 20643	20407	1.4 MHz	QPSK	1 RB / 0 RB Offset
					6 RB / 0 RB Offset
	20407 to 20643	20643	1.4 MHz	QPSK	1 RB / 5 RB Offset
					6 RB / 0 RB Offset
	20415 to 20635	20415	3 MHz	QPSK	1 RB / 0 RB Offset
					15 RB / 0 RB Offset
	20415 to 20635	20635	3 MHz	QPSK	1 RB / 14 RB Offset
					15 RB / 0 RB Offset
20425 to 20625	20425	5MHz	QPSK	1 RB / 0 RB Offset	
				25 RB / 0 RB Offset	
20425 to 20625	20625	5MHz	QPSK	1 RB / 24 RB Offset	
				25 RB / 0 RB Offset	
20450 to 20600	20450	10MHz	QPSK	1 RB / 0 RB Offset	
				50 RB / 0 RB Offset	
20450 to 20600	20600	10MHz	QPSK	1 RB / 49 RB Offset	
				50 RB / 0 RB Offset	
CONDCUDED EMISSION	20407 to 20643	20525	1.4MHz	QPSK	1 RB / 0 RB Offset
	20415 to 20635	20525	3MHz	QPSK	1 RB / 0 RB Offset
	20425 to 20625	20525	5MHz	QPSK	1 RB / 0 RB Offset
	20450 to 20600	20525	10MHz	QPSK	1 RB / 0 RB Offset
RADIATED EMISSION	20407 to 20643	20525	1.4MHz	QPSK	1 RB / 0 RB Offset
	20415 to 20635	20525	3MHz	QPSK	1 RB / 0 RB Offset
	20425 to 20625	20525	5MHz	QPSK	1 RB / 0 RB Offset
	20450 to 20600	20525	10MHz	QPSK	1 RB / 0 RB Offset

TEST ITEM	ENVIRONMENTAL CONDITIONS	INPUT POWER	TESTED BY
ERP	23deg. C, 62%RH	3.7Vdc from Battery	Yuqiang Yin
FREQUENCY STABILITY	23deg. C, 62%RH	3.7Vdc from Battery	Yuqiang Yin
OCCUPIED BANDWIDTH	23deg. C, 62%RH	3.7Vdc from Battery	Yuqiang Yin
BAND EDGE	23deg. C, 62%RH	3.7Vdc from Battery	Yuqiang Yin
CONDCUDED EMISSION	23deg. C, 62%RH	5Vdc from adapter	Yuqiang Yin
RADIATED EMISSION	25deg. C, 63.6%RH	5Vdc from adapter	Blue Zheng

Bureau Veritas Shenzhen Co., Ltd.
Dongguan Branch

No. 34, Chenwulu Section, Guantai Rd.,
Houjie Town, Dongguan City,
Guangdong 523942, China

Tel: +86 769 8593 5656
Fax: +86 769 8593 1080
Email: customerservice.dg@cn.bureauveritas.com



Test Report No.: RF141006N005-3

3.5 EUT OPERATING CONDITIONS

The EUT makes a call to the communication simulator. The communication simulator station system controlled a EUT to export maximum output power under transmission mode and specific channel frequency

3.6 GENERAL DESCRIPTION OF APPLIED STANDARDS

The EUT is a RF product. According to the specifications of the manufacturer, it must comply with the requirements of the following standards:

FCC 47 CFR Part 2

FCC 47 CFR Part 22

ANSI/TIA/EIA-603-C 2004

NOTE: All test items have been performed and recorded as per the above standards.

4 TEST TYPES AND RESULTS

4.1 OUTPUT POWER MEASUREMENT

4.1.1 LIMITS OF OUTPUT POWER MEASUREMENT

Mobile / Portable station are limited to 7 watts e.r.p.

4.1.2 TEST PROCEDURES

EIRP / ERP MEASUREMENT:

- a. All measurements were done at low, middle and high operational frequency range. RBW and VBW is 1MHz for GSM, GPRS & EDGE, 5MHz for WCDMA mode, and 10MHz for LTE mode.
- b. Substitution method is used for E.I.R.P measurement. In the semi-anechoic chamber, EUT placed on the 0.8m height of Turn Table, rotated the table around 360 degrees to search the maximum radiation power and receiver antenna shall be rotated vertical and horizontal polarization and moved height from 1m to 4m to find the maximum polar radiated power. The "Read Value" is the spectrum reading the maximum power value.
- c. The substitution horn antenna is substituted for EUT at the same position and signals generator export the CW signal to the substitution antenna via a tx cable. Rotated the Turn Table and moved receiving antenna to find the maximum radiation power. Adjust output power level of S.G to get a Value of spectrum reading equal to "Read Value " of step b. Record the power level of S.G
- d. $EIRP = \text{Output power level of S.G} - \text{TX cable loss} + \text{Antenna gain of substitution horn.}$
 $E.R.P \text{ power can be calculated form E.I.R.P power by subtracting the gain of dipole, } E.R.P \text{ power} = E.I.P.R \text{ power} - 2.15\text{dBi.}$

CONDUCTED POWER MEASUREMENT:

The EUT was set up for the maximum power with GSM, GPRS, EDGE & WCDMA link data modulation and link up with simulator. Set the EUT to transmit under low, middle and high channel and record the power level shown on simulator.

4.1.3 TEST SETUP

EIRP / ERP MEASUREMENT:

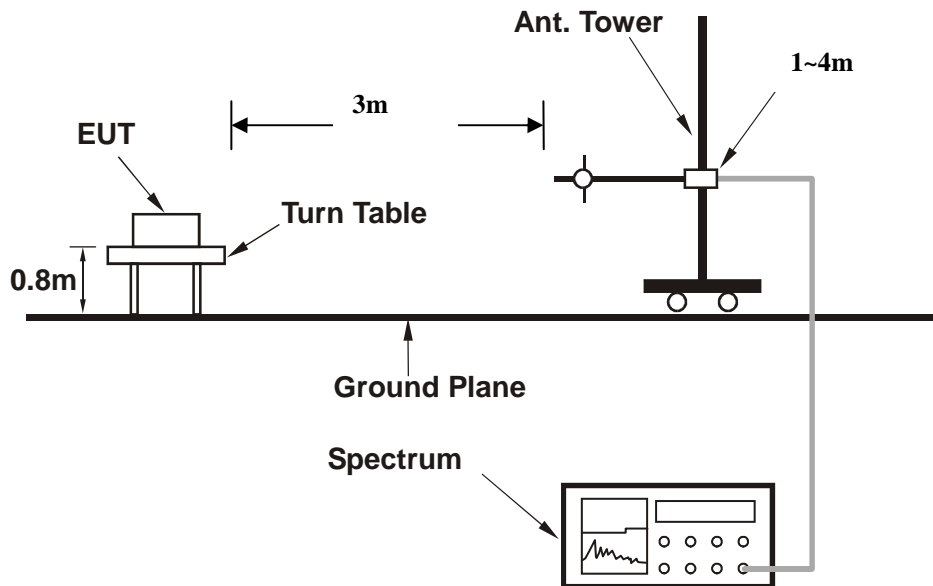

For the actual test configuration, please refer to the attached file (Test Setup Photo).

CONDUCTED POWER MEASUREMENT:

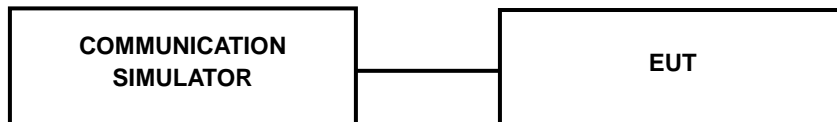

For the actual test configuration, please refer to the attached file (Test Setup Photo).

4.1.4 TEST RESULTS

CONDUCTED OUTPUT POWER (dBm)

Band	GSM850		
Channel	128	190	251
Frequency (MHz)	824.2	836.6	848.8
GSM	31.97	32.06	32.05
GPRS 8	31.95	32.04	32.01
GPRS 10	31.82	31.95	31.55
EDGE 8 (MCS1)	31.94	32.00	31.99
EDGE 10 (MCS1)	31.80	31.90	31.50
EDGE 8 (MCS9)	26.20	26.17	26.14
EDGE 10 (MCS9)	25.67	25.63	25.60

Band	WCDMA V		
Channel	4132	4182	4233
Frequency (MHz)	826.4	836.4	846.6
RMC 12.2K	23.66	23.70	23.59
HSPA			
HSDPA Subtest-1	22.22	22.18	22.19
HSDPA Subtest-2	22.18	22.11	22.20
HSDPA Subtest-3	21.62	21.66	21.67
HSDPA Subtest-4	21.62	21.65	21.69
HSUPA Subtest-1	22.51	22.57	22.55
HSUPA Subtest-2	20.58	20.50	20.59
HSUPA Subtest-3	21.40	21.55	21.34
HSUPA Subtest-4	20.64	20.69	20.63
HSUPA Subtest-5	22.61	22.71	22.70

Band/BW	Modulation	RB Size	RB Offset	Low CH 20407	Mid CH 20525	High CH 20643	3GPP MPR (dB)
				Frequency 824.7 MHz	Frequency 836.5 MHz	Frequency 848.3 MHz	
5/1.4	QPSK	1	0	23.35	23.37	23.36	0
		1	2	23.29	23.35	23.28	0
		1	5	23.27	23.24	23.26	0
		3	0	23.34	23.36	23.35	0
		3	1	23.28	23.34	23.27	0
		3	3	23.26	23.23	23.25	0
		6	0	22.33	22.35	22.34	1
	16QAM	1	0	22.32	22.34	22.33	1
		1	2	22.26	22.32	22.25	1
		1	5	22.24	22.21	22.23	1
		3	0	22.31	22.33	22.32	1
		3	1	22.25	22.31	22.24	1
		3	3	22.23	22.2	22.22	1
		6	0	21.3	21.32	21.31	2

Band/BW	Modulation	RB Size	RB Offset	Low CH 20415	Mid CH 20525	High CH 20635	3GPP MPR (dB)
				Frequency 825.5 MHz	Frequency 836.5 MHz	Frequency 847.5 MHz	
5/3	QPSK	1	0	23.45	23.47	23.46	0
		1	7	23.39	23.45	23.38	0
		1	14	23.37	23.34	23.36	0
		8	0	22.45	22.55	22.48	1
		8	3	22.44	22.45	22.4	1
		8	7	22.36	22.42	22.38	1
		15	0	22.43	22.54	22.41	1
	16QAM	1	0	22.41	22.43	22.42	1
		1	7	22.35	22.41	22.34	1
		1	14	22.33	22.3	22.32	1
		8	0	21.47	21.49	21.48	2
		8	3	21.41	21.47	21.4	2
		8	7	21.39	21.36	21.38	2
		15	0	21.45	21.47	21.46	2

Band/BW	Modulation	RB Size	RB Offset	Low CH 20425	Mid CH 20525	High CH 20625	3GPP MPR (dB)
				Frequency 826.5 MHz	Frequency 836.5 MHz	Frequency 846.5 MHz	
5/5	QPSK	1	0	23.49	23.51	23.5	0
		1	12	23.43	23.49	23.42	0
		1	24	23.41	23.38	23.4	0
		12	0	22.49	22.59	22.52	1
		12	6	22.48	22.49	22.44	1
		12	13	22.4	22.46	22.42	1
		25	0	22.47	22.58	22.45	1
	16QAM	1	0	22.45	22.47	22.46	1
		1	12	22.39	22.45	22.38	1
		1	24	22.37	22.34	22.36	1
		12	0	21.51	21.53	21.52	2
		12	6	21.45	21.51	21.44	2
		12	13	21.43	21.4	21.42	2
		25	0	21.49	21.51	21.5	2

Band/BW	Modulation	RB Size	RB Offset	Low CH 20450	Mid CH 20525	High CH 20600	3GPP MPR (dB)
				Frequency 829 MHz	Frequency 836.5 MHz	Frequency 844 MHz	
5/10	QPSK	1	0	23.51	23.53	23.52	0
		1	24	23.45	23.51	23.44	0
		1	49	23.43	23.4	23.42	0
		25	0	22.51	22.61	22.54	1
		25	12	22.5	22.51	22.46	1
		25	25	22.42	22.48	22.44	1
		50	0	22.49	22.6	22.47	1
	16QAM	1	0	22.47	22.49	22.48	1
		1	24	22.41	22.47	22.4	1
		1	49	22.39	22.36	22.38	1
		25	0	21.53	21.55	21.54	2
		25	12	21.47	21.53	21.46	2
		25	25	21.45	21.42	21.44	2
		50	0	21.51	21.53	21.52	2

ERP POWER (dBm)

GSM

Channel	Frequency (MHz)	LVL (dBm)	Correction Factor(dB)	ERP(dBm)	ERP(mW)	Polarization (H/V)
128	824.2	-6.74	35.85	26.96	496.59	H
189	836.4	-6.53	37.09	28.41	693.43	H
251	848.8	-6.47	36.96	28.34	682.34	H
128	824.2	-10.21	36.88	24.52	283.14	V
189	836.4	-10.14	37.56	25.27	336.51	V
251	848.8	-10.09	37.72	25.48	353.18	V

EDGE

Channel	Frequency (MHz)	LVL (dBm)	Correction Factor(dB)	ERP(dBm)	ERP(mW)	Polarization (H/V)
128	824.2	-8.47	35.85	25.23	333.43	H
189	836.4	-8.39	37.09	26.55	451.86	H
251	848.8	-8.27	36.96	26.54	450.82	H
128	824.2	-12.32	36.88	22.41	174.18	V
189	836.4	-12.24	37.56	23.17	207.49	V
251	848.8	-12.20	37.72	23.37	217.27	V

WCDMA

Channel	Frequency (MHz)	LVL (dBm)	Correction Factor(dB)	ERP(dBm)	ERP(mW)	Polarization (H/V)
4132	826.4	-10.14	35.85	23.56	226.99	H
4182	836.4	-10.08	37.09	24.86	306.20	H
4233	846.6	-10.01	37	24.84	304.79	H
4132	826.4	-15.36	36.85	19.34	85.90	V
4182	836.4	-15.24	37.56	20.17	103.99	V
4233	846.6	-15.09	37.77	20.53	112.98	V

LTE BAND 5

CHANNEL BANDWIDTH: 1.4MHz QPSK

Channel	Frequency (MHz)	LVL (dBm)	Correction Factor(dB)	ERP(dBm)	ERP(mW)	Polarization (H/V)	LIMIT (W)
20407	824.7	-10.64	35.07	22.28	169.04	H	1
20525	836.5	-10.57	35.36	22.64	183.65	H	1
20643	848.3	-10.75	35.21	22.31	170.22	H	1
20407	824.7	-15.87	35.85	17.83	60.67	V	1
20525	836.5	-15.96	35.88	17.77	59.84	V	1
20643	848.3	-15.63	36.11	18.33	68.08	V	1

CHANNEL BANDWIDTH: 1.4MHz 16QAM

Channel	Frequency (MHz)	LVL (dBm)	Correction Factor(dB)	ERP(dBm)	ERP(mW)	Polarization (H/V)	LIMIT (W)
20407	824.7	-11.39	35.07	21.53	142.23	H	1
20525	836.5	-11.25	35.36	21.96	157.04	H	1
20643	848.3	-11.74	35.21	21.32	135.52	H	1
20407	824.7	-19.76	35.85	13.94	24.77	V	1
20525	836.5	-19.87	35.88	13.86	24.32	V	1
20643	848.3	-19.65	36.11	14.31	26.98	V	1

CHANNEL BANDWIDTH: 3MHz QPSK

Channel	Frequency (MHz)	LVL (dBm)	Correction Factor(dB)	ERP(dBm)	ERP(mW)	Polarization (H/V)	LIMIT (W)
20415	825.5	-10.98	35.08	21.95	156.68	H	1
20525	836.5	-10.48	35.36	22.73	187.50	H	1
20635	847.5	-10.34	35.15	22.66	184.50	H	1
20415	825.5	-15.36	35.68	18.17	65.61	V	1
20525	836.5	-15.22	35.88	18.51	70.96	V	1
20635	847.5	-15.74	36.02	18.13	65.01	V	1

CHANNEL BANDWIDTH: 3MHz 16QAM

Channel	Frequency (MHz)	LVL (dBm)	Correction Factor(dB)	ERP(dBm)	ERP(mW)	Polarization (H/V)	LIMIT (W)
20415	825.5	-11.65	35.08	21.28	134.28	H	1
20525	836.5	-11.48	35.36	21.73	148.94	H	1
20635	847.5	-11.05	35.15	21.95	156.68	H	1
20415	825.5	-19.27	35.68	14.26	26.67	V	1
20525	836.5	-19.47	35.88	14.26	26.67	V	1
20635	847.5	-19.57	36.02	14.30	26.92	V	1

CHANNEL BANDWIDTH: 5MHz QPSK

Channel	Frequency (MHz)	LVL (dBm)	Correction Factor(dB)	ERP(dBm)	ERP(mW)	Polarization (H/V)	LIMIT (W)
20425	826.5	-10.65	34.96	22.16	164.44	H	1
20525	836.5	-10.25	35.36	22.96	197.70	H	1
20625	846.5	-10.47	35.18	22.56	180.30	H	1
20425	826.5	-15.22	35.62	18.25	66.83	V	1
20525	836.5	-15.68	35.88	18.05	63.83	V	1
20625	846.5	-15.39	36.02	18.48	70.47	V	1

CHANNEL BANDWIDTH: 5MHz 16QAM

Channel	Frequency (MHz)	LVL (dBm)	Correction Factor(dB)	ERP(dBm)	ERP(mW)	Polarization (H/V)	LIMIT (W)
20425	826.5	-11.68	34.96	21.13	129.72	H	1
20525	836.5	-11.74	35.36	21.47	140.28	H	1
20625	846.5	-11.35	35.18	21.68	147.23	H	1
20425	826.5	-19.97	35.62	13.50	22.39	V	1
20525	836.5	-19.74	35.88	13.99	25.06	V	1
20625	846.5	-19.36	36.02	14.51	28.25	V	1

CHANNEL BANDWIDTH: 10MHz QPSK

Channel	Frequency (MHz)	LVL (dBm)	Correction Factor(dB)	ERP(dBm)	ERP(mW)	Polarization (H/V)	LIMIT (W)
20450	829	-10.47	34.98	22.36	172.19	H	1
20525	836.5	-10.16	35.33	23.02	200.45	H	1
20600	844	-10.26	35.41	23.00	199.53	H	1
20450	829	-15.47	35.86	18.24	66.68	V	1
20525	836.5	-15.30	35.85	18.40	69.18	V	1
20600	844	-15.95	36.19	18.09	64.42	V	1

CHANNEL BANDWIDTH: 10MHz 16QAM

Channel	Frequency (MHz)	LVL (dBm)	Correction Factor(dB)	ERP(dBm)	ERP(mW)	Polarization (H/V)	LIMIT (W)
20450	829	-11.75	34.98	21.08	128.23	H	1
20525	836.5	-11.54	35.33	21.64	145.88	H	1
20600	844	-11.65	35.41	21.61	144.88	H	1
20450	829	-19.47	35.86	14.24	26.55	V	1
20525	836.5	-19.56	35.85	14.14	25.94	V	1
20600	844	-19.86	36.19	14.18	26.18	V	1

REMARKS: 1. ERP Output Power (dBm) = SPA Reading (dBm) + Correction Factor (dB).
2. Correction factor (dB) = Free Space Loss + Antenna Factor + Cable Loss.

4.2 FREQUENCY STABILITY MEASUREMENT

4.2.1 LIMITS OF FREQUENCY STABILITY MEASUREMENT

1.5 ppm is for base and fixed station. 2.5 ppm is for mobile station.

4.2.2 TEST PROCEDURE

- Device is placed at the oven room. The oven room could control the temperatures and humidity. Power warm up is at least 15 min and power applied should perform before recording frequency error.
- EUT is connected the external power supply to control the DC input power. The test voltage range is from minimum to maximum working voltage. Each step shall be record the frequency error rate.
- The temperature range step is 10 degrees in this test items. All temperature levels shall be hold the $\pm 0.5^{\circ}\text{C}$ during the measurement testing. The each temperature step shall be at least 0.5 hours, consider the EUT could be test under the stability condition.

NOTE: The frequency error was recorded frequency error from the communication simulator.

4.2.3 TEST SETUP

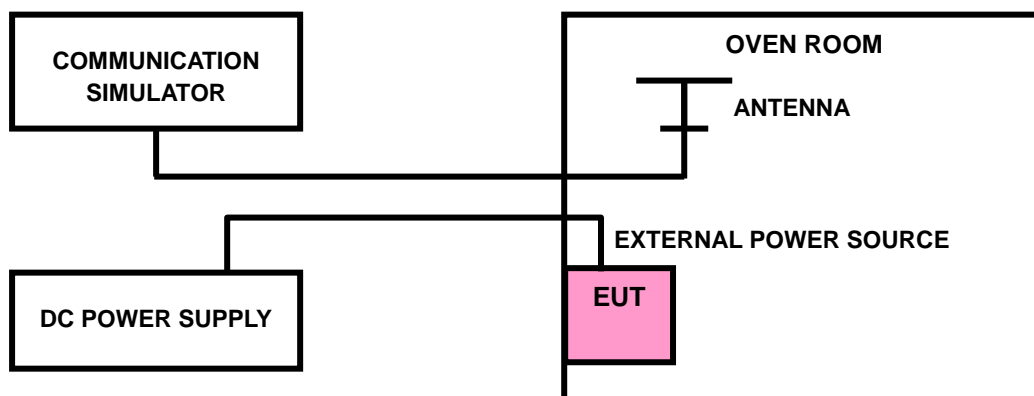

4.2.4 TEST RESULTS

FREQUENCY ERROR VS. VOLTAGE

Voltage (Volts)	Frequency Error (ppm)							Limit (ppm)
	GSM	EDGE	WCDMA	LTE Band 5				
				1.4 MHz	3 MHz	5 MHz	10MHz	
3.8	0.0007	0.0007	0.0008	-0.020	-0.015	-0.015	-0.010	2.5
3.5	-0.0034	-0.0046	-0.0043	-0.018	-0.007	-0.009	-0.007	2.5
4.35	0.0043	0.0051	0.0057	-0.013	-0.008	-0.014	-0.009	2.5

NOTE: The applicant defined the normal working voltage of the battery is from 3.5Vdc to 4.35Vdc.

FREQUENCY ERROR vs. TEMPERATURE.

Voltage (Volts)	Frequency Error (ppm)							Limit (ppm)
	GSM	EDGE	WCDMA	LTE Band 5				
				1.4 MHz	3 MHz	5 MHz	10MHz	
-30	-0.0156	-0.0156	-0.0167	-0.024	-0.019	-0.017	-0.021	2.5
-20	-0.0121	-0.0123	-0.0133	-0.018	-0.017	-0.014	-0.019	2.5
-10	-0.0090	0.0097	-0.0103	-0.016	-0.014	-0.012	-0.017	2.5
0	-0.0075	-0.0088	-0.0081	-0.015	-0.010	-0.007	-0.016	2.5
10	-0.0062	-0.0069	-0.0046	-0.013	-0.009	-0.003	-0.015	2.5
20	-0.0017	0.0040	-0.0015	-0.010	-0.007	-0.003	-0.012	2.5
30	0.0003	-0.0002	0.0019	-0.009	-0.004	0.006	-0.004	2.5
40	0.0041	0.0033	0.0042	0.003	0.005	0.007	0.002	2.5
50	0.0061	0.0070	0.0050	0.006	0.008	0.012	0.006	2.5
60	0.0074	0.0090	0.0073	0.010	0.014	0.016	0.009	2.5

4.3 OCCUPIED BANDWIDTH MEASUREMENT

4.3.1 TEST PROCEDURES

The EUT makes a call to the communication simulator. All measurements were done at low, middle and high operational frequency range. The communication simulator station system controlled a EUT to export maximum output power under transmission mode and specific channel frequency. Use OBW measurement function of Spectrum analyzer to measure 99 % occupied bandwidth.

4.3.2 TEST SETUP

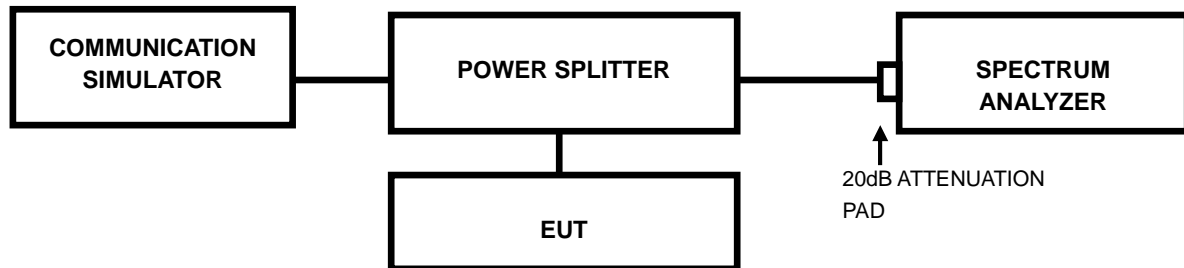

4.3.3 TEST RESULTS

CHANNEL	Frequency (MHz)	99% OCCUPIED Bandwidth (kHz)		CHANNEL	Frequency (MHz)	99% OCCUPIED Bandwidth (MHz)
		GSM	EDGE			WCDMA
128	824.2	244.93	243.48	4132	826.4	4.16
190	836.6	244.93	242.03	4182	836.4	4.14
251	848.8	243.48	243.48	4233	846.6	4.16

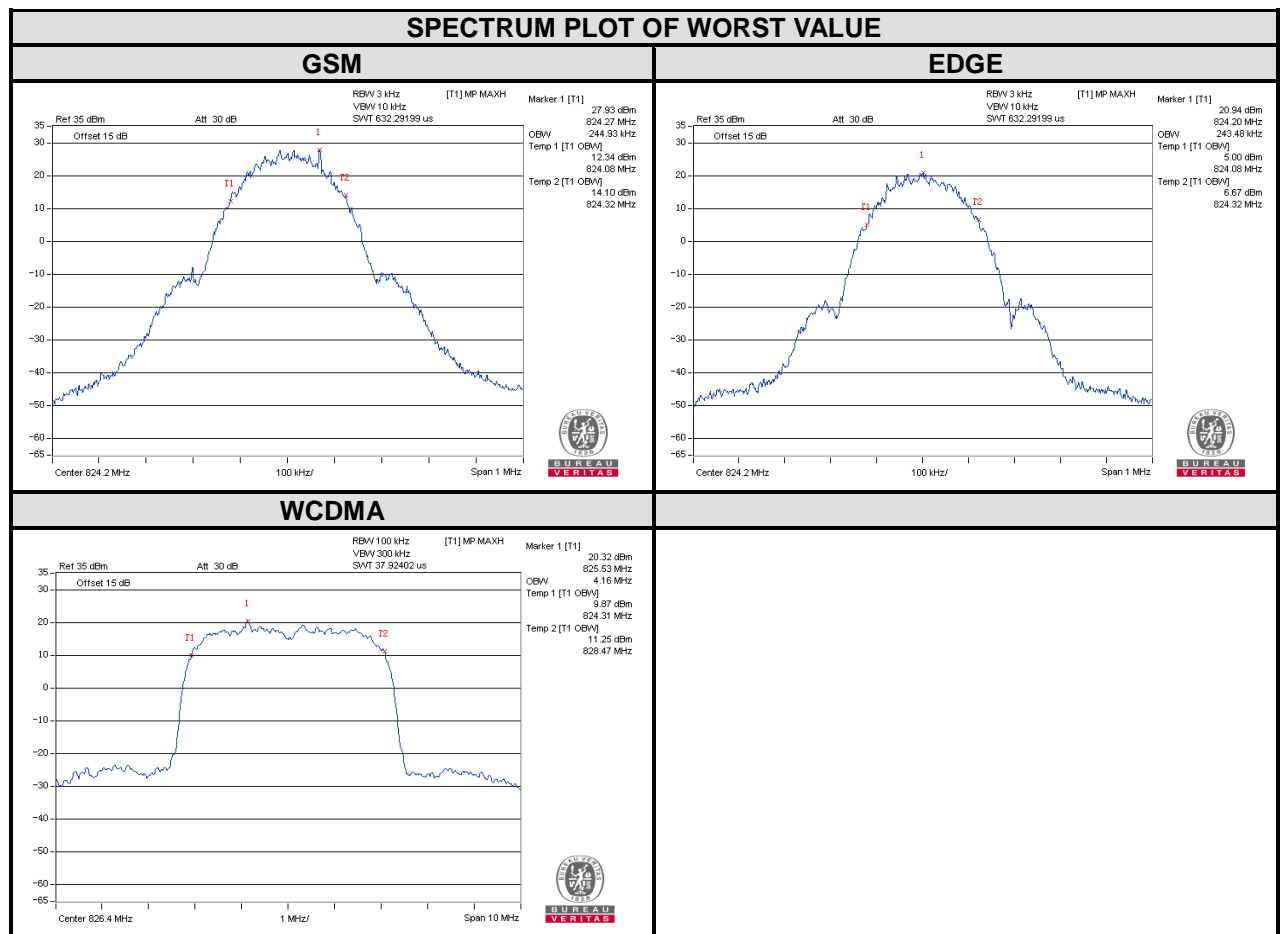



**BUREAU
VERITAS**

Test Report No.: RF141006N005-3

CHANNEL	Frequency (MHz)	26dB Bandwidth (kHz)		CHANNEL	Frequency (MHz)	26dB Bandwidth (MHz)
		GSM	EDGE			
128	824.2	316.43	310.2	4132	826.4	4.66
190	836.6	315.05	314.36	4182	836.4	4.67
251	848.8	315.96	310.43	4233	846.6	4.66

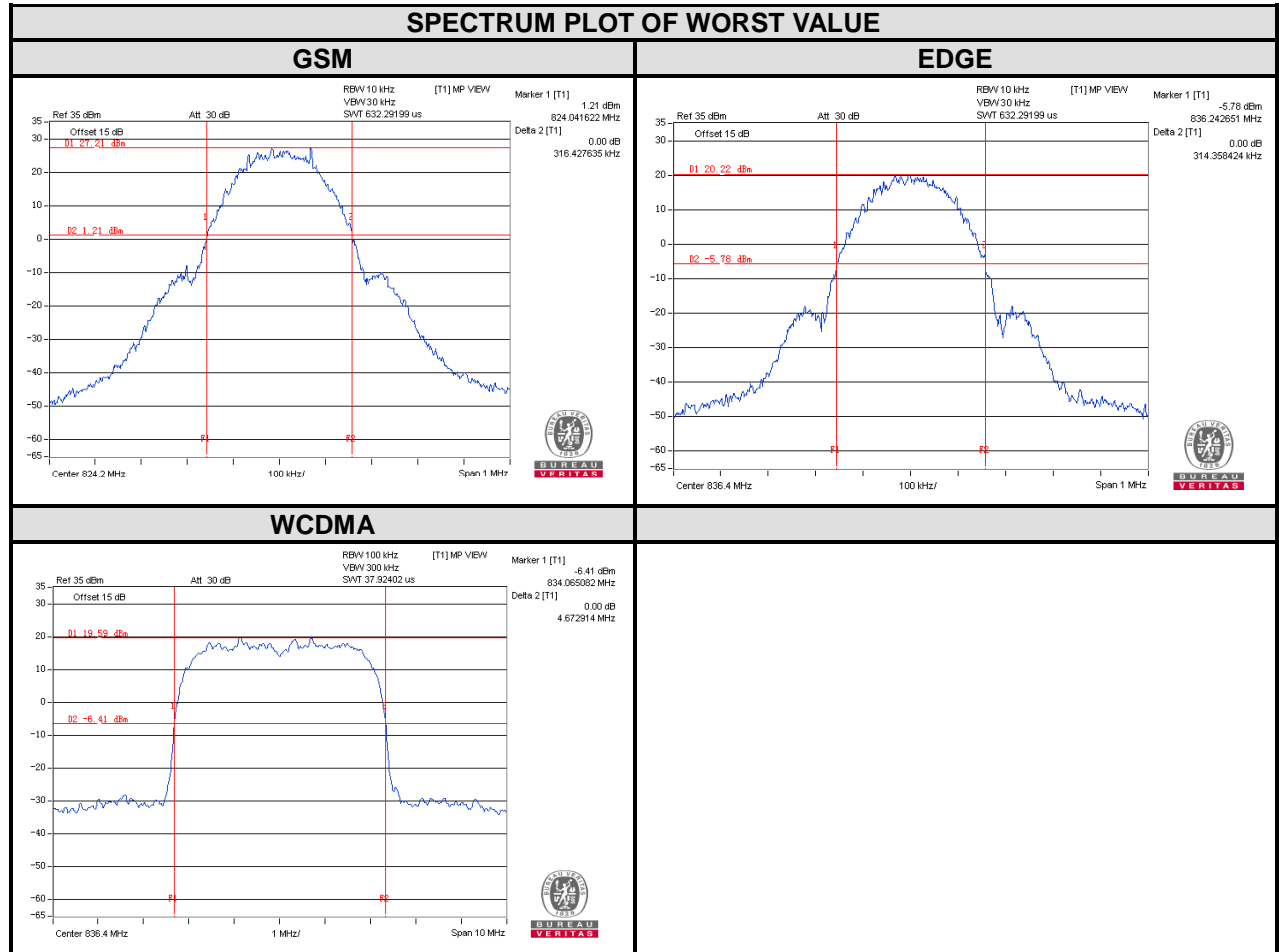

Bureau Veritas Shenzhen Co., Ltd.
Dongguan Branch

No. 34, Chenwulu Section, Guantai Rd.,
Houjie Town, Dongguan City,
Guangdong 523942, China

Tel: +86 769 8593 5656
Fax: +86 769 8593 1080
Email: customerservice.dg@cn.bureauveritas.com



BUREAU
VERITAS

Test Report No.: RF141006N005-3

LTE band 5							
Channel Bandwidth : 1.4MHz							
Channel	Frequency (MHz)	99% Occupied bandwidth (MHz)		Channel	Frequency (MHz)	26 dB bandwidth (MHz)	
		QPSK	16QAM			QPSK	16QAM
20407	824.7	1.09	1.09	20407	824.7	1.26	1.27
20525	836.5	1.09	1.09	20525	836.5	1.27	1.29
20643	848.3	1.09	1.09	20643	848.3	1.27	1.27

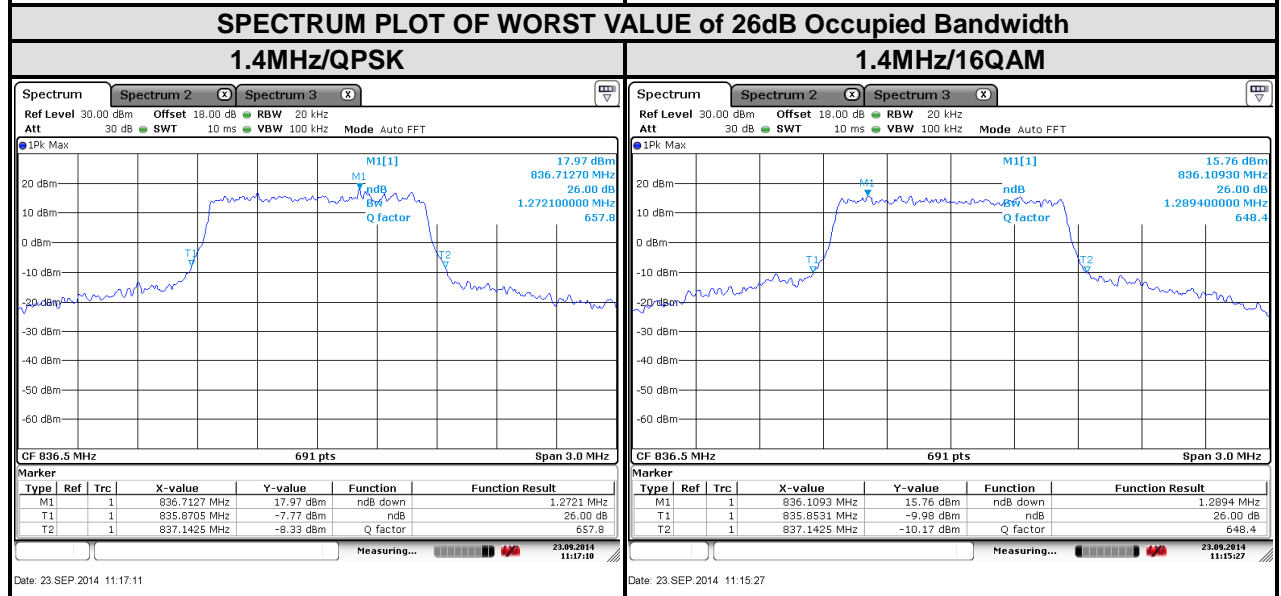
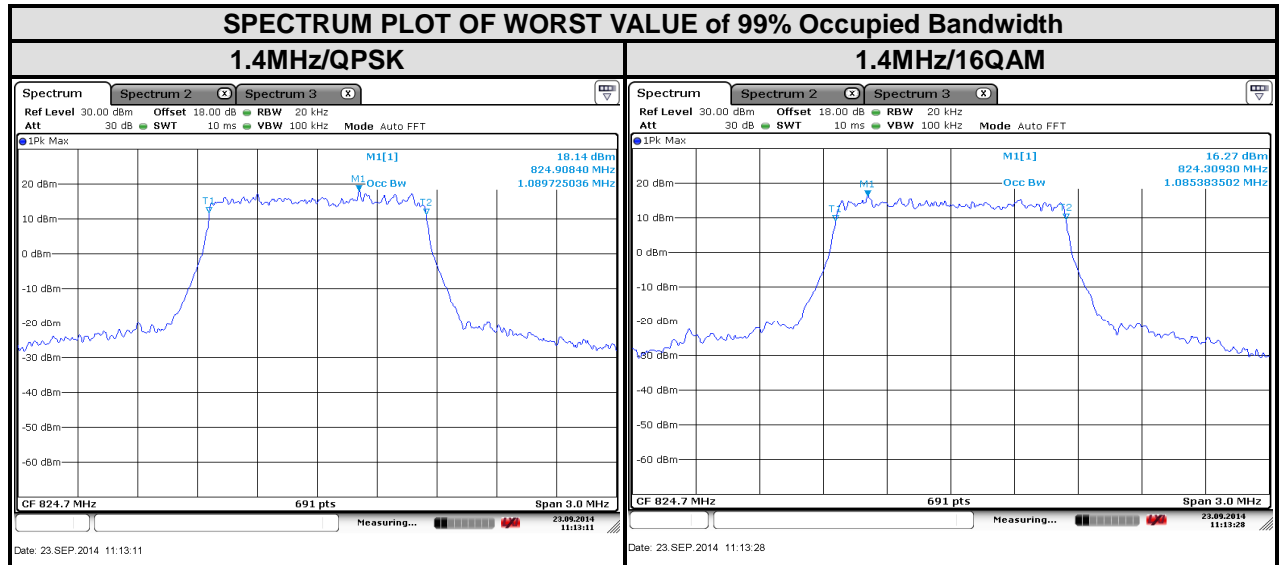

Bureau Veritas Shenzhen Co., Ltd.
Dongguan Branch

No. 34, Chenwulu Section, Guantai Rd.,
Houjie Town, Dongguan City,
Guangdong 523942, China

Tel: +86 769 8593 5656
Fax: +86 769 8593 1080
Email: customerservice.dg@cn.bureauveritas.com



BUREAU
VERITAS

Test Report No.: RF141006N005-3

LTE band 5							
Channel Bandwidth : 3MHz							
Channel	Frequency (MHz)	99% Occupied bandwidth (MHz)		Channel	Frequency (MHz)	26 dB bandwidth (MHz)	
		QPSK	16QAM			QPSK	16QAM
20415	825.5	2.68	2.69	20415	825.5	2.94	2.97
20525	836.5	2.68	2.69	20525	836.5	2.96	2.93
20635	847.5	2.68	2.68	20635	847.5	2.92	2.92

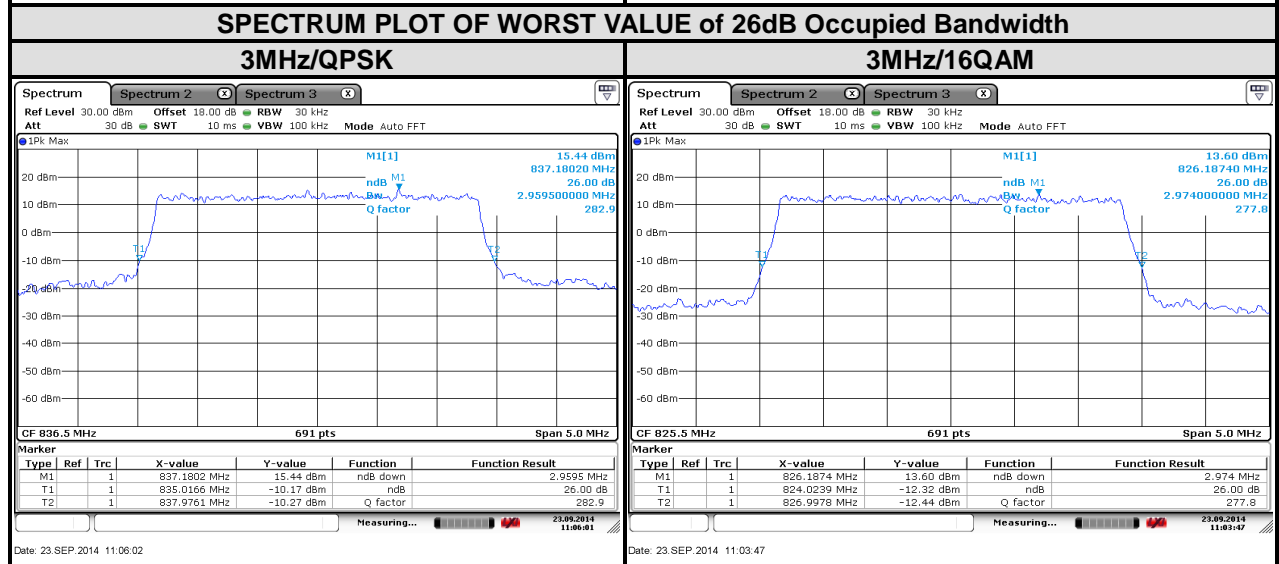
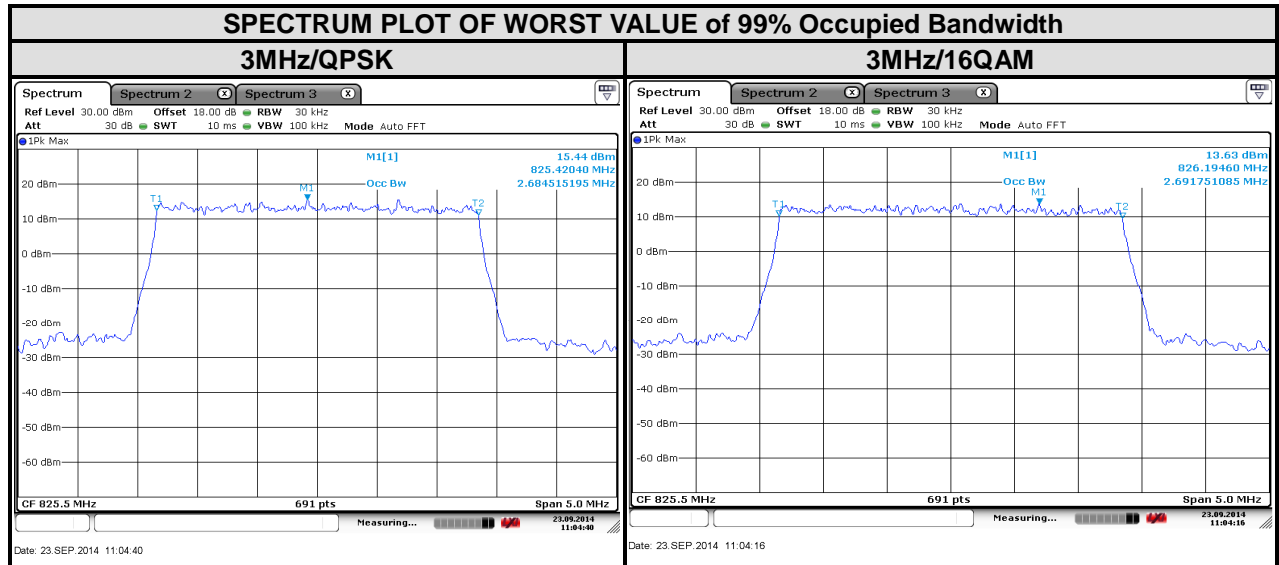

Bureau Veritas Shenzhen Co., Ltd.
Dongguan Branch

No. 34, Chenwulu Section, Guantai Rd.,
Houjie Town, Dongguan City,
Guangdong 523942, China

Tel: +86 769 8593 5656
Fax: +86 769 8593 1080
Email: customerservice.dg@cn.bureauveritas.com



LTE band 5							
Channel Bandwidth : 5 MHz							
Channel	Frequency (MHz)	99% Occupied bandwidth (MHz)		Channel	Frequency (MHz)	26 dB bandwidth (MHz)	
		QPSK	16QAM			QPSK	16QAM
20425	826.5	4.46	4.47	20425	826.5	4.91	4.85
20525	836.5	4.47	4.46	20525	836.5	4.86	4.86
20625	846.5	4.46	4.46	20625	846.5	4.94	4.85

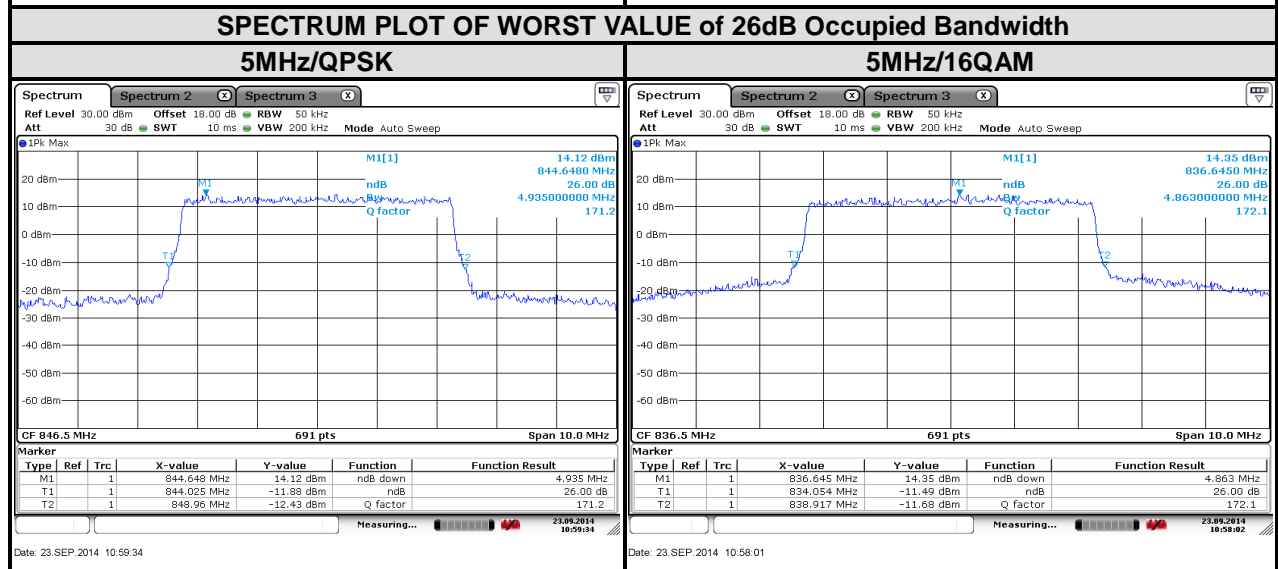
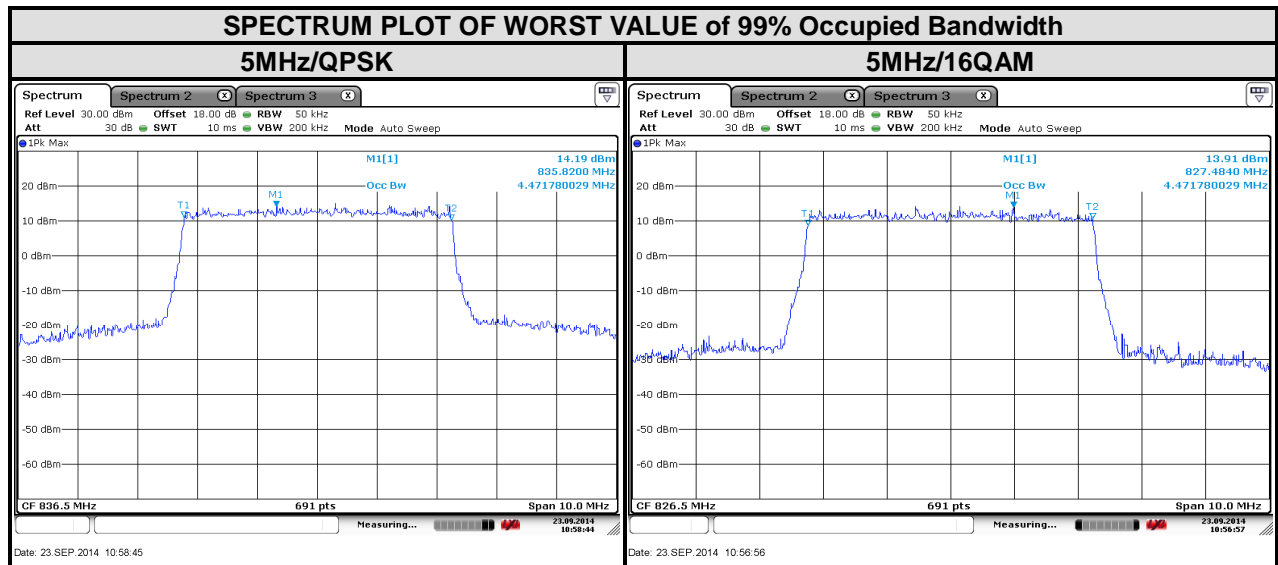

LTE band 5							
Channel Bandwidth : 10 MHz							
Channel	Frequency (MHz)	99% Occupied bandwidth (MHz)		Channel	Frequency (MHz)	26 dB bandwidth (MHz)	
		QPSK	16QAM			QPSK	16QAM
20450	829	8.94	8.97	20450	829	9.73	9.81
20525	836.5	8.91	8.94	20525	836.5	9.73	9.75
20600	844	8.94	8.97	20600	844	9.78	9.75

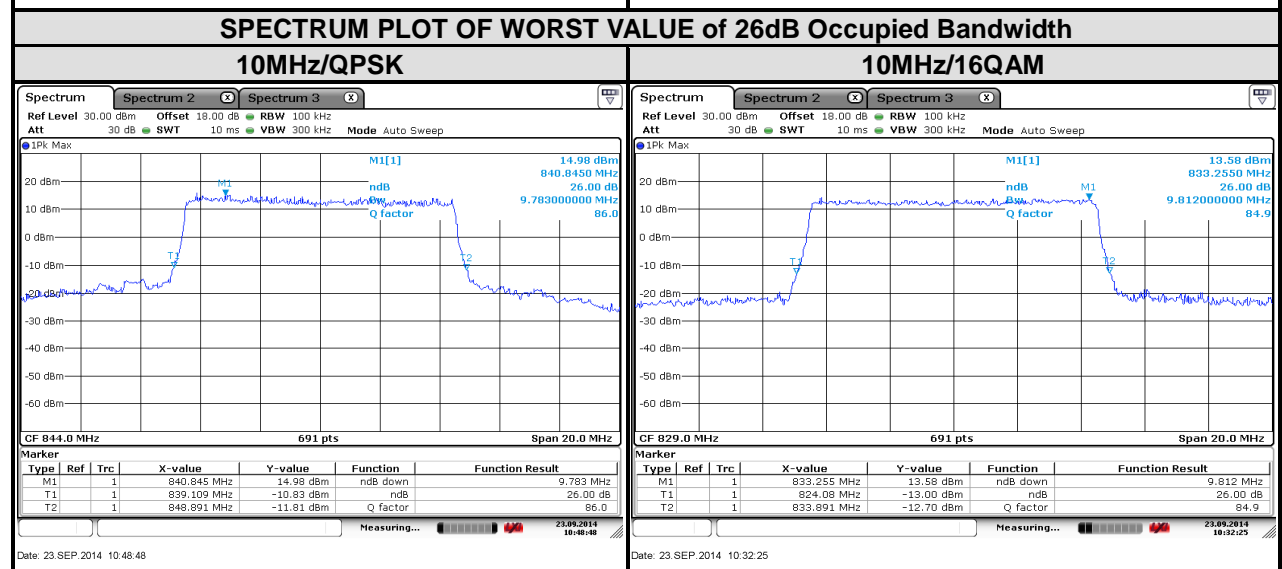
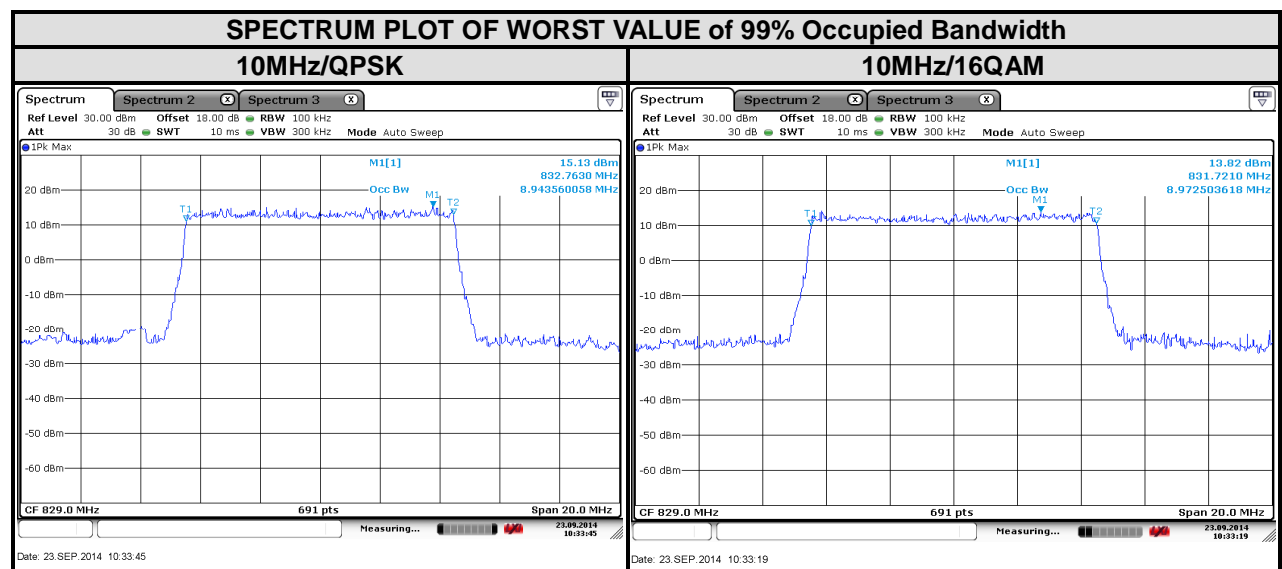

4.4 BAND EDGE MEASUREMENT

4.4.1 LIMITS OF BAND EDGE MEASUREMENT

Power of any emission outside of the authorized operating frequency ranges must be attenuated below the transmitting power (P) by a factor of at least $43 + 10 \log(P)$ dB. In the 1 MHz bands immediately outside and adjacent to the frequency block a resolution bandwidth of at least one percent of the emission bandwidth of the fundamental emission of the transmitter may be employed.

4.4.2 TEST SETUP

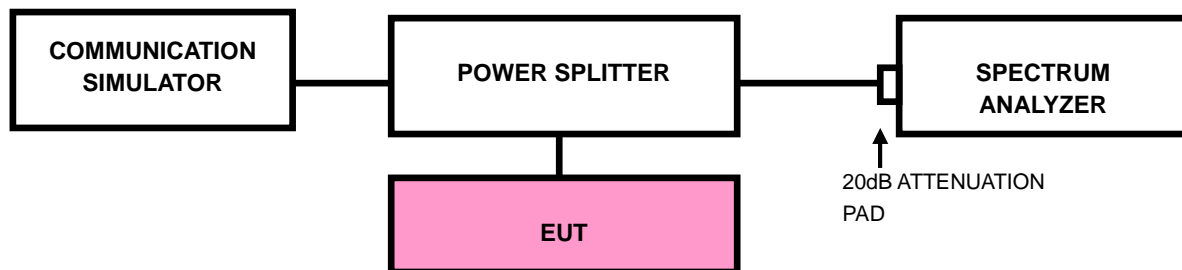

4.4.3 TEST PROCEDURES

- All measurements were done at low and high operational frequency range.
- The center frequency of spectrum is the band edge frequency and span is 1.5MHz. RBW of the spectrum is 10kHz and VBW of the spectrum is 30kHz (GSM/GPRS/EDGE).
- The center frequency of spectrum is the band edge frequency and span is 10MHz. RBW of the spectrum is 100kHz and VBW of the spectrum is 300kHz (WCDMA).
- The center frequency of spectrum is the band edge frequency and span is 1~5 MHz. RB of the spectrum is 20kHz and VB of the spectrum is 100 kHz. (LTE bandwidth 1.4MHz).
- The center frequency of spectrum is the band edge frequency and span is 1~5 MHz. RB of the spectrum is 30kHz and VB of the spectrum is 100kHz. (LTE bandwidth 3MHz)



Test Report No.: RF141006N005-3

- f. The center frequency of spectrum is the band edge frequency and span is 1~5 MHz. RB of the spectrum is 50kHz and VB of the spectrum is 200kHz. (LTE bandwidth 5MHz)
- g. The center frequency of spectrum is the band edge frequency and span is 1~5 MHz. RB of the spectrum is 100kHz and VB of the spectrum is 300kHz. (LTE bandwidth 10MHz)
- h. Record the max trace plot into the test report.

4.4.4 TEST RESULTS

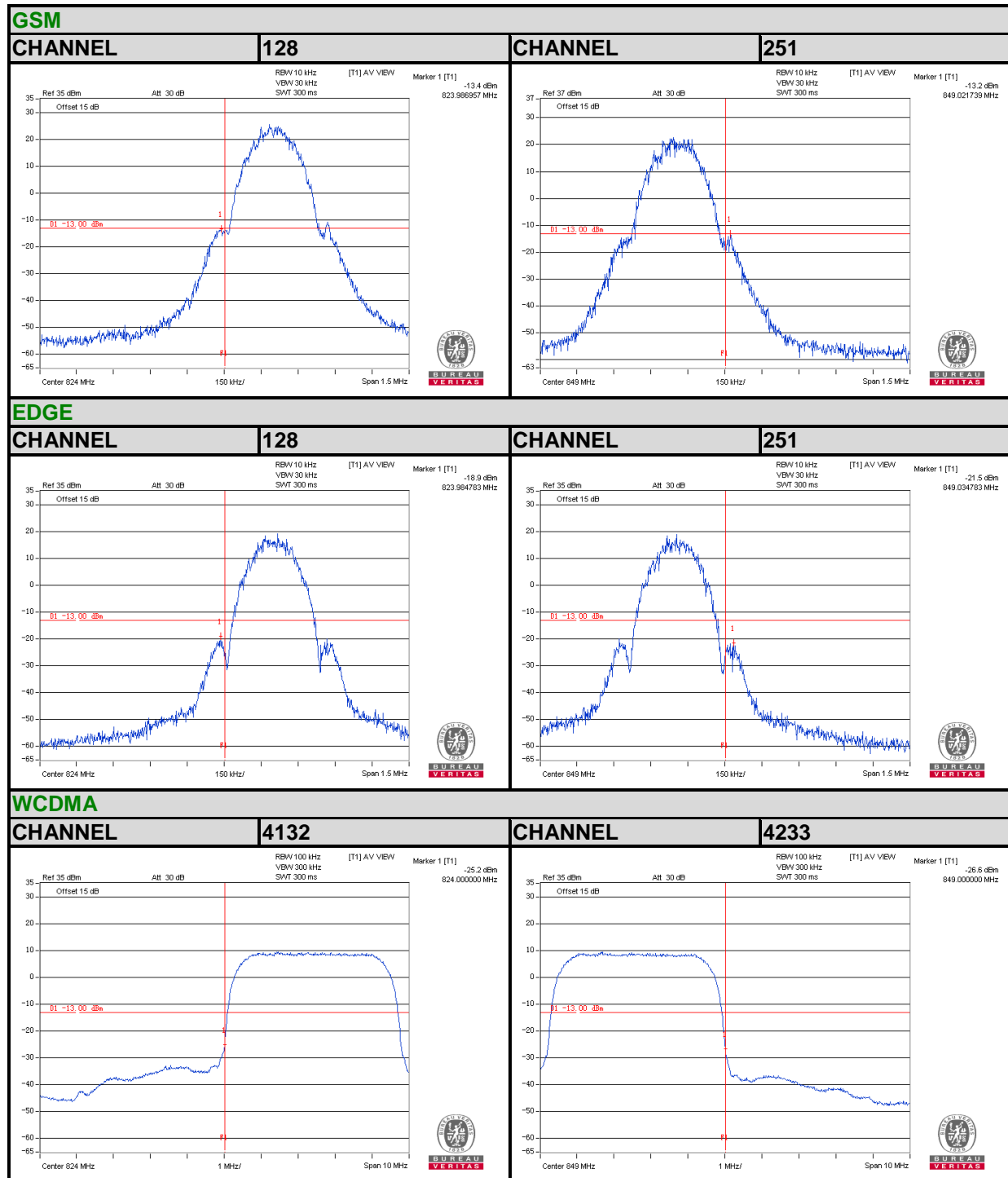



Test Report No.: RF141006N005-3

LTE Band5

Channel Bandwidth: 1.4MHz

CHANNEL 20407	1 RB	CHANNEL 20643	1 RB
----------------------	-------------	----------------------	-------------

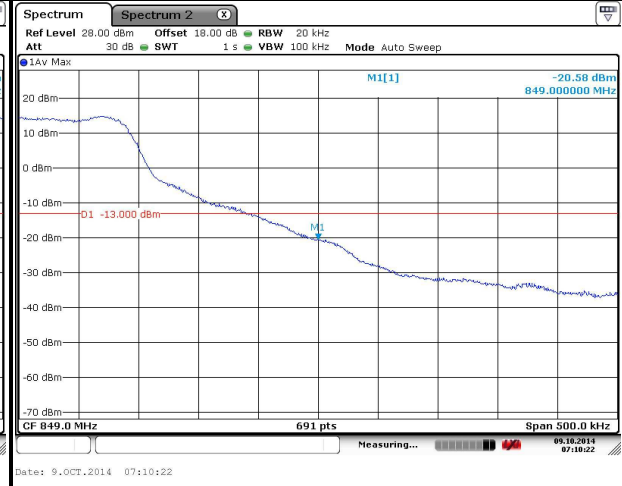
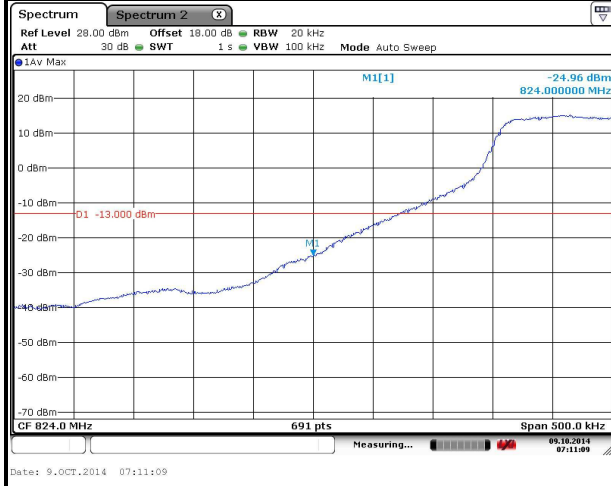

Date: 9.OCT.2014 07:11:09

Date: 9.OCT.2014 07:10:22

LTE Band5

Channel Bandwidth: 1.4MHz

CHANNEL 20407	Full RB	CHANNEL 20643	Full RB
----------------------	----------------	----------------------	----------------

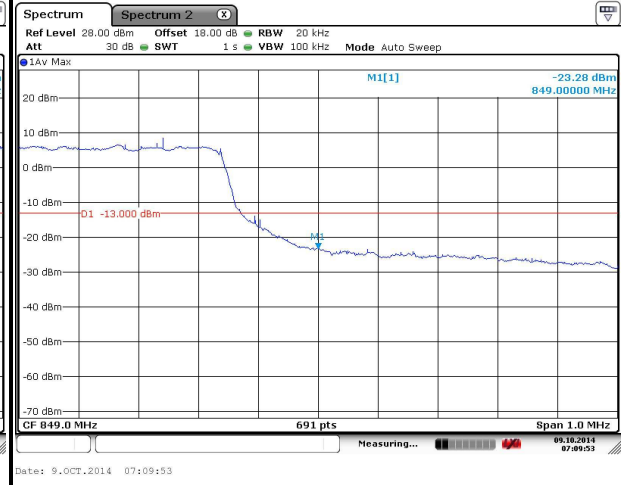
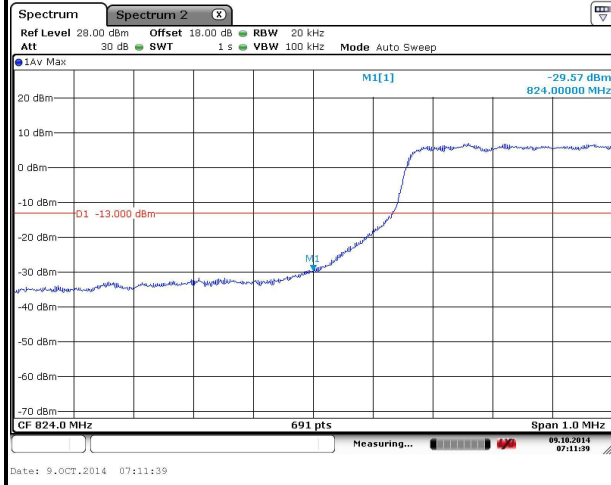

Date: 9.OCT.2014 07:11:39

Date: 9.OCT.2014 07:09:53

Bureau Veritas Shenzhen Co., Ltd.
Dongguan Branch

No. 34, Chenwulu Section, Guantai Rd.,
Houjie Town, Dongguan City,
Guangdong 523942, China

Tel: +86 769 8593 5656
Fax: +86 769 8593 1080
Email: customerservice.dg@cn.bureauveritas.com



Test Report No.: RF141006N005-3

LTE Band5

Channel Bandwidth: 3MHz

CHANNEL	20415	1 RB	CHANNEL	20635	1 RB
----------------	--------------	-------------	----------------	--------------	-------------

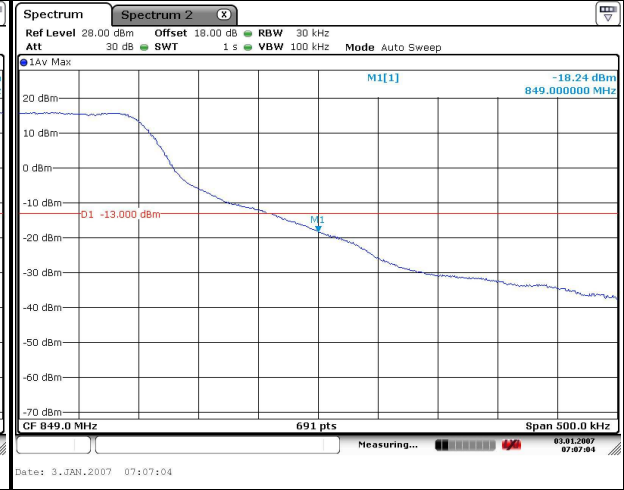
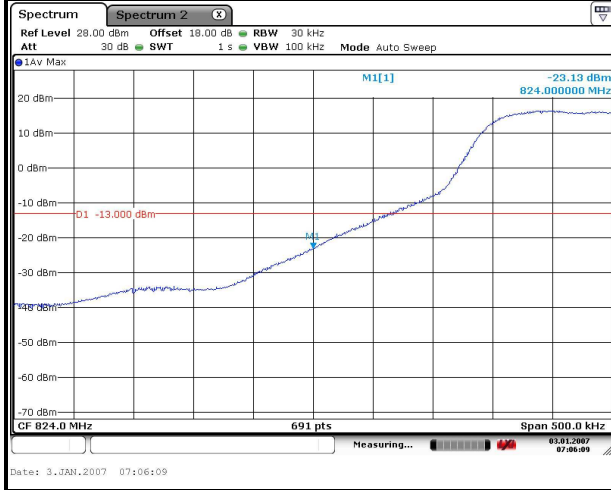

LTE Band5

Channel Bandwidth: 3MHz

CHANNEL	20415	Full RB	CHANNEL	20635	Full RB
----------------	--------------	----------------	----------------	--------------	----------------

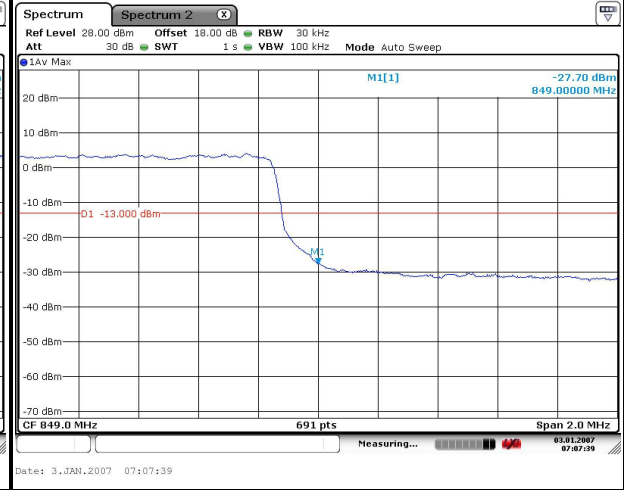
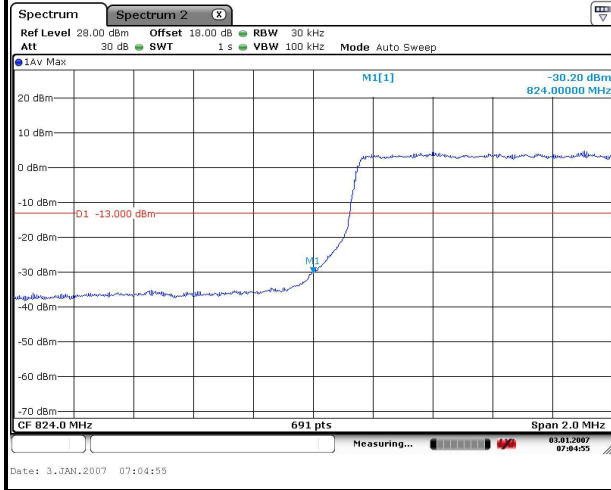

Bureau Veritas Shenzhen Co., Ltd.
Dongguan Branch

No. 34, Chenwulu Section, Guantai Rd.,
Houjie Town, Dongguan City,
Guangdong 523942, China

Tel: +86 769 8593 5656
Fax: +86 769 8593 1080
Email: customerservice.dg@cn.bureauveritas.com



LTE Band5

Channel Bandwidth: 5MHz

CHANNEL	20425	1 RB	CHANNEL	20625	1 RB
----------------	--------------	-------------	----------------	--------------	-------------

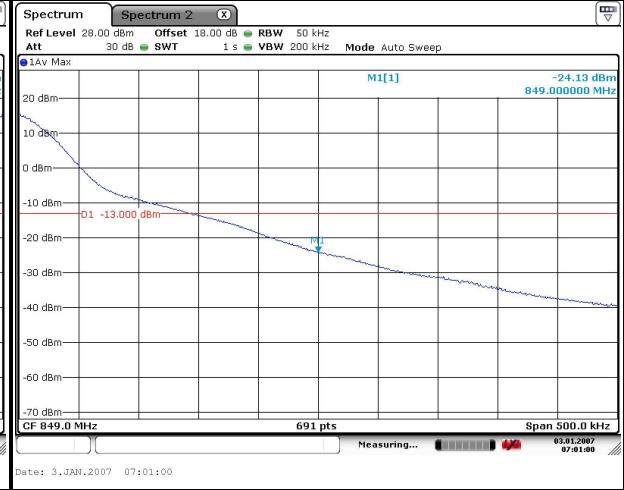
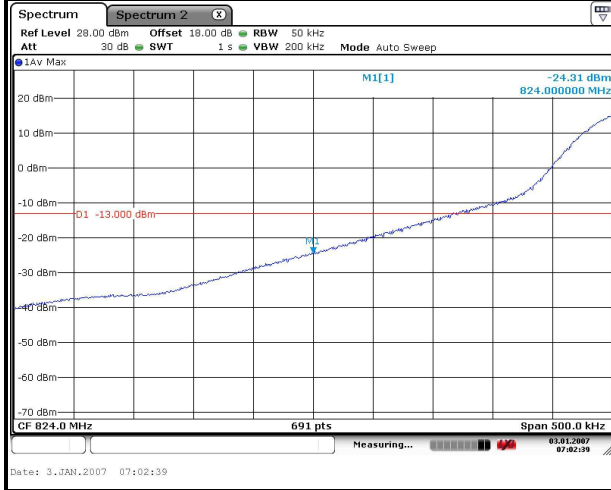

LTE Band5

Channel Bandwidth: 5MHz

CHANNEL	20425	Full RB	CHANNEL	20625	Full RB
----------------	--------------	----------------	----------------	--------------	----------------

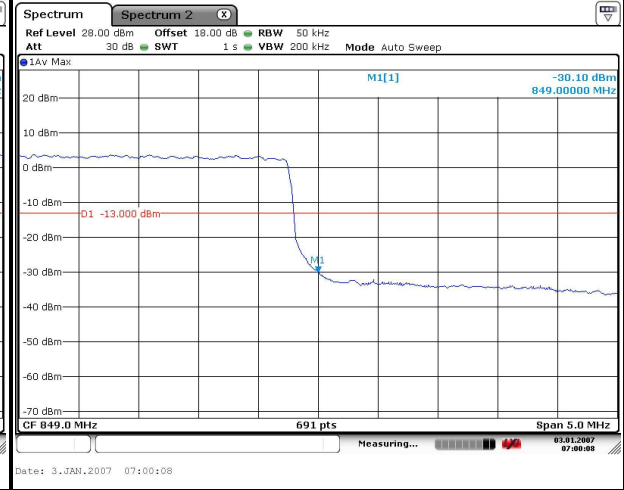
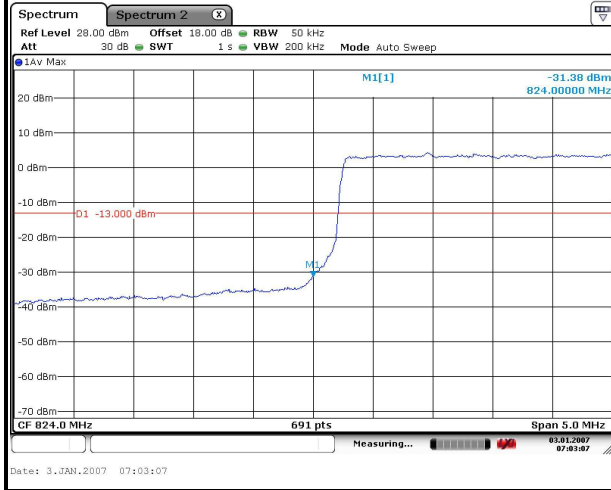



Test Report No.: RF141006N005-3

LTE Band5

Channel Bandwidth: 10MHz

CHANNEL	20450	1 RB	CHANNEL	20600	1 RB
----------------	--------------	-------------	----------------	--------------	-------------

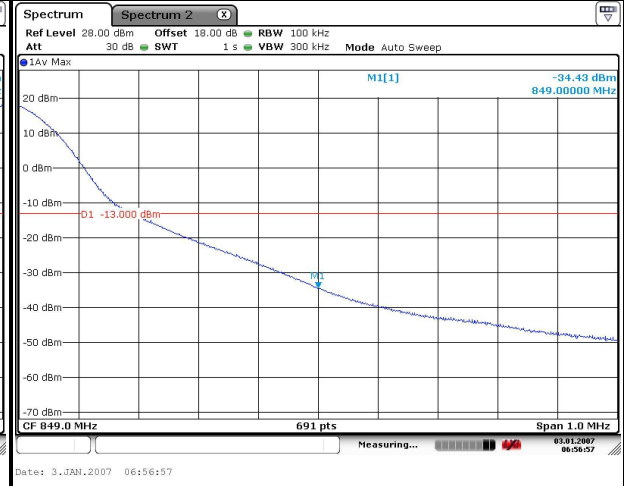
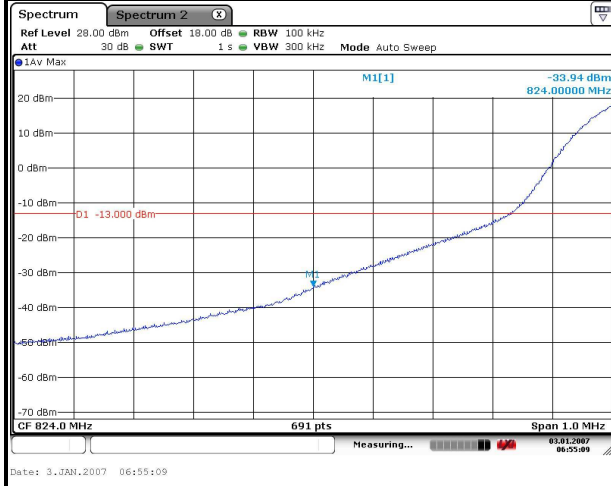

Date: 3.JAN.2007 06:55:09

LTE Band5

Channel Bandwidth: 10MHz

CHANNEL	20450	Full RB	CHANNEL	20600	Full RB
----------------	--------------	----------------	----------------	--------------	----------------

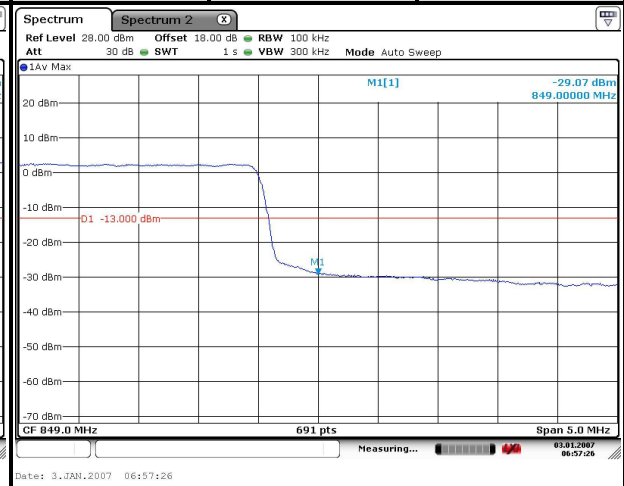
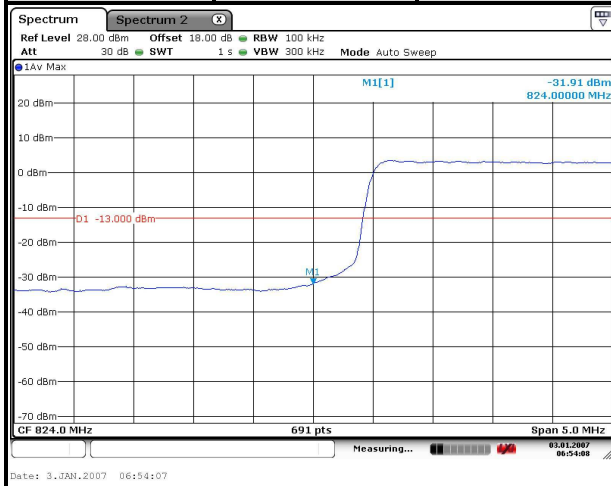

Date: 3.JAN.2007 06:54:07

Bureau Veritas Shenzhen Co., Ltd.
Dongguan Branch

No. 34, Chenwulu Section, Guantai Rd.,
Houjie Town, Dongguan City,
Guangdong 523942, China

Tel: +86 769 8593 5656
Fax: +86 769 8593 1080
Email: customerservice.dg@cn.bureauveritas.com

4.5 CONDUCTED SPURIOUS EMISSIONS

4.5.1 LIMITS OF CONDUCTED SPURIOUS EMISSIONS MEASUREMENT

The power of any emission outside of the authorized operating frequency ranges must be attenuated below the transmitting power (P) by a factor of at least $43 + 10 \log(P)$ dB. The emission limit equal to -13dBm .

4.5.2 TEST PROCEDURE

- a. The EUT makes a phone call to the communication simulator. All measurements were done at low, middle and high operational frequency range.
- b. Measuring frequency range is from 9 kHz to 9GHz. 20dB attenuation pad is connected with spectrum. RBW=1MHz and VBW=3MHz is used for conducted emission measurement.

4.5.3 TEST SETUP

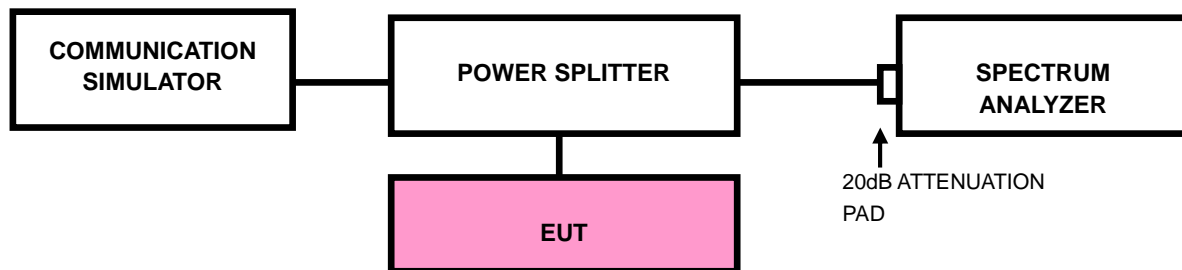



4.5.4 TEST RESULTS

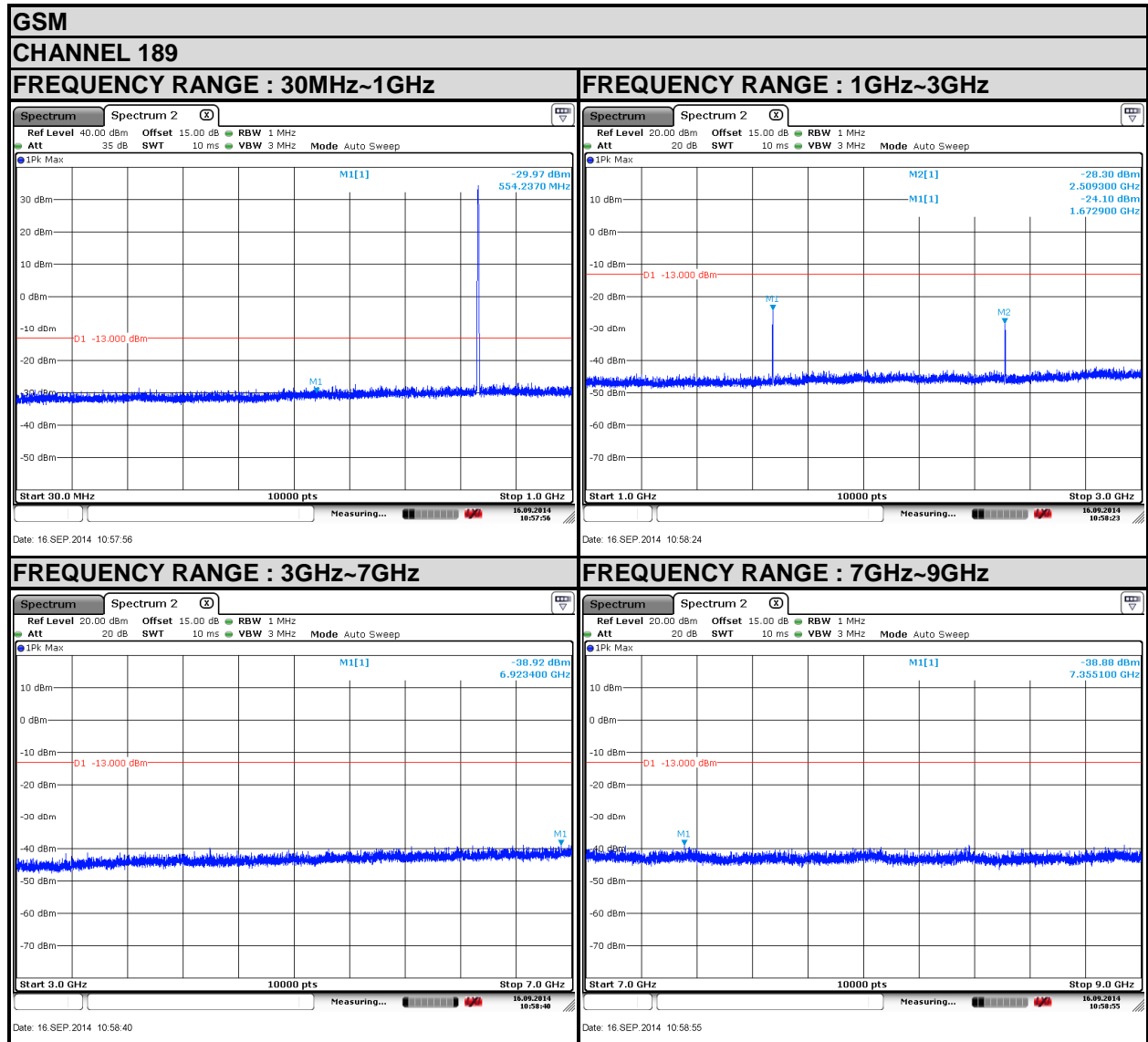



Test Report No.: RF141006N005-3

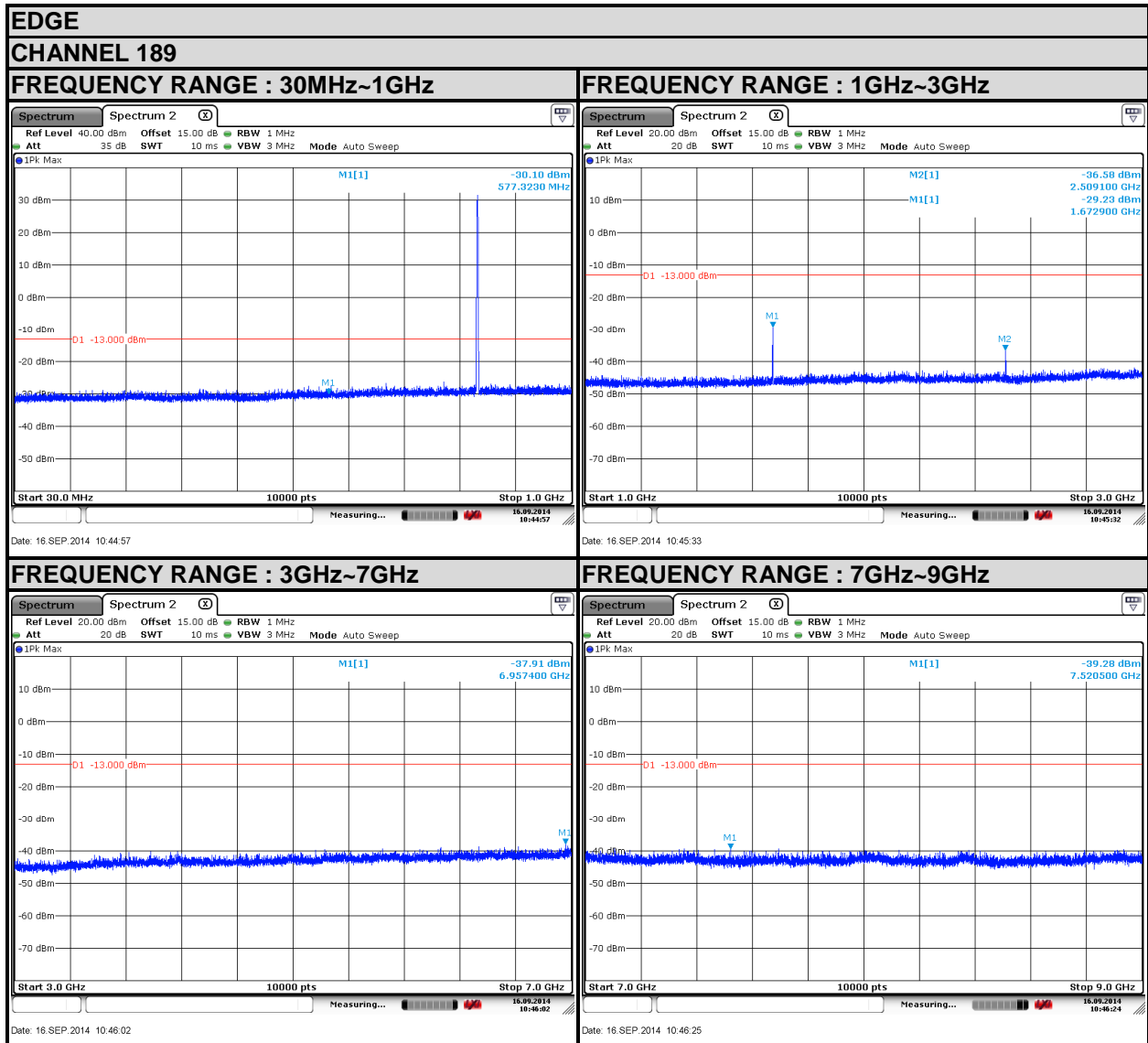

Bureau Veritas Shenzhen Co., Ltd.
Dongguan Branch

No. 34, Chenwulu Section, Guantai Rd.,
Houjie Town, Dongguan City,
Guangdong 523942, China

Tel: +86 769 8593 5656
Fax: +86 769 8593 1080
Email: customerservice.dg@cn.bureauveritas.com

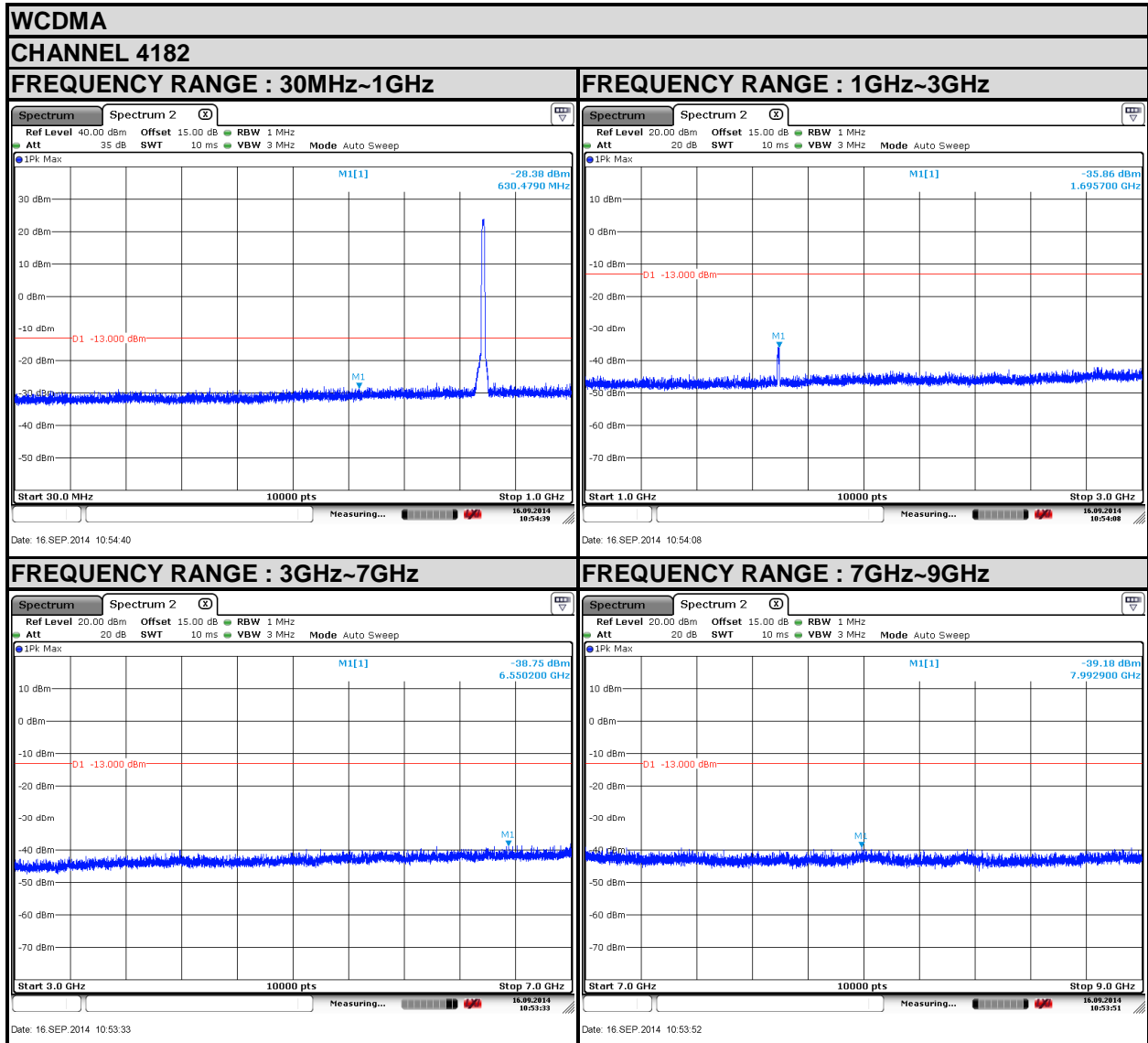

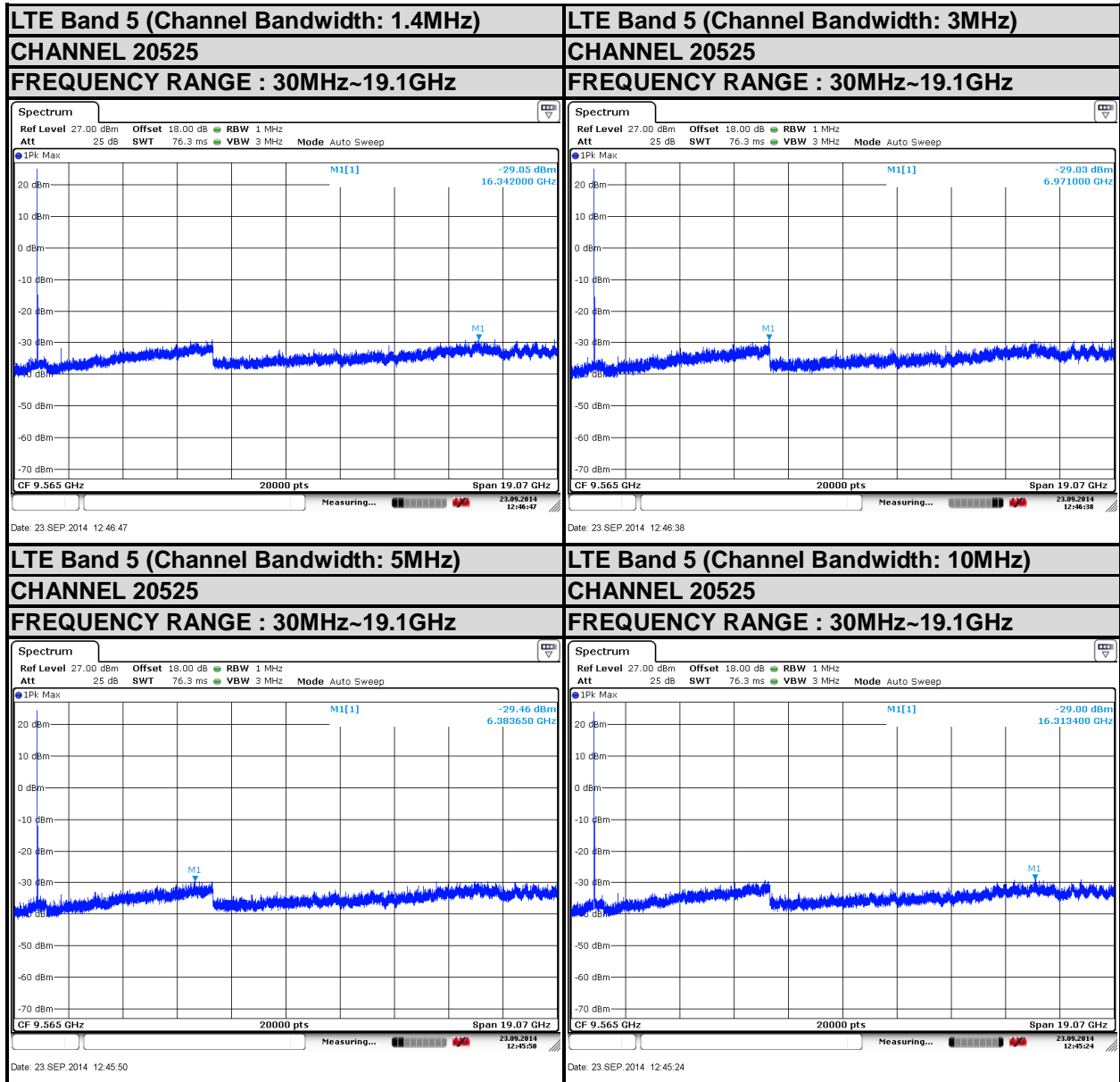



4.6 RADIATED EMISSION MEASUREMENT

4.6.1 LIMITS OF RADIATED EMISSION MEASUREMENT

The power of any emission outside of the authorized operating frequency ranges must be attenuated below the transmitting power (P) by a factor of at least $43 + 10 \log(P)$ dB. The emission limit equal to -13dBm .

4.6.2 TEST PROCEDURES

- a. Substitution method is used for E.I.R.P measurement. In the semi-anechoic chamber, EUT placed on the 0.8m height of Turn Table, rotated the table around 360 degrees to search the maximum radiation power and receiver antenna shall be rotated vertical and horizontal polarization and moved height from 1m to 4m to find the maximum polar radiated power. The “Read Value” is the spectrum reading the maximum power value.
- b. The substitution horn antenna is substituted for EUT at the same position and signals generator export the CW signal to the substitution antenna via a TX cable. Rotated the Turn Table and moved receiving antenna to find the maximum radiation power. Adjust output power level of S.G to get a Value of spectrum reading equal to “Read Value “ of step a. Record the power level of S.G
- c. $\text{EIRP} = \text{Output power level of S.G} - \text{TX cable loss} + \text{Antenna gain of substitution horn}$.
- d. E.R.P power can be calculated form E.I.R.P power by subtracting the gain of dipole, $\text{E.R.P power} = \text{E.I.P.R power} - 2.15\text{dBi}$.

NOTE: The resolution bandwidth and video bandwidth of test receiver/spectrum analyzer is 1MHz/3MHz.

4.6.3 DEVIATION FROM TEST STANDARD

No deviation

4.6.4 TEST SETUP

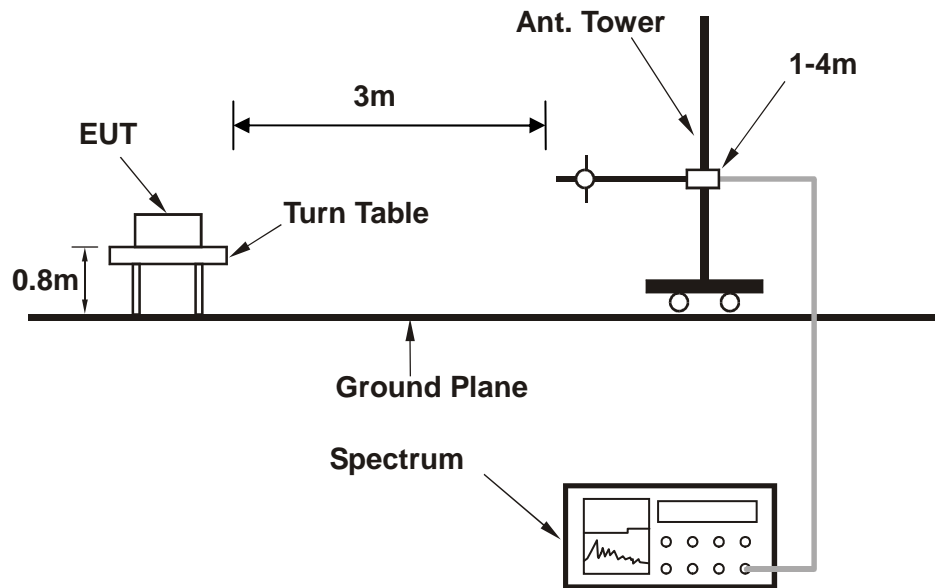

For the actual test configuration, please refer to the attached file (Test Setup Photo).



4.6.5 TEST RESULTS

BELOW 1GHz WORST-CASE DATA : LTE BAND 5

SPURIOUS EMISSION FREQUENCY RANGE	Below 1000MHz	OPERATING CHANNEL	Channel 20525
--	---------------	--------------------------	---------------

SPURIOUS EMISSION LEVEL				
Frequency (MHz)	Antenna Polarization	Level (dBm)	Limit (dBm)	Margin (dB)
30.00	H	-69.00	-13.00	-56.00
43.99	H	-74.69	-13.00	-61.69
112.39	H	-73.76	-13.00	-60.76
159.02	H	-72.13	-13.00	-59.13
244.52	H	-72.33	-13.00	-59.33
314.47	H	-69.38	-13.00	-56.38

NOTE: The emission behavior belongs to narrowband spurious emission.

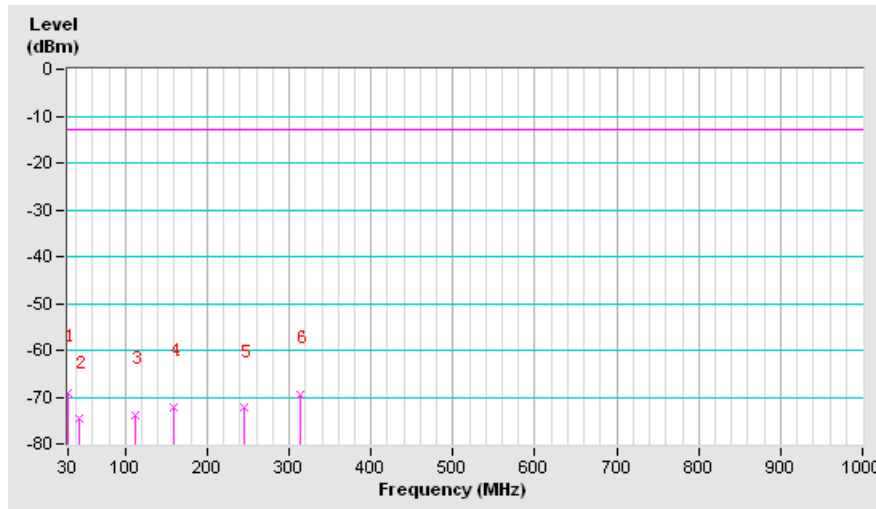



SPURIOUS EMISSION FREQUENCY RANGE	Below 1000MHz	OPERATING CHANNEL	Channel 20525
--	---------------	--------------------------	---------------

SPURIOUS EMISSION LEVEL				
Frequency (MHz)	Antenna Polarization	Level (dBm)	Limit (dBm)	Margin (dB)
33.11	V	-71.96	-13.00	-58.96
160.58	V	-74.16	-13.00	-61.16
255.40	V	-70.91	-13.00	-57.91
457.48	V	-66.05	-13.00	-53.05
586.51	V	-62.21	-13.00	-49.21
774.60	V	-58.77	-13.00	-45.77

NOTE: The emission behavior belongs to narrowband spurious emission.

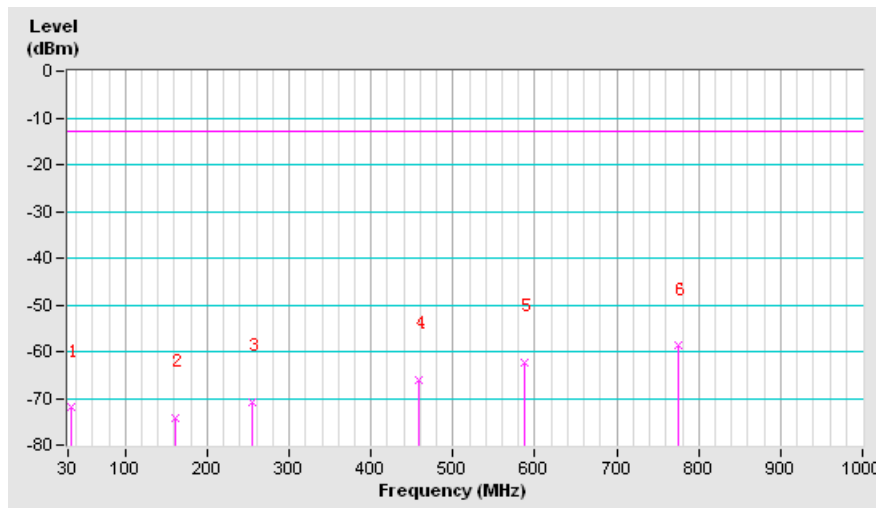



Test Report No.: RF141006N005-3

ABOVE 1GHz DATA

GSM:

ANTENNA POLARITY & TEST DISTANCE: HORIZONTAL AT 3 M

No.	Freq. (MHz)	SPA READING (dBm)	Limit (dBm)	S.G Power Value (dBm)	Correction Factor (dB)	ERP (dBm)	Margin (dB)
1	1672	-47.24	-13	-40.60	0.11	-40.49	-27.49
2	2509	-45.62	-13	-35.44	-0.06	-35.50	-22.50
3	3345	-49.57	-13	-37.90	0.69	-37.21	-24.21
4	4182	-52.36	-13	-38.45	0.12	-38.33	-25.33

ANTENNA POLARITY & TEST DISTANCE: VERTICAL AT 3 M

No.	Freq. (MHz)	SPA READING (dBm)	Limit (dBm)	S.G Power Value (dBm)	Correction Factor (dB)	ERP (dBm)	Margin (dB)
1	1672	-49.22	-13	-38.27	0.11	-38.16	-25.16
2	2509	-50.14	-13	-38.06	-0.06	-38.12	-25.12
3	3345	-49.27	-13	-36.79	0.69	-36.10	-23.10
4	4182	-53.24	-13	-36.15	0.12	-36.03	-23.03

REMARKS:

1. ERP (dBm) = S.G Value (dBm) + Correction Factor (dB).
2. Correction Factor (dB) = Substitution Antenna Gain (dB) + Cable Loss (dB) - 2.15 (dB)

EDGE:

ANTENNA POLARITY & TEST DISTANCE: HORIZONTAL AT 3 M

No.	Freq. (MHz)	Emission Level (dBuV)	Limit (dBm)	S.G Power Value (dBm)	Correction Factor (dB)	ERP (dBm)	Margin (dB)
1	1672	-44.14	-13	-37.47	0.11	-37.36	-24.36
2	2509	-46.28	-13	-36.10	-0.06	-36.16	-23.16
3	3345	-48.36	-13	-36.68	0.69	-35.99	-22.99
4	4182	-51.47	-13	-37.55	0.12	-37.43	-24.43

ANTENNA POLARITY & TEST DISTANCE: VERTICAL AT 3 M

No.	Freq. (MHz)	Emission Level (dBuV)	Limit (dBm)	S.G Power Value (dBm)	Correction Factor (dB)	ERP (dBm)	Margin (dB)
1	1672	-46.22	-13	-35.27	0.11	-35.16	-22.16
2	2509	-49.57	-13	-37.48	-0.06	-37.54	-24.54
3	3345	-51.28	-13	-38.81	0.69	-38.12	-25.12
4	4182	-54.74	-13	-37.65	0.12	-37.53	-24.53

REMARKS:

1. ERP (dBm) = S.G Value (dBm) + Correction Factor (dB).
2. Correction Factor (dB) = Substitution Antenna Gain (dB) + Cable Loss (dB) - 2.15 (dB)

Bureau Veritas Shenzhen Co., Ltd.
Dongguan Branch

No. 34, Chenwulu Section, Guantai Rd.,
Houjie Town, Dongguan City,
Guangdong 523942, China

Tel: +86 769 8593 5656
Fax: +86 769 8593 1080
Email: customerservice.dg@cn.bureauveritas.com



Test Report No.: RF141006N005-3

WCDMA:

ANTENNA POLARITY & TEST DISTANCE: HORIZONTAL AT 3 M							
No.	Freq. (MHz)	SPA READING (dBm)	Limit (dBm)	S.G Power Value (dBm)	Correction Factor (dB)	ERP (dBm)	Margin (dB)
1	1672	-46.25	-13	-39.60	0.11	-39.49	-26.49
2	2509	-48.24	-13	-38.07	-0.06	-38.13	-25.13
3	3345	-51.24	-13	-39.58	0.69	-38.89	-25.89
4	4182	-54.25	-13	-40.35	0.12	-40.23	-27.23
ANTENNA POLARITY & TEST DISTANCE: VERTICAL AT 3 M							
No.	Freq. (MHz)	SPA READING (dBm)	Limit (dBm)	S.G Power Value (dBm)	Correction Factor (dB)	ERP (dBm)	Margin (dB)
1	1672	-45.22	-13	-34.27	0.11	-34.16	-21.16
2	2509	-45.62	-13	-33.43	-0.06	-33.49	-20.49
3	3345	-49.25	-13	-36.77	0.69	-36.08	-23.08
4	4182	-52.33	-13	-35.24	0.12	-35.12	-22.12

REMARKS:

- ERP (dBm) = S.G Value (dBm) + Correction Factor (dB).
- Correction Factor (dB) = Substitution Antenna Gain (dB) + Cable Loss (dB) - 2.15 (dB)

LTE BAND 5

CHANNEL BANDWIDTH: 1.4MHz / QPSK

MODE	TX channel 20525	FREQUENCY RANGE	Above 1000MHz
ENVIRONMENTAL CONDITIONS	24deg. C, 60%RH	INPUT POWER	DC 5V from adapter
TESTED BY	Blue Zheng		

ANTENNA POLARITY & TEST DISTANCE: HORIZONTAL AT 3 M							
No.	Freq. (MHz)	Reading (dBm)	Limit (dBm)	S.G Power Value (dBm)	Correction Factor (dB)	ERP (dBm)	Margin (dB)
1	1672	-67.36	-13	-64.50	2.26	-64.39	-67.36
2	2509	-67.48	-13	-60.47	2.09	-60.53	-67.48
3	3345	-67.36	-13	-58.34	2.84	-57.65	-67.36
ANTENNA POLARITY & TEST DISTANCE: VERTICAL AT 3 M							
No.	Freq. (MHz)	Reading (dBm)	Limit (dBm)	S.G Power Value (dBm)	Correction Factor (dB)	ERP (dBm)	Margin (dB)
1	1672	-68.65	-13	-62.17	2.26	-62.06	-68.65
2	2509	-68.54	-13	-60.14	2.09	-60.20	-68.54
3	3345	-68.76	-13	-58.16	2.84	-57.47	-68.76

REMARKS:

- ERP (dBm) = S.G Value (dBm) + Correction Factor (dB).
- Correction Factor (dB) = Substitution Antenna Gain (dB) + Cable Loss (dB) - 2.15 (dB)

Bureau Veritas Shenzhen Co., Ltd.
Dongguan Branch

No. 34, Chenwulu Section, Guantai Rd.,
Houjie Town, Dongguan City,
Guangdong 523942, China

Tel: +86 769 8593 5656
Fax: +86 769 8593 1080
Email: customerservice.dg@cn.bureauveritas.com



BUREAU
VERITAS

Test Report No.: RF141006N005-3

CHANNEL BANDWIDTH: 3MHz / QPSK

MODE	TX channel 20525	FREQUENCY RANGE	Above 1000MHz
ENVIRONMENTAL CONDITIONS	24deg. C, 60%RH	INPUT POWER	DC 5V from adapter
TESTED BY	Blue Zheng		

ANTENNA POLARITY & TEST DISTANCE: HORIZONTAL AT 3 M							
No.	Freq. (MHz)	Reading (dBm)	Limit (dBm)	S.G Power Value (dBm)	Correction Factor (dB)	ERP (dBm)	Margin (dB)
1	1672	-67.41	-13	-64.55	2.26	-64.44	-67.41
2	2509	-67.65	-13	-60.64	2.09	-60.70	-67.65
3	3345	-67.74	-13	-58.72	2.84	-58.03	-67.74
ANTENNA POLARITY & TEST DISTANCE: VERTICAL AT 3 M							
No.	Freq. (MHz)	Reading (dBm)	Limit (dBm)	S.G Power Value (dBm)	Correction Factor (dB)	ERP (dBm)	Margin (dB)
1	1672	-68.69	-13	-62.21	2.26	-62.10	-68.69
2	2509	-68.63	-13	-60.24	2.09	-60.30	-68.63
3	3345	-68.27	-13	-57.67	2.84	-56.98	-68.27

REMARKS:

- ERP (dBm) = S.G Value (dBm) + Correction Factor (dB).
- Correction Factor (dB) = Substitution Antenna Gain (dB) + Cable Loss (dB) - 2.15 (dB)



Test Report No.: RF141006N005-3

CHANNEL BANDWIDTH: 5MHz / QPSK

MODE	TX channel 20525	FREQUENCY RANGE	Above 1000MHz
ENVIRONMENTAL CONDITIONS	24deg. C, 60%RH	INPUT POWER	DC 5V from adapter
TESTED BY	Blue Zheng		

ANTENNA POLARITY & TEST DISTANCE: HORIZONTAL AT 3 M							
No.	Freq. (MHz)	Reading (dBm)	Limit (dBm)	S.G Power Value (dBm)	Correction Factor (dB)	ERP (dBm)	Margin (dB)
1	1672	-67.47	-13	-64.61	2.26	-64.50	-67.47
2	2509	-67.32	-13	-60.31	2.09	-60.37	-67.32
3	3345	-67.22	-13	-58.20	2.84	-57.51	-67.22
ANTENNA POLARITY & TEST DISTANCE: VERTICAL AT 3 M							
No.	Freq. (MHz)	Reading (dBm)	Limit (dBm)	S.G Power Value (dBm)	Correction Factor (dB)	ERP (dBm)	Margin (dB)
1	1672	-68.65	-13	-62.17	2.26	-62.06	-68.65
2	2509	-68.22	-13	-59.82	2.09	-59.88	-68.22
3	3345	-68.69	-13	-58.09	2.84	-57.40	-68.69

REMARKS:

1. ERP (dBm) = S.G Value (dBm) + Correction Factor (dB).
2. Correction Factor (dB) = Substitution Antenna Gain (dB) + Cable Loss (dB) - 2.15 (dB)



Test Report No.: RF141006N005-3

CHANNEL BANDWIDTH: 10MHz / QPSK

MODE	TX channel 20525	FREQUENCY RANGE	Above 1000MHz
ENVIRONMENTAL CONDITIONS	24deg. C, 60%RH	INPUT POWER	DC 5V from adapter
TESTED BY	Blue Zheng		

ANTENNA POLARITY & TEST DISTANCE: HORIZONTAL AT 3 M							
No.	Freq. (MHz)	Reading (dBm)	Limit (dBm)	S.G Power Value (dBm)	Correction Factor (dB)	ERP (dBm)	Margin (dB)
1	1672	-67.46	-13	-64.60	2.26	-64.49	-51.49
2	2509	-67.87	-13	-60.86	2.09	-60.92	-47.92
3	3345	-67.63	-13	-58.61	2.84	-57.92	-44.92
ANTENNA POLARITY & TEST DISTANCE: VERTICAL AT 3 M							
No.	Freq. (MHz)	Reading (dBm)	Limit (dBm)	S.G Power Value (dBm)	Correction Factor (dB)	ERP (dBm)	Margin (dB)
1	1672	-68.11	-13	-61.63	2.26	-61.52	-48.52
2	2509	-68.41	-13	-60.01	2.09	-60.07	-47.07
3	3345	-68.96	-13	-58.36	2.84	-57.67	-44.67

REMARKS:

- ERP (dBm) = S.G Value (dBm) + Correction Factor (dB).
- Correction Factor (dB) = Substitution Antenna Gain (dB) + Cable Loss (dB) - 2.15 (dB)



Test Report No.: RF141006N005-3

5 PHOTOGRAPHS OF THE TEST CONFIGURATION

Please refer to the attached file (Test Setup Photo).



Test Report No.: RF141006N005-3

6 INFORMATION ON THE TESTING LABORATORIES

We, Bureau Veritas Shenzhen Co., Ltd. Dongguan Branch, were founded in 2002 to provide our best service in EMC, Radio, Telecom and Safety consultation. Our laboratories are accredited and approved according to ISO/IEC 17025.

If you have any comments, please feel free to contact us at the following:

Dongguan EMC/RF Lab:

Tel: +86-769-85935656

Fax: +86-769-85931080

Email: customerservice.dg@cn.bureauveritas.com

Web Site: www.adt.com.tw

The address and road map of all our labs can be found in our web site also.



Test Report No.: RF141006N005-3

7 APPENDIX A – MODIFICATIONS RECORDERS FOR ENGINEERING CHANGES TO THE EUT BY THE LAB

No any modifications are made to the EUT by the lab during the test.

---END---