

# TEST REPORT

of

## FCC Part 15 Subpart C & CANADA RSS-247

Product: **Bluetooth 5.3 module**  
Brand: **Fanstel**  
Main Model: **BT840N**  
Series Model: **BT840NE**  
Model Difference: **Antenna. Please see page 6 for detail**  
FCC ID: **X8WBT840N**  
IC: **4100A-BT840N**  
FCC Rule Part: **§15.247, Cat: DTS**  
IC Rule Part: **RSS-247 issue 2: 2017  
RSS-Gen issue 5: 2018**  
Reference: **ANSI C63.10: 2013  
KDB 558074 D01 v05r02**  
Applicant: **Fanstel Corporation, Taipei**  
Address: **10F-10, No. 79, Sec. 1, Hsin Tai Wu Rd., Hsi-Chih, New  
Taipei City 221 Taiwan**

Test Performed by:



**International Standards Laboratory Corp. LT Lab.**

TEL: +886-3-263-8888 FAX: +886-3-263-8899

No. 120, Lane 180, Hsin Ho Rd., Lung-Tan Dist., Tao Yuan City 325,  
Taiwan

Report No.: **ISL-23LR0074FCBLE**  
Issue Date : **September 11, 2023**



FCC Registration Number: 487532

Test results given in this report apply only to the specific sample(s) tested and are traceable to national or international standard through calibration of the equipment and evaluating measurement uncertainty herein. The uncertainty of the measurement does not include in consideration of the test result unless the customer required the determination of uncertainty via the agreement, regulation or standard document specification. This test report shall not be reproduced except in full, without the written approval of International Standards Laboratory Corp.

### VERIFICATION OF COMPLIANCE

**Applicant:** Fanstel Corporation, Taipei  
**Equipment Under Test:** Bluetooth 5.3 module  
**Brand:** Fanstel  
**Main Model:** BT840N  
**Series Model:** BT840NE  
**Model Difference:** Antenna. Please see page 6 for detail  
**FCC ID:** X8WBT840N  
**IC:** 4100A-BT840N  
**Date of Test:** May 30, 2023 ~ September 11, 2023  
**Date of EUT Received:** May 30, 2023

APPLICABLE STANDARDS	
STANDARD	TEST RESULT
FCC Part 15.247 RSS-247	Complied

**We hereby certify that:**

All the tests in this report have been performed and recorded in accordance with the standards described above and performed by an independent electromagnetic compatibility consultant, International Standards Laboratory Corp.

The test results contained in this report accurately represent the measurements of the characteristics and the energy generated by sample equipment under test at the time of the test. The sample equipment tested as described in this report is in compliance with the limits of above standards.

**Test By:**                     Weixin Chen                     **Date:**                     September 11, 2023                      
*Weixin Chen / Senior Engineer*

**Prepared By:**                     Gigi Yeh                     **Date:**                     September 11, 2023                      
*Gigi Yeh / Senior Engineer*

**Approved By:**                     Jerry Liu                     **Date:**                     September 11, 2023                      
*Jerry Liu / Manager*

## Version

Version No.	Date	Description
00	September 11, 2023	Initial creation of document

# TABLE OF CONTENTS

<b>1. General.....</b>	<b>6</b>
1.1 DESCRIPTION OF EUT .....	6
1.2 SPECIAL ACCESSORIES .....	7
1.3 EQUIPMENT MODIFICATIONS .....	7
<b>2. System Test Configuration.....</b>	<b>8</b>
2.1 EUT CONFIGURATION.....	8
2.2 EUT EXERCISE .....	8
2.3 TEST PROCEDURE.....	8
2.4 CONFIGURATION OF TESTED SYSTEM.....	8
2.5 DUTY FACTOR .....	9
<b>3. Summary of Test Results.....</b>	<b>10</b>
<b>4. Description of Test Modes.....</b>	<b>10</b>
<b>5. AC Line Conduced Emission Test.....</b>	<b>11</b>
5.1 STANDARD APPLICABLE .....	11
5.2 MEASUREMENT PROCEDURE.....	11
5.3 MEASUREMENT RESULT.....	12
<b>6. Peak Output Power Measurement .....</b>	<b>14</b>
6.1 STANDARD APPLICABLE .....	14
6.2 MEASUREMENT PROCEDURE.....	14
6.3 MEASUREMENT RESULT.....	15
<b>7. Radiated Spurious Emission Test.....</b>	<b>16</b>
7.1 STANDARD APPLICABLE .....	16
7.2 MEASUREMENT PROCEDURE.....	16
7.3 FIELD STRENGTH CALCULATION .....	17
7.4 MEASUREMENT RESULT.....	18
<b>8. 100kHz Bandwidth of Band Edges Measurement .....</b>	<b>42</b>
8.1 STANDARD APPLICABLE .....	42
8.2 MEASUREMENT PROCEDURE.....	42
8.3 FIELD STRENGTH CALCULATION .....	42
8.4 MEASUREMENT RESULT.....	43
<b>9. 6dB Bandwidth.....</b>	<b>51</b>
9.1 STANDARD APPLICABLE .....	51
9.2 MEASUREMENT PROCEDURE.....	51
9.3 MEASUREMENT RESULT.....	51
<b>10. Peak Power Spectral Density .....</b>	<b>54</b>
10.1 STANDARD APPLICABLE .....	54
10.2 MEASUREMENT PROCEDURE.....	54
10.3 MEASUREMENT RESULT.....	54
<b>11. Appendix.....</b>	<b>57</b>
11.1 APPENDIX A: EQUIPMENT LIST .....	57
11.2 APPENDIX B: UNCERTAINTY OF MEASUREMENT.....	59



11.3 APPENDIX C: TEST SETUP .....60  
11.4 APPENDIX D: PHOTOGRAPHS OF SETUP .....63  
11.5 APPENDIX E: PHOTOGRAPHS OF EUT .....71

# 1. General

## 1.1 Description of EUT

General Information	
Product Name:	Bluetooth 5.3 module
Brand Name:	Fanstel
Model Name:	BT840N; BT840NE
Model Difference:	Antenna. Please see table below for detail.
Temperature Range	-45°C to +105°C
Power Supply:	5VDC
BLE Information	
Frequency Range:	2402 – 2480MHz
Max Output Power:	20.593dBm
Channel number:	40 channels
Modulation type:	GFSK
PMN (Product Marketing Name)	BT840N
HVIN (Hardware Version Identification Number)	BT840N; BT840NE
FVIN (Firmware Version Identification Number)	nrf52840 s140
Test SW Version:	Putty 0.60.0.0
RFpower setting:	Pos6dBm

	Antenna Type	Brand	Model	Peak Gain	Frequency Range	Connector Type
1	Dipole	Fanstel	ANT060	6dBi	2400-2485 MHz	MMCX
2	PCB	Fanstel	F type	0.88dBi	2400-2485 MHz	MMCX

### Model Summaries

module	BT840N	BT840NE
SoC	nRF52840	nRF52840
Size, mm	15x29.9x2.0	15x29.9x2.0
32M,32.768kHz crystals	Integrated	Integrated
DCDC inductors,VDD,VDDH	Integrated	Integrated
BT Antenna	PA+PCB	PA+PCB+u.FL
Operating temp.	-40oC to +85oC	-40oC to +85oC
Evaluation board	EV-BT840NE	EV-BT840NE

## **1.2 Special Accessories**

Not available for this EUT intended for grant.

## **1.3 Equipment Modifications**

Not available for this EUT intended for grant.

## 2. System Test Configuration

### 2.1 EUT Configuration

The EUT configuration for testing is installed on RF field strength measurement to meet the Commissions requirement and operating in a manner which intends to maximize its emission characteristics in a continuous normal application.

### 2.2 EUT Exercise

The EUT (Transmitter) was operated in the engineering mode to fix the Tx frequency that was for the purpose of the measurements.

### 2.3 Test Procedure

#### 2.3.1 AC Line Conducted Emissions

The EUT is a placed on as turn table which is 0.8 m above ground plane. According to ANSI C63.10 and RSS-Gen. AC Line Conducted emissions from the EUT measured in the frequency range between 0.15 MHz and 30MHz using CISPR 16-1-1 Quasi-Peak and Average detector mode.

#### 2.3.2 Radiated Emissions

The EUT is a placed on as turn table which is 0.8 m/1.5m (Frequency above 1GHz) above ground plane. The turn table shall rotate 360 degrees to determine the position of maxi-mum emission level. EUT is set 3m away from the receiving antenna which varied from 1m to 4m to find out the highest emission. And also, each emission was to be maximized by changing the polarization of receiving antenna both horizontal and vertical. In order to find out the max. emission, the relative positions of this hand-held transmitter (EUT) was rotated through three orthogonal axes according to ANSI C63.10.

### 2.4 Configuration of Tested System

#### Configuration of Tested System (Fixed channel)

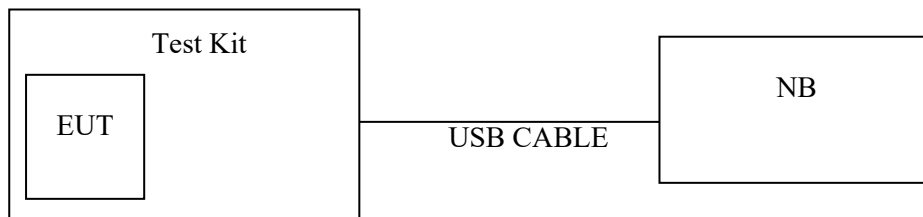

#### Equipment Used in Tested System

Item	Equipment	Mfr/Brand	Model/ Type No.	Series No.	Data Cable	Power Cord
1	Notebook	Lenovo	X220i	N/A	N/A	Non-shielded
2	Test Kit	N/A	N/A	N/A	N/A	N/A



## 2.5 Duty factor

Mode	ON time (ms)	Total time (ms)	Duty Cycle	Duty Factor	1/Ton	VBW (kHz)
BLE (1M)	10	10	100%	0	0.1	NA

If duty cycle of test signal is  $\geq 98\%$ , duty factor is not required.

If duty cycle of test signal is  $< 98\%$ , duty factor shall be considered.

The output power = measured power + duty factor

For frequency above 1GHz, the video bandwidth setting for average detector:  $VBW \geq 1/Ton$

Test Data: BLE Duty 1M

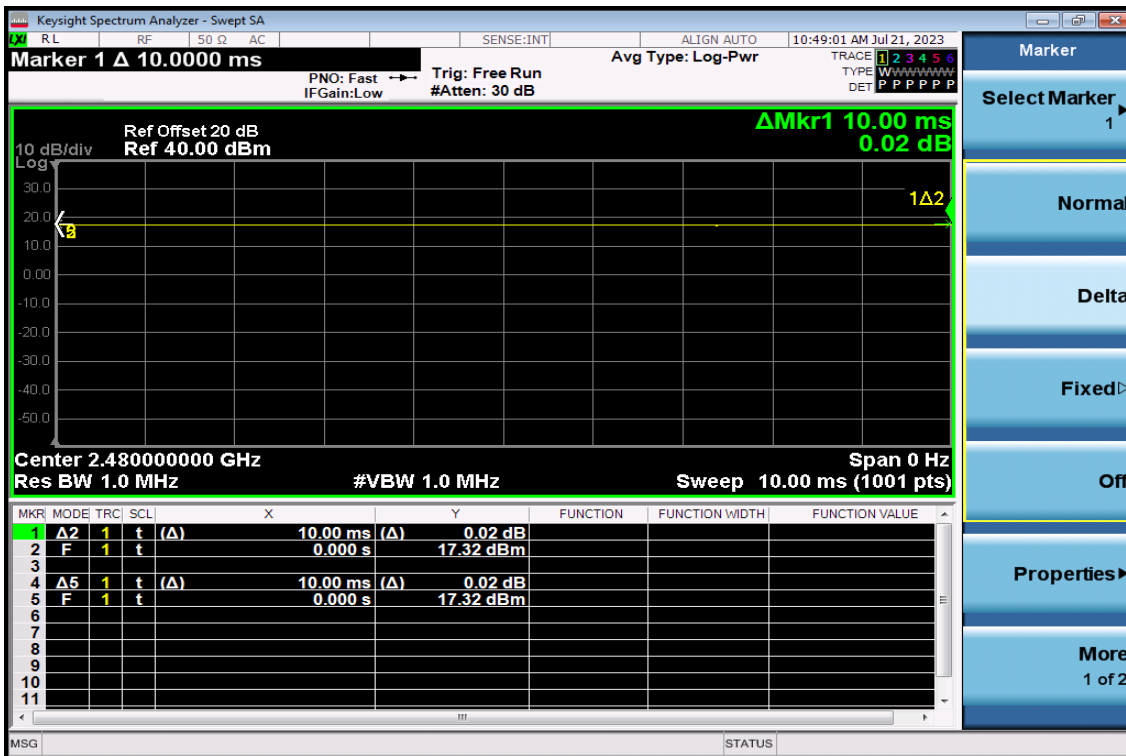

### 3. Summary of Test Results

FCC Rules	Description Of Test	Result
§15.207(a) RSS-Gen §8.8	AC Power Line Conducted Emission	Compliant
§15.247(b) (3), (4) RSS-247 issue 2, §5.4(4)	Peak Output Power/ EIRP	Compliant
§15.247(a)(2) RSS-247 issue 2, §5.2(1) RSS-Gen §6.6	6dB & 99% Power Bandwidth	Compliant
§15.247(d) RSS-247 issue 2, §5.5	100 kHz Bandwidth of Frequency Band Edges	Compliant
§15.247(d) RSS-247 issue 2, §5.5	Spurious Emission	Compliant
§15.247(e) RSS-247 issue 2, §5.2	Peak Power Density	Compliant
§15.203 RSS-GEN 8.3	Antenna Requirement	Compliant

### 4. Description of Test Modes

The EUT has been tested under engineering operating condition.

Test program used to control the EUT for staying in continuous transmitting mode is programmed.

BLE:

Channel low (2402MHz), mid (2442MHz), (2480MHz) with each modulation were chosen for full testing.

## 5. AC Line Conduced Emission Test

### 5.1 Standard Applicable

According to §15.207 and RSS-Gen §7.2.4, frequency range within 150kHz to 30MHz shall not exceed the Limit table as below.

Frequency range MHz	Limits dB(μV)	
	Quasi-peak	Average
0.15 to 0.50	66 to 56	56 to 46
0.50 to 5	56	46
5 to 30	60	50

Note

- 1.The lower limit shall apply at the transition frequencies
- 2.The limit decreases linearly with the logarithm of the frequency in the range 0.15 MHz to 0.50 MHz.

### 5.2 Measurement Procedure

1. The EUT was placed on a table which is 0.8m above ground plane.
2. Maximum procedure was performed on the six highest emissions to ensure EUT compliance.
3. Repeat above procedures until all frequency measured were complete.
4. Both 120V & 240V have been verified, and 120V/60Hz was defined as the worst-case and record in the report.

### 5.3 Measurement Result



Address: No. 120, Lane 180, Hsin Ho Rd., Lung-Tan Dist.,  
Tao Yuan City 325, Taiwan.  
Tel: 03-2638888

#### Conducted Emission Measurement

operator: Jason  
Temperature: 26 °C  
Humidity: 54 %

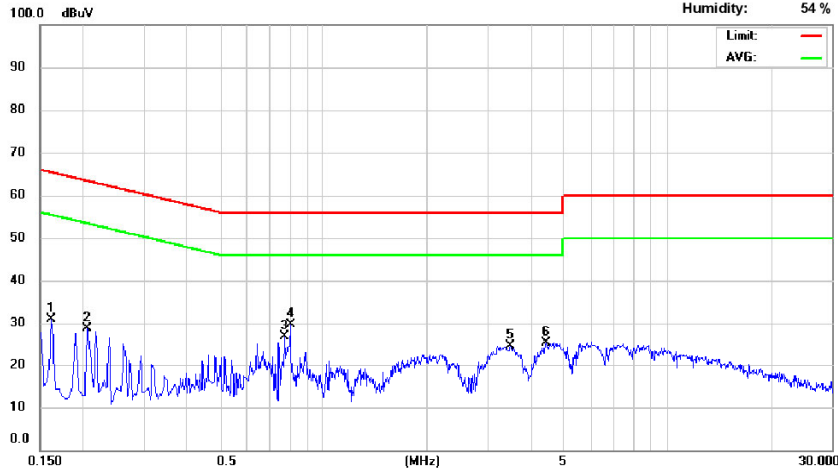

Site: Phase: **L1**

No.	Frequency (MHz)	QP_R (dBuV)	AVG_R (dBuV)	Correct Factor (dB)	QP Emission (dBuV)	QP Limit (dBuV)	QP Margin (dB)	AVG Emission (dBuV)	AVG Limit (dBuV)	AVG Margin (dB)
1	0.162	13.72	-1.97	9.70	23.42	65.36	-41.94	7.73	55.36	-47.63
2	0.206	10.56	-2.75	9.70	20.26	63.37	-43.11	6.95	53.37	-46.42
3	0.774	10.29	2.06	9.71	20.00	56.00	-36.00	11.77	46.00	-34.23
4	0.802	10.94	3.84	9.71	20.65	56.00	-35.35	13.55	46.00	-32.45
5	3.506	10.05	2.34	9.79	19.84	56.00	-36.16	12.13	46.00	-33.87
6	4.450	9.97	2.15	9.81	19.78	56.00	-36.22	11.96	46.00	-34.04

Note:

Margin = QP/AVG Emission - Limit

QP/AVG Emission = QP\_R/AVG\_R + Correct Factor

Correct Factor = LISN Loss + Cable Loss

The frequency spectrum graph is for final peak graph, and the attached table is for QP/AVG test result.

If peak data can pass, it will be shown in "QP/AVG Correct" column, if not, QP/AVG data will instead.



Address: No. 120, Lane 180, Hsin Ho Rd., Lung-Tan Dist.,  
Tao Yuan City 325, Taiwan.  
Tel: 03-2638888

Conducted Emission Measurement

operator: Jason  
Temperature: 26 °C  
Humidity: 54 %

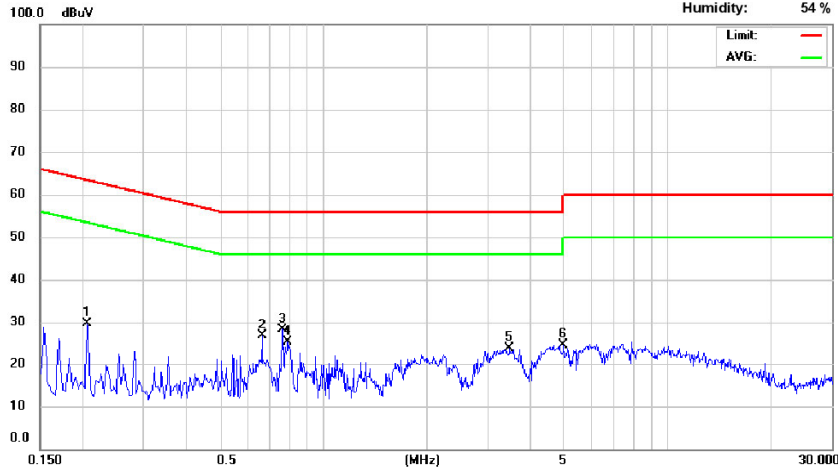

Site: Phase: N

No.	Frequency (MHz)	QP_R (dBuV)	AVG_R (dBuV)	Correct Factor (dB)	QP Emission (dBuV)	QP Limit (dBuV)	QP Margin (dB)	AVG Emission (dBuV)	AVG Limit (dBuV)	AVG Margin (dB)
1	0.206	10.25	-2.72	9.70	19.95	63.37	-43.42	6.98	53.37	-46.39
2	0.662	6.81	0.55	9.71	16.52	56.00	-39.48	10.26	46.00	-35.74
3	0.762	8.33	-0.77	9.71	18.04	56.00	-37.96	8.94	46.00	-37.06
4	0.790	11.76	3.90	9.71	21.47	56.00	-34.53	13.61	46.00	-32.39
5	3.482	8.90	1.46	9.79	18.69	56.00	-37.31	11.25	46.00	-34.75
6	4.982	8.47	0.58	9.82	18.29	56.00	-37.71	10.40	46.00	-35.60

Note:

Margin = QP/AVG Emission - Limit

QP/AVG Emission = QP\_R/AVG\_R + Correct Factor

Correct Factor = LISN Loss + Cable Loss

The frequency spectrum graph is for final peak graph, and the attached table is for QP/AVG test result.

If peak data can pass, it will be shown in "QP/AVG Correct" column, if not, QP/AVG data will instead.

## 6. Peak Output Power Measurement

### 6.1 Standard Applicable

According to §15.247

(3) For systems using digital modulation in the 902-928 MHz, 2400-2483.5 MHz, and 5725-5850 MHz bands: 1 Watt. As an alternative to a peak power measurement, compliance with the one Watt limit can be based on a measurement of the maximum conducted output power. Maximum Conducted Output Power is defined as the total transmit power delivered to all antennas and antenna elements averaged across all symbols in the signaling alphabet when the transmitter is operating at its maximum power control level. Power must be summed across all antennas and antenna elements. The average must not include any time intervals during which the transmitter is off or is transmitting at a reduced power level. If multiple modes of operation are possible (e.g., alternative modulation methods), the maximum conducted output power is the highest total transmit power occurring in any mode.

(4) The conducted output power limit specified in paragraph (b) of this section is based on the use of antennas with directional gains that do not exceed 6 dBi. Except as shown in paragraph (c) of this section, if transmitting antennas of directional gain greater than 6 dBi are used, the conducted output power from the intentional radiator shall be reduced below the stated values in paragraphs (b)(1), (b)(2), and (b)(3) of this section, as appropriate, by the amount in dB that the directional gain of the antenna exceeds 6 dBi.

(c) Operation with directional antenna gains greater than 6 dBi.

(1) Fixed point-to-point operation:

(i) Systems operating in the 2400-2483.5 MHz band that are used exclusively for fixed, point-to-point operations may employ transmitting antennas with directional gain greater than 6 dBi provided the maximum conducted output power of the intentional radiator is reduced by 1 dB for every 3 dB that the directional gain of the antenna exceeds 6 dBi.

(ii) Systems operating in the 5725-5850 MHz band that are used exclusively for fixed, point-to-point operations may employ transmitting antennas with directional gain greater than 6 dBi without any corresponding reduction in transmitter conducted output power.

According to RSS-247 issue 2, §5.4

(D)For DTSs employing digital modulation techniques operating in the bands 902-928 MHz and 2400-2483.5 MHz, the maximum peak conducted output power shall not exceed 1W. The e.i.r.p. shall not exceed 4 W, except as provided in section 5.4(e)

As an alternative to a peak power measurement, compliance can be based on a measurement of the maximum conducted output power. The maximum conducted output power is the total transmit power delivered to all antennas and antenna elements, averaged across all symbols in the signalling alphabet when the transmitter is operating at its maximum power control level. Power must be summed across all antennas and antenna elements. The average must not include any time intervals during which the transmitter is off or transmitting at a reduced power level. If multiple modes of operation are implemented, the maximum conducted output power is the highest total transmit power occurring in any mode.

### 6.2 Measurement Procedure

1. Place the EUT on the table and set it in transmitting mode.
2. Remove the antenna from the EUT and then connect a low loss RF cable from the antenna port to the power meter or spectrum analyzer with proper instrument's parameters.
3. Record the max. reading.
4. Repeat above procedures until all frequency measured were complete.

### 6.3 Measurement Result

Peak Power

Mode	Freq. (MHz)	Output Power (dBm)	Duty Factor (dB)	Total Output Power (dBm)	Output Power Limit (dBm)
BLE (1M)	2402	20.458	0	20.458	30
	2442	20.593	0	20.593	30
	2480	17.561	0	17.561	30

## 7. Radiated Spurious Emission Test

### 7.1 Standard Applicable

According to §15.247(d), all other emissions outside these bands shall not exceed the general radiated emission limits specified in §15.209(a). And according to §15.33(a)(1), for an intentional radiator operates below 10GHz, the frequency range of measurements: to the tenth harmonic of the highest fundamental frequency or to 40GHz, whichever is lower.

According to RSS-247 issue 2, §5.5

In any 100 kHz bandwidth outside the frequency band in which the spread spectrum or digitally modulated device is operating, the RF power that is produced shall be at least 20 dB below that in the 100 kHz bandwidth within the band that contains the highest level of the de-sired power, based on either an RF conducted or a radiated measurement, provided that the transmitter demonstrates compliance with the peak conducted power limits. If the transmitter complies with the conducted power limits based on the use of root-mean-square averaging over a time interval, as permitted under Section 5.4(d), the attenuation required shall be 30 dB instead of 20 dB. Attenuation below the general field strength limits specified in RSS-Gen is not required.

### 7.2 Measurement Procedure

1. The EUT was placed on a turn table which is 0.8m/1.5m above ground plane in 966 chamber.
2. The turn table shall rotate 360 degrees to determine the position of maximum emission level.
3. EUT is set 3m away from the receiving antenna which varied from 1m to 4m to find out the highest emissions.
4. When measurement procedures for electric field radiated emissions above 1 GHz the EUT measurement is to be made “while keeping the antenna in the ‘cone of radiation’ from that area and pointed at the area both in azimuth and elevation, with polarization oriented for maximum response.” is still within the 3dB illumination BW of the measurement antenna.
5. Maximum procedure was performed on the six highest emissions to ensure EUT compliance.
6. And also, each emission was to be maximized by changing the polarization of receiving antenna both horizontal and vertical.
7. Repeat above procedures until all frequency measured were complete.

Test receiver setting	:	Below 1GHz
Detector	:	Average (9kHz – 90kHz, 110kHz – 90kHz), Quasi-Peak
Bandwidth	:	200Hz, 120kHz
Test spectrum setting	:	Above 1GHz
Peak	:	RBW=1MHz, VBW≥3*RBW, Sweep=auto
Average	:	RBW=1MHz, VBW≥ 1/T <sub>on</sub> , Sweep=auto



### 7.3 Field Strength Calculation

The field strength is calculated by adding the Antenna Factor and Cable Factor and subtracting the Amplifier Gain and Duty Cycle Correction Factor (if any) from the measured reading. The basic equation with a sample calculation is as follows:

$$FS = RA + AF + CL - AG$$

Where	FS = Field Strength	CL = Cable Attenuation Factor (Cable Loss)
	RA = Reading Amplitude	AG = Amplifier Gain
	AF = Antenna Factor	

Remark:

<1GHz

1. No further spurious emissions detected from the lowest internal frequency and 30MHz.
2. Measuring frequencies from the lowest internal frequency to the 1GHz.
3. Radiated emissions measured in frequency range from 9kHz to 1000MHz were made with an instrument detector setting 9-90kHz/110-490kHz using PK/AV and other Frequency Band using PK/QP
4. Measurement result within this frequency range shown “ - ” in the table above means the reading of emissions are attenuated more than 20dB below the permissible limits or the field strength is too small to be measured.

>1GHz

- 5 Measuring frequencies from the lowest internal frequency to the 10th of fundamental frequency
- 6 Field strength limits for frequency above 1000MHz are based on average limits. However, Peak mode field strength shall not exceed the average limits specified plus 20dB.
- 7 Measurement of data within this frequency range shown “ - ” in the table above means the reading of emissions are attenuated more than 20dB below the permissible limits or the field strength is too small to be measured.

### 7.4 Measurement Result

#### 7.4.1 Radiated Spurious Emission Measurement Result (below 1GHz)

Test mode: Dipole Ant.

International Standard Laboratory Corp.  
Company Address: No.120, Lane 180, Hsin Ho Rd.  
Lung-Tan Dist., Tao Yuan City 325, Taiwan

Date: 2023-08-04

Project Number. : 23LR0074 Temp.(°C)/RH(%) : 24/63  
Test Mode : Tx Low Ch Tested by : Weitin Chen

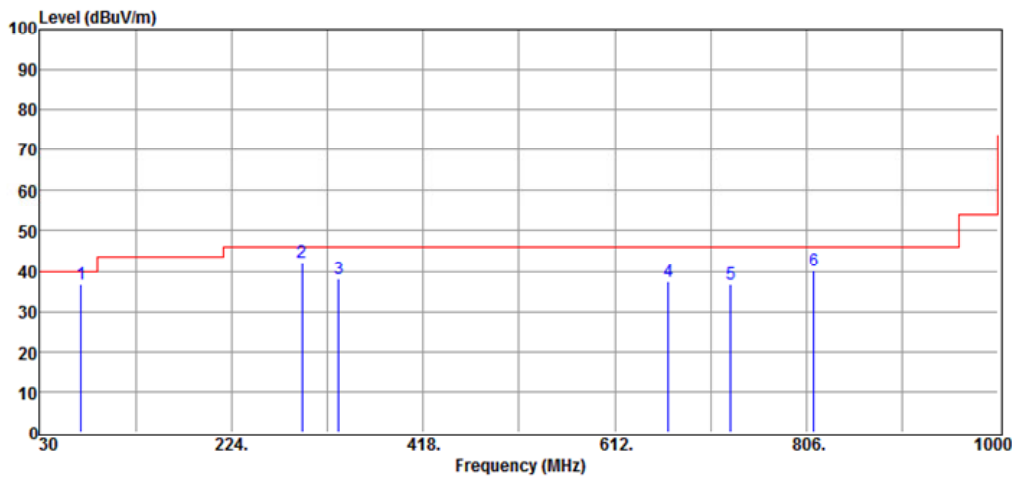

No	Freq MHz	Reading dBuV	Factor dB/m	Level dBuV/m	Limit dBuV/m	Margin dB	Remark	Pol V/H
1	71.71	44.74	-8.02	36.72	40.00	-3.28	Peak	VERTICAL
2	295.78	46.24	-4.11	42.13	46.00	-3.87	Peak	VERTICAL
3	332.64	41.40	-3.29	38.11	46.00	-7.89	Peak	VERTICAL
4	666.32	34.72	2.82	37.54	46.00	-8.46	Peak	VERTICAL
5	729.37	32.89	4.01	36.90	46.00	-9.10	Peak	VERTICAL
6	813.76	34.99	5.29	40.28	46.00	-5.72	Peak	VERTICAL

International Standard Laboratory Corp.  
Company Address: No.120, Lane 180, Hsin Ho Rd.  
Lung-Tan Dist., Tao Yuan City 325, Taiwan  
Date: 2023-08-04

Project Number. : 23LR0074 Temp.(°C)/RH(%) : 24/63  
Test Mode : Tx Low Ch Tested by : Weitin Chen

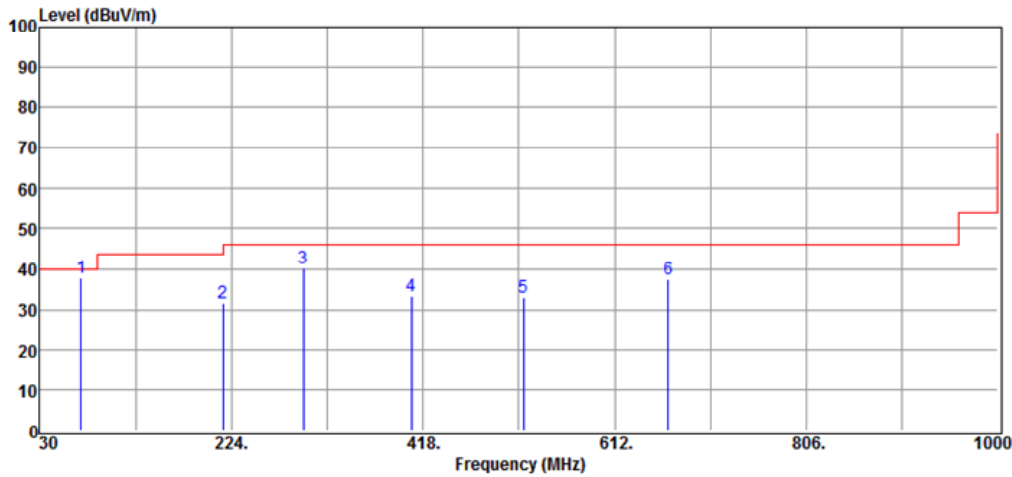

No	Freq MHz	Reading dBuV	Factor dB/m	Level dBuV/m	Limit dBuV/m	Margin dB	Remark	Pol V/H
1	71.71	45.97	-8.02	37.95	40.00	-2.05	Peak	HORIZONTAL
2	215.27	39.31	-7.68	31.63	43.50	-11.87	Peak	HORIZONTAL
3	296.75	44.41	-4.09	40.32	46.00	-5.68	Peak	HORIZONTAL
4	406.36	35.39	-2.07	33.32	46.00	-12.68	Peak	HORIZONTAL
5	519.85	32.84	0.02	32.86	46.00	-13.14	Peak	HORIZONTAL
6	666.32	34.68	2.82	37.50	46.00	-8.50	Peak	HORIZONTAL

International Standard Laboratory Corp.  
Company Address: No.120, Lane 180, Hsin Ho Rd.  
Lung-Tan Dist., Tao Yuan City 325, Taiwan

Date: 2023-08-04

Project Number. : 23LR0074 Temp.(°C)/RH(%) : 24/63  
Test Mode : Tx Mid Ch Tested by : Weitin Chen

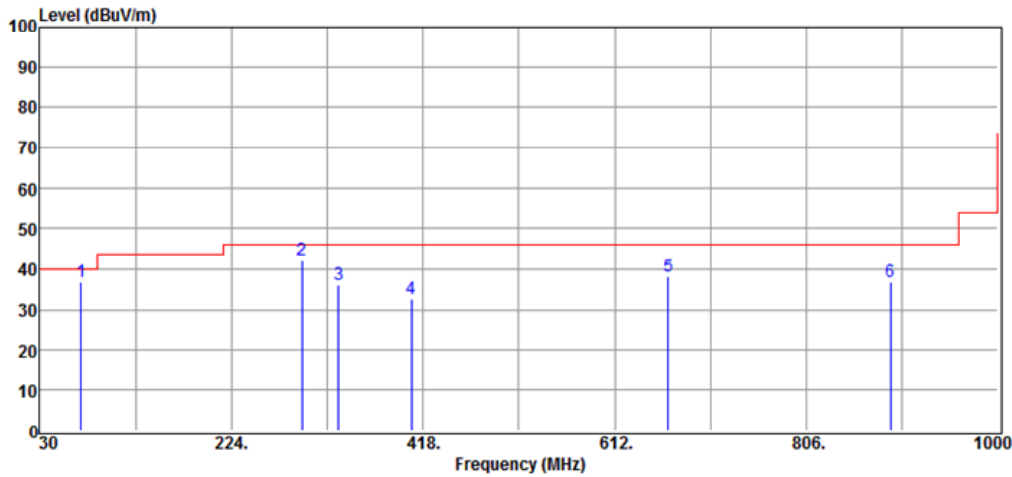

No	Freq MHz	Reading dBuV	Factor dB/m	Level dBuV/m	Limit dBuV/m	Margin dB	Remark	Pol V/H
1	71.71	44.79	-8.02	36.77	40.00	-3.23	Peak	VERTICAL
2	295.78	46.41	-4.11	42.30	46.00	-3.70	Peak	VERTICAL
3	332.64	39.28	-3.29	35.99	46.00	-10.01	Peak	VERTICAL
4	406.36	34.65	-2.07	32.58	46.00	-13.42	Peak	VERTICAL
5	666.32	35.19	2.82	38.01	46.00	-7.99	Peak	VERTICAL
6	891.36	30.54	6.20	36.74	46.00	-9.26	Peak	VERTICAL

International Standard Laboratory Corp.  
Company Address: No.120, Lane 180, Hsin Ho Rd.  
Lung-Tan Dist., Tao Yuan City 325, Taiwan  
Date: 2023-08-04

Project Number. : 23LR0074 Temp.(°C)/RH(%) : 24/63  
Test Mode : Tx Mid Ch Tested by : Weitin Chen

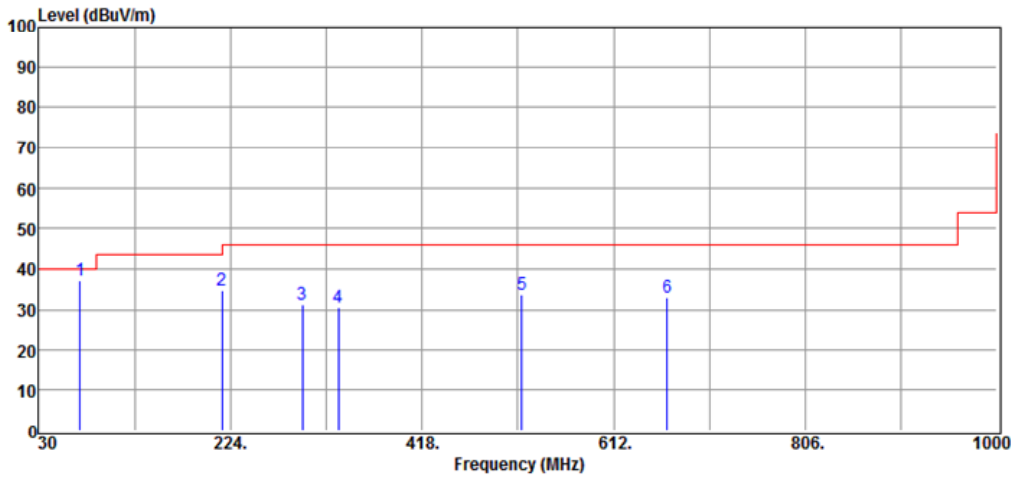

No	Freq MHz	Reading dBuV	Factor dB/m	Level dBuV/m	Limit dBuV/m	Margin dB	Remark	Pol V/H
1	71.71	45.01	-8.02	36.99	40.00	-3.01	Peak	HORIZONTAL
2	215.27	42.23	-7.68	34.55	43.50	-8.95	Peak	HORIZONTAL
3	296.75	35.40	-4.09	31.31	46.00	-14.69	Peak	HORIZONTAL
4	333.61	33.80	-3.29	30.51	46.00	-15.49	Peak	HORIZONTAL
5	518.88	33.77	0.00	33.77	46.00	-12.23	Peak	HORIZONTAL
6	666.32	30.13	2.82	32.95	46.00	-13.05	Peak	HORIZONTAL

International Standard Laboratory Corp.  
 Company Address: No.120, Lane 180, Hsin Ho Rd.  
 Lung-Tan Dist., Tao Yuan City 325, Taiwan  
 Date: 2023-08-04

Project Number. : 23LR0074 Temp.(°C)/RH(%) : 24/63  
 Test Mode : Tx High Ch Tested by : Weitin Chen

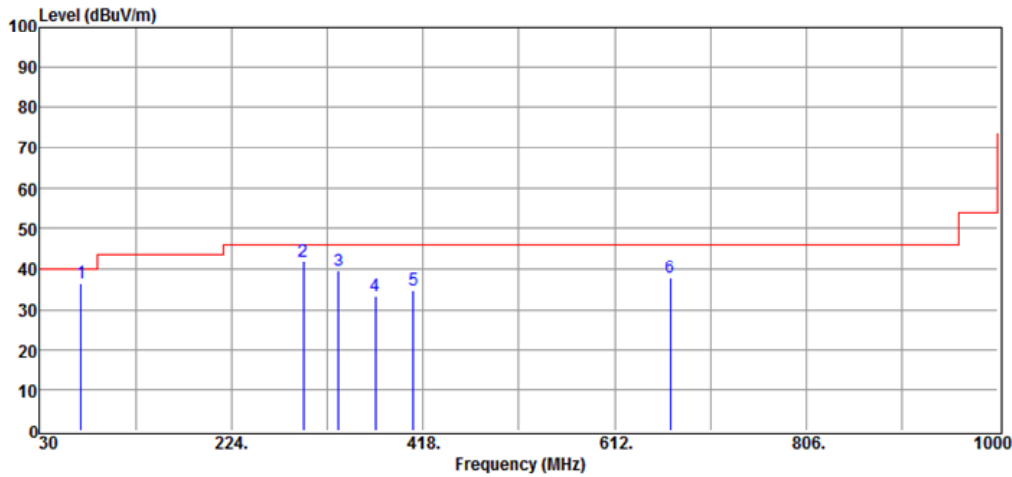

No	Freq MHz	Reading dBuV	Factor dB/m	Level dBuV/m	Limit dBuV/m	Margin dB	Remark	Pol V/H
1	71.71	44.32	-8.02	36.30	40.00	-3.70	Peak	VERTICAL
2	296.75	46.11	-4.09	42.02	46.00	-3.98	Peak	VERTICAL
3	332.64	42.76	-3.29	39.47	46.00	-6.53	Peak	VERTICAL
4	369.50	36.12	-2.81	33.31	46.00	-12.69	Peak	VERTICAL
5	408.30	36.56	-1.99	34.57	46.00	-11.43	Peak	VERTICAL
6	668.26	35.06	2.86	37.92	46.00	-8.08	Peak	VERTICAL

International Standard Laboratory Corp.  
Company Address: No.120, Lane 180, Hsin Ho Rd.  
Lung-Tan Dist., Tao Yuan City 325, Taiwan  
Date: 2023-08-04

Project Number. : 23LR0074 Temp.(°C)/RH(%) : 24/63  
Test Mode : Tx High Ch Tested by : Weitin Chen

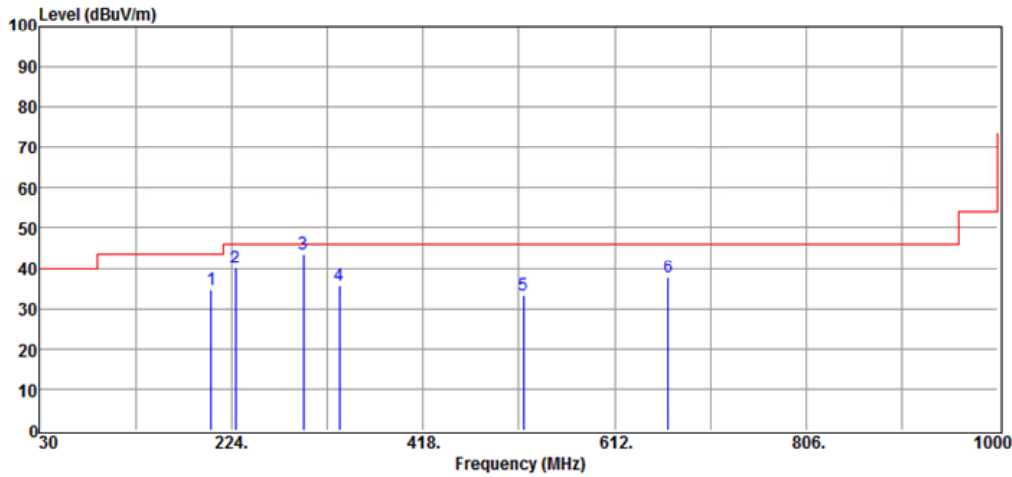

No	Freq MHz	Reading dBuV	Factor dB/m	Level dBuV/m	Limit dBuV/m	Margin dB	Remark	Pol V/H
1	203.63	42.47	-7.84	34.63	43.50	-8.87	Peak	HORIZONTAL
2	227.88	47.76	-7.62	40.14	46.00	-5.86	Peak	HORIZONTAL
3	296.75	47.76	-4.09	43.67	46.00	-2.33	Peak	HORIZONTAL
4	333.61	39.06	-3.29	35.77	46.00	-10.23	Peak	HORIZONTAL
5	519.85	33.38	0.02	33.40	46.00	-12.60	Peak	HORIZONTAL
6	666.32	34.90	2.82	37.72	46.00	-8.28	Peak	HORIZONTAL

Test mode: PCB Ant.

International Standard Laboratory Corp.  
Company Address: No.120, Lane 180, Hsin Ho Rd.  
Lung-Tan Dist., Tao Yuan City 325, Taiwan  
Date: 2023-08-04

Project Number. : 23LR0074 Temp.(°C)/RH(%) : 24/63  
Test Mode : Tx Low Ch Tested by : Weitin Chen

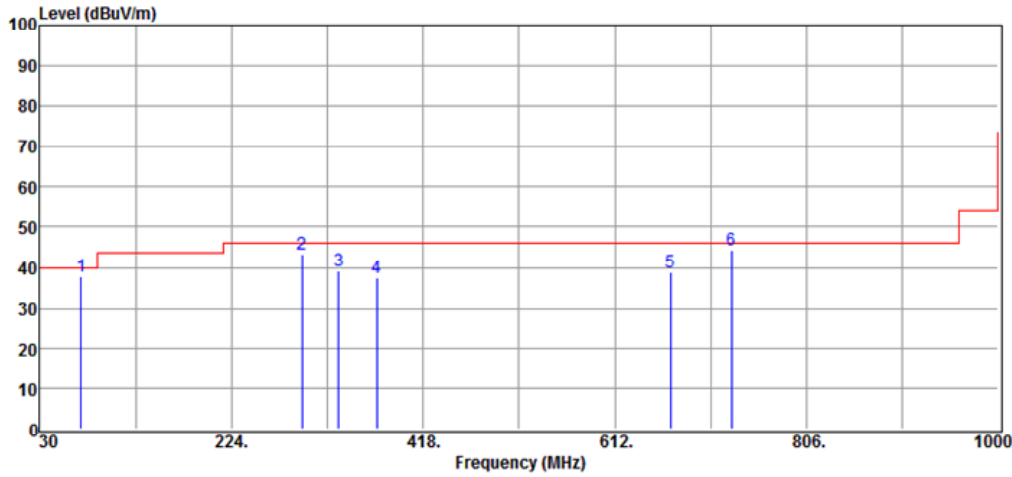

No	Freq MHz	Reading dBuV	Factor dB/m	Level dBuV/m	Limit dBuV/m	Margin dB	Remark	Pol V/H
1	71.71	45.86	-8.02	37.84	40.00	-2.16	Peak	VERTICAL
2	295.78	47.49	-4.11	43.38	46.00	-2.62	Peak	VERTICAL
3	332.64	42.49	-3.29	39.20	46.00	-6.80	Peak	VERTICAL
4	371.44	40.23	-2.71	37.52	46.00	-8.48	Peak	VERTICAL
5	668.26	35.96	2.86	38.82	46.00	-7.18	Peak	VERTICAL
6	730.34	40.42	4.05	44.47	46.00	-1.53	Peak	VERTICAL



International Standard Laboratory Corp.  
Company Address: No.120, Lane 180, Hsin Ho Rd.  
Lung-Tan Dist., Tao Yuan City 325, Taiwan  
Date: 2023-08-04

Project Number. : 23LR0074 Temp.(°C)/RH(%) : 24/63  
Test Mode : Tx Low Ch Tested by : Weitin Chen

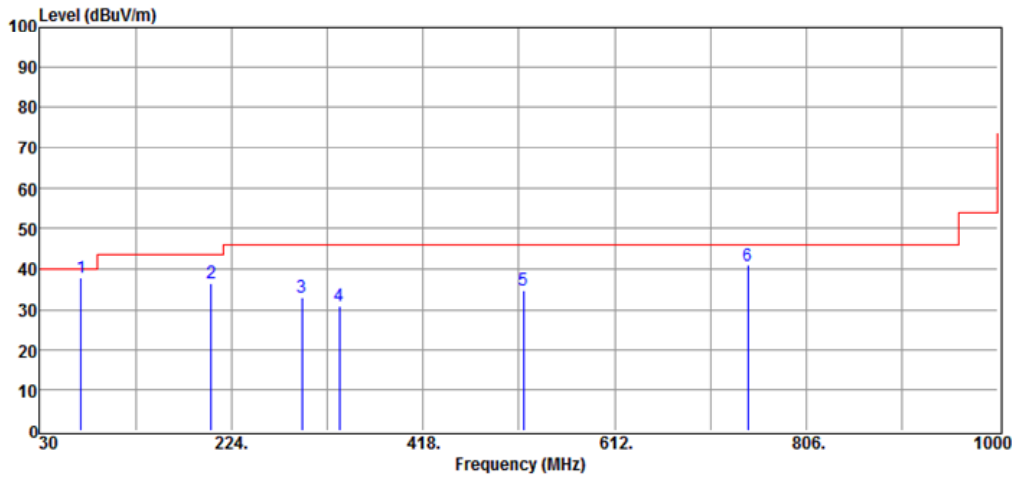

No	Freq MHz	Reading dBuV	Factor dB/m	Level dBuV/m	Limit dBuV/m	Margin dB	Remark	Pol V/H
1	71.71	45.87	-8.02	37.85	40.00	-2.15	Peak	HORIZONTAL
2	203.63	44.32	-7.84	36.48	43.50	-7.02	Peak	HORIZONTAL
3	295.78	37.26	-4.11	33.15	46.00	-12.85	Peak	HORIZONTAL
4	333.61	34.24	-3.29	30.95	46.00	-15.05	Peak	HORIZONTAL
5	519.85	34.61	0.02	34.63	46.00	-11.37	Peak	HORIZONTAL
6	746.83	36.20	4.56	40.76	46.00	-5.24	Peak	HORIZONTAL

International Standard Laboratory Corp.  
Company Address: No.120, Lane 180, Hsin Ho Rd.  
Lung-Tan Dist., Tao Yuan Ciy 325, Taiwan  
Date: 2023-08-04

Project Number. : 23LR0074 Temp.(°C)/RH(%) : 24/63  
Test Mode : Tx Mid Ch Tested by : Weitin Chen

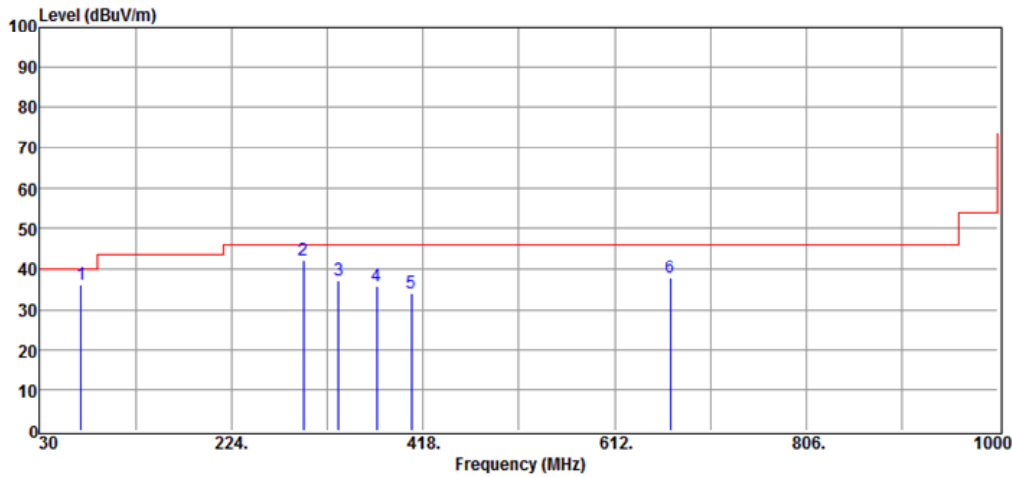

No	Freq MHz	Reading dBuV	Factor dB/m	Level dBuV/m	Limit dBuV/m	Margin dB	Remark	Pol V/H
1	71.71	44.21	-8.02	36.19	40.00	-3.81	Peak	VERTICAL
2	296.75	46.27	-4.09	42.18	46.00	-3.82	Peak	VERTICAL
3	332.64	40.38	-3.29	37.09	46.00	-8.91	Peak	VERTICAL
4	371.44	38.37	-2.71	35.66	46.00	-10.34	Peak	VERTICAL
5	406.36	36.09	-2.07	34.02	46.00	-11.98	Peak	VERTICAL
6	668.26	35.04	2.86	37.90	46.00	-8.10	Peak	VERTICAL

International Standard Laboratory Corp.  
 Company Address: No.120, Lane 180, Hsin Ho Rd.  
 Lung-Tan Dist., Tao Yuan City 325, Taiwan  
 Date: 2023-08-04

Project Number. : 23LR0074 Temp.(°C)/RH(%) : 24/63  
 Test Mode : Tx Mid Ch Tested by : Weitin Chen

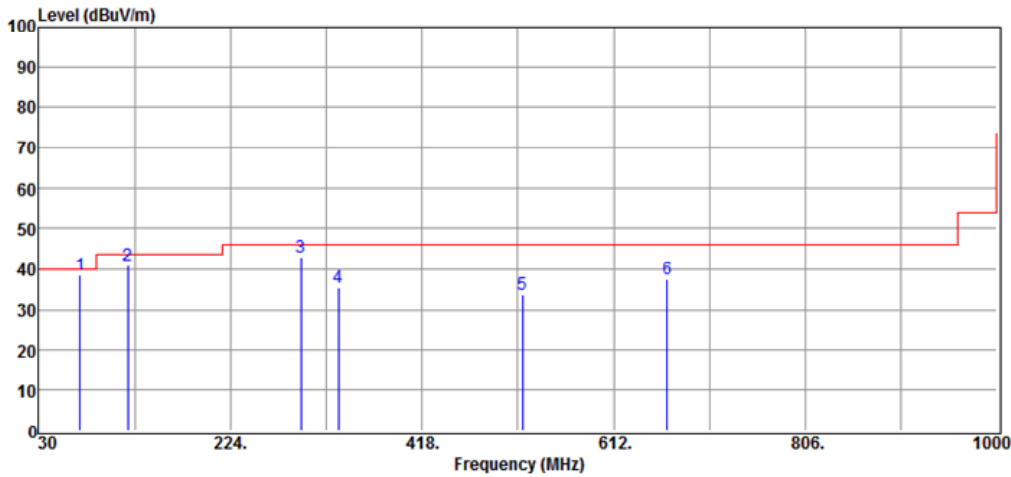

No	Freq MHz	Reading dBuV	Factor dB/m	Level dBuV/m	Limit dBuV/m	Margin dB	Remark	Pol V/H
1	71.71	46.47	-8.02	38.45	40.00	-1.55	Peak	HORIZONTAL
2	120.21	48.70	-7.67	41.03	43.50	-2.47	Peak	HORIZONTAL
3	295.78	47.02	-4.11	42.91	46.00	-3.09	Peak	HORIZONTAL
4	333.61	38.57	-3.29	35.28	46.00	-10.72	Peak	HORIZONTAL
5	519.85	33.77	0.02	33.79	46.00	-12.21	Peak	HORIZONTAL
6	666.32	34.67	2.82	37.49	46.00	-8.51	Peak	HORIZONTAL

International Standard Laboratory Corp.  
Company Address: No.120, Lane 180, Hsin Ho Rd.  
Lung-Tan Dist., Tao Yuan City 325, Taiwan  
Date: 2023-08-04

Project Number. : 23LR0074 Temp.(°C)/RH(%) : 24/63  
Test Mode : Tx High Ch Tested by : Weitin Chen

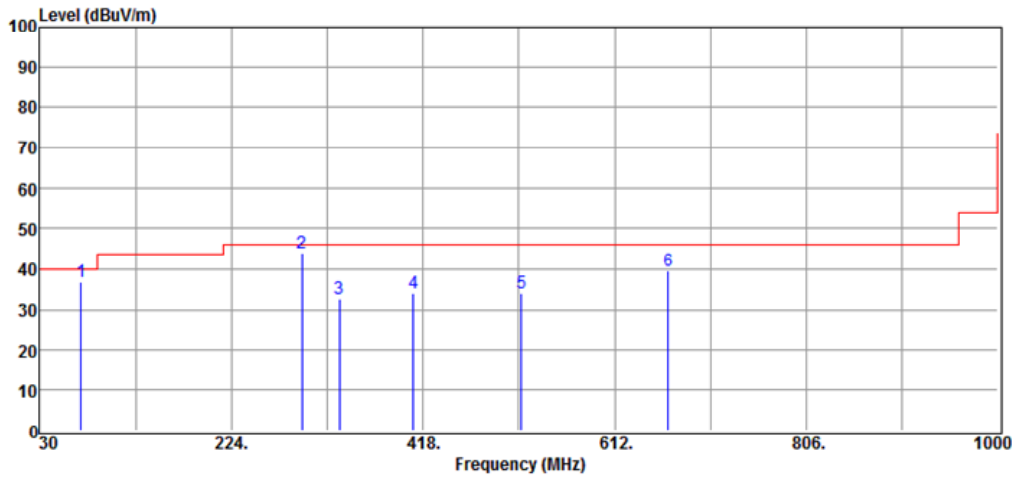

No	Freq MHz	Reading dBuV	Factor dB/m	Level dBuV/m	Limit dBuV/m	Margin dB	Remark	Pol V/H
1	71.71	44.75	-8.02	36.73	40.00	-3.27	Peak	VERTICAL
2	295.78	47.98	-4.11	43.87	46.00	-2.13	Peak	VERTICAL
3	333.61	35.91	-3.29	32.62	46.00	-13.38	Peak	VERTICAL
4	408.30	36.00	-1.99	34.01	46.00	-11.99	Peak	VERTICAL
5	517.91	33.88	-0.02	33.86	46.00	-12.14	Peak	VERTICAL
6	666.32	36.66	2.82	39.48	46.00	-6.52	Peak	VERTICAL

International Standard Laboratory Corp.  
Company Address: No.120, Lane 180, Hsin Ho Rd.  
Lung-Tan Dist., Tao Yuan City 325, Taiwan  
Date: 2023-08-04

Project Number. : 23LR0074 Temp.(°C)/RH(%) : 24/63  
Test Mode : Tx High Ch Tested by : Weitin Chen

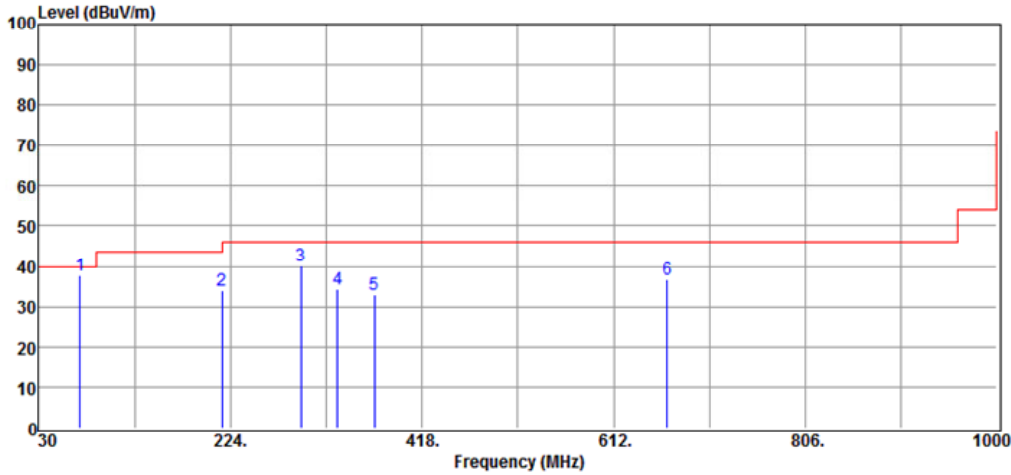

No	Freq MHz	Reading dBuV	Factor dB/m	Level dBuV/m	Limit dBuV/m	Margin dB	Remark	Pol V/H
1	71.71	45.88	-8.02	37.86	40.00	-2.14	Peak	HORIZONTAL
2	215.27	41.73	-7.68	34.05	43.50	-9.45	Peak	HORIZONTAL
3	295.78	44.21	-4.11	40.10	46.00	-5.90	Peak	HORIZONTAL
4	332.64	37.79	-3.29	34.50	46.00	-11.50	Peak	HORIZONTAL
5	369.50	35.88	-2.81	33.07	46.00	-12.93	Peak	HORIZONTAL
6	666.32	34.07	2.82	36.89	46.00	-9.11	Peak	HORIZONTAL

### 7.4.2 Radiated Spurious Emission Measurement Result (above1GHz)

Test mode: Dipole Ant.

International Standard Laboratory Corp.  
Company Address:No.120,Lane 180, Hsin Ho Rd.  
Lung-Tan Dist., Tao Yuan City 325, Taiwa  
Date: 2023-07-28

Project Number. : 23LR0074 Temp.(°C)/RH(%) : 24/63  
Test Mode : Tx Low Ch Tested by : Weitin Chen

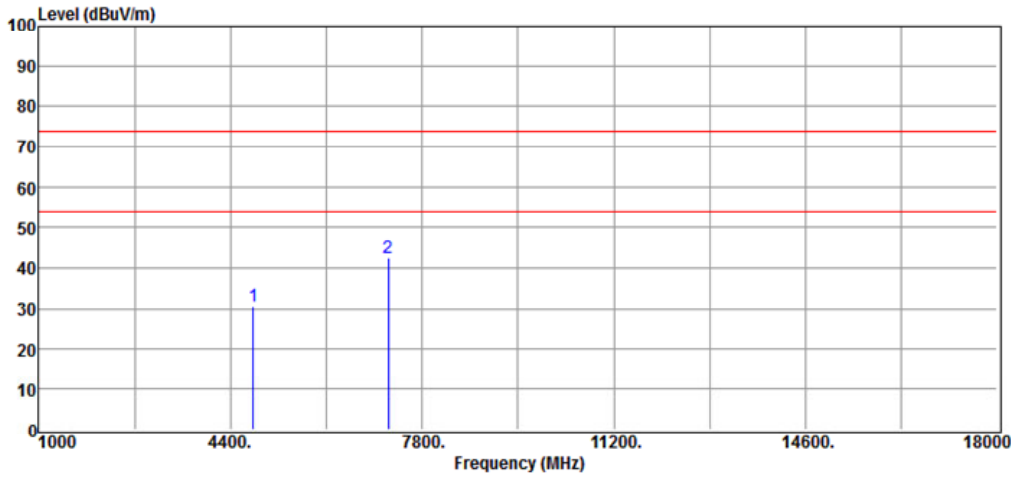

No	Freq MHz	Reading dBuV	Factor dB/m	Level dBuV/m	Limit dBuV/m	Margin dB	Remark	Pol V/H
1	4804.00	36.49	-5.75	30.74	74.00	-43.26	Peak	VERTICAL
2	7206.00	44.61	-2.16	42.45	74.00	-31.55	Peak	VERTICAL

International Standard Laboratory Corp.  
Company Address: No.120, Lane 180, Hsin Ho Rd.  
Lung-Tan Dist., Tao Yuan City 325, Taiwan  
Date: 2023-07-28

Project Number. : 23LR0074 Temp.(°C)/RH(%) : 24/63  
Test Mode : Tx Low Ch Tested by : Weitin Chen

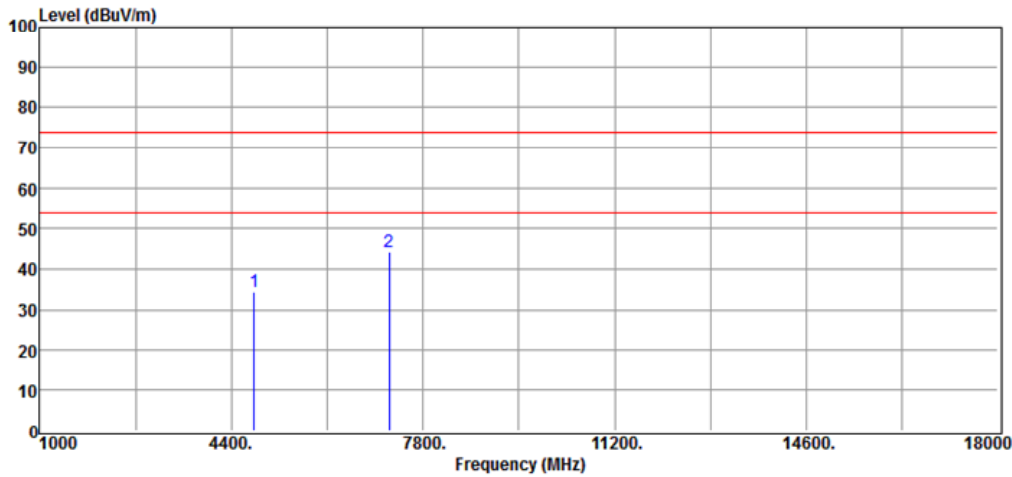

No	Freq MHz	Reading dBuV	Factor dB/m	Level dBuV/m	Limit dBuV/m	Margin dB	Remark	Pol V/H
1	4804.00	40.00	-5.75	34.25	74.00	-39.75	Peak	HORIZONTAL
2	7206.00	46.35	-2.16	44.19	74.00	-29.81	Peak	HORIZONTAL

International Standard Laboratory Corp.  
 Company Address: No.120, Lane 180, Hsin Ho Rd.  
 Lung-Tan Dist., Tao Yuan City 325, Taiwan  
 Date: 2023-07-28

Project Number. : 23LR0074 Temp.(°C)/RH(%) : 24/63  
 Test Mode : Tx Mid Ch Tested by : Weitin Chen

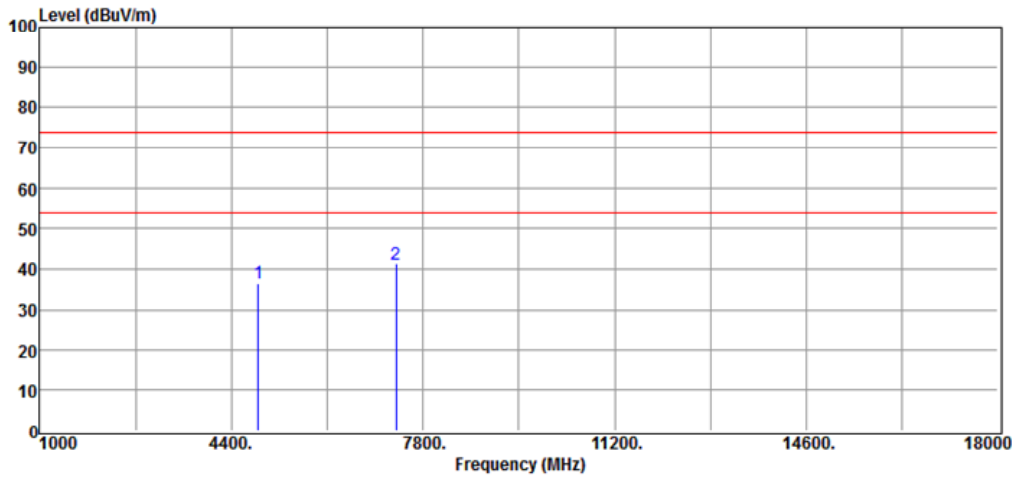

No	Freq MHz	Reading dBuV	Factor dB/m	Level dBuV/m	Limit dBuV/m	Margin dB	Remark	Pol V/H
1	4884.00	42.07	-5.67	36.40	74.00	-37.60	Peak	VERTICAL
2	7326.00	43.33	-1.99	41.34	74.00	-32.66	Peak	VERTICAL



International Standard Laboratory Corp.  
Company Address: No.120, Lane 180, Hsin Ho Rd.  
Lung-Tan Dist., Tao Yuan City 325, Taiwan  
Date: 2023-07-28

Project Number. : 23LR0074 Temp.(°C)/RH(%) : 24/63  
Test Mode : Tx Mid Ch Tested by : Weitin Chen

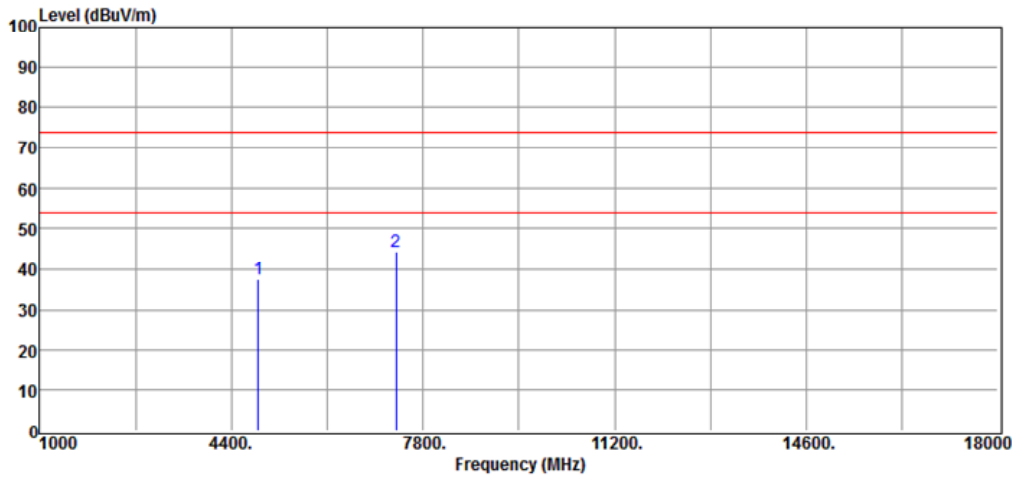

No	Freq MHz	Reading dBuV	Factor dB/m	Level dBuV/m	Limit dBuV/m	Margin dB	Remark	Pol V/H
1	4884.00	43.27	-5.67	37.60	74.00	-36.40	Peak	HORIZONTAL
2	7326.00	46.36	-1.99	44.37	74.00	-29.63	Peak	HORIZONTAL

International Standard Laboratory Corp.  
 Company Address: No.120, Lane 180, Hsin Ho Rd.  
 Lung-Tan Dist., Tao Yuan City 325, Taiwan  
 Date: 2023-07-28

Project Number. : 23LR0074 Temp.(°C)/RH(%) : 24/63  
 Test Mode : Tx High Ch Tested by : Weitin Chen

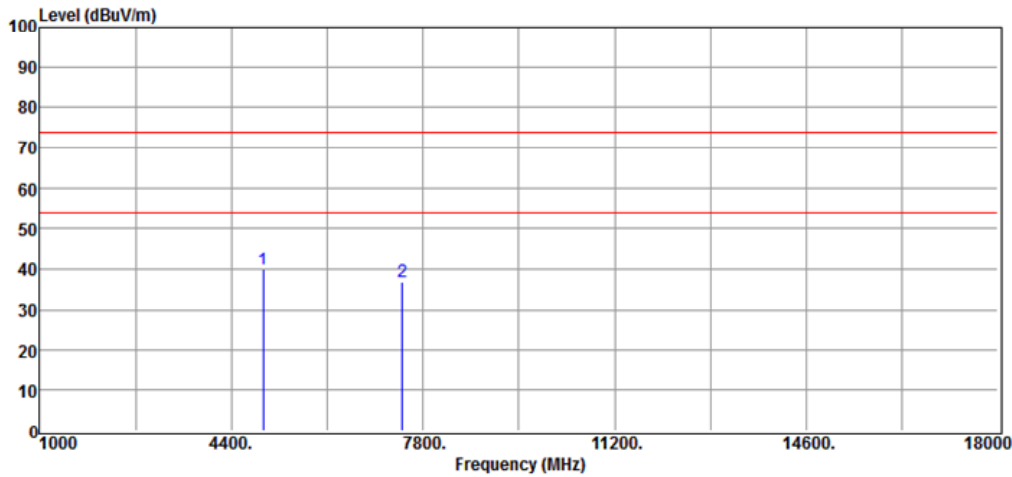

No	Freq MHz	Reading dBuV	Factor dB/m	Level dBuV/m	Limit dBuV/m	Margin dB	Remark	Pol V/H
1	4960.00	45.27	-5.47	39.80	74.00	-34.20	Peak	VERTICAL
2	7440.00	38.66	-1.99	36.67	74.00	-37.33	Peak	VERTICAL

International Standard Laboratory Corp.  
Company Address: No.120, Lane 180, Hsin Ho Rd.  
Lung-Tan Dist., Tao Yuan City 325, Taiwan  
Date: 2023-07-28

Project Number. : 23LR0074 Temp.(°C)/RH(%) : 24/63  
Test Mode : Tx High Ch Tested by : Weitin Chen

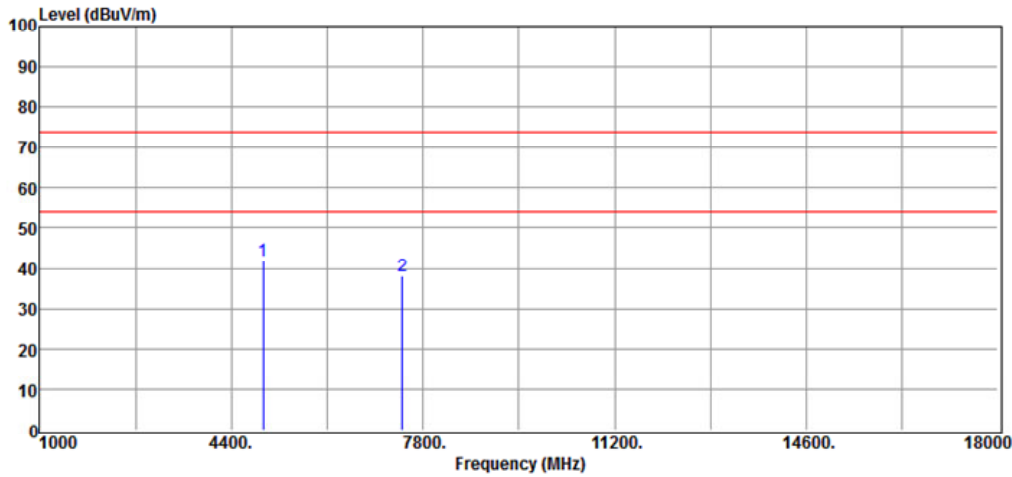

No	Freq MHz	Reading dBuV	Factor dB/m	Level dBuV/m	Limit dBuV/m	Margin dB	Remark	Pol V/H
1	4960.00	47.56	-5.47	42.09	74.00	-31.91	Peak	HORIZONTAL
2	7440.00	40.28	-1.99	38.29	74.00	-35.71	Peak	HORIZONTAL

**Test mode: PCB Ant.**

International Standard Laboratory Corp.  
Company Address: No.120, Lane 180, Hsin Ho Rd.  
Lung-Tan Dist., Tao Yuan City 325, Taiwan  
Date: 2023-07-28

Project Number. : 23LR0074 Temp.(°C)/RH(%) : 24/63  
Test Mode : Tx Low Ch Tested by : Weitin Chen

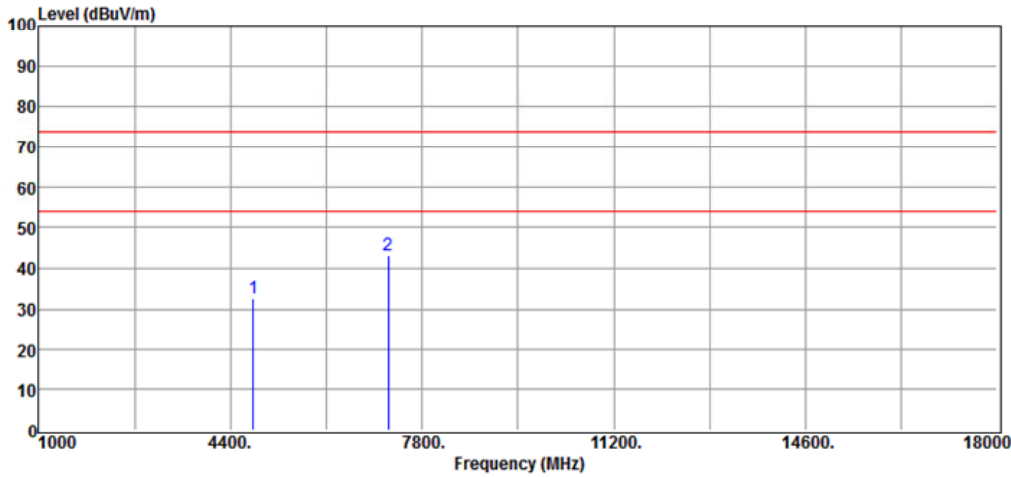

No	Freq MHz	Reading dBuV	Factor dB/m	Level dBuV/m	Limit dBuV/m	Margin dB	Remark	Pol V/H
1	4804.00	38.36	-5.75	32.61	74.00	-41.39	Peak	VERTICAL
2	7206.00	45.35	-2.16	43.19	74.00	-30.81	Peak	VERTICAL

International Standard Laboratory Corp.  
 Company Address: No.120, Lane 180, Hsin Ho Rd.  
 Lung-Tan Dist., Tao Yuan City 325, Taiwan  
 Date: 2023-07-28

Project Number. : 23LR0074 Temp.(°C)/RH(%) : 24/63  
 Test Mode : Tx Low Ch Tested by : Weitin Chen

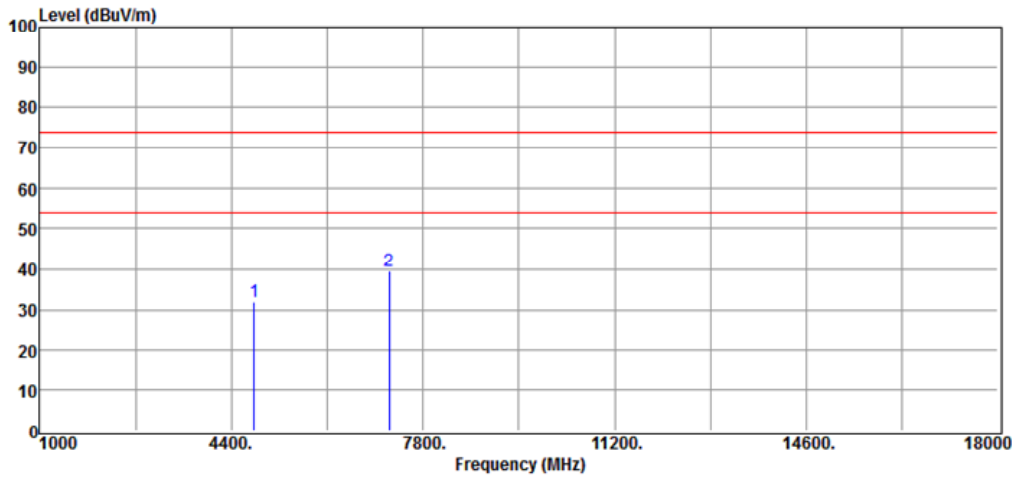

No	Freq MHz	Reading dBuV	Factor dB/m	Level dBuV/m	Limit dBuV/m	Margin dB	Remark	Pol V/H
1	4804.00	37.77	-5.75	32.02	74.00	-41.98	Peak	HORIZONTAL
2	7206.00	41.74	-2.16	39.58	74.00	-34.42	Peak	HORIZONTAL

International Standard Laboratory Corp.  
 Company Address: No.120, Lane 180, Hsin Ho Rd.  
 Lung-Tan Dist., Tao Yuan City 325, Taiwan  
 Date: 2023-07-28

Project Number. : 23LR0074 Temp.(°C)/RH(%) : 24/63  
 Test Mode : Tx Mid Ch Tested by : Weitin Chen

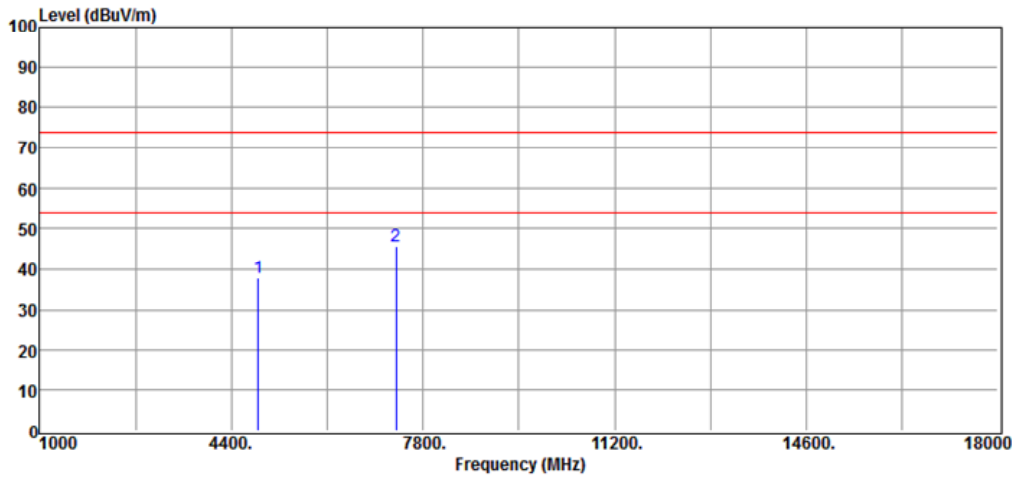

No	Freq MHz	Reading dBuV	Factor dB/m	Level dBuV/m	Limit dBuV/m	Margin dB	Remark	Pol V/H
1	4884.00	43.58	-5.67	37.91	74.00	-36.09	Peak	VERTICAL
2	7326.00	47.66	-1.99	45.67	74.00	-28.33	Peak	VERTICAL

International Standard Laboratory Corp.  
Company Address: No.120, Lane 180, Hsin Ho Rd.  
Lung-Tan Dist., Tao Yuan City 325, Taiwan  
Date: 2023-07-28

Project Number. : 23LR0074 Temp.(°C)/RH(%) : 24/63  
Test Mode : Tx Mid Ch Tested by : Weitin Chen

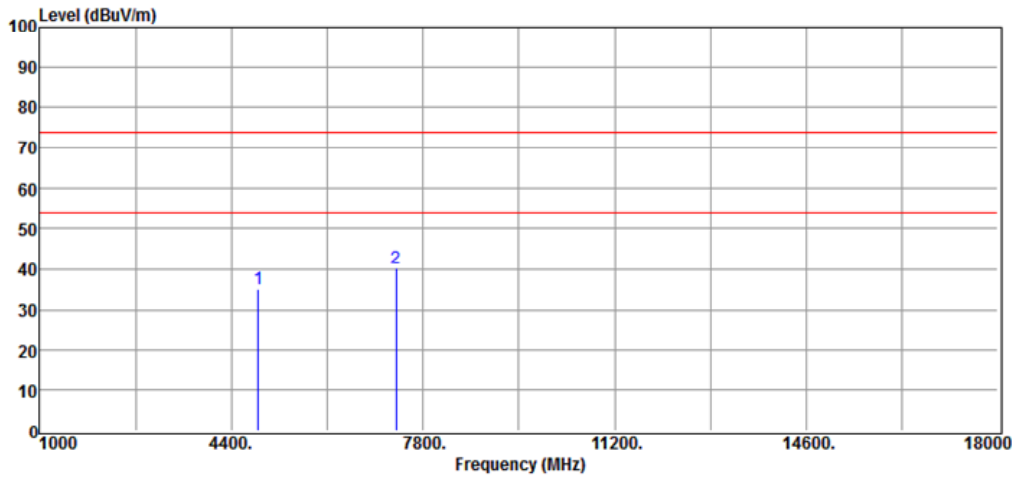

No	Freq MHz	Reading dBuV	Factor dB/m	Level dBuV/m	Limit dBuV/m	Margin dB	Remark	Pol V/H
1	4884.00	40.79	-5.67	35.12	74.00	-38.88	Peak	HORIZONTAL
2	7326.00	42.33	-1.99	40.34	74.00	-33.66	Peak	HORIZONTAL

International Standard Laboratory Corp.  
 Company Address: No.120, Lane 180, Hsin Ho Rd.  
 Lung-Tan Dist., Tao Yuan City 325, Taiwan  
 Date: 2023-07-28

Project Number. : 23LR0074 Temp.(°C)/RH(%) : 24/63  
 Test Mode : Tx High Ch Tested by : Weitin Chen

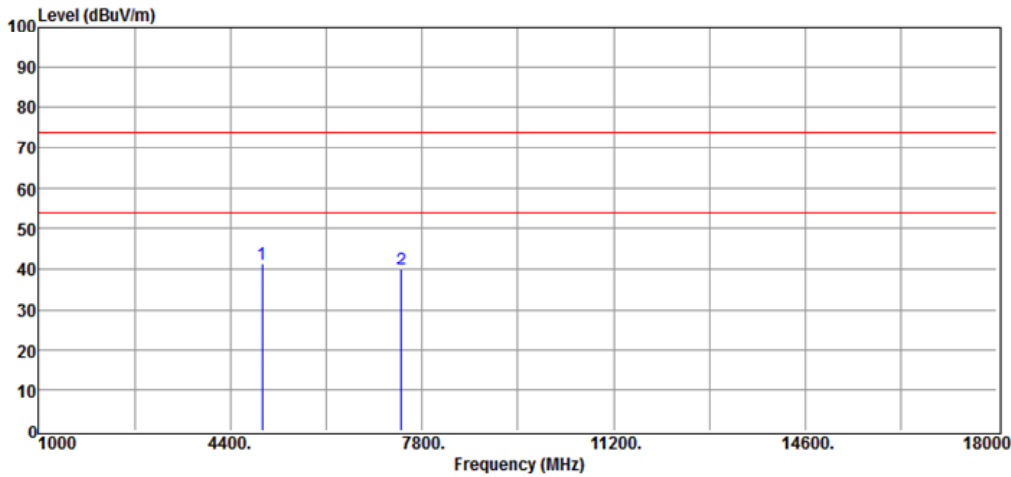

No	Freq MHz	Reading dBuV	Factor dB/m	Level dBuV/m	Limit dBuV/m	Margin dB	Remark	Pol V/H
1	4960.00	46.70	-5.47	41.23	74.00	-32.77	Peak	VERTICAL
2	7440.00	42.01	-1.99	40.02	74.00	-33.98	Peak	VERTICAL



International Standard Laboratory Corp.  
 Company Address: No.120, Lane 180, Hsin Ho Rd.  
 Lung-Tan Dist., Tao Yuan City 325, Taiwan  
 Date: 2023-07-28

Project Number. : 23LR0074 Temp.(°C)/RH(%) : 24/63  
 Test Mode : Tx High Ch Tested by : Weitin Chen

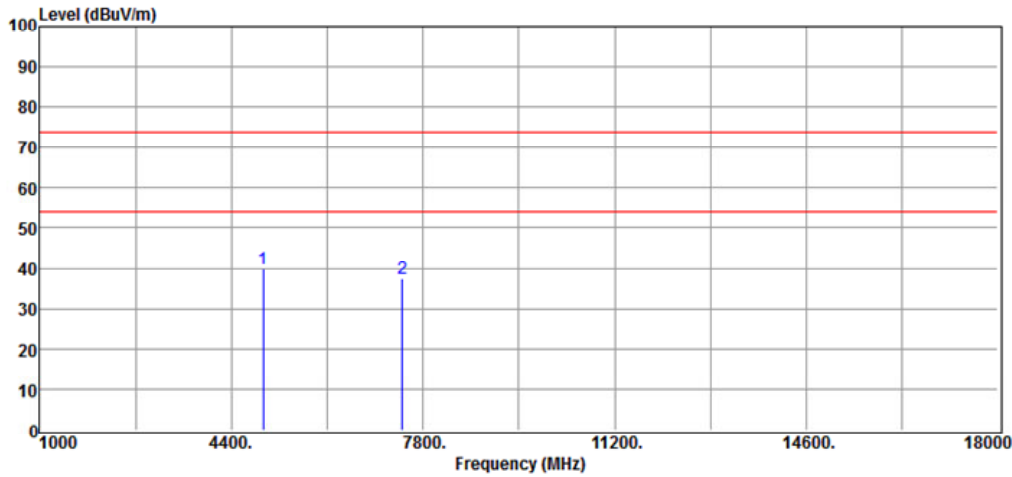

No	Freq MHz	Reading dBuV	Factor dB/m	Level dBuV/m	Limit dBuV/m	Margin dB	Remark	Pol V/H
1	4960.00	45.25	-5.47	39.78	74.00	-34.22	Peak	HORIZONTAL
2	7440.00	39.39	-1.99	37.40	74.00	-36.60	Peak	HORIZONTAL

## 8. 100kHz Bandwidth of Band Edges Measurement

### 8.1 Standard Applicable

According to §15.247(d), in any 100 kHz bandwidth outside the frequency bands in which the spread spectrum intentional radiator is operating, the radio frequency power that is produced by the intentional radiator shall be at least 20dB below that in the 100kHz bandwidth within the band that contains the highest level of the desired power, In addition, radiated emissions which fall in the restricted bands, as defined in §15.205(a), must also comply with the radiated emission limits specified in 15.209(a).

According to RSS-247 issue 2, §5.5

In any 100 kHz bandwidth outside the frequency band in which the spread spectrum or digitally modulated device is operating, the RF power that is produced shall be at least 20 dB below that in the 100 kHz bandwidth within the band that contains the highest level of the de-sired power, based on either an RF conducted or a radiated measurement, provided that the transmitter demonstrates compliance with the peak conducted power limits. If the transmitter complies with the conducted power limits based on the use of root-mean-square averaging over a time interval, as permitted under Section 5.4(d), the attenuation required shall be 30 dB instead of 20dB. Attenuation below the general field strength limits specified in RSS-Gen is not required.

### 8.2 Measurement Procedure

1. Place the EUT on the table and set it in transmitting mode.
2. Remove the antenna from the EUT and then connect a low loss RF cable from the antenna port to the spectrum analyzer.
3. Set center frequency of spectrum analyzer = operating frequency.
4. Set the spectrum analyzer as RBW=1MHz, VBW≥3\*RBW (for Peak); VBW≥1/T<sub>on</sub> (for Average), Sweep = auto.
5. Mark Peak, 2.390GHz and 2.4835GHz and record the max. level.
6. Repeat above procedures until all frequency measured were complete.

### 8.3 Field Strength Calculation

The field strength is calculated by adding the Antenna Factor and Cable Factor and subtracting the Amplifier Gain and Duty Cycle Correction Factor (if any) from the measured reading. The basic equation with a sample calculation is as follows:

$$FS = RA + AF + CL - AG$$

Where	FS = Field Strength	CL = Cable Attenuation Factor (Cable Loss)
	RA = Reading Amplitude	AG = Amplifier Gain
	AF = Antenna Factor	

### 8.4 Measurement Result

Test mode: Dipole Ant.

International Standard Laboratory Corp.  
 Company Address: No.120, Lane 180, Hsin Ho Rd.  
 Lung-Tan Dist., Tao Yuan City 325, Taiwan

Date: 2023-07-28

Project Number. : 23LR0074 Temp.(°C)/RH(%) : 24/63  
 Test Mode : Bandedge Low Ch Tested by : Weitin Chen

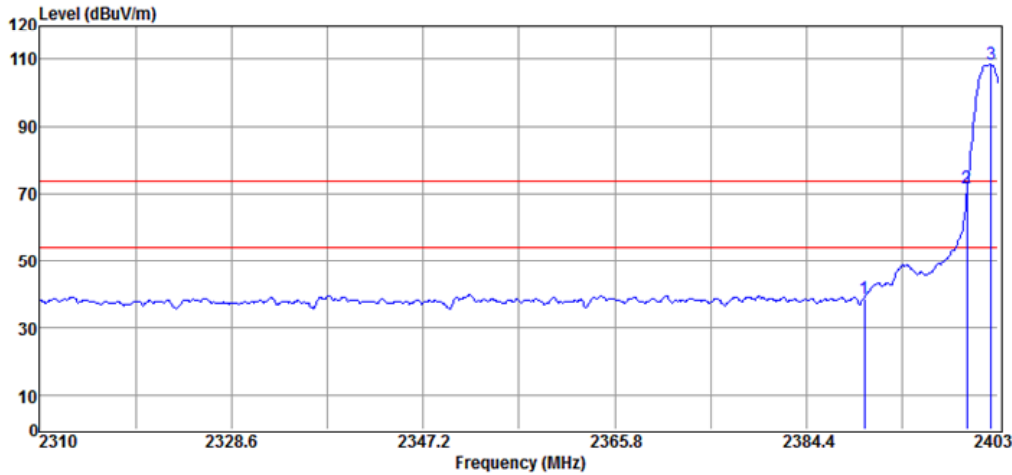

No	Freq MHz	Reading dBuV	Factor dB/m	Level dBuV/m	Limit dBuV/m	Margin dB	Remark	Pol V/H
1	2390.00	49.61	-10.77	38.84	74.00	-35.16	Peak	VERTICAL
2	2400.00	82.63	-10.70	71.93	88.43	-16.50	Peak	VERTICAL
3	2402.35	119.13	-10.70	108.43	F	--	Peak	VERTICAL

Note: "F" denotes fundamental frequency.

International Standard Laboratory Corp.  
Company Address: No.120, Lane 180, Hsin Ho Rd.  
Lung-Tan Dist., Tao Yuan City 325, Taiwan  
Date: 2023-07-28

Project Number. : 23LR0074 Temp.(°C)/RH(%) : 24/63  
Test Mode : Bandedge Low Ch Tested by : Weitin Chen

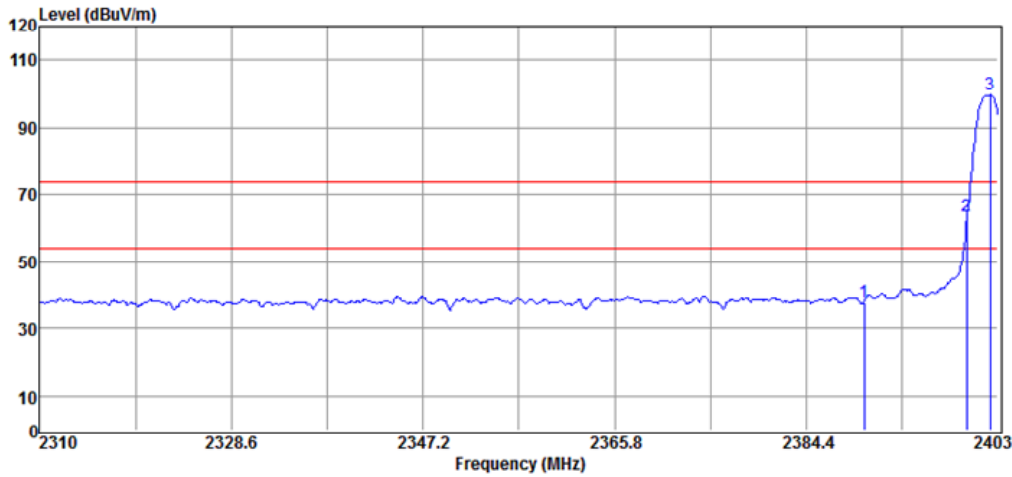

No	Freq MHz	Reading dBuV	Factor dB/m	Level dBuV/m	Limit dBuV/m	Margin dB	Remark	Pol V/H
1	2390.00	48.89	-10.77	38.12	74.00	-35.88	Peak	HORIZONTAL
2	2400.00	74.08	-10.70	63.38	79.63	-16.25	Peak	HORIZONTAL
3	2402.26	110.33	-10.70	99.63	F	--	Peak	HORIZONTAL

Note: "F" denotes fundamental frequency.

International Standard Laboratory Corp.  
Company Address: No.120, Lane 180, Hsin Ho Rd.  
Lung-Tan Dist., Tao Yuan City 325, Taiwan  
Date: 2023-07-28

Project Number. : 23LR0074 Temp.(°C)/RH(%) : 24/63  
Test Mode : Bandedge High Ch Tested by : Weitin Chen

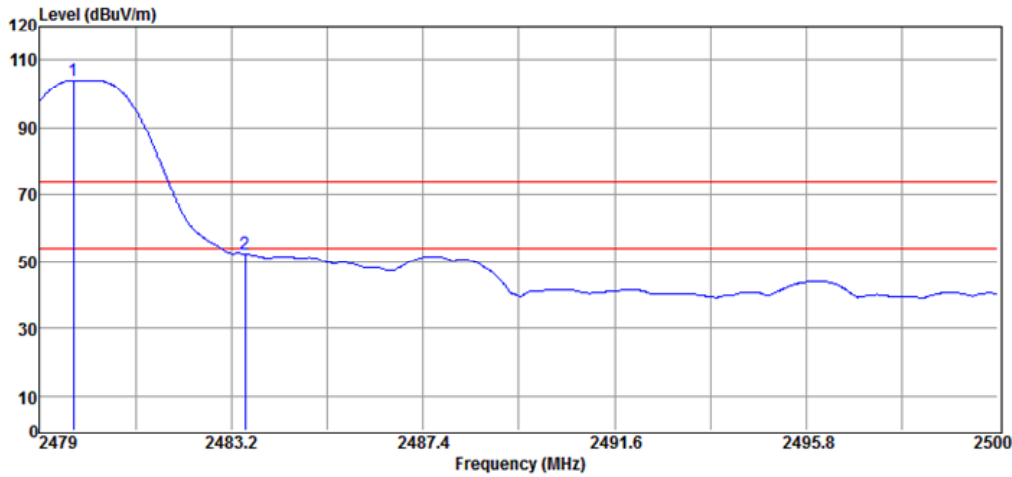

No	Freq MHz	Reading dBuV	Factor dB/m	Level dBuV/m	Limit dBuV/m	Margin dB	Remark	Pol V/H
1	2479.74	114.45	-10.41	104.04	F	--	Peak	VERTICAL
2	2483.50	62.84	-10.39	52.45	74.00	-21.55	Peak	VERTICAL

Note: "F" denotes fundamental frequency.

International Standard Laboratory Corp.  
Company Address: No.120, Lane 180, Hsin Ho Rd.  
Lung-Tan Dist., Tao Yuan City 325, Taiwan  
Date: 2023-07-28

Project Number. : 23LR0074 Temp.(°C)/RH(%) : 24/63  
Test Mode : Bandedge High Ch Tested by : Weitin Chen

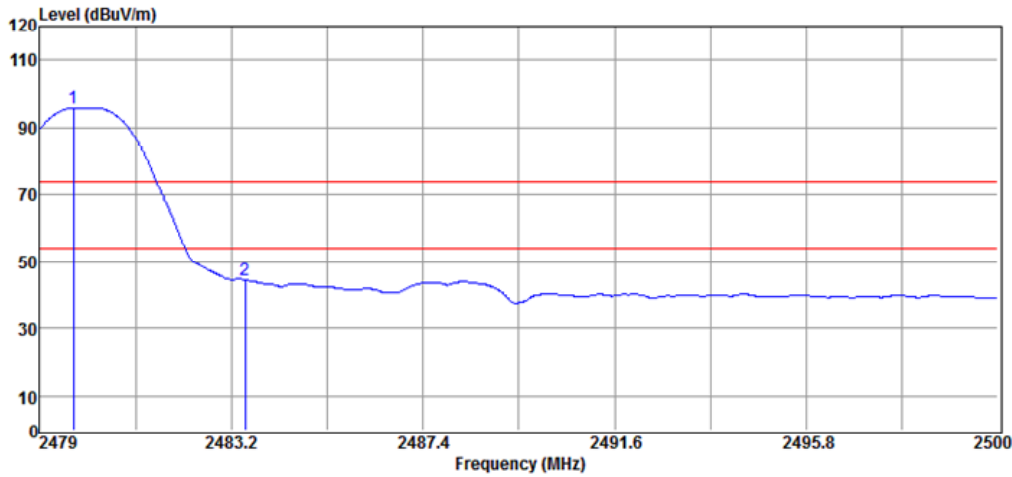

No	Freq MHz	Reading dBuV	Factor dB/m	Level dBuV/m	Limit dBuV/m	Margin dB	Remark	Pol V/H
1	2479.74	106.17	-10.41	95.76	F	--	Peak	HORIZONTAL
2	2483.50	55.04	-10.39	44.65	74.00	-29.35	Peak	HORIZONTAL

Note: "F" denotes fundamental frequency.

**Test mode: PCB Ant.**

International Standard Laboratory Corp.  
 Company Address: No.120, Lane 180, Hsin Ho Rd.  
 Lung-Tan Dist., Tao Yuan City 325, Taiwan

Date: 2023-07-28

Project Number. : 23LR0074 Temp.(°C)/RH(%) : 24/63  
 Test Mode : Bandedge Low Ch Tested by : Weitin Chen

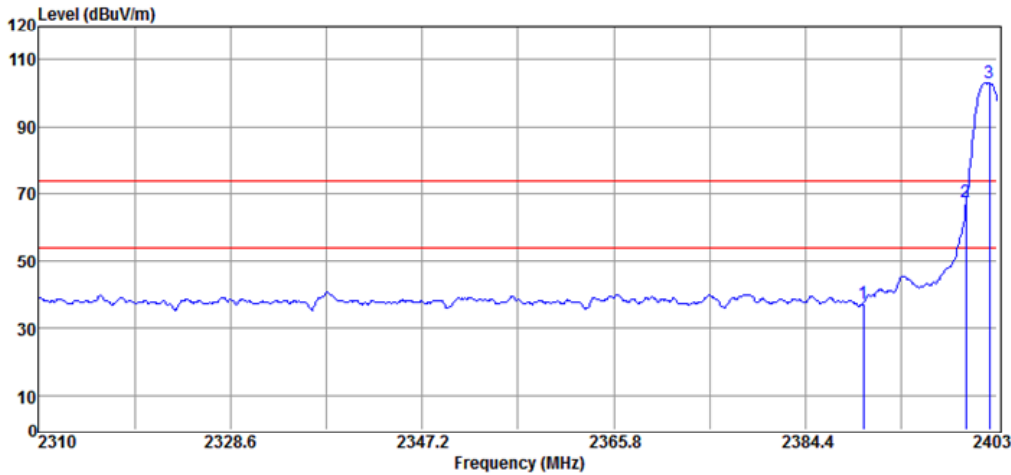

No	Freq MHz	Reading dBuV	Factor dB/m	Level dBuV/m	Limit dBuV/m	Margin dB	Remark	Pol V/H
1	2390.00	48.21	-10.77	37.44	74.00	-36.56	Peak	VERTICAL
2	2400.00	78.36	-10.70	67.66	83.07	-15.41	Peak	VERTICAL
3	2402.26	113.77	-10.70	103.07	F	--	Peak	VERTICAL

Note: "F" denotes fundamental frequency.

International Standard Laboratory Corp.  
Company Address: No.120, Lane 180, Hsin Ho Rd.  
Lung-Tan Dist., Tao Yuan City 325, Taiwan  
Date: 2023-07-28

Project Number. : 23LR0074 Temp.(°C)/RH(%) : 24/63  
Test Mode : Bandedge Low Ch Tested by : Weitin Chen

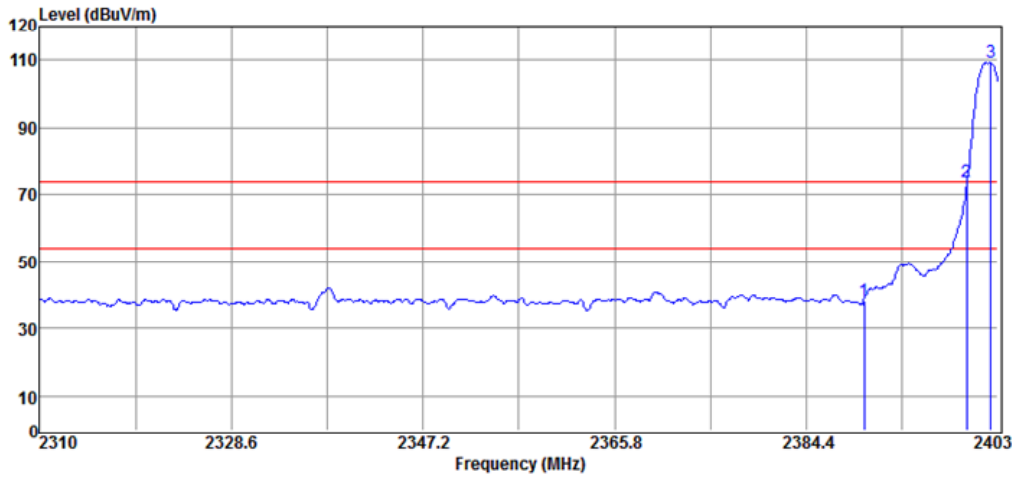

No	Freq MHz	Reading dBuV	Factor dB/m	Level dBuV/m	Limit dBuV/m	Margin dB	Remark	Pol V/H
1	2390.00	49.10	-10.77	38.33	74.00	-35.67	Peak	HORIZONTAL
2	2400.00	84.34	-10.70	73.64	89.21	-15.57	Peak	HORIZONTAL
3	2402.35	119.91	-10.70	109.21	F	--	Peak	HORIZONTAL

Note: "F" denotes fundamental frequency.



International Standard Laboratory Corp.  
Company Address: No.120, Lane 180, Hsin Ho Rd.  
Lung-Tan Dist., Tao Yuan City 325, Taiwan  
Date: 2023-07-28

Project Number. : 23LR0074 Temp.(°C)/RH(%) : 24/63  
Test Mode : Bandedge High Ch Tested by : Weitin Chen

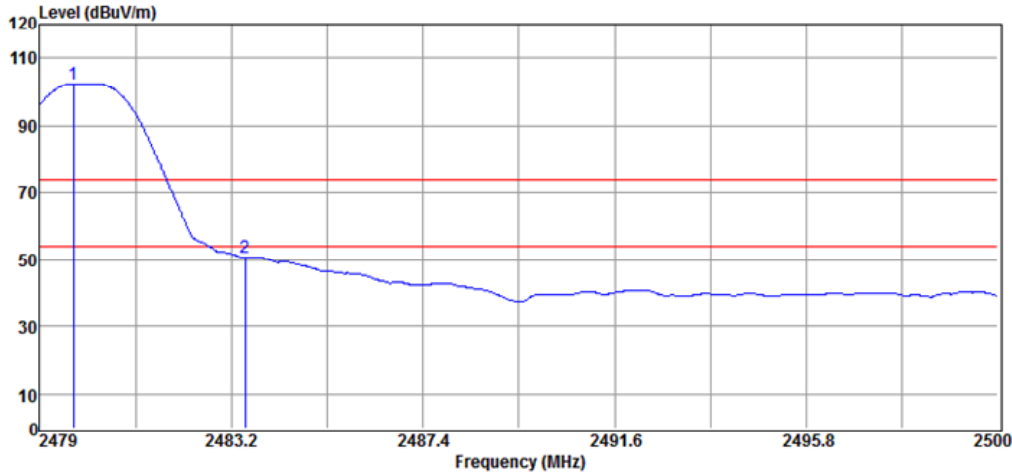

No	Freq MHz	Reading dBuV	Factor dB/m	Level dBuV/m	Limit dBuV/m	Margin dB	Remark	Pol V/H
1	2479.74	112.80	-10.41	102.39	F	--	Peak	VERTICAL
2	2483.50	61.01	-10.39	50.62	74.00	-23.38	Peak	VERTICAL

Note: "F" denotes fundamental frequency.

International Standard Laboratory Corp.  
 Company Address: No.120, Lane 180, Hsin Ho Rd.  
 Lung-Tan Dist., Tao Yuan City 325, Taiwan  
 Date: 2023-07-28

Project Number. : 23LR0074 Temp.(°C)/RH(%) : 24/63  
 Test Mode : Bandedge High Ch Tested by : Weitin Chen

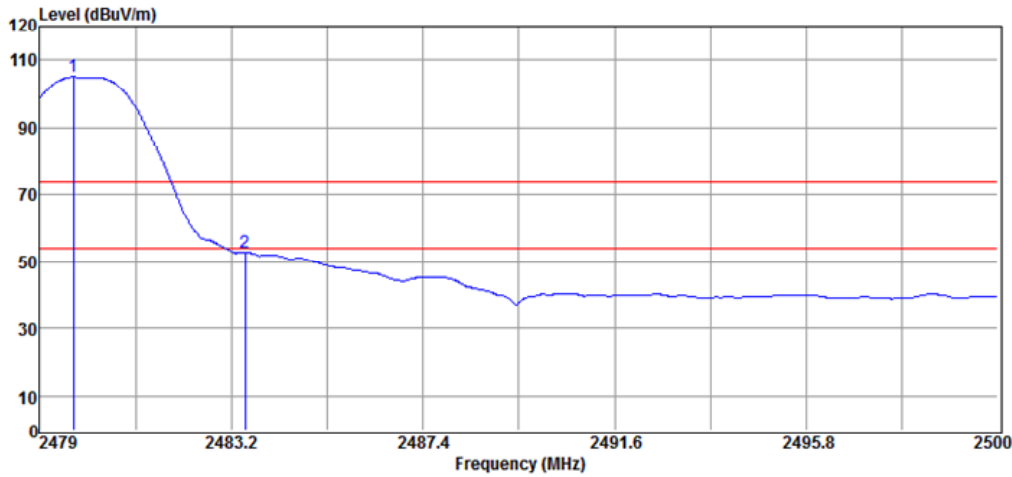

No	Freq MHz	Reading dBuV	Factor dB/m	Level dBuV/m	Limit dBuV/m	Margin dB	Remark	Pol V/H
1	2479.74	115.39	-10.41	104.98	F	--	Peak	HORIZONTAL
2	2483.50	63.17	-10.39	52.78	74.00	-21.22	Peak	HORIZONTAL

Note: "F" denotes fundamental frequency.

## 9. 6dB Bandwidth

### 9.1 Standard Applicable

According to §15.247(a)(2), Systems using digital modulation techniques may operate in the 902 - 928 MHz, 2400 - 2483.5 MHz, and 5725 - 5850 MHz bands. The minimum 6 dB bandwidth shall be at least 500kHz.

According to RSS-247 issue 2, §5.2

(a)The minimum 6 dB bandwidth shall be 500 kHz.

### 9.2 Measurement Procedure

1. Place the EUT on the table and set it in transmitting mode.
2. Remove the antenna from the EUT and then connect a low loss RF cable from the antenna port to the spectrum analyzer.
3. Set the spectrum analyzer as
  - RBW = 100 kHz.
  - VBW  $\geq$  3 x RBW.
  - Detector = Peak.
  - Trace mode = max hold.
  - Sweep = auto couple.
  - Allow the trace to stabilize.
  - Use 6-dB BW measurement function
4. Repeat above procedures until all frequency measured were complete.

### 9.3 Measurement Result

BLE (1M)

Frequency (MHz)	6dB Bandwidth (MHz)	6dB BW Limit (kHz)
2402	0.734	> 500
2442	0.739	> 500
2480	0.721	> 500

Test Data: BLE 1M\2402MHz



Test Data: BLE 1M\2442MHz

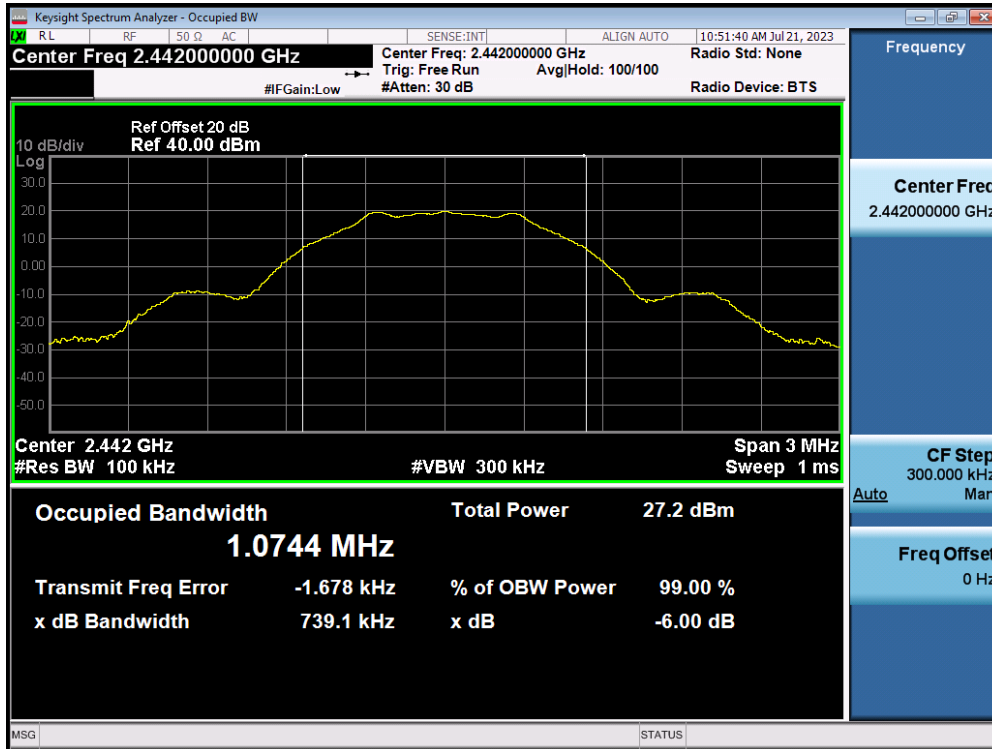

Test Data: BLE 1M\2480MHz



## 10. Peak Power Spectral Density

### 10.1 Standard Applicable

According to §15.247(e) For digitally modulated systems, the power spectral density conducted from the intentional radiator to the antenna shall not be greater than 8 dBm in any 3 kHz band during any time interval of continuous transmission. This power spectral density shall be determined in accordance with the provisions of paragraph (b) of this section. The same method of determining the conducted output power shall be used to determine the power spectral density.

According to RSS-247 issue 2, §5.2

(2)The transmitter power spectral density conducted from the transmitter to the antenna shall not be greater than 8 dBm in any 3 kHz band during any time interval of continuous transmission. This power spectral density shall be determined in accordance with the provisions of Section 5.4(d), (i.e. the power spectral density shall be determined using the same method as is used to determine the conducted output power).

### 10.2 Measurement Procedure

1. Place the EUT on the table and set it in transmitting mode.
2. Remove the antenna from the EUT and then connect a low loss RF cable from the antenna port to the spectrum analyzer.
3. Set the spectrum analyzer as RBW =3kHz, VBW = 10kHz, Set the span to 1.5 DTS bandwidth., Sweep=Auto
4. Record the max. reading.
5. Repeat above procedures until all frequency measured were complete.

### 10.3 Measurement Result

Mode	Freq. (MHz)	PSD (dBm/3kHz)	Duty Factor (dB)	Total PSD (dBm/3kHz)	PSD Limit (dBm/3kHz)
BLE (1M)	2402	7.71	0	7.71	8
	2442	7.216	0	7.216	8
	2480	4.427	0	4.427	8

Test Data: BLE 1M\2402MHz

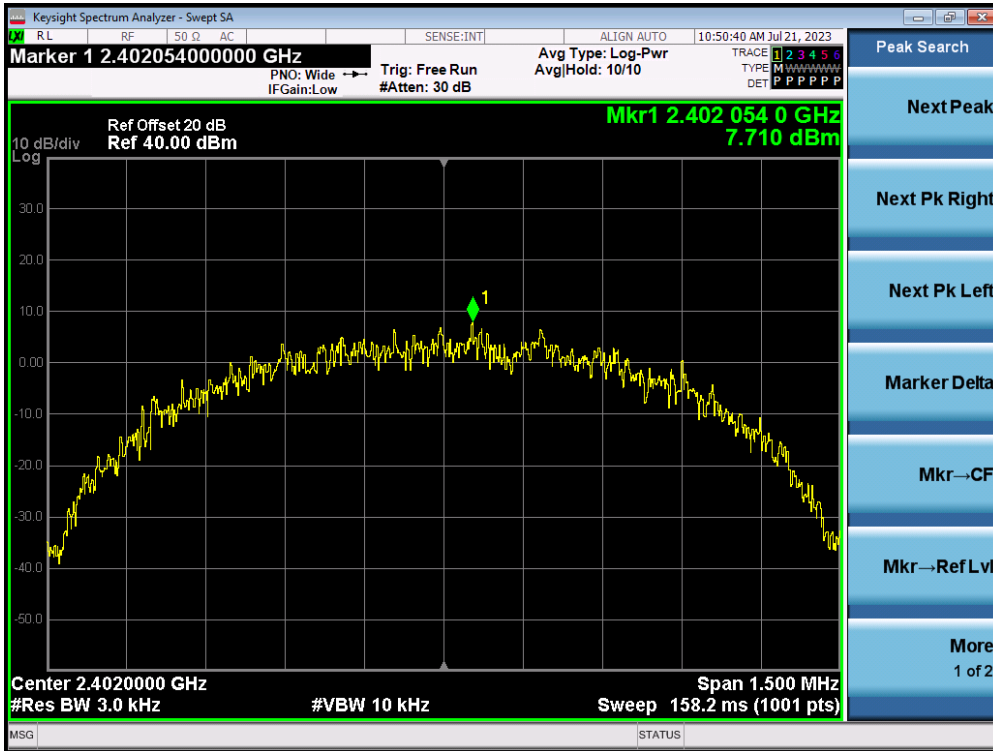

Test Data: BLE 1M\2442MHz



Test Data: BLE 1M\2480MHz

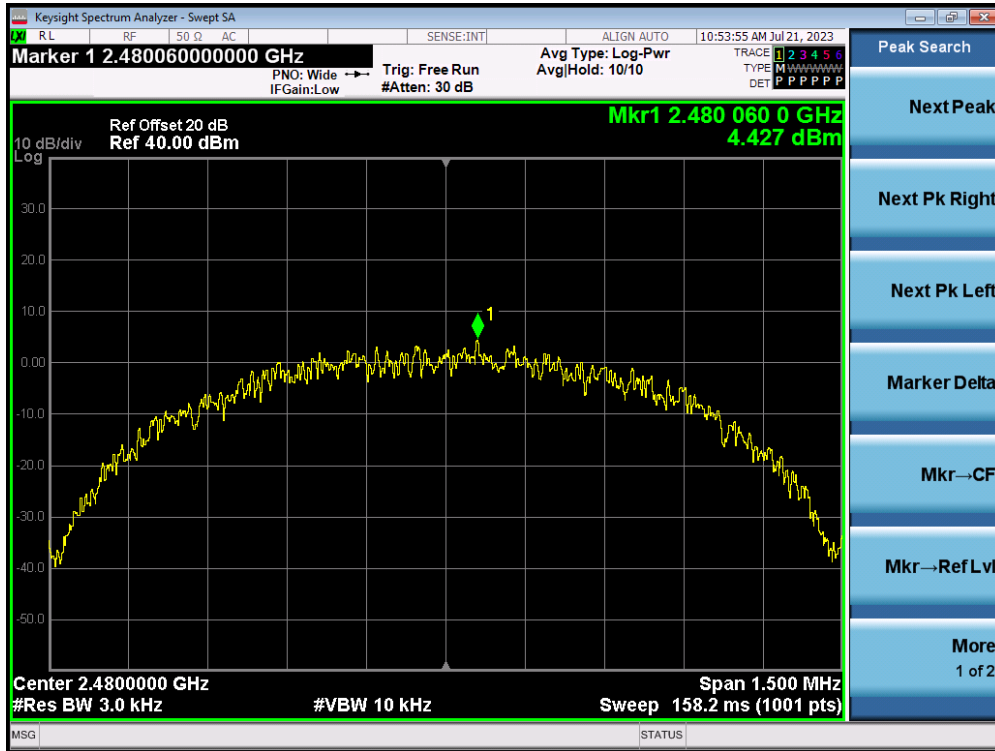



## 11. Appendix

### 11.1 Appendix A: Equipment List

Location	Equipment Name	Brand	Model	S/N	Last Cal. Date	Next Cal. Date
Conduction 02	EMI Receiver 19	R&S	ESR3	102460	05/08/2023	05/08/2024
Conduction 02	Conduction 02-1 Cable	WOKEN	CFD 300-NL	Conduction 02 -1	10/11/2022	10/11/2023
Conduction 02	LISN 26	R&S	ENV216	102378	12/08/2022	12/08/2023
Conduction 02	LISN 15	R&S	ENV216	101335	12/08/2022	12/08/2023
Conduction 02	ISN T8 CAT6A_02	SCHWARZBECK	NTFM 8158	NTFM 8158-00370	07/07/2023	07/07/2024
Conduction 02	ISN T4 08	TESEQ	ISN T400A	49913	08/31/2022	08/31/2023
Conduction 02	ISN T8 08	Teseq GmbH	ISN T800	36155	10/03/2022	10/03/2023
Conduction 02	CDN ISN ST08A_1	Teseq GmbH	CDN ISN ST08A	43352	10/04/2022	10/04/2023
Conduction 02	Capacitive Voltage Probe 01	SCHAFFNER	CVP 2200A	18711	02/22/2023	02/22/2024
Conduction 02	Current Probe	SCHAFFNER	SMZ 11	18030	02/22/2023	02/22/2024

Location Conducted	Equipment Name	Brand	Model	S/N	Last Cal. Date	Next Cal. Date
Chamber 19	Spectrum analyzer	R&S	FSV40	101919	08/17/2023	08/17/2024
Chamber 19	EMI Receiver	R&S	ESR3	102461	05/08/2023	05/08/2024
Chamber 19	Loop Antenna	EM	EM-6879	271	10/05/2022	10/05/2023
Chamber 19	Bilog Antenna (30MHz-1GHz)	Schwarzbeck	VULB9168 w 6dB Att.	9168-736	03/09/2023	03/09/2024
Chamber 19	Horn antenna (1GHz-18GHz)	ETS	3117	00218718	10/12/2022	10/12/2023
Chamber 19	Horn antenna (18GHz-26GHz)	Com-power	AH-826	081001	11/24/2022	11/24/2023
Chamber 19	Horn antenna (26GHz-40GHz)	Com-power	AH-640	100A	03/25/2023	03/25/2024
Chamber 19	Preamplifier (9kHz-3GHz)	EM	EM330	060822	01/05/2023	01/05/2024
Chamber 19	Preamplifier (1GHz-26GHz)	HP	8449B	3008A02471	10/26/2022	10/26/2023
Chamber 19	Preamplifier (26GHz-40GHz)	MITEQ	JS4-26004000-27-5A	818471	05/04/2023	05/04/2024
Chamber 19	RF Cable (100kHz-26.5GHz)	Huber Suhner	Sucoflex 104A	MY1394/4A & 50886/4A	09/02/2023	09/02/2024
Chamber 19	RF Cable (18GHz-40GHz)	HUBER SUHNER	Sucoflex 102	27963/2&37421/2	11/23/2022	11/23/2023
Chamber 19	Signal Generator	Anritsu	MG3692A	20311	12/29/2022	12/29/2023
Chamber 19	Test Software	Audix	E3 Ver:6.120203b	N/A	N/A	N/A

Location Conducted	Equipment Name	Brand	Model	S/N	Last Cal. Date	Next Cal. Date
Conducted	Power Meter	Anritsu	ML2495A	1116010	09/29/2022	09/29/2023
Conducted	Power Sensor	Anritsu	MA2411B	34NKF50	09/29/2022	09/29/2023
Conducted	Power Sensor	DARE	RPR3006W	13I00030SNO33	01/06/2023	01/06/2024
Conducted	Power Sensor	DARE	RPR3006W	13I00030SNO34	01/06/2023	01/06/2024
Conducted	Power Sensor	DARE	RPR3006W	14I00889SNO35	06/21/2023	06/21/2024
Conducted	Power Sensor	DARE	RPR3006W	14I00889SNO36	06/21/2023	06/21/2024
Conducted	Temperature Chamber	KSON	THS-B4H100	2287	05/17/2023	05/17/2024
Conducted	DC Power supply	ABM	8185D	N/A	01/04/2023	01/04/2024
Conducted	AC Power supply	EXTECH	CFC105W	NA	N/A	N/A
Conducted	Spectrum analyzer	Keysight	N9010A	MY56070257	09/28/2022	09/28/2023
Conducted	Test Software	DARE	Radiation Ver:2013.1.23	NA	NA	NA
Conducted	Test Software	R&S	CMUGO Ver:2.0.0	N/A	N/A	N/A
Conducted	Universal Radio Comm. Tester	R&S	CMU200	111968	11/19/2022	11/19/2023
Conducted	Wideband Radio Comm. Tester	R&S	CMW500	1201.002K501087 93-JG	10/31/2022	10/31/2023
Conducted	BT Simulator	Agilent	N4010A	MY48100200	NA	NA
Conducted	Signal Generator	Agilent	E4438C	MY49071550	12/28/2022	12/28/2023
Conducted	Signal Generator	Keysight	N5182B	MY53052399	12/28/2022	12/28/2023
Conducted	Spectrum analyzer	Keysight	N9010A	MY56070257	09/28/2022	09/28/2023
Conducted (TS8997)	Wideband Radio Comm. Tester	R&S	CMW500	168811	09/22/2022	09/22/2023
Conducted (TS8997)	UP/DOWN converter	R&S	CMW-Z800A	100566	12/22/2022	12/22/2023
Conducted (TS8997)	Signal Generator	R&S	SMB100A	183701	01/18/2023	01/18/2024
Conducted (TS8997)	Vector Signal Generator	R&S	SMM100A	101908	11/23/2022	11/23/2023
Conducted (TS8997)	Signal analyzer 40GHz	R&S	FSV40	101884	09/22/2022	09/22/2023
Conducted (TS8997)	OSP150 extension unit CAM-BUS	R&S	OSP150	101107	09/21/2022	09/21/2023
Conducted (TS8997)	Test Software	R&S	EMC32 Ver: 11.60.00	NA	NA	NA

## 11.2 Appendix B: Uncertainty of Measurement

ISO/IEC 17025 requires that an estimate of measurement uncertainties associated with the emissions test results be included in the report. The measurement uncertainties given below are based on a 95% confidence level (based on a coverage factor (k=2)).

Parameters	Uncertainty (k=2)
Conducted Emission (AC power line)	±0.852 dB
Spurious emissions, radiated	±3.46 dB
RF power, conducted	±1.386 dB
Power Density	±1.432 dB
RF Frequency	±0.00298%
Time	±0.01%



### Radiated Spurious Emission Test & 100kHz Bandwidth of Band Edges Measurement Test Setup

(A) Radiated Emission Test Setup for frequency below 1000MHz

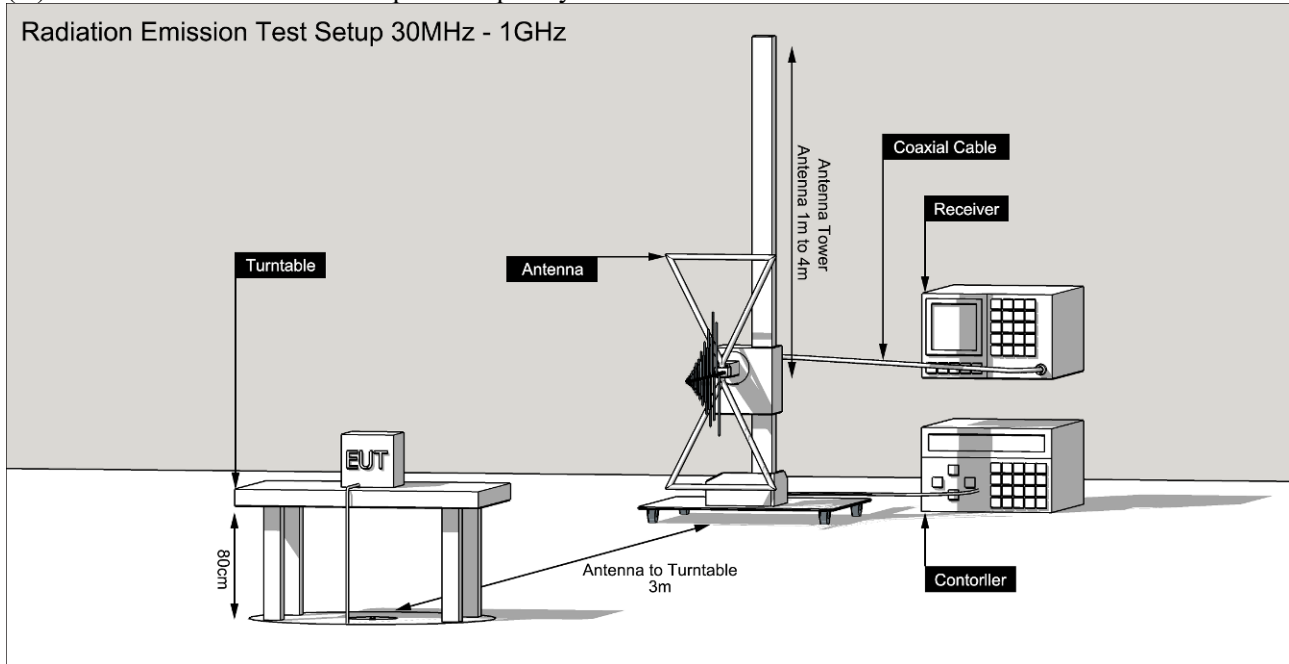

(B) Radiated Emission Test Setup for frequency above 1 GHz

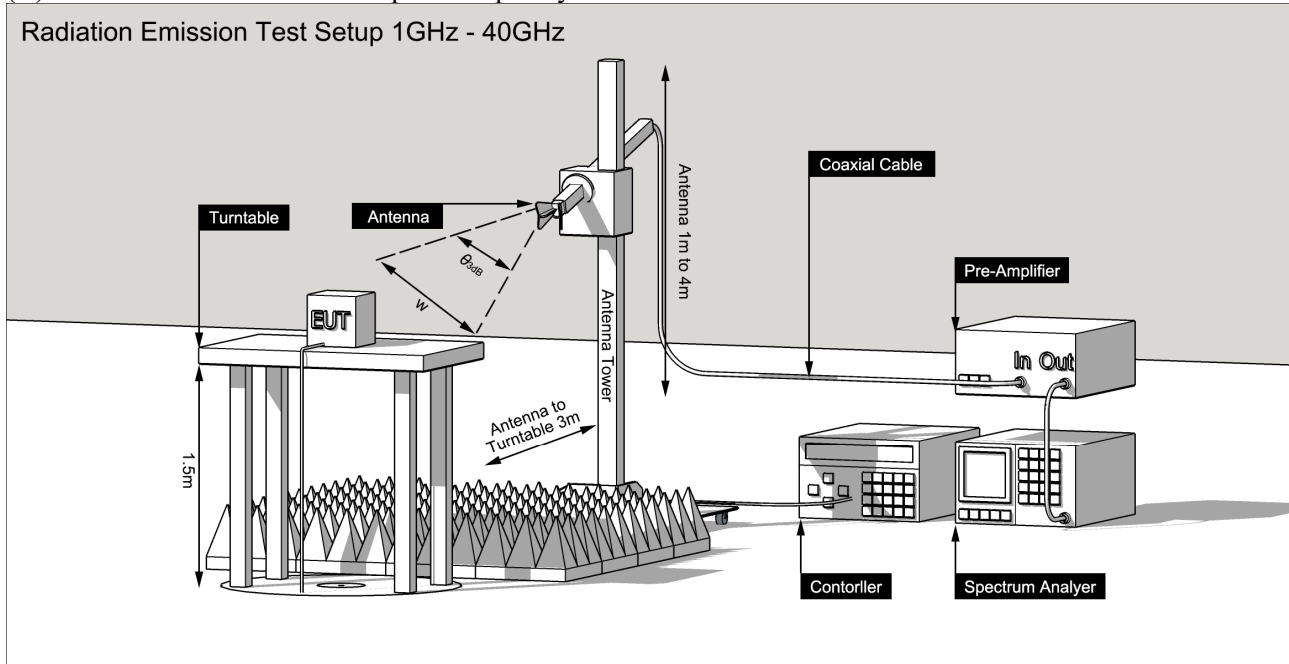

### RF Conducted Measurement Test Setup

