



MET Laboratories, Inc. *Safety Certification - EMI - Telecom Environmental Simulation*

914 WEST PATAPSCO AVENUE • BALTIMORE, MARYLAND 21230-3432 • PHONE (410) 354-3300 • FAX (410) 354-3313

33439 WESTERN AVENUE • UNION CITY, CALIFORNIA 94587 • PHONE (510) 489-6300 • FAX (510) 489-6372

3162 BELICK STREET • SANTA CLARA, CALIFORNIA 95054 • PHONE (408) 748-3585 • FAX (510) 489-6372

September 6, 2011

Infinet Malta Ltd.
222 Merchants Street
Valletta, VLT1170

Dear Andrey Koynov,

Enclosed is the EMC Wireless test report for compliance testing of the Infinet Malta Ltd., R5000-Mmx/58.300.2x200.2x23 as tested to the requirements of Title 47 of the CFR, Ch. 1 (10-1-06 ed.), Part 15, Subpart B, ICES-003, Issue 4 February 2004 for a Class A Digital Device and FCC Part 15 Subpart C, RSS-210, Issue 8, Dec. 2010 for Intentional Radiators.

Thank you for using the services of MET Laboratories, Inc. If you have any questions regarding these results or if MET can be of further service to you, please feel free to contact me.

Sincerely yours,
MET LABORATORIES, INC.

Jennifer Warnell
Documentation Department

Reference: (\Infinet Malta Ltd.\EMC31687A-FCC247 Rev. 1)

Certificates and reports shall not be reproduced except in full, without the written permission of MET Laboratories, Inc.

Electromagnetic Compatibility Criteria Test Report

for the

**Infinet Malta Ltd.
R5000-Mmx/58.300.2x200.2x23**

Tested under
the FCC Certification Rules
contained in
Title 47 of the CFR, Parts 15 Subpart B & ICES-003
for Class A Digital Devices
&
15.247 Subpart C & RSS-210, Issue 8, Dec. 2010
for Intentional Radiators

MET Report: EMC31687A-FCC247 Rev. 1

September 6, 2011

Prepared For:

**Infinet Malta Ltd.
222 Merchants Street
Valletta, VLT1170**

Prepared By:
MET Laboratories, Inc.
914 W. Patapsco Ave.
Baltimore, MD 21230

Electromagnetic Compatibility Criteria Test Report

for the

Infinet Malta Ltd.
R5000-Mmx/58.300.2x200.2x23

Tested under
the FCC Certification Rules
contained in
Title 47 of the CFR, Parts 15 Subpart B & ICES-003
for Class A Digital Devices
&
15.247 Subpart C & RSS-210, Issue 8, Dec. 2010
for Intentional Radiators

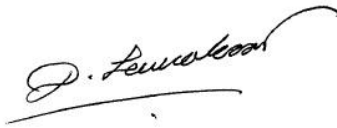

Dusmantha Tennakoon, Project Engineer
Electromagnetic Compatibility Lab



Jennifer Warnell
Documentation Department

Engineering Statement: The measurements shown in this report were made in accordance with the procedures indicated, and the emissions from this equipment were found to be within the limits applicable. I assume full responsibility for the accuracy and completeness of these measurements, and for the qualifications of all persons taking them. It is further stated that upon the basis of the measurements made, the equipment tested is capable of operation in accordance with the requirements of the FCC Rules Parts 15B, 15.247 and Industry Canada standards ICES-003, Issue 4 February 2004, RSS-210, Issue 8, Dec. 2010 under normal use and maintenance.



Shawn McMillen,
Wireless Manager, Electromagnetic Compatibility Lab

Report Status Sheet

Revision	Report Date	Reason for Revision
∅	August 31, 2011	Initial Issue.
1	September 6, 2011	Revised to reflect engineer corrections.

Table of Contents

I.	Executive Summary	1
	A. Purpose of Test	2
	B. Executive Summary	2
II.	Equipment Configuration	3
	A. Overview.....	4
	B. References.....	5
	C. Test Site	5
	D. Description of Test Sample.....	6
	E. Equipment Configuration.....	8
	F. Support Equipment	8
	G. Ports and Cabling Information.....	8
	H. Mode of Operation.....	9
	I. Method of Monitoring EUT Operation	9
	J. Modifications	9
	a) Modifications to EUT.....	9
	b) Modifications to Test Standard.....	9
	K. Disposition of EUT.....	9
III.	Electromagnetic Compatibility Criteria for Unintentional Radiators	10
	§ 15.107(a) Conducted Emissions Limits.....	11
	§ 15.109(a) Radiated Emissions Limits.....	15
IV.	Electromagnetic Compatibility Criteria for Intentional Radiators.....	19
	§ 15.203 Antenna Requirement	20
	§ 15.207(a) Conducted Emissions Limits.....	21
	§ 15.247(a)(a) 6 dB and 99% Bandwidth	25
	§ 15.247(b) Peak Power Output	36
	§ 15.247(d) Radiated Spurious Emissions Requirements and Band Edge	42
	§ 15.247(d) RF Conducted Spurious Emissions Requirements and Band Edge.....	55
	§ 15.247(e) Peak Power Spectral Density	72
	§ 15.247(i) Maximum Permissible Exposure	82
	RSS-GEN Receiver Spurious Emissions.....	83
V.	Test Equipment	86
VI.	Certification & User's Manual Information.....	88
	A. Certification Information	89
	B. Label and User's Manual Information	93
VII.	ICES-003 Procedural & Labeling Requirements.....	95

List of Tables

Table 1. Executive Summary of EMC Part 15.247 Compliance Testing	2
Table 2. EUT Summary Table.....	4
Table 3. References	5
Table 4. Equipment Configuration	8
Table 5. Support Equipment.....	8
Table 6. Ports and Cabling Information	8
Table 7. Conducted Limits for Radio Frequency Devices calculated from FCC Part 15 Subsections 15.107(a) (b) and 15.207(a)	11
Table 8. Conducted Emissions - Voltage, AC Power, Phase Line (120 VAC, 60 Hz).....	12
Table 9. Conducted Emissions - Voltage, AC Power, Neutral Line (120 VAC, 60 Hz).....	13
Table 10. Radiated Emissions Limits calculated from FCC Part 15, §15.109 (a) (b)	15
Table 11. Radiated Emissions Limits, Test Results, 30 MHz – 1 GHz, FCC Limits	16
Table 12. Radiated Emissions Limits, Test Results, ICES-003 Limits	17
Table 13. Conducted Limits for Intentional Radiators from FCC Part 15 § 15.207(a)	21
Table 14. Conducted Emissions, 15.207(a), Phase Line, Test Results	22
Table 15. Conducted Emissions, 15.207(a), Neutral Line, Test Results	23
Table 16. 6 dB Occupied Bandwidth, Test Results, 20 MHz, Horizontal Feed	26
Table 17. 6 dB Occupied Bandwidth, Test Results, 20 MHz, Vertical Feed	26
Table 18. 6 dB Occupied Bandwidth, Test Results, 40 MHz, Horizontal Feed	26
Table 19. 6 dB Occupied Bandwidth, Test Results, 40 MHz, Vertical Feed	26
Table 20. 99% Occupied Bandwidth, Test Results, 20 MHz, Horizontal Feed.....	27
Table 21. 99% Occupied Bandwidth, Test Results, 20 MHz, Vertical Feed.....	27
Table 22. 99% Occupied Bandwidth, Test Results, 40 MHz, Horizontal Feed.....	27
Table 23. 99% Occupied Bandwidth, Test Results, 40 MHz, Vertical Feed.....	27
Table 24. Output Power Requirements from §15.247(b)	36
Table 25. Peak Power Output, Summed.....	37
Table 26. Restricted Bands of Operation.....	42
Table 27. Radiated Emissions Limits Calculated from FCC Part 15, § 15.209 (a)	43
Table 28. Peak Power Spectral Density, Test Results	73
Table 29. Spurious Emission Limits for Receivers	83
Table 30. Test Equipment List	87

List of Plots

Plot 1. Conducted Emission, Phase Line Plot	12
Plot 2. Conducted Emission, Neutral Line Plot.....	13
Plot 3. Radiated Emissions, 30 MHz - 1 GHz, FCC Limits	16
Plot 4. Radiated Emissions, ICES-003 Limits.....	17
Plot 5. Conducted Emissions, 15.207(a), Phase Line	22
Plot 6. Conducted Emissions, 15.207(a), Neutral Line	23
Plot 7. 6 dB Occupied Bandwidth, Low Channel, 20 MHz, Horizontal Feed.....	28
Plot 8. 6 dB Occupied Bandwidth, Mid Channel, 20 MHz, Horizontal Feed.....	28
Plot 9. 6 dB Occupied Bandwidth, High Channel, 20 MHz, Horizontal Feed	28
Plot 10. 6 dB Occupied Bandwidth, Low Channel, 20 MHz, Vertical Feed	29
Plot 11. 6 dB Occupied Bandwidth, Mid Channel, 20 MHz, Vertical Feed.....	29
Plot 12. 6 dB Occupied Bandwidth, High Channel, 20 MHz, Vertical Feed	29
Plot 13. 6 dB Occupied Bandwidth, Low Channel, 40 MHz, Horizontal Feed.....	30
Plot 14. 6 dB Occupied Bandwidth, Mid Channel, 40 MHz, Horizontal Feed.....	30
Plot 15. 6 dB Occupied Bandwidth, High Channel, 40 MHz, Horizontal Feed	30
Plot 16. 6 dB Occupied Bandwidth, Low Channel, 40 MHz, Vertical Feed	31

Plot 17. 6 dB Occupied Bandwidth, Mid Channel, 40 MHz, Vertical Feed.....	31
Plot 18. 6 dB Occupied Bandwidth, High Channel, 40 MHz, Vertical Feed	31
Plot 19. 99% Occupied Bandwidth, Low Channel, 20 MHz, Horizontal Feed	32
Plot 20. 99% Occupied Bandwidth, Mid Channel, 20 MHz, Horizontal Feed.....	32
Plot 21. 99% Occupied Bandwidth, High Channel, 20 MHz, Horizontal Feed.....	32
Plot 22. 99% Occupied Bandwidth, Low Channel, 20 MHz, Vertical Feed	33
Plot 23. 99% Occupied Bandwidth, Mid Channel, 20 MHz, Vertical Feed	33
Plot 24. 99% Occupied Bandwidth, High Channel, 20 MHz, Vertical Feed.....	33
Plot 25. 99% Occupied Bandwidth, Low Channel, 40 MHz, Horizontal Feed	34
Plot 26. 99% Occupied Bandwidth, Mid Channel, 40 MHz, Horizontal Feed.....	34
Plot 27. 99% Occupied Bandwidth, High Channel, 40 MHz, Horizontal Feed.....	34
Plot 28. 99% Occupied Bandwidth, Low Channel, 40 MHz, Vertical Feed	35
Plot 29. 99% Occupied Bandwidth, Mid Channel, 40 MHz, Vertical Feed	35
Plot 30. 99% Occupied Bandwidth, High Channel, 40 MHz, Vertical Feed.....	35
Plot 31. Peak Power Output, Low Channel, 20 MHz, Horizontal Feed	38
Plot 32. Peak Power Output, Mid Channel, 20 MHz, Horizontal Feed	38
Plot 33. Peak Power Output, High Channel, 20 MHz, Horizontal Feed.....	38
Plot 34. Peak Power Output, Low Channel, 20 MHz, Vertical Feed	39
Plot 35. Peak Power Output, Mid Channel, 20 MHz, Vertical Feed	39
Plot 36. Peak Power Output, High Channel, 20 MHz, Vertical Feed.....	39
Plot 37. Peak Power Output, Low Channel, 40 MHz, Horizontal Feed	40
Plot 38. Peak Power Output, Mid Channel, 40 MHz, Horizontal Feed.....	40
Plot 39. Peak Power Output, High Channel, 40 MHz, Horizontal Feed.....	40
Plot 40. Peak Power Output, Low Channel, 40 MHz, Vertical Feed	41
Plot 41. Peak Power Output, Mid Channel, 40 MHz, Vertical Feed	41
Plot 42. Peak Power Output, High Channel, 40 MHz, Vertical Feed.....	41
Plot 43. Radiated Spurious Emissions, Low Channel, 30 MHz – 1 GHz, 20 MHz.....	44
Plot 44. Radiated Spurious Emissions, Low Channel, 1 GHz – 7 GHz, 20 MHz	44
Plot 45. Radiated Spurious Emissions, Low Channel, 7 GHz – 18 GHz, 20 MHz	44
Plot 46. Radiated Spurious Emissions, Low Channel, 1 GHz – 6 GHz, Peak, 20 MHz.....	45
Plot 47. Radiated Spurious Emissions, Low Channel, 6 GHz – 18 GHz, Peak, 20 MHz.....	45
Plot 48. Radiated Spurious Emissions, Mid Channel, 30 MHz – 1 GHz, 20 MHz	45
Plot 49. Radiated Spurious Emissions, Mid Channel, 1 GHz – 7 GHz, 20 MHz	46
Plot 50. Radiated Spurious Emissions, Mid Channel, 7 GHz – 18 GHz, 20 MHz.....	46
Plot 51. Radiated Spurious Emissions, Mid Channel, 1 GHz – 6 GHz, Peak, 20 MHz	46
Plot 52. Radiated Spurious Emissions, Mid Channel, 6 GHz – 18 GHz, Peak, 20 MHz	47
Plot 53. Radiated Spurious Emissions, High Channel, 30 MHz – 1 GHz, 20 MHz.....	47
Plot 54. Radiated Spurious Emissions, High Channel, 1 GHz – 7 GHz, 20 MHz.....	47
Plot 55. Radiated Spurious Emissions, High Channel, 7 GHz – 18 GHz, 20 MHz.....	48
Plot 56. Radiated Spurious Emissions, High Channel, 1 GHz – 6 GHz, Peak, 20 MHz.....	48
Plot 57. Radiated Spurious Emissions, High Channel, 1 GHz – 6 GHz, Peak, 20 MHz	48
Plot 58. Radiated Spurious Emissions, Low Channel, 30 MHz – 1 GHz, 40 MHz.....	49
Plot 59. Radiated Spurious Emissions, Low Channel, 1 GHz – 7 GHz, 40 MHz	49
Plot 60. Radiated Spurious Emissions, Low Channel, 7 GHz – 18 GHz, 40 MHz	49
Plot 61. Radiated Spurious Emissions, Low Channel, 1 GHz – 6 GHz, Peak, 40 MHz.....	50
Plot 62. Radiated Spurious Emissions, Low Channel, 6 GHz – 18 GHz, Peak, 40 MHz.....	50
Plot 63. Radiated Spurious Emissions, Mid Channel, 30 MHz – 1 GHz, 40 MHz	50
Plot 64. Radiated Spurious Emissions, Mid Channel, 1 GHz – 7 GHz, 40 MHz.....	51
Plot 65. Radiated Spurious Emissions, Mid Channel, 7 GHz – 18 GHz, 40 MHz.....	51
Plot 66. Radiated Spurious Emissions, Mid Channel, 1 GHz – 6 GHz, Peak, 40 MHz	51
Plot 67. Radiated Spurious Emissions, Mid Channel, 6 GHz – 18 GHz, Peak, 40 MHz	52
Plot 68. Radiated Spurious Emissions, High Channel, 30 MHz – 1 GHz, 40 MHz.....	52
Plot 69. Radiated Spurious Emissions, High Channel, 1 GHz – 7 GHz, 40 MHz.....	52

Plot 70. Radiated Spurious Emissions, High Channel, 7 GHz – 18 GHz, 40 MHz.....	53
Plot 71. Radiated Spurious Emissions, High Channel, 1 GHz – 6 GHz, Peak, 40 MHz.....	53
Plot 72. Radiated Spurious Emissions, High Channel, 6 GHz – 18 GHz, Peak, 40 MHz.....	53
Plot 73. Conducted Spurious Emissions, Low Channel, 30 MHz – 1 GHz, 20 MHz, Horizontal Feed.....	56
Plot 74. Conducted Spurious Emissions, Low Channel, 1 GHz – 18 GHz, 20 MHz, Horizontal Feed.....	56
Plot 75. Conducted Spurious Emissions, Low Channel, 18 GHz – 40 GHz, 20 MHz, Horizontal Feed.....	56
Plot 76. Conducted Spurious Emissions, Mid Channel, 30 MHz – 1 GHz, 20 MHz, Horizontal Feed.....	57
Plot 77. Conducted Spurious Emissions, Mid Channel, 1 GHz – 18 GHz, 20 MHz, Horizontal Feed.....	57
Plot 78. Conducted Spurious Emissions, Mid Channel, 18 GHz – 40 GHz, 20 MHz, Horizontal Feed.....	57
Plot 79. Conducted Spurious Emissions, High Channel, 30 MHz – 1 GHz, 20 MHz, Horizontal Feed.....	58
Plot 80. Conducted Spurious Emissions, High Channel, 1 GHz – 18 GHz, 20 MHz, Horizontal Feed.....	58
Plot 81. Conducted Spurious Emissions, High Channel, 18 GHz – 40 GHz, 20 MHz, Horizontal Feed.....	58
Plot 82. Conducted Spurious Emissions, Low Channel, 30 MHz – 1 GHz, 20 MHz, Vertical Feed.....	59
Plot 83. Conducted Spurious Emissions, Low Channel, 1 GHz – 18 GHz, 20 MHz, Vertical Feed.....	59
Plot 84. Conducted Spurious Emissions, Low Channel, 18 GHz – 40 GHz, 20 MHz, Vertical Feed.....	59
Plot 85. Conducted Spurious Emissions, Mid Channel, 30 MHz – 1 GHz, 20 MHz, Vertical Feed.....	60
Plot 86. Conducted Spurious Emissions, Mid Channel, 1 GHz – 18 GHz, 20 MHz, Vertical Feed.....	60
Plot 87. Conducted Spurious Emissions, Mid Channel, 18 GHz – 40 GHz, 20 MHz, Vertical Feed.....	60
Plot 88. Conducted Spurious Emissions, High Channel, 30 MHz – 1 GHz, 20 MHz, Vertical Feed.....	61
Plot 89. Conducted Spurious Emissions, High Channel, 1 GHz – 18 GHz, 20 MHz, Vertical Feed.....	61
Plot 90. Conducted Spurious Emissions, High Channel, 18 GHz – 40 GHz, 20 MHz, Vertical Feed.....	61
Plot 91. Conducted Spurious Emissions, Low Channel, 30 MHz – 1 GHz, 40 MHz, Horizontal Feed.....	62
Plot 92. Conducted Spurious Emissions, Low Channel, 1 GHz – 18 GHz, 40 MHz, Horizontal Feed.....	62
Plot 93. Conducted Spurious Emissions, Low Channel, 18 GHz – 40 GHz, 40 MHz, Horizontal Feed.....	62
Plot 94. Conducted Spurious Emissions, Mid Channel, 30 MHz – 1 GHz, 40 MHz, Horizontal Feed.....	63
Plot 95. Conducted Spurious Emissions, Mid Channel, 1 GHz – 18 GHz, 40 MHz, Horizontal Feed.....	63
Plot 96. Conducted Spurious Emissions, Mid Channel, 18 GHz – 40 GHz, 40 MHz, Horizontal Feed.....	63
Plot 97. Conducted Spurious Emissions, High Channel, 30 MHz – 1 GHz, 40 MHz, Horizontal Feed.....	64
Plot 98. Conducted Spurious Emissions, High Channel, 1 GHz – 18 GHz, 40 MHz, Horizontal Feed.....	64
Plot 99. Conducted Spurious Emissions, High Channel, 18 GHz – 40 GHz, 40 MHz, Horizontal Feed.....	64
Plot 100. Conducted Spurious Emissions, Low Channel, 30 MHz – 1 GHz, 40 MHz, Vertical Feed.....	65
Plot 101. Conducted Spurious Emissions, Low Channel, 1 GHz – 18 GHz, 40 MHz, Vertical Feed.....	65
Plot 102. Conducted Spurious Emissions, Low Channel, 18 GHz – 40 GHz, 40 MHz, Vertical Feed.....	65
Plot 103. Conducted Spurious Emissions, Mid Channel, 30 MHz – 1 GHz, 40 MHz, Vertical Feed.....	66
Plot 104. Conducted Spurious Emissions, Mid Channel, 1 GHz – 18 GHz, 40 MHz, Vertical Feed.....	66
Plot 105. Conducted Spurious Emissions, Mid Channel, 18 GHz – 40 GHz, 40 MHz, Vertical Feed.....	66
Plot 106. Conducted Spurious Emissions, High Channel, 30 MHz – 1 GHz, 40 MHz, Vertical Feed.....	67
Plot 107. Conducted Spurious Emissions, High Channel, 1 GHz – 18 GHz, 40 MHz, Vertical Feed.....	67
Plot 108. Conducted Spurious Emissions, High Channel, 18 GHz – 40 GHz, 40 MHz, Vertical Feed.....	67
Plot 109. Conducted Band Edge, Low Channel, 20 MHz, Horizontal Feed.....	68
Plot 110. Conducted Band Edge, High Channel, 20 MHz, Horizontal Feed.....	68
Plot 111. Conducted Band Edge, Low Channel, 20 MHz, Vertical Feed.....	69
Plot 112. Conducted Band Edge, High Channel, 20 MHz, Vertical Feed.....	69
Plot 113. Conducted Band Edge, Low Channel, 40 MHz, Horizontal Feed.....	70
Plot 114. Conducted Band Edge, High Channel, 40 MHz, Horizontal Feed.....	70
Plot 115. Conducted Band Edge, Low Channel, 40 MHz, Vertical Feed.....	71
Plot 116. Conducted Band Edge, High Channel, 40 MHz, Vertical Feed.....	71
Plot 117. Peak Power Spectral Density, Low Channel, 20 MHz, Horizontal Feed, Determination.....	74
Plot 118. Peak Power Spectral Density, Low Channel, 20 MHz, Horizontal Feed.....	74
Plot 119. Peak Power Spectral Density, Mid Channel, 20 MHz, Horizontal Feed, Determination.....	74
Plot 120. Peak Power Spectral Density, Mid Channel, 20 MHz, Horizontal Feed.....	75
Plot 121. Peak Power Spectral Density, High Channel, 20 MHz, Horizontal Feed, Determination.....	75
Plot 122. Peak Power Spectral Density, High Channel, 20 MHz, Horizontal Feed.....	75

Plot 123. Peak Power Spectral Density, Low Channel, 20 MHz, Vertical Feed, Determination	76
Plot 124. Peak Power Spectral Density, Low Channel, 20 MHz, Vertical Feed	76
Plot 125. Peak Power Spectral Density, Mid Channel, 20 MHz, Vertical Feed, Determination	76
Plot 126. Peak Power Spectral Density, Mid Channel, 20 MHz, Vertical Feed	77
Plot 127. Peak Power Spectral Density, High Channel, 20 MHz, Vertical Feed, Determination.....	77
Plot 128. Peak Power Spectral Density, High Channel, 20 MHz, Vertical Feed	77
Plot 129. Peak Power Spectral Density, Low Channel, 40 MHz, Horizontal Feed, Determination	78
Plot 130. Peak Power Spectral Density, Low Channel, 40 MHz, Horizontal Feed	78
Plot 131. Peak Power Spectral Density, Mid Channel, 40 MHz, Horizontal Feed, Determination.....	78
Plot 132. Peak Power Spectral Density, Mid Channel, 40 MHz, Horizontal Feed.....	79
Plot 133. Peak Power Spectral Density, High Channel, 40 MHz, Horizontal Feed, Determination	79
Plot 134. Peak Power Spectral Density, High Channel, 40 MHz, Horizontal Feed	79
Plot 135. Peak Power Spectral Density, Low Channel, 40 MHz, Vertical Feed, Determination	80
Plot 136. Peak Power Spectral Density, Low Channel, 40 MHz, Vertical Feed	80
Plot 137. Peak Power Spectral Density, Mid Channel, 40 MHz, Vertical Feed, Determination	80
Plot 138. Peak Power Spectral Density, Mid Channel, 40 MHz, Vertical Feed.....	81
Plot 139. Peak Power Spectral Density, High Channel, 40 MHz, Vertical Feed, Determination.....	81
Plot 140. Peak Power Spectral Density, High Channel, 40 MHz, Vertical Feed	81
Plot 141. Conducted Receiver Spurious Emissions, Mid Channel, 30 MHz – 1 GHz, Horizontal Feed.....	84
Plot 142. Conducted Receiver Spurious Emissions, Mid Channel, 1 GHz – 18 GHz, Horizontal Feed	84
Plot 143. Conducted Receiver Spurious Emissions, Mid Channel, 30 MHz – 1 GHz, Vertical Feed.....	85
Plot 144. Conducted Receiver Spurious Emissions, Mid Channel, 1 GHz – 18 GHz, Vertical Feed	85

List of Figures

Figure 1. Block Diagram of Test Configuration.....	7
Figure 2. Block Diagram, Occupied Bandwidth Test Setup.....	25
Figure 3. Peak Power Output Test Setup.....	36
Figure 4. Block Diagram, Conducted Spurious Emissions Test Setup.....	55
Figure 5. Block Diagram, Peak Power Spectral Density Test Setup	72
Figure 6. Block Diagram, Conducted Receiver Spurious Emissions Test Setup	83

List of Photographs

Photograph 1. Infinet Malta Ltd. R5000-Mmx/58.300.2x200.2x23, Front View.....	6
Photograph 2. Conducted Emissions, Test Setup	14
Photograph 3. Radiated Emission, Test Setup.....	18
Photograph 4. Conducted Emissions, 15.207(a), Test Setup.....	24
Photograph 5. Radiated Spurious Emissions, Test Setup	54

List of Terms and Abbreviations

AC	Alternating Current
ACF	Antenna Correction Factor
Cal	Calibration
<i>d</i>	Measurement Distance
dB	Decibels
dB μ A	Decibels above one microamp
dB μ V	Decibels above one microvolt
dB μ A/m	Decibels above one microamp per meter
dB μ V/m	Decibels above one microvolt per meter
DC	Direct Current
E	Electric Field
DSL	Digital Subscriber Line
ESD	Electrostatic Discharge
EUT	Equipment Under Test
<i>f</i>	Frequency
FCC	Federal Communications Commission
GRP	Ground Reference Plane
H	Magnetic Field
HCP	Horizontal Coupling Plane
Hz	Hertz
IEC	International Electrotechnical Commission
kHz	kilohertz
kPa	kilopascal
kV	kilovolt
LISN	Line Impedance Stabilization Network
MHz	Megahertz
μ H	microhenry
μ	microfarad
μ s	microseconds
NEBS	Network Equipment-Building System
PRF	Pulse Repetition Frequency
RF	Radio Frequency
RMS	Root-Mean-Square
TWT	Traveling Wave Tube
V/m	Volts per meter
VCP	Vertical Coupling Plane

I. Executive Summary

A. Purpose of Test

An EMC evaluation was performed to determine compliance of the Infinet Malta Ltd. R5000-Mmx/58.300.2x200.2x23, with the requirements of Part 15, §15.247. All references are to the most current version of Title 47 of the Code of Federal Regulations in effect. In accordance with §2.1033, the following data is presented in support of the Certification of the R5000-Mmx/58.300.2x200.2x23. Infinet Malta Ltd. should retain a copy of this document which should be kept on file for at least two years after the manufacturing of the R5000-Mmx/58.300.2x200.2x23, has been **permanently** discontinued.

B. Executive Summary

The following tests were conducted on a sample of the equipment for the purpose of demonstrating compliance with Part 15, §15.247, in accordance with Infinet Malta Ltd., purchase order number MET-06. All tests were conducted using measurement procedure ANSI C63.4-2003.

FCC Reference 47 CFR Part 15.247:2005	IC Reference RSS-210 Issue 8: 2010; RSS-GEN Issue 3: 2010	Description	Compliance
47 CFR Part 15.107 (a)	ICES-003 Issue 4 February 2004	Conducted Emission Limits for a Class A Digital Device	Compliant
47 CFR Part 15.109 (a)	ICES-003 Issue 4 February 2004	Radiated Emission Limits for a Class A Digital Device	Compliant
Title 47 of the CFR, Part 15 §15.203	N/A	Antenna Requirement	Compliant
Title 47 of the CFR, Part 15 §15.207(a)	RSS-GEN (7.2.4)	Conducted Emission Limits	Compliant
Title 47 of the CFR, Part 15 §15.247(a)(2)	RSS-Gen(4.6)	6dB Occupied Bandwidth	Compliant
		99% Occupied Bandwidth	Compliant
Title 47 of the CFR, Part 15 §15.247(b)	RSS-210(A8.4)	Peak Power Output	Compliant
Title 47 of the CFR, Part 15 §15.247(d); §15.209; §15.205	RSS-210(A8.5)	Radiated Spurious Emissions Requirements	Compliant
Title 47 of the CFR, Part 15 §15.247(d)	RSS-210(A8.5)	RF Conducted Spurious Emissions Requirements	Compliant
Title 47 of the CFR, Part 15 §15.247(d)	RSS-210(A8.5)	RF Conducted Band Edge	Compliant
Title 47 of the CFR, Part 15; §15.247(e)	RSS-210(A8.2)	Peak Power Spectral Density	Compliant
Title 47 of the CFR, Part 15 §15.247(i)	RSS-Gen(5.6)	Maximum Permissible Exposure (MPE)	Compliant
N/A	RSS-Gen(4.10)	Receiver Spurious Emissions	Compliant

Table 1. Executive Summary of EMC Part 15.247 Compliance Testing

II. Equipment Configuration

A. Overview

MET Laboratories, Inc. was contracted by Infinet Malta Ltd. to perform testing on the R5000-Mmx/58.300.2x200.2x23, under Infinet Malta Ltd.'s purchase order number MET-06.

This document describes the test setups, test methods, required test equipment, and the test limit criteria used to perform compliance testing of the Infinet Malta Ltd., R5000-Mmx/58.300.2x200.2x23.

The results obtained relate only to the item(s) tested.

Model(s) Tested:	R5000-Mmx/58.300.2x200.2x23	
Model(s) Covered:	R5000-Mmx/58.300.2x200.2x23	
EUT Specifications:	Primary Power: 120 VAC, 60 Hz	
	FCC ID: X8Q-MMX-5X2323 IC: 9144A-MMX5X2323	
	Type of Modulations:	OFDM
	Equipment Code:	DTS
	Peak RF Output Power:	0.056 W (HT20) 0.033 W (HT40)
	EUT Frequency Ranges:	5740 – 5840 MHz (20 MHz channels) 5750 – 5830 MHz (40 MHz channels)
Analysis:	The results obtained relate only to the item(s) tested.	
Environmental Test Conditions:	Temperature: 15-35° C	
	Relative Humidity: 30-60%	
	Barometric Pressure: 860-1060 mbar	
Evaluated by:	Dusmantha Tennakoon, Jeff Pratt	
Report Date(s):	September 6, 2011	

Table 2. EUT Summary Table

B. References

CFR 47, Part 15, Subpart C	Federal Communication Commission, Code of Federal Regulations, Title 47, Part 15: General Rules and Regulations, Allocation, Assignment, and Use of Radio Frequencies
CFR 47, Part 15, Subpart B	Electromagnetic Compatibility: Criteria for Radio Frequency Devices
RSS-210, Issue 8, Dec. 2010	Low-power Licence-exempt Radiocommunications Devices (All Frequency Bands): Category I Equipment
RSS-GEN, Issue 3, Dec. 2010	General Requirements and Information for the Certification of Radio Apparatus
ICES-003, Issue 4 February 2004	Electromagnetic Compatibility: Criteria for Radio Frequency Devices
ANSI C63.4:2003	Methods and Measurements of Radio-Noise Emissions from Low-Voltage Electrical And Electronic Equipment in the Range of 9 kHz to 40 GHz
ANSI/NCSL Z540-1-1994	Calibration Laboratories and Measuring and Test Equipment - General Requirements
ANSI/ISO/IEC 17025:2000	General Requirements for the Competence of Testing and Calibration Laboratories
ANSI C63.10-2009	American National Standard for Testing Unlicensed Wireless Devices

Table 3. References

C. Test Site

All testing was performed at MET Laboratories, Inc., 914 W. Patapsco Ave., Baltimore, MD 21230. All equipment used in making physical determinations is accurate and bears recent traceability to the National Institute of Standards and Technology.

Radiated Emissions measurements were performed in a 3 meter semi-anechoic chamber (equivalent to an Open Area Test Site). In accordance with §2.948(a)(3), a complete site description is contained at MET Laboratories.

D. Description of Test Sample

The Infinet Malta Ltd. R5000-Mmx/58.300.2x200.2x23, Equipment Under Test (EUT), is a High-performance broadband wireless system



Photograph 1. Infinet Malta Ltd. R5000-Mmx/58.300.2x200.2x23, Front View

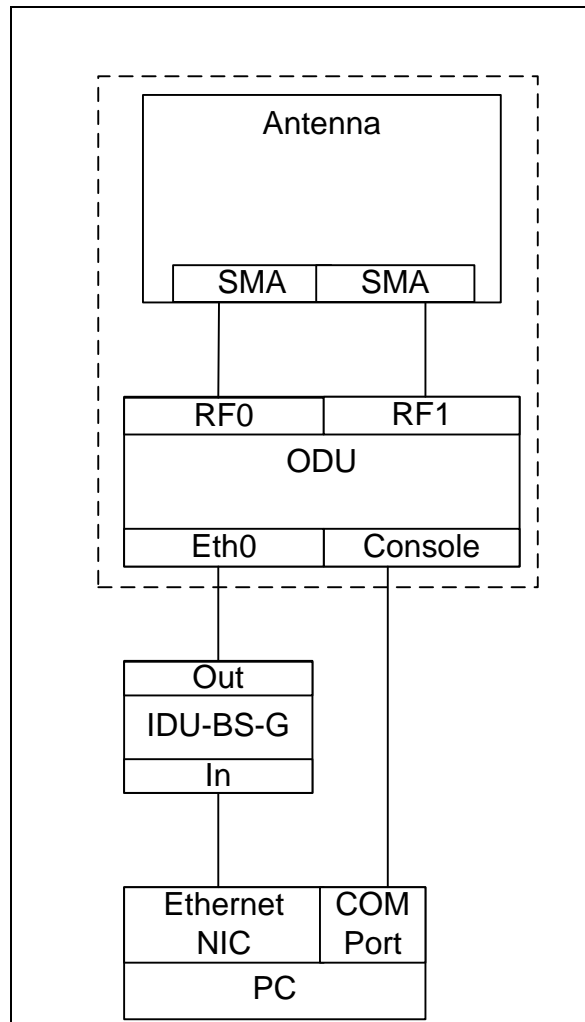

Figure 1. Block Diagram of Test Configuration

E. Equipment Configuration

The EUT was set up as outlined in Figure 1, Block Diagram of Test Setup. All cards, racks, etc., incorporated as part of the EUT is included in the following list.

Ref. ID	Name / Description	Model Number	Serial Number
1	Outdoor unit	R5000-Mmx/58.300.2x200.2x23	46136
2	Indoor unit	IDU-BS-G	N/A

Table 4. Equipment Configuration

F. Support Equipment

Support equipment necessary for the operation and testing of the EUT is included in the following list.

Ref. ID	Name / Description	Manufacturer	Model Number
1	ODU mount kit	InfiNet Wireless	MOUNT-KIT-85

Table 5. Support Equipment

G. Ports and Cabling Information

Ref. ID	Port Name on EUT	Cable Description	Qty.	Length (m)	Shielded (Y/N)	Termination Point
1	Eth0	RJ-45 cable	1	10	Y	ODU R5000-Mmx/58.300.2x200.2x23
2	Console	Console cable	1	1.5	N	ODU R5000-Mmx/58.300.2x200.2x23
3	RF0	RF cable	1	1	Y	ODU R5000-Mmx/58.300.2x200.2x23
4	RF1	RF cable	1	1	Y	ODU R5000-Mmx/58.300.2x200.2x23
5	In	RJ-45 cable	1	1	N	IDU-BS-G
6	Out	RJ-45 cable	1	10	Y	IDU-BS-G
7	SMA	RF cable	2	1	Y	Antenna

Table 6. Ports and Cabling Information

H. Mode of Operation

The EUT is intended to operate in point-to-point mode with the unit of the same model as a peer.

I. Method of Monitoring EUT Operation

The EUT is performing according to the manufacturer's intended operation if it is capable to provide data channel with capacity of 1 Mbps or higher measured for TCP traffic as 1 minute average value.

If the unit is not capable to provide such a channel it is not performing according to the manufacturer's intended operation.

J. Modifications

a) Modifications to EUT

No modifications were made to the EUT.

b) Modifications to Test Standard

No modifications were made to the test standard.

K. Disposition of EUT

The test sample including all support equipment submitted to the Electro-Magnetic Compatibility Lab for testing was returned to Infinet Malta Ltd. upon completion of testing.

III. Electromagnetic Compatibility Criteria for Unintentional Radiators

Electromagnetic Compatibility Criteria

§ 15.107 Conducted Emissions Limits

Test Requirement(s): **15.107 (a)** Except for Class A digital devices, for equipment that is designed to be connected to the public utility (AC) power line, the radio frequency voltage that is conducted back onto the AC power line on any frequency or frequencies within the band 150 kHz to 30 MHz shall not exceed the limits in Table 7. Compliance with this provision shall be based on the measurement of the radio frequency voltage between each power line and ground at the power terminals.

15.107 (b) For a Class A digital device that is designed to be connected to the public utility (AC) power line, the radio frequency voltage that is conducted back onto the AC power line on any frequency or frequencies within the band 150 kHz to 30 MHz shall not exceed the limits in Table 7. Compliance with this provision shall be based on the measurement of the radio frequency voltage between each power line and ground at the power terminals. The lower limit applies at the band edges.

15.207(a), Except as shown in paragraphs (b) and (c) of this section*, charging, AC adapters or battery eliminators the radio frequency voltage that is conducted back onto the AC power line on any frequency or frequencies, within the band 150 kHz to 30 MHz, shall not exceed the limits in the Table 7, as measured using a 50 μ H/50 ohms line impedance stabilization network (LISN). Compliance with the provisions of this paragraph shall be based on the measurement of the radio frequency voltage between each power line and ground at the power terminal. The lower limit applies at the boundary between the frequencies ranges.

Frequency range (MHz)	Class A Conducted Limits (dB μ V)		*Class B Conducted Limits (dB μ V)	
	Quasi-Peak	Average	Quasi-Peak	Average
* 0.15- 0.45	79	66	66 - 56	56 - 46
0.45 - 0.5	79	66	56	46
0.5 - 30	73	60	60	50

Note 1 — The lower limit shall apply at the transition frequencies.
 Note 2 — The limit decreases linearly with the logarithm if the frequency in the range 0.15 MHz to 0.5 MHz.
 * -- Limits per Subsection 15.207(a).

Table 7. Conducted Limits for Radio Frequency Devices calculated from FCC Part 15 Subsections 15.107(a) (b) and 15.207(a)

Test Results: The EUT was compliant with the Class A requirement(s) of this section. Measured emissions were below applicable limits.

Test Engineer(s): Jeff Pratt

Test Date(s): 08/05/11

Conducted Emissions - Voltage, AC Power, Phase Line (120 VAC, 60 Hz)

Frequency (MHz)	Uncorrected Meter Reading (dBuV) QP	Cable Loss (dB)	Corrected Measurement (dBuV) QP	Limit (dBuV) QP	Margin (dB) QP	Uncorrected Meter Reading (dBuV) Avg.	Cable Loss (dB)	Corrected Measurement (dBuV) AVG	Limit (dBuV) AVG	Margin (dB) AVG
0.513	37.12	0	37.12	73	-35.88	29.36	0	29.36	60	-30.64
0.899	36.61	0	36.61	73	-36.39	24.9	0	24.9	60	-35.1
11.79	33.35	0.17	33.52	73	-39.48	27.31	0.17	27.48	60	-32.52
21.55	36.08	0.23	36.31	73	-36.69	32.78	0.23	33.01	60	-26.99
21.8	38.63	0.23	38.86	73	-34.14	36.29	0.23	36.52	60	-23.48
22.28	37.77	0.23	38	73	-35	35.51	0.23	35.74	60	-24.26

Table 8. Conducted Emissions - Voltage, AC Power, Phase Line (120 VAC, 60 Hz)

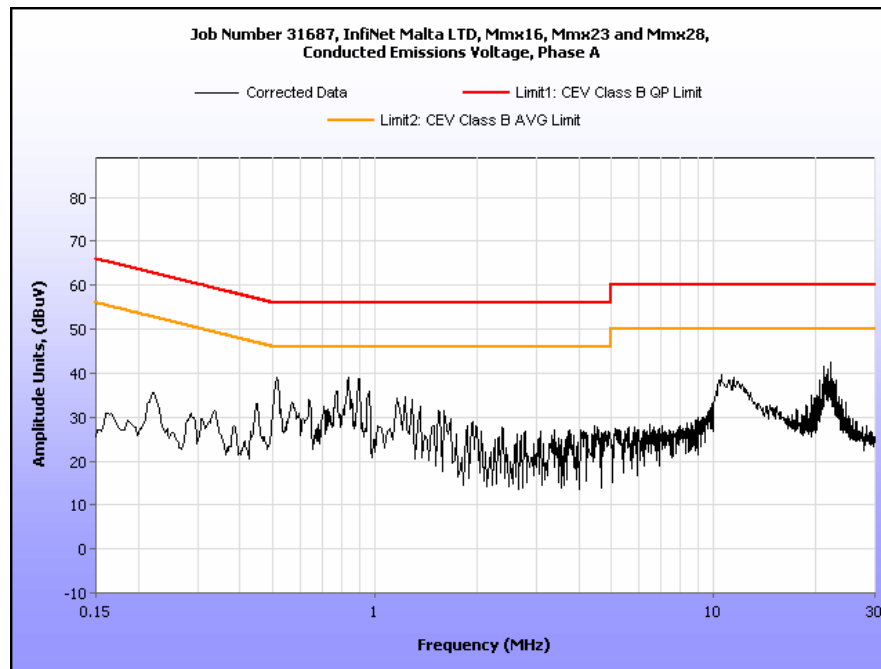

Plot 1. Conducted Emission, Phase Line Plot

Conducted Emissions - Voltage, AC Power, Neutral Line (120 VAC, 60 Hz)

Frequency (MHz)	Uncorrected Meter Reading (dBuV) QP	Cable Loss (dB)	Corrected Measurement (dBuV) QP	Limit (dBuV) QP	Margin (dB) QP	Uncorrected Meter Reading (dBuV) Avg.	Cable Loss (dB)	Corrected Measurement (dBuV) AVG	Limit (dBuV) AVG	Margin (dB) AVG
0.515	34.74	0	34.74	73	-38.26	24.25	0	24.25	60	-35.75
10.45	27.37	0.17	27.54	73	-45.46	22.88	0.17	23.05	60	-36.95
20.6	34.96	0.22	35.18	73	-37.82	32.18	0.22	32.4	60	-27.6
21.32	34.92	0.22	35.14	73	-37.86	32.21	0.22	32.43	60	-27.57
21.79	31.2	0.23	31.43	73	-41.57	28.17	0.23	28.4	60	-31.6
22.29	26.63	0.23	26.86	73	-46.14	21.9	0.23	22.13	60	-37.87

Table 9. Conducted Emissions - Voltage, AC Power, Neutral Line (120 VAC, 60 Hz)

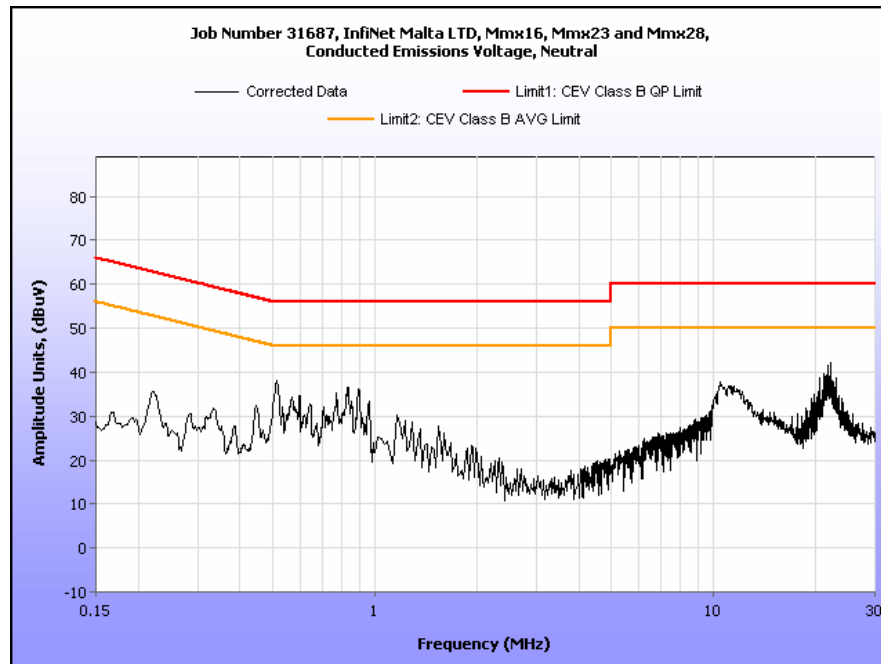

Plot 2. Conducted Emission, Neutral Line Plot

Conducted Emission Limits Test Setup



Photograph 2. Conducted Emissions, Test Setup

Radiated Emission Limits

§ 15.109 Radiated Emissions Limits

Test Requirement(s): **15.109 (a)** Except for Class A digital devices, the field strength of radiated emissions from unintentional radiators at a distance of 3 meters shall not exceed the Class B limits expressed in Table 10.

15.109 (b) The field strength of radiated emissions from a Class A digital device, as determined at a distance of 10 meters, shall not exceed the Class A limits expressed in Table 10.

Frequency (MHz)	Field Strength (dB μ V/m)	
	§15.109 (b), Class A Limit (dB μ V) @ 10m	§15.109 (a), Class B Limit (dB μ V) @ 3m
30 - 88	39.00	40.00
88 - 216	43.50	43.50
216 - 960	46.40	46.00
Above 960	49.50	54.00

Table 10. Radiated Emissions Limits calculated from FCC Part 15, §15.109 (a) (b)

Test Procedures: The EUT was placed on a non-metallic table, 80 cm above the ground plane inside a semi-anechoic chamber. The method of testing and test conditions of ANSI C63.4 were used. An antenna was located 3 m from the EUT on an adjustable mast. A pre-scan was first performed in order to find prominent radiated emissions. For final emissions measurements at each frequency of interest, the EUT was rotated and the antenna height was varied between 1 m and 4 m in order to maximize the emission. Measurements in both horizontal and vertical polarities were made and the data was recorded. Unless otherwise specified, measurements were made using a quasi-peak detector with a 120 kHz bandwidth.

Test Results: The EUT was compliant with the Class A requirement(s) of this section. Measured emissions were below applicable limits.

Test Engineer(s): Jeff Pratt

Test Date(s): 08/04/11

Radiated Emissions Limits Test Results, Class A

Frequency (MHz)	EUT Azimuth (Degrees)	Antenna Polarity (H/V)	Antenna HEIGHT (m)	Uncorrected Amplitude (dBuV)	Antenna Correction Factor (dB) (+)	Cable Loss (dB) (+)	Distance Correction Factor (dB) (-)	Corrected Amplitude (dBuV/m)	Limit (dBuV/m)	Margin (dB)
83.366734	175	H	1.01	11.74	7.66	0.23	0.00	19.63	40.00	-20.37
83.366734	175	V	1.01	27.72	7.66	0.23	0.00	35.61	40.00	-4.39
249.97745	152	H	1.12	29.45	12.10	0.50	0.00	42.05	46.00	-3.95
249.97745	236	V	1.01	29.61	12.10	0.50	0.00	42.21	46.00	-3.79
50.413828	361	H	1.01	6.23	8.36	0.23	0.00	14.82	40.00	-25.18
50.413828	57	V	1.12	25.43	8.36	0.23	0.00	34.02	40.00	-5.98
374.96668	179	H	1.01	16.26	15.50	0.83	0.00	32.59	46.00	-13.41
374.96668	299	V	1.32	14.48	15.50	0.83	0.00	30.81	46.00	-15.19
74.709419	185	H	2.19	14.15	8.03	0.23	0.00	22.41	40.00	-17.59
74.709419	168	V	1.12	27.56	8.03	0.23	0.00	35.82	40.00	-4.18
62.453908	79	H	1.08	7.11	7.60	0.23	0.00	14.94	40.00	-25.06
62.453908	149	V	1.00	26.75	7.60	0.23	0.00	34.58	40.00	-5.42

Table 11. Radiated Emissions Limits, Test Results, 30 MHz – 1 GHz, FCC Limits

Note: The EUT was tested at 3 m.

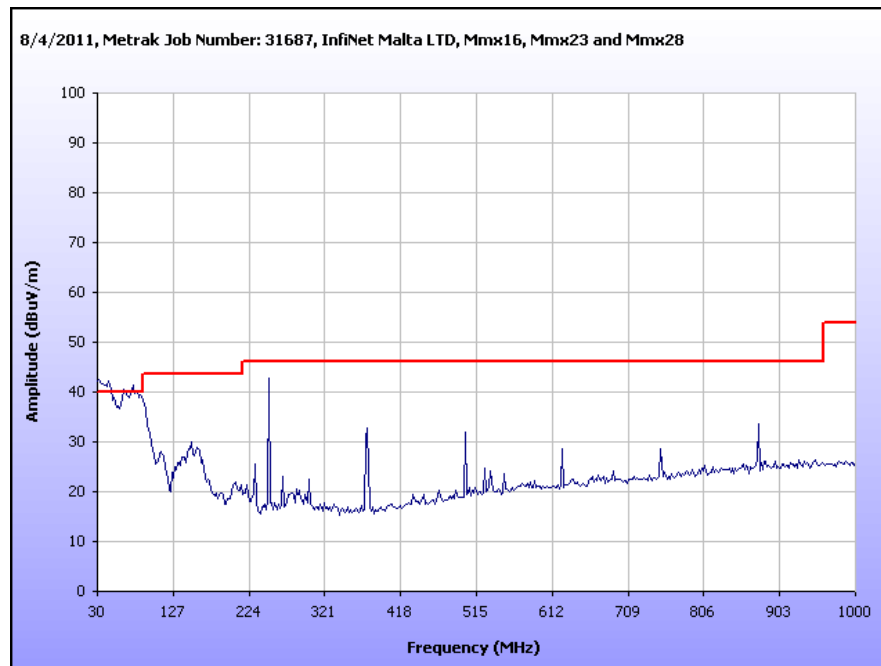

Plot 3. Radiated Emissions, 30 MHz - 1 GHz, FCC Limits

Radiated Emissions Limits Test Results, Class A

Frequency (MHz)	EUT Azimuth (Degrees)	Antenna Polarity (H/V)	Antenna HEIGHT (m)	Uncorrected Amplitude (dBuV)	Antenna Correction Factor (dB) (+)	Cable Loss (dB) (+)	Distance Correction Factor (dB) (-)	Corrected Amplitude (dBuV/m)	Limit (dBuV/m)	Margin (dB)
83.366734	175	H	1.01	11.74	7.66	0.23	10.46	9.17	30.00	-20.83
83.366734	175	V	1.01	27.72	7.66	0.23	10.46	25.15	30.00	-4.85
249.97745	152	H	1.12	29.45	12.10	0.50	10.46	31.59	37.00	-5.41
249.97745	236	V	1.01	29.61	12.10	0.50	10.46	31.75	37.00	-5.25
50.413828	361	H	1.01	6.23	8.36	0.23	10.46	4.36	30.00	-25.64
50.413828	57	V	1.12	25.43	8.36	0.23	10.46	23.56	30.00	-6.44
374.96668	179	H	1.01	16.26	15.50	0.83	10.46	22.13	37.00	-14.87
374.96668	299	V	1.32	14.48	15.50	0.83	10.46	20.35	37.00	-16.65
74.709419	185	H	2.19	14.15	8.03	0.23	10.46	11.95	30.00	-18.05
74.709419	168	V	1.12	27.56	8.03	0.23	10.46	25.36	30.00	-4.64
62.453908	79	H	1.08	7.11	7.60	0.23	10.46	4.48	30.00	-25.52
62.453908	149	V	1.00	26.75	7.60	0.23	10.46	24.12	30.00	-5.88

Table 12. Radiated Emissions Limits, Test Results, ICES-003 Limits

Note: The EUT was tested at 3 m.

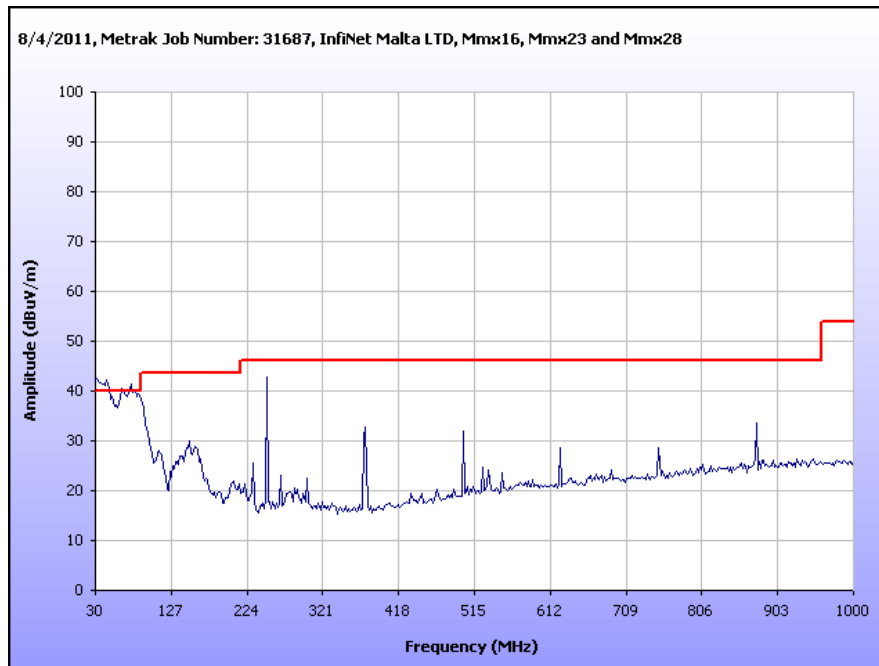

Plot 4. Radiated Emissions, ICES-003 Limits

Radiated Emission Limits Test Setup



Photograph 3. Radiated Emission, Test Setup

IV. Electromagnetic Compatibility Criteria for Intentional Radiators

Electromagnetic Compatibility Criteria for Intentional Radiators

§ 15.203 Antenna Requirement

Test Requirement: § 15.203: An intentional radiator shall be designed to ensure that no antenna other than that furnished by the responsible party shall be used with the device. The use of a permanently attached antenna or of an antenna that uses a unique coupling to the intentional radiator shall be considered sufficient to comply with the provisions of this section. The manufacturer may design the unit so that a broken antenna can be replaced by the user, but the use of a standard antenna jack or electrical connector is prohibited.

The structure and application of the EUT were analyzed to determine compliance with Section 15.203 of the Rules. Section 15.203 states that the subject device must meet at least one of the following criteria:

- a.) Antenna must be permanently attached to the unit.
- b.) Antenna must use a unique type of connector to attach to the EUT.
- c.) Unit must be professionally installed. Installer shall be responsible for verifying that the correct antenna is employed with the unit.

Results: The EUT as tested is compliant the criteria of §15.203. The EUT is intended to be professionally installed (point-to-point).

Test Engineer(s): Dusmantha Tennakoon & Jeff Pratt

Test Date(s): 06/15/11 & 08/08/11

Antenna Type	Gain (dBi)	Manufacturer
Panel	23	InfiNet Malta

Electromagnetic Compatibility Criteria for Intentional Radiators

§ 15.207(a) Conducted Emissions Limits

Test Requirement(s): § 15.207 (a): For an intentional radiator that is designed to be connected to the public utility (AC) power line, the radio frequency voltage that is conducted back onto the AC power line on any frequency or frequencies, within the band 150 kHz to 30MHz, shall not exceed the limits in the following table, as measured using a 50 μ H/50 Ω line impedance stabilization network (LISN). Compliance with the provisions of this paragraph shall be based on the measurement of the radio frequency voltage between each power line and ground at the power terminal. The lower limit applies at the boundary between the frequency ranges.

Frequency range (MHz)	§ 15.207(a), Conducted Limit (dB μ V)	
	Quasi-Peak	Average
* 0.15- 0.45	66 - 56	56 - 46
0.45 - 0.5	56	46
0.5 - 30	60	50

Table 13. Conducted Limits for Intentional Radiators from FCC Part 15 § 15.207(a)

Test Procedure: The EUT was placed on a 0.8 m-high wooden table inside a screen room. The EUT was situated such that the back of the EUT was 0.4 m from one wall of the vertical ground plane, and the remaining sides of the EUT were no closer than 0.8 m from any other conductive surface. The EUT was powered from a 50 Ω /50 μ H Line Impedance Stabilization Network (LISN). The EMC receiver scanned the frequency range from 150 kHz to 30 MHz. Conducted Emissions measurements were made in accordance with *ANSI C63.4-2003 "Methods and Measurements of Radio-Noise Emissions from Low-Voltage Electrical and Electronic Equipment in the Range of 9kHz to 40 GHz"*. The measurements were performed over the frequency range of 0.15 MHz to 30 MHz using a 50 Ω /50 μ H LISN as the input transducer to an EMC/field intensity meter. For the purpose of this testing, the transmitter was turned on. Scans were performed with the transmitter on.

Test Results: The EUT was compliant with this requirement. Measured emissions were below applicable limits.

Test Engineer(s): Jeff Pratt

Test Date(s): 08/05/11

15.207(a) Conducted Emissions Test Results

Frequency (MHz)	Uncorrected Meter Reading (dBuV) QP	Cable Loss (dB)	Corrected Measurement (dBuV) QP	Limit (dBuV) QP	Margin (dB) QP	Uncorrected Meter Reading (dBuV) Avg.	Cable Loss (dB)	Corrected Measurement (dBuV) AVG	Limit (dBuV) AVG	Margin (dB) AVG
22.28	37.77	0.23	38	60	-22	35.51	0.23	35.74	50	-14.26
0.899	36.61	0	36.61	56	-19.39	24.9	0	24.9	46	-21.1
21.8	38.63	0.23	38.86	60	-21.14	36.29	0.23	36.52	50	-13.48
0.513	37.12	0	37.12	56	-18.88	29.36	0	29.36	46	-16.64
21.55	36.08	0.23	36.31	60	-23.69	32.78	0.23	33.01	50	-16.99
11.79	33.35	0.17	33.52	60	-26.48	27.31	0.17	27.48	50	-22.52

Table 14. Conducted Emissions, 15.207(a), Phase Line, Test Results

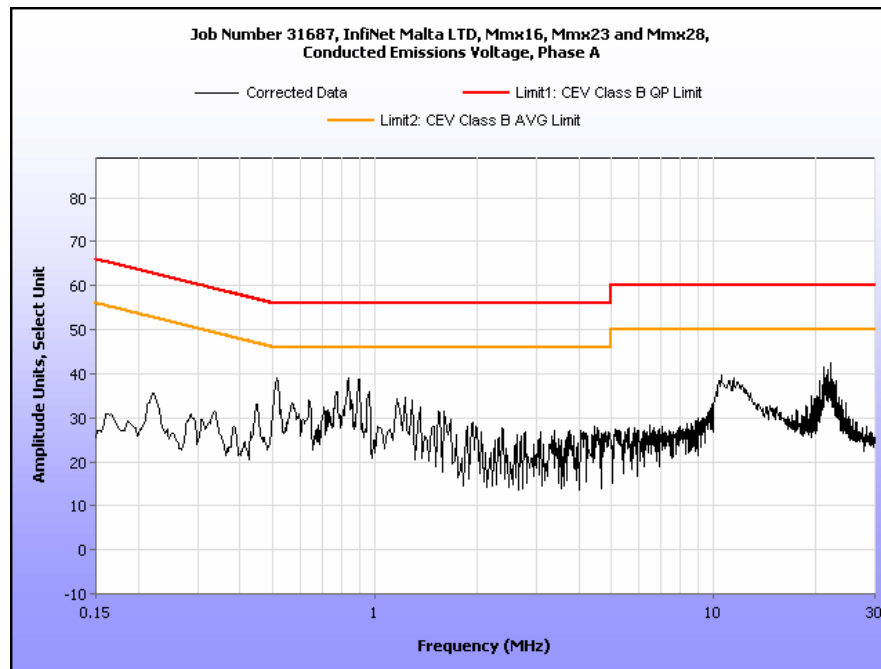

Plot 5. Conducted Emissions, 15.207(a), Phase Line

15.207(a) Conducted Emissions Test Results

Frequency (MHz)	Uncorrected Meter Reading (dBuV) QP	Cable Loss (dB)	Corrected Measurement (dBuV) QP	Limit (dBuV) QP	Margin (dB) QP	Uncorrected Meter Reading (dBuV) Avg.	Cable Loss (dB)	Corrected Measurement (dBuV) AVG	Limit (dBuV) AVG	Margin (dB) AVG
22.29	26.63	0.23	26.86	60	-33.14	21.9	0.23	22.13	50	-27.87
21.79	31.2	0.23	31.43	60	-28.57	28.17	0.23	28.4	50	-21.6
0.515	34.74	0	34.74	56	-21.26	24.25	0	24.25	46	-21.75
10.45	27.37	0.17	27.54	60	-32.46	22.88	0.17	23.05	50	-26.95
21.32	34.92	0.22	35.14	60	-24.86	32.21	0.22	32.43	50	-17.57
20.6	34.96	0.22	35.18	60	-24.82	32.18	0.22	32.4	50	-17.6

Table 15. Conducted Emissions, 15.207(a), Neutral Line, Test Results

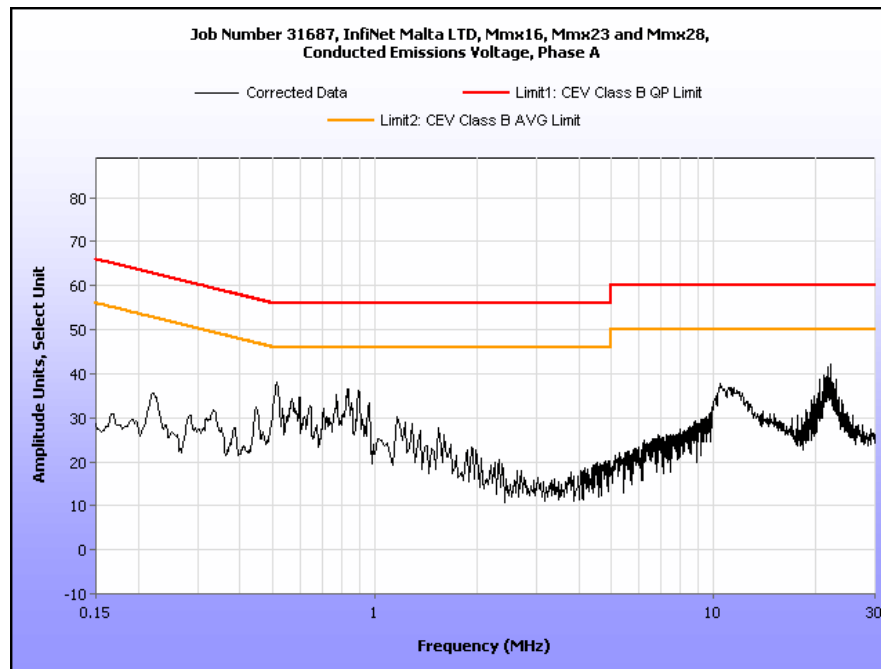

Plot 6. Conducted Emissions, 15.207(a), Neutral Line

15.207(a) Conducted Emissions Test Setup Photo



Photograph 4. Conducted Emissions, 15.207(a), Test Setup

Electromagnetic Compatibility Criteria for Intentional Radiators

§ 15.247(a)(2) 6 dB and 99% Bandwidth

Test Requirements: § 15.247(a)(2): Operation under the provisions of this section is limited to frequency hopping and digitally modulated intentional radiators that comply with the following provisions:

For systems using digital modulation techniques, the EUT may operate in the 902-928 MHz, 2400-2483.5 MHz and 5725-5850 MHz bands. The minimum 6dB bandwidth shall be at least 500 kHz.

Test Procedure: The transmitter was on and transmitting at the highest output power. The bandwidth of the fundamental frequency was measured with the spectrum analyzer using a RBW approximately 1% of the total emission bandwidth, VBW > RBW. The 6 dB Bandwidth was measured and recorded. The measurements were performed on the low, mid and high channels.

Test Results The EUT was compliant with § 15.247 (a)(2).

The 6 dB and 99% Bandwidth was determined from the plots on the following pages.

Test Engineer(s): Dusmantha Tennakoon & Jeff Pratt

Test Date(s): 06/15/11 & 08/02/11

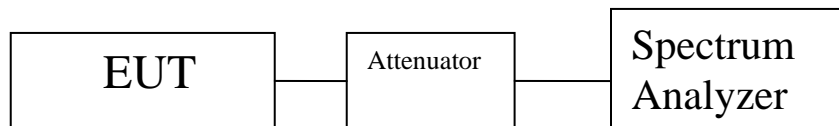

Figure 2. Block Diagram, Occupied Bandwidth Test Setup

Occupied Bandwidth Test Results

Occupied Bandwidth		
Carrier Channel	Frequency (MHz)	Measured 6 dB Bandwidth (MHz)
Low	5740	17.793
Mid	5800	17.821
High	5840	17.804

Table 16. 6 dB Occupied Bandwidth, Test Results, 20 MHz, Horizontal Feed

Occupied Bandwidth		
Carrier Channel	Frequency (MHz)	Measured 6 dB Bandwidth (MHz)
Low	5740	17.775
Mid	5800	17.777
High	5840	17.779

Table 17. 6 dB Occupied Bandwidth, Test Results, 20 MHz, Vertical Feed

Occupied Bandwidth		
Carrier Channel	Frequency (MHz)	Measured 6 dB Bandwidth (MHz)
Low	5750	36.435
Mid	5790	36.490
High	5830	36.532

Table 18. 6 dB Occupied Bandwidth, Test Results, 40 MHz, Horizontal Feed

Occupied Bandwidth		
Carrier Channel	Frequency (MHz)	Measured 6 dB Bandwidth (MHz)
Low	5750	36.469
Mid	5790	36.389
High	5830	36.465

Table 19. 6 dB Occupied Bandwidth, Test Results, 40 MHz, Vertical Feed

Occupied Bandwidth		
Carrier Channel	Frequency (MHz)	Measured 99% Bandwidth (MHz)
Low	5740	17.6963
Mid	5800	17.6515
High	5840	17.6694

Table 20. 99% Occupied Bandwidth, Test Results, 20 MHz, Horizontal Feed

Occupied Bandwidth		
Carrier Channel	Frequency (MHz)	Measured 99% Bandwidth (MHz)
Low	5740	17.6254
Mid	5800	17.6367
High	5840	17.6388

Table 21. 99% Occupied Bandwidth, Test Results, 20 MHz, Vertical Feed

Occupied Bandwidth		
Carrier Channel	Frequency (MHz)	Measured 99% Bandwidth (MHz)
Low	5750	36.2183
Mid	5790	36.2216
High	5830	36.2486

Table 22. 99% Occupied Bandwidth, Test Results, 40 MHz, Horizontal Feed

Occupied Bandwidth		
Carrier Channel	Frequency (MHz)	Measured 99% Bandwidth (MHz)
Low	5750	36.1998
Mid	5790	37.1437
High	5830	36.2200

Table 23. 99% Occupied Bandwidth, Test Results, 40 MHz, Vertical Feed

6 dB Occupied Bandwidth Test Results, 20 MHz, Horizontal Feed

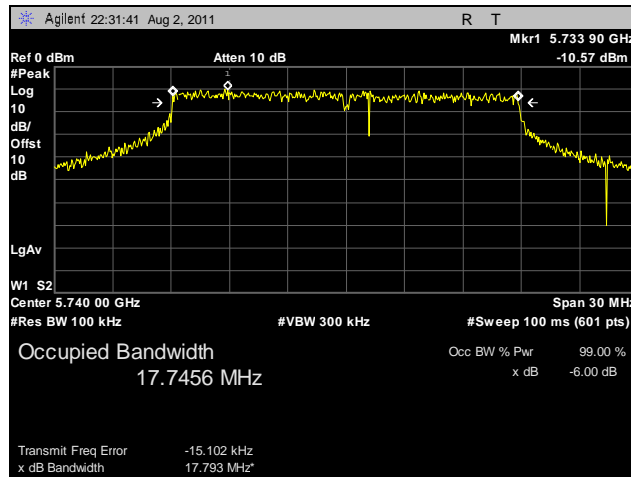

Plot 7. 6 dB Occupied Bandwidth, Low Channel, 20 MHz, Horizontal Feed

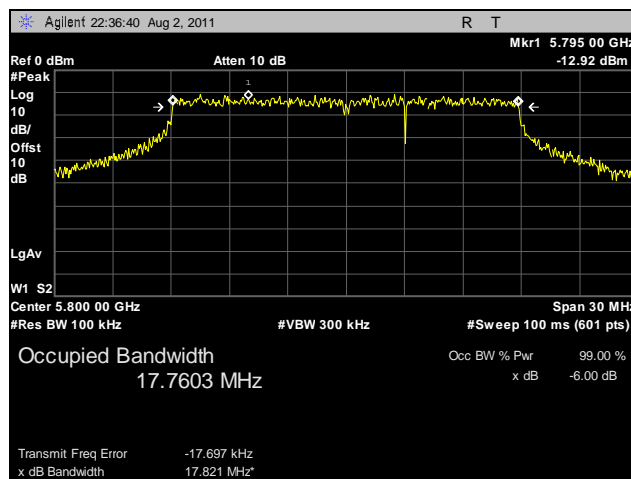

Plot 8. 6 dB Occupied Bandwidth, Mid Channel, 20 MHz, Horizontal Feed

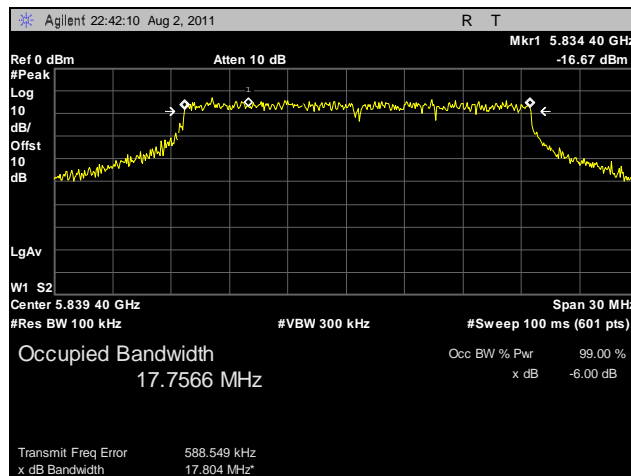

Plot 9. 6 dB Occupied Bandwidth, High Channel, 20 MHz, Horizontal Feed

6 dB Occupied Bandwidth Test Results, 20 MHz, Vertical Feed

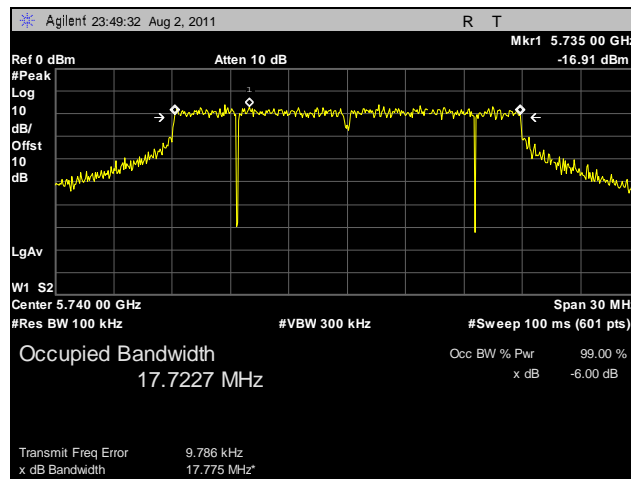

Plot 10. 6 dB Occupied Bandwidth, Low Channel, 20 MHz, Vertical Feed

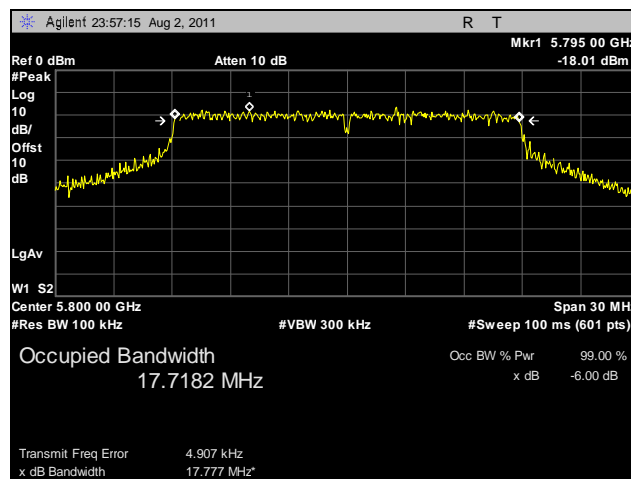

Plot 11. 6 dB Occupied Bandwidth, Mid Channel, 20 MHz, Vertical Feed

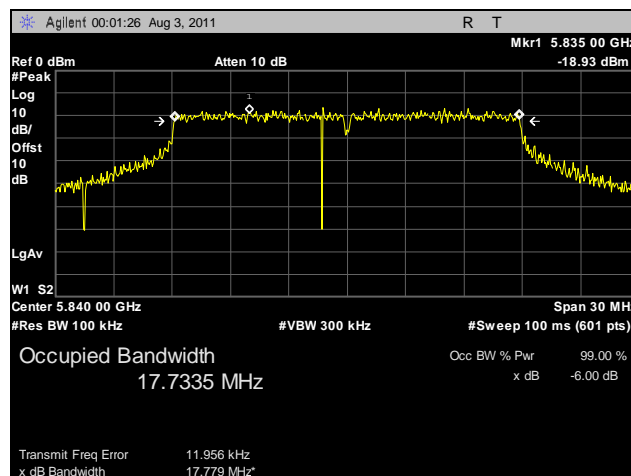

Plot 12. 6 dB Occupied Bandwidth, High Channel, 20 MHz, Vertical Feed

6 dB Occupied Bandwidth Test Results, 40 MHz, Horizontal Feed

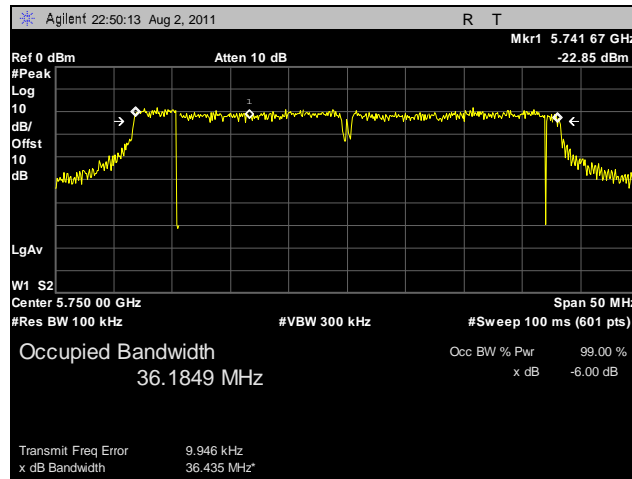

Plot 13. 6 dB Occupied Bandwidth, Low Channel, 40 MHz, Horizontal Feed

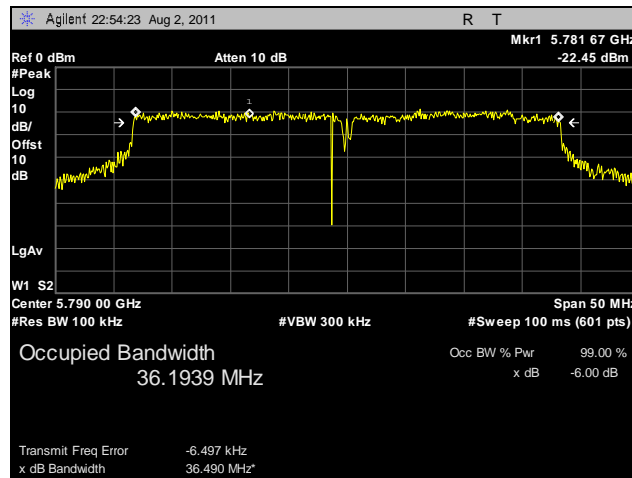

Plot 14. 6 dB Occupied Bandwidth, Mid Channel, 40 MHz, Horizontal Feed

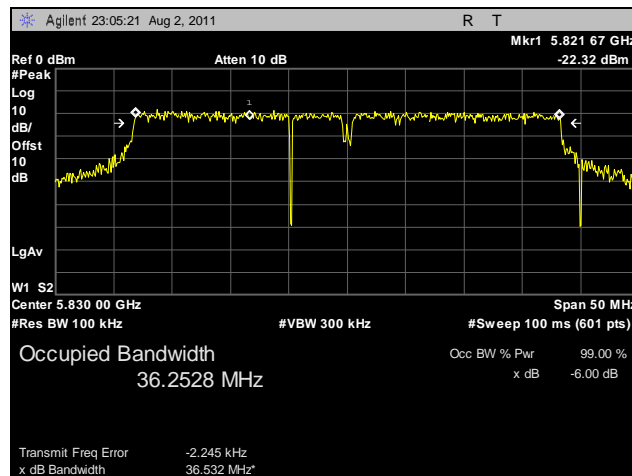

Plot 15. 6 dB Occupied Bandwidth, High Channel, 40 MHz, Horizontal Feed

6 dB Occupied Bandwidth Test Results, 40 MHz, Vertical Feed

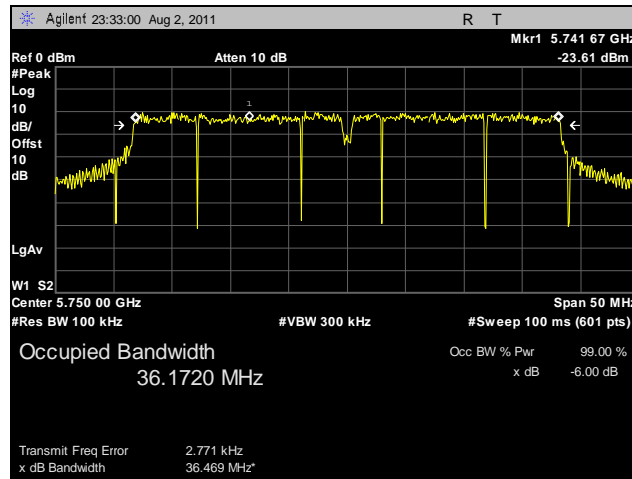

Plot 16. 6 dB Occupied Bandwidth, Low Channel, 40 MHz, Vertical Feed

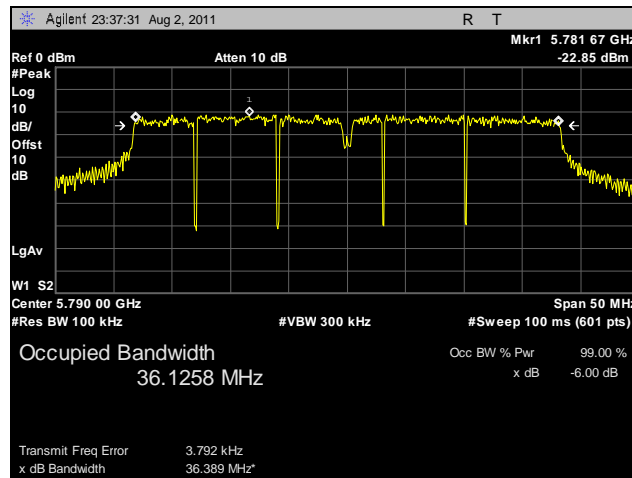

Plot 17. 6 dB Occupied Bandwidth, Mid Channel, 40 MHz, Vertical Feed

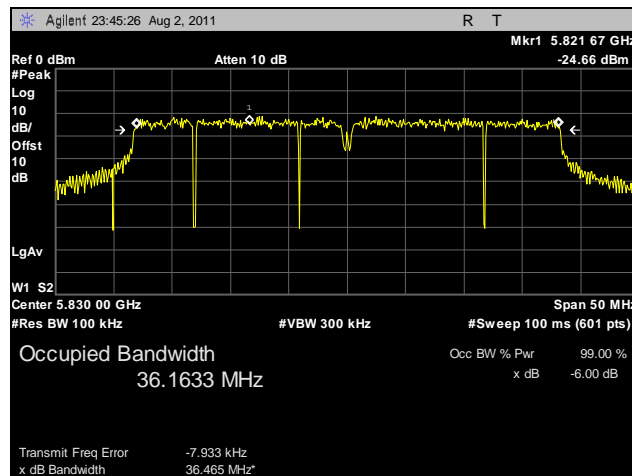

Plot 18. 6 dB Occupied Bandwidth, High Channel, 40 MHz, Vertical Feed

99% Occupied Bandwidth Test Results, 20 MHz, Horizontal Feed

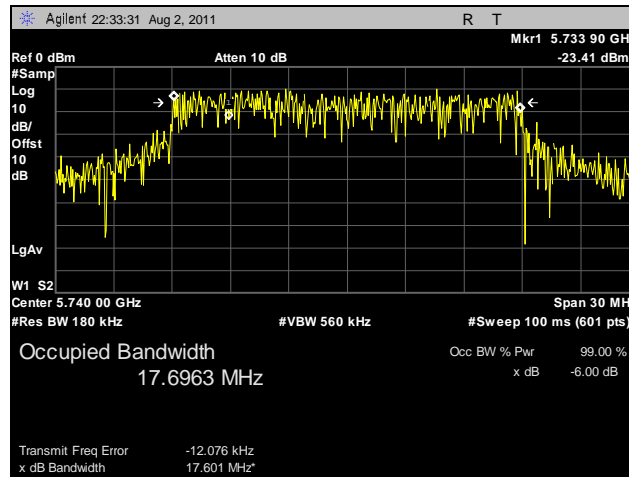

Plot 19. 99% Occupied Bandwidth, Low Channel, 20 MHz, Horizontal Feed

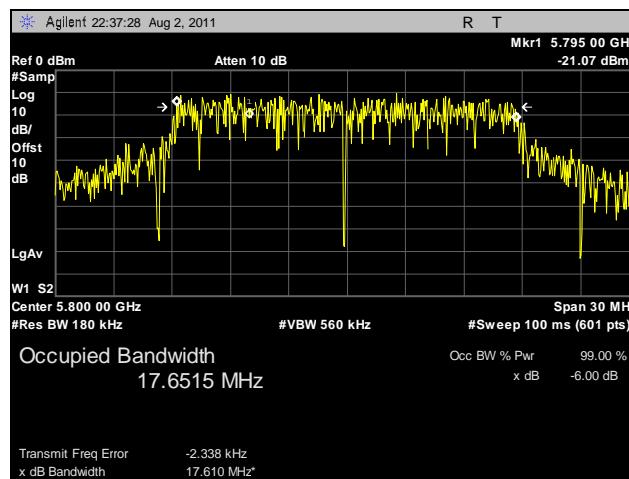

Plot 20. 99% Occupied Bandwidth, Mid Channel, 20 MHz, Horizontal Feed

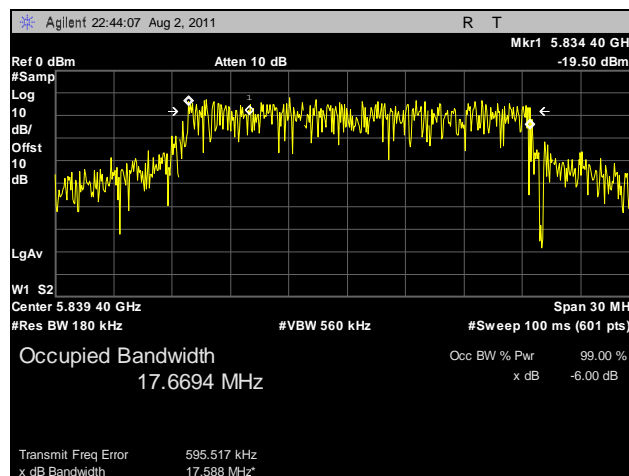

Plot 21. 99% Occupied Bandwidth, High Channel, 20 MHz, Horizontal Feed

99% Occupied Bandwidth Test Results, 20 MHz, Vertical Feed

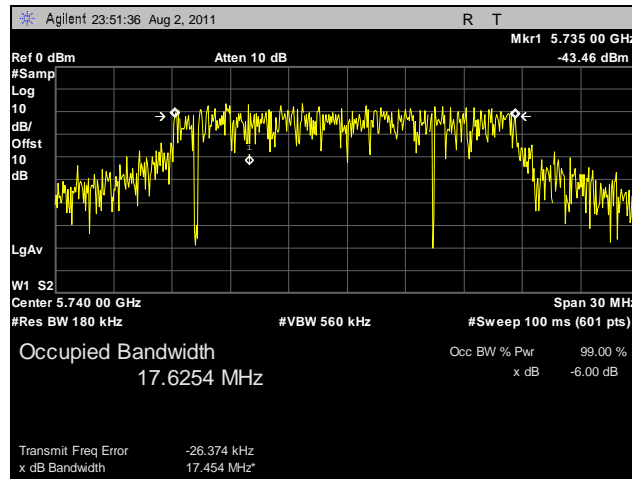

Plot 22. 99% Occupied Bandwidth, Low Channel, 20 MHz, Vertical Feed

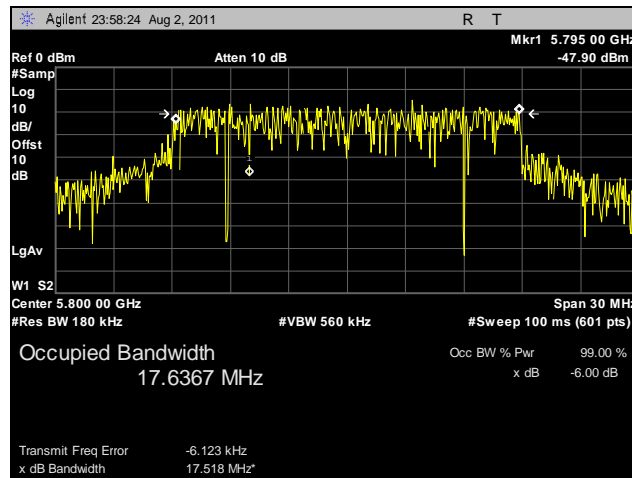

Plot 23. 99% Occupied Bandwidth, Mid Channel, 20 MHz, Vertical Feed

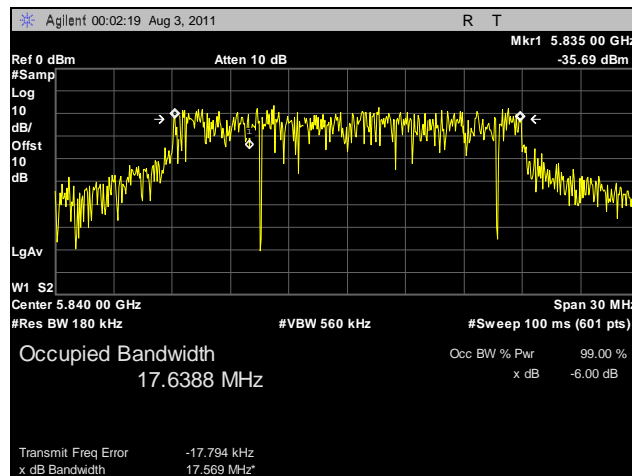

Plot 24. 99% Occupied Bandwidth, High Channel, 20 MHz, Vertical Feed

99% Occupied Bandwidth Test Results, 40 MHz, Horizontal Feed

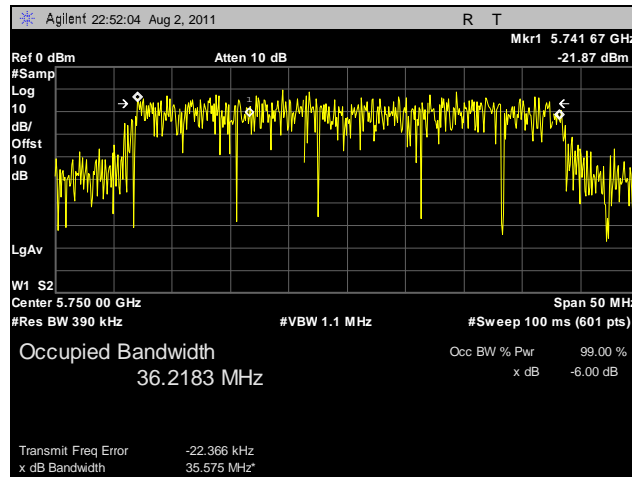

Plot 25. 99% Occupied Bandwidth, Low Channel, 40 MHz, Horizontal Feed

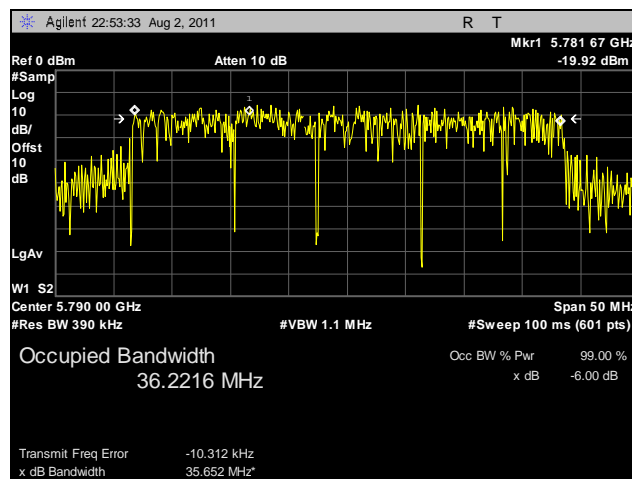

Plot 26. 99% Occupied Bandwidth, Mid Channel, 40 MHz, Horizontal Feed

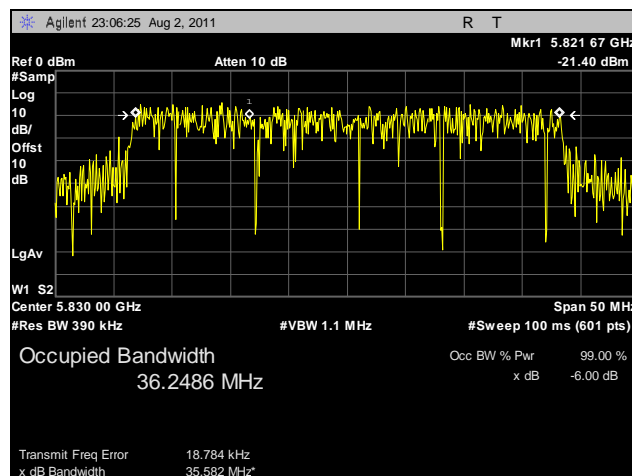

Plot 27. 99% Occupied Bandwidth, High Channel, 40 MHz, Horizontal Feed

99% Occupied Bandwidth Test Results, 40 MHz, Vertical Feed

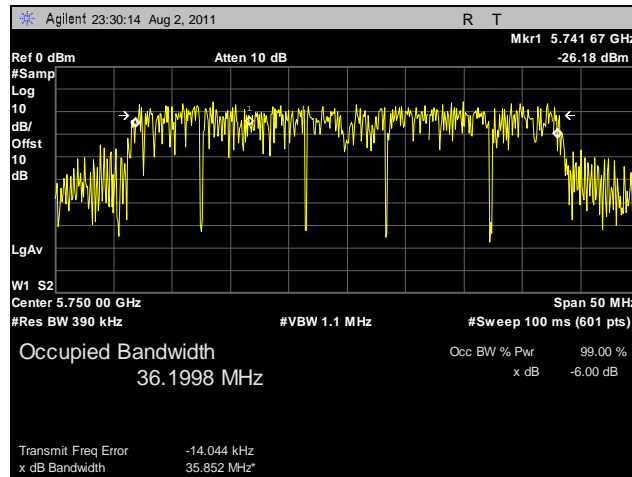

Plot 28. 99% Occupied Bandwidth, Low Channel, 40 MHz, Vertical Feed

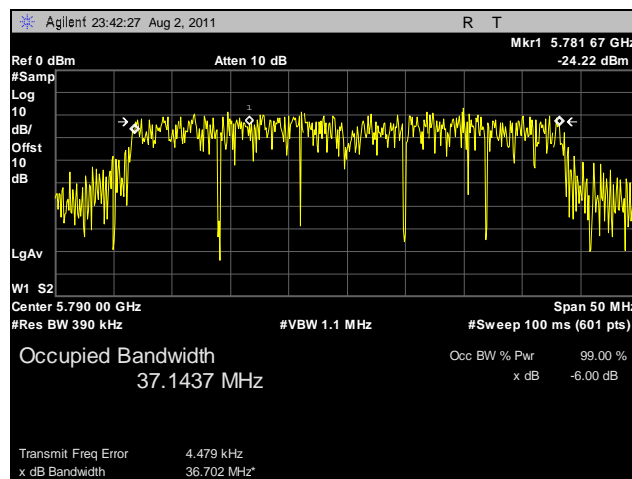

Plot 29. 99% Occupied Bandwidth, Mid Channel, 40 MHz, Vertical Feed

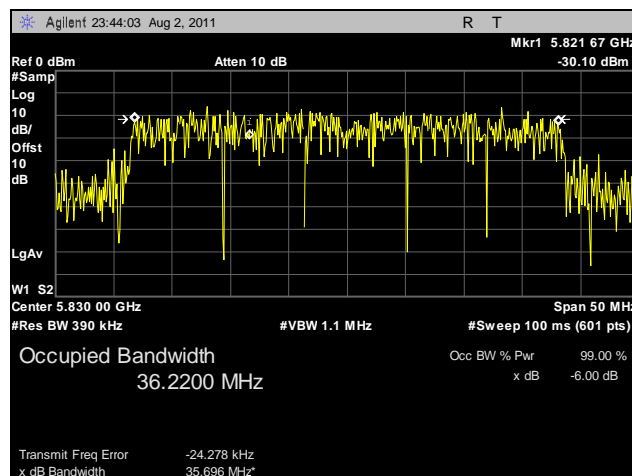

Plot 30. 99% Occupied Bandwidth, High Channel, 40 MHz, Vertical Feed

Electromagnetic Compatibility Criteria for Intentional Radiators

§ 15.247(b) Peak Power Output

Test Requirements: §15.247(b): The maximum peak output power of the intentional radiator shall not exceed the following:

Digital Transmission Systems (MHz)	Output Limit (Watts)
902-928	1.000
2400-2483.5	1.000
5725- 5850	1.000

Table 24. Output Power Requirements from §15.247(b)

§15.247(c): if transmitting antennas of directional gain greater than 6 dBi are used the peak output power from the intentional radiator shall be reduced below the stated values in the Table 24, as appropriate, by the amount in dB that the directional gain of the antenna exceeds 6 dBi.

Systems operating in the 2400 – 2483.5 MHz band and using a point to point application may employ transmitting antennas with directional gain greater than 6 dBi provided the maximum peak output power of the intentional radiator is reduced by 1 dB for every 3 dB that the directional gain of the antenna exceeds 6 dBi.

Systems operating in the 5725 – 5850 MHz band that are used exclusively for fixed, point-to-point operations may employ transmitting antennas with directional gain greater than 6 dBi without any corresponding reduction in transmitter peak output power.

Fixed, point-to-point operation excludes the use of point-to-multipoint systems, Omni-directional applications, and multiple co-located intentional radiators transmitting the same information. The operator of the spread spectrum intentional radiator or, if the equipment is professionally installed, the installer is responsible for ensuring that the system is used exclusively for fixed, point-to-point operations. The instruction manual furnished with the intentional radiator shall contain language in the installation instructions informing the operator and the installer of this responsibility.

Test Procedure: The transmitter was connected to a calibrated spectrum analyzer. The EUT was measured at the low, mid and high channels of each band at the maximum power level.

Test Results: The EUT was compliant with the Peak Power Output limits of §15.247(b).

Test Engineer(s): Jeff Pratt

Test Date(s): 08/02/11

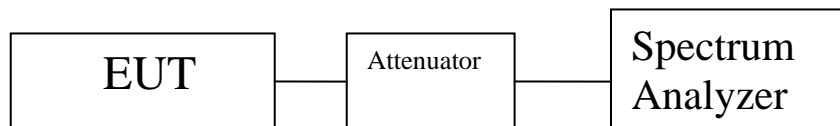

Figure 3. Peak Power Output Test Setup

Peak Power Output Test Results

Channel	Mode/Modulation Type	H feed Power (dBm)	H feed Power (mW)	V feed Power (dBm)	V feed Power (mW)	Summed Power (mW)	Summed Power (dBm)	Limit (dBm)	Margin (dB)
5740	n HT20	14.09	25.64	14.90	30.90	56.55	17.52	30	-12.48
5800	n HT20	12.53	17.91	14.35	27.23	45.13	16.54	30	-13.46
5840	n HT20	12.05	16.03	14.32	27.04	43.07	16.34	30	-13.66
5750	n HT40	11.59	14.42	12.74	18.79	33.21	15.21	30	-14.79
5790	n HT40	10.92	12.36	11.59	14.42	26.78	14.28	30	-15.72
5830	n HT40	10.83	12.11	12.67	18.49	30.60	14.86	30	-15.14

Table 25. Peak Power Output, Summed

Peak Power Output Test Results, 20 MHz, Horizontal Feed

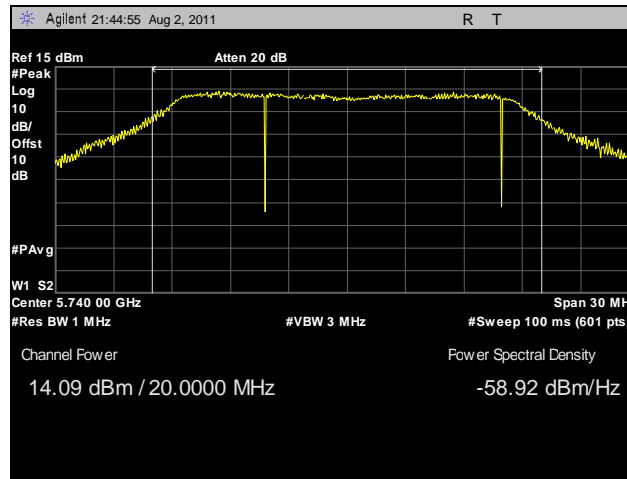

Plot 31. Peak Power Output, Low Channel, 20 MHz, Horizontal Feed

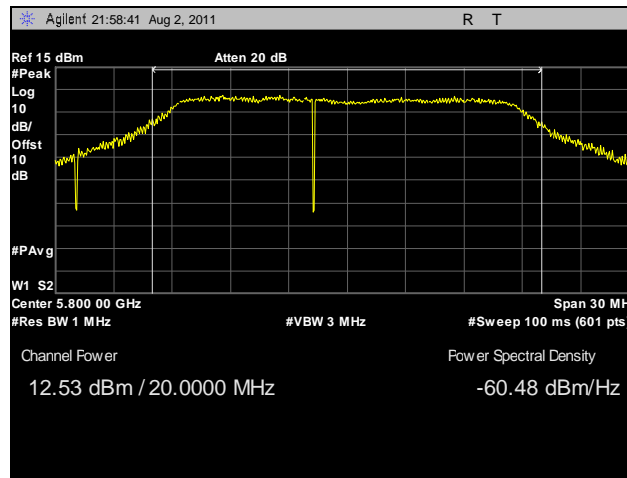

Plot 32. Peak Power Output, Mid Channel, 20 MHz, Horizontal Feed

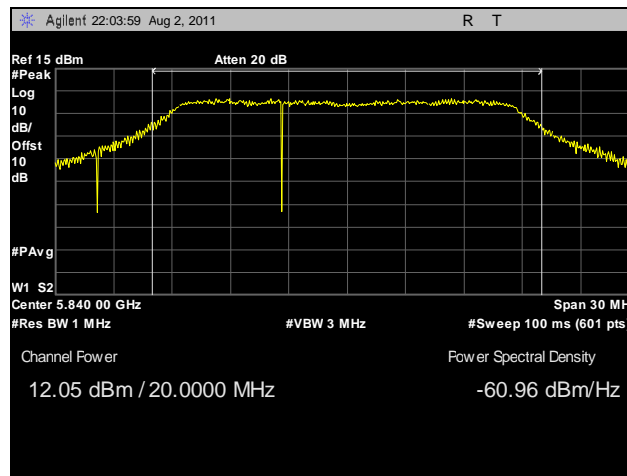

Plot 33. Peak Power Output, High Channel, 20 MHz, Horizontal Feed

Peak Power Output Test Results, 20 MHz, Vertical Feed

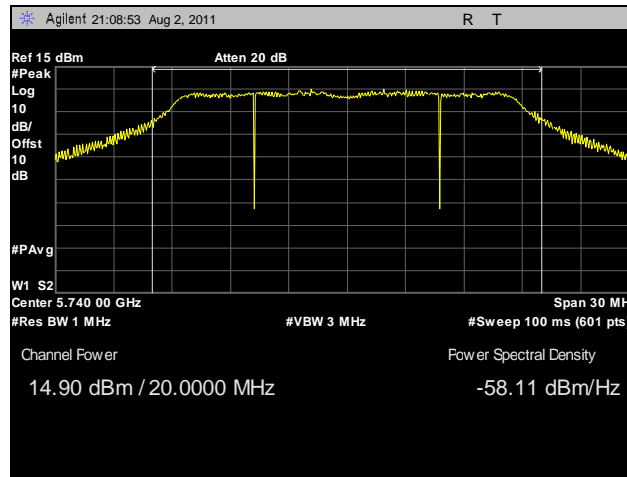

Plot 34. Peak Power Output, Low Channel, 20 MHz, Vertical Feed

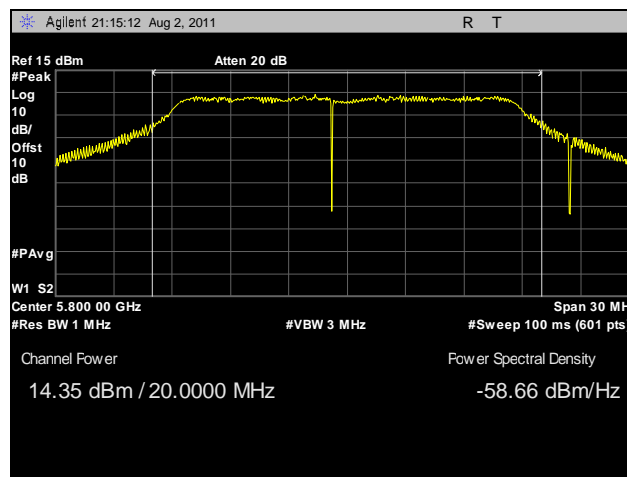

Plot 35. Peak Power Output, Mid Channel, 20 MHz, Vertical Feed

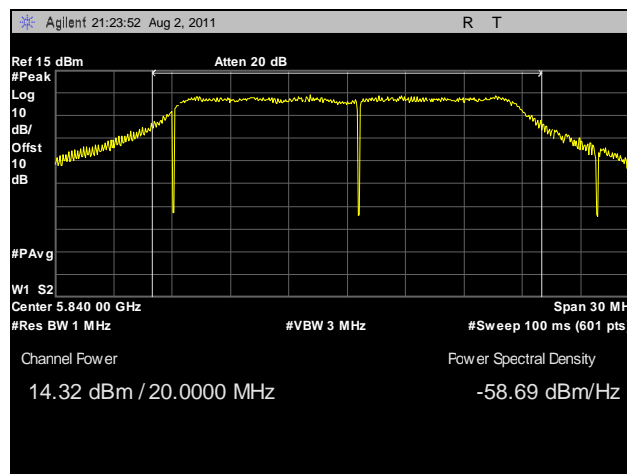

Plot 36. Peak Power Output, High Channel, 20 MHz, Vertical Feed

Peak Power Output Test Results, 40 MHz, Horizontal Feed

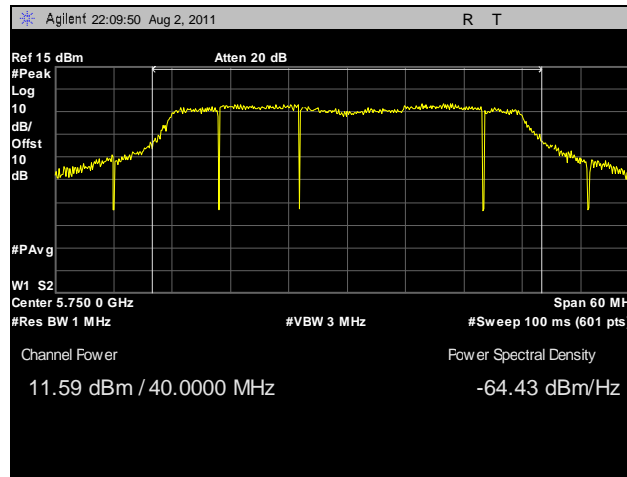

Plot 37. Peak Power Output, Low Channel, 40 MHz, Horizontal Feed

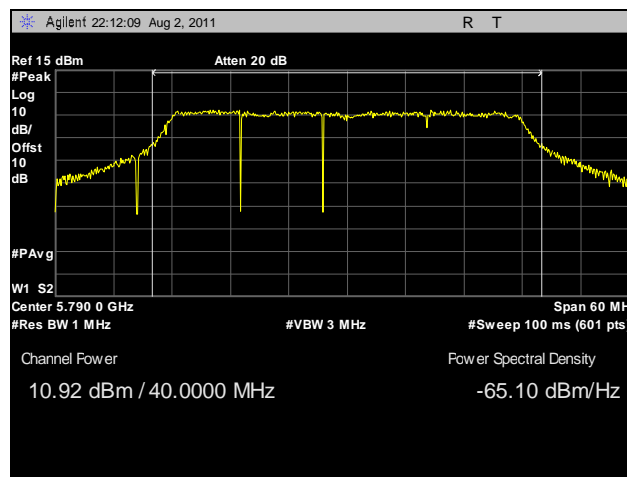

Plot 38. Peak Power Output, Mid Channel, 40 MHz, Horizontal Feed

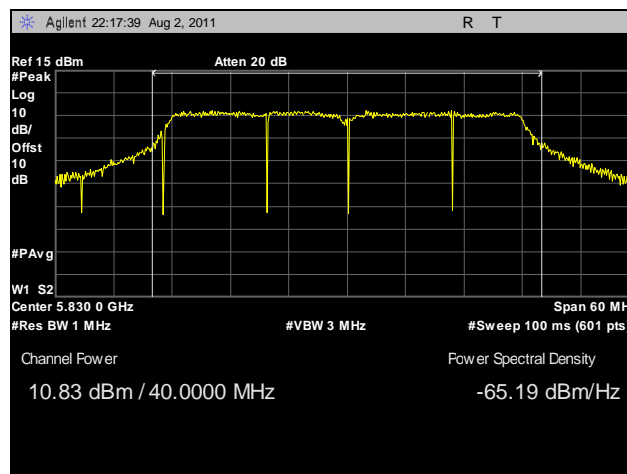

Plot 39. Peak Power Output, High Channel, 40 MHz, Horizontal Feed

Peak Power Output Test Results, 40 MHz, Vertical Feed

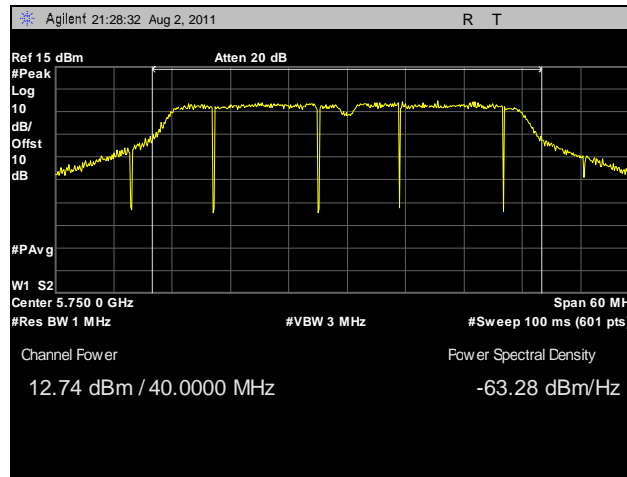

Plot 40. Peak Power Output, Low Channel, 40 MHz, Vertical Feed

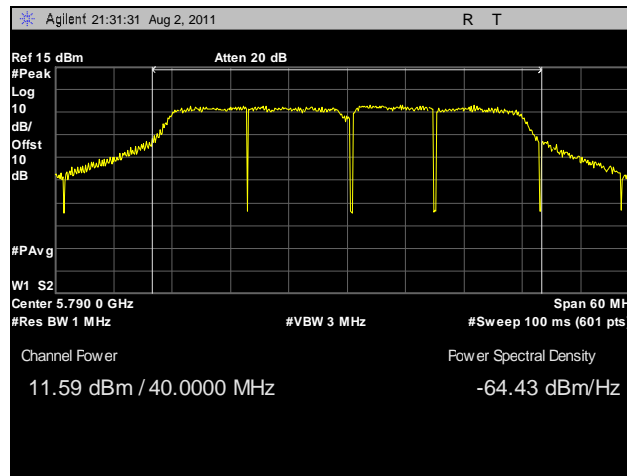

Plot 41. Peak Power Output, Mid Channel, 40 MHz, Vertical Feed

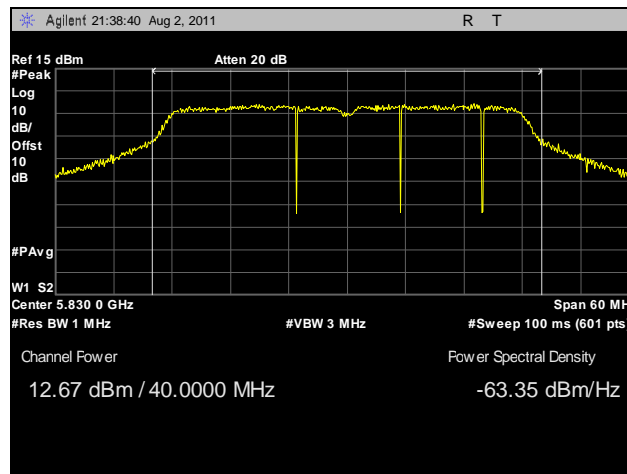

Plot 42. Peak Power Output, High Channel, 40 MHz, Vertical Feed

Electromagnetic Compatibility Criteria for Intentional Radiators

§ 15.247(d) Radiated Spurious Emissions Requirements and Band Edge

Test Requirements: §15.247(d); §15.205: Emissions outside the frequency band.

§15.247(d): In any 100 kHz bandwidth outside the frequency band in which the spread spectrum or digitally modulated intentional radiator is operating, the radio frequency power that is produced by the intentional radiator shall be at least 20 dB below that in the 100 kHz bandwidth within the band that contains the highest level of the desired power, based on either an RF conducted or a radiated measurement. Attenuation below the general limits specified in § 15.209(a) is not required. In addition, radiated emissions which fall in the restricted bands, as defined in § 15.205(a), must also comply with the radiated emission limits specified in § 15.209(a).

§15.205(a): Except as shown in paragraph (d) of this section, only spurious emissions are permitted in any of the frequency bands listed below:

MHz	MHz	MHz	GHz
0.090–0.110-----	16.42–16.423	399.9–410	4.5–5.15
¹ 0.495–0.505-----	16.69475–16.69525	608–614	5.35–5.46
2.1735–2.1905-----	16.80425–16.80475	960–1240	7.25–7.75
4.125–4.128-----	25.5–25.67	1300–1427	8.025–8.5
4.17725–4.17775-----	37.5–38.25	1435–1626.5	9.0–9.2
4.20725–4.20775-----	73–74.6	1645.5–1646.5	9.3–9.5
6.215–6.218-----	74.8–75.2	1660–1710	10.6–12.7
6.26775–6.26825-----	108–121.94	1718.8–1722.2	13.25–13.4
6.31175–6.31225-----	123–138	2200–2300	14.47–14.5
8.291–8.294-----	149.9–150.05	2310–2390	15.35–16.2
8.362–8.366-----	156.52475–156.52525	2483.5–2500	17.7–21.4
8.37625–8.38675-----	156.7–156.9	2655–2900	22.01–23.12
8.41425–8.41475-----	162.0125–167.17	3260–3267	23.6–24.0
12.29–12.293-----	167.72–173.2	3332–3339	31.2–31.8
12.51975–12.52025-----	240–285	3345.8–3358.36.	43–36.5
12.57675–12.57725-----	322–335.4	3600–4400	(²)

Table 26. Restricted Bands of Operation

¹ Until February 1, 1999, this restricted band shall be 0.490 – 0.510 MHz.

² Above 38.6

Test Requirement(s): § 15.209 (a): Except as provided elsewhere in this subpart, the emissions from an intentional radiator shall not exceed the field strength levels specified in Table 27.

Frequency (MHz)	§ 15.209(a), Radiated Emission Limits (dB μ V) @ 3m
30 - 88	40.00
88 - 216	43.50
216 - 960	46.00
Above 960	54.00

Table 27. Radiated Emissions Limits Calculated from FCC Part 15, § 15.209 (a)

Test Procedures: The transmitter was turned on. Measurements were performed of the low, mid and high Channels. The EUT was rotated orthogonally through all three axes. Plots shown are corrected for both antenna correction factor and distance and compared to a 3 m limit line. Only noise floor was measured above 18 GHz.

Test Results: The EUT was completed with the Radiated Spurious Emission limits of § 15.247(d).

Test Engineer(s): Jeff Pratt

Test Date(s): 06/15/11 & 08/02/11

Radiated Spurious Emissions Test Results, 20 MHz

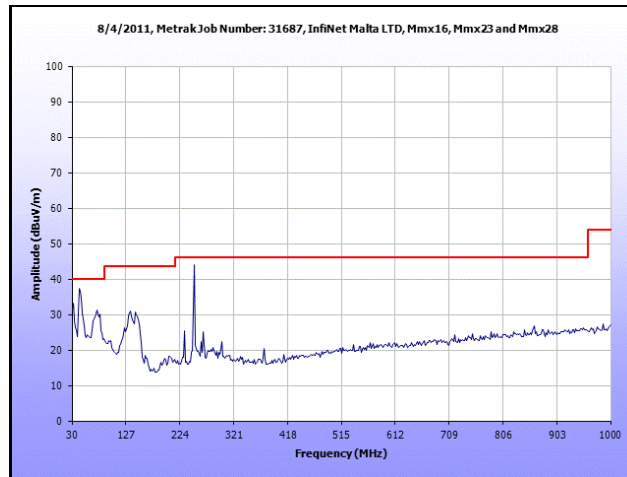

Plot 43. Radiated Spurious Emissions, Low Channel, 30 MHz – 1 GHz, 20 MHz

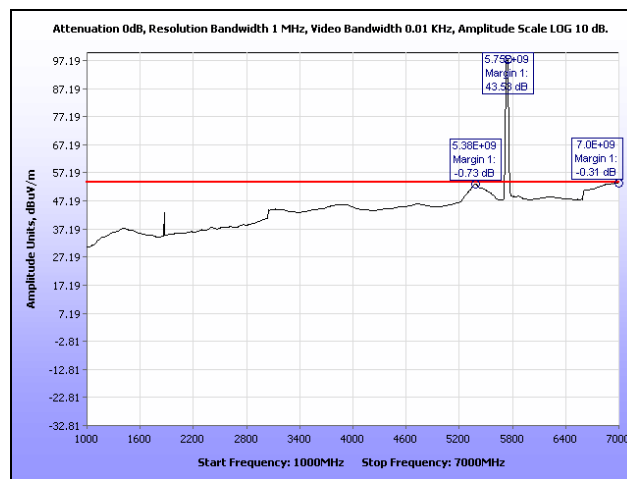

Plot 44. Radiated Spurious Emissions, Low Channel, 1 GHz – 7 GHz, 20 MHz

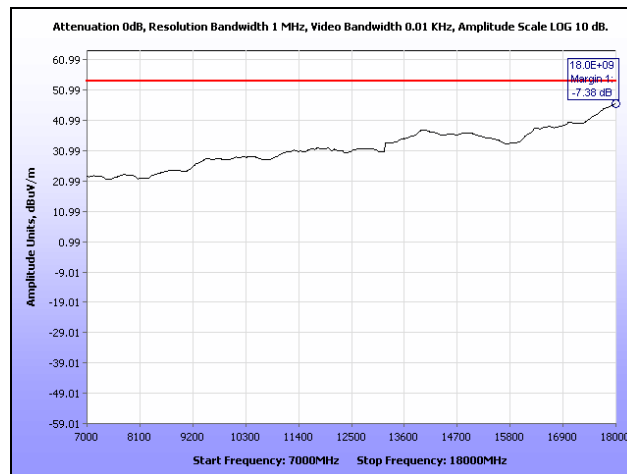

Plot 45. Radiated Spurious Emissions, Low Channel, 7 GHz – 18 GHz, 20 MHz

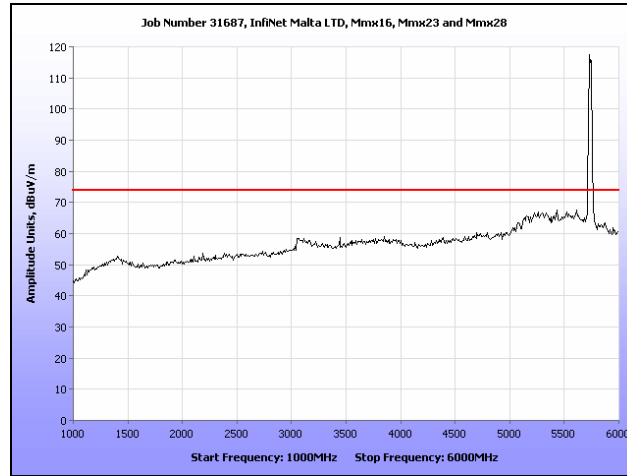

Plot 46. Radiated Spurious Emissions, Low Channel, 1 GHz – 6 GHz, Peak, 20 MHz

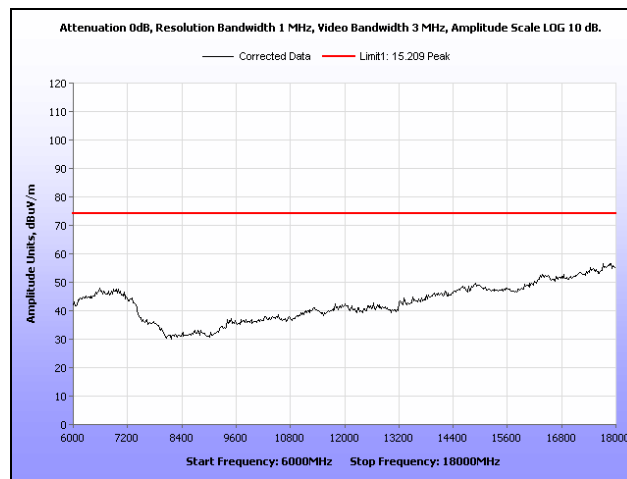

Plot 47. Radiated Spurious Emissions, Low Channel, 6 GHz – 18 GHz, Peak, 20 MHz

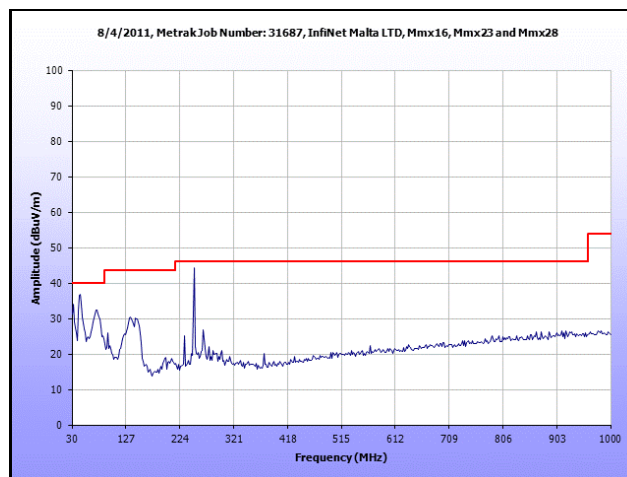

Plot 48. Radiated Spurious Emissions, Mid Channel, 30 MHz – 1 GHz, 20 MHz

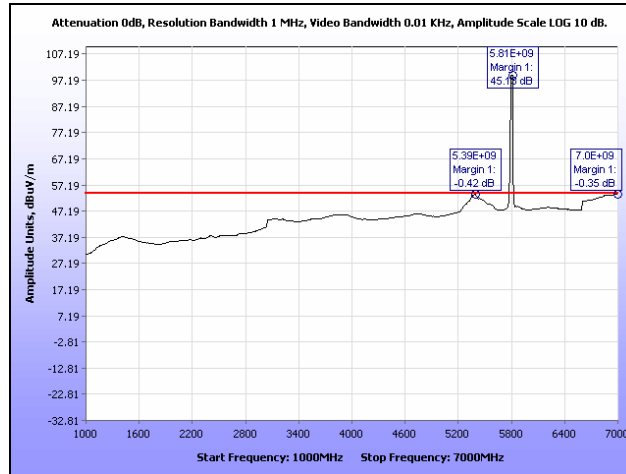

Plot 49. Radiated Spurious Emissions, Mid Channel, 1 GHz – 7 GHz, 20 MHz

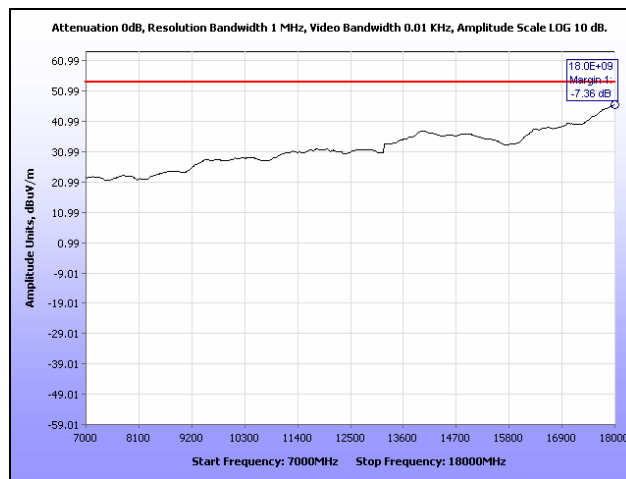

Plot 50. Radiated Spurious Emissions, Mid Channel, 7 GHz – 18 GHz, 20 MHz

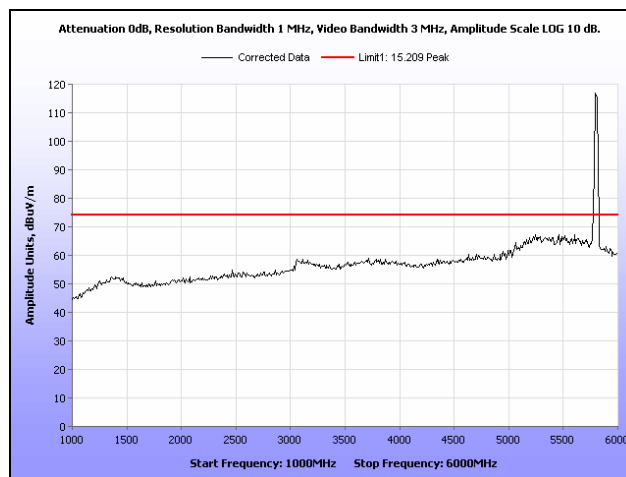

Plot 51. Radiated Spurious Emissions, Mid Channel, 1 GHz – 6 GHz, Peak, 20 MHz

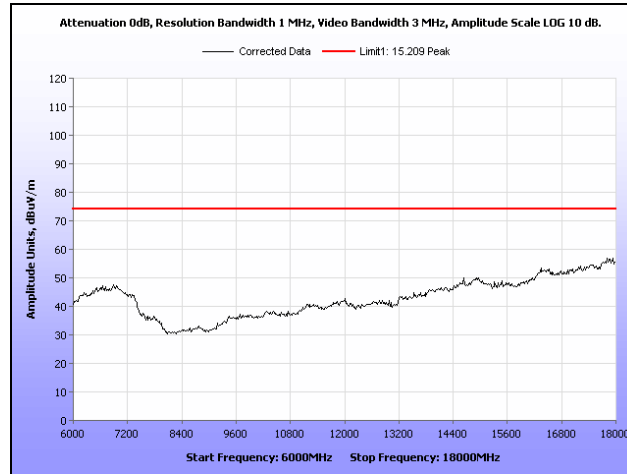

Plot 52. Radiated Spurious Emissions, Mid Channel, 6 GHz – 18 GHz, Peak, 20 MHz

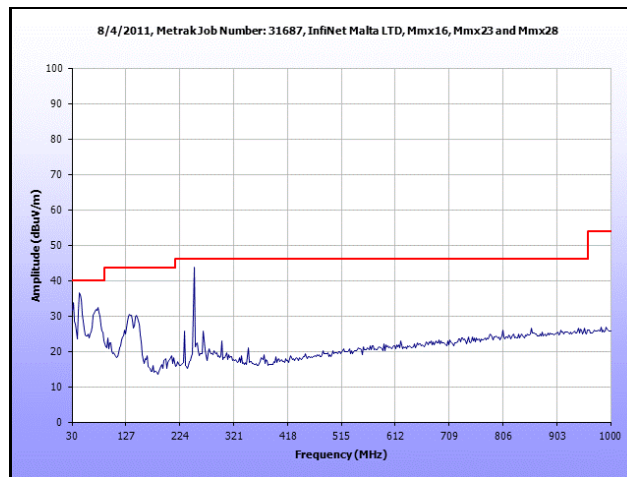

Plot 53. Radiated Spurious Emissions, High Channel, 30 MHz – 1 GHz, 20 MHz

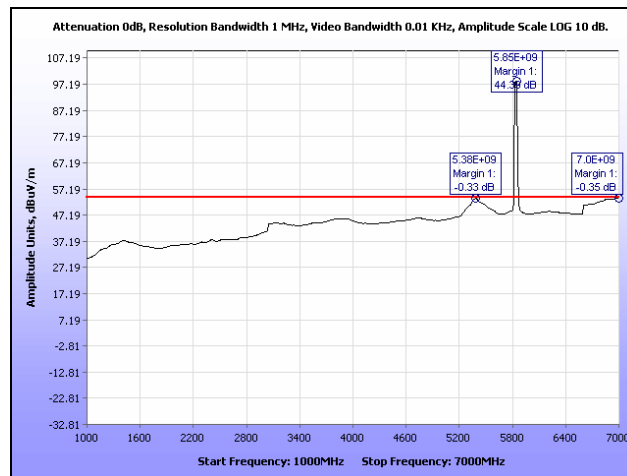

Plot 54. Radiated Spurious Emissions, High Channel, 1 GHz – 7 GHz, 20 MHz

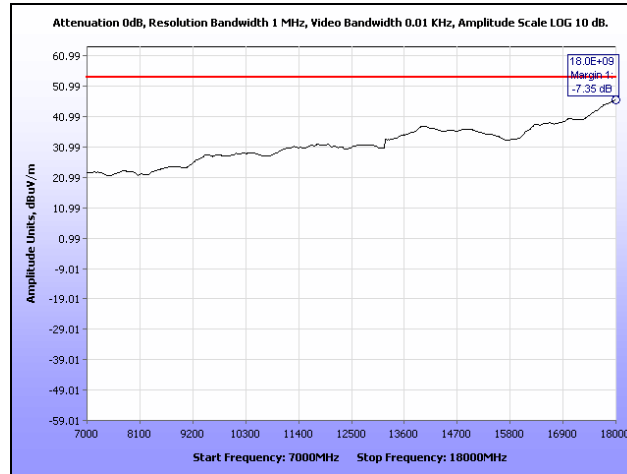

Plot 55. Radiated Spurious Emissions, High Channel, 7 GHz – 18 GHz, 20 MHz

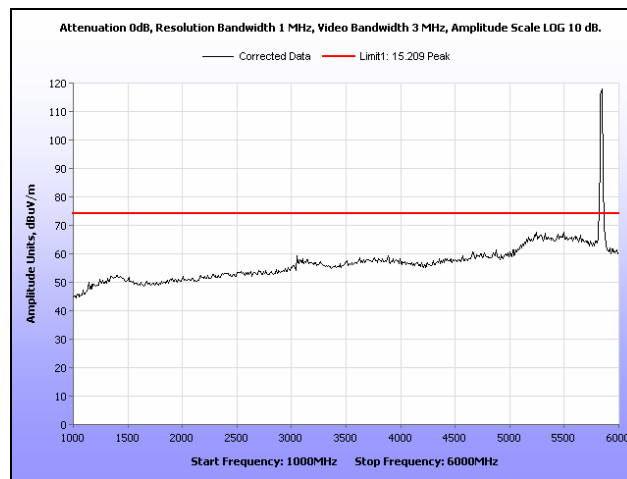

Plot 56. Radiated Spurious Emissions, High Channel, 1 GHz – 6 GHz, Peak, 20 MHz

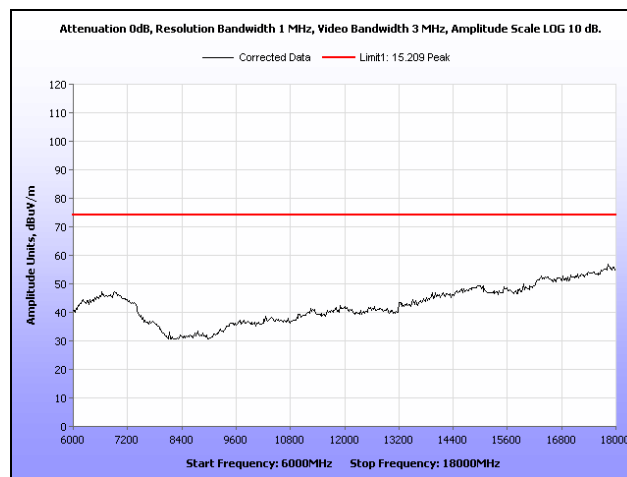

Plot 57. Radiated Spurious Emissions, High Channel, 1 GHz – 6 GHz, Peak, 20 MHz

Radiated Spurious Emissions Test Results, 40 MHz

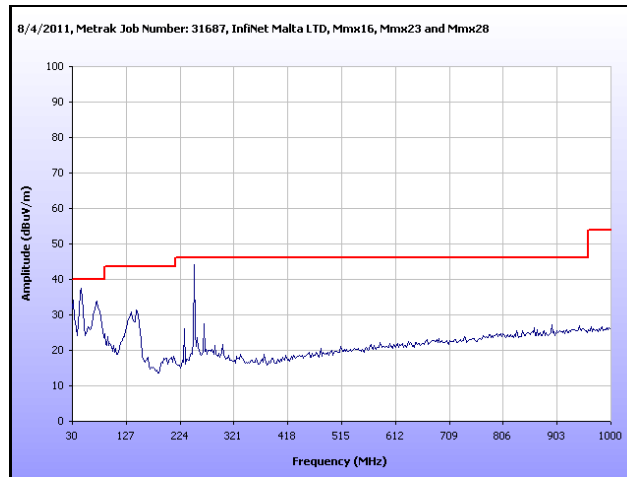

Plot 58. Radiated Spurious Emissions, Low Channel, 30 MHz – 1 GHz, 40 MHz

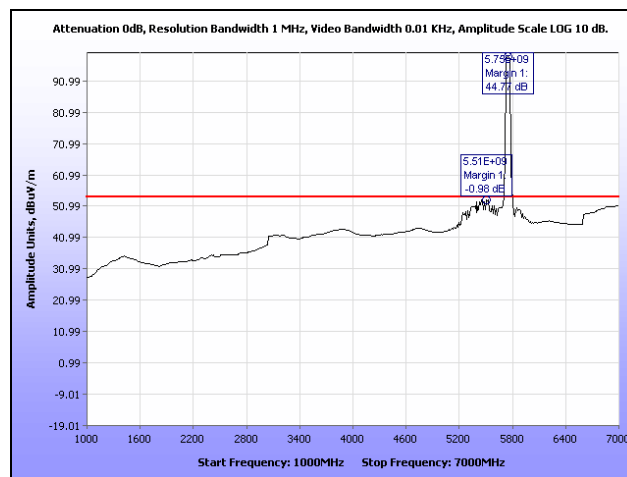

Plot 59. Radiated Spurious Emissions, Low Channel, 1 GHz – 7 GHz, 40 MHz

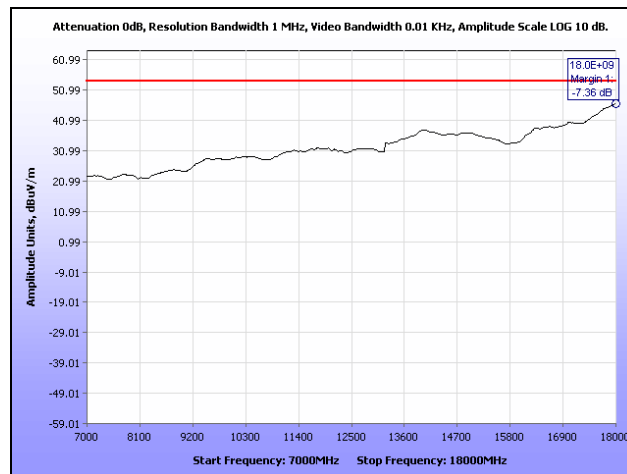

Plot 60. Radiated Spurious Emissions, Low Channel, 7 GHz – 18 GHz, 40 MHz

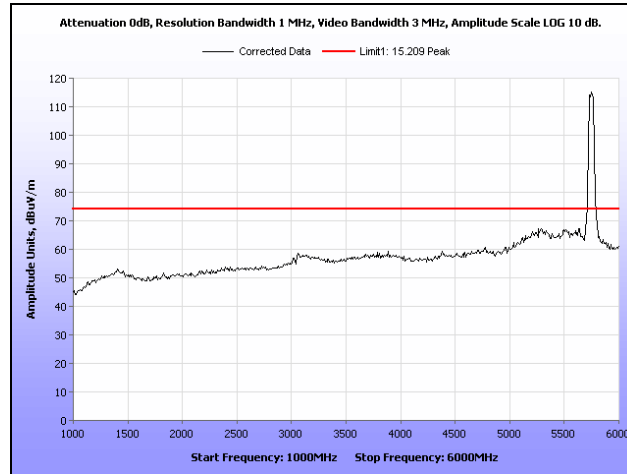

Plot 61. Radiated Spurious Emissions, Low Channel, 1 GHz – 6 GHz, Peak, 40 MHz

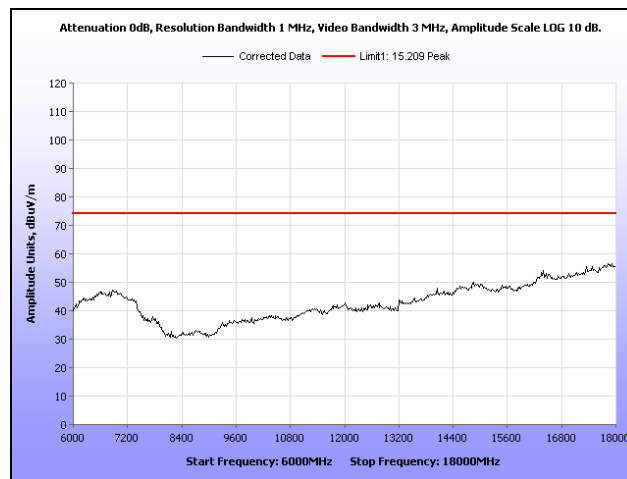

Plot 62. Radiated Spurious Emissions, Low Channel, 6 GHz – 18 GHz, Peak, 40 MHz

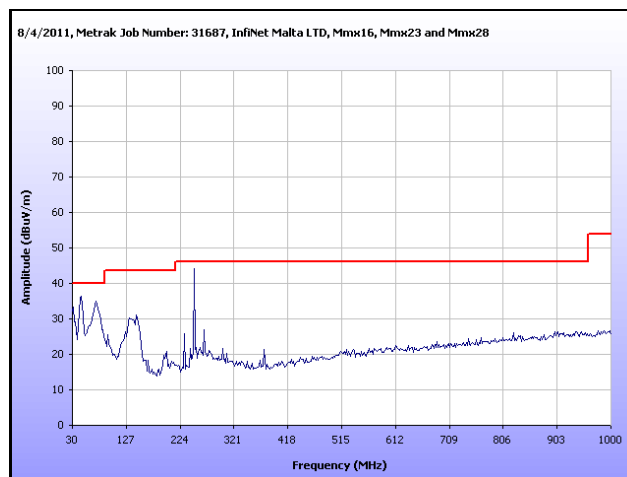

Plot 63. Radiated Spurious Emissions, Mid Channel, 30 MHz – 1 GHz, 40 MHz

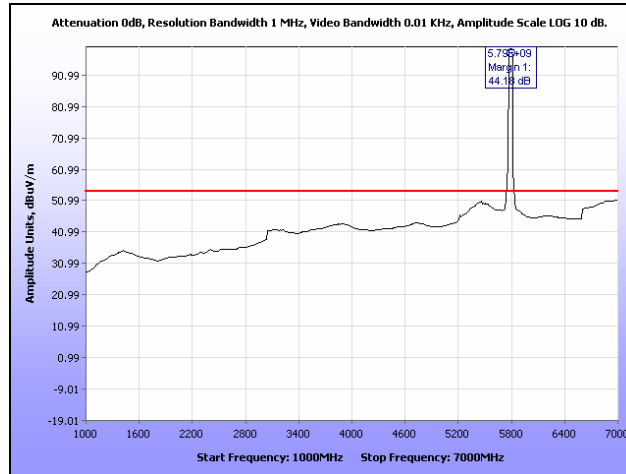

Plot 64. Radiated Spurious Emissions, Mid Channel, 1 GHz – 7 GHz, 40 MHz

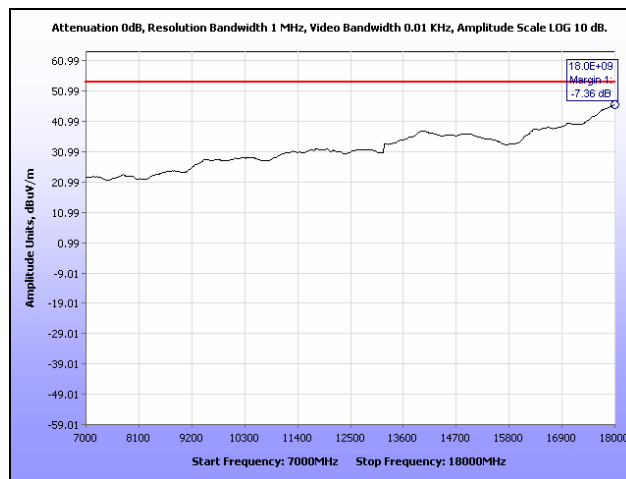

Plot 65. Radiated Spurious Emissions, Mid Channel, 7 GHz – 18 GHz, 40 MHz

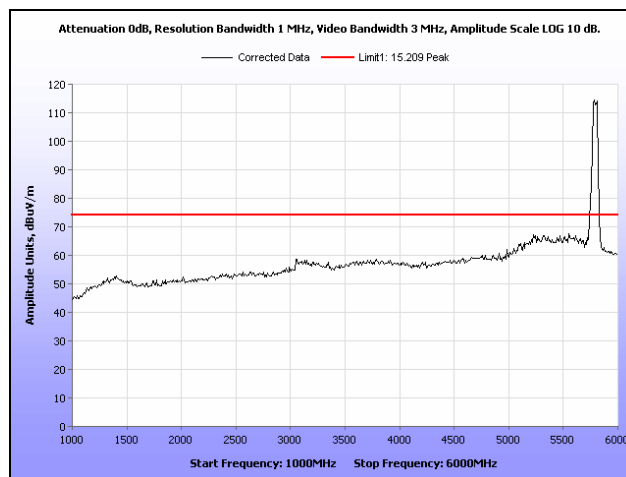

Plot 66. Radiated Spurious Emissions, Mid Channel, 1 GHz – 6 GHz, Peak, 40 MHz

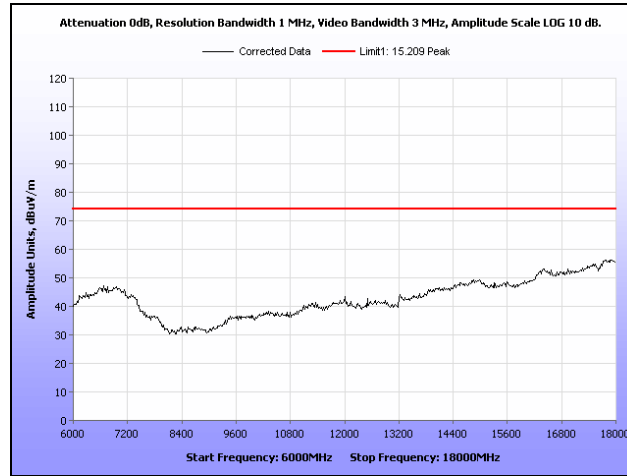

Plot 67. Radiated Spurious Emissions, Mid Channel, 6 GHz – 18 GHz, Peak, 40 MHz

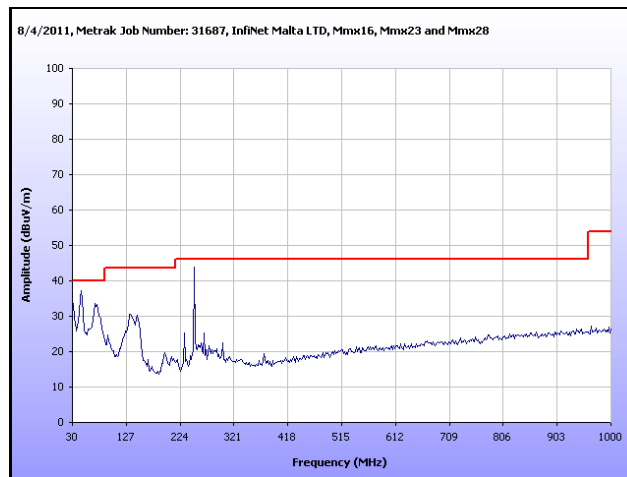

Plot 68. Radiated Spurious Emissions, High Channel, 30 MHz – 1 GHz, 40 MHz

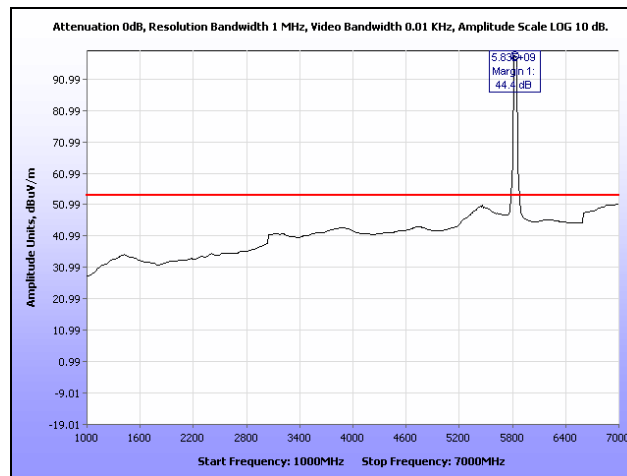

Plot 69. Radiated Spurious Emissions, High Channel, 1 GHz – 7 GHz, 40 MHz

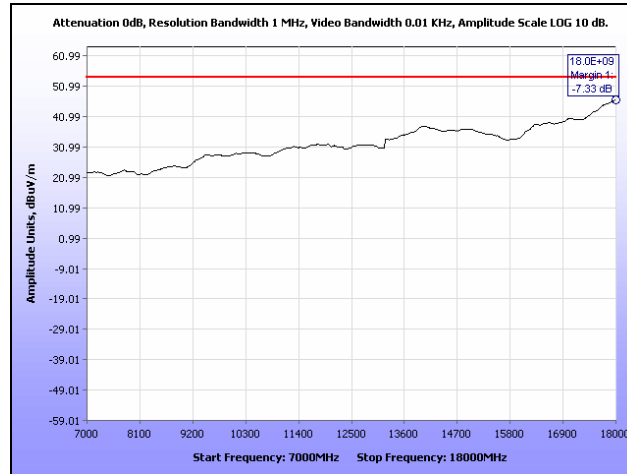

Plot 70. Radiated Spurious Emissions, High Channel, 7 GHz – 18 GHz, 40 MHz

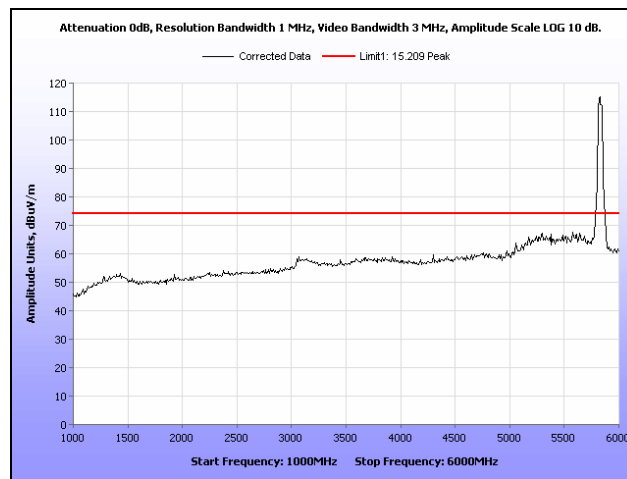

Plot 71. Radiated Spurious Emissions, High Channel, 1 GHz – 6 GHz, Peak, 40 MHz

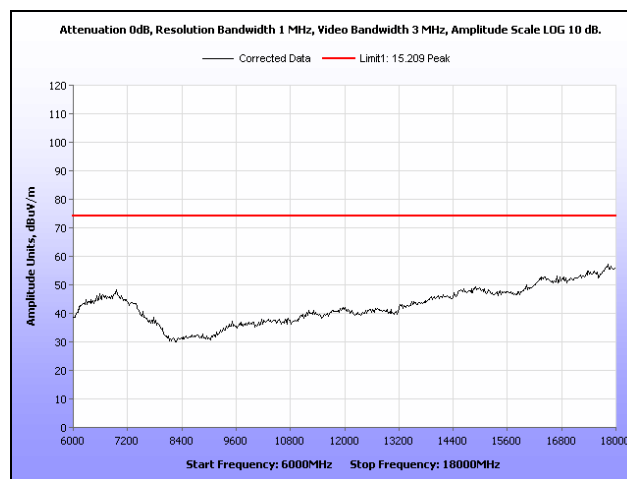

Plot 72. Radiated Spurious Emissions, High Channel, 6 GHz – 18 GHz, Peak, 40 MHz

Radiated Spurious Emissions Test Setup



Photograph 5. Radiated Spurious Emissions, Test Setup

Electromagnetic Compatibility Criteria for Intentional Radiators

§ 15.247(d) RF Conducted Spurious Emissions Requirements and Band Edge

Test Requirement: **15.247(d)** In any 100 kHz bandwidth outside the frequency band in which the spread spectrum or digitally modulated intentional radiator is operating, the radio frequency power that is produced by the intentional radiator shall be at least 20 dB below that in the 100 kHz bandwidth within the band that contains the highest level of the desired power, based on either an RF conducted or a radiated measurement, provided the transmitter demonstrates compliance with the peak conducted power limits. If the transmitter complies with the conducted power limits based on the use of RMS averaging over a time interval, as permitted under paragraph (b)(3) of this section, the attenuation required under this paragraph shall be 30 dB instead of 20 dB.

Test Procedure: For intentional radiators with a digital device portion which operates below 10 GHz, the spectrum was investigated as per §15.33(a)(1) and §15.33(a)(4); i.e., the lowest RF signal generated or used in the device up to the 10th harmonic of the highest fundamental frequency or to 40 GHz, whichever is lower.

Since the EUT had an integral antenna, conducted measurements could not be performed. Measurements needed to be taken radiated. An antenna was located 3 m away from the EUT and plots were taken. The EUT was rotated through all three orthogonal axes. The plots were corrected for both antenna correction factor and cable loss.

See following pages for detailed test results with RF Conducted Spurious Emissions.

Test Results: The EUT was compliant with the Conducted Spurious Emission limits of §15.247(d).

Test Engineer(s): Jeff Pratt

Test Date(s): 06/15/11 & 08/09/11

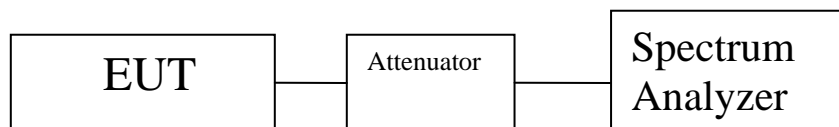
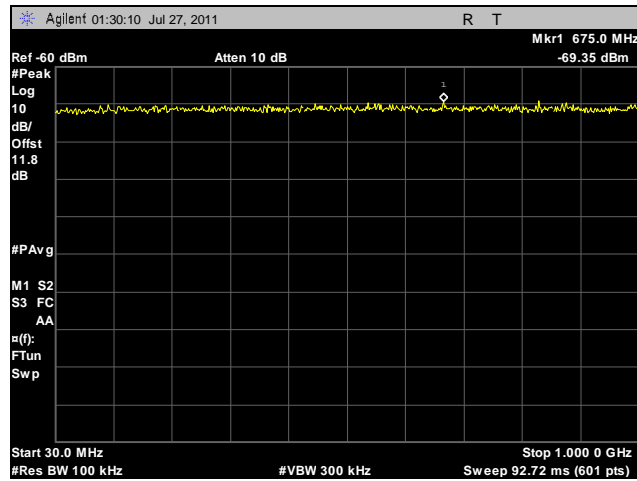
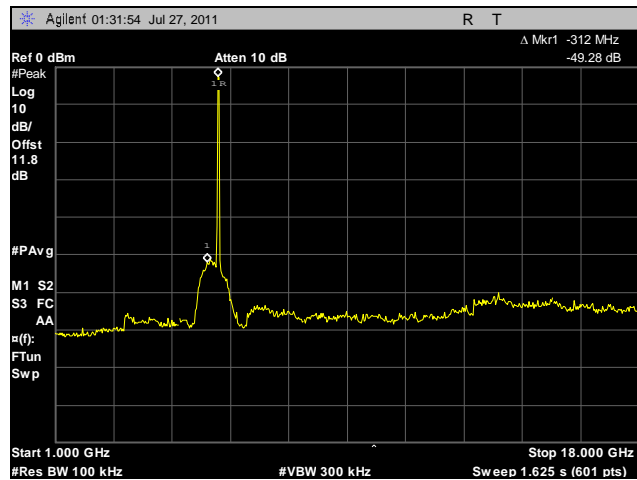

Figure 4. Block Diagram, Conducted Spurious Emissions Test Setup

Conducted Spurious Emissions Test Results, 20 MHz, Horizontal Feed



Plot 73. Conducted Spurious Emissions, Low Channel, 30 MHz – 1 GHz, 20 MHz, Horizontal Feed



Plot 74. Conducted Spurious Emissions, Low Channel, 1 GHz – 18 GHz, 20 MHz, Horizontal Feed

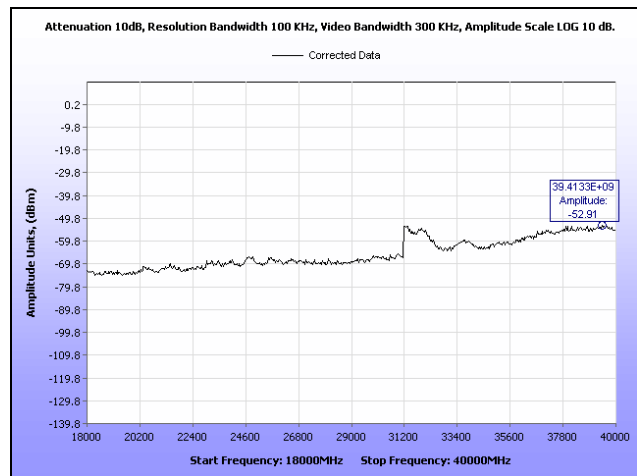

Plot 75. Conducted Spurious Emissions, Low Channel, 18 GHz – 40 GHz, 20 MHz, Horizontal Feed

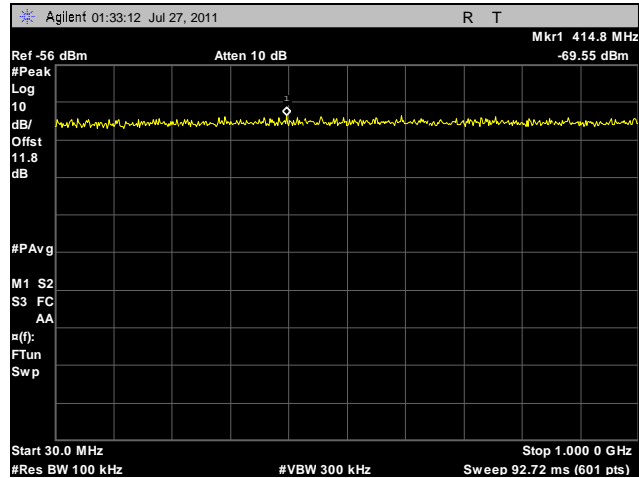

Plot 76. Conducted Spurious Emissions, Mid Channel, 30 MHz – 1 GHz, 20 MHz, Horizontal Feed

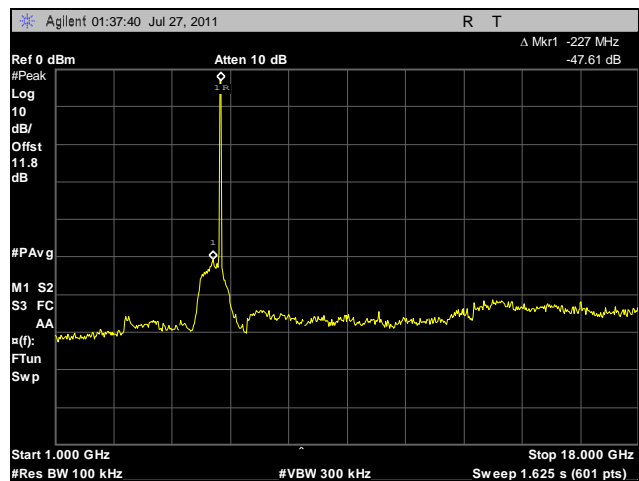

Plot 77. Conducted Spurious Emissions, Mid Channel, 1 GHz – 18 GHz, 20 MHz, Horizontal Feed

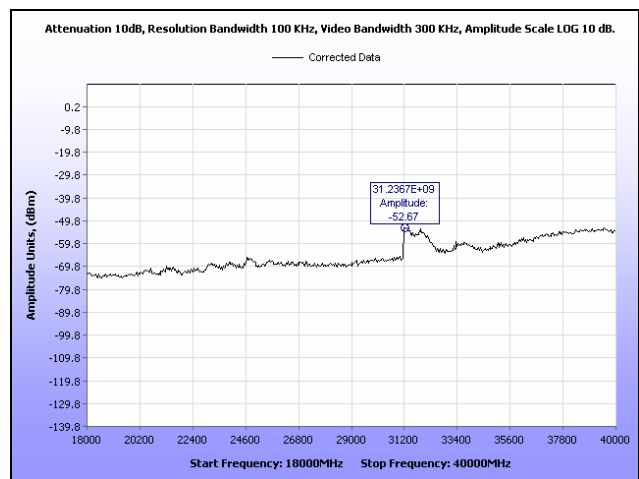

Plot 78. Conducted Spurious Emissions, Mid Channel, 18 GHz – 40 GHz, 20 MHz, Horizontal Feed

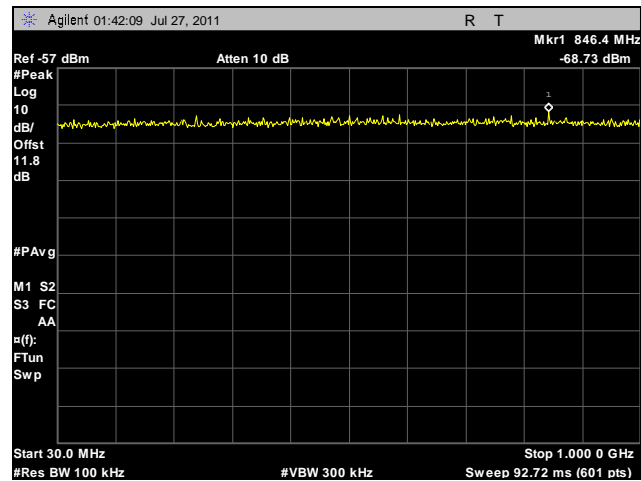

Plot 79. Conducted Spurious Emissions, High Channel, 30 MHz – 1 GHz, 20 MHz, Horizontal Feed

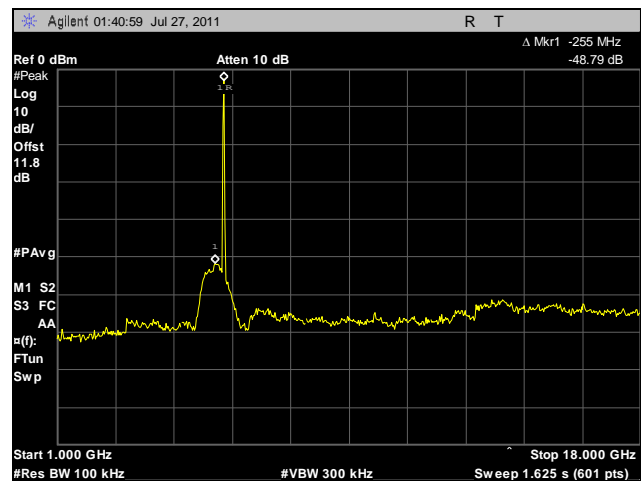

Plot 80. Conducted Spurious Emissions, High Channel, 1 GHz – 18 GHz, 20 MHz, Horizontal Feed

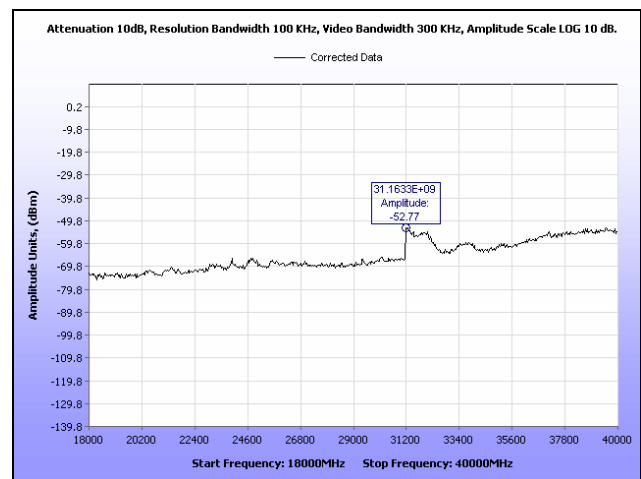

Plot 81. Conducted Spurious Emissions, High Channel, 18 GHz – 40 GHz, 20 MHz, Horizontal Feed

Conducted Spurious Emissions Test Results, 20 MHz, Vertical Feed

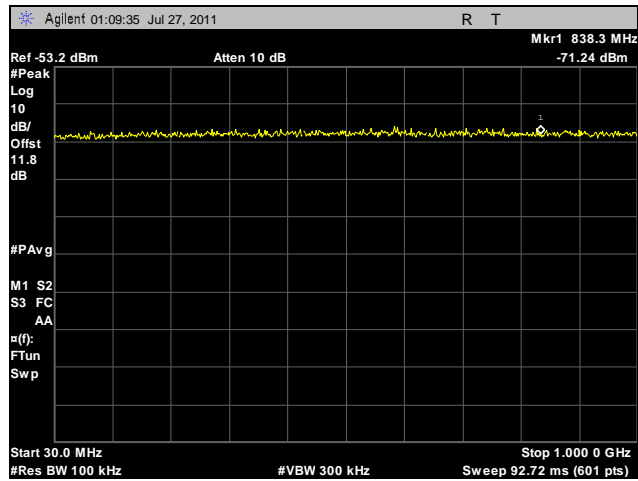

Plot 82. Conducted Spurious Emissions, Low Channel, 30 MHz – 1 GHz, 20 MHz, Vertical Feed

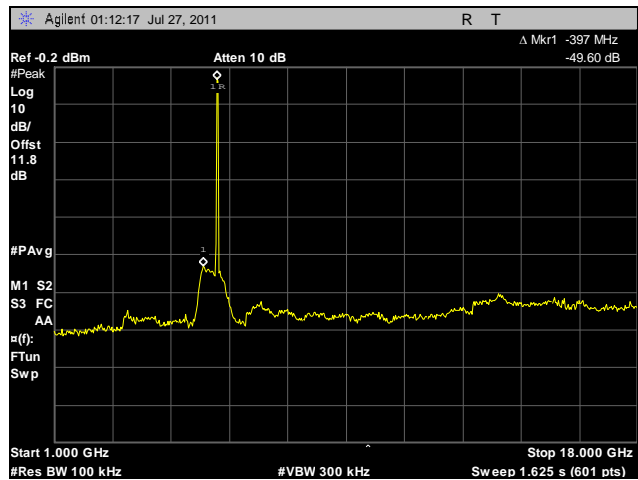

Plot 83. Conducted Spurious Emissions, Low Channel, 1 GHz – 18 GHz, 20 MHz, Vertical Feed

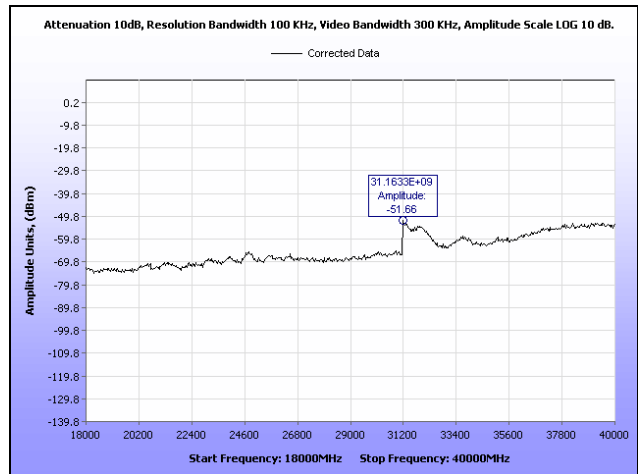

Plot 84. Conducted Spurious Emissions, Low Channel, 18 GHz – 40 GHz, 20 MHz, Vertical Feed

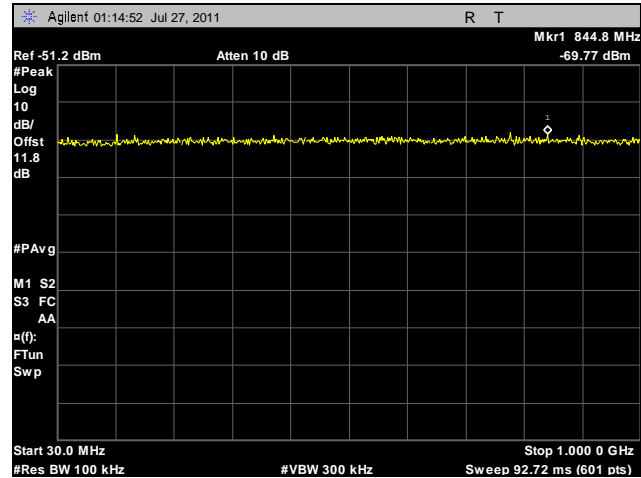

Plot 85. Conducted Spurious Emissions, Mid Channel, 30 MHz – 1 GHz, 20 MHz, Vertical Feed

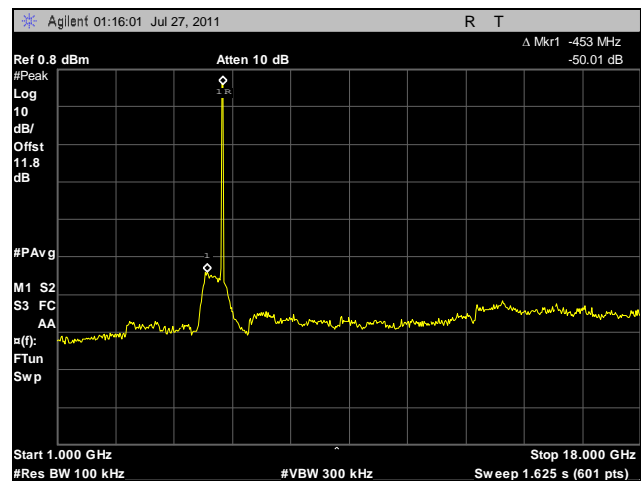

Plot 86. Conducted Spurious Emissions, Mid Channel, 1 GHz – 18 GHz, 20 MHz, Vertical Feed

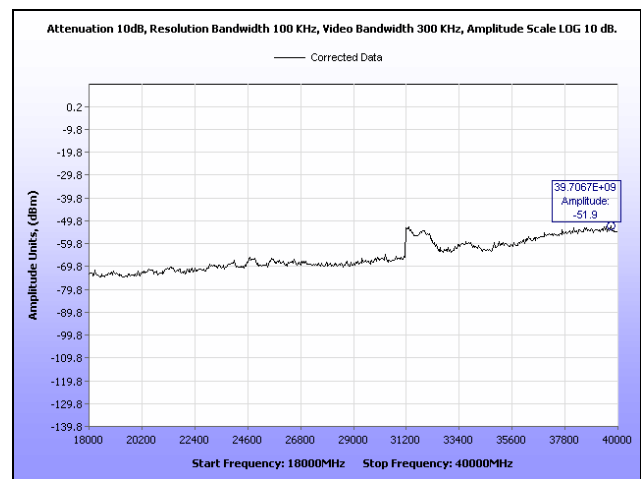

Plot 87. Conducted Spurious Emissions, Mid Channel, 18 GHz – 40 GHz, 20 MHz, Vertical Feed

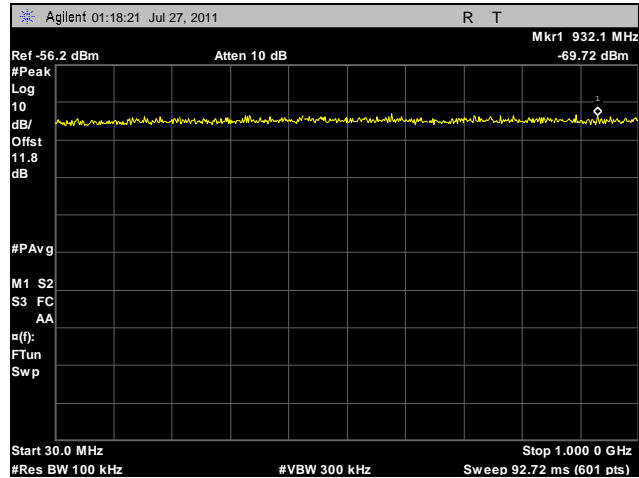

Plot 88. Conducted Spurious Emissions, High Channel, 30 MHz – 1 GHz, 20 MHz, Vertical Feed

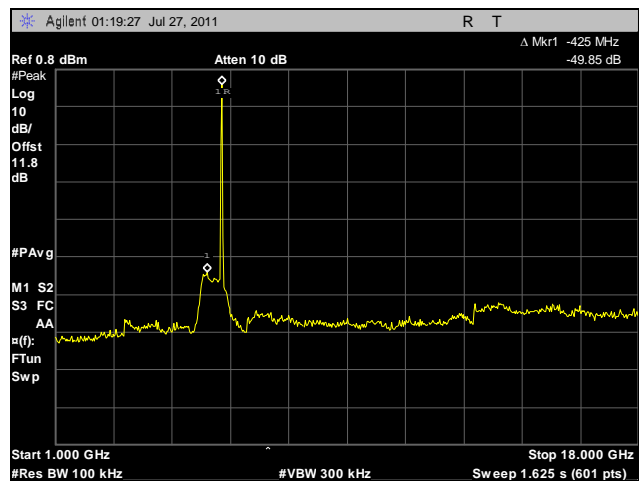

Plot 89. Conducted Spurious Emissions, High Channel, 1 GHz – 18 GHz, 20 MHz, Vertical Feed

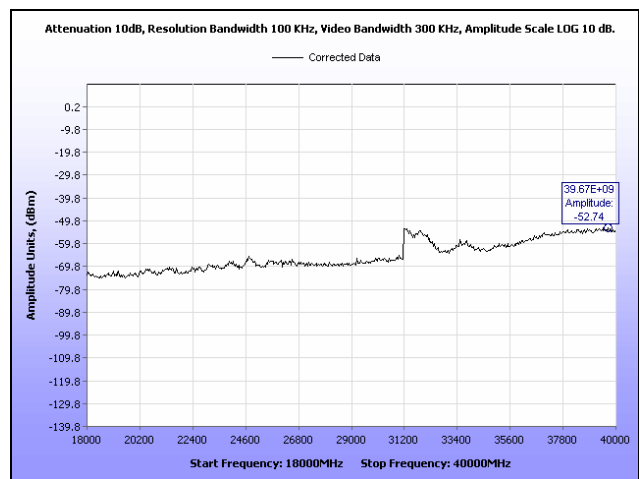

Plot 90. Conducted Spurious Emissions, High Channel, 18 GHz – 40 GHz, 20 MHz, Vertical Feed

Conducted Spurious Emissions Test Results, 40 MHz, Horizontal Feed

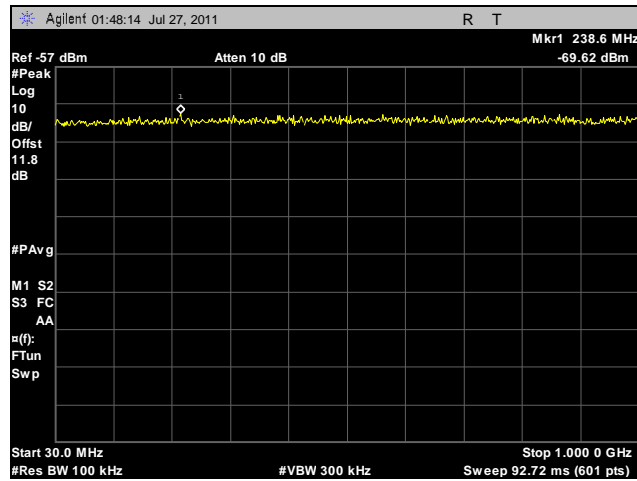

Plot 91. Conducted Spurious Emissions, Low Channel, 30 MHz – 1 GHz, 40 MHz, Horizontal Feed

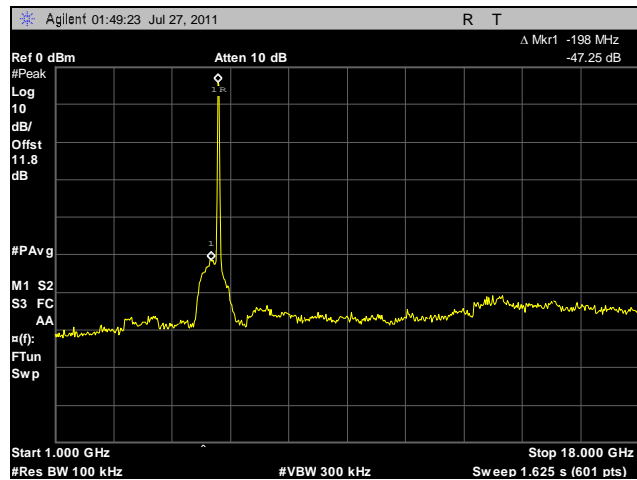

Plot 92. Conducted Spurious Emissions, Low Channel, 1 GHz – 18 GHz, 40 MHz, Horizontal Feed

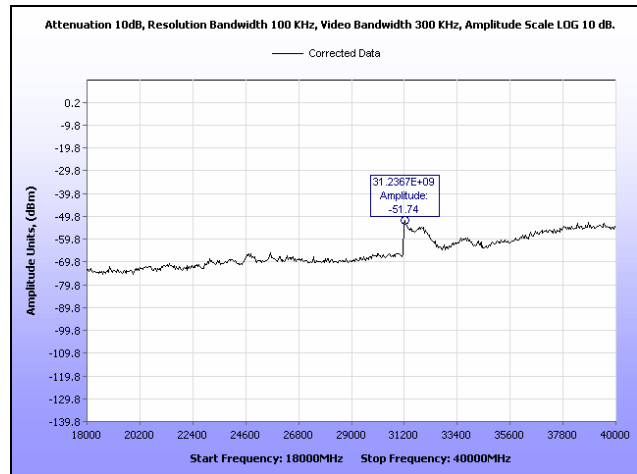

Plot 93. Conducted Spurious Emissions, Low Channel, 18 GHz – 40 GHz, 40 MHz, Horizontal Feed

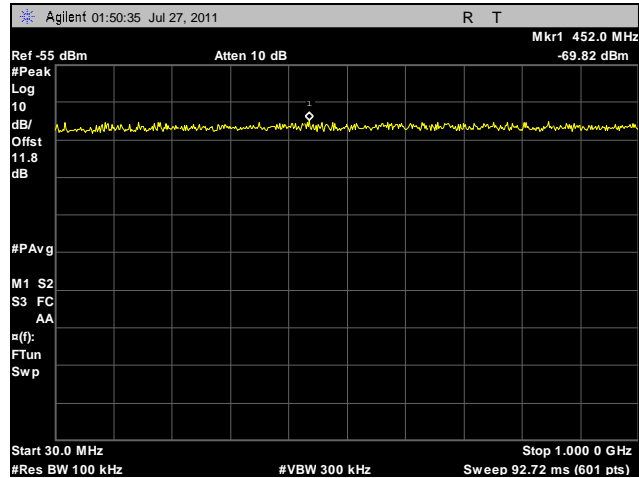

Plot 94. Conducted Spurious Emissions, Mid Channel, 30 MHz – 1 GHz, 40 MHz, Horizontal Feed

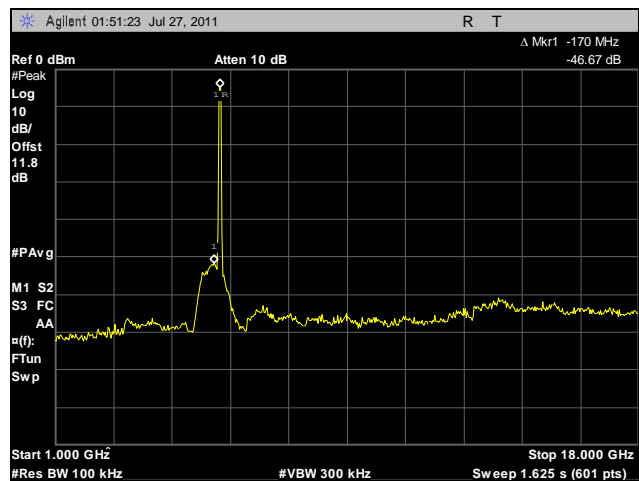

Plot 95. Conducted Spurious Emissions, Mid Channel, 1 GHz – 18 GHz, 40 MHz, Horizontal Feed

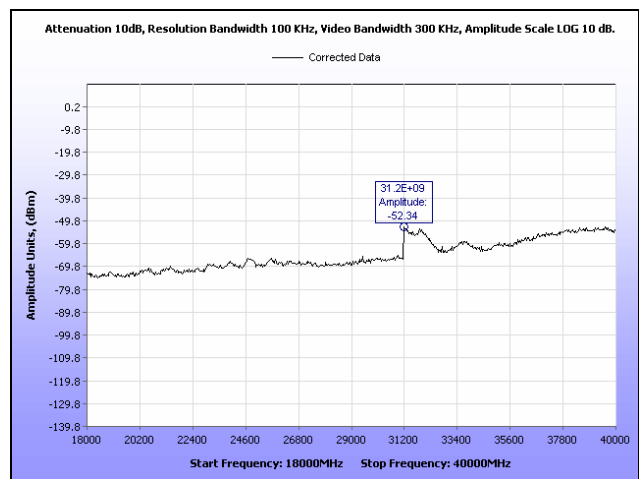

Plot 96. Conducted Spurious Emissions, Mid Channel, 18 GHz – 40 GHz, 40 MHz, Horizontal Feed

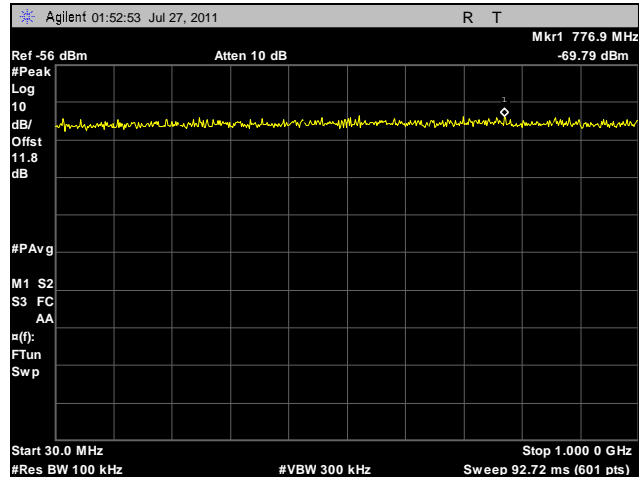

Plot 97. Conducted Spurious Emissions, High Channel, 30 MHz – 1 GHz, 40 MHz, Horizontal Feed

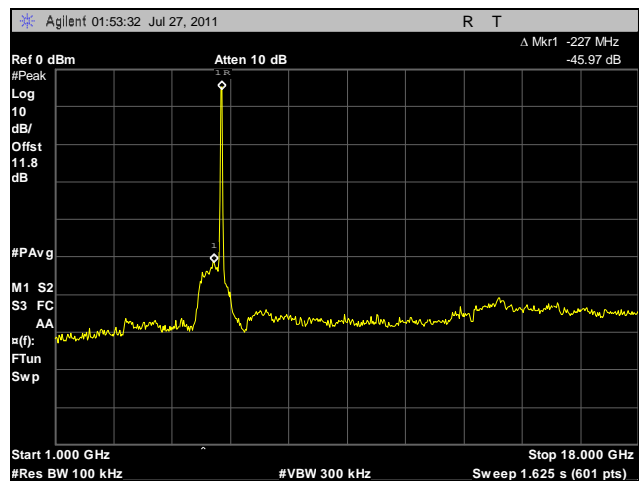

Plot 98. Conducted Spurious Emissions, High Channel, 1 GHz – 18 GHz, 40 MHz, Horizontal Feed

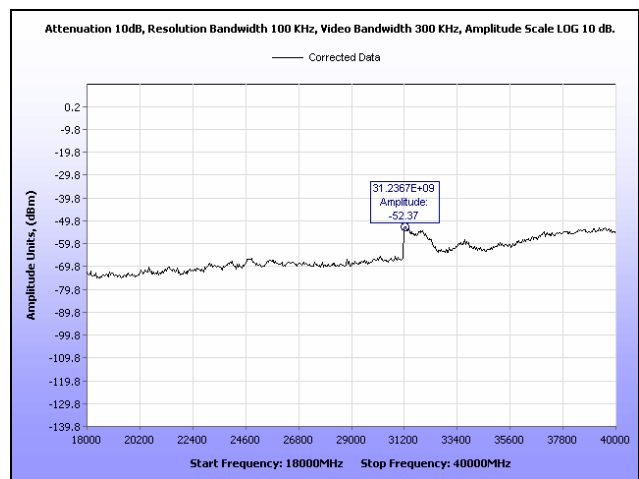

Plot 99. Conducted Spurious Emissions, High Channel, 18 GHz – 40 GHz, 40 MHz, Horizontal Feed

Conducted Spurious Emissions Test Results, 40 MHz, Vertical Feed

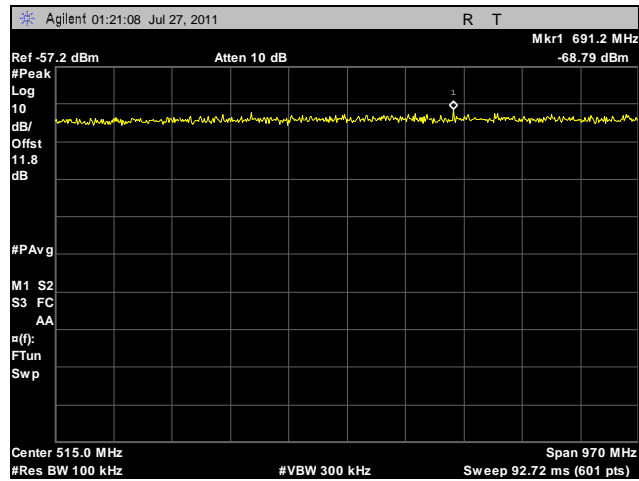

Plot 100. Conducted Spurious Emissions, Low Channel, 30 MHz – 1 GHz, 40 MHz, Vertical Feed

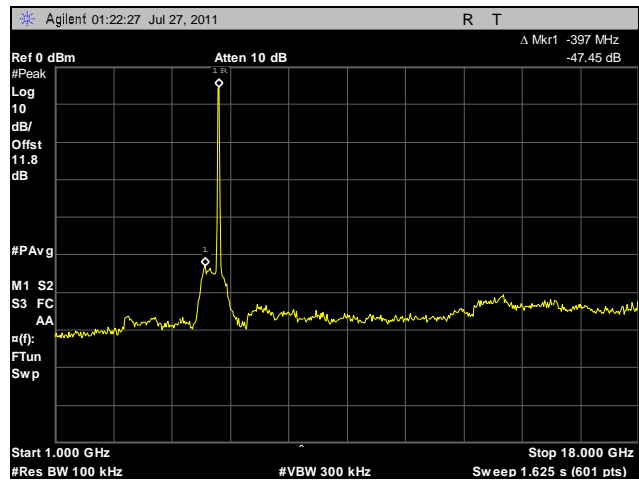

Plot 101. Conducted Spurious Emissions, Low Channel, 1 GHz – 18 GHz, 40 MHz, Vertical Feed

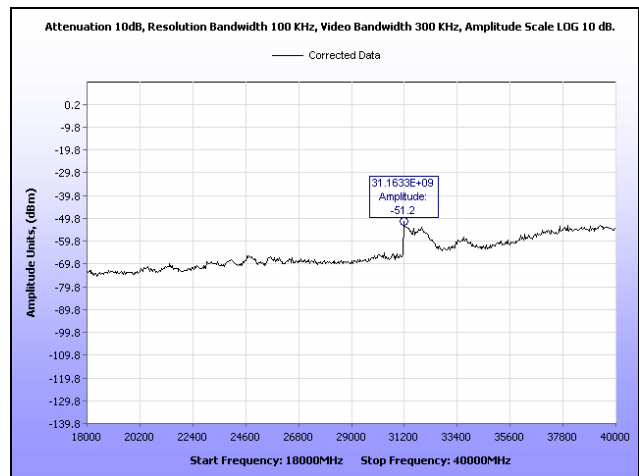

Plot 102. Conducted Spurious Emissions, Low Channel, 18 GHz – 40 GHz, 40 MHz, Vertical Feed

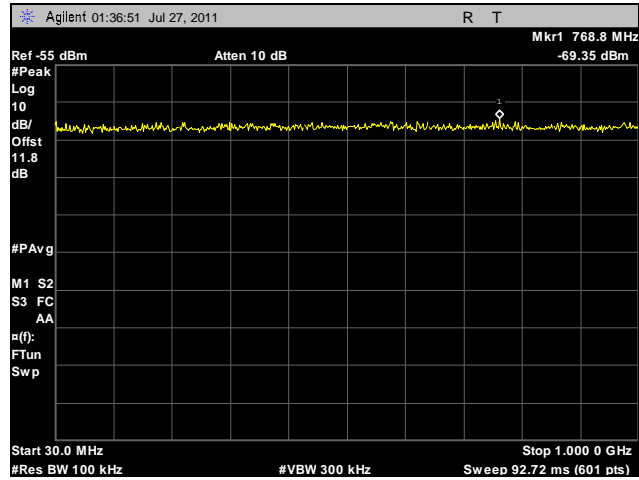

Plot 103. Conducted Spurious Emissions, Mid Channel, 30 MHz – 1 GHz, 40 MHz, Vertical Feed

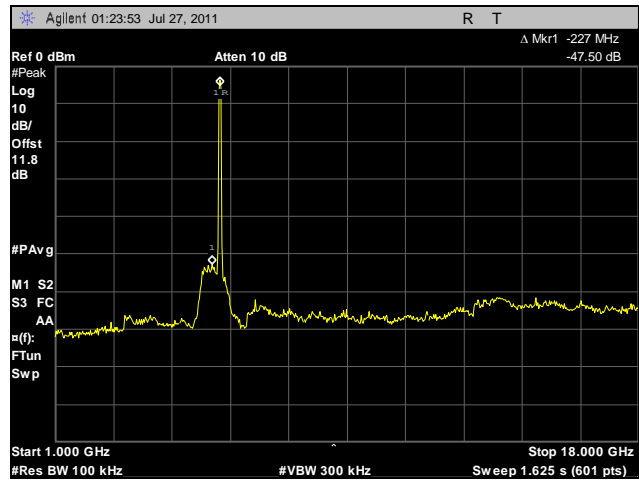

Plot 104. Conducted Spurious Emissions, Mid Channel, 1 GHz – 18 GHz, 40 MHz, Vertical Feed

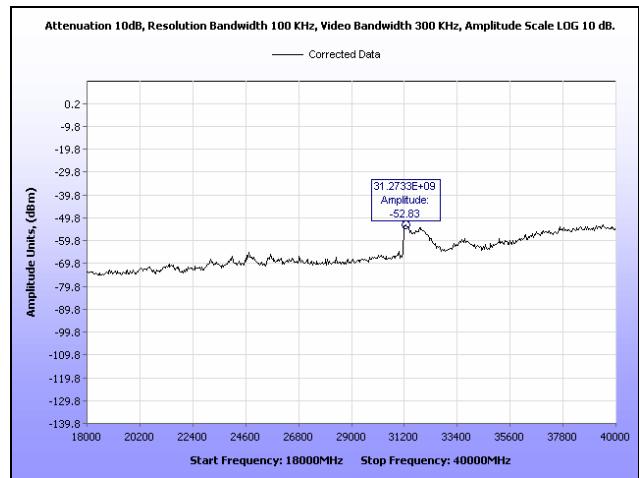

Plot 105. Conducted Spurious Emissions, Mid Channel, 18 GHz – 40 GHz, 40 MHz, Vertical Feed

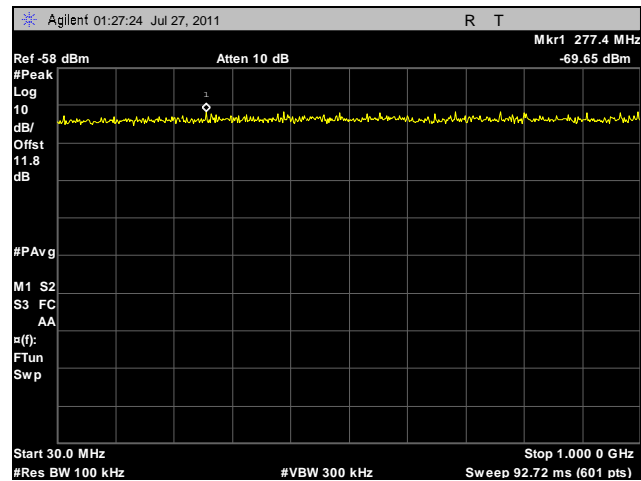

Plot 106. Conducted Spurious Emissions, High Channel, 30 MHz – 1 GHz, 40 MHz, Vertical Feed

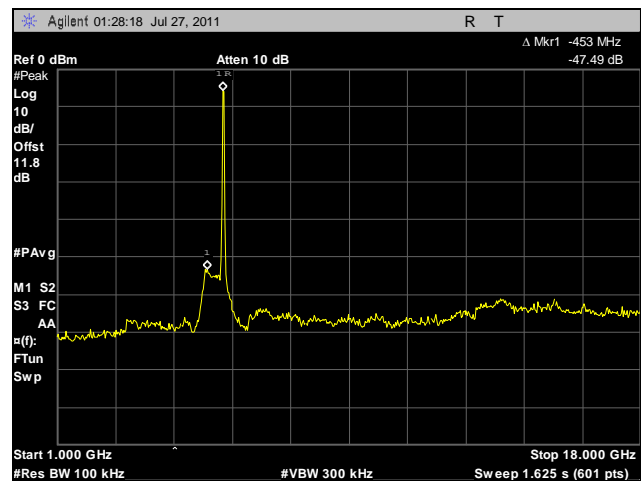

Plot 107. Conducted Spurious Emissions, High Channel, 1 GHz – 18 GHz, 40 MHz, Vertical Feed

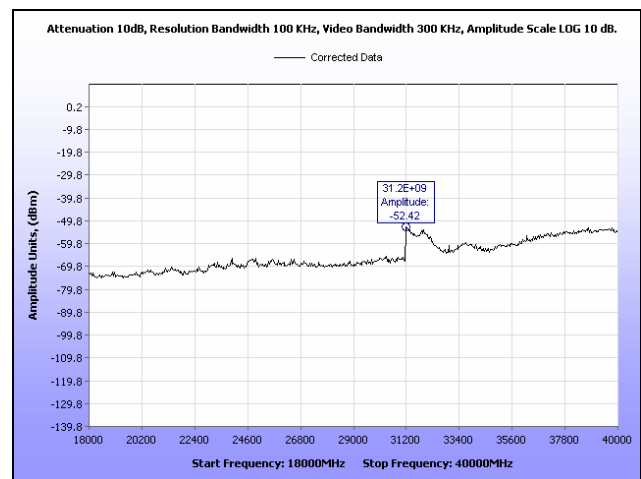

Plot 108. Conducted Spurious Emissions, High Channel, 18 GHz – 40 GHz, 40 MHz, Vertical Feed

Conducted Band Edge Test Results, 20 MHz, Horizontal Feed

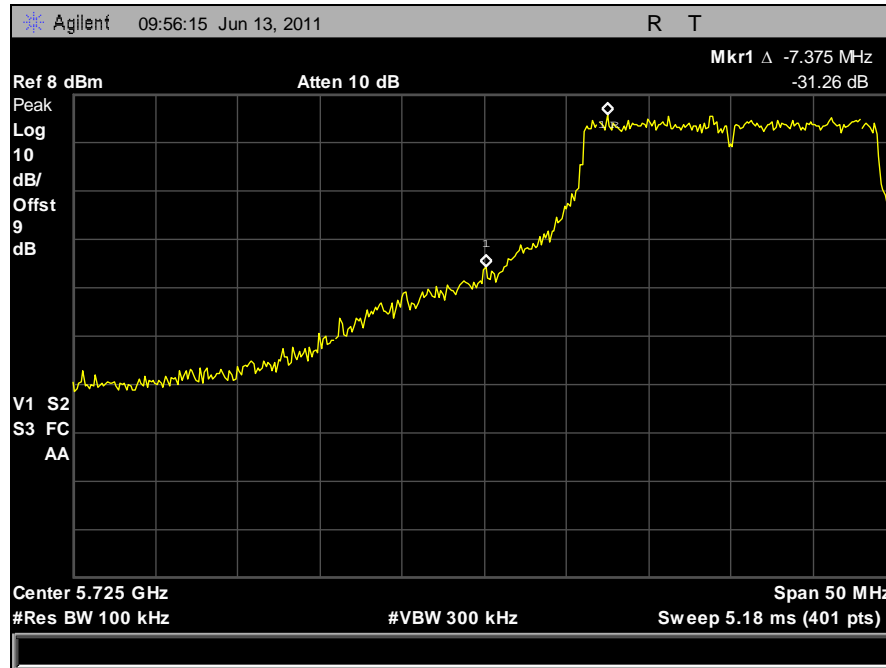

Plot 109. Conducted Band Edge, Low Channel, 20 MHz, Horizontal Feed

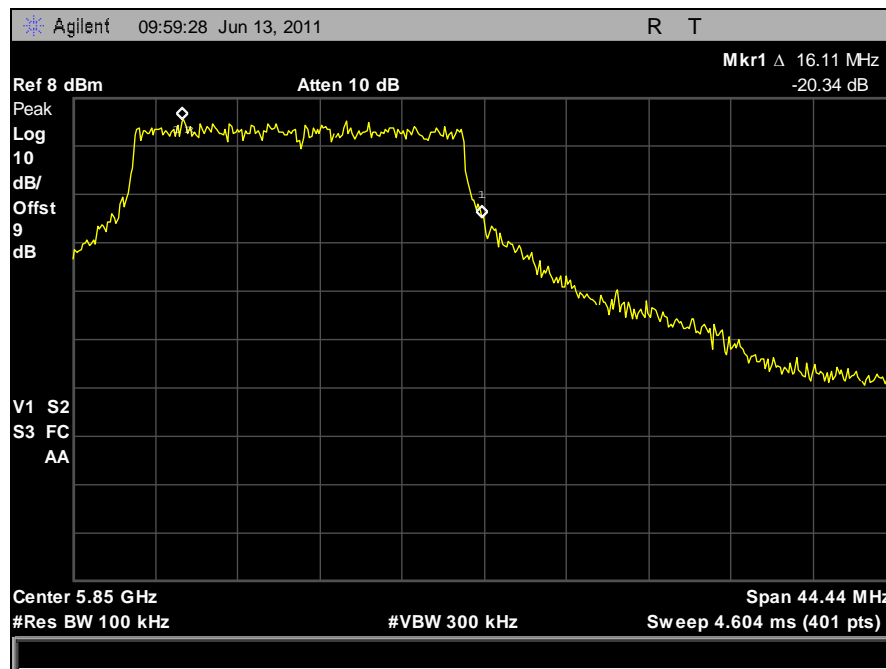

Plot 110. Conducted Band Edge, High Channel, 20 MHz, Horizontal Feed

Conducted Band Edge Test Results, 20 MHz, Vertical Feed

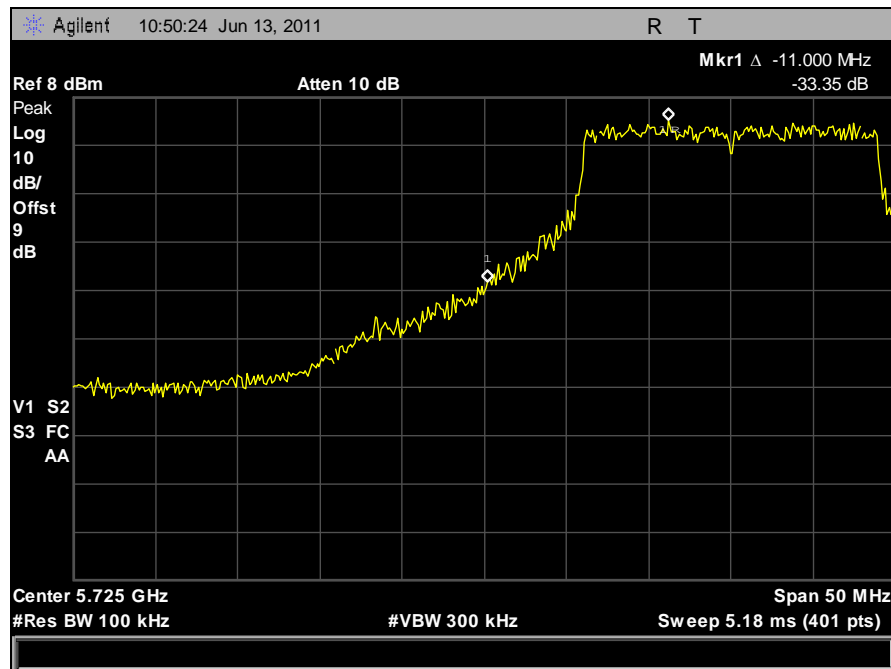

Plot 111. Conducted Band Edge, Low Channel, 20 MHz, Vertical Feed

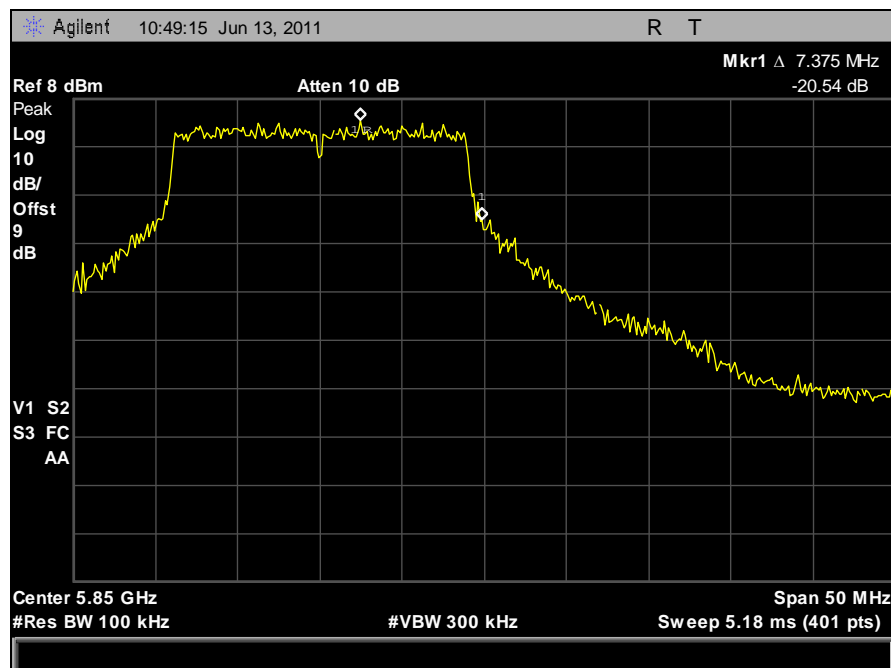

Plot 112. Conducted Band Edge, High Channel, 20 MHz, Vertical Feed

Conducted Band Edge Test Results, 40 MHz, Horizontal Feed

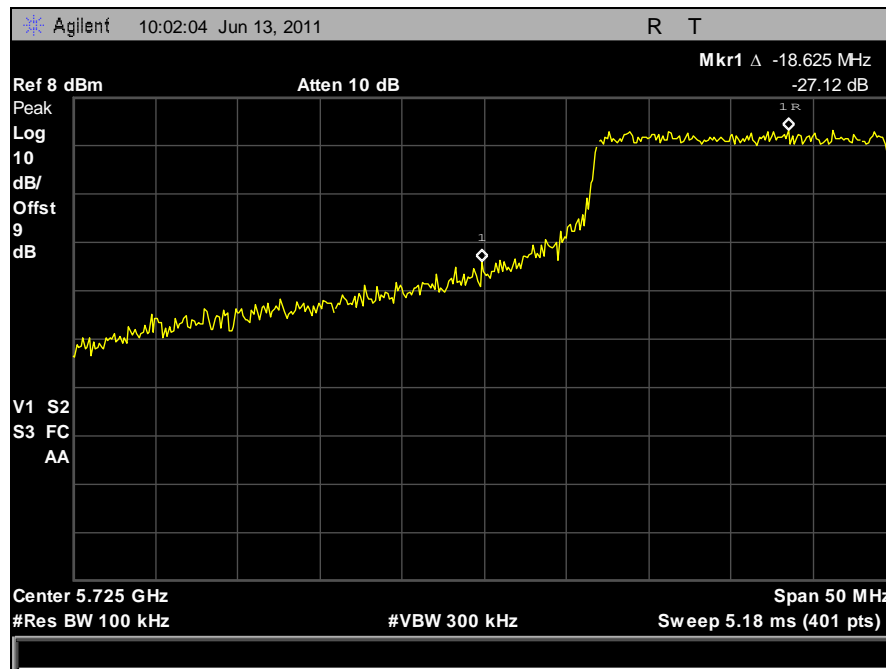

Plot 113. Conducted Band Edge, Low Channel, 40 MHz, Horizontal Feed

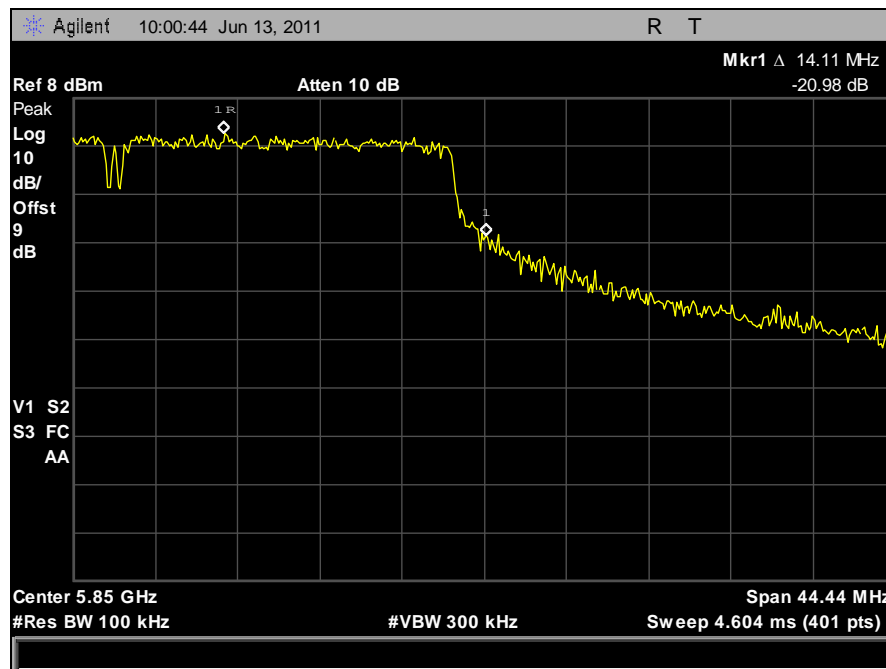

Plot 114. Conducted Band Edge, High Channel, 40 MHz, Horizontal Feed

Conducted Band Edge Test Results, 40 MHz, Vertical Feed

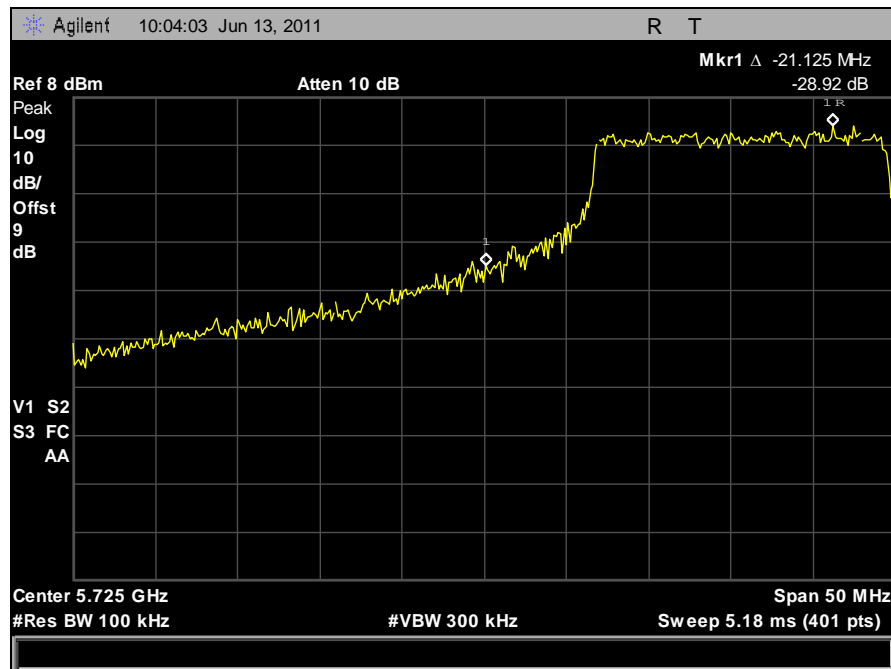

Plot 115. Conducted Band Edge, Low Channel, 40 MHz, Vertical Feed

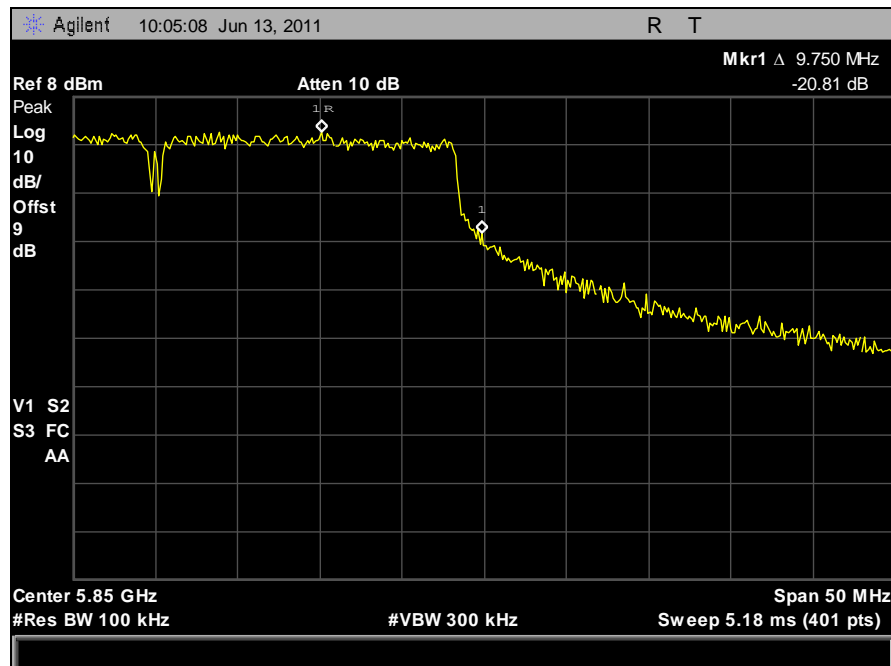

Plot 116. Conducted Band Edge, High Channel, 40 MHz, Vertical Feed

Electromagnetic Compatibility Criteria for Intentional Radiators

§ 15.247(e) Peak Power Spectral Density

Test Requirements: §15.247(e): For digitally modulated systems, the peak power spectral density conducted from the intentional radiator to the antenna shall not be greater than 8dBm in any 3 kHz band during any time interval of continuous transmission.

Test Procedure: The transmitter was connected directly to a Spectrum Analyzer through an attenuator. The power level was set to its maximum level. The RBW was set to 3 kHz and the VBW was set to greater than 9 kHz. The spectrum analyzer's sweep time was set to auto and a peak detector was used. The frequency at which the spectral density was highest was found and centered. The span was changed to 1.5MHz, the sweep time changed to span/RBW = 500s, and the peak level found and recorded.

Test Results: The EUT was compliant with the peak power spectral density limits of § 15.247 (e).
The peak power spectral density was determined from plots on the following page(s).

Test Engineer: Dusmantha Tennakoon & Jeff Pratt

Test Date: 06/15/11 & 08/02/11 – 08/09/11

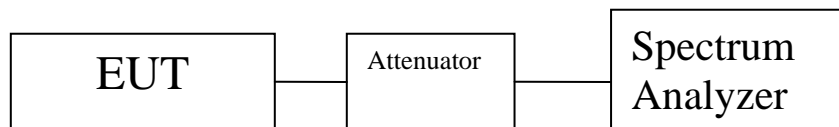

Figure 5. Block Diagram, Peak Power Spectral Density Test Setup

Peak Power Spectral Density Test Results

Channel (MHz)	Nominal Bandwidth (MHz)	H Feed PSD (dBm/MHz)	H Feed PSD (mW/MHz)	V Feed PSD (dBm/MHz)	V Feed PSD (mW/MHz)	Summed PSD (mW/MHz)	Summed PSD (dBm/MHz)	Limit (dBm/MHz)	Margin (dB)	Channel (MHz)
5740	20	-12.38	0.06	-13.60	0.04	0.10	-9.94	8	-17.94	5740
5800	20	-13.11	0.05	-15.14	0.03	0.08	-11.00	8	-19.00	5800
5840	20	-10.81	0.08	-14.92	0.03	0.12	-9.39	8	-17.39	5840
5750	40	-9.19	0.12	-16.42	0.02	0.14	-8.44	8	-16.44	5750
5790	40	-9.19	0.12	-16.74	0.02	0.14	-8.49	8	-16.49	5790
5830	40	-9.44	0.11	-16.62	0.02	0.14	-8.68	8	-16.68	5830

Table 28. Peak Power Spectral Density, Test Results

Peak Power Spectral Density, 20 MHz, Horizontal Feed

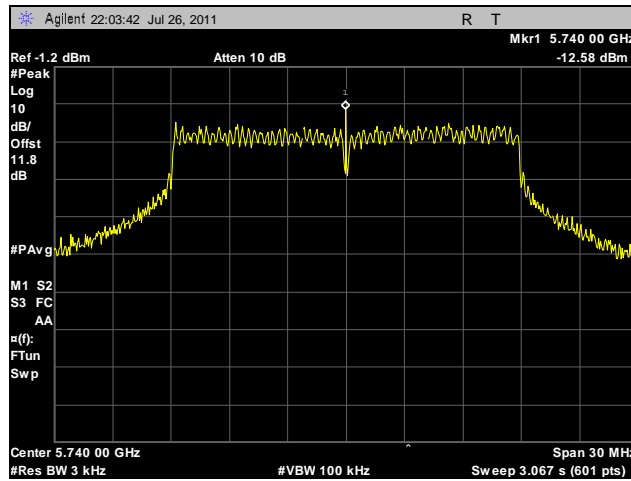

Plot 117. Peak Power Spectral Density, Low Channel, 20 MHz, Horizontal Feed, Determination

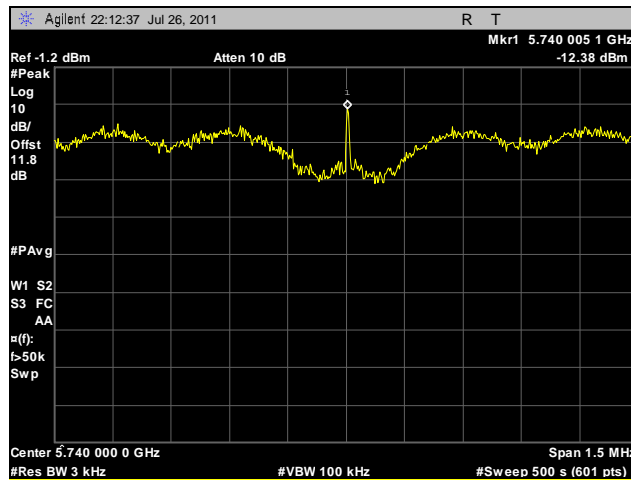

Plot 118. Peak Power Spectral Density, Low Channel, 20 MHz, Horizontal Feed

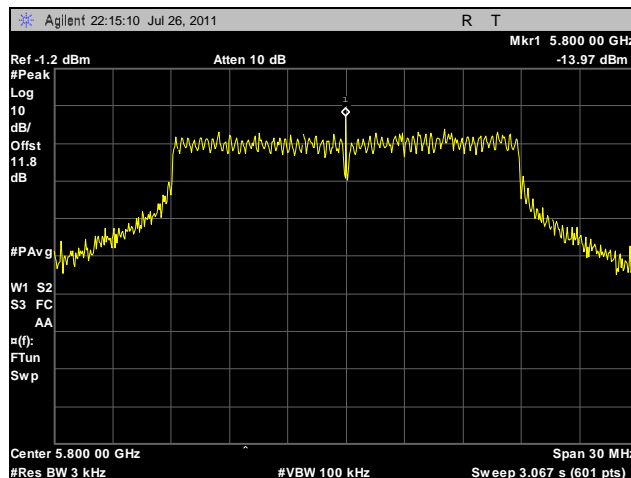

Plot 119. Peak Power Spectral Density, Mid Channel, 20 MHz, Horizontal Feed, Determination

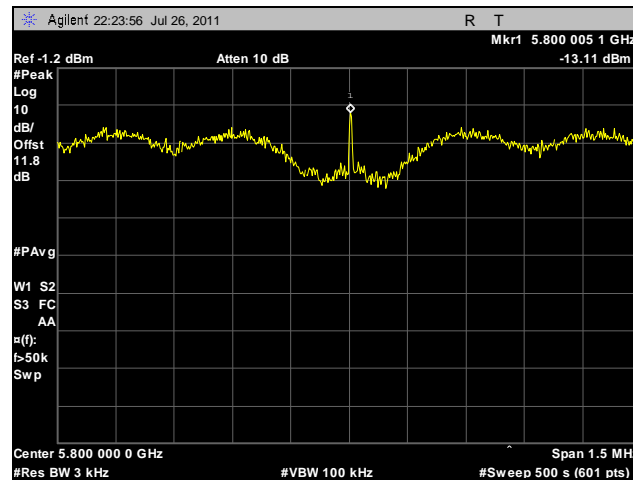

Plot 120. Peak Power Spectral Density, Mid Channel, 20 MHz, Horizontal Feed

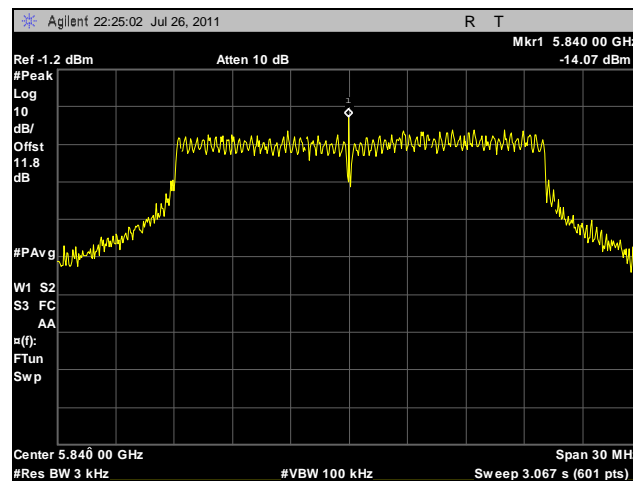

Plot 121. Peak Power Spectral Density, High Channel, 20 MHz, Horizontal Feed, Determination

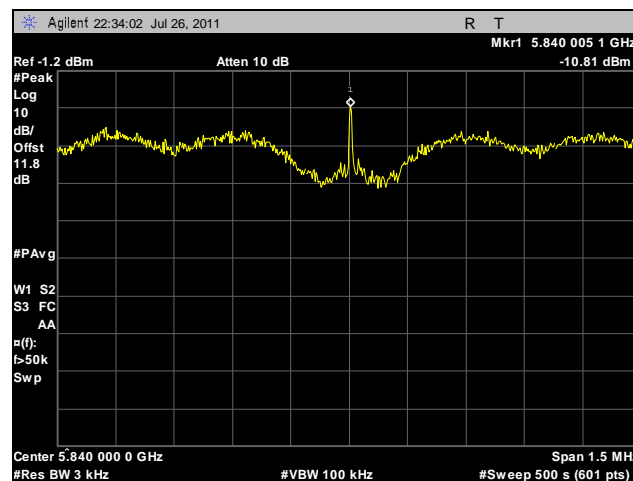

Plot 122. Peak Power Spectral Density, High Channel, 20 MHz, Horizontal Feed

Peak Power Spectral Density, 20 MHz, Vertical Feed

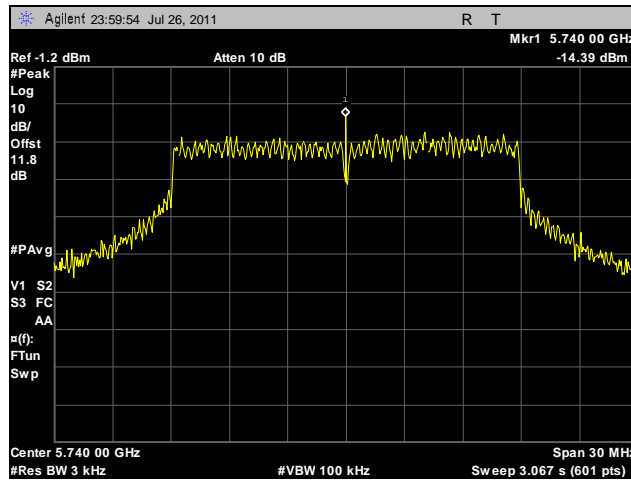

Plot 123. Peak Power Spectral Density, Low Channel, 20 MHz, Vertical Feed, Determination

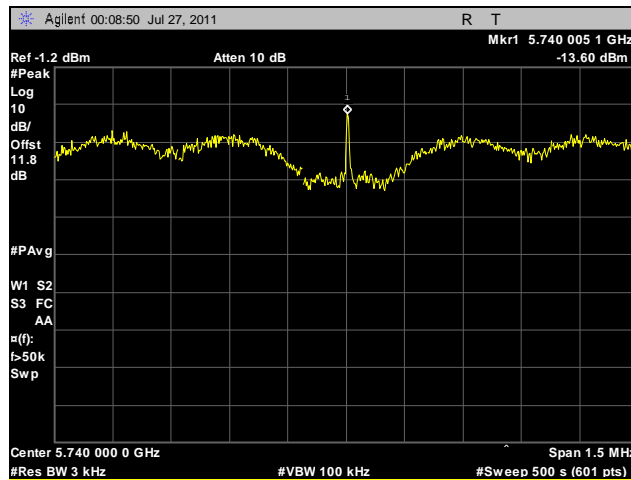

Plot 124. Peak Power Spectral Density, Low Channel, 20 MHz, Vertical Feed

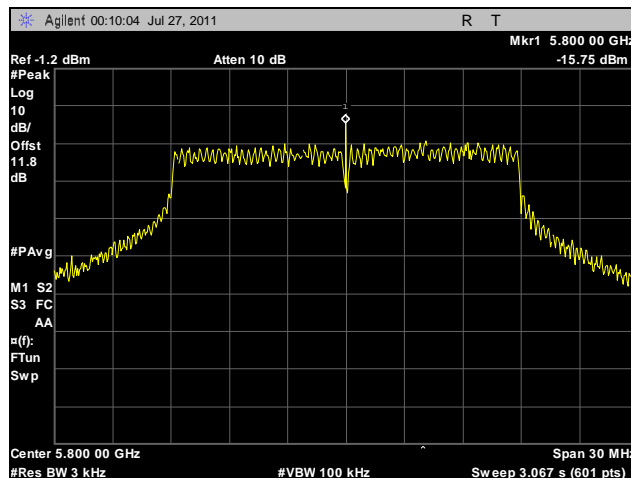

Plot 125. Peak Power Spectral Density, Mid Channel, 20 MHz, Vertical Feed, Determination

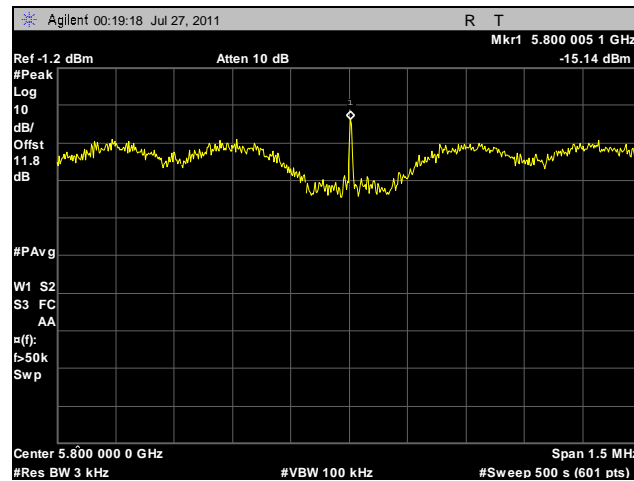

Plot 126. Peak Power Spectral Density, Mid Channel, 20 MHz, Vertical Feed

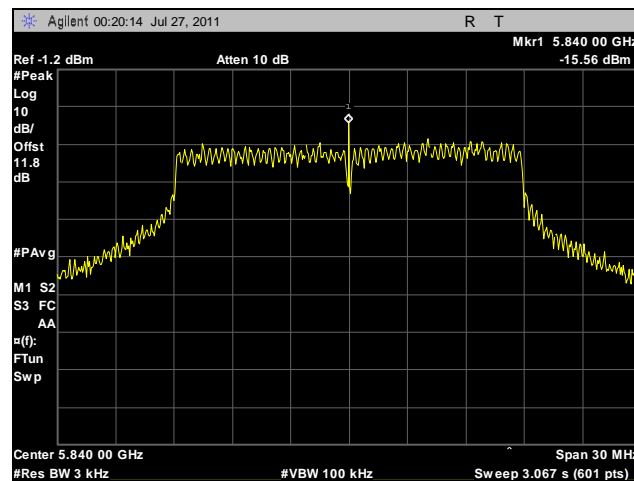

Plot 127. Peak Power Spectral Density, High Channel, 20 MHz, Vertical Feed, Determination



Plot 128. Peak Power Spectral Density, High Channel, 20 MHz, Vertical Feed

Peak Power Spectral Density, 40 MHz, Horizontal Feed

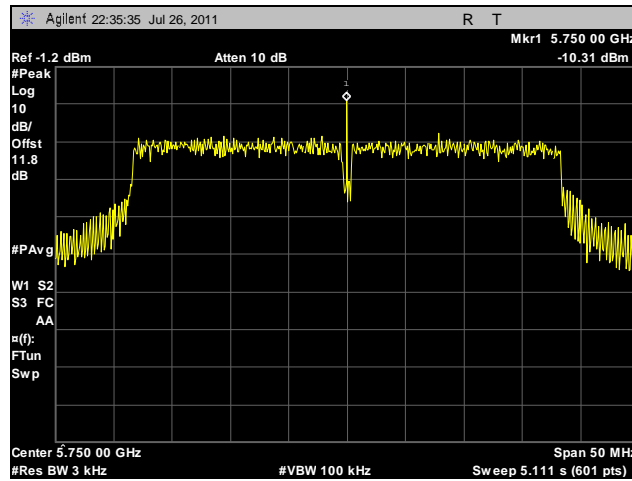

Plot 129. Peak Power Spectral Density, Low Channel, 40 MHz, Horizontal Feed, Determination

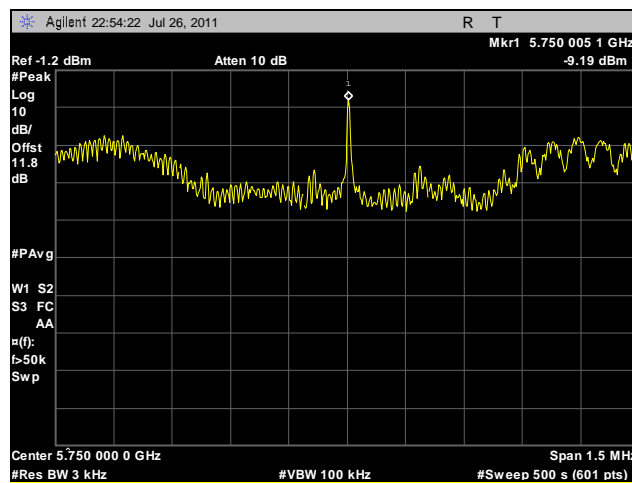

Plot 130. Peak Power Spectral Density, Low Channel, 40 MHz, Horizontal Feed

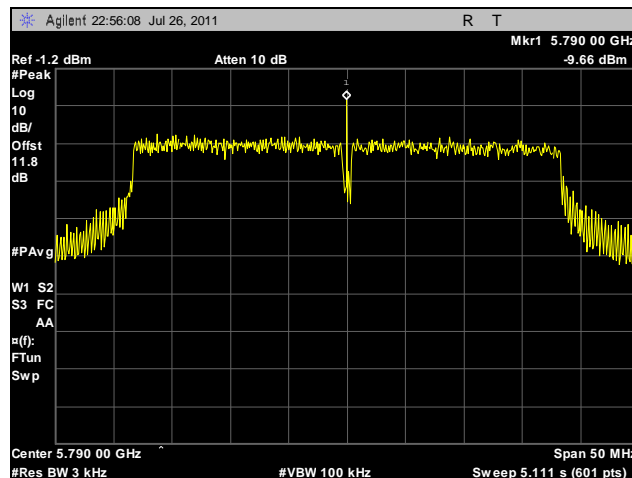

Plot 131. Peak Power Spectral Density, Mid Channel, 40 MHz, Horizontal Feed, Determination

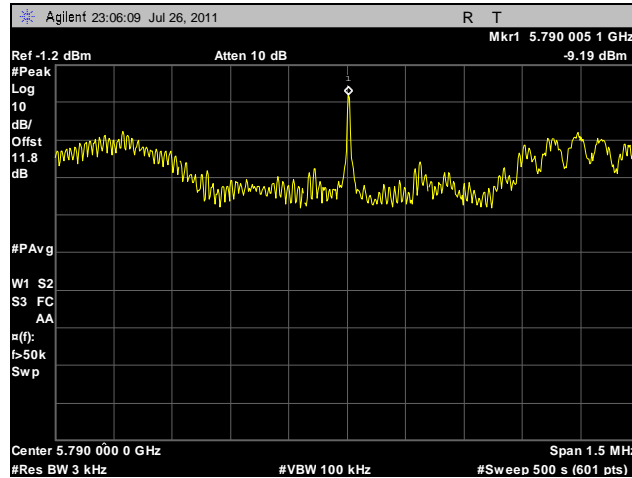

Plot 132. Peak Power Spectral Density, Mid Channel, 40 MHz, Horizontal Feed

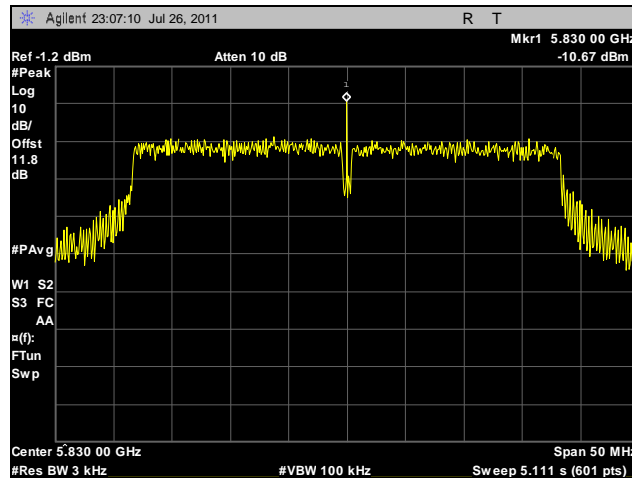

Plot 133. Peak Power Spectral Density, High Channel, 40 MHz, Horizontal Feed, Determination

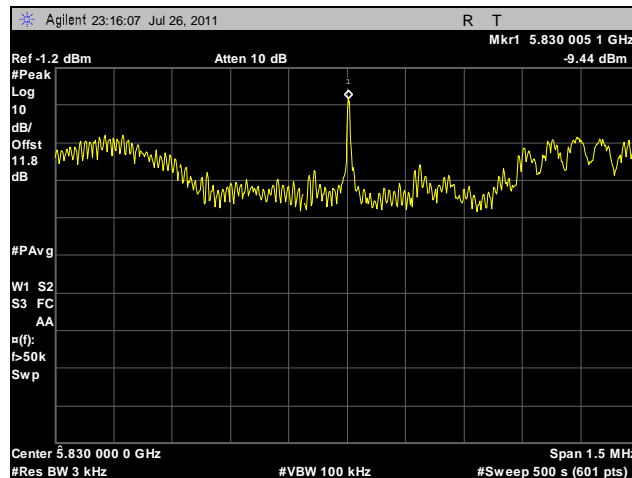

Plot 134. Peak Power Spectral Density, High Channel, 40 MHz, Horizontal Feed

Peak Power Spectral Density, 40 MHz, Vertical Feed

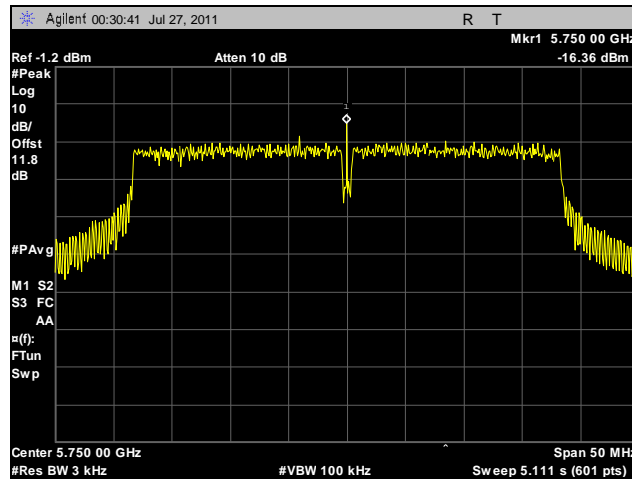

Plot 135. Peak Power Spectral Density, Low Channel, 40 MHz, Vertical Feed, Determination

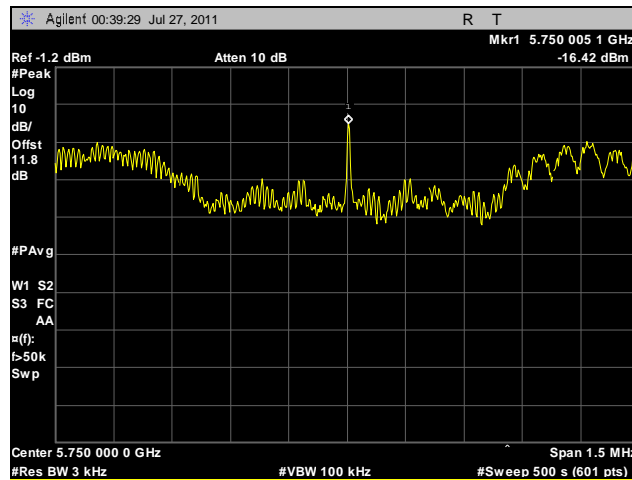

Plot 136. Peak Power Spectral Density, Low Channel, 40 MHz, Vertical Feed

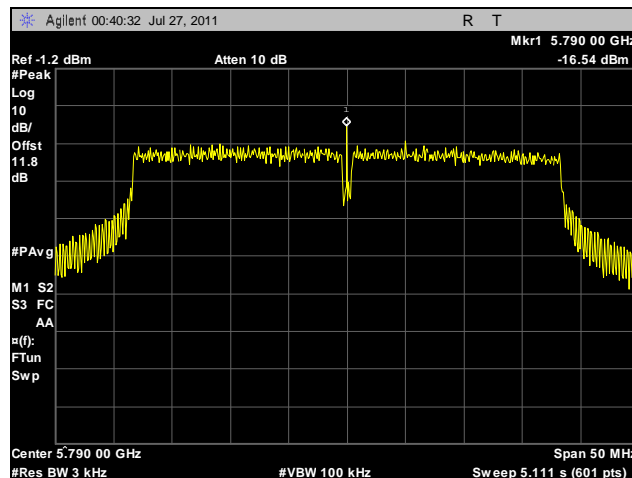

Plot 137. Peak Power Spectral Density, Mid Channel, 40 MHz, Vertical Feed, Determination

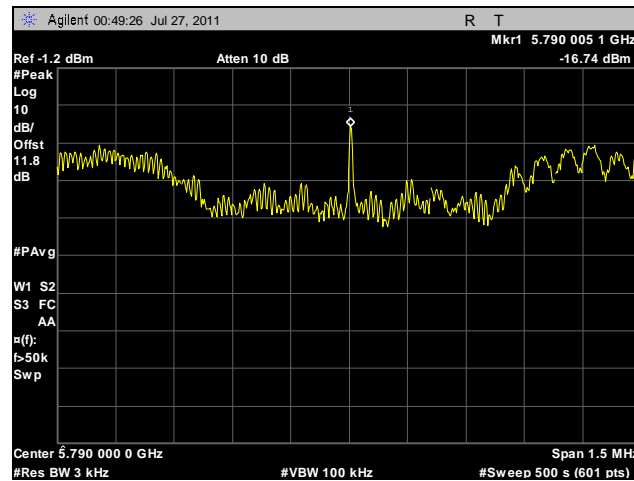

Plot 138. Peak Power Spectral Density, Mid Channel, 40 MHz, Vertical Feed

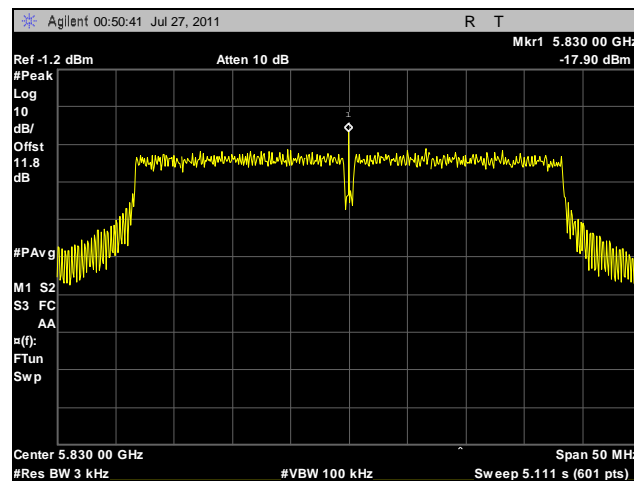

Plot 139. Peak Power Spectral Density, High Channel, 40 MHz, Vertical Feed, Determination

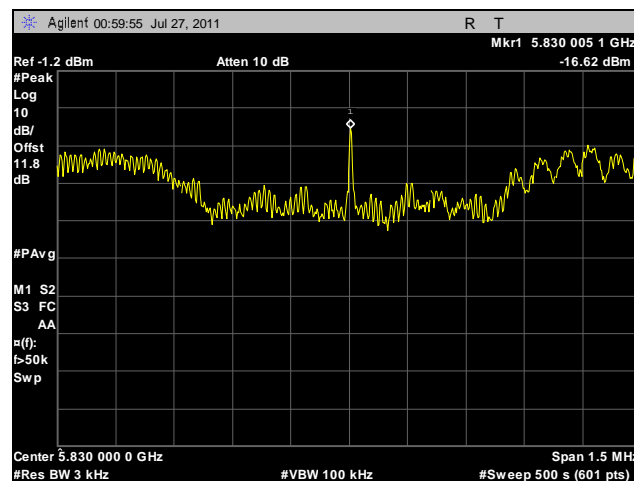

Plot 140. Peak Power Spectral Density, High Channel, 40 MHz, Vertical Feed

Electromagnetic Compatibility Criteria for Intentional Radiators

§ 15.247(i) Maximum Permissible Exposure

RF Exposure Requirements: §1.1307(b)(1) and §1.1307(b)(2): Systems operating under the provisions of this section shall be operated in a manner that ensures that the public is not exposed to radio frequency energy levels in excess of the Commission's guidelines.

RF Radiation Exposure Limit: §1.1310: As specified in this section, the Maximum Permissible Exposure (MPE) Limit shall be used to evaluate the environmental impact of human exposure to radiofrequency (RF) radiation as specified in Sec. 1.1307(b), except in the case of portable devices which shall be evaluated according to the provisions of Sec. 2.1093 of this chapter.

MPE Limit Calculation: EUT's operating frequencies @ 5740-5840 MHz; highest conducted power = 17.52dBm (peak) therefore, **Limit for Uncontrolled exposure: 1 mW/cm² or 10 W/m²**

EUT maximum antenna gain @ 5.8GHz = 23 dBi

Equation from page 18 of OET 65, Edition 97-01

$$S = PG / 4\pi R^2 \quad \text{or} \quad R = \sqrt{PG} / 4\pi S$$

where, S = Power Density (<1 mW/cm²)
P = Power Input to antenna (56.49mW)
G = Antenna Gain (199.53 numeric)
R = Radius (20cm)

$$S = (56.49 * 199.53) / (4 * 3.14 * 20^2) = 2.244 \text{ mW/cm}^2$$
$$R = ((56.49 * 199.53) / (4 * 3.14 * 1.0))^{0.5} = 29.96 \text{ cm}$$

Electromagnetic Compatibility Criteria for Intentional Radiators

RSS-GEN Receiver Spurious Emissions Requirements

Test Requirements: The following receiver spurious emission limits shall be complied with:

- (a) If a radiated measurement is made, all spurious emissions shall comply with the limits of Table 29.

Spurious Frequency (MHz)	Field Strength (microvolt/m at 3 metres)
30 – 88	100
88 – 216	150
216 – 960	200
Above 960	500

Table 29. Spurious Emission Limits for Receivers

- (b) If a conducted measurement is made, no spurious output signals appearing at the antenna terminals shall exceed 2 nanowatts per any 4 kHz spurious frequency in the band 30-1000 MHz, or 5 nanowatts above 1 GHz.

Test Procedures: The EUT was programmed for receive mode only. Conducted measurements were taken at the antenna port of the EUT. 100 kHz resolution bandwidth was used from 30 MHz - 1 GHz and 300 kHz resolution was used for measurements done above 1 GHz. All plots are corrected for cable loss.

Test Results: Equipment is compliant with the Receiver Spurious Emissions Requirements of RSS-GEN.

Test Engineer(s): Dusmantha Tennakoon & Jeff Pratt

Test Date(s): 06/15/11 & 08/09/11

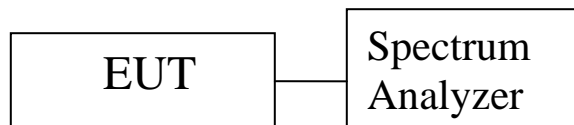
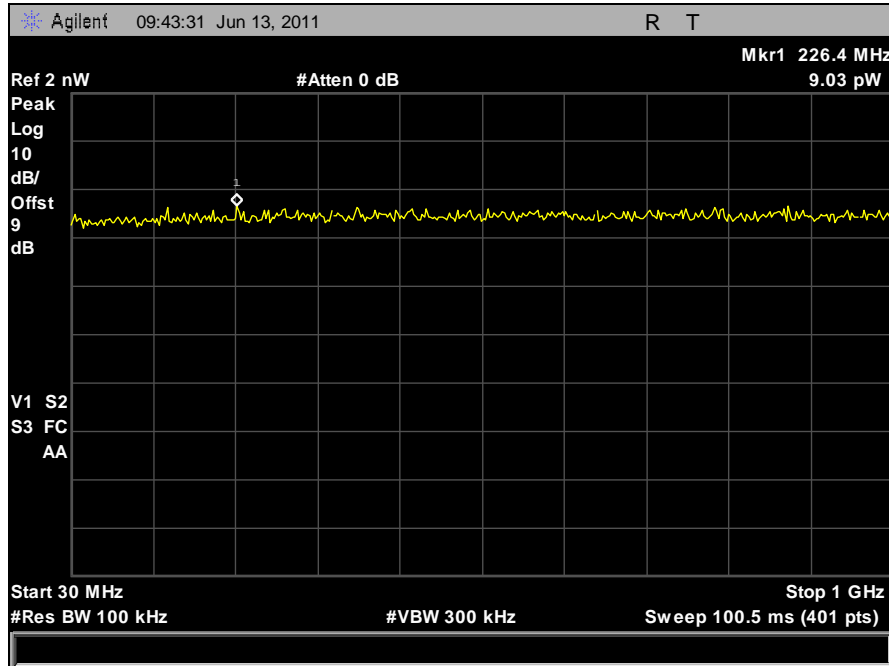
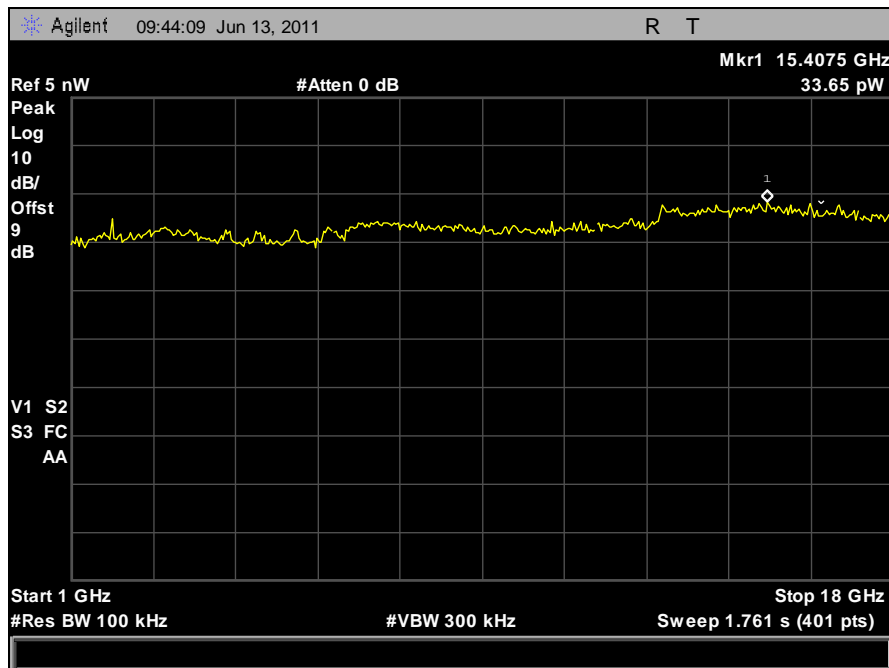

Figure 6. Block Diagram, Conducted Receiver Spurious Emissions Test Setup

Conducted Receiver Spurious Emissions, Horizontal Feed



Plot 141. Conducted Receiver Spurious Emissions, Mid Channel, 30 MHz – 1 GHz, Horizontal Feed



Plot 142. Conducted Receiver Spurious Emissions, Mid Channel, 1 GHz – 18 GHz, Horizontal Feed

Conducted Receiver Spurious Emissions, Vertical Feed

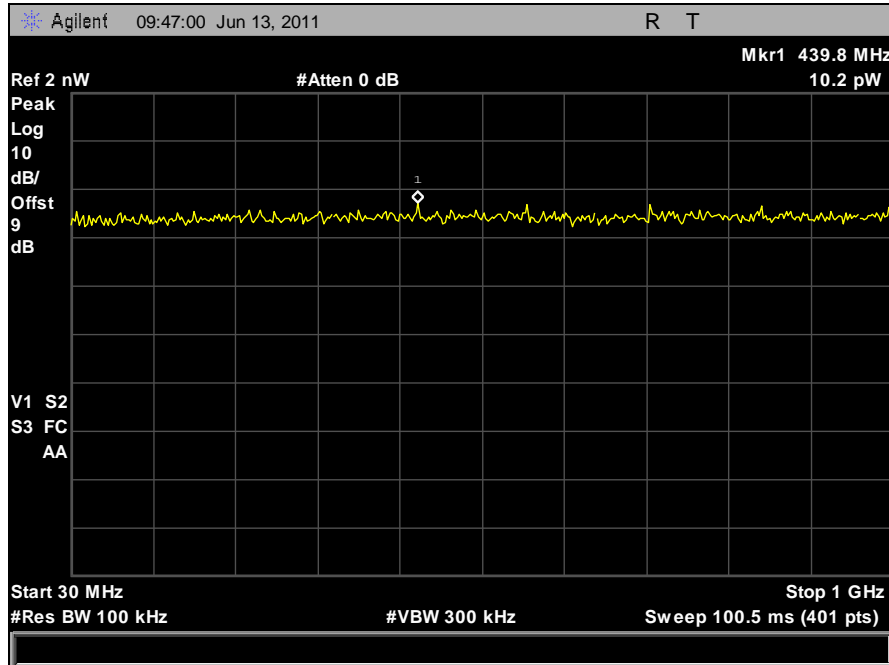

Plot 143. Conducted Receiver Spurious Emissions, Mid Channel, 30 MHz – 1 GHz, Vertical Feed

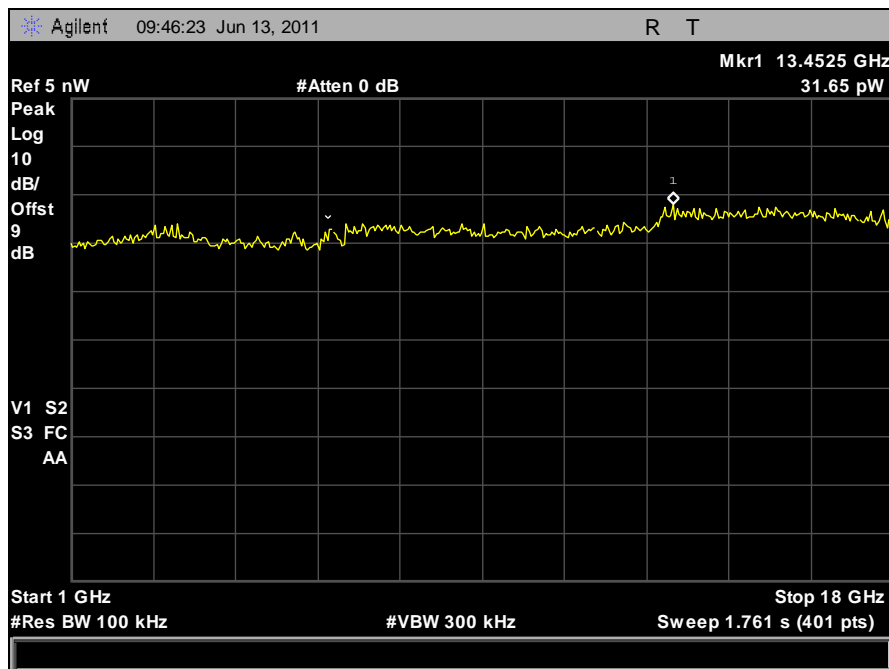

Plot 144. Conducted Receiver Spurious Emissions, Mid Channel, 1 GHz – 18 GHz, Vertical Feed

IV. Test Equipment

Test Equipment

Calibrated test equipment utilized during testing was maintained in a current state of calibration per the requirements of ANSI/NCSL Z540-1-1994 and ANSI/ISO/IEC 17025:2000.

MET Asset #	Equipment	Manufacturer	Model	Last Cal Date	Cal Due Date
1T2665	HORN ANTENNA	EMCO	3115	07/15/2010	07/15/2011
1T4300	SEMI-ANECHOIC CHAMBER # 1	EMC TEST SYSTEMS	NONE	08/23/2010	08/23/2011
1T4303	ANTENNA; BILOG	SCHAFNER - CHASE EMC	CBL6140A	09/14/2009	09/14/2010
1T4409	EMI RECEIVER	ROHDE & SCHWARZ	ESIB7	06/14/2011	06/14/2012
1T2511	ANTENNA; HORN	EMCO	3115	08/31/2010	08/31/2011
1T4612	SPECTRUM ANALYZER	AGILENT TECHNOLOGIES	E4407B	09/27/2010	09/27/2011
1T4681	SPECTRUM ANALYZER	AGILENT TECHNOLOGIES	E4448A	1/27/2011	1/27/2012
1T4737	HIGH FREQUENCY PREAMP	MITEQ	AFS42-01001800	SEE NOTE	
1T4592	RF FILTER KIT	VARIOUS	N/A	SEE NOTE	
1T4744	ANTENNA; HORN	ETS-LINDGREN	3116	6/14/2011	6/14/2012
1T4752	PRE-AMPLIFIER	MITEQ	JS44-18004000- 35-8P	SEE NOTE	

Table 30. Test Equipment List

Note: Functionally tested equipment is verified using calibrated instrumentation at the time of testing.

V. Certification & User's Manual Information

Certification & User's Manual Information

A. Certification Information

The following is extracted from Title 47 of the Code of Federal Regulations, Part 2, Subpart I — Marketing of Radio frequency devices:

§ 2.801 Radio-frequency device defined.

As used in this part, a radio-frequency device is any device which in its operation is capable of Emitting radio-frequency energy by radiation, conduction, or other means. Radio- frequency devices include, but are not limited to:

- (a) The various types of radio communication transmitting devices described throughout this chapter.
- (b) *The incidental, unintentional and intentional radiators defined in Part 15 of this chapter.*
- (c) The industrial, scientific, and medical equipment described in Part 18 of this chapter.
- (d) Any part or component thereof which in use emits radio-frequency energy by radiation, conduction, or other means.

§ 2.803 Marketing of radio frequency devices prior to equipment authorization.

- (a) Except as provided elsewhere in this chapter, no person shall sell or lease, or offer for sale or lease (including advertising for sale or lease), or import, ship or distribute for the purpose of selling or leasing or offering for sale or lease, any radio frequency device unless:
 - (1) In the case of a device subject to certification, such device has been authorized by the Commission in accordance with the rules in this chapter and is properly identified and labeled as required by §2.925 and other relevant sections in this chapter; or
 - (2) In the case of a device that is not required to have a grant of equipment authorization issued by the Commission, but which must comply with the specified technical standards prior to use, such device also complies with all applicable administrative (including verification of the equipment or authorization under a Declaration of Conformity, where required), technical, labeling and identification requirements specified in this chapter.
- (d) Notwithstanding the provisions of paragraph (a) of this section, the offer for sale solely to business, commercial, industrial, scientific or medical users (but not an offer for sale to other parties or to end users located in a residential environment) of a radio frequency device that is in the conceptual, developmental, design or pre-production stage is permitted prior to equipment authorization or, for devices not subject to the equipment authorization requirements, prior to a determination of compliance with the applicable technical requirements *provided* that the prospective buyer is advised in writing at the time of the offer for sale that the equipment is subject to the FCC rules and that the equipment will comply with the appropriate rules before delivery to the buyer or to centers of distribution.

- (e)(1) Notwithstanding the provisions of paragraph (a) of this section, prior to equipment authorization or determination of compliance with the applicable technical requirements any radio frequency device may be operated, but not marketed, for the following purposes and under the following conditions:
- (i) *Compliance testing*;
 - (ii) Demonstrations at a trade show provided the notice contained in paragraph (c) of this section is displayed in a conspicuous location on, or immediately adjacent to, the device;
 - (iii) Demonstrations at an exhibition conducted at a business, commercial, industrial, scientific or medical location, but excluding locations in a residential environment, provided the notice contained in paragraphs (c) or (d) of this section, as appropriate, is displayed in a conspicuous location on, or immediately adjacent to, the device;
 - (iv) Evaluation of product performance and determination of customer acceptability, provided such operation takes place at the manufacturer's facilities during developmental, design or pre-production states; or
 - (v) Evaluation of product performance and determination of customer acceptability where customer acceptability of a radio frequency device cannot be determined at the manufacturer's facilities because of size or unique capability of the device, provided the device is operated at a business, commercial, industrial, scientific or medical user's site, but not at a residential site, during the development, design or pre-production stages.
- (e)(2) For the purpose of paragraphs (e)(1)(iv) and (e)(1)(v) of this section, the term *manufacturer's facilities* includes the facilities of the party responsible for compliance with the regulations and the manufacturer's premises, as well as the facilities of other entities working under the authorization of the responsible party in connection with the development and manufacture, but not the marketing, of the equipment.
- (f) For radio frequency devices subject to verification and sold solely to business, commercial, industrial, scientific and medical users (excluding products sold to other parties or for operation in a residential environment), parties responsible for verification of the devices shall have the option of ensuring compliance with the applicable technical specifications of this chapter at each end user's location after installation, provided that the purchase or lease agreement includes a proviso that such a determination of compliance be made and is the responsibility of the party responsible for verification of the equipment.

Certification & User's Manual Information

The following is extracted from Title 47 of the Code of Federal Regulations, Part 2, Subpart J — Equipment Authorization Procedures:

§ 2.901 Basis and Purpose

- (a) In order to carry out its responsibilities under the Communications Act and the various treaties and international regulations, and in order to promote efficient use of the radio spectrum, the Commission has developed technical standards for radio frequency equipment and parts or components thereof. The technical standards applicable to individual types of equipment are found in that part of the rules governing the service wherein the equipment is to be operated.¹ *In addition to the technical standards provided, the rules governing the service may require that such equipment be verified by the manufacturer or importer, be authorized under a Declaration of Conformity, or receive an equipment authorization from the Commission by one of the following procedures: certification or registration.*
- (b) The following sections describe the verification procedure, the procedure for a Declaration of Conformity, and the procedures to be followed in obtaining certification from the Commission and the conditions attendant to such a grant.

§ 2.907 Certification.

- (a) Certification is an equipment authorization issued by the Commission, based on representation and test data submitted by the applicant.
- (b) Certification attaches to all units subsequently marketed by the grantee which are identical (see Section 2.908) to the sample tested except for permissive changes or other variations authorized by the Commission pursuant to Section 2.1043.

¹ In this case, the equipment is subject to the rules of Part 15. More specifically, the equipment falls under Subpart B (of Part 15), which deals with unintentional radiators.

Certification & User's Manual Information

§ 2.948 Description of measurement facilities.

- (a) Each party making measurements of equipment that is subject to an equipment authorization under Part 15 or Part 18 of this chapter, regardless of whether the measurements are filed with the Commission or kept on file by the party responsible for compliance of equipment marketed within the U.S. or its possessions, shall compile a description of the measurement facilities employed.
- (1) If the measured equipment is subject to the verification procedure, the description of the measurement facilities shall be retained by the party responsible for verification of the equipment.
- (i) *If the equipment is verified through measurements performed by an independent laboratory, it is acceptable for the party responsible for verification of the equipment to rely upon the description of the measurement facilities retained by or placed on file with the Commission by that laboratory. In this situation, the party responsible for the verification of the equipment is not required to retain a duplicate copy of the description of the measurement facilities.*
- (ii) If the equipment is verified based on measurements performed at the installation site of the equipment, no specific site calibration data is required. It is acceptable to retain the description of the measurement facilities at the site at which the measurements were performed.
- (2) If the equipment is to be authorized by the Commission under the certification procedure, the description of the measurement facilities shall be filed with the Commission's Laboratory in Columbia, Maryland. The data describing the measurement facilities need only be filed once but must be updated as changes are made to the measurement facilities or as otherwise described in this section. At least every three years, the organization responsible for filing the data with the Commission shall certify that the data on file is current.

Certification & User's Manual Information

1. Label and User's Manual Information

The following is extracted from Title 47 of the Code of Federal Regulations, Part 15, Subpart A — General:

§ 15.19 Labeling requirements.

(a) *In addition to the requirements in Part 2 of this chapter, a device subject to certification or verification shall be labeled as follows:*

- (1) Receivers associated with the operation of a licensed radio service, e.g., FM broadcast under Part 73 of this chapter, land mobile operation under Part 90, etc., shall bear the following statement in a conspicuous location on the device:

This device complies with Part 15 of the FCC Rules. Operation is subject to the condition that this device does not cause harmful interference.

- (2) A stand-alone cable input selector switch, shall bear the following statement in a conspicuous location on the device:

This device is verified to comply with Part 15 of the FCC Rules for use with cable television service.

- (3) All other devices shall bear the following statement in a conspicuous location on the device:

This device complies with Part 15 of the FCC Rules. Operation is subject to the following two conditions: (1) This device may not cause harmful interference, and (2) this device must accept any interference received, including interference that may cause undesired operation.

- (4) Where a device is constructed in two or more sections connected by wires and marketed together, the statement specified under paragraph (a) of this section is required to be affixed only to the main control unit.

- (5) When the device is so small or for such use that it is not practicable to place the statement specified under paragraph (a) of this section on it, the information required by this paragraph shall be placed in a prominent location in the instruction manual or pamphlet supplied to the user or, alternatively, shall be placed on the container in which the device is marketed. However, the FCC identifier or the unique identifier, as appropriate, must be displayed on the device.

§ 15.21 Information to user.

The users manual or instruction manual for an intentional or unintentional radiator shall caution the user that changes or modifications not expressly approved by the party responsible for compliance could void the user's authority to operate the equipment.

Verification & User's Manual Information

The following is extracted from Title 47 of the Code of Federal Regulations, Part 15, Subpart B — Unintentional Radiators:

§ 15.105 Information to the user.

- (a) For a Class A digital device or peripheral, the instructions furnished the user shall include the following or similar statement, placed in a prominent location in the text of the manual:

Note: This equipment has been tested and found to comply with the limits for a Class A digital device, pursuant to Part 15 of the FCC Rules. These limits are designed to provide reasonable protection against harmful interference when the equipment is operated in a commercial environment. This equipment generates, uses, and can radiate radio frequency energy and, if not installed and used in accordance with the instruction manual, may cause harmful interference to radio communications. Operation of this equipment in a residential area is likely to cause harmful interference in which case the user will be required to correct the interference at own expense.

- (b) For a Class B digital device or peripheral, the instructions furnished the user shall include the following or similar statement, placed in a prominent location in the text of the manual:

Note: This equipment has been tested and found to comply with the limits for a Class B digital device, pursuant to Part 15 of the FCC Rules. These limits are designed to provide reasonable protection against harmful interference when the equipment is operated in a residential environment. This equipment generates, uses, and can radiate radio frequency energy and, if not installed and used in accordance with the instruction manual, may cause harmful interference to radio communications. However, there is no guarantee that interference will not occur in a particular installation. If this equipment does cause harmful interference to radio or television reception, which can be determined by turning the equipment off and on, the user is encouraged to try to correct the interference by one or more of the following measures:

- Reorient or relocate the receiving antenna.
- Increase the separation between the equipment and receiver.
- Connect the equipment into an outlet on a circuit different from that to which the receiver is connected.
- Consult the dealer or an experienced radio/TV technician for help.

ICES-003 Procedural & Labeling Requirements

From the Industry Canada Electromagnetic Compatibility Advisory Bulletin entitled, "Implementation and Interpretation of the Interference-Causing Equipment Standard for Digital Apparatus, ICES-003" (EMCAB-3, Issue 2, July 1995):

"At present, CISPR 22: 2002 and ICES technical requirements are essentially equivalent. Therefore, if you have CISPR 22: 2002 approval by meeting CISPR Publication 22, the only additional requirements are: to attach a note to the report of the test results for compliance, indicating that these results are deemed satisfactory evidence of compliance with ICES-003 of the Canadian Interference-Causing Equipment Regulations; to maintain these records on file for the requisite five year period; and to provide the device with a notice of compliance in accordance with ICES-003."

Procedural Requirements:

According to Industry Canada's Interference Causing Equipment Standard for Digital Apparatus ICES-003 Issue 4, February 2004:

- Section 6.1: A record of the measurements and results, showing the date that the measurements were completed, shall be retained by the manufacturer or importer for a period of at least five years from the date shown in the record and made available for examination on the request of the Minister.
- Section 6.2: A written notice indicating compliance must accompany each unit of digital apparatus to the end user. The notice shall be in the form of a label that is affixed to the apparatus. Where because of insufficient space or other constraints it is not feasible to affix a label to the apparatus, the notice may be in the form of a statement in the user's manual.

Labeling Requirements:

The suggested text for the notice, in English and in French, is provided below, from the Annex of ICES-003:

This Class [²] digital apparatus complies with Canadian ICES-003.

Cet appareil numérique de la classe [¹] est conforme à la norme NMB-003 du Canada.

² Insert either A or B but not both as appropriate for the equipment requirements.

End of Report