

SAR Test Report

Report No.: AGC00454180501FH01

FCC ID : X8F-SX500
APPLICATION PURPOSE : Original Equipment
PRODUCT DESIGNATION : SkyCaddie SX500
BRAND NAME : SkyCaddie
MODEL NAME : SX500
CLIENT : SkyHawke Technologies, LLC
DATE OF ISSUE : Aug. 31,2018
STANDARD(S) : IEEE Std. 1528:2013
FCC 47CFR § 2.1093
IEEE/ANSI C95.1:2005
REPORT VERSION : V1.2

Attestation of Global Compliance(Shenzhen) Co., Ltd.

CAUTION:

This report shall not be reproduced except in full without the written permission of the test laboratory and shall not be quoted out of context.



The results shown in this test report refer only to the sample(s) tested unless otherwise stated and the sample(s) are retained for 30 days only. The document is issued by AGC, this document cannot be reproduced except in full with our prior written permission. The more details and the authenticity of the report will be confirmed at <http://www.agc-cert.com>.

Report Revise Record

Report Version	Revise Time	Issued Date	Valid Version	Notes
V1.0	/	Aug. 08,2018	Invalid	Initial Release
V1.1	1 st	Aug. 28,2018	Invalid	Deleted hot spot mode and KDB 941228
V1.2	2 nd	Aug. 31,2018	Valid	Added the test of body(with 0 mm separation)

The results shown in this test report refer only to the sample(s) tested unless otherwise stated and the sample(s) are retained for 30 days only. The document is issued by AGC, this document cannot be reproduced except in full with our prior written permission. The more details and the authenticity of the report will be confirmed at <http://www.agc-cert.com>.

Test Report Certification

Applicant Name	SkyHawke Technologies, LLC
Applicant Address	274 Commerce Park Drive, Ridgeland, MS 39157 USA
Manufacturer Name	SkyHawke Technologies, LLC
Manufacturer Address	274 Commerce Park Drive, Ridgeland, MS 39157 USA
Product Designation	SkyCaddie SX500
Brand Name	SkyCaddie
Model Name	SX500
Different Description	N/A
EUT Voltage	DC3.8V by battery
Applicable Standard	IEEE Std. 1528:2013 FCC 47CFR § 2.1093 IEEE/ANSI C95.1:2005
Test Date	Aug. 03,2018 to Aug. 30,2018
Performed Location	Attestation of Global Compliance(Shenzhen) Co., Ltd.
	2 F, Building 2, No.1-No.4, Chaxi Sanwei Technical Industrial Park, Gushu, Xixiang Street, Bao'an District, Shenzhen, China
Report Template	AGCRT-US-2.4G/SAR (2018-01-01)



Tested By _____

Eric Zhou(Zhou Yongkang) Aug. 30,2018



Checked By _____

Angela Li(Li Jiao) Aug. 31,2018



Authorized By _____

 Forrest Lei(Lei Yonggang)
 Authorized Officer Aug. 31,2018

The results shown in this test report refer only to the sample(s) tested unless otherwise stated and the sample(s) are retained for 30 days only. The document is issued by AGC, this document cannot be reproduced except in full with our prior written permission. The more details and the authenticity of the report will be confirmed at <http://www.agc-cert.com>.

TABLE OF CONTENTS

1. SUMMARY OF MAXIMUM SAR VALUE 5

2. GENERAL INFORMATION..... 6

 2.1. EUT DESCRIPTION..... 6

3. SAR MEASUREMENT SYSTEM..... 7

 3.1. THE SATIMO SYSTEM USED FOR PERFORMING COMPLIANCE TESTS CONSISTS OF FOLLOWING ITEMS 7

 3.2. COMOSAR E-FIELD PROBE 8

 3.3. ROBOT..... 9

 3.4. VIDEO POSITIONING SYSTEM 9

 3.5. DEVICE HOLDER 10

 3.6. SAM TWIN PHANTOM..... 10

4. SAR MEASUREMENT PROCEDURE..... 11

 4.1. SPECIFIC ABSORPTION RATE (SAR)..... 11

 4.2. SAR MEASUREMENT PROCEDURE 12

 4.3. RF EXPOSURE CONDITIONS 14

5. TISSUE SIMULATING LIQUID..... 16

 5.1. THE COMPOSITION OF THE TISSUE SIMULATING LIQUID..... 16

 5.2. TISSUE DIELECTRIC PARAMETERS FOR HEAD AND BODY PHANTOMS 16

 5.3. TISSUE CALIBRATION RESULT 17

6. SAR SYSTEM CHECK PROCEDURE 18

 6.1. SAR SYSTEM CHECK PROCEDURES 18

 6.2. SAR SYSTEM CHECK..... 19

7. EUT TEST POSITION..... 20

 7.1. DEFINE TWO IMAGINARY LINES ON THE HANDSET..... 20

 7.2. CHEEK POSITION 21

 7.3. TILT POSITION..... 21

 7.4. BODY WORN POSITION 22

8. SAR EXPOSURE LIMITS 23

9. TEST FACILITY 24

10. TEST EQUIPMENT LIST 25

11. MEASUREMENT UNCERTAINTY 26

12. CONDUCTED POWER MEASUREMENT..... 32

13. TEST RESULTS 33

 13.1. SAR TEST RESULTS SUMMARY..... 33

APPENDIX A. SAR SYSTEM CHECK DATA 36

APPENDIX B. SAR MEASUREMENT DATA..... 42

APPENDIX C. TEST SETUP PHOTOGRAPHS..... 66

APPENDIX D. CALIBRATION DATA 73

The results shown in this test report refer only to the sample(s) tested unless otherwise stated and the sample(s) are retained for 30 days only. The document is issued by AGC, this document cannot be reproduced except in full with our prior written permission. The more details and the authenticity of the report will be confirmed at <http://www.agc-cert.com>.

1. SUMMARY OF MAXIMUM SAR VALUE

The maximum results of Specific Absorption Rate (SAR) found during testing for EUT are as follows:

Frequency Band	Highest Reported 1g-SAR(W/Kg)			SAR Test Limit (W/Kg)
	Head	Body-worn (with 10 mm separation)	Body-worn (with 0 mm separation)	
802.11b	0.337	0.109	0.691	1.6
SAR Test Result	PASS			

This device is compliance with Specific Absorption Rate (SAR) for general population/uncontrolled exposure limits (1.6W/Kg) specified in IEEE Std. 1528:2013; FCC 47CFR § 2.1093; IEEE/ANSI C95.1:2005 and the following specific FCC Test Procedures:

- KDB 447498 D01 General RF Exposure Guidance v06
- KDB 648474 D04 Handset SAR v01r03
- KDB 865664 D01 SAR Measurement 100MHz to 6GHz v01r04
- KDB 248227 D01 802 11 Wi-Fi SAR v02r02

The results shown in this test report refer only to the sample(s) tested unless otherwise stated and the sample(s) are retained for 30 days only. The document is issued by AGC, this document cannot be reproduced except in full with our prior written permission. The more details and the authenticity of the report will be confirmed at <http://www.agc-cert.com>.

2. GENERAL INFORMATION

2.1. EUT Description

General Information	
Product Designation	SkyCaddie SX500
Test Model	SX500
Hardware Version	E523-MB-P3.0
Software Version	SX500_V1_00_14
Device Category	Portable
RF Exposure Environment	Uncontrolled
Antenna Type	Internal
Bluetooth	
Bluetooth Version	<input type="checkbox"/> V2.0 <input type="checkbox"/> V2.1 <input type="checkbox"/> V2.1+EDR <input type="checkbox"/> V3.0 <input type="checkbox"/> V3.0+HS <input checked="" type="checkbox"/> V4.0 <input type="checkbox"/> V4.1
Operation Frequency	2402~2480MHz
Type of modulation	<input checked="" type="checkbox"/> GFSK <input checked="" type="checkbox"/> II/4-DQPSK <input checked="" type="checkbox"/> 8-DPSK
Max. Peak Power	2.573dBm
Antenna Gain	1.0dBi
WIFI	
WIFI Specification	<input type="checkbox"/> 802.11a <input checked="" type="checkbox"/> 802.11b <input checked="" type="checkbox"/> 802.11g <input checked="" type="checkbox"/> 802.11n(20) <input checked="" type="checkbox"/> 802.11n(40)
Operation Frequency	2412~2462MHz
Avg. Burst Power	IEEE 802.11b:14.65dBm, IEEE 802.11g:12.59dBm; IEEE 802.11n(20):12.20dBm, IEEE 802.11n(40):11.67dBm
Antenna Gain	1.0dBi
Accessories	
Battery	Brand name: N/A Model No. : 776065PV Voltage and Capacitance: 3.8V & 4700mAh
Adapter	Brand name: Tianyin Model No. : TPA-46050200UU Input: AC 100-240V, 50/60Hz, 0.3A Output: DC 5V, 2A
Earphone	Brand name: N/A Model No. : N/A
Note: The sample used for testing is end product.	
Product	Type <input checked="" type="checkbox"/> Production unit <input type="checkbox"/> Identical Prototype

The results shown in this test report refer only to the sample(s) tested unless otherwise stated and the sample(s) are retained for 30 days only. The document is issued by AGC, this document cannot be reproduced except in full with our prior written permission. The more details and the authenticity of the report will be confirmed at <http://www.agc-cert.com>.

3. SAR MEASUREMENT SYSTEM

3.1. The SATIMO system used for performing compliance tests consists of following items

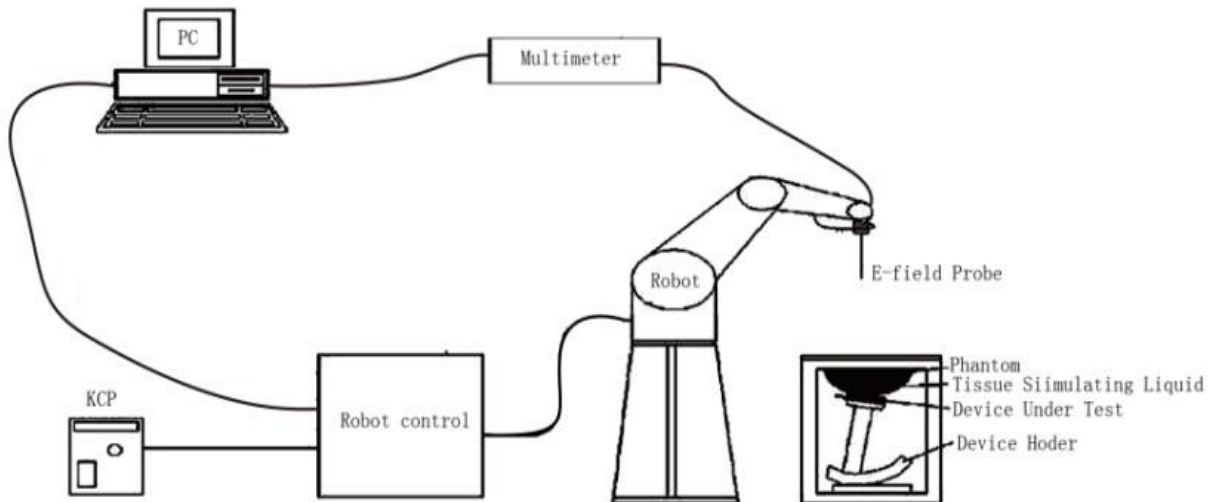

The COMOSAR system for performing compliance tests consists of the following items:

- The PC. It controls most of the bench devices and stores measurement data. A computer running WinXP and the Opensar software.
- The E-Field probe. The probe is a 3-axis system made of 3 distinct dipoles. Each dipole returns a voltage in function of the ambient electric field.
- The Keithley multimeter measures each probe dipole voltages.
- The SAM phantom simulates a human head. The measurement of the electric field is made inside the phantom.
- The liquids simulate the dielectric properties of the human head tissues.
- The network emulator controls the mobile phone under test.
- The validation dipoles are used to measure a reference SAR. They are used to periodically check the bench to make sure that there is no drift of the system characteristics over time.
- The phantom, the device holder and other accessories according to the targeted measurement.

The results shown in this test report refer only to the sample(s) tested unless otherwise stated and the sample(s) are retained for 30 days only. The document is issued by AGC, this document cannot be reproduced except in full with our prior written permission. The more details and the authenticity of the report will be confirmed at <http://www.agc-cert.com>.

3.2. COMOSAR E-Field Probe

The SAR measurement is conducted with the dosimetric probe manufactured by SATIMO. The probe is specially designed and calibrated for use in liquid with high permittivity. The dosimetric probe has special calibration in liquid at different frequency. SATIMO conducts the probe calibration in compliance with international and national standards (e.g. IEEE 1528 and relevant KDB files.) The calibration data are in Appendix D.

Isotropic E-Field Probe Specification

Model	SSE2	
Manufacture	MVG	
Identification No.	SN 08/16 EPGO282	
Frequency	0.7GHz-6GHz Linearity:±0.06dB(700MHz-6GHz)	
Dynamic Range	0.01W/Kg-100W/Kg Linearity:±0.06dB	
Dimensions	Overall length:330mm Length of individual dipoles:2mm Maximum external diameter:8mm Probe Tip external diameter:2.5mm Distance between dipoles/ probe extremity:1mm	
Application	High precision dosimetric measurements in any exposure scenario (e.g., very strong gradient fields). Only probe which enables compliance testing for frequencies up to 6 GHz with precision of better 30%.	

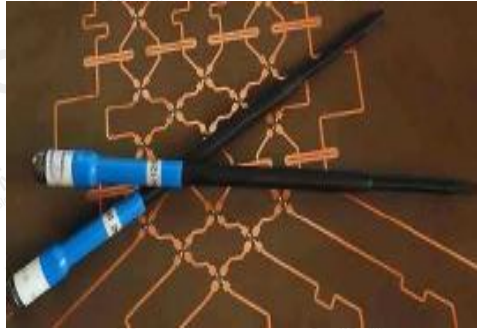
Model	SSE5	
Manufacturer	MVG	
Identification No.	SN 22/12 EP159	
Frequency	0.4GHz-3GHz Linearity:±0.09dB(300MHz-3GHz)	
Dynamic Range	0.01W/Kg-100W/Kg Linearity:±0.11dB	
Dimensions	Overall length:330mm Length of individual dipoles:4.5mm Maximum external diameter:8mm Probe Tip external diameter:5mm Distance between dipoles/ probe extremity:2.7mm	
Application	High precision dosimetric measurements in any exposure scenario (e.g., very strong gradient fields). Only probe which enables compliance testing for frequencies up to 3 GHz with precision of better 30%.	

The results shown in this test report refer only to the sample(s) tested unless otherwise stated and the sample(s) are retained for 30 days only. The document is issued by AGC, this document cannot be reproduced except in full with our prior written permission. The more details and the authenticity of the report will be confirmed at <http://www.agc-cert.com>.

3.3. Robot

The COMOSAR system uses the KUKA robot from SATIMO SA (France). For the 6-axis controller COMOSAR system, the KUKA robot controller version from SATIMO is used.

The XL robot series have many features that are important for our application:

- High precision (repeatability 0.02 mm)
- High reliability (industrial design)
- Jerk-free straight movements
- Low ELF interference (the closed metallic construction shields against motor control fields)
- 6-axis controller



3.4. Video Positioning System

The video positioning system is used in OpenSAR to check the probe. Which is composed of a camera, LED, mirror and mechanical parts. The camera is piloted by the main computer with firewire link. During the process, the actual position of the probe tip with respect to the robot arm is measured, as well as the probe length and the horizontal probe offset. The software then corrects all movements, such that the robot coordinates are valid for the probe tip. The repeatability of this process is better than 0.1 mm. If a position has been taught with an aligned probe, the same position will be reached with another aligned probe within 0.1 mm, even if the other probe has different dimensions. During probe rotations, the probe tip will keep its actual position.

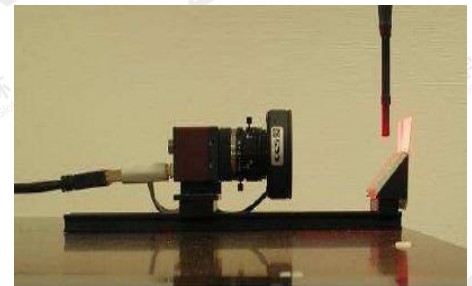

3.5. Device Holder

The COMOSAR device holder is designed to cope with different positions given in the standard. It has two scales for the device rotation (with respect to the body axis) and the device inclination (with respect to the line between the ear reference points). The rotation center for both scales is the ear reference point (EPR).

Thus the device needs no repositioning when changing the angles.

The COMOSAR device holder has been made out of low-loss POM material having the following dielectric parameters: relative permittivity

$\epsilon_r = 3$ and loss tangent $\delta = 0.02$. The amount of dielectric material has been reduced in the closest vicinity of the device, since measurements have suggested that the influence of the clamp on the test results could thus be lowered.

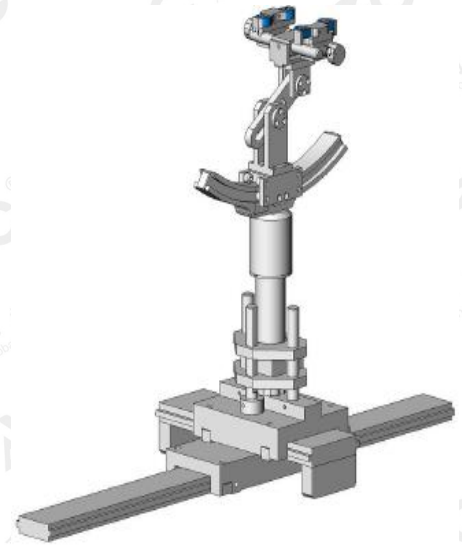

3.6. SAM Twin Phantom

The SAM twin phantom is a fiberglass shell phantom with 2mm shell thickness (except the ear region where shell thickness increases to 6mm). It has three measurement areas:

- Left head
- Right head
- Flat phantom



The bottom plate contains three pair of bolts for locking the device holder. The device holder positions are adjusted to the standard measurement positions in the three sections. A white cover is provided to tap the phantom during off-periods to prevent water evaporation and changes in the liquid parameters. On the phantom top, three reference markers are provided to identify the phantom position with respect to the robot.

4. SAR MEASUREMENT PROCEDURE

4.1. Specific Absorption Rate (SAR)

SAR is related to the rate at which energy is absorbed per unit mass in object exposed to a radio field. The SAR distribution in a biological body is complicated and is usually carried out by experimental techniques or numerical modeling. The standard recommends limits for two tiers of groups, occupational/controlled and occupational/uncontrolled, based on a person's awareness and ability to exercise control over his or her exposure. In general, occupational/controlled exposure limits are higher than the limits for general population/uncontrolled.

The SAR definition is the time derivative (rate) of the incremental energy (dW) absorbed by (dissipated in) an incremental mass (dm) contained in a volume element(dv) of given mass density (ρ). The equation description is as below:

$$SAR = \frac{d}{dt} \left(\frac{dW}{dm} \right) = \frac{d}{dt} \left(\frac{dW}{\rho dV} \right)$$

SAR is expressed in units of Watts per kilogram (W/Kg)

SAR can be obtained using either of the following equations:

$$SAR = \frac{\sigma E^2}{\rho}$$

$$SAR = c_h \left. \frac{dT}{dt} \right|_{t=0}$$

Where

SAR	is the specific absorption rate in watts per kilogram;
E	is the r.m.s. value of the electric field strength in the tissue in volts per meter;
σ	is the conductivity of the tissue in siemens per metre;
ρ	is the density of the tissue in kilograms per cubic metre;
c _h	is the heat capacity of the tissue in joules per kilogram and Kelvin;
$\left. \frac{dT}{dt} \right _{t=0}$	is the initial time derivative of temperature in the tissue in kelvins per second

The results shown in this test report refer only to the sample(s) tested unless otherwise stated and the sample(s) are retained for 30 days only. The document is issued by AGC, this document cannot be reproduced except in full with our prior written permission. The more details and the authenticity of the report will be confirmed at <http://www.agc-cert.com>.

4.2. SAR Measurement Procedure

Step 1: Power Reference Measurement

The Power Reference Measurement and Power Drift Measurement are for monitoring the power drift of the device under test in the batch process. The minimum distance of probe sensors to surface is 2.7mm This distance cannot be smaller than the distance os sensor calibration points to probe tip as `defined in the probe properties,

Step 2: Area Scan

The Area Scan is used as a fast scan in two dimensions to find the area of high field values, before doing a fine measurement around the hot spot. The sophisticated interpolation routines implemented in SATIMO software can find the maximum locations even in relatively coarse grids. When an Area Scan has measured all reachable points, it computes the field maximal found in the scanned area, within a range of the global maximum. The range (in db) is specified in the standards for compliance testing. For example, a 2db range is required in IEEE Standard 1528, whereby 3db is a requirement when compliance is assessed in accordance with the ARIB standard (Japan) If one Zoom Scan follows the Area Scan, then only the absolute maximum will be taken as reference. For cases where multiple maximum are detected, the number of Zoom Scan has to be increased accordingly.

Area Scan Parameters extracted from KDB 865664 D01 SAR Measurement 100MHz to 6GHz

	≤ 3 GHz	> 3 GHz
Maximum distance from closest measurement point (geometric center of probe sensors) to phantom surface	5 ± 1 mm	$\frac{1}{2} \cdot \delta \cdot \ln(2) \pm 0.5$ mm
Maximum probe angle from probe axis to phantom surface normal at the measurement location	30° ± 1°	20° ± 1°
Maximum area scan spatial resolution: Δx_{Area} , Δy_{Area}	≤ 2 GHz: ≤ 15 mm 2 – 3 GHz: ≤ 12 mm	3 – 4 GHz: ≤ 12 mm 4 – 6 GHz: ≤ 10 mm
	When the x or y dimension of the test device, in the measurement plane orientation, is smaller than the above, the measurement resolution must be ≤ the corresponding x or y dimension of the test device with at least one measurement point on the test device.	

Step 3: Zoom Scan

Zoom Scan are used to assess the peak spatial SAR value within a cubic average volume containing 1g abd 10g of simulated tissue. The Zoom Scan measures points(refer to table below) within a cube whose base faces are centered on the maxima found in a preceding area scan job within the same procedure. When the measurement is done, the Zoom Scan evaluates the averaged SAR for 1g and 10g and displays these values next to the job's label.

The results shown in this test report refer only to the sample(s) tested unless otherwise stated and the sample(s) are retained for 30 days only. The document is issued by AGC, this document cannot be reproduced except in full with our prior written permission. The more details and the authenticity of the report will be confirmed at <http://www.agc-cert.com>.

Zoom Scan Parameters extracted from KDB865664 d01 SAR Measurement 100MHz to 6GHz

Maximum zoom scan spatial resolution: Δx_{Zoom} , Δy_{Zoom}		≤ 2 GHz: ≤ 8 mm 2 – 3 GHz: ≤ 5 mm*	3 – 4 GHz: ≤ 5 mm* 4 – 6 GHz: ≤ 4 mm*
Maximum zoom scan spatial resolution, normal to phantom surface	uniform grid: $\Delta z_{Zoom}(n)$	≤ 5 mm	3 – 4 GHz: ≤ 4 mm 4 – 5 GHz: ≤ 3 mm 5 – 6 GHz: ≤ 2 mm
	graded grid	$\Delta z_{Zoom}(1)$: between 1 st two points closest to phantom surface	≤ 4 mm
		$\Delta z_{Zoom}(n>1)$: between subsequent points	$\leq 1.5 \cdot \Delta z_{Zoom}(n-1)$
Minimum zoom scan volume	x, y, z	≥ 30 mm	3 – 4 GHz: ≥ 28 mm 4 – 5 GHz: ≥ 25 mm 5 – 6 GHz: ≥ 22 mm
<p>Note: δ is the penetration depth of a plane-wave at normal incidence to the tissue medium; see draft standard IEEE P1528-2011 for details.</p> <p>* When zoom scan is required and the <i>reported</i> SAR from the <i>area scan based 1-g SAR estimation</i> procedures of KDB 447498 is ≤ 1.4 W/kg, ≤ 8 mm, ≤ 7 mm and ≤ 5 mm zoom scan resolution may be applied, respectively, for 2 GHz to 3 GHz, 3 GHz to 4 GHz and 4 GHz to 6 GHz.</p>			

Step 4: Power Drift Measurement

The Power Drift Measurement measures the field at the same location as the most recent power reference measurement within the same procedure, and with the same settings. The Power Drift Measurement gives the field difference in dB from the reading conducted within the same settings. This allows a user to monitor the power drift of the device under test within a batch process. The measurement procedure is the same as Step 1.

The results shown in this test report refer only to the sample(s) tested unless otherwise stated and the sample(s) are retained for 30 days only. The document is issued by AGC, this document cannot be reproduced except in full with our prior written permission. The more details and the authenticity of the report will be confirmed at <http://www.agc-cert.com>.

4.3. RF Exposure Conditions

Test Configuration and setting:

The EUT is a model of GSM Portable Mobile Station (MS). It supports BT, WIFI.

For WLAN testing, the EUT is configured with the WLAN continuous TX tool through engineering command.

Antenna Location: (the back view)

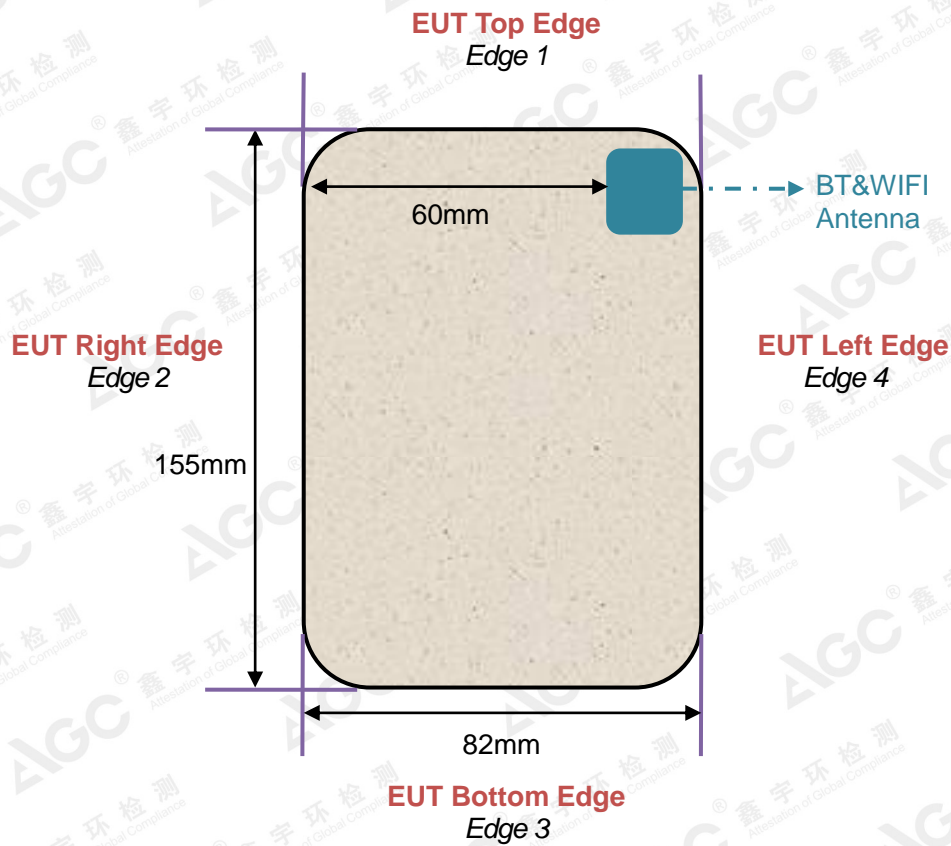

The results shown in this test report refer only to the sample(s) tested otherwise stated and the sample(s) are retained for 30 days only. The document is issued by AGC, this document cannot be reproduced except in full with our prior written permission. The more details and the authenticity of the report will be confirmed at <http://www.agc-cert.com>.

For WLAN mode:

Test Configurations	Antenna to edges/surface	SAR required	Note
Head			
Left Touch		Yes	--
Left Tilt		Yes	--
Right Touch		Yes	--
Right Tilt		Yes	--
Body			
Back	<25mm	Yes	--
Front	<25mm	Yes	--
Hotspot			
Back	<25mm	Yes	--
Front	<25mm	Yes	--
Edge 1 (Top)	6mm	Yes	--
Edge 2 (Right)	60mm	No	--
Edge 3 (Bottom)	133mm	No	--
Edge 4 (Left)	8mm	Yes	--

The results shown in this test report refer only to the sample(s) tested unless otherwise stated and the sample(s) are retained for 30 days only. The document is issued by AGC, this document cannot be reproduced except in full with our prior written permission. The more details and the authenticity of the report will be confirmed at <http://www.agc-cert.com>.

5. TISSUE SIMULATING LIQUID

For SAR measurement of the field distribution inside the phantom, the phantom must be filled with homogeneous tissue simulating liquid to a depth of at least 15cm. For head SAR testing the liquid height from the ear reference point (ERP) of the phantom to the liquid top surface is larger than 15cm For body SAR testing, the liquid height from the center of the flat phantom to the liquid top surface is larger than 15cm. The nominal dielectric values of the tissue simulating liquids in the phantom and the tolerance of 5% are listed in 5.2

5.1. The composition of the tissue simulating liquid

Ingredient (% Weight) Frequency (MHz)	Water	Nacl	Polysorbate 20	DGBE	1,2 Propanediol	Triton X-100
2450 Head	71.88	0.16	0.0	7.99	0.0	19.97
2450 Body	70	1	0.0	9	0.0	20

5.2. Tissue Dielectric Parameters for Head and Body Phantoms

The head tissue dielectric parameters recommended by the IEEE 1528 have been incorporated in the following table. These head parameters are derived from planar layer models simulating the highest expected SAR for the dielectric properties and tissue thickness variations in a human head. Other head and body tissue parameters that have not been specified in IEEE 1528 are derived from the tissue dielectric parameters computed from the 4-Cole-Cole equations described in Reference [12] and extrapolated according to the head parameters specified in IEEE 1528.

Target Frequency (MHz)	head		body	
	ϵ_r	σ (S/m)	ϵ_r	σ (S/m)
300	45.3	0.87	58.2	0.92
450	43.5	0.87	56.7	0.94
835	41.5	0.90	55.2	0.97
900	41.5	0.97	55.0	1.05
915	41.5	1.01	55.0	1.06
1450	40.5	1.20	54.0	1.30
1610	40.3	1.29	53.8	1.40
1800 – 2000	40.0	1.40	53.3	1.52
2450	39.2	1.80	52.7	1.95
3000	38.5	2.40	52.0	2.73

(ϵ_r = relative permittivity, σ = conductivity and $\rho = 1000$ kg/m³)

The results shown in this test report refer only to the sample(s) tested unless otherwise stated and the sample(s) are retained for 30 days only. The document is issued by AGC, this document cannot be reproduced except in full with our prior written permission. The more details and the authenticity of the report will be confirmed at <http://www.agc-cert.com>.

5.3. Tissue Calibration Result

The dielectric parameters of the liquids were verified prior to the SAR evaluation using SATIMO Dielectric Probe Kit and R&S Network Analyzer ZVL6.

Tissue Stimulant Measurement for 2450MHz					
	Fr. (MHz)	Dielectric Parameters ($\pm 5\%$)		Tissue Temp [°C]	Test time
		ϵ_r	δ [s/m]		
Head		$\epsilon_r 39.2(37.24-41.16)$	$\delta [s/m] 1.80(1.71-1.89)$	21.3	Aug. 03,2018
	2412	40.01	1.75		
	2437	39.43	1.78		
	2450	38.81	1.82		
	2462	38.19	1.84		
Body		$\epsilon_r 52.7(50.065-55.335)$	$\delta [s/m] 1.95(1.8525-2.0475)$	21.5	Aug. 03,2018
	2412	54.06	1.88		
	2437	53.47	1.90		
	2450	52.94	1.92		
	2462	52.25	1.95		
Body		$\epsilon_r 52.7(50.065-55.335)$	$\delta [s/m] 1.95(1.8525-2.0475)$	21.5	Aug. 30,2018
	2412	54.03	1.88		
	2437	53.71	1.90		
	2450	53.25	1.92		
	2462	52.84	1.93		

The results shown in this test report refer only to the sample(s) tested unless otherwise stated and the sample(s) are retained for 30 days only. The document is issued by AGC, this document cannot be reproduced except in full with our prior written permission. The more details and the authenticity of the report will be confirmed at <http://www.agc-cert.com>.

6. SAR SYSTEM CHECK PROCEDURE

6.1. SAR System Check Procedures

SAR system check is required to confirm measurement accuracy, according to the tissue dielectric media, probe calibration points and other system operating parameters required for measuring the SAR of a test device. The system verification must be performed for each frequency band and within the valid range of each probe calibration point required for testing the device. The same SAR probe(s) and tissue-equivalent media combinations used with each specific SAR system for system verification must be used for device testing. When multiple probe calibration points are required to cover substantially large transmission bands, independent system verifications are required for each probe calibration point. A system verification must be performed before each series of SAR measurements using the same probe calibration point and tissue-equivalent medium. Additional system verification should be considered according to the conditions of the tissue-equivalent medium and measured tissue dielectric parameters, typically every three to four days when the liquid parameters are remeasured or sooner when marginal liquid parameters are used at the beginning of a series of measurements.

Each SATIMO system is equipped with one or more system check kits. These units, together with the predefined measurement procedures within the SATIMO software, enable the user to conduct the system check and system validation. System kit includes a dipole, and dipole device holder.

The system check verifies that the system operates within its specifications. It's performed daily or before every SAR measurement. The system check uses normal SAR measurement in the flat section of the phantom with a matched dipole at a specified distance. The system check setup is shown as below.

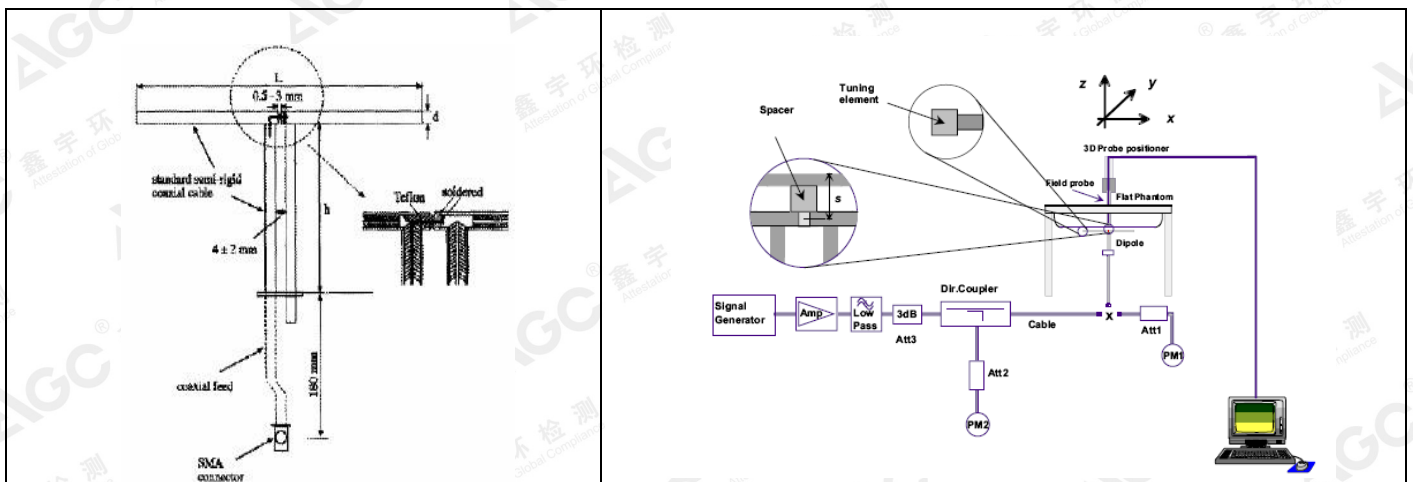

The results shown in this test report refer only to the sample(s) tested unless otherwise stated and the sample(s) are retained for 30 days only. The document is issued by AGC, this document cannot be reproduced except in full with our prior written permission. The more details and the authenticity of the report will be confirmed at <http://www.agc-cert.com>.

6.2. SAR System Check
6.2.1. Dipoles

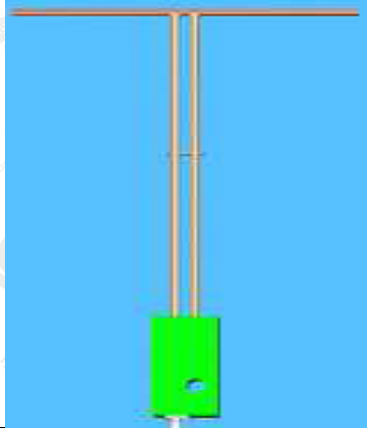
	<p>The dipoles used is based on the IEEE-1528 standard, and is complied with mechanical and electrical specifications in line with the requirements of IEEE. the table below provides details for the mechanical and electrical Specifications for the dipoles.</p>
---	---

Frequency	L (mm)	h (mm)	d (mm)
2450MHz	51.5	30.4	3.6

6.2.2. System Check Result

System Performance Check at 2450MHz for Head								
Validation Kit: SN 29/15DIP 2G450-393								
Frequency [MHz]	Target Value(W/Kg)		Reference Result (± 10%)		Tested Value(W/Kg)		Tissue Temp. [°C]	Test time
	1g	10g	1g	10g	1g	10g		
2450	54.53	24.30	49.077-59.983	21.87-26.730	51.62	23.22	21.3	Aug. 03,2018
System Performance Check at 2450MHz for Body								
Frequency [MHz]	Target Value(W/Kg)		Reference Result (± 10%)		Tested Value(W/Kg)		Tissue Temp. [°C]	Test time
	1g	10g	1g	10g	1g	10g		
2450	49.92	23.16	44.928-54.912	20.844-25.476	47.92	21.07	21.5	Aug. 03,2018
2450	49.92	23.16	44.928-54.912	20.844-25.476	53.50	23.00	21.5	Aug. 30,2018

Note:

(1) We use a CW signal of 18dBm for system check, and then all SAR value are normalized to 1W forward power. The result must be within ±10% of target value.

The results shown in this test report refer only to the sample(s) tested unless otherwise stated and the sample(s) are retained for 30 days only. The document is issued by AGC, this document cannot be reproduced except in full with our prior written permission. The more details and the authenticity of the report will be confirmed at <http://www.agc-cert.com>.

7. EUT TEST POSITION

This EUT was tested in **Right Cheek, Right Tilted, Left Cheek, Left Tilted, Body back, Body front and 4 edges.**

7.1. Define Two Imaginary Lines on the Handset

- (1) The vertical centerline passes through two points on the front side of the handset the midpoint of the width w_t of the handset at the level of the acoustic output, and the midpoint of the width w_b of the handset.
- (2) The horizontal line is perpendicular to the vertical centerline and passes through the center of the acoustic output. The horizontal line is also tangential to the face of the handset at point A.
- (3) The two lines intersect at point A. Note that for many handsets, point A coincides with the center of the acoustic output; however, the acoustic output may be located elsewhere on the horizontal line. Also note that the vertical centerline is not necessarily to the front face of the handset, especially for clamshell handsets, handsets with flip covers, and other irregularly shaped handsets.

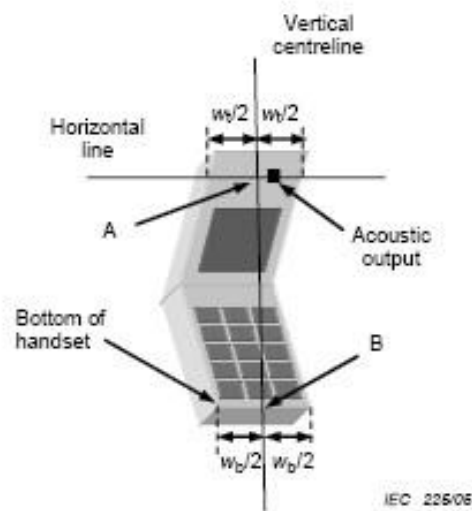
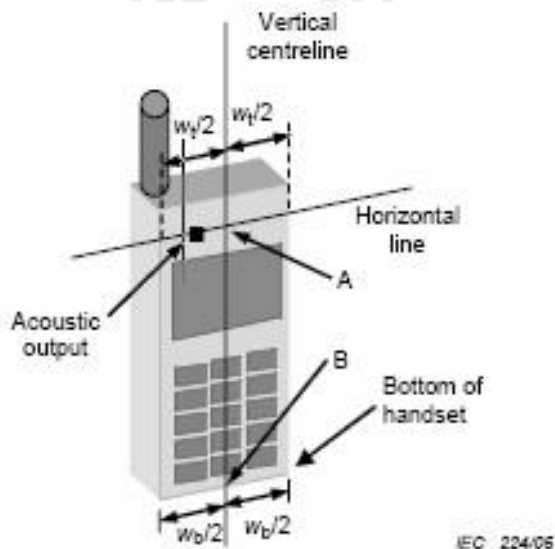

The results shown in this test report refer only to the sample(s) tested unless otherwise stated and the sample(s) are retained for 30 days only. The document is issued by AGC, this document cannot be reproduced except in full with our prior written permission. The more details and the authenticity of the report will be confirmed at <http://www.agc-cert.com>.

7.2. Cheek Position

- (1) To position the device with the vertical center line of the body of the device and the horizontal line crossing the center piece in a plane parallel to the sagittal plane of the phantom. While maintaining the device in this plane, align the vertical center line with the reference plane containing the ear and mouth reference point (M: Mouth, RE: Right Ear, and LE: Left Ear) and align the center of the ear piece with the line RE-LE.
- (2) To move the device towards the phantom with the ear piece aligned with the the line LE-RE until the phone touched the ear. While maintaining the device in the reference plane and maintaining the phone contact with ear, move the bottom of the phone until any point on the front side is in contact with the cheek of the phantom or until contact with the ear is lost



7.3. Tilt Position

- (1) To position the device in the “cheek” position described above.
- (2) While maintaining the device in the reference plane described above and pivoting against the ear, moves it outward away from the mouth by an angle of 15 degrees or until with the ear is lost.



The results shown in this test report refer only to the sample(s) tested unless otherwise stated and the sample(s) are retained for 30 days only. The document is issued by AGC, this document cannot be reproduced except in full with our prior written permission. The more details and the authenticity of the report will be confirmed at <http://www.agc-cert.com>.

7.4. Body Worn Position

- (1) To position the EUT parallel to the phantom surface.
- (2) To adjust the EUT parallel to the flat phantom.
- (3) To adjust the distance between the EUT surface and the flat phantom to **10mm**.

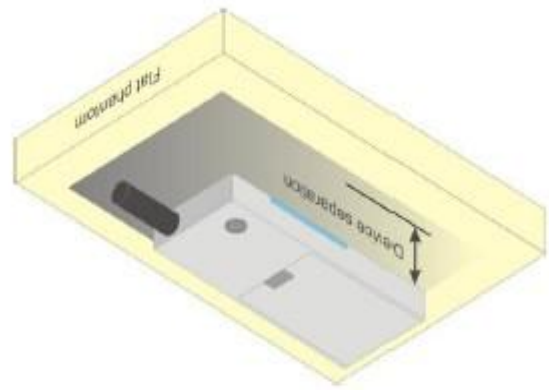
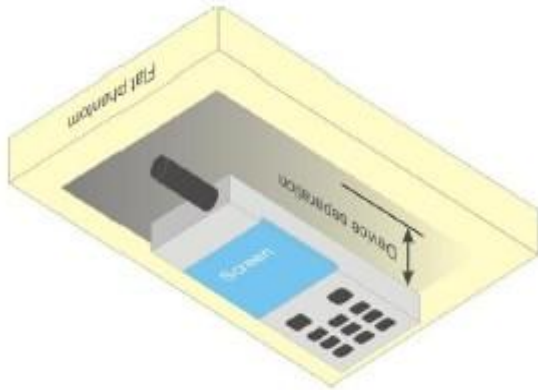

The results shown in this test report refer only to the sample(s) tested unless otherwise stated and the sample(s) are retained for 30 days only. The document is issued by AGC, this document cannot be reproduced except in full with our prior written permission. The more details and the authenticity of the report will be confirmed at <http://www.agc-cert.com>.

8. SAR EXPOSURE LIMITS

Limits for General Population/Uncontrolled Exposure (W/kg)

Type Exposure	Uncontrolled Environment Limit (W/kg)
Spatial Peak SAR (1g cube tissue for brain or body)	1.60
Spatial Average SAR (Whole body)	0.08
Spatial Peak SAR (Limbs)	4.0

The results shown in this test report refer only to the sample(s) tested unless otherwise stated and the sample(s) are retained for 30 days only. The document is issued by AGC, this document cannot be reproduced except in full with our prior written permission. The more details and the authenticity of the report will be confirmed at <http://www.agc-cert.com>.

9. TEST FACILITY

Test Site	Attestation of Global Compliance (Shenzhen) Co., Ltd
Location	1-2F., Bldg.2, No.1-4, Chaxi Sanwei Technical Industrial Park, Gushu, Xixiang, Bao'an District B112-B113, Shenzhen 518012
NVLAP Lab Code	600153-0
Designation Number	CN5028
Test Firm Registration Number	682566
Description	Attestation of Global Compliance(Shenzhen) Co., Ltd is accredited by National Voluntary Laboratory Accreditation program, NVLAP Code 600153-0

The results shown in this test report refer only to the sample(s) tested unless otherwise stated and the sample(s) are retained for 30 days only. The document is issued by AGC, this document cannot be reproduced except in full with our prior written permission. The more details and the authenticity of the report will be confirmed at <http://www.agc-cert.com>.

10. TEST EQUIPMENT LIST

Equipment description	Manufacturer/ Model	Identification No.	Current calibration date	Next calibration date
SAR Probe	MVG	SN 08/16 EPGO282	Aug. 08,2017	Aug. 08,2018
SAR Probe	MVG	SN 22/12 EP159	Aug. 08,2018	Aug. 07,2019
Phantom	SATIMO	SN_4511_SAM90	Validated. No cal required.	Validated. No cal required.
Liquid	SATIMO	-	Validated. No cal required.	Validated. No cal required.
Multimeter	Keithley 2000	1188656	Mar. 01,2018	Feb. 28,2019
Dipole	SATIMO SID2450	SN29/15 DIP 2G450-393	07/05/2016	07/04/2019
Signal Generator	Agilent-E4438C	US41461365	Mar. 01,2018	Feb. 28,2019
Vector Analyzer	Agilent / E4440A	US41421290	Mar. 01,2018	Feb. 28,2019
Network Analyzer	Rhode & Schwarz ZVL6	SN100132	Mar. 01,2018	Feb. 28,2019
Attenuator	Warison /WATT-6SR1211	N/A	N/A	N/A
Attenuator	Mini-circuits / VAT-10+	N/A	N/A	N/A
Amplifier	EM30180	SN060552	Mar. 01,2018	Feb. 28,2019
Directional Couple	Werlatone/ C5571-10	SN99463	June. 12,2018	June. 11,2019
Directional Couple	Werlatone/ C6026-10	SN99482	June. 12,2018	June. 11,2019
Power Sensor	NRP-Z21	1137.6000.02	Oct. 12,2017	Oct. 11,2018
Power Sensor	NRP-Z23	US38261498	Mar. 01,2018	Feb. 28,2019
Power Viewer	R&S	V2.3.1.0	N/A	N/A

Note: Per KDB 865664 Dipole SAR Validation, AGC Lab has adopted 3 years calibration intervals. On annual basis, every measurement dipole has been evaluated and is in compliance with the following criteria:

1. There is no physical damage on the dipole;
2. System validation with specific dipole is within 10% of calibrated value;
3. Return-loss is within 20% of calibrated measurement;
4. Impedance is within 5Ω of calibrated measurement.

The results shown in this test report refer only to the sample(s) tested unless otherwise stated and the sample(s) are retained for 30 days only. The document is issued by AGC, this document cannot be reproduced except in full with our prior written permission. The more details and the authenticity of the report will be confirmed at <http://www.agc-cert.com>.

11. MEASUREMENT UNCERTAINTY

Measurement uncertainty for Dipole averaged over 1 gram / 10 gram. -SN 08/16 EPGO282									
a	b	c	d	e f(d,k)	f	g	h cx/f/e	i cxg/e	k
Uncertainty Component	Sec.	Tol (± %)	Prob. Dist.	Div.	Ci (1g)	Ci (10g)	1g Ui (±%)	10g Ui (±%)	vi
Measurement System									
Probe calibration	E.2.1	5.831	N	1	1	1	5.83	5.83	∞
Axial Isotropy	E.2.2	0.695	R	$\sqrt{3}$	$\sqrt{0.5}$	$\sqrt{0.5}$	0.28	0.28	∞
Hemispherical Isotropy	E.2.2	1.045	R	$\sqrt{3}$	$\sqrt{0.5}$	$\sqrt{0.5}$	0.43	0.43	∞
Boundary effect	E.2.3	1.0	R	$\sqrt{3}$	1	1	0.58	0.58	∞
Linearity	E.2.4	0.685	R	$\sqrt{3}$	1	1	0.40	0.40	∞
System detection limits	E.2.4	1.0	R	$\sqrt{3}$	1	1	0.58	0.58	∞
Modulation response	E.2.5	3.0	R	$\sqrt{3}$	1	1	1.73	1.73	∞
Readout Electronics	E.2.6	0.021	N	1	1	1	0.021	0.021	∞
Response Time	E.2.7	0	R	$\sqrt{3}$	1	1	0	0	∞
Integration Time	E.2.8	1.4	R	$\sqrt{3}$	1	1	0.81	0.81	∞
RF ambient conditions-Noise	E.6.1	3.0	R	$\sqrt{3}$	1	1	1.73	1.73	∞
RF ambient conditions-reflections	E.6.1	3.0	R	$\sqrt{3}$	1	1	1.73	1.73	∞
Probe positioner mechanical tolerance	E.6.2	1.4	R	$\sqrt{3}$	1	1	0.81	0.81	∞
Probe positioning with respect to phantom shell	E.6.3	1.4	R	$\sqrt{3}$	1	1	0.81	0.81	∞
Extrapolation, interpolation, and integrations algorithms for max. SAR evaluation	E.5	2.3	R	$\sqrt{3}$	1	1	1.33	1.33	∞
Test sample Related									
Test sample positioning	E.4.2	2.6	N	1	1	1	2.6	2.6	∞
Device holder uncertainty	E.4.1	3	N	1	1	1	3	3	∞
Output power variation—SAR drift measurement	E.2.9	5	R	$\sqrt{3}$	1	1	2.89	2.89	∞
SAR scaling	E.6.5	5	R	$\sqrt{3}$	1	1	2.89	2.89	∞
Phantom and tissue parameters									
Phantom shell uncertainty—shape, thickness, and permittivity	E.3.1	4	R	$\sqrt{3}$	1	1	2.31	2.31	∞
Uncertainty in SAR correction for deviations in permittivity and conductivity	E.3.2	1.9	N	1	1	0.84	1.90	1.60	∞
Liquid conductivity measurement	E.3.3	4	N	1	0.78	0.71	3.12	2.84	M
Liquid permittivity measurement	E.3.3	5	N	1	0.23	0.26	1.15	1.30	M
Liquid conductivity—temperature uncertainty	E.3.4	2.5	R	$\sqrt{3}$	0.78	0.71	1.13	1.02	∞
Liquid permittivity—temperature uncertainty	E.3.4	2.5	R	$\sqrt{3}$	0.23	0.26	0.33	0.38	∞
Combined Standard Uncertainty			RSS				9.79	9.59	
Expanded Uncertainty (95% Confidence interval)			K=2				19.58	19.18	

The results shown in this test report refer only to the sample(s) tested unless otherwise stated and the sample(s) are retained for 30 days only. The document is issued by AGC, this document cannot be reproduced except in full with our prior written permission. The more details and the authenticity of the report will be confirmed at <http://www.agc-cert.com>.

System check uncertainty for Dipole averaged over 1 gram / 10 gram. -SN 08/16 EPGO282									
a	b	c	d	e f(d,k)	f	g	h cx _f /e	i cx _g /e	k
Uncertainty Component	Sec.	Tol (±%)	Prob. Dist.	Div.	Ci (1g)	Ci (10g)	1g U _i (±%)	10g U _i (±%)	v _i
Measurement System									
Probe calibration drift	E.2.1.3	0.5	N	1	1	1	0.50	0.50	∞
Axial Isotropy	E.2.2	0.695	R	√3	0	0	0.00	0.00	∞
Hemispherical Isotropy	E.2.2	1.045	R	√3	0	0	0.00	0.00	∞
Boundary effect	E.2.3	1.0	R	√3	0	0	0.00	0.00	∞
Linearity	E.2.4	0.685	R	√3	0	0	0.00	0.00	∞
System detection limits	E.2.4	1.0	R	√3	0	0	0.00	0.00	∞
Modulation response	E.2.5	3.0	R	√3	0	0	0.00	0.00	∞
Readout Electronics	E.2.6	0.021	N	1	0	0	0.00	0.00	∞
Response Time	E.2.7	0	R	√3	0	0	0.00	0.00	∞
Integration Time	E.2.8	1.4	R	√3	0	0	0.00	0.00	∞
RF ambient conditions-Noise	E.6.1	3.0	R	√3	0	0	0.00	0.00	∞
RF ambient conditions-reflections	E.6.1	3.0	R	√3	0	0	0.00	0.00	∞
Probe positioner mechanical tolerance	E.6.2	1.4	R	√3	1	1	0.81	0.81	∞
Probe positioning with respect to phantom shell	E.6.3	1.4	R	√3	1	1	0.81	0.81	∞
Extrapolation, interpolation, and integrations algorithms for max. SAR evaluation	E.5	2.3	R	√3	0	0	0.00	0.00	∞
System check source (dipole)									
Deviation of experimental dipoles	E.6.4	2	N	1	1	1	2	2	∞
Input power and SAR drift measurement	8,6.6.4	5	R	√3	1	1	2.89	2.89	∞
Dipole axis to liquid distance	8,E.6.6	2	R	√3	1	1	1.15	1.15	∞
Phantom and tissue parameters									
Phantom shell uncertainty—shape, thickness, and permittivity	E.3.1	4	R	√3	1	1	2.31	2.31	∞
Uncertainty in SAR correction for deviations in permittivity and conductivity	E.3.2	1.9	N	1	1	0.84	1.90	1.60	∞
Liquid conductivity measurement	E.3.3	4	N	1	0.78	0.71	3.12	2.84	M
Liquid permittivity measurement	E.3.3	5	N	1	0.23	0.26	1.15	1.30	M
Liquid conductivity—temperature uncertainty	E.3.4	2.5	R	√3	0.78	0.71	1.13	1.02	∞
Liquid permittivity—temperature uncertainty	E.3.4	2.5	R	√3	0.23	0.26	0.33	0.38	∞
Combined Standard Uncertainty			RSS				5.564	5.205	
Expanded Uncertainty (95% Confidence interval)			K=2				11.128	10.410	

The results shown in this test report refer only to the sample(s) tested unless otherwise stated and the sample(s) are retained for 30 days only. The document is issued by AGC, this document cannot be reproduced except in full with our prior written permission. The more details and the authenticity of the report will be confirmed at <http://www.agc-cert.com>.

System Validation uncertainty for Dipole averaged over 1 gram / 10 gram. -SN 08/16 EPGO282									
a	b	c	d	e f(d,k)	f	g	h cx _f /e	i cx _g /e	k
Uncertainty Component	Sec.	Tol (±%)	Prob. Dist.	Div.	Ci (1g)	Ci (10g)	1g U _i (±%)	10g U _i (±%)	v _i
Measurement System									
Probe calibration	E.2.1	5.831	N	1	1	1	5.83	5.83	∞
Axial Isotropy	E.2.2	0.695	R	√3	1	1	0.40	0.40	∞
Hemispherical Isotropy	E.2.2	1.045	R	√3	0	0	0.00	0.00	∞
Boundary effect	E.2.3	1.0	R	√3	1	1	0.58	0.58	∞
Linearity	E.2.4	0.685	R	√3	1	1	0.40	0.40	∞
System detection limits	E.2.4	1.0	R	√3	1	1	0.58	0.58	∞
Modulation response	E.2.5	3.0	R	√3	0	0	0.00	0.00	∞
Readout Electronics	E.2.6	0.021	N	1	1	1	0.021	0.021	∞
Response Time	E.2.7	0.0	R	√3	0	0	0.00	0.00	∞
Integration Time	E.2.8	1.4	R	√3	0	0	0.00	0.00	∞
RF ambient conditions-Noise	E.6.1	3.0	R	√3	1	1	1.73	1.73	∞
RF ambient conditions-reflections	E.6.1	3.0	R	√3	1	1	1.73	1.73	∞
Probe positioner mechanical tolerance	E.6.2	1.4	R	√3	1	1	0.81	0.81	∞
Probe positioning with respect to phantom shell	E.6.3	1.4	R	√3	1	1	0.81	0.81	∞
Extrapolation, interpolation, and integrations algorithms for max. SAR evaluation	E.5	2.3	R	√3	1	1	1.33	1.33	∞
System check source (dipole)									
Deviation of experimental dipole from numerical dipole	E.6.4	5.0	N	1	1	1	5.00	5.00	∞
Input power and SAR drift measurement	8,6.6.4	5.0	R	√3	1	1	2.89	2.89	∞
Dipole axis to liquid distance	8,E.6.6	2.0	R	√3	1	1	1.15	1.15	∞
Phantom and tissue parameters									
Phantom shell uncertainty—shape, thickness, and permittivity	E.3.1	4.0	R	√3	1	1	2.31	2.31	∞
Uncertainty in SAR correction for deviations in permittivity and conductivity	E.3.2	1.9	N	1	1	0.84	1.90	1.60	∞
Liquid conductivity measurement	E.3.3	4.0	N	1	0.78	0.71	3.12	2.84	M
Liquid permittivity measurement	E.3.3	5.0	N	1	0.23	0.26	1.15	1.30	M
Liquid conductivity—temperature uncertainty	E.3.4	2.5	R	√3	0.78	0.71	1.13	1.02	∞
Liquid permittivity—temperature uncertainty	E.3.4	2.5	R	√3	0.23	0.26	0.33	0.38	∞
Combined Standard Uncertainty				RSS			9.718	9.517	
Expanded Uncertainty (95% Confidence interval)				K=2			19.437	19.035	

The results shown in this test report refer only to the sample(s) tested unless otherwise stated and the sample(s) are retained for 30 days only. The document is issued by AGC, this document cannot be reproduced except in full with our prior written permission. The more details and the authenticity of the report will be confirmed at <http://www.agc-cert.com>.

Measurement uncertainty for Dipole averaged over 1 gram / 10 gram. -SN 22/12 EP159									
a	b	c	d	e f(d,k)	f	g	h cx/f/e	i cx/g/e	k
Uncertainty Component	Sec.	Tol (±%)	Prob. Dist.	Div.	Ci (1g)	Ci (10g)	1g Ui (±%)	10g Ui (±%)	vi
Measurement System									
Probe calibration	E.2.1	5.831	N	1	1	1	5.83	5.83	∞
Axial Isotropy	E.2.2	0.579	R	$\sqrt{3}$	$\sqrt{0.5}$	$\sqrt{0.5}$	0.24	0.24	∞
Hemispherical Isotropy	E.2.2	0.813	R	$\sqrt{3}$	$\sqrt{0.5}$	$\sqrt{0.5}$	0.33	0.33	∞
Boundary effect	E.2.3	1.0	R	$\sqrt{3}$	1	1	0.58	0.58	∞
Linearity	E.2.4	1.26	R	$\sqrt{3}$	1	1	0.73	0.73	∞
System detection limits	E.2.4	1.0	R	$\sqrt{3}$	1	1	0.58	0.58	∞
Modulation response	E.2.5	3.0	R	$\sqrt{3}$	1	1	1.73	1.73	∞
Readout Electronics	E.2.6	0.021	N	1	1	1	0.021	0.021	∞
Response Time	E.2.7	0	R	$\sqrt{3}$	1	1	0	0	∞
Integration Time	E.2.8	1.4	R	$\sqrt{3}$	1	1	0.81	0.81	∞
RF ambient conditions-Noise	E.6.1	3.0	R	$\sqrt{3}$	1	1	1.73	1.73	∞
RF ambient conditions-reflections	E.6.1	3.0	R	$\sqrt{3}$	1	1	1.73	1.73	∞
Probe positioner mechanical tolerance	E.6.2	1.4	R	$\sqrt{3}$	1	1	0.81	0.81	∞
Probe positioning with respect to phantom shell	E.6.3	1.4	R	$\sqrt{3}$	1	1	0.81	0.81	∞
Extrapolation, interpolation, and integrations algorithms for max. SAR evaluation	E.5	2.3	R	$\sqrt{3}$	1	1	1.33	1.33	∞
Test sample Related									
Test sample positioning	E.4.2	2.6	N	1	1	1	2.6	2.6	∞
Device holder uncertainty	E.4.1	3	N	1	1	1	3	3	∞
Output power variation—SAR drift measurement	E.2.9	5	R	$\sqrt{3}$	1	1	2.89	2.89	∞
SAR scaling	E.6.5	5	R	$\sqrt{3}$	1	1	2.89	2.89	∞
Phantom and tissue parameters									
Phantom shell uncertainty—shape, thickness, and permittivity	E.3.1	4	R	$\sqrt{3}$	1	1	2.31	2.31	∞
Uncertainty in SAR correction for deviations in permittivity and conductivity	E.3.2	1.9	N	1	1	0.84	1.90	1.60	∞
Liquid conductivity measurement	E.3.3	4	N	1	0.78	0.71	3.12	2.84	M
Liquid permittivity measurement	E.3.3	5	N	1	0.23	0.26	1.15	1.30	M
Liquid conductivity—temperature uncertainty	E.3.4	2.5	R	$\sqrt{3}$	0.78	0.71	1.13	1.02	∞
Liquid permittivity—temperature uncertainty	E.3.4	2.5	R	$\sqrt{3}$	0.23	0.26	0.33	0.38	∞
Combined Standard Uncertainty			RSS				9.807	9.608	
Expanded Uncertainty (95% Confidence interval)			K=2				19.614	19.216	

The results shown in this test report refer only to the sample(s) tested unless otherwise stated and the sample(s) are retained for 30 days only. The document is issued by AGC, this document cannot be reproduced except in full with our prior written permission. The more details and the authenticity of the report will be confirmed at <http://www.agc-cert.com>.

System check uncertainty for Dipole averaged over 1 gram / 10 gram. -SN 22/12 EP159									
a	b	c	d	e f(d,k)	f	g	h cx _f /e	i cx _g /e	k
Uncertainty Component	Sec.	Tol (±%)	Prob. Dist.	Div.	Ci (1g)	Ci (10g)	1g U _i (±%)	10g U _i (±%)	v _i
Measurement System									
Probe calibration drift	E.2.1.3	0.5	N	1	1	1	0.50	0.50	∞
Axial Isotropy	E.2.2	0.579	R	√3	0	0	0.00	0.00	∞
Hemispherical Isotropy	E.2.2	0.813	R	√3	0	0	0.00	0.00	∞
Boundary effect	E.2.3	1.0	R	√3	0	0	0.00	0.00	∞
Linearity	E.2.4	1.26	R	√3	0	0	0.00	0.00	∞
System detection limits	E.2.4	1.0	R	√3	0	0	0.00	0.00	∞
Modulation response	E.2.5	3.0	R	√3	0	0	0.00	0.00	∞
Readout Electronics	E.2.6	0.021	N	1	0	0	0.00	0.00	∞
Response Time	E.2.7	0	R	√3	0	0	0.00	0.00	∞
Integration Time	E.2.8	1.4	R	√3	0	0	0.00	0.00	∞
RF ambient conditions-Noise	E.6.1	3.0	R	√3	0	0	0.00	0.00	∞
RF ambient conditions-reflections	E.6.1	3.0	R	√3	0	0	0.00	0.00	∞
Probe positioner mechanical tolerance	E.6.2	1.4	R	√3	1	1	0.81	0.81	∞
Probe positioning with respect to phantom shell	E.6.3	1.4	R	√3	1	1	0.81	0.81	∞
Extrapolation, interpolation, and integrations algorithms for max. SAR evaluation	E.5	2.3	R	√3	0	0	0.00	0.00	∞
System check source (dipole)									
Deviation of experimental dipoles	E.6.4	2	N	1	1	1	2	2	∞
Input power and SAR drift measurement	8,6.6.4	5	R	√3	1	1	2.89	2.89	∞
Dipole axis to liquid distance	8,E.6.6	2	R	√3	1	1	1.15	1.15	∞
Phantom and tissue parameters									
Phantom shell uncertainty—shape, thickness, and permittivity	E.3.1	4	R	√3	1	1	2.31	2.31	∞
Uncertainty in SAR correction for deviations in permittivity and conductivity	E.3.2	1.9	N	1	1	0.84	1.90	1.60	∞
Liquid conductivity measurement	E.3.3	4	N	1	0.78	0.71	3.12	2.84	M
Liquid permittivity measurement	E.3.3	5	N	1	0.23	0.26	1.15	1.30	M
Liquid conductivity—temperature uncertainty	E.3.4	2.5	R	√3	0.78	0.71	1.13	1.02	∞
Liquid permittivity—temperature uncertainty	E.3.4	2.5	R	√3	0.23	0.26	0.33	0.38	∞
Combined Standard Uncertainty				RSS			5.564	5.205	
Expanded Uncertainty (95% Confidence interval)				K=2			11.128	10.410	

The results shown in this test report refer only to the sample(s) tested unless otherwise stated and the sample(s) are retained for 30 days only. The document is issued by AGC, this document cannot be reproduced except in full with our prior written permission. The more details and the authenticity of the report will be confirmed at <http://www.agc-cert.com>.

System Validation uncertainty for Dipole averaged over 1 gram / 10 gram. -SN 22/12 EP159									
a	b	c	d	e f(d,k)	f	g	h cx _f /e	i cx _g /e	k
Uncertainty Component	Sec.	Tol (±%)	Prob. Dist.	Div.	C _i (1g)	C _i (10g)	1g U _i (±%)	10g U _i (±%)	v _i
Measurement System									
Probe calibration	E.2.1	5.831	N	1	1	1	5.83	5.83	∞
Axial Isotropy	E.2.2	0.579	R	√3	1	1	0.33	0.33	∞
Hemispherical Isotropy	E.2.2	0.813	R	√3	0	0	0.00	0.00	∞
Boundary effect	E.2.3	1.0	R	√3	1	1	0.58	0.58	∞
Linearity	E.2.4	1.26	R	√3	1	1	0.73	0.73	∞
System detection limits	E.2.4	1.0	R	√3	1	1	0.58	0.58	∞
Modulation response	E.2.5	3.0	R	√3	0	0	0.00	0.00	∞
Readout Electronics	E.2.6	0.021	N	1	1	1	0.021	0.021	∞
Response Time	E.2.7	0.0	R	√3	0	0	0.00	0.00	∞
Integration Time	E.2.8	1.4	R	√3	0	0	0.00	0.00	∞
RF ambient conditions-Noise	E.6.1	3.0	R	√3	1	1	1.73	1.73	∞
RF ambient conditions-reflections	E.6.1	3.0	R	√3	1	1	1.73	1.73	∞
Probe positioner mechanical tolerance	E.6.2	1.4	R	√3	1	1	0.81	0.81	∞
Probe positioning with respect to phantom shell	E.6.3	1.4	R	√3	1	1	0.81	0.81	∞
Extrapolation, interpolation, and integrations algorithms for max. SAR evaluation	E.5	2.3	R	√3	1	1	1.33	1.33	∞
System check source (dipole)									
Deviation of experimental dipole from numerical dipole	E.6.4	5.0	N	1	1	1	5.00	5.00	∞
Input power and SAR drift measurement	8,6.6.4	5.0	R	√3	1	1	2.89	2.89	∞
Dipole axis to liquid distance	8,E.6.6	2.0	R	√3	1	1	1.15	1.15	∞
Phantom and tissue parameters									
Phantom shell uncertainty—shape, thickness, and permittivity	E.3.1	4.0	R	√3	1	1	2.31	2.31	∞
Uncertainty in SAR correction for deviations in permittivity and conductivity	E.3.2	1.9	N	1	1	0.84	1.90	1.60	∞
Liquid conductivity measurement	E.3.3	4.0	N	1	0.78	0.71	3.12	2.84	M
Liquid permittivity measurement	E.3.3	5.0	N	1	0.23	0.26	1.15	1.30	M
Liquid conductivity—temperature uncertainty	E.3.4	2.5	R	√3	0.78	0.71	1.13	1.02	∞
Liquid permittivity—temperature uncertainty	E.3.4	2.5	R	√3	0.23	0.26	0.33	0.38	∞
Combined Standard Uncertainty				RSS			9.735	9.534	
Expanded Uncertainty (95% Confidence interval)				K=2			19.470	19.069	

The results shown in this test report refer only to the sample(s) tested unless otherwise stated and the sample(s) are retained for 30 days only. The document is issued by AGC, this document cannot be reproduced except in full with our prior written permission. The more details and the authenticity of the report will be confirmed at <http://www.agc-cert.com>.

12. CONDUCTED POWER MEASUREMENT

WIFI

Mode	Data Rate (Mbps)	Channel	Frequency(MHz)	Avg. Burst Power(dBm)
802.11b	1	01	2412	10.60
		06	2437	14.65
		11	2462	14.14
802.11g	6	01	2412	6.26
		06	2437	12.59
		11	2462	11.93
802.11n(20)	6.5	01	2412	6.17
		06	2437	12.20
		11	2462	11.92
802.11n(40)	13.5	03	2422	10.13
		06	2437	11.33
		09	2452	11.67

Bluetooth_EDR

Modulation	Channel	Frequency(MHz)	Peak Power (dBm)
GFSK	0	2402	-2.364
	39	2441	2.573
	78	2480	0.913
$\pi/4$ -DQPSK	0	2402	-3.096
	39	2441	1.706
	78	2480	-0.028
8-DPSK	0	2402	-3.251
	39	2441	1.518
	78	2480	-0.261

Bluetooth_BLE

Modulation	Channel	Frequency(MHz)	Peak Power (dBm)
GFSK	0	2402	-8.009
	19	2440	-3.976
	39	2480	-6.188

The results shown in this test report refer only to the sample(s) tested unless otherwise stated and the sample(s) are retained for 30 days only. The document is issued by AGC, this document cannot be reproduced except in full with our prior written permission. The more details and the authenticity of the report will be confirmed at <http://www.agc-cert.com>.

13. TEST RESULTS

13.1. SAR Test Results Summary

13.1.1. Test position and configuration

Head SAR was performed with the device configured in the positions according to IEEE 1528-2013, Body-worn SAR was performed with the device 10mm from the phantom

13.1.2. Operation Mode

1. Per KDB 447498 D01 v06 ,for each exposure position, if the highest 1-g SAR is ≤ 0.8 W/kg, testing for low and high channel is optional.
2. Per KDB 865664 D01 v01r04,for each frequency band, if the measured SAR is ≥ 0.8 W/Kg, testing for repeated SAR measurement is required , that the highest measured SAR is only to be tested. When the SAR results are near the limit, the following procedures are required for each device to verify these types of SAR measurement related variation concerns by repeating the highest measured SAR configuration in each frequency band.
 - (1) When the original highest measured SAR is ≥ 0.8 W/Kg, repeat that measurement once.
 - (2) Perform a second repeated measurement only if the ratio of largest to smallest SAR for the original and first repeated measurements is >1.20 or when the original or repeated measurement is ≥ 1.45 W/Kg.
 - (3) Perform a third repeated measurement only if the original, first and second repeated measurement is ≥ 1.5 W/Kg and ratio of largest to smallest SAR for the original, first and second measurement is ≥ 1.20 .
3. Per KDB 648474 D04 v01r03,when the reported SAR for a body-worn accessory measured without a headset connected to the handset is ≤ 1.2 W/Kg, SAR testing with a headset connected is not required.
4. Per KDB 248227 D01v02r02,for 2.4GHz 802.11g/n SAR testing is not required when the highest reported SAR for DSSS is adjusted by the ratio of OFDM to DSSS specified maximum output power and the adjusted SAR is ≤ 1.2 W/kg.
5. Maximum Scaling SAR in order to calculate the Maximum SAR values to test under the standard Peak Power, Calculation method is as follows:
Maximum Scaling SAR =tested SAR (Max.) \times [maximum turn-up power (mw)/ maximum measurement output power(mw)]
6. Bluetooth and WIFI have same antennas, and cannot transmit simultaneously;
7. According to KDB 447498 D01, annex A, SAR is not required for bluetooth because its maximum output power is less than 10 mW.

The results shown in this test report refer only to the sample(s) tested unless otherwise stated and the sample(s) are retained for 30 days only. The document is issued by AGC, this document cannot be reproduced except in full with our prior written permission. The more details and the authenticity of the report will be confirmed at <http://www.agc-cert.com>.

13.1.3. Test Result
SAR MEASUREMENT

Depth of Liquid (cm):>15 Relative Humidity (%): 64.9

Product: SkyCaddie SX500

Test Mode:802.11b

Position	Mode	Ch.	Fr. (MHz)	Power Drift ($\leq \pm 5\%$)	SAR (1g) (W/kg)	Max. Tune-up Power (dBm)	Meas. output Power (dBm)	Scaled SAR (W/Kg)	Limit (W/kg)
Left Cheek	DTS	6	2437	-0.23	0.174	14.70	14.65	0.176	1.6
Left Tilt	DTS	6	2437	0.14	0.109	14.70	14.65	0.110	1.6
Right Cheek	DTS	6	2437	-0.25	0.333	14.70	14.65	0.337	1.6
Right Tilt	DTS	6	2437	-0.63	0.225	14.70	14.65	0.228	1.6
Body back	DTS	6	2437	-0.48	0.107	14.70	14.65	0.108	1.6
Body front	DTS	6	2437	-1.22	0.085	14.70	14.65	0.086	1.6
Edge 1 (Top)	DTS	6	2437	0.02	0.040	14.70	14.65	0.040	1.6
Edge 4(Left)	DTS	6	2437	0.12	0.108	14.70	14.65	0.109	1.6

Note:

- According to KDB 248227 D01v02r02, for 2.4GHz 802.11g/n SAR testing is not required when the highest reported SAR for DSSS is adjusted by the ratio of OFDM to DSSS specified maximum output power and the adjusted SAR is $\leq 1.2W/kg$.
- All of above "DTS" means data transmitters.
- The test separation for body is 10mm of all above table.

The results shown in this test report refer only to the sample(s) tested unless otherwise stated and the sample(s) are retained for 30 days only. The document is issued by AGC, this document cannot be reproduced except in full with our prior written permission. The more details and the authenticity of the report will be confirmed at <http://www.agc-cert.com>.

SAR MEASUREMENT									
Depth of Liquid (cm):>15					Relative Humidity (%): 53.6				
Product: SkyCaddie SX500									
Test Mode:802.11b									
Position	Mode	Ch.	Fr. (MHz)	Power Drift (<±5%)	SAR (1g) (W/kg)	Max. Tune-up Power (dBm)	Meas. output Power (dBm)	Scaled SAR (W/Kg)	Limit (W/kg)
Body back	DTS	6	2437	-1.23	0.565	14.70	14.65	0.572	1.6
Body front	DTS	6	2437	0.86	0.641	14.70	14.65	0.648	1.6
Edge 1 (Top)	DTS	6	2437	-1.81	0.328	14.70	14.65	0.332	1.6
Edge 4(Left)	DTS	6	2437	-1.78	0.683	14.70	14.65	0.691	1.6

•The test separation for body s 0mm of all above table.

The results shown in this test report refer only to the sample(s) tested unless otherwise stated and the sample(s) are retained for 30 days only. The document is issued by AGC, this document cannot be reproduced except in full with our prior written permission. The more details and the authenticity of the report will be confirmed at <http://www.agc-cert.com>.

APPENDIX A. SAR SYSTEM CHECK DATA

Test Laboratory: AGC Lab

Date: Aug. 03,2018

System Check Head 2450 MHz

DUT: Dipole 2450 MHz Type: SID 2450

Communication System CW; Communication System Band: D2450 (2450.0 MHz); Duty Cycle: 1:1; Conv.F=2.52
Frequency: 2450 MHz; Medium parameters used: $f = 2450$ MHz; $\sigma = 1.82$ mho/m; $\epsilon_r = 38.81$; $\rho = 1000$ kg/m³ ;
Phantom section: Flat Section; Input Power=18dBm
Ambient temperature (°C):21.9, Liquid temperature (°C): 21.3

SATIMO Configuration

- Probe: SSE2; Calibrated: Aug. 08,2017; Serial No.: SN 08/16 EPGO282
- Sensor-Surface: 4mm (Mechanical Surface Detection)
- Phantom: SAM twin phantom
- Measurement SW: OpenSAR V4_02_32

Configuration/System Check 2450MHz Head/Area Scan: Measurement grid: dx=8mm, dy=8mm

Configuration/System Check 2450MHz Head/Zoom Scan: Measurement grid: dx=5mm,dy=5mm, dz=5mm

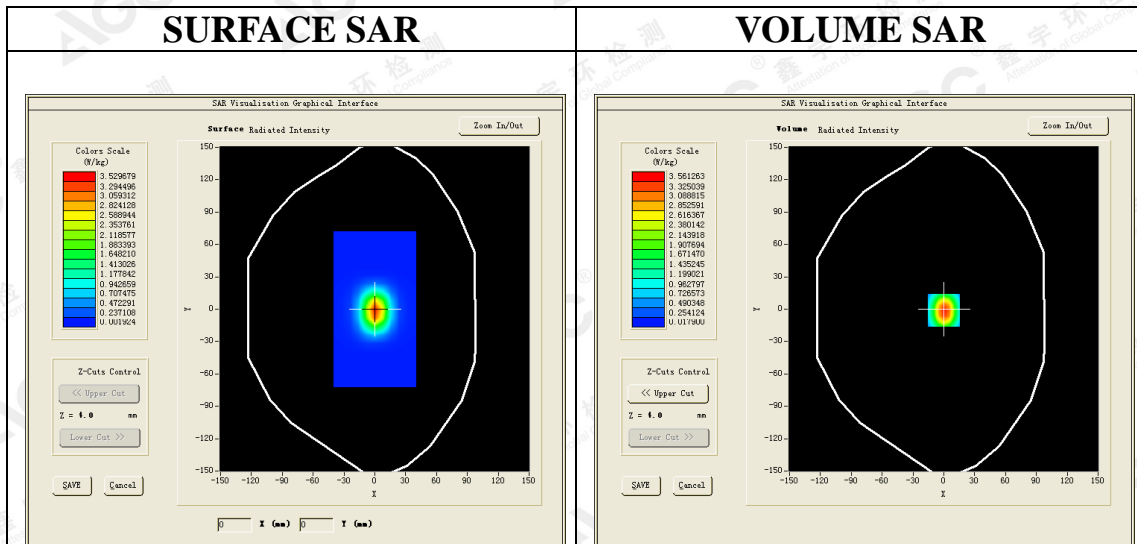

Maximum location: X=0.00, Y=-0.00

SAR Peak: 6.17 W/kg

SAR 10g (W/Kg)	1.465371
SAR 1g (W/Kg)	3.257154

The results shown in this test report refer only to the sample(s) tested unless otherwise stated and the sample(s) are retained for 30 days only. The document is issued by AGC, this document cannot be reproduced except in full with our prior written permission. The more details and the authenticity of the report will be confirmed at <http://www.agc-cert.com>.

Z (mm)	0.00	4.00	9.00	14.00	19.00	24.00	29.00
SAR (W/Kg)	6.1744	3.5695	1.6801	0.8144	0.4035	0.2011	0.1005

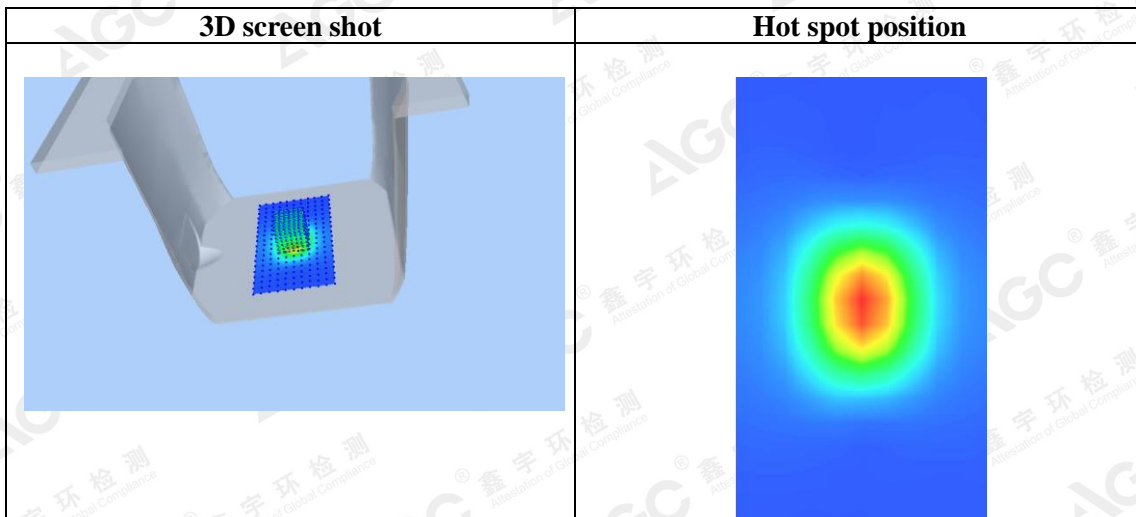
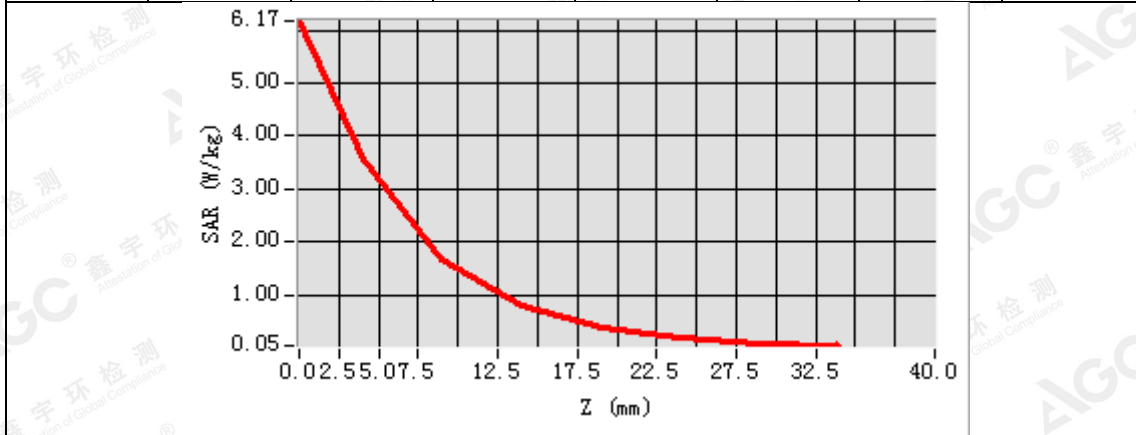

The results shown in this test report refer only to the sample(s) tested unless otherwise stated and the sample(s) are retained for 30 days only. The document is issued by AGC, this document cannot be reproduced except in full with our prior written permission. The more details and the authenticity of the report will be confirmed at <http://www.agc-cert.com>.

Test Laboratory: AGC Lab

Date: Aug. 03,2018

System Check Body 2450 MHz

DUT: Dipole 2450 MHz Type: SID 2450

Communication System CW; Communication System Band: D2450 (2450.0 MHz); Duty Cycle: 1:1; Conv.F=2.58

Frequency: 2450 MHz; Medium parameters used: $f = 2450$ MHz; $\sigma = 1.92$ mho/m; $\epsilon_r = 52.94$; $\rho = 1000$ kg/m³ ;

Phantom section: Flat Section; Input Power=18dBm

Ambient temperature (°C):21.9, Liquid temperature (°C): 21.5

SATIMO Configuration

- Probe: SSE2; Calibrated: Aug. 08,2017; Serial No.: SN 08/16 EPGO282
- Sensor-Surface: 4mm (Mechanical Surface Detection)
- Phantom: SAM twin phantom
- Measurement SW: OpenSAR V4_02_32

Configuration/System Check 2450MHz Body/Area Scan: Measurement grid: dx=8mm, dy=8mm

Configuration/System Check 2450MHz Body/Zoom Scan: Measurement grid: dx=5mm,dy=5mm, dz=5mm

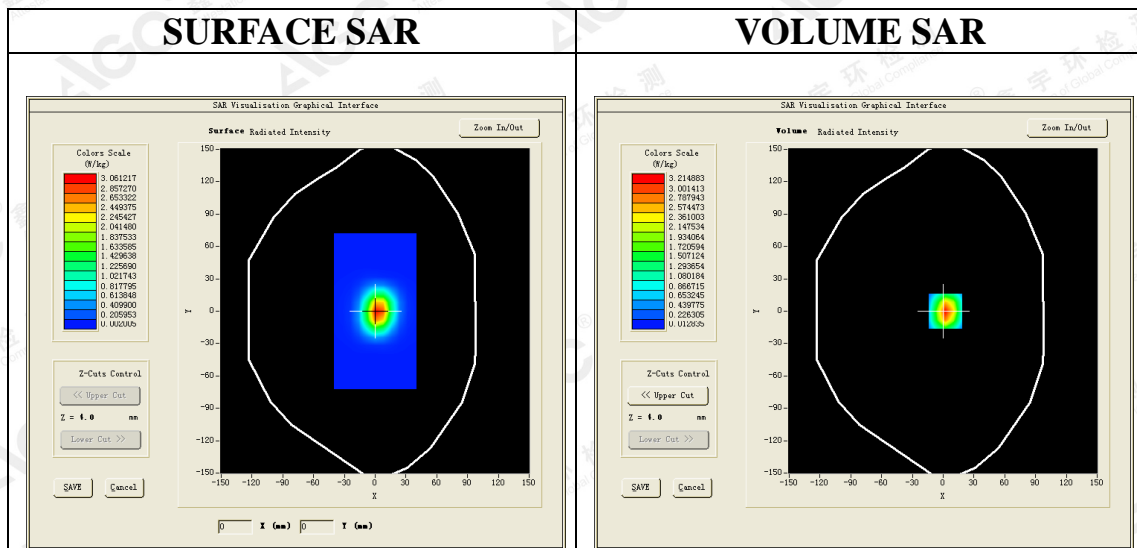

Maximum location: X=2.00, Y=0.00

SAR Peak: 5.69 W/kg

SAR 10g (W/Kg)	1.329134
SAR 1g (W/Kg)	3.023741

The results shown in this test report refer only to the sample(s) tested unless otherwise stated and the sample(s) are retained for 30 days only. The document is issued by AGC, this document cannot be reproduced except in full with our prior written permission. The more details and the authenticity of the report will be confirmed at <http://www.agc-cert.com>.

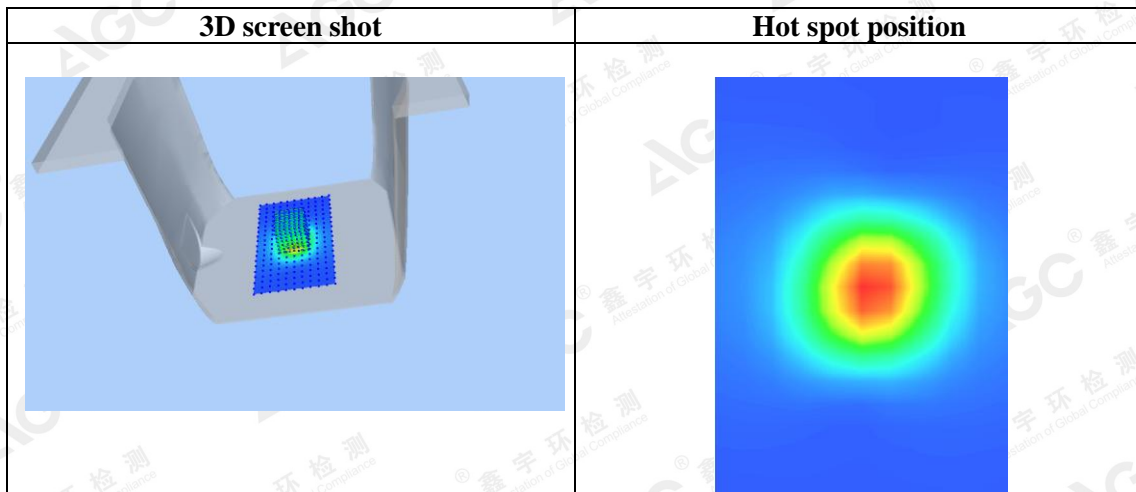
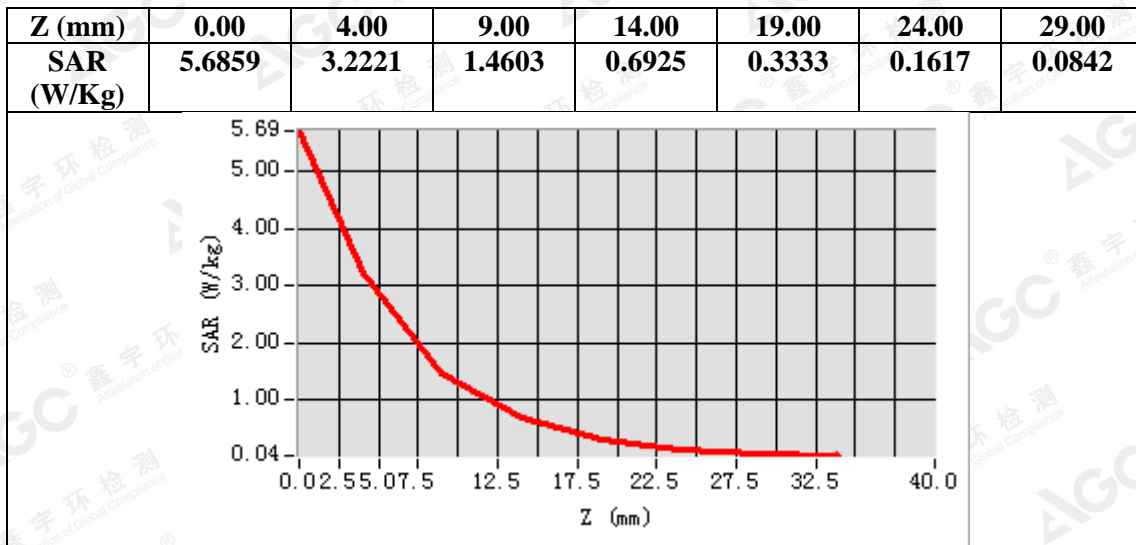

The results shown in this test report refer only to the sample(s) tested unless otherwise stated and the sample(s) are retained for 30 days only. The document is issued by AGC, this document cannot be reproduced except in full with our prior written permission. The more details and the authenticity of the report will be confirmed at <http://www.agc-cert.com>.

Test Laboratory: AGC Lab

Date: Aug. 30,2018

System Check Body 2450 MHz

DUT: Dipole 2450 MHz Type: SID 2450

Communication System CW; Communication System Band: D2450 (2450.0 MHz); Duty Cycle: 1:1; Conv.F=5.04

Frequency: 2450 MHz; Medium parameters used: $f = 2450$ MHz; $\sigma = 1.92$ mho/m; $\epsilon_r = 53.25$; $\rho = 1000$ kg/m³ ;

Phantom section: Flat Section; Input Power=18dBm

Ambient temperature (°C):21.9, Liquid temperature (°C): 21.5

SATIMO Configuration

- Probe: SSE5; Calibrated: Aug. 08,2018; Serial No.: SN 22/12 EP159
- Sensor-Surface: 4mm (Mechanical Surface Detection)
- Phantom: SAM twin phantom
- Measurement SW: OpenSAR V4_02_32

Configuration/System Check 2450MHz Body/Area Scan: Measurement grid: dx=8mm, dy=8mm

Configuration/System Check 2450MHz Body/Zoom Scan: Measurement grid: dx=5mm,dy=5mm, dz=5mm

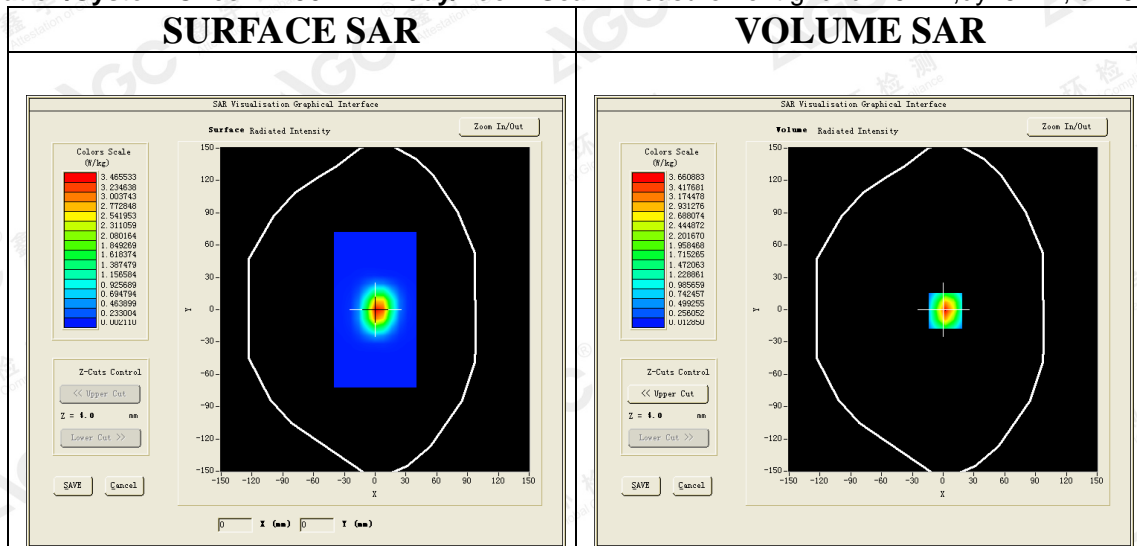

Maximum location: X=2.00, Y=-1.00

SAR Peak: 6.40 W/kg

SAR 10g (W/Kg)	1.451203
SAR 1g (W/Kg)	3.375541

The results shown in this test report refer only to the sample(s) tested unless otherwise stated and the sample(s) are retained for 30 days only. The document is issued by AGC, this document cannot be reproduced except in full with our prior written permission. The more details and the authenticity of the report will be confirmed at <http://www.agc-cert.com>.

Z (mm)	0.00	4.00	9.00	14.00	19.00	24.00	29.00
SAR (W/Kg)	6.4153	3.6411	1.6256	0.7581	0.3574	0.1623	0.0802

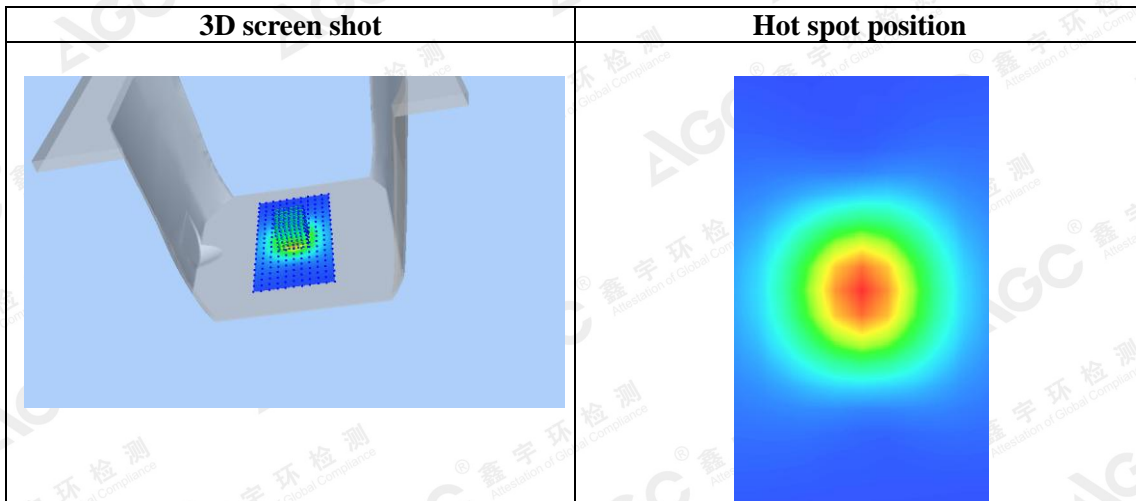
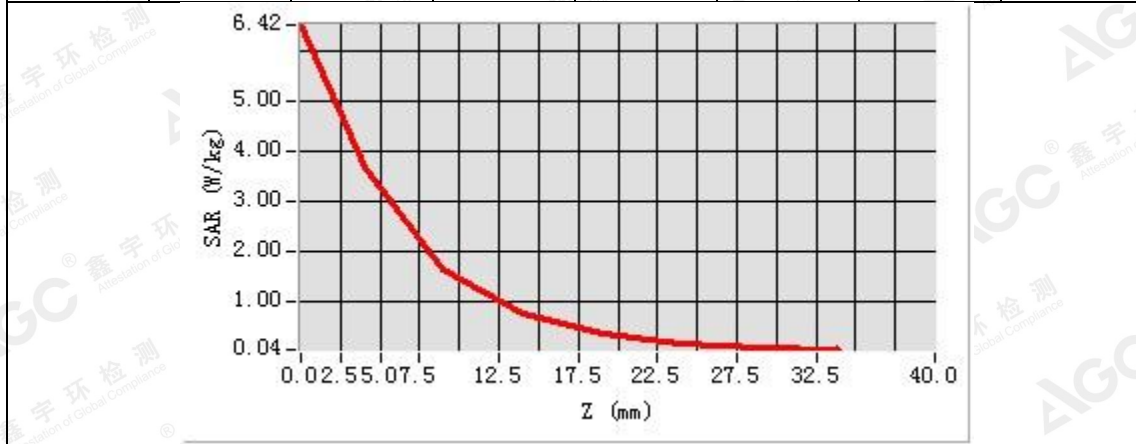

The results shown in this test report refer only to the sample(s) tested unless otherwise stated and the sample(s) are retained for 30 days only. The document is issued by AGC, this document cannot be reproduced except in full with our prior written permission. The more details and the authenticity of the report will be confirmed at <http://www.agc-cert.com>.

APPENDIX B. SAR MEASUREMENT DATA

Test Laboratory: AGC Lab
802.11b Mid-Touch-Left
DUT: SkyCaddie SX500 ; Type: SX500

Date: Aug. 03,2018

Communication System: Wi-Fi; Communication System Band: 802.11b; Duty Cycle: 1:1; Conv.F=2.52;
Frequency: 2437 MHz; Medium parameters used: $f = 2450$ MHz; $\sigma = 1.78$ mho/m; $\epsilon_r = 39.43$ $\rho = 1000$ kg/m³ ;
Phantom section: Left Section
Ambient temperature (°C):21.9, Liquid temperature (°C): 21.3

SATIMO Configuration:

- Probe: SSE2; Calibrated: Aug. 08,2017; Serial No.: SN 08/16 EPGO282
- Sensor-Surface: 4mm (Mechanical Surface Detection)
- Phantom: SAM twin phantom
- Measurement SW: OpenSAR V4_02_32

Configuration/802.11b Mid- Touch-Left/Area Scan: Measurement grid: dx=8mm, dy=8mm
Configuration/802.11b Mid- Touch-Left/Zoom Scan: Measurement grid: dx=5mm,dy=5mm, dz=5mm

Area Scan	sam_direct_droit2_surf8mm.txt
ZoomScan	7x7x7,dx=5mm dy=5mm dz=5mm
Phantom	Left head
Device Position	Cheek
Band	2450MHz
Channels	Middle
Signal	Crest factor: 1.0

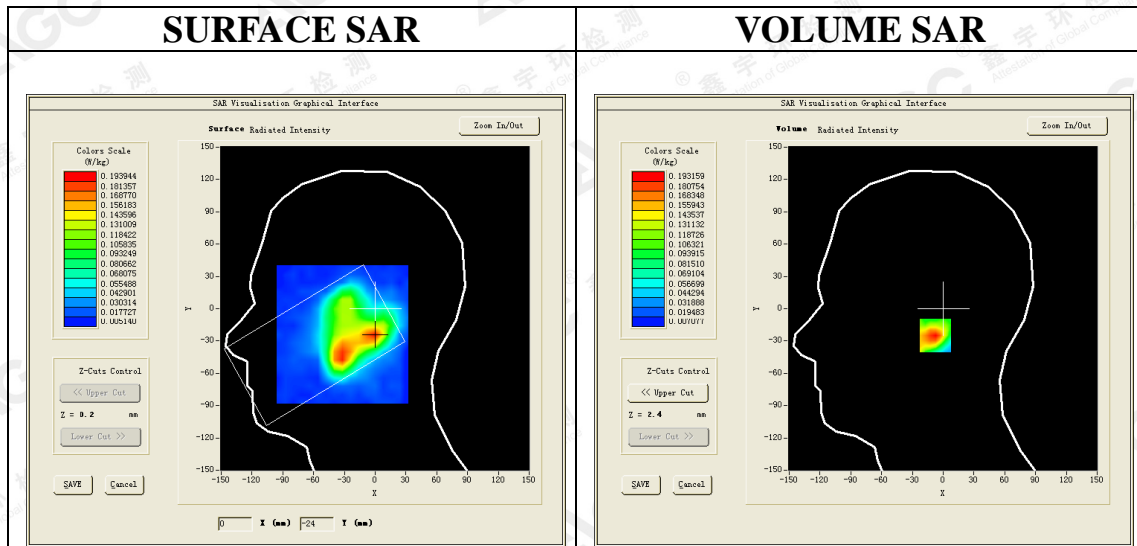

Maximum location: X=-1.00, Y=-25.00
SAR Peak: 0.29 W/kg

SAR 10g (W/Kg)	0.093415
SAR 1g (W/Kg)	0.173915

The results shown in this test report refer only to the sample(s) tested unless otherwise stated and the sample(s) are retained for 30 days only. The document is issued by AGC, this document cannot be reproduced except in full with our prior written permission. The more details and the authenticity of the report will be confirmed at <http://www.agc-cert.com>.

Z (mm)	0.00	4.00	9.00	14.00	19.00	24.00	29.00
SAR (W/Kg)	0.2903	0.1932	0.1128	0.0590	0.0327	0.0215	0.0115

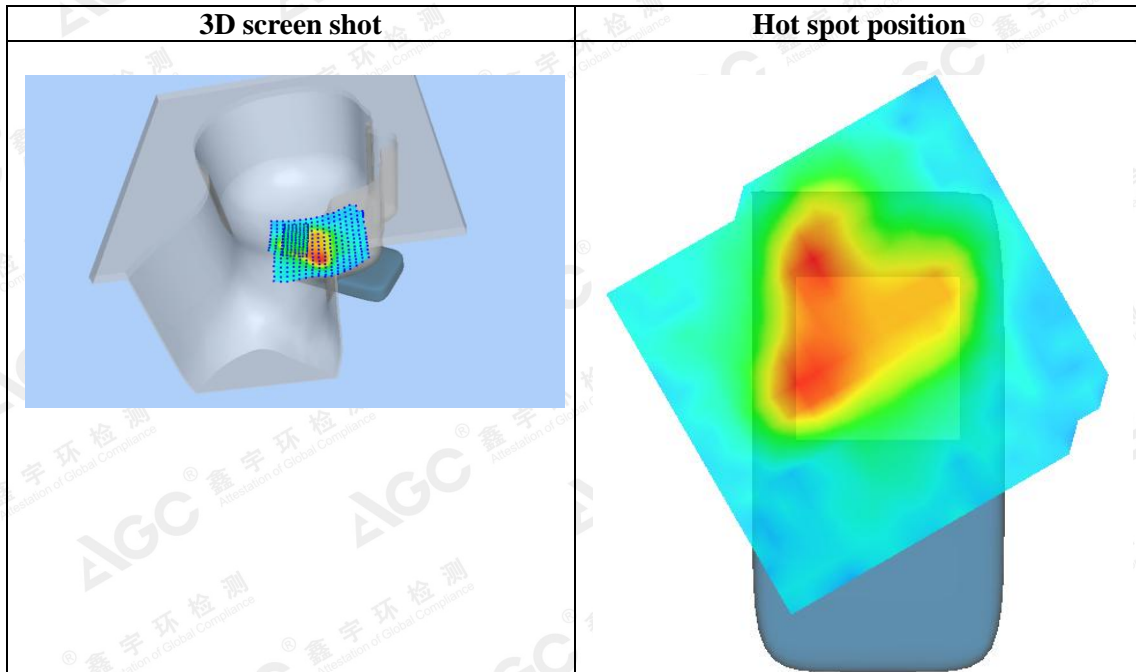
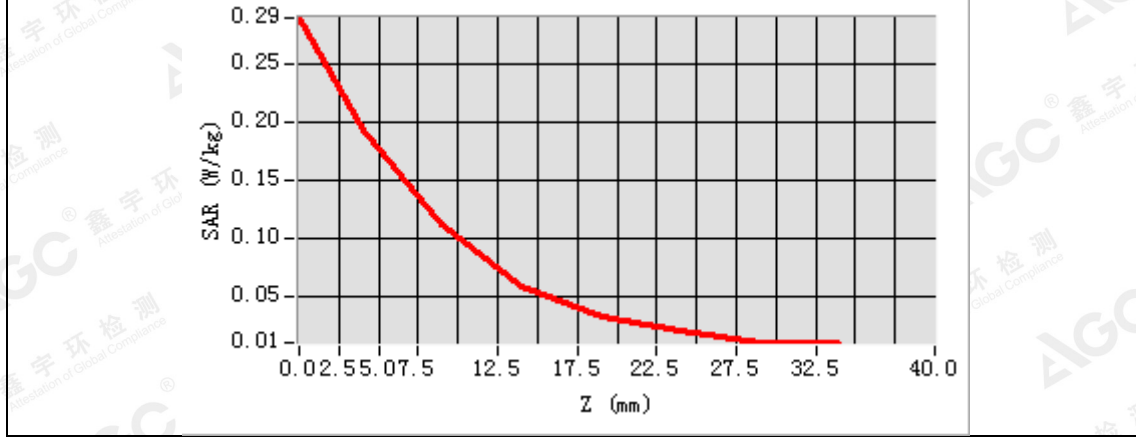

The results shown in this test report refer only to the sample(s) tested unless otherwise stated and the sample(s) are retained for 30 days only. The document is issued by AGC, this document cannot be reproduced except in full with our prior written permission. The more details and the authenticity of the report will be confirmed at <http://www.agc-cert.com>.

Test Laboratory: AGC Lab
802.11b Mid -Tilt-Left
DUT: SkyCaddie SX500 ; Type: SX500

Date: Aug. 03,2018

Communication System: Wi-Fi; Communication System Band: 802.11b; Duty Cycle: 1:1; Conv.F=2.52;
Frequency: 2437 MHz; Medium parameters used: $f = 2450$ MHz; $\sigma = 1.78$ mho/m; $\epsilon_r = 39.43$; $\rho = 1000$ kg/m³ ;
Phantom section: Left Section
Ambient temperature (°C):21.9, Liquid temperature (°C): 21.3

SATIMO Configuration:

- Probe: SSE2; Calibrated: Aug. 08,2017; Serial No.: SN 08/16 EPGO282
- Sensor-Surface: 4mm (Mechanical Surface Detection)
- Phantom: SAM twin phantom
- Measurement SW: OpenSAR V4_02_32

Configuration/802.11b Mid- Tilt-Left/Area Scan: Measurement grid: dx=8mm, dy=8mm

Configuration/802.11b Mid- Tilt-Left/Zoom Scan: Measurement grid: dx=5mm, dy=5mm,dz=5mm;

Area Scan	sam_direct_droit2_surf8mm.txt
ZoomScan	7x7x7,dx=5mm dy=5mm dz=5mm
Phantom	Left head
Device Position	Tilt
Band	2450MHz
Channels	Middle
Signal	Crest factor: 1.0

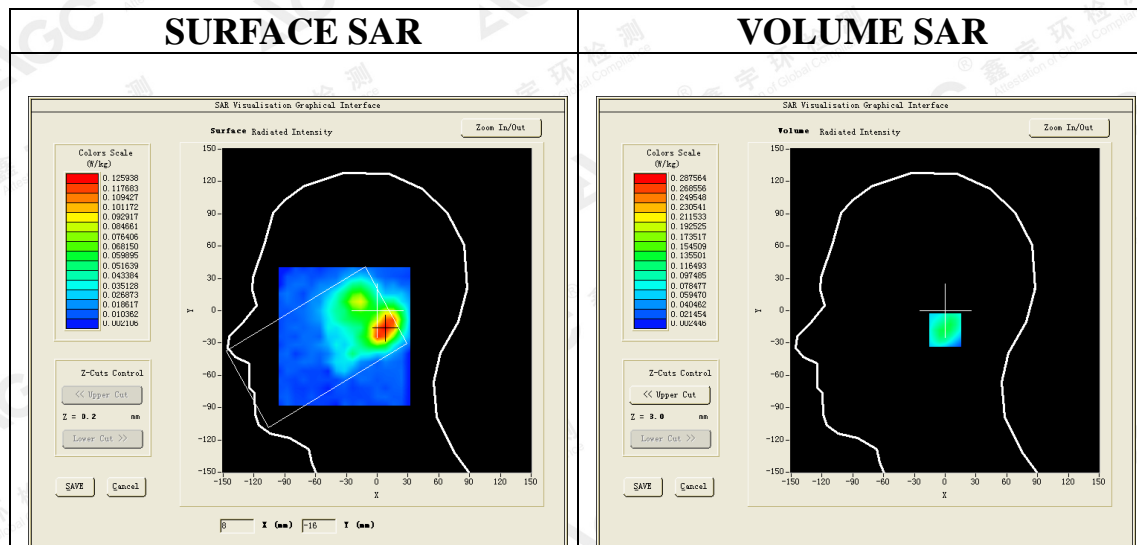

Maximum location: X=6.00, Y=-18.00

SAR Peak: 0.24 W/kg

SAR 10g (W/Kg)	0.063683
SAR 1g (W/Kg)	0.109288

The results shown in this test report refer only to the sample(s) tested unless otherwise stated and the sample(s) are retained for 30 days only. The document is issued by AGC, this document cannot be reproduced except in full with our prior written permission. The more details and the authenticity of the report will be confirmed at <http://www.agc-cert.com>.

Z (mm)	0.00	4.00	9.00	14.00	19.00	24.00	29.00
SAR (W/Kg)	0.2158	0.1313	0.0696	0.0346	0.0204	0.0155	0.0096

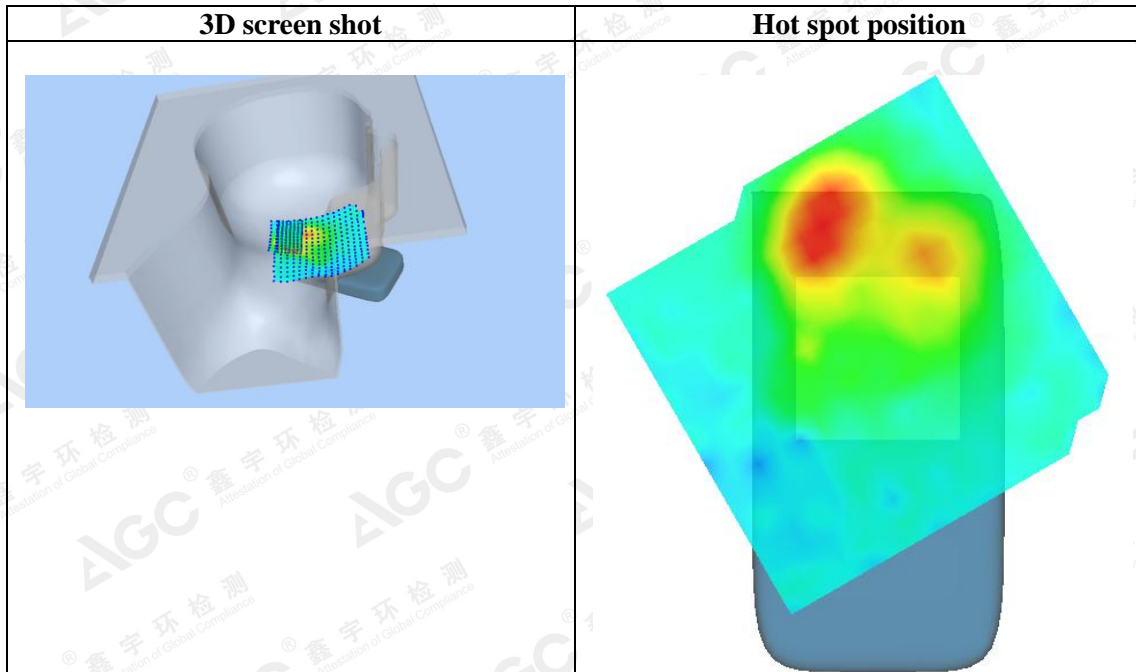
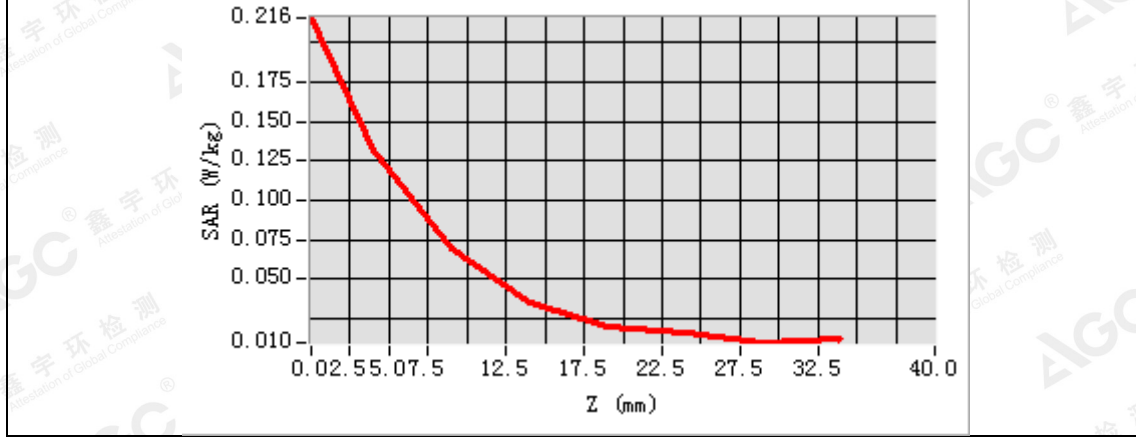

The results shown in this test report refer only to the sample(s) tested unless otherwise stated and the sample(s) are retained for 30 days only. The document is issued by AGC, this document cannot be reproduced except in full with our prior written permission. The more details and the authenticity of the report will be confirmed at <http://www.agc-cert.com>.

Test Laboratory: AGC Lab
802.11b Mid- Touch-Right
DUT: SkyCaddie SX500 ; Type: SX500

Date: Aug. 03,2018

Communication System: Wi-Fi; Communication System Band: 802.11b; Duty Cycle: 1:1; Conv.F=2.52;
Frequency: 2437 MHz; Medium parameters used: f = 2450 MHz; $\sigma = 1.78\text{mho/m}$; $\epsilon_r = 39.43$; $\rho = 1000 \text{ kg/m}^3$;
Phantom section: Right Section
Ambient temperature (°C):21.9, Liquid temperature (°C): 21.3

SATIMO Configuration:

- Probe: SSE2; Calibrated: Aug. 08,2017; Serial No.: SN 08/16 EPGO282
- Sensor-Surface: 4mm (Mechanical Surface Detection)
- Phantom: SAM twin phantom
- Measurement SW: OpenSAR V4_02_32

Configuration/802.11b Mid- Touch-Right /Area Scan: Measurement grid: dx=8mm, dy=8mm
Configuration/802.11b Mid- Touch-Right /Zoom Scan: Measurement grid: dx=5mm,dy=5mm, dz=5mm;

Area Scan	sam_direct_droit2_surf8mm.txt
ZoomScan	7x7x7,dx=5mm dy=5mm dz=5mm
Phantom	Right head
Device Position	Cheek
Band	2450MHz
Channels	Middle
Signal	Crest factor: 1.0

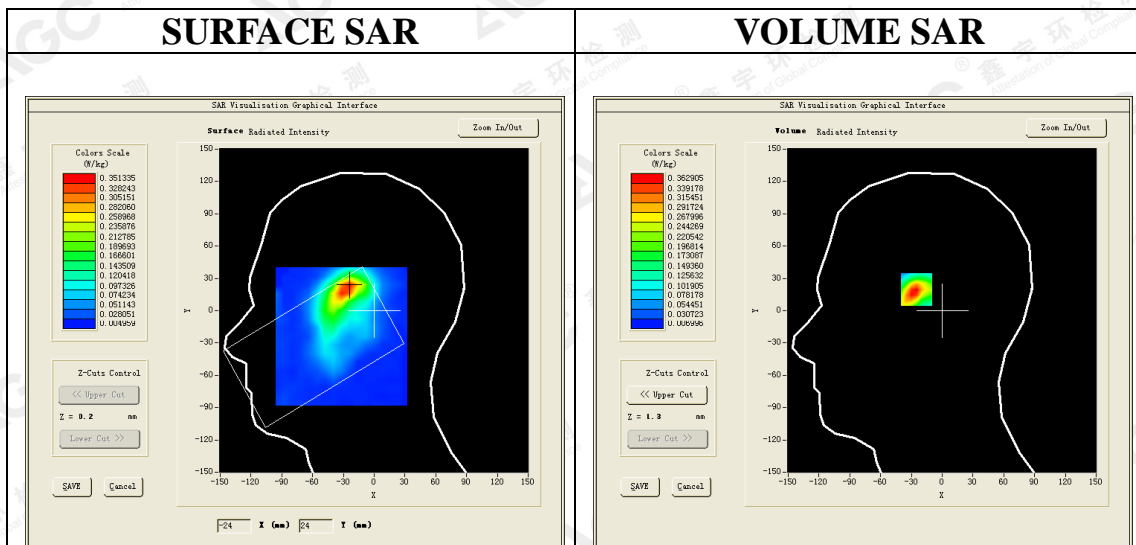

Maximum location: X=-25.00, Y=22.00
SAR Peak: 0.57 W/kg

SAR 10g (W/Kg)	0.165856
SAR 1g (W/Kg)	0.332975

The results shown in this test report refer only to the sample(s) tested unless otherwise stated and the sample(s) are retained for 30 days only. The document is issued by AGC, this document cannot be reproduced except in full with our prior written permission. The more details and the authenticity of the report will be confirmed at <http://www.agc-cert.com>.

Z (mm)	0.00	4.00	9.00	14.00	19.00	24.00	29.00
SAR (W/Kg)	0.5572	0.3629	0.1986	0.1057	0.0526	0.0319	0.0231

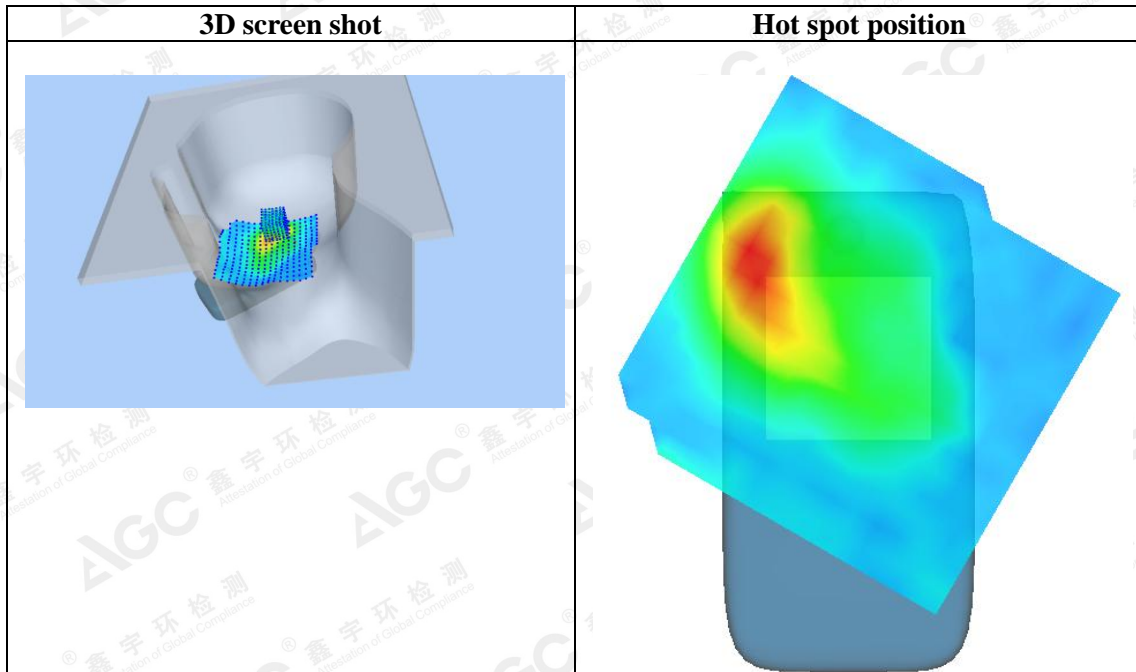
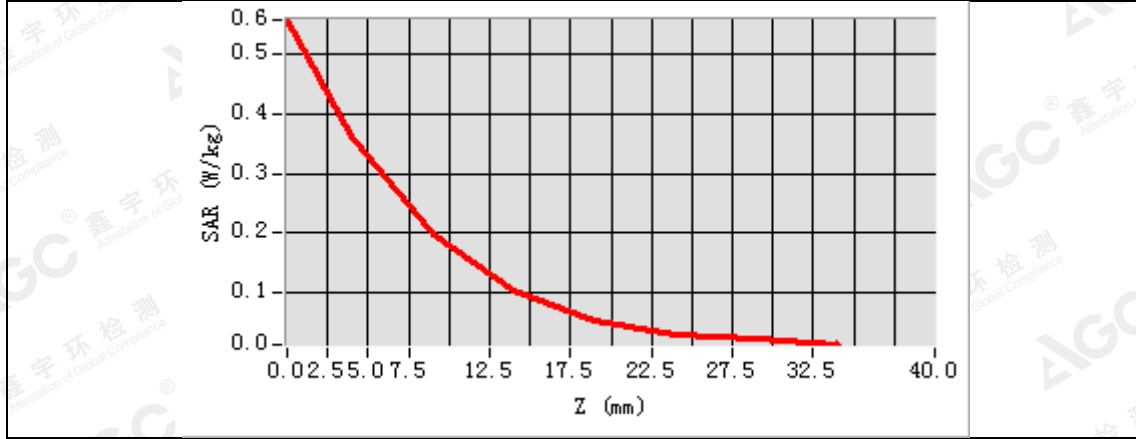

The results shown in this test report refer only to the sample(s) tested unless otherwise stated and the sample(s) are retained for 30 days only. The document is issued by AGC, this document cannot be reproduced except in full with our prior written permission. The more details and the authenticity of the report will be confirmed at <http://www.agc-cert.com>.

Test Laboratory: AGC Lab
802.11b Mid-Tilt-Right
DUT: SkyCaddie SX500 ; Type: SX500

Date: Aug. 03,2018

Communication System: Wi-Fi; Communication System Band: 802.11b; Duty Cycle: 1:1; Conv.F=2.52;
Frequency: 2437 MHz; Medium parameters used: $f = 2450$ MHz; $\sigma = 1.78$ mho/m; $\epsilon_r = 39.43$; $\rho = 1000$ kg/m³ ;
Phantom section: Right Section
Ambient temperature (°C):21.9, Liquid temperature (°C): 21.3

SATIMO Configuration:

- Probe: SSE2; Calibrated: Aug. 08,2017; Serial No.: SN 08/16 EPGO282
- Sensor-Surface: 4mm (Mechanical Surface Detection)
- Phantom: SAM twin phantom
- Measurement SW: OpenSAR V4_02_32

Configuration/802.11b Mid- Tilt-Right/Area Scan: Measurement grid: dx=8mm, dy=8mm
Configuration/802.11b Mid- Tilt-Right/Zoom Scan: Measurement grid: dx=5mm,dy=5mm, dz=5mm;

Area Scan	sam_direct_droit2_surf8mm.txt
ZoomScan	7x7x7,dx=5mm dy=5mm dz=5mm
Phantom	Right head
Device Position	Tilt
Band	2450MHz
Channels	Middle
Signal	Crest factor: 1.0

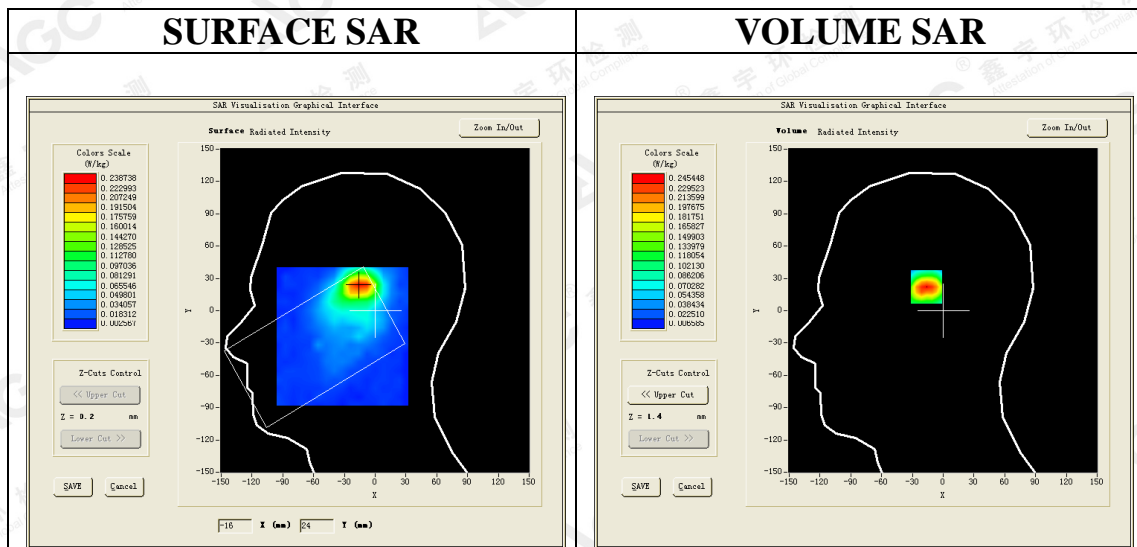

Maximum location: X=-15.00, Y=24.00
SAR Peak: 0.40 W/kg

SAR 10g (W/Kg)	0.115383
SAR 1g (W/Kg)	0.224952

The results shown in this test report refer only to the sample(s) tested unless otherwise stated and the sample(s) are retained for 30 days only. The document is issued by AGC, this document cannot be reproduced except in full with our prior written permission. The more details and the authenticity of the report will be confirmed at <http://www.agc-cert.com>.

Z (mm)	0.00	4.00	9.00	14.00	19.00	24.00	29.00
SAR (W/Kg)	0.4061	0.2454	0.1272	0.0669	0.0391	0.0212	0.0136

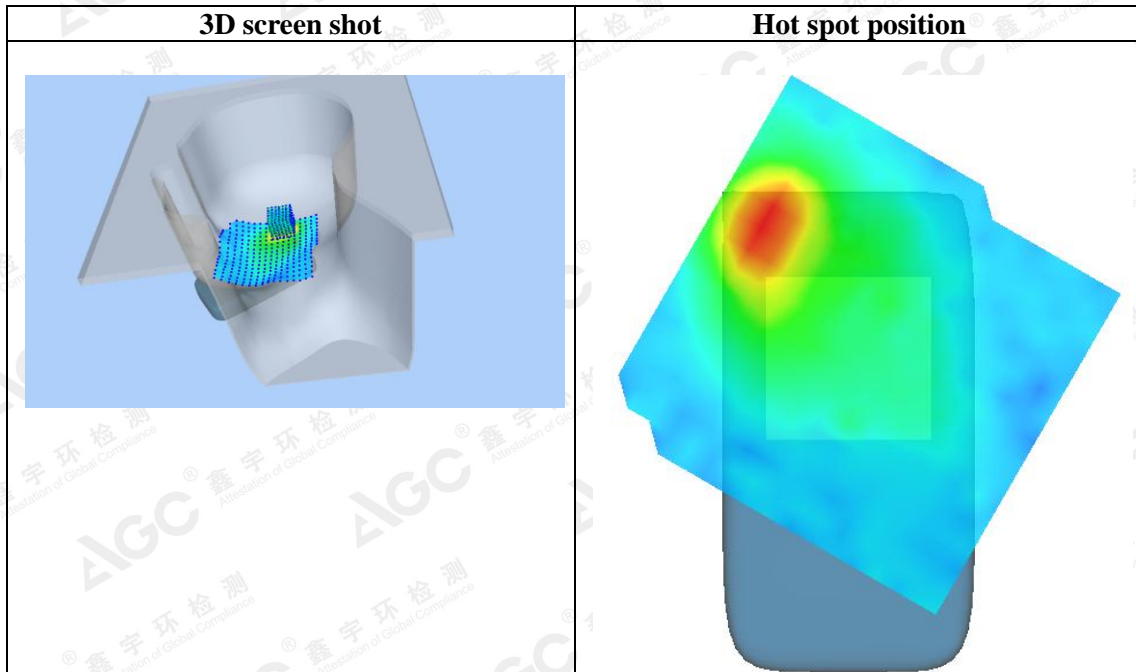
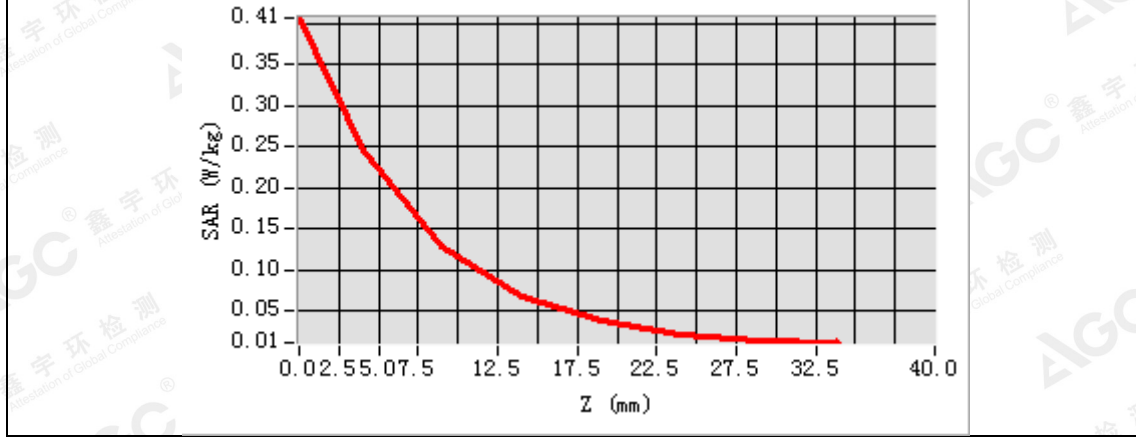

The results shown in this test report refer only to the sample(s) tested unless otherwise stated and the sample(s) are retained for 30 days only. The document is issued by AGC, this document cannot be reproduced except in full with our prior written permission. The more details and the authenticity of the report will be confirmed at <http://www.agc-cert.com>.

Test Laboratory: AGC Lab
802.11b Mid-Body-Worn- Back (DTS)
DUT: SkyCaddie SX500 ; Type: SX500

Date: Aug. 03,2018

Communication System: Wi-Fi; Communication System Band: 802.11b; Duty Cycle: 1:1; Conv.F=2.58;
Frequency: 2437 MHz; Medium parameters used: $f = 2450$ MHz; $\sigma = 1.90$ mho/m; $\epsilon_r = 53.47$; $\rho = 1000$ kg/m³ ;
Phantom section: Flat Section
Ambient temperature (°C):21.9, Liquid temperature (°C): 21.5

SATIMO Configuration:

- Probe: SSE2; Calibrated: Aug. 08,2017; Serial No.: SN 08/16 EPGO282
- Sensor-Surface: 4mm (Mechanical Surface Detection)
- Phantom: SAM twin phantom
- Measurement SW: OpenSAR V4_02_32

Configuration/802.11b Mid- Body- Back /Area Scan: Measurement grid: dx=8mm, dy=8mm
Configuration/802.11b Mid- Body- Back /Zoom Scan: Measurement grid: dx=5mm,dy=5mm, dz=5mm;

Area Scan	sam_direct_droit2_surf8mm.txt
ZoomScan	7x7x7,dx=5mm dy=5mm dz=5mm
Phantom	Validation plane
Device Position	Body Back
Band	2450MHz
Channels	Middle
Signal	Crest factor: 1.0

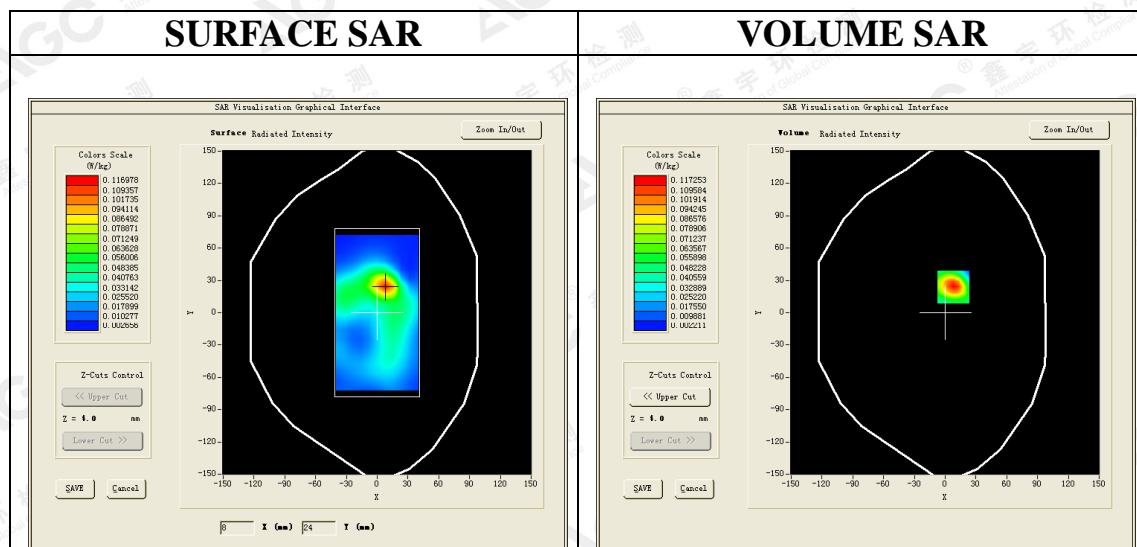

Maximum location: X=8.00, Y=24.00
SAR Peak: 0.19 W/kg

SAR 10g (W/Kg)	0.053344
SAR 1g (W/Kg)	0.107141

The results shown in this test report refer only to the sample(s) tested unless otherwise stated and the sample(s) are retained for 30 days only. The document is issued by AGC, this document cannot be reproduced except in full with our prior written permission. The more details and the authenticity of the report will be confirmed at <http://www.agc-cert.com>.

Z (mm)	0.00	4.00	9.00	14.00	19.00	24.00	29.00
SAR (W/Kg)	0.1852	0.1173	0.0641	0.0342	0.0192	0.0109	0.0066

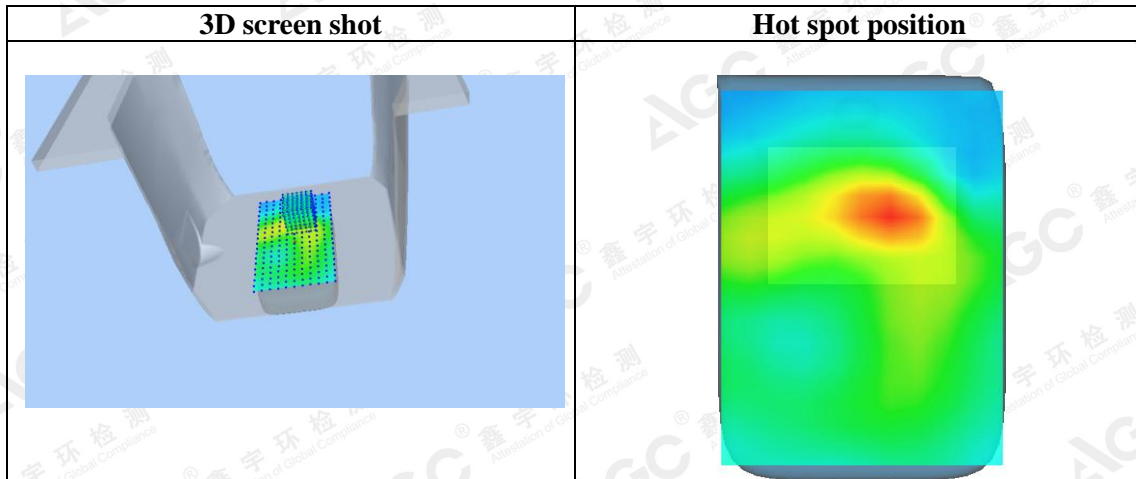
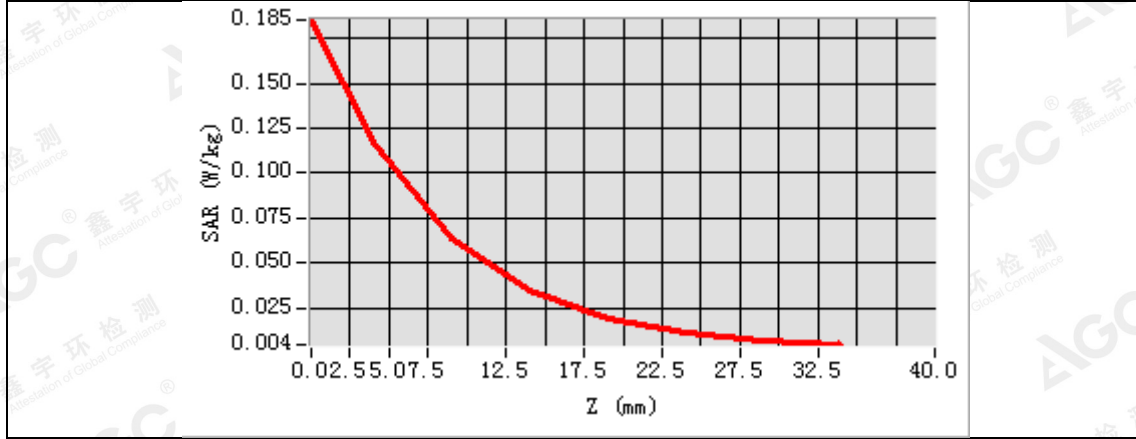

The results shown in this test report refer only to the sample(s) tested unless otherwise stated and the sample(s) are retained for 30 days only. The document is issued by AGC, this document cannot be reproduced except in full with our prior written permission. The more details and the authenticity of the report will be confirmed at <http://www.agc-cert.com>.

Test Laboratory: AGC Lab
802.11b Mid-Body- Worn- Front (DTS)
DUT: SkyCaddie SX500 ; Type: SX500

Date: Aug. 03,2018

Communication System: Wi-Fi; Communication System Band: 802.11b; Duty Cycle: 1:1; Conv.F=2.58;
Frequency: 2437 MHz; Medium parameters used: $f = 2450$ MHz; $\sigma = 1.90$ mho/m; $\epsilon_r = 53.47$; $\rho = 1000$ kg/m³ ;
Phantom section: Flat Section
Ambient temperature (°C):21.9, Liquid temperature (°C): 21.5

SATIMO Configuration:

- Probe: SSE2; Calibrated: Aug. 08,2017; Serial No.: SN 08/16 EPGO282
- Sensor-Surface: 4mm (Mechanical Surface Detection)
- Phantom: SAM twin phantom
- Measurement SW: OpenSAR V4_02_32

Configuration/802.11b Mid- Body- Front /Area Scan: Measurement grid: dx=8mm, dy=8mm

Configuration/802.11b Mid- Body- Front /Zoom Scan: Measurement grid: dx=5mm,dy=5mm, dz=5mm;

Area Scan	sam_direct_droit2_surf8mm.txt
ZoomScan	7x7x7,dx=5mm dy=5mm dz=5mm
Phantom	Validation plane
Device Position	Body Front
Band	2450MHz
Channels	Middle
Signal	Crest factor: 1.0

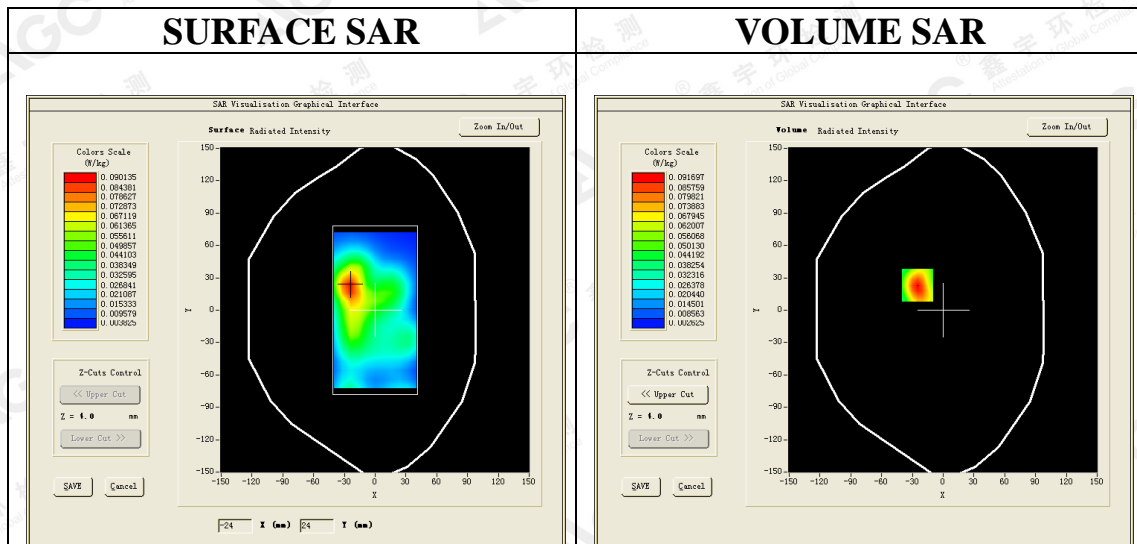

Maximum location: X=-25.00, Y=23.00

SAR Peak: 0.14 W/kg

SAR 10g (W/Kg)	0.047319
SAR 1g (W/Kg)	0.084853

The results shown in this test report refer only to the sample(s) tested unless otherwise stated and the sample(s) are retained for 30 days only. The document is issued by AGC, this document cannot be reproduced except in full with our prior written permission. The more details and the authenticity of the report will be confirmed at <http://www.agc-cert.com>.

Z (mm)	0.00	4.00	9.00	14.00	19.00	24.00	29.00
SAR (W/Kg)	0.1375	0.0917	0.0533	0.0300	0.0169	0.0100	0.0065

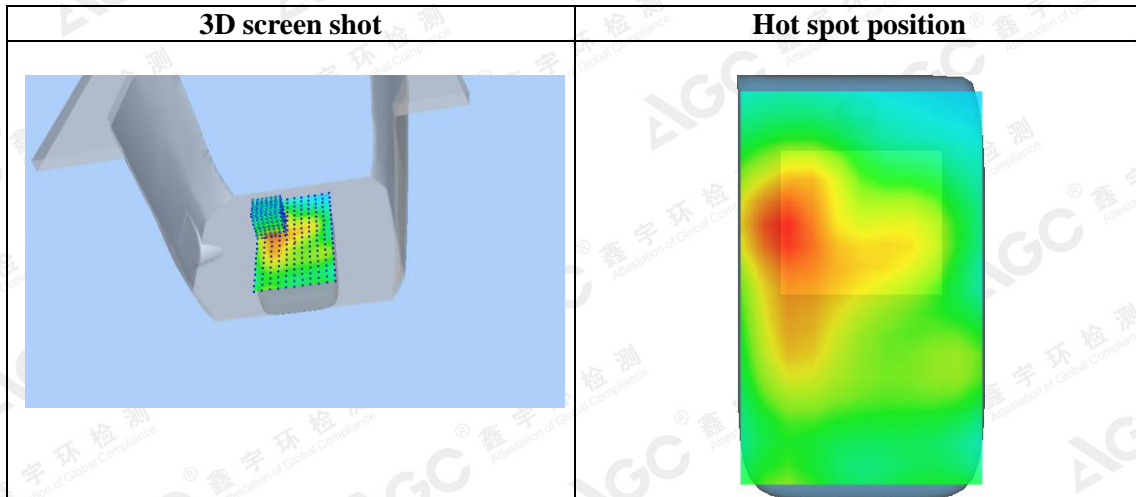
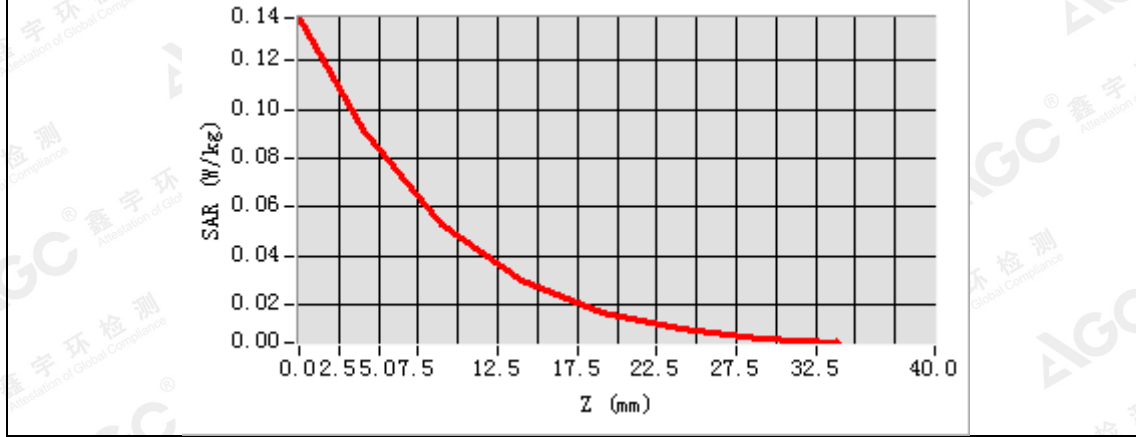

The results shown in this test report refer only to the sample(s) tested unless otherwise stated and the sample(s) are retained for 30 days only. The document is issued by AGC, this document cannot be reproduced except in full with our prior written permission. The more details and the authenticity of the report will be confirmed at <http://www.agc-cert.com>.

Test Laboratory: AGC Lab
802.11b Mid- Edge1 (DTS)
DUT: SkyCaddie SX500 ; Type: SX500

Date: Aug. 03,2018

Communication System: Wi-Fi; Communication System Band: 802.11b; Duty Cycle: 1:1; Conv.F=2.58;
Frequency: 2437 MHz; Medium parameters used: $f = 2450$ MHz; $\sigma = 1.90$ mho/m; $\epsilon_r = 53.47$; $\rho = 1000$ kg/m³ ;
Phantom section: Flat Section
Ambient temperature (°C):21.9, Liquid temperature (°C): 21.5

SATIMO Configuration:

- Probe: SSE2; Calibrated: Aug. 08,2017; Serial No.: SN 08/16 EPGO282
- Sensor-Surface: 4mm (Mechanical Surface Detection)
- Phantom: SAM twin phantom
- Measurement SW: OpenSAR V4_02_32

Configuration/802.11b Mid- Edge1 /Area Scan: Measurement grid: dx=8mm, dy=8mm

Configuration/802.11b Mid- Edge1 /Zoom Scan: Measurement grid: dx=5mm,dy=5mm, dz=5mm;

Area Scan	sam_direct_droit2_surf8mm.txt
ZoomScan	7x7x7,dx=5mm dy=5mm dz=5mm
Phantom	Validation plane
Device Position	Edge1
Band	2450MHz
Channels	Middle
Signal	Crest factor: 1.0

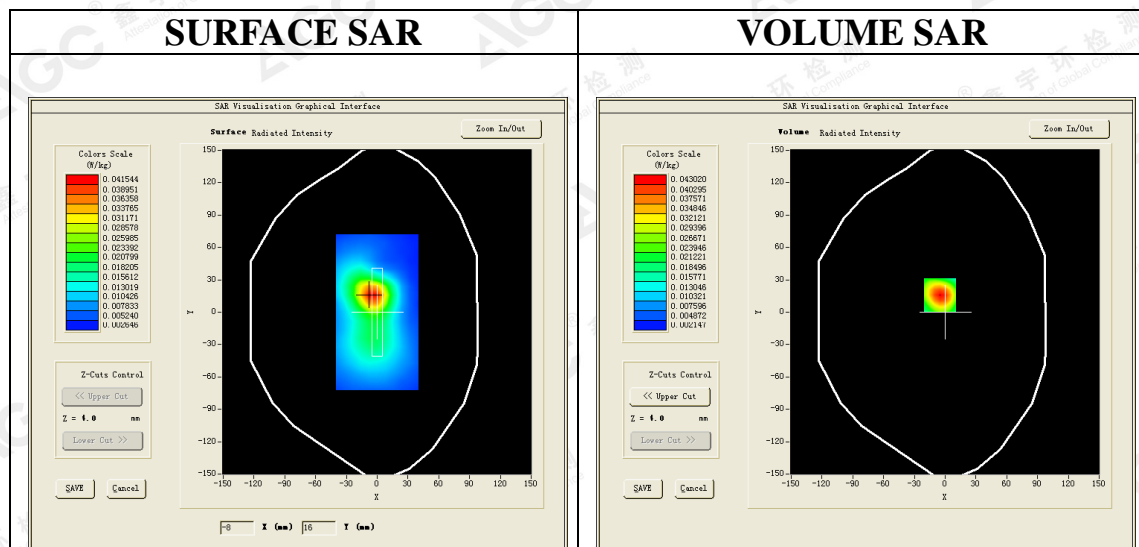

Maximum location: X=-5.00, Y=16.00

SAR Peak: 0.06 W/kg

SAR 10g (W/Kg)	0.022104
SAR 1g (W/Kg)	0.040082

The results shown in this test report refer only to the sample(s) tested unless otherwise stated and the sample(s) are retained for 30 days only. The document is issued by AGC, this document cannot be reproduced except in full with our prior written permission. The more details and the authenticity of the report will be confirmed at <http://www.agc-cert.com>.

Z (mm)	0.00	4.00	9.00	14.00	19.00	24.00	29.00
SAR (W/Kg)	0.0649	0.0430	0.0252	0.0143	0.0087	0.0055	0.0038

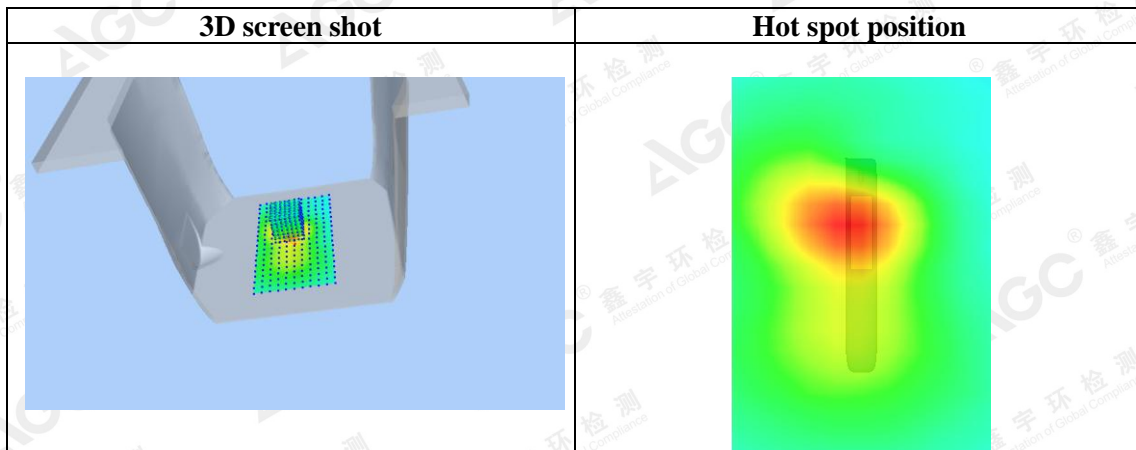
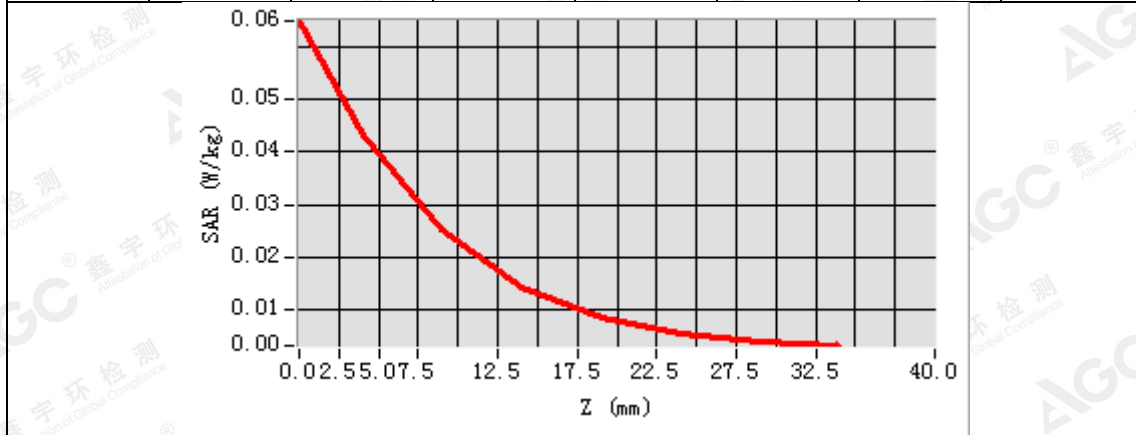

The results shown in this test report refer only to the sample(s) tested unless otherwise stated and the sample(s) are retained for 30 days only. The document is issued by AGC, this document cannot be reproduced except in full with our prior written permission. The more details and the authenticity of the report will be confirmed at <http://www.agc-cert.com>.

Test Laboratory: AGC Lab
802.11b Mid- Edge4 (DTS)
DUT: SkyCaddie SX500 ; Type: SX500

Date: Aug. 03,2018

Communication System: Wi-Fi; Communication System Band: 802.11b; Duty Cycle: 1:1; Conv.F=2.58;
Frequency: 2437 MHz; Medium parameters used: $f = 2450$ MHz; $\sigma = 1.90$ mho/m; $\epsilon_r = 53.47$; $\rho = 1000$ kg/m³ ;
Phantom section: Flat Section
Ambient temperature (°C):21.9, Liquid temperature (°C): 21.5

SATIMO Configuration:

- Probe: SSE2; Calibrated: Aug. 08,2017; Serial No.: SN 08/16 EPGO282
- Sensor-Surface: 4mm (Mechanical Surface Detection)
- Phantom: SAM twin phantom
- Measurement SW: OpenSAR V4_02_32

Configuration/802.11b Mid- Edge4 /Area Scan: Measurement grid: dx=8mm, dy=8mm
Configuration/802.11b Mid- Edge4 /Zoom Scan: Measurement grid: dx=5mm,dy=5mm, dz=5mm;

Area Scan	sam_direct_droit2_surf8mm.txt
ZoomScan	7x7x7,dx=5mm dy=5mm dz=5mm
Phantom	Validation plane
Device Position	Edge4
Band	2450MHz
Channels	Middle
Signal	Crest factor: 1.0

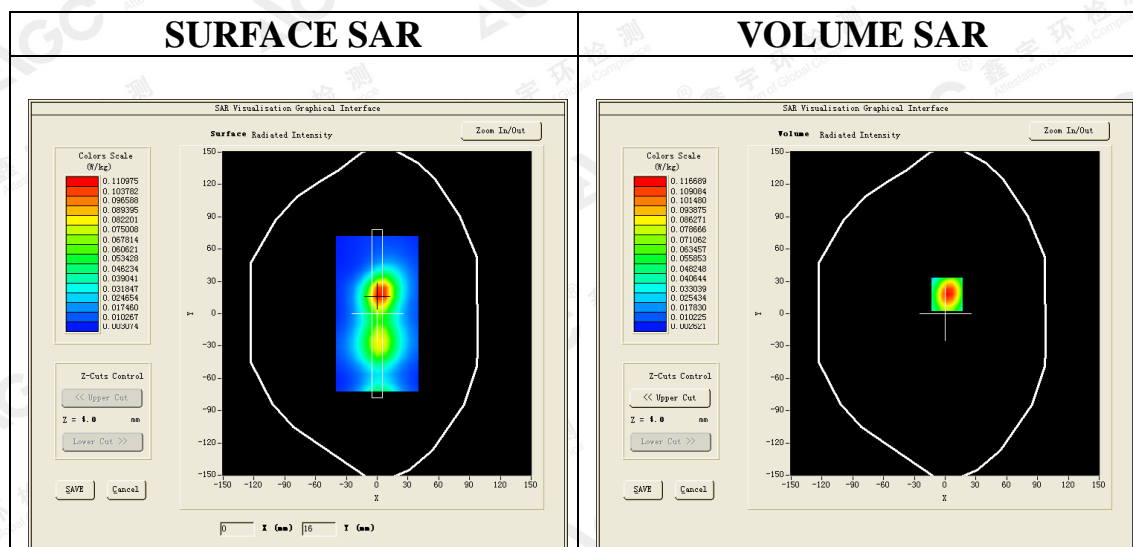

Maximum location: X=2.00, Y=18.00
SAR Peak: 0.18 W/kg

SAR 10g (W/Kg)	0.055998
SAR 1g (W/Kg)	0.108074

The results shown in this test report refer only to the sample(s) tested unless otherwise stated and the sample(s) are retained for 30 days only. The document is issued by AGC, this document cannot be reproduced except in full with our prior written permission. The more details and the authenticity of the report will be confirmed at <http://www.agc-cert.com>.

Z (mm)	0.00	4.00	9.00	14.00	19.00	24.00	29.00
SAR (W/Kg)	0.1793	0.1167	0.0659	0.0359	0.0202	0.0117	0.0072

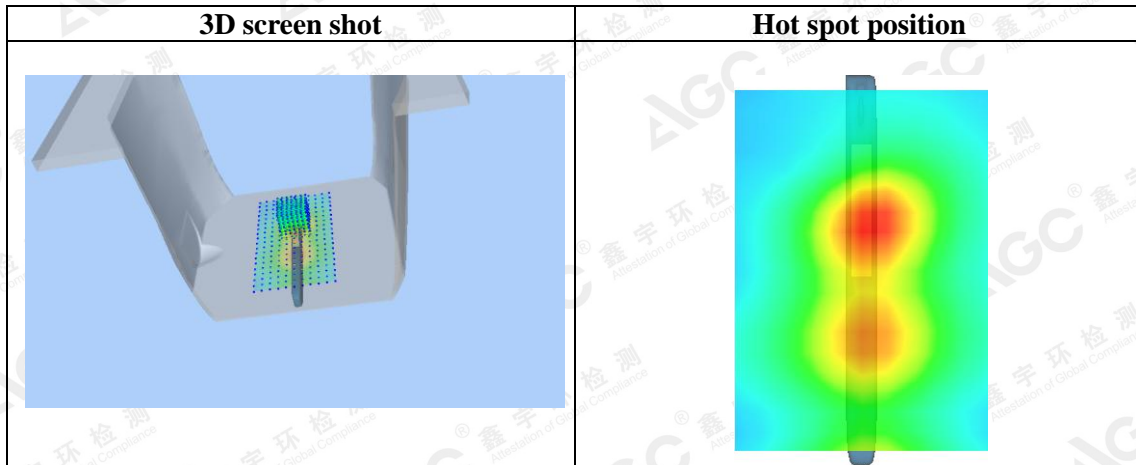
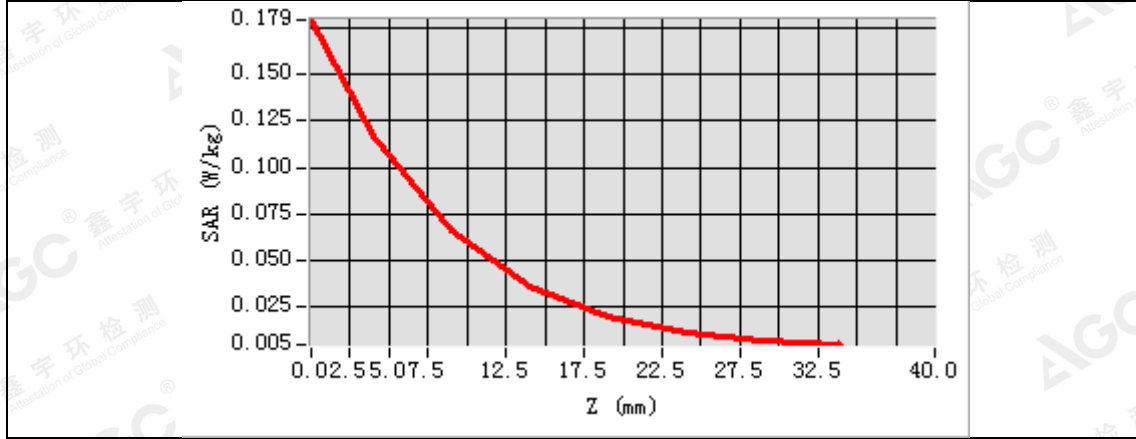

The results shown in this test report refer only to the sample(s) tested unless otherwise stated and the sample(s) are retained for 30 days only. The document is issued by AGC, this document cannot be reproduced except in full with our prior written permission. The more details and the authenticity of the report will be confirmed at <http://www.agc-cert.com>.

Test Laboratory: AGC Lab
802.11b Mid-Body-Worn- Back (DTS)
DUT: SkyCaddie SX500 ; Type: SX500

Date: Aug. 30,2018

Communication System: Wi-Fi; Communication System Band: 802.11b; Duty Cycle: 1:1; Conv.F=5.04
Frequency: 2437 MHz; Medium parameters used: $f = 2450$ MHz; $\sigma = 1.90$ mho/m; $\epsilon_r = 53.71$; $\rho = 1000$ kg/m³ ;
Phantom section: Flat Section
Ambient temperature (°C):21.9, Liquid temperature (°C): 21.5

SATIMO Configuration:

- Probe: SSE5; Calibrated: Aug. 08,2018; Serial No.: SN 22/12 EP159
- Sensor-Surface: 4mm (Mechanical Surface Detection)
- Phantom: SAM twin phantom
- Measurement SW: OpenSAR V4_02_32

Configuration/802.11b Mid- Body- Back /Area Scan: Measurement grid: dx=8mm, dy=8mm
Configuration/802.11b Mid- Body- Back /Zoom Scan: Measurement grid: dx=5mm,dy=5mm, dz=5mm;

Area Scan	sam_direct_droit2_surf8mm.txt
ZoomScan	7x7x7,dx=5mm dy=5mm dz=5mm
Phantom	Validation plane
Device Position	Body Back
Band	2450MHz
Channels	Middle
Signal	Crest factor: 1.0

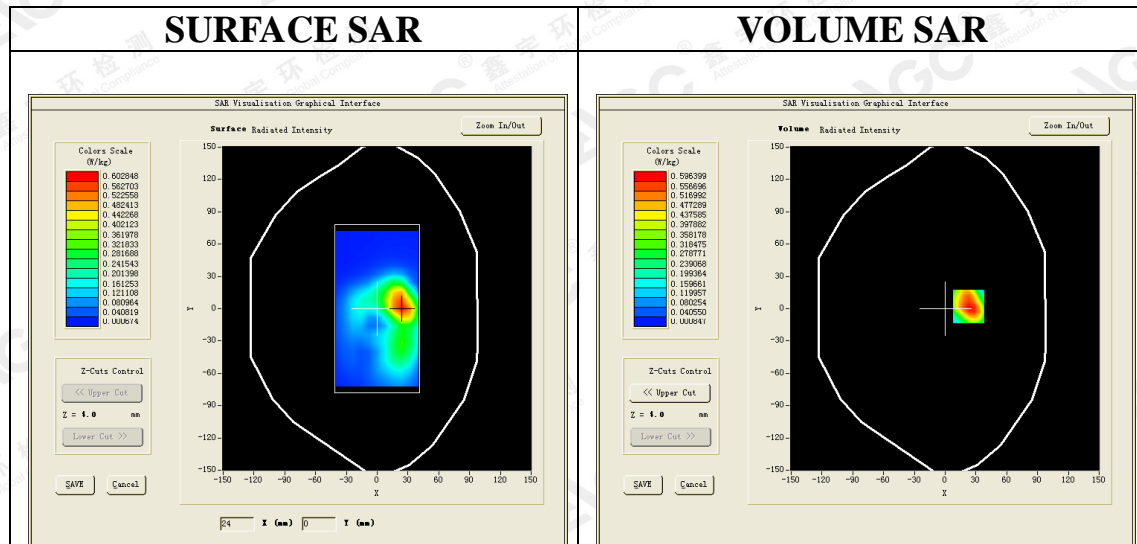

Maximum location: X=23.00, Y=2.00
SAR Peak: 1.01 W/kg

SAR 10g (W/Kg)	0.276168
SAR 1g (W/Kg)	0.565203

The results shown in this test report refer only to the sample(s) tested unless otherwise stated and the sample(s) are retained for 30 days only. The document is issued by AGC, this document cannot be reproduced except in full with our prior written permission. The more details and the authenticity of the report will be confirmed at <http://www.agc-cert.com>.

Z (mm)	0.00	4.00	9.00	14.00	19.00	24.00	29.00
SAR (W/Kg)	1.0112	0.5964	0.2875	0.1350	0.0627	0.0292	0.0137

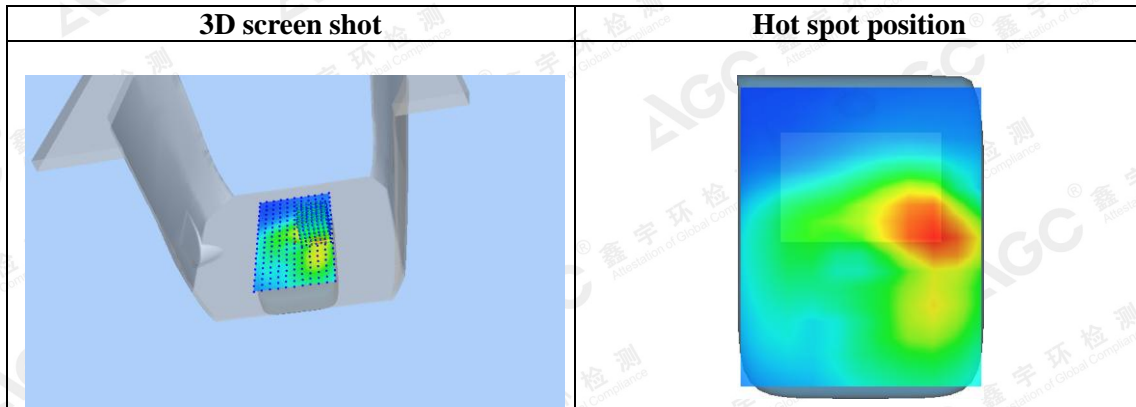
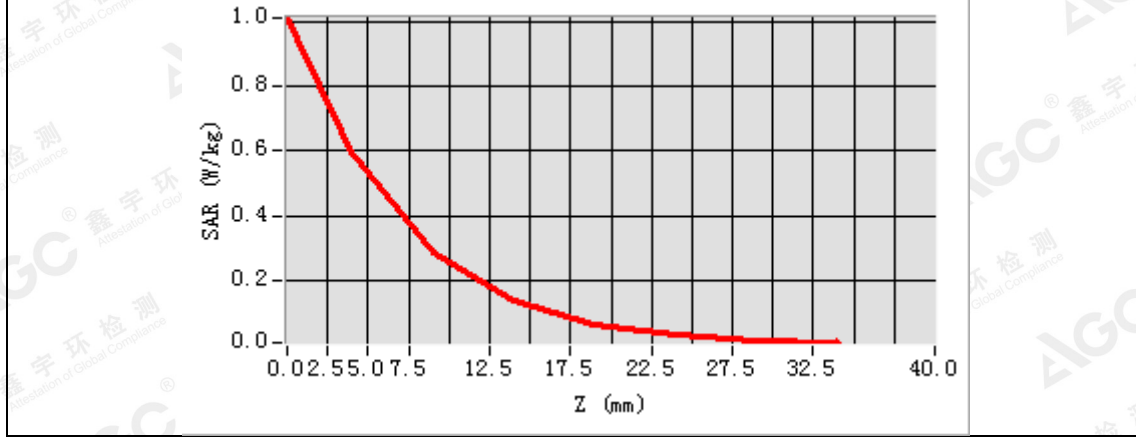

The results shown in this test report refer only to the sample(s) tested unless otherwise stated and the sample(s) are retained for 30 days only. The document is issued by AGC, this document cannot be reproduced except in full with our prior written permission. The more details and the authenticity of the report will be confirmed at <http://www.agc-cert.com>.

Test Laboratory: AGC Lab
802.11b Mid-Body-Worn- Front (DTS)
DUT: SkyCaddie SX500 ; Type: SX500

Date: Aug. 30,2018

Communication System: Wi-Fi; Communication System Band: 802.11b; Duty Cycle: 1:1; Conv.F=5.04
Frequency: 2437 MHz; Medium parameters used: $f = 2450$ MHz; $\sigma = 1.90$ mho/m; $\epsilon_r = 53.71$; $\rho = 1000$ kg/m³ ;
Phantom section: Flat Section
Ambient temperature (°C):21.9, Liquid temperature (°C): 21.5

SATIMO Configuration:

- Probe: SSE5; Calibrated: Aug. 08,2018; Serial No.: SN 22/12 EP159
- Sensor-Surface: 4mm (Mechanical Surface Detection)
- Phantom: SAM twin phantom
- Measurement SW: OpenSAR V4_02_32

Configuration/802.11b Mid- Body- Front /Area Scan: Measurement grid: dx=8mm, dy=8mm
Configuration/802.11b Mid- Body- Front /Zoom Scan: Measurement grid: dx=5mm,dy=5mm, dz=5mm;

Area Scan	sam_direct_droit2_surf8mm.txt
ZoomScan	7x7x7,dx=5mm dy=5mm dz=5mm
Phantom	Validation plane
Device Position	Body Front
Band	2450MHz
Channels	Middle
Signal	Crest factor: 1.0

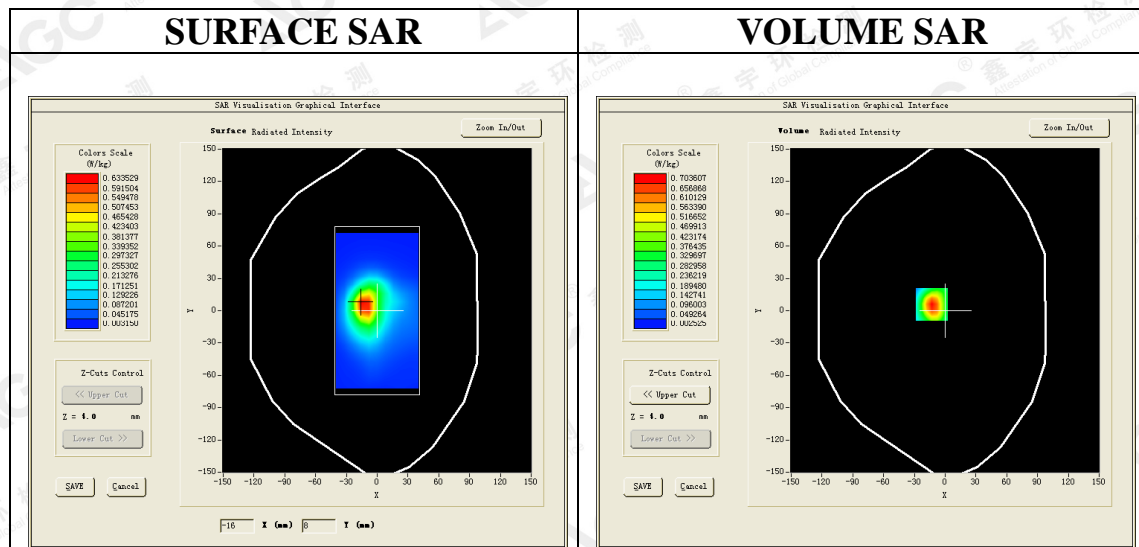

Maximum location: X=-13.00, Y=6.00
SAR Peak: 1.19 W/kg

SAR 10g (W/Kg)	0.295731
SAR 1g (W/Kg)	0.641257

The results shown in this test report refer only to the sample(s) tested unless otherwise stated and the sample(s) are retained for 30 days only. The document is issued by AGC, this document cannot be reproduced except in full with our prior written permission. The more details and the authenticity of the report will be confirmed at <http://www.agc-cert.com>.

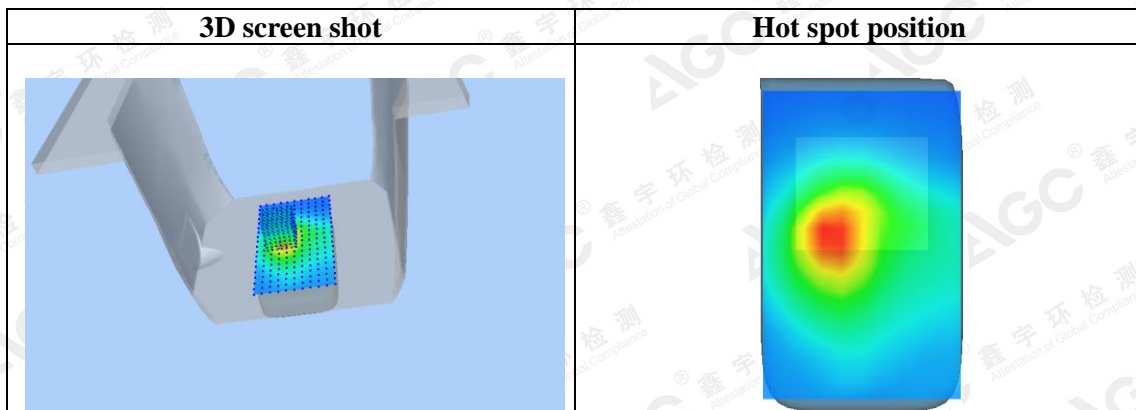
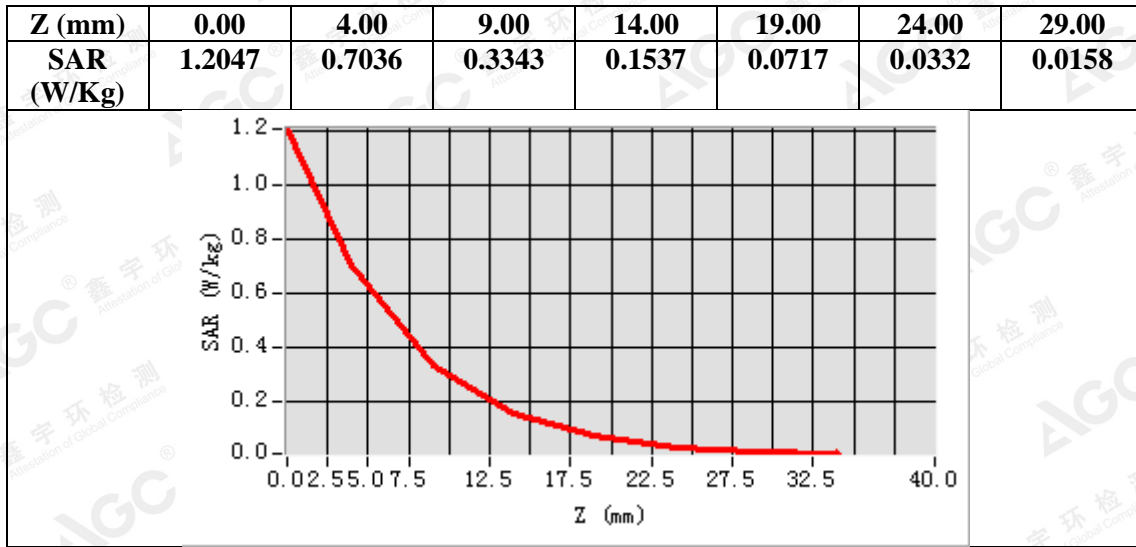

The results shown in this test report refer only to the sample(s) tested unless otherwise stated and the sample(s) are retained for 30 days only. The document is issued by AGC, this document cannot be reproduced except in full with our prior written permission. The more details and the authenticity of the report will be confirmed at <http://www.agc-cert.com>.

Test Laboratory: AGC Lab
802.11b Mid- Edge1 (DTS)
DUT: SkyCaddie SX500 ; Type: SX500

Date: Aug. 30,2018

Communication System: Wi-Fi; Communication System Band: 802.11b; Duty Cycle: 1:1; Conv.F=5.04
Frequency: 2437 MHz; Medium parameters used: $f = 2450$ MHz; $\sigma = 1.90$ mho/m; $\epsilon_r = 53.71$; $\rho = 1000$ kg/m³ ;
Phantom section: Flat Section
Ambient temperature (°C):21.9, Liquid temperature (°C): 21.5

SATIMO Configuration:

- Probe: SSE5; Calibrated: Aug. 08,2018; Serial No.: SN 22/12 EP159
- Sensor-Surface: 4mm (Mechanical Surface Detection)
- Phantom: SAM twin phantom
- Measurement SW: OpenSAR V4_02_32

Configuration/802.11b Mid- Edge1 /Area Scan: Measurement grid: dx=8mm, dy=8mm
Configuration/802.11b Mid- Edge1 /Zoom Scan: Measurement grid: dx=5mm,dy=5mm, dz=5mm;

Area Scan	sam_direct_droit2_surf8mm.txt
ZoomScan	7x7x7,dx=5mm dy=5mm dz=5mm
Phantom	Validation plane
Device Position	Edge1
Band	2450MHz
Channels	Middle
Signal	Crest factor: 1.0

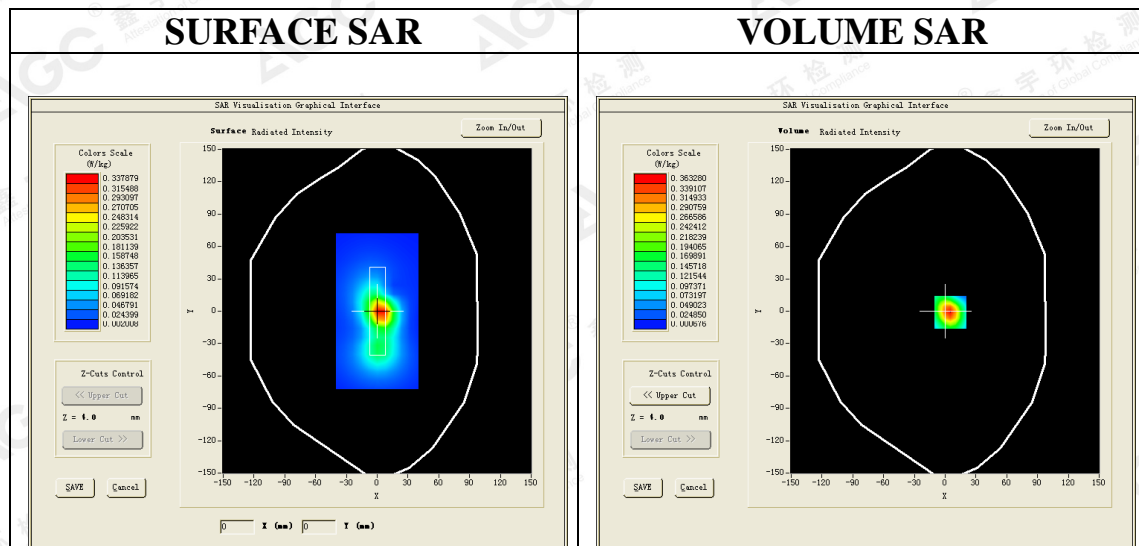

Maximum location: X=5.00, Y=-1.00
SAR Peak: 0.62 W/kg

SAR 10g (W/Kg)	0.146369
SAR 1g (W/Kg)	0.328454

The results shown in this test report refer only to the sample(s) tested unless otherwise stated and the sample(s) are retained for 30 days only. The document is issued by AGC, this document cannot be reproduced except in full with our prior written permission. The more details and the authenticity of the report will be confirmed at <http://www.agc-cert.com>.

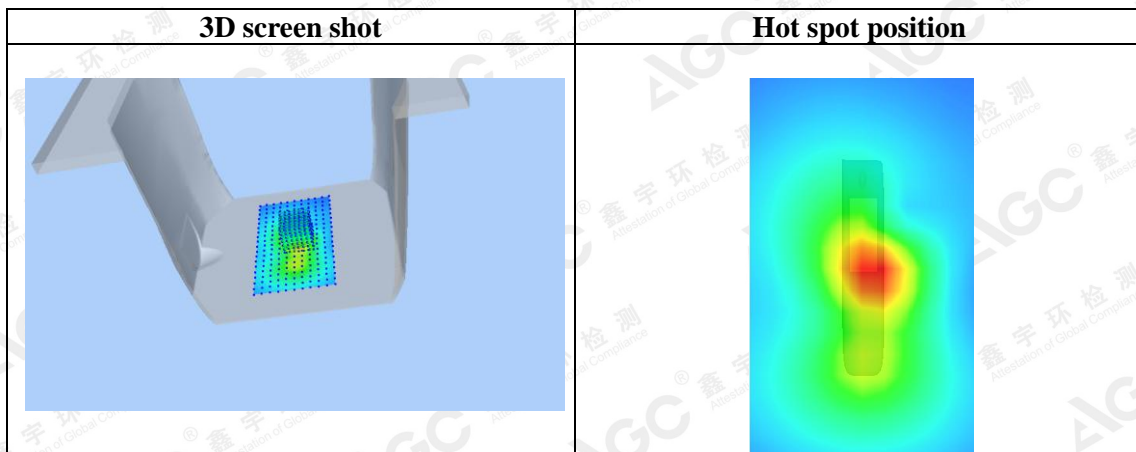
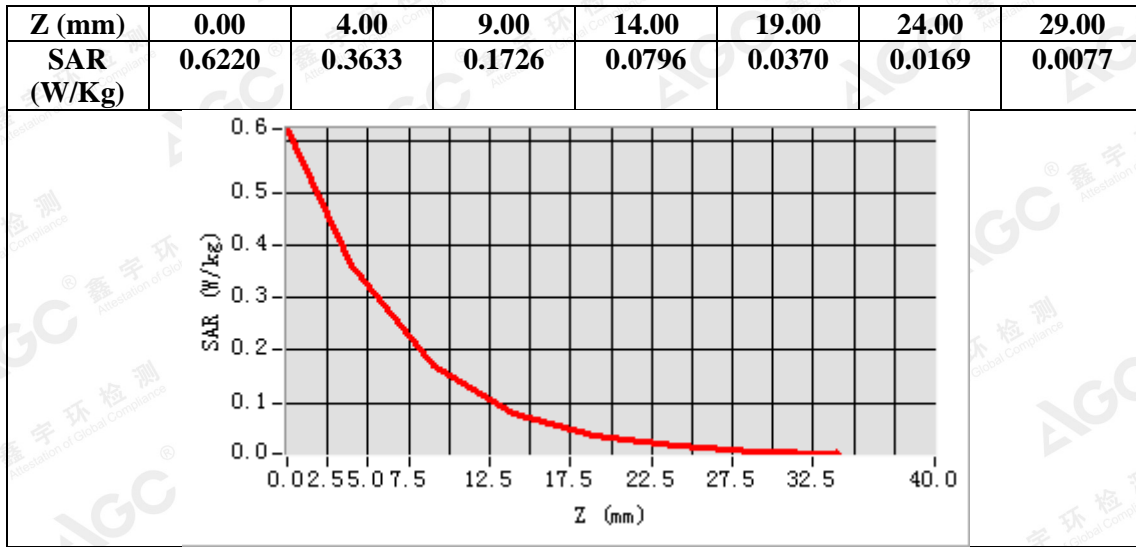

The results shown in this test report refer only to the sample(s) tested unless otherwise stated and the sample(s) are retained for 30 days only. The document is issued by AGC, this document cannot be reproduced except in full with our prior written permission. The more details and the authenticity of the report will be confirmed at <http://www.agc-cert.com>.

Test Laboratory: AGC Lab
802.11b Mid- Edge4 (DTS)
DUT: SkyCaddie SX500 ; Type: SX500

Date: Aug. 30,2018

Communication System: Wi-Fi; Communication System Band: 802.11b; Duty Cycle: 1:1; Conv.F=5.04
Frequency: 2437 MHz; Medium parameters used: $f = 2450$ MHz; $\sigma = 1.90$ mho/m; $\epsilon_r = 53.71$; $\rho = 1000$ kg/m³ ;
Phantom section: Flat Section
Ambient temperature (°C):21.9, Liquid temperature (°C): 21.5

SATIMO Configuration:

- Probe: SSE5; Calibrated: Aug. 08,2018; Serial No.: SN 22/12 EP159
- Sensor-Surface: 4mm (Mechanical Surface Detection)
- Phantom: SAM twin phantom
- Measurement SW: OpenSAR V4_02_32

Configuration/802.11b Mid- Edge4 /Area Scan: Measurement grid: dx=8mm, dy=8mm
Configuration/802.11b Mid- Edge4 /Zoom Scan: Measurement grid: dx=5mm,dy=5mm, dz=5mm;

Area Scan	sam_direct_droit2_surf8mm.txt
ZoomScan	7x7x7,dx=5mm dy=5mm dz=5mm
Phantom	Validation plane
Device Position	Edge4
Band	2450MHz
Channels	Middle
Signal	Crest factor: 1.0

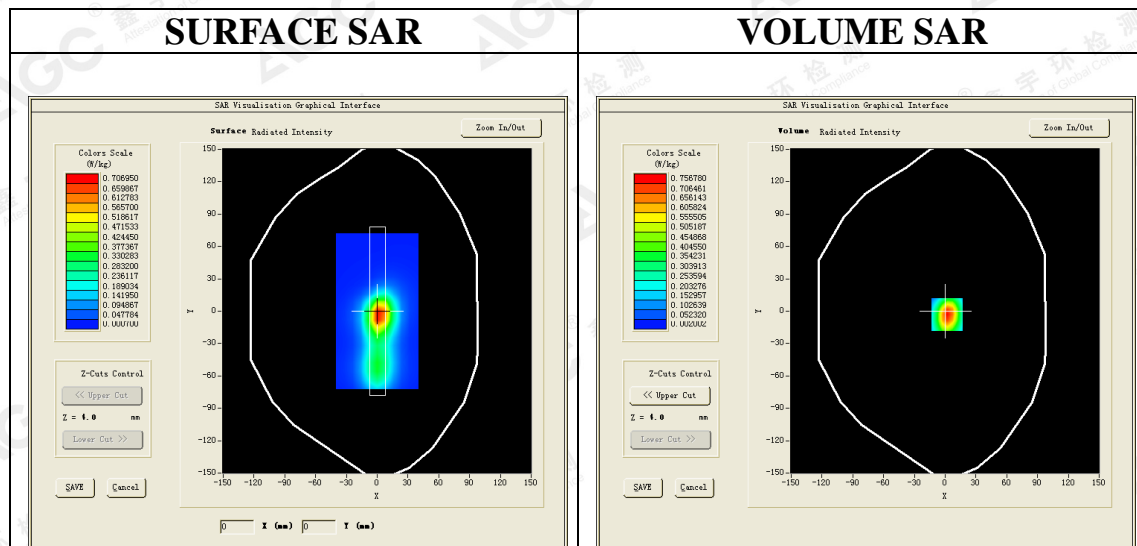

Maximum location: X=2.00, Y=-3.00

SAR Peak: 1.27 W/kg

SAR 10g (W/Kg)	0.308847
SAR 1g (W/Kg)	0.683300

The results shown in this test report refer only to the sample(s) tested unless otherwise stated and the sample(s) are retained for 30 days only. The document is issued by AGC, this document cannot be reproduced except in full with our prior written permission. The more details and the authenticity of the report will be confirmed at <http://www.agc-cert.com>.

Z (mm)	0.00	4.00	9.00	14.00	19.00	24.00	29.00
SAR (W/Kg)	1.2781	0.7568	0.3679	0.1726	0.0817	0.0384	0.0180

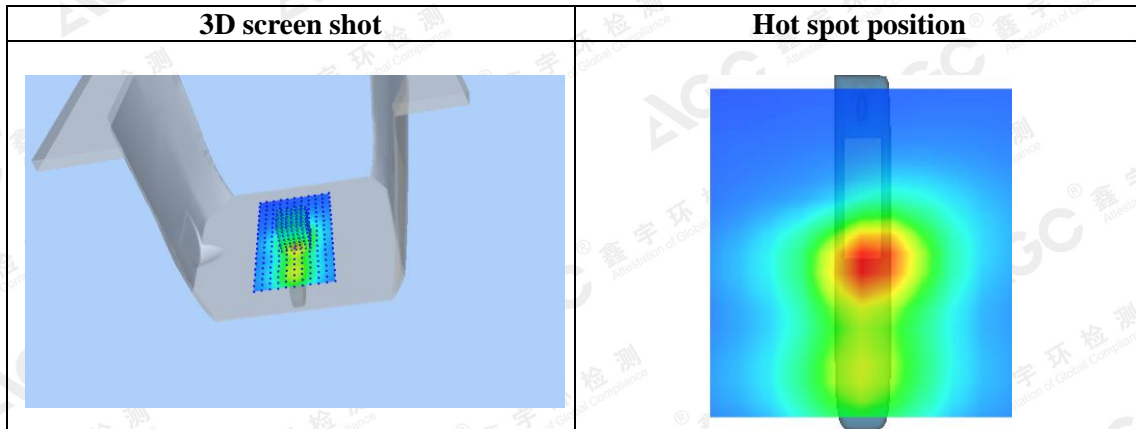
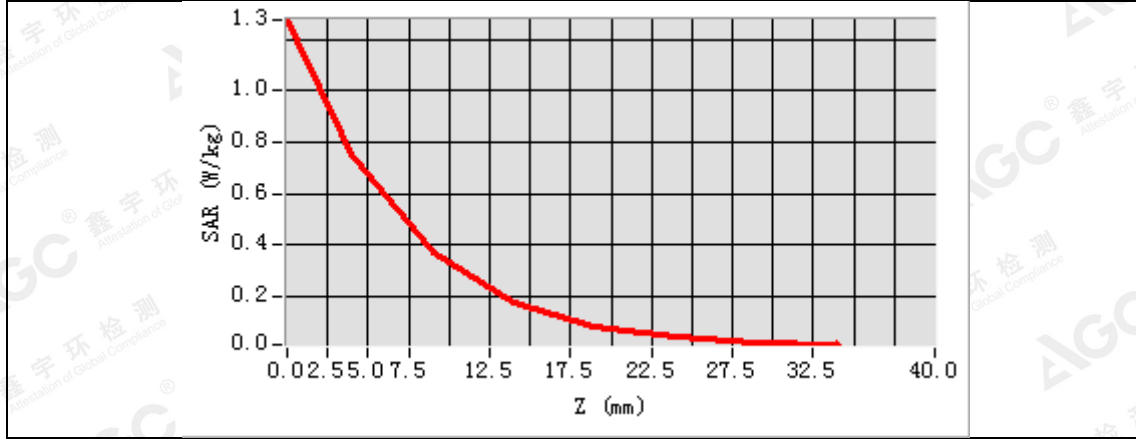

The results shown in this test report refer only to the sample(s) tested unless otherwise stated and the sample(s) are retained for 30 days only. The document is issued by AGC, this document cannot be reproduced except in full with our prior written permission. The more details and the authenticity of the report will be confirmed at <http://www.agc-cert.com>.

APPENDIX C. TEST SETUP PHOTOGRAPHS
LEFT- CHEEK TOUCH

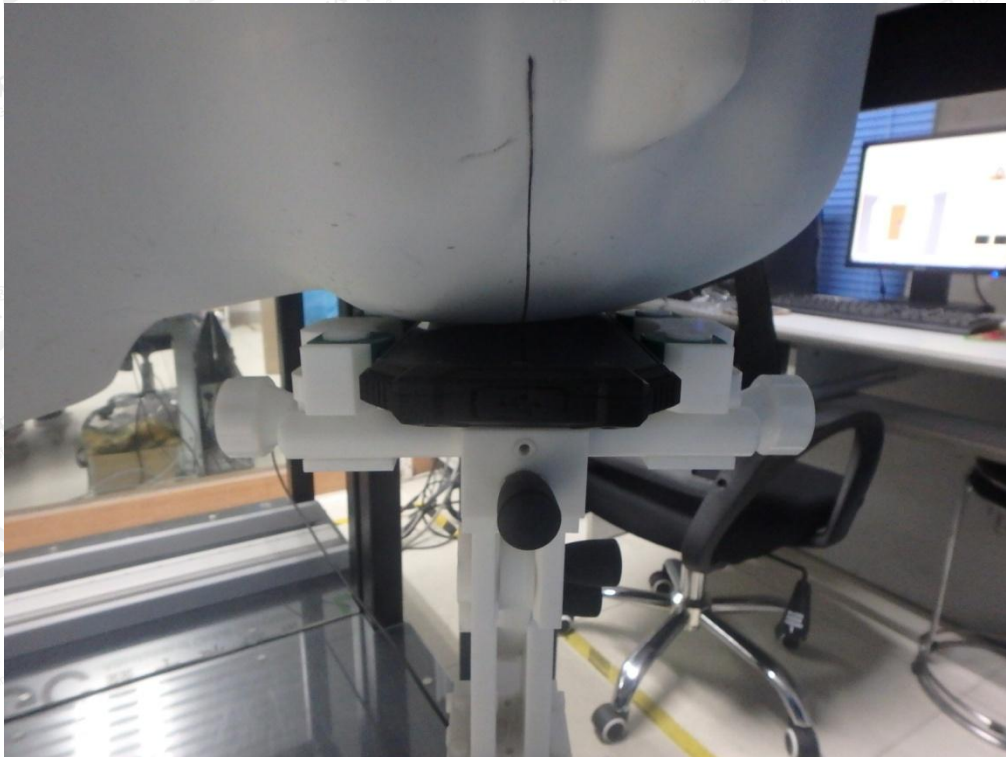

LEFT-TILT 15°



The results shown in this test report refer only to the sample(s) tested unless otherwise stated and the sample(s) are retained for 30 days only. The document is issued by AGC, this document cannot be reproduced except in full with our prior written permission. The more details and the authenticity of the report will be confirmed at <http://www.agc-cert.com>.

RIGHT- CHEEK TOUCH

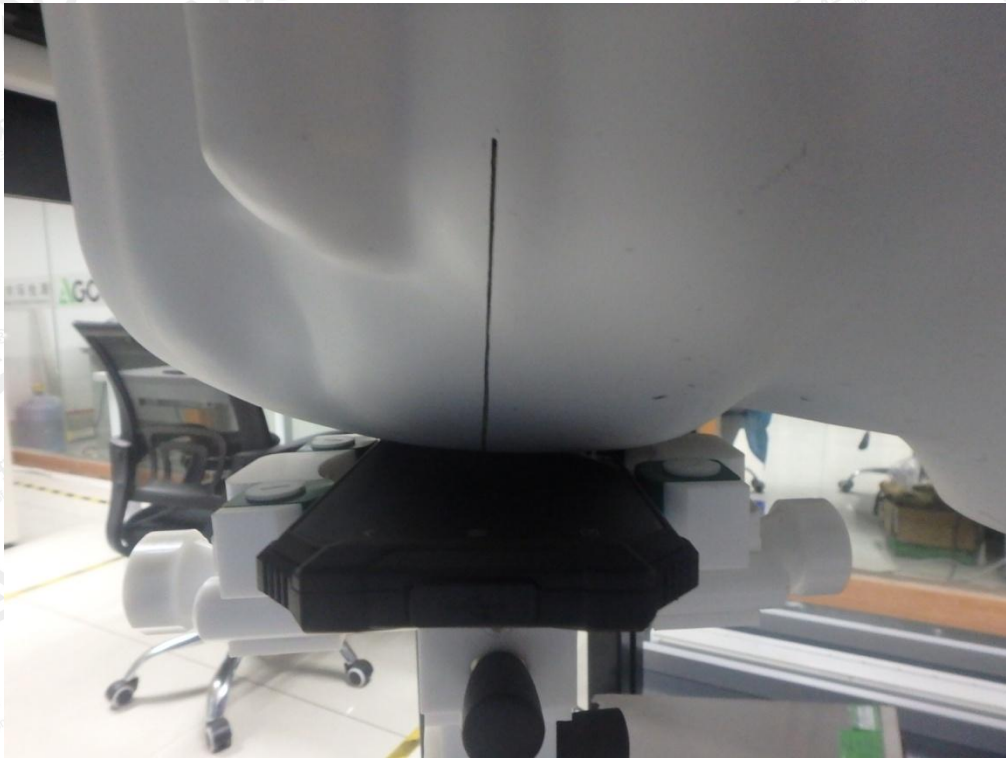

RIGHT-TILT 15°

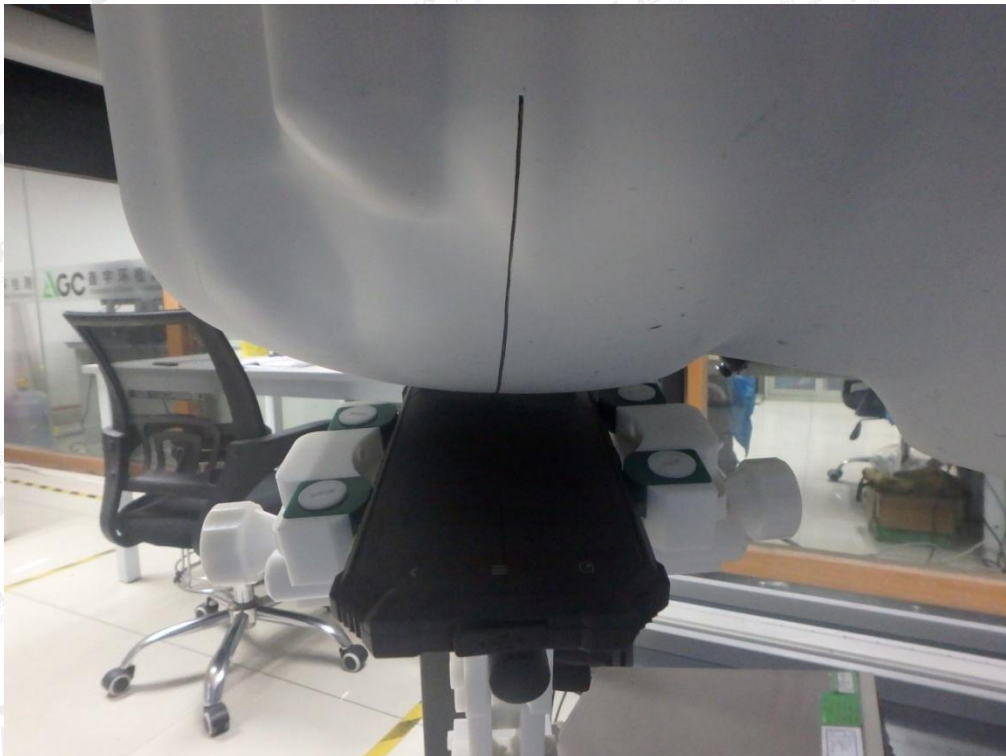

The results shown in this test report refer only to the sample(s) tested unless otherwise stated and the sample(s) are retained for 30 days only. The document is issued by AGC, this document cannot be reproduced except in full with our prior written permission. The more details and the authenticity of the report will be confirmed at <http://www.agc-cert.com>.

Body Back 10mm



Body Front 10mm

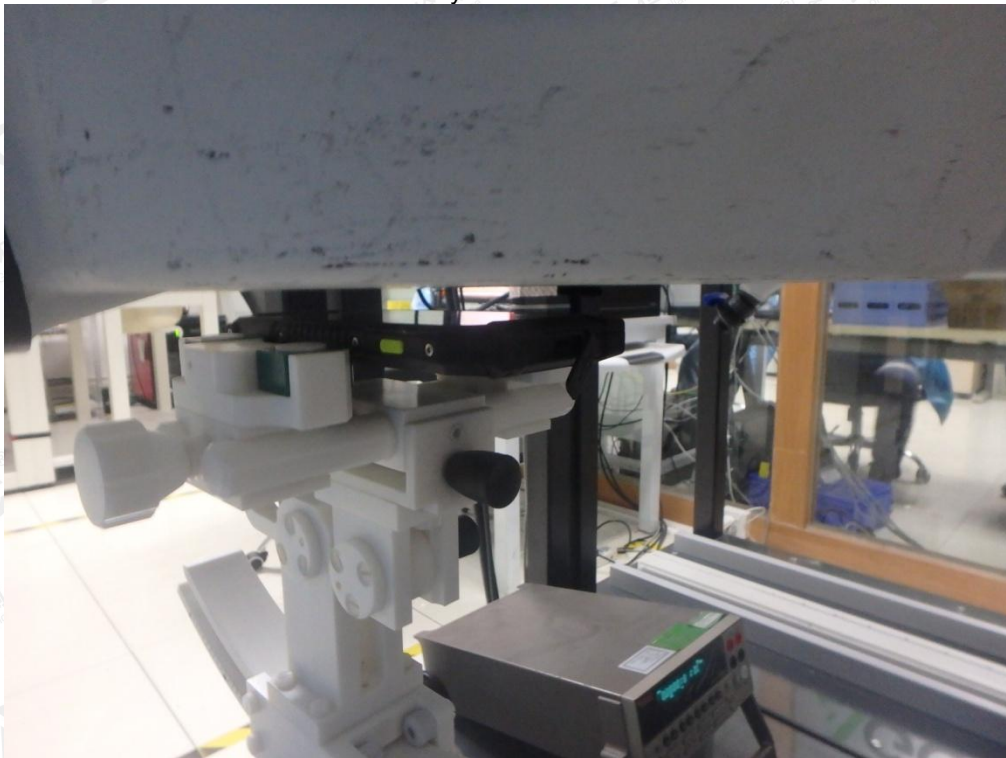

The results shown in this test report refer only to the sample(s) tested otherwise stated and the sample(s) are retained for 30 days only. The document is issued by AGC, this document cannot be reproduced except in full with our prior written permission. The more details and the authenticity of the report will be confirmed at <http://www.agc-cert.com>.

Edge 1(Top) 10mm



Edge 4(Left) 10mm



The results shown in this test report refer only to the sample(s) tested otherwise stated and the sample(s) are retained for 30 days only. The document is issued by AGC, this document cannot be reproduced except in full with our prior written permission. The more details and the authenticity of the report will be confirmed at <http://www.agc-cert.com>.

Body Back 0mm



Body Front 0mm



The results shown in this test report refer only to the sample(s) tested otherwise stated and the sample(s) are retained for 30 days only. The document is issued by AGC, this document cannot be reproduced except in full with our prior written permission. The more details and the authenticity of the report will be confirmed at <http://www.agc-cert.com>.

Edge 1(Top) 0mm



Edge 4(Left) 0mm



The results shown in this test report refer only to the sample(s) tested otherwise stated and the sample(s) are retained for 30 days only. The document is issued by AGC, this document cannot be reproduced except in full with our prior written permission. The more details and the authenticity of the report will be confirmed at <http://www.agc-cert.com>.

DEPTH OF THE LIQUID IN THE PHANTOM—ZOOM IN

Note : The position used in the measurement were according to IEEE 1528-2013

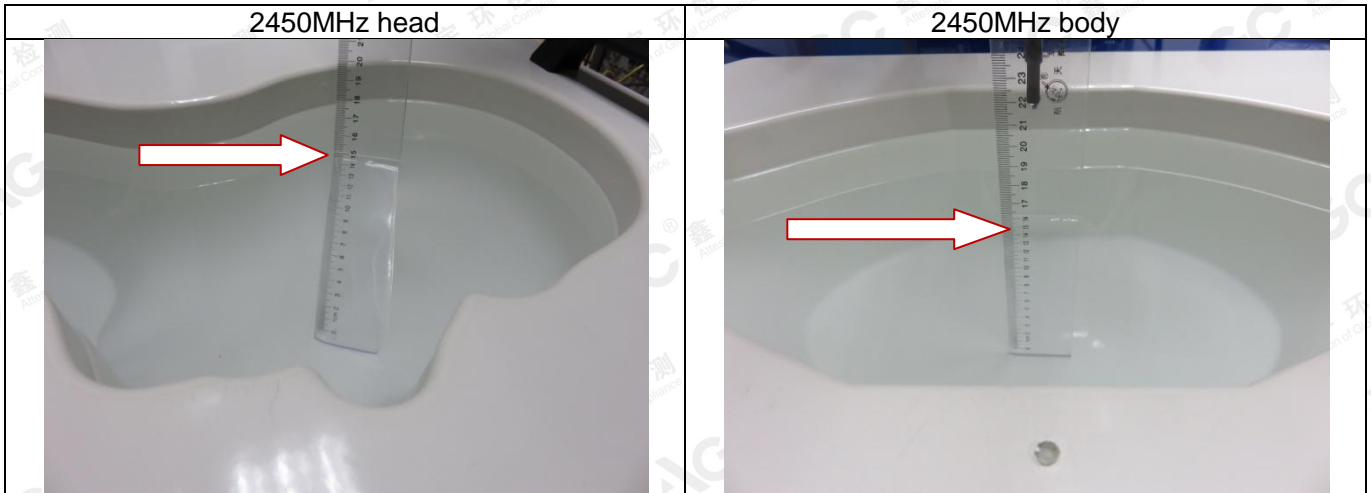

The results shown in this test report refer only to the sample(s) tested unless otherwise stated and the sample(s) are retained for 30 days only. The document is issued by AGC, this document cannot be reproduced except in full with our prior written permission. The more details and the authenticity of the report will be confirmed at <http://www.agc-cert.com>.

APPENDIX D. CALIBRATION DATA

Refer to Attached files.

The results shown in this test report refer only to the sample(s) tested unless otherwise stated and the sample(s) are retained for 30 days only. The document is issued by AGC, this document cannot be reproduced except in full with our prior written permission. The more details and the authenticity of the report will be confirmed at <http://www.agc-cert.com>.